

Yealink

Certified for
Microsoft Teams

Certified for
Skype for Business

Smart Business Phone MP56[®] - Teams/Skype for Business[®] Edition

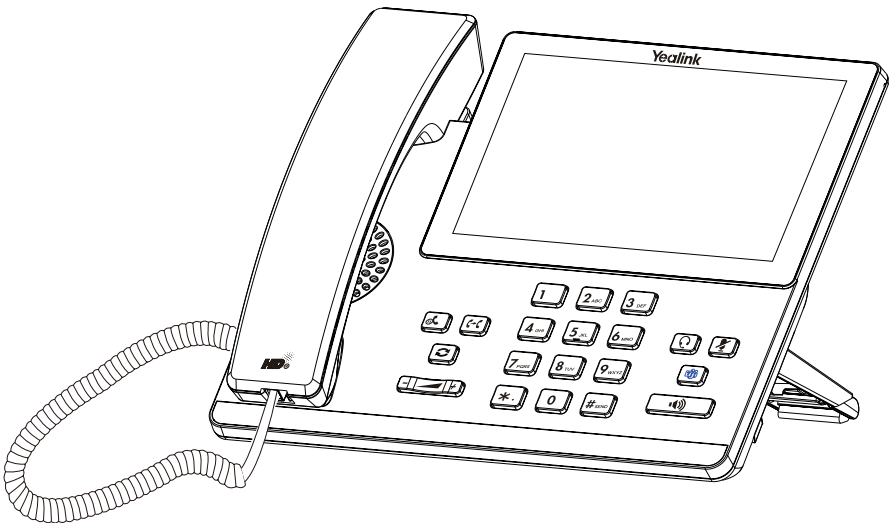

Quick Start Guide(V1.0)

Package Contents

The following items are included in your package. If you find anything missing, contact your system administrator.

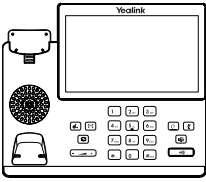

MP56 Phone



Handset



Handset Cord



Quick Start Guide



Ethernet Cable
(2m CAT5E FTP cable)



Power Adapter
(Optional)

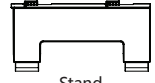

Stand

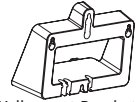

Wallmount Bracket
(Optional)

Note: We recommend that you use the accessories provided or approved by Yealink. The unapproved third-party accessories may result in reduced performance. The USB is 5VDC 500mA Max Output.

Assembling Your Phone

1. Attach the stand:

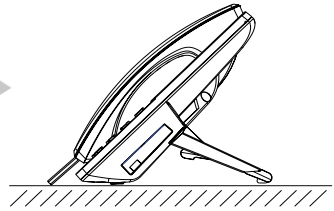
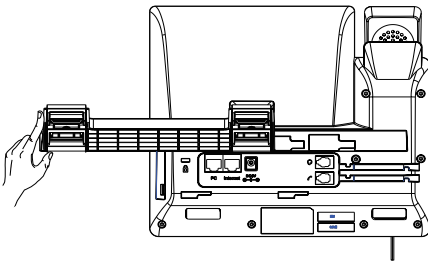

2. Optional: Attach the wall mount bracket:

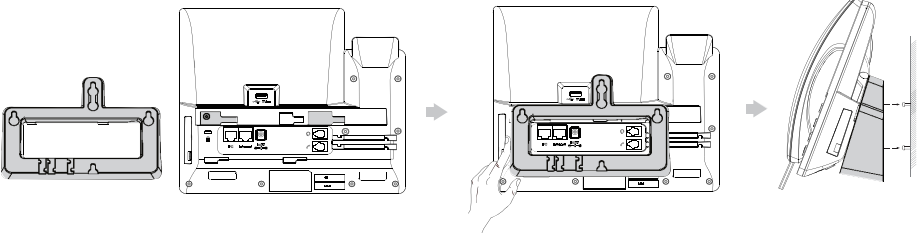

Note: The reversible tab has a lip which allows the handset to stay on-hook when the IP phone is mounted vertically. For more information, refer to Yealink Wall Mount Quick Installation Guide for Yealink IP Phones.

3. Connect the handset and optional headset:

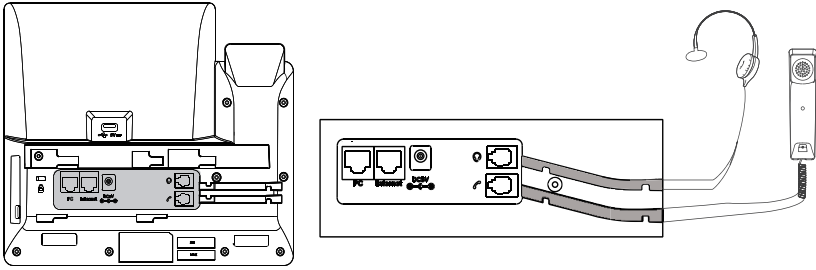

4. Connect the AC power or PoE:

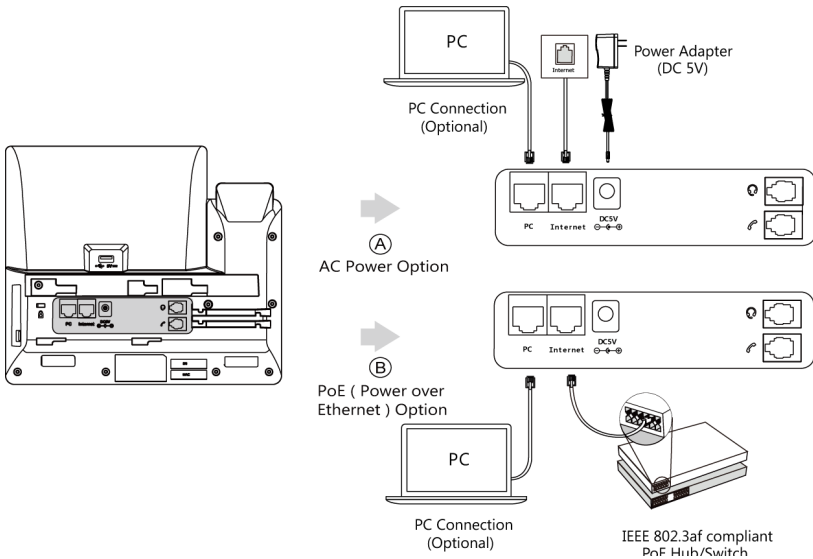

Note: The phone should be worked with Yealink original power adapter (5V/2A) only. The third-party power adapter may damage the phone. If inline power (PoE) is provided, you don't need to connect the power adapter. Make sure the hub/switch is PoE-compliant.

Hardware Component Instructions

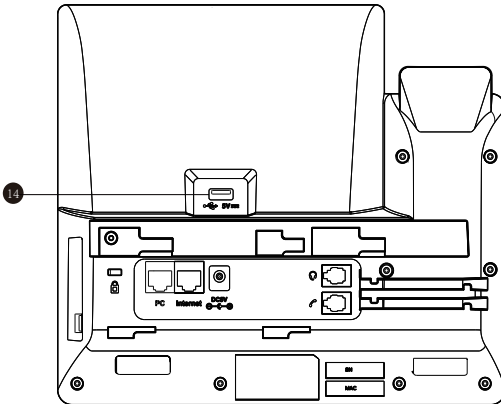
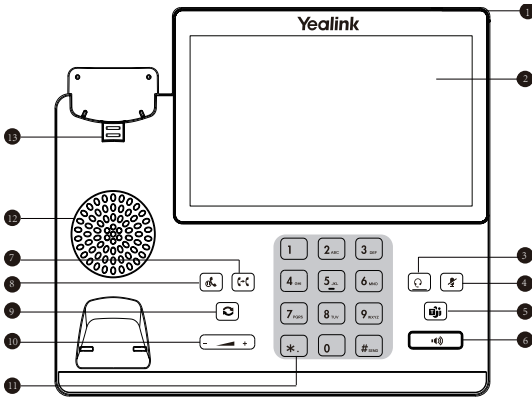

| Item | |
|------|---------------------|
| 1 | Power LED Indicator |
| 2 | Touch Screen |
| 3 | HEADSET Key |
| 4 | MUTE Key |
| 5 | Teams Key |
| 6 | Speakerphone Key |
| 7 | TRANSFER Key |
| 8 | HOLD Key |
| 9 | REDIAL Key |
| 10 | Volume Key |
| 11 | Keypad |
| 12 | Speaker |
| 13 | Reversible Tab |
| 14 | Hookswitch |
| 15 | USB2.0 port |

Startup and Sign in (Teams Edition)

Startup

After the Teams phone is connected to the network and supplied with power, it automatically begins the initialization process. After startup, select a desired language and then the phone enters the sign-in screen.

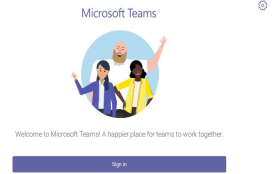

Sign in to Microsoft Teams

Phone Sign-in

To sign in to Microsoft Teams on your phone:

1. Tap **Sign in**.

You will be connected to the Company Portal automatically.

2. Follow the on-screen prompts.

In the **Sign in** screen, you can select **Sign in from another device** to sign in to Microsoft Teams using web sign-in method.

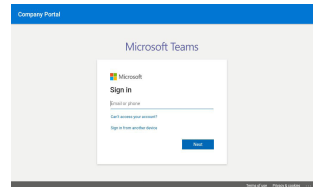

Web Sign-in

To sign in to Microsoft Teams via web sign-in:

1. Tap **Sign in**.

You will be connected to the Company Portal automatically.

2. Select **Sign in from another device** from the **Sign in** screen.

3. Go to <https://microsoft.com/devicelogin> on your computer.

4. Enter the code shown on your phone and select **Next**.

5. Enter your account credentials or select a desired account to sign in.

A confirmation message is displayed after you successfully sign in to Microsoft Intune Company Portal.

Startup and Sign in (SfB Edition)

Startup

After the Skype for Business phone is connected to the network and supplied with power, it automatically begins the initialization process. After startup, the phone enters the sign-in screen.

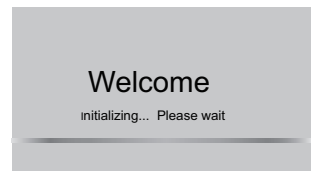

Signing in to Skype for Business

Web Sign-in (Recommended method)

You can sign in to your Skype for Business Online account using a web browser. Contact your system administrator to get your login credentials.

To sign in to Skype for Business using web sign-in method:

1. Tap **Sign in**.
2. Select **Web Sign-in**.
A web address and pairing code are displayed.
3. Enter the web address into the web browser on your computer.
4. Enter the pairing code generated on the phone into the web browser and select **Next**.
5. Follow the on-screen prompts.
A confirmation message is displayed when the phone successfully signs in to Skype for Business.

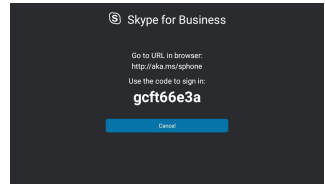

User Sign-in

You can sign in to your Skype for Business account using your login credentials, which includes your address, username, and password. Contact your system administrator to get your login credentials.

To sign in using your skype for business user credentials:

1. Tap **Sign in**.
2. Select **User Sign-in**.
3. Enter your Skype for Business account user credentials and select **Sign in**.

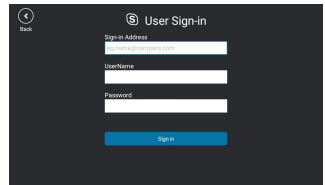

PIN Authentication

You can sign in to your Skype for Business account using your PIN Authentication credentials. Contact your system administrator to get your login credentials.

Before you begin

Your system administrator should configure network environment in advanced for PIN Authentication method. If not, your phone may not display this sign-in method. For more information contact the system administrator.

To sign in using your Skype for Business PIN authentication:

1. Tap **Sign in**.
2. Select **PIN Authentication**.
3. Enter your PIN authentication credentials and select **Sign in**.

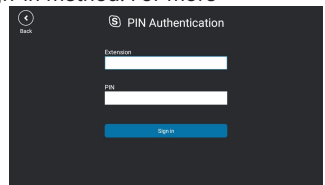

Sign in via PC

When your phone is connected to your computer and paired using Better Together over Ethernet (BToE), you can sign in to the phone using the Skype for Business client on your computer.

To sign in to Skype for Business on your computer using BToE:

1. Tap **Sign in**.
2. Select **Sign in via PC**.
3. In the Skype for Business client on your computer, enter your login credentials, and click **Sign in**.

Switching to Teams or SfB

If you are using the SfB Edition, you can switch to the Teams Edition by upgrading firmware via the web user interface or auto provisioning. Similarly, if you are using the Teams Edition, you can also switch to SfB Edition via firmware upgrading.

Visit the Yealink WIKI (<http://support.yealink.com/>) for the latest firmware or contact the Yealink technical support team for help.

More Info

For more information on your phone, see related documentations, including User Guide and Administrator Guide, on your phone's Support page: <http://support.yealink.com/>. You can also contact the Yealink technical support team for help.

Regulatory Notices

Operating Ambient Temperatures

- Operating temperature: +14 to 113°F (-10 to 45°C)
- Relative humidity: 5% to 90%, noncondensing
- Storage temperature: -22 to +160°F (-30 to +70°C)

Warranty

Our product warranty is limited only to the unit itself, when used normally in accordance with the operating instructions and the system environment. We are not liable for damage or loss resulting from the use of this product, or for any claim from a third party. We are not liable for problems with Yealink device arising from the use of this product; we are not liable for financial damages, lost profits, claims from third parties, etc., arising from the use of this product.

Explanation of the symbols

•DC symbol

--- is the DC voltage symbol.

•WEEE Warning symbol

To avoid the potential effects on the environment and human health as a result of the presence of hazardous substances in electrical and electronic equipment, end users of electrical and electronic equipment should understand the meaning of the crossed-out wheeled bin symbol. Do not dispose of WEEE as unsorted municipal waste and have to collect such WEEE separately.

•Restriction of Hazardous Substances Directive (RoHS)

This device complies with the requirements of the EU RoHS Directive. Statements of compliance can be obtained by contacting support@yealink.com.

•Safety Instructions

Save these instructions. Read these safety instructions before use!

▲ General Requirements

- Before you install and use the device, read the safety instructions carefully and observe the situation during operation.
- During the process of storage, transportation, and operation, please always keep the device dry and clean, avoid collision and crash.
- Please attempt not to dismantle the device by yourself. In case of any discrepancy, please contact the appointed maintenance center for repair.
- Please refer to the relevant laws and statutes while using the device. Legal rights of others should be respected as well.

▲ Environmental Requirements

- Place the device at a well-ventilated place. Do not expose the device under direct sunlight.
- Keep the device dry and free of dusts.
- Do not place the device on or near any inflammable or fire-vulnerable object, such as rubber-made materials.
- Keep the device away from any heat source or bare fire, such as a candle or an electric heater.

▲ Operating Requirements

- Do not let a child operate the device without guidance.
- Do not let a child play with the device or any accessory in case of accidental swallowing.
- Please use the accessories provided or authorized by the manufacturer only.
- The power supply of the device shall meet the requirements of the input voltage of the device. Please use the provided surge protection power socket only.
- Before plugging or unplugging any cable, make sure that your hands are completely dry.
- Do not spill liquid of any kind on the product or use the equipment near water, for example, near a bathtub, washbowl, kitchen sink, wet basement or near a swimming pool.
- During a thunderstorm, stop using the device and disconnect it from the power supply. Unplug the power plug and the Asymmetric Digital Subscriber Line (ADSL) twisted pair (the radio frequency cable) to avoid lightning strike.
- If the device is left unused for a rather long time, disconnect it from the power supply and unplug the power plug.
- When there is smoke emitted from the device, or some abnormal noise or smell, disconnect the device from the power supply, and unplug the power plug immediately.

Note: This equipment has been tested and found to comply with the limits for a Class B digital device, pursuant to part 15 of the FCC Rules. These limits are designed to provide reasonable protection against harmful interference in a residential installation. This equipment generates uses and can radiate radio frequency energy and, if not installed and used in accordance with the instructions, may cause harmful interference to radio communications. However, there is no guarantee that interference will not occur in a particular installation. If this equipment does cause harmful interference to radio or television reception, which can be determined by turning the equipment off and on, the user is encouraged to try to correct the interference by one or more of the following measures:

- Reorient or relocate the receiving antenna.
- Increase the separation between the equipment and receiver.
- Connect the equipment into an outlet on a circuit different from that to which the receiver is connected.
- Consult the dealer or an experienced radio/TV technician for help.

High power radars are allocated as primary users of the 5.25 to 5.35 GHz and 5.65 to 5.85 GHz bands. These radar stations can cause interference with and/or damage this device. No configuration controls are provided for this wireless equipment allowing any change in the frequency of operations outside the FCC grant of authorization for US operation according to Part 15.407 of the FCC rules 5.15-5.25GHz Band Operations in the 5.15-5.25GHz band are restricted to indoor use only.

- Contact the specified maintenance center for repair.
- Do not insert any object into equipment slots that is not part of the product or auxiliary product.
- Before connecting a cable, connect the grounding cable of the device first. Do not disconnect the grounding cable until you disconnect all other cables.

▲ Operating Requirements

- Before cleaning the device, disconnect it from the power supply.
- Use a piece of soft, dry and anti-static cloth to clean the device.
- Keep the power plug clean and dry.

Troubleshooting

The unit cannot supply power to device other than Yealink device.

There is a bad connection with the plug.

1. Clean the plug with a dry cloth.

2. Connect it to another wall outlet.

The usage environment is out of operating temperature range.

1. Use in the operating temperature range.

The cable between the unit and the Yealink device is connected incorrectly.

1. Connect the cable correctly.

You cannot connect the cable properly.

1. You may have connected a wrong Yealink device.

2. Use the correct power supply.

Some dust, etc., may be in the port.

1. Clean the port.

Contact your dealer or authorized service facility for any further questions.

FCC Statement

This device complies with part 15 of the FCC Rules. Operation is subject to the following two conditions: (1) this device may not cause harmful interference, and (2) this device must accept any interference received, including interference that may cause undesired operation. Any Changes or modifications not expressly approved by the party responsible for compliance could void the user's authority to operate the equipment.

IC Statement

This device complies with Industry Canada's licence-exempt RSSs.

Operation is subject to the following two conditions:

(1) this device may not cause interference; and

(2) this device must accept any interference, including interference that may cause undesired operation of the device. CAN ICES-3(B)

Le présent appareil est conforme aux CNR d'Industrie Canada applicables aux appareils radio exempts de licence. L'exploitation est autorisée aux deux conditions suivantes :

(1) l'appareil ne doit pas produire de brouillage;

(2) l'utilisateur de l'appareil doit accepter tout brouillage radioélectrique subi, même si le brouillage est susceptible d'en compromettre le fonctionnement. NMB-3(B)

Radiation Exposure Statement

This equipment complies with FCC and IC radiation exposure limits set forth for an uncontrolled environment. This equipment should be installed and operated with minimum distance 20cm between the radiator and your body.

Cet émetteur ne doit pas être Co-placé ou ne fonctionnant en même temps qu'aucune autre antenne ou émetteur. Cet équipement devrait être installé et actionné avec une distance minimum de 20 centimètres entre le radiateur et votre corps.

Contact Information

YEALINK NETWORK TECHNOLOGY CO.,LTD.

309, 3rd Floor, No.16, Yun Ding North Road, Huli District, Xiamen City,

Fujian, P.R.C

YEALINK (EUROPE) NETWORK TECHNOLOGY B.V.

Strawinskylaan 3127, Atrium Building, 8th floor, 1077ZX Amsterdam, The Netherlands

YEALINK (USA) NETWORK TECHNOLOGY CO., LTD.

999 Peachtree Street Suite 2300, Fulton, Atlanta, GA, 30309, USA

Made in China

YEALINK(XIAMEN) NETWORK TECHNOLOGY CO.,LTD.

Web: www.yealink.com

Copyright©2020 YEALINK(XIAMEN) NETWORK TECHNOLOGY CO.,LTD.All rights reserved.