

# TEST REPORT

Applicant Name: YEALINK(XIAMEN) NETWORK TECHNOLOGY CO.,LTD.  
Address: No.666 Hu'an Rd,Huli District Xiamen City, Fujian, P.R. China  
Report Number: SZ1240109-02053E-RF-00  
FCC ID: T2C-MP54E2

## Test Standard (s)

FCC PART 15.407

## Sample Description

Product Type: Smart Business Phone  
Model No.: MP54 E2  
Multiple Model(s) No.: N/A  
Trade Mark: **Yealink**  
Date Received: 2024/01/09  
Issue Date: 2024/05/31

Test Result:	Pass <sup>▲</sup>
--------------	-------------------

▲ In the configuration tested, the EUT complied with the standards above.

## Prepared and Checked By:

*Andy Yu*

Andy Yu  
RF Engineer

## Approved By:

*Nancy Wang*

Nancy Wang  
RF Supervisor

Note: The information marked # is provided by the applicant, the laboratory is not responsible for its authenticity and this information can affect the validity of the result in the test report. Customer model name, addresses, names, trademarks etc. are included.

This report cannot be reproduced except in full, without prior written approval of the Company. Unless otherwise stated the results shown in this test report refer only to the sample(s) tested. This report is valid only with a valid digital signature. The digital signature may be available only under the Adobe software above version 7.0.

This report must not be used by the customer to claim product certification, approval, or endorsement by NVLAP or any agency of the U.S. Government.

This report may contain data that are not covered by the NVLAP accreditation and are marked with an asterisk "▼".

## Bay Area Compliance Laboratories Corp. (Shenzhen)

5F(B-West) , 6F, 7F, the 3rd Phase of Wan Li Industrial Building D, Shihua Rd, FuTian Free Trade Zone, Shenzhen, China

Tel: +86-755-33320018 Fax: +86-755-33320008 www.baclcorp.com.cn

## TABLE OF CONTENTS

<b>DOCUMENT REVISION HISTORY .....</b>	<b>4</b>
<b>GENERAL INFORMATION.....</b>	<b>5</b>
PRODUCT DESCRIPTION FOR EQUIPMENT UNDER TEST (EUT).....	5
OBJECTIVE .....	5
TEST METHODOLOGY .....	6
MEASUREMENT UNCERTAINTY.....	6
TEST FACILITY .....	6
<b>SYSTEM TEST CONFIGURATION.....</b>	<b>7</b>
DESCRIPTION OF TEST CONFIGURATION .....	7
EUT EXERCISE SOFTWARE .....	9
EQUIPMENT MODIFICATIONS .....	9
SUPPORT EQUIPMENT LIST AND DETAILS .....	9
EXTERNAL I/O CABLE.....	10
BLOCK DIAGRAM OF TEST SETUP .....	10
<b>SUMMARY OF TEST RESULTS .....</b>	<b>12</b>
<b>TEST EQUIPMENT LIST .....</b>	<b>13</b>
<b>FCC §1.1310 &amp; §2.1091- MAXIMUM PERMISSIBLE EXPOSURE (MPE).....</b>	<b>15</b>
APPLICABLE STANDARD .....	15
RESULT .....	15
<b>FCC §15.203 – ANTENNA REQUIREMENT.....</b>	<b>16</b>
APPLICABLE STANDARD .....	16
ANTENNA CONNECTOR CONSTRUCTION .....	16
<b>FCC §15.407 (B) (6) §15.207 (A) – CONDUCTED EMISSIONS.....</b>	<b>17</b>
APPLICABLE STANDARD .....	17
EUT SETUP .....	17
EMI TEST RECEIVER SETUP.....	17
TEST PROCEDURE .....	17
FACTOR & OVER LIMIT CALCULATION.....	18
TEST DATA .....	18
<b>§15.205 &amp; §15.209 &amp; §15.407(B)– UNDESIRABLE EMISSION.....</b>	<b>21</b>
APPLICABLE STANDARD .....	21
EUT SETUP .....	21
EMI TEST RECEIVER & SPECTRUM ANALYZER SETUP .....	23
TEST PROCEDURE .....	23
FACTOR & OVER LIMIT/MARGIN CALCULATION .....	24
TEST DATA .....	24
<b>FCC §15.407(A), (E) – 26 DB &amp; 6DB EMISSION BANDWIDTH.....</b>	<b>50</b>
APPLICABLE STANDARD .....	50
TEST PROCEDURE .....	50
TEST DATA .....	51

**FCC §15.407(A) – CONDUCTED TRANSMITTER OUTPUT POWER.....52**  
    APPLICABLE STANDARD .....52  
    TEST PROCEDURE .....52  
    TEST DATA .....53  
**FCC §15.407(A) - POWER SPECTRAL DENSITY .....54**  
    TEST PROCEDURE .....54  
    TEST DATA .....55  
**EUT PHOTOGRAPHS.....56**  
**TEST SETUP PHOTOGRAPHS .....57**  
**APPENDIX .....58**  
    APPENDIX A1: EMISSION BANDWIDTH .....58  
    APPENDIX A2: OCCUPIED CHANNEL BANDWIDTH .....75  
    APPENDIX A3: MIN EMISSION BANDWIDTH.....97  
    APPENDIX B: MAXIMUM CONDUCTED OUTPUT POWER .....104  
    APPENDIX C: MAXIMUM POWER SPECTRAL DENSITY .....109  
    APPENDIX D: DUTY CYCLE.....133

**DOCUMENT REVISION HISTORY**

Revision Number	Report Number	Description of Revision	Date of Revision
0	SZ1240109-02053E-RF-00	Original Report	2024/05/31

## GENERAL INFORMATION

### Product Description for Equipment under Test (EUT)

Product	Smart Business Phone
Tested Model	MP54 E2
Multiple Model(s)	N/A
Frequency Range	5G Wi-Fi: 5150-5250MHz; 5250-5350MHz; 5470-5600MHz&5650-5725MHz; 5725-5850MHz
Mode	802.11a/n20/n40/ac20/ac40/ac80
Maximum Conducted Average Output Power	5150-5250MHz: 14.24dBm 5250-5350MHz: 13.62dBm 5470-5600MHz&5650-5725MHz: 15.01dBm 5725-5850MHz: 14.52dBm
Modulation Technique	OFDM
Antenna Specification <sup>#</sup>	5.1dBi (provided by the applicant)
Voltage Range	DC 48V from POE or DC 5V from adapter
Sample serial number	2GDB-8 for Conducted and Radiated Emissions Test 2GDB-1 for RF Conducted Test (Assigned by BAACL, Shenzhen)
Sample/EUT Status	Good condition
Adapter Information	Adapter 1 Model:YLPS052000B1-US Input:100-240V,50/60Hz,0.5A Output:5.0V,2.0A Adapter 2 Model:YLPS052000C1-US Input:100-240V,50/60Hz,0.5A Output:5.0V,2.0A Adapter 3 Model:YLPS052000E1-US Input:100-240V,50/60Hz,0.5A Output:5.0V,2.0A

### Objective

This test report is in accordance with Part 2-Subpart J, Part 15-Subparts A and E of the Federal Communication Commissions rules.

The tests were performed in order to determine compliance with FCC Part 15, Subpart E, section 15.203, 15.205, 15.207, 15.209 and 15.407 rules.

## Test Methodology

All measurements contained in this report were conducted with ANSI C63.10-2013, American National Standard of Procedures for Compliance Testing of Unlicensed Wireless Devices. And KDB789033 D02 General U-NII Test Procedures New Rules v02r01.

All emissions measurement was performed at Bay Area Compliance Laboratories Corp. (Shenzhen). The radiated testing was performed at an antenna-to-EUT distance of 3 meters.

Each test item follows test standards and with no deviation.

## Measurement Uncertainty

Parameter		Uncertainty
Occupied Channel Bandwidth		±5%
RF Frequency		213.55 Hz(k=2, 95% level of confidence)
RF output power, conducted		0.72 dB(k=2, 95% level of confidence)
Unwanted Emission, conducted		1.75 dB(k=2, 95% level of confidence)
AC Power Lines Conducted Emissions	9kHz-150kHz	3.94dB(k=2, 95% level of confidence)
	150kHz-30MHz	3.84dB(k=2, 95% level of confidence)
Radiated Emissions	9kHz - 30MHz	3.30dB(k=2, 95% level of confidence)
	30MHz~200MHz (Horizontal)	4.48dB(k=2, 95% level of confidence)
	30MHz~200MHz (Vertical)	4.55dB(k=2, 95% level of confidence)
	200MHz~1000MHz (Horizontal)	4.85dB(k=2, 95% level of confidence)
	200MHz~1000MHz (Vertical)	5.05dB(k=2, 95% level of confidence)
	1GHz - 6GHz	5.35dB(k=2, 95% level of confidence)
	6GHz - 18GHz	5.44dB(k=2, 95% level of confidence)
18GHz - 40GHz	5.16dB(k=2, 95% level of confidence)	
Temperature		±1°C
Humidity		±1%
Supply voltages		±0.4%

*Note: The extended uncertainty given in this report is obtained by combining the standard uncertainty times the coverage factor K with the 95% confidence interval. Otherwise required by the applicant or Product Regulations, Decision Rule in this report did not consider the uncertainty.*

## Test Facility

The Test site used by Bay Area Compliance Laboratories Corp. (Shenzhen) to collect test data is located on the 5F(B-West) , 6F, 7F, the 3rd Phase of Wan Li Industrial Building D, Shihua Rd, FuTian Free Trade Zone, Shenzhen, China.

The lab has been recognized as the FCC accredited lab under the KDB 974614 D01 and is listed in the FCC Public Access Link (PAL) database, FCC Registration No. : 715558, the FCC Designation No. : CN5045.

## SYSTEM TEST CONFIGURATION

### Description of Test Configuration

The system was configured for testing in an engineering mode, which was provided by manufacturer.

The system support 802.11a/n ht20/n ht40/ac vht20/ac vht40/ac vht80, the 802.11 n ht20/n ht40 were reduced since the identical parameters with 802.11ac vht20 and vht40.

For 5150-5250MHz Band, 7 channels are provided to testing:

Channel	Frequency (MHz)	Channel	Frequency (MHz)
36	5180	44	5220
38	5190	46	5230
40	5200	48	5240
42	5210	/	/

For 802.11a/ac20 mode: channel 36, 40, 48 were tested;

For 802.11ac40 mode: channel 38, 46 were tested;

For 802.11ac80 mode, channel 42 was tested.

For 5250-5350MHz Band, 7 channels are provided to testing:

Channel	Frequency (MHz)	Channel	Frequency (MHz)
52	5260	60	5300
54	5270	62	5310
56	5280	64	5320
58	5290	/	/

For 802.11a, 802.11n20/ac20 mode: channel 52, 56, 64 were tested;

For 802.11n40/ac40 mode: channel 54, 62 were tested;

For 802.11ac80 mode, channel 58 was tested.

For 5470-5725MHz Band, 15channels are provided to testing:

Channel	Frequency (MHz)	Channel	Frequency (MHz)
100	5500	132	5660
102	5510	134	5670
104	5520	136	5680
106	5530	138	5690
108	5540	140	5700
110	5550	142	5710
112	5560	144	5720
116	5580		

For 802.11a, 802.11n20/ac20 mode: channel 100, 116, 140 were tested;

For 802.11n40/ac40 mode: channel 102, 110, 134 were tested;

For 802.11ac80 mode, channel 106 was tested;

Cross-band Channel 144, 142, 138 were tested.

For 5725-5850MHz Band, 8 channels are provided to testing:

Channel	Frequency (MHz)	Channel	Frequency (MHz)
149	5745	157	5785
151	5755	159	5795
153	5765	161	5805
155	5775	165	5825

For 802.11a/ac20 mode: channel 149, 157, 165 were tested;

For 802.11ac40 mode: channel 151, 159 were tested;

For 802.11ac80 mode, channel 155 was tested.



**EUT Exercise Software**

“AuthenticTool\_1.2.25.0”<sup>#</sup> software was used and power level as below. The software and power level was provided by the applicant. The device was tested with the worst case was performed as below:

U-NII	Mode	Data rate	Power Level			
			Low Channel	Middle Channel	High Channel	Cross-band Channel
5150-5250MHz	802.11a	6Mbps	14	14	14	/
	802.11ac20	MCS0	13	13	13	/
	802.11ac40	MCS0	12	/	12	/
	802.11ac80	MCS0	/	11	/	/
5250-5350MHz	802.11a	6Mbps	14	14	14	/
	802.11ac20	MCS0	13	13	13	/
	802.11ac40	MCS0	12	/	12	/
	802.11ac80	MCS0	/	11	/	/
5470-5725MHz	802.11a	6Mbps	14	14	14	14
	802.11ac20	MCS0	13	13	13	13
	802.11ac40	MCS0	12	12	12	12
	802.11ac80	MCS0	11	/	11	11
5725 – 5850MHz	802.11a	6Mbps	14	14	14	/
	802.11ac20	MCS0	13	13	13	/
	802.11ac40	MCS0	12	/	12	/
	802.11ac80	MCS0	/	11	/	/

**Equipment Modifications**

No modification was made to the EUT tested.

**Support Equipment List and Details**

Manufacturer	Description	Model	Serial Number
BULL	Socket	GN-415K	5503290068073
DELL	PC	Latitude E5430	JG3NLV1
NOKIA	POE	G0545-530-060-PSE1000	N/A
Grandstream	IP Phone	GXV3480	T11223323B898
Yealink	Earphone	N/A	N/A

**External I/O Cable**

Cable Description	Length (m)	From/Port	To
Un-shielded un-detachable AC cable	1.2	Socket	LISN/ AC Mains
Un-shielded un-detachable DC cable	1.5	Adapter	EUT
Un-shielded detachable RJ45 cable	3.0	EUT	IP Phone
Un-shielded detachable RJ45 cable	3.0	EUT	PC
Un-shielded detachable RJ11 cable	1.8	EUT	Earphone
Un-shielded detachable RJ45 cable	10.0	EUT	PC
Un-shielded detachable RJ45 cable	10.0	EUT	IP Phone

**Block Diagram of Test Setup**

**Powered by Adapter**

For Conducted Emissions:

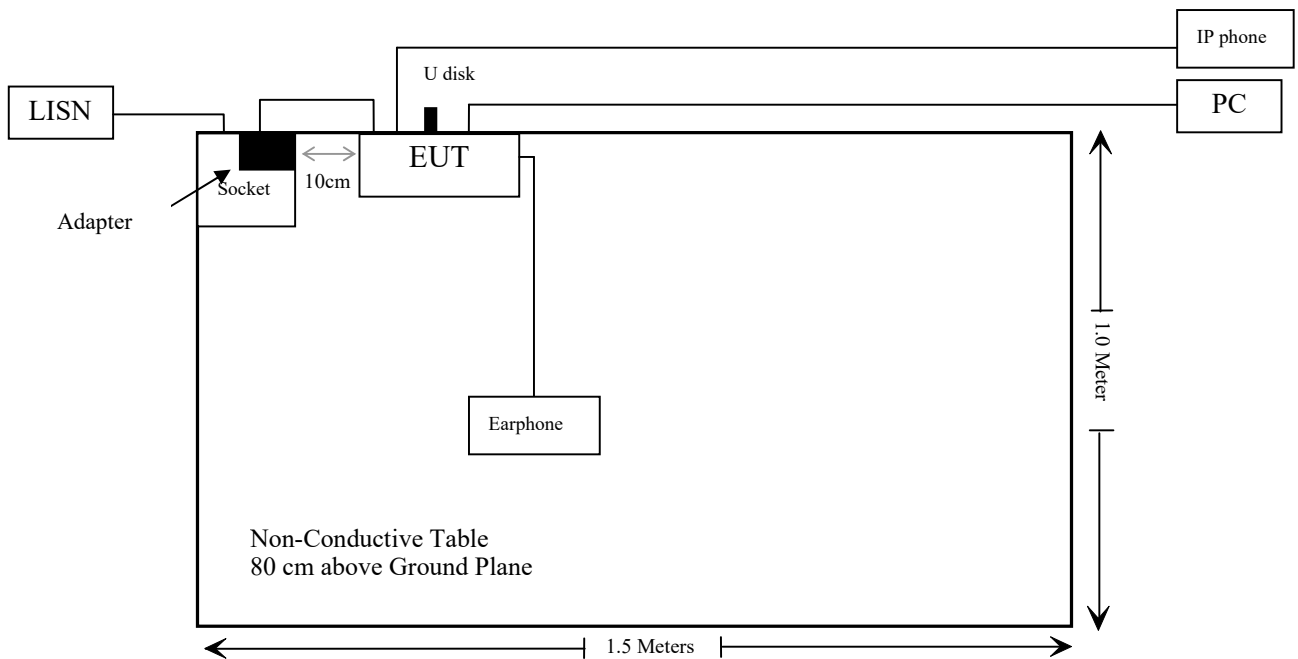

For Radiated Emissions:

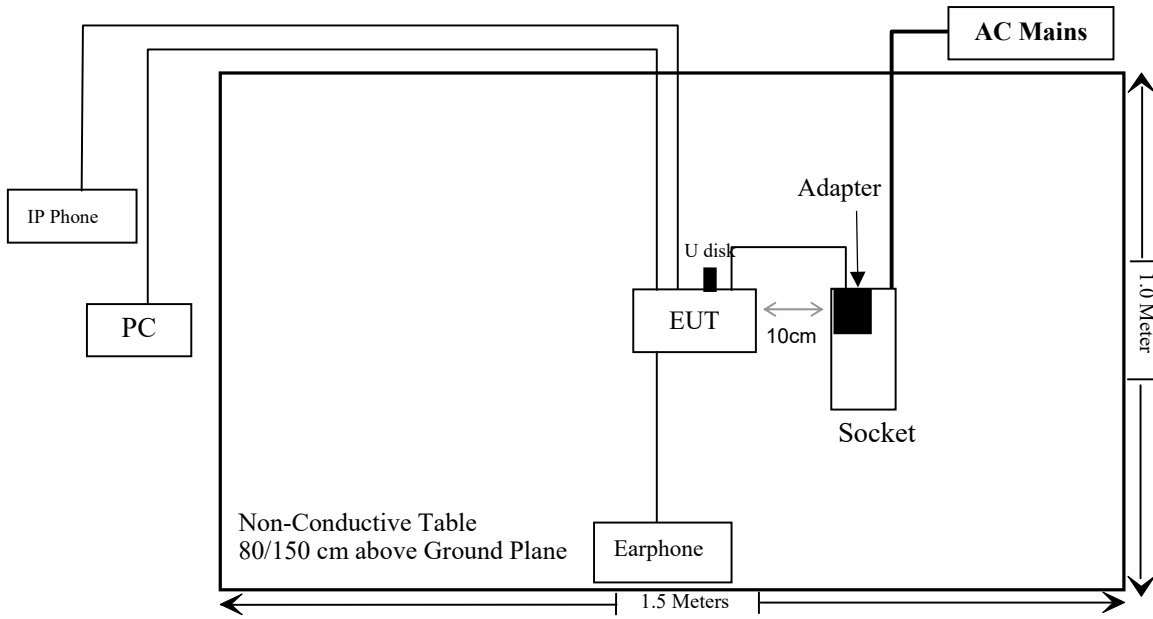

**SUMMARY OF TEST RESULTS**

FCC Rules	Description of Test	Result
§1.1310 & §2.1091	Maximum Permissible Exposure (MPE)	Compliant
§15.203	Antenna Requirement	Compliant
§15.407(b)(9)& §15.207(a)	Conducted Emissions	Compliant
§15.205& §15.209 &§15.407(b)	Undesirable Emission& Restricted Bands	Compliant
§15.407(a) (e)	26 dB Emission Bandwidth & 6dB Bandwidth	Compliant
§15.407(a)	Conducted Transmitter Output Power	Compliant
§15.407 (a)	Power Spectral Density	Compliant
§15.407 (h)	Transmit Power Control (TPC)	Not Applicable
§15.407 (h)	Dynamic Frequency Selection (DFS)	Compliant*

Compliant\*: Please refer to the DFS report SZ1240109-02053E-RFC.

Not Applicable: The supplier declared that the equipment has no this function.

**TEST EQUIPMENT LIST**

Manufacturer	Description	Model	Serial Number	Calibration Date	Calibration Due Date
<b>Conducted Emissions Test</b>					
Rohde & Schwarz	EMI Test Receiver	ESCI	101120	2024/01/16	2025/01/15
Rohde & Schwarz	LISN	ENV216	101613	2024/01/16	2025/01/15
Rohde & Schwarz	Transient Limiter	ESH3Z2	DE25985	2023/08/03	2024/08/02
Unknown	CE Cable	CE Cable	UF A210B-1-0720-504504	2023/08/03	2024/08/02
Audix	EMI Test software	E3	191218	NCR	NCR
<b>Radiated Emissions Test</b>					
R&S	EMI Test Receiver	ESR3	102455	2024/01/16	2025/01/15
Sonoma instrument	Pre-amplifier	310 N	186238	2023/06/08	2024/06/07
Sunol Sciences	Broadband Antenna	JB1	A040904-1	2023/07/20	2024/07/19
ETS	Passive Loop Antenna	6512	29604	2023/07/07	2024/07/06
Unknown	Cable	Chamber Cable 1	F-03-EM236	2023/08/03	2024/08/02
Unknown	Cable	Chamber Cable 4	EC-007	2023/08/03	2024/08/02
Audix	EMI Test software	E3	19821b(V9)	NCR	NCR
Rohde & Schwarz	Spectrum Analyzer	FSV40	101605	2023/04/18	2024/04/17
COM-POWER	Pre-amplifier	PA-122	181919	2023/06/29	2024/06/28
Schwarzbeck	Horn Antenna	BBHA9120D(1201)	1143	2023/07/26	2024/07/25
Unknown	RF Cable	KMSE	0735	2023/10/08	2024/10/07
Unknown	RF Cable	UFA147	219661	2023/10/08	2024/10/07
JD	Multiplex Switch Test Control Set	DT7220FSU	DQ77926	NCR	NCR
SNSD	5G Band Reject filter	BSF5150-5850MN-0899-004	5G filter	2023/08/03	2024/08/02
Audix	EMI Test software	E3	191218(V9)	NCR	NCR
A.H.System	Pre-amplifier	PAM-1840VH	190	2023/08/03	2024/08/02
Electro-Mechanics Co	Horn Antenna	3116	9510-2270	2023/09/18	2026/09/17
UTIFLEX	RF Cable	NO. 13	232308-001	2023/08/03	2024/08/02

Manufacturer	Description	Model	Serial Number	Calibration Date	Calibration Due Date
<b>RF Conducted Test</b>					
Tonscend	RF control Unit	JS0806-2	19D8060154	2023/09/06	2024/09/05
Rohde & Schwarz	Signal and Spectrum Analyzer	FSV40	101473	2024/01/16	2025/01/15
Unknown	10dB Attenuator	Unknown	F-03-EM190	2023/07/04	2024/07/03
Micro-Tronics	RF Cable	8082135	W1113	2023/07/04	2024/07/03

\* **Statement of Traceability:** Bay Area Compliance Laboratories Corp. (Shenzhen) attests that all calibrations have been performed in accordance to requirements that traceable to National Primary Standards and International System of Units (SI).

**FCC §1.1310 & §2.1091- MAXIMUM PERMISSIBLE EXPOSURE (MPE)**

**Applicable Standard**

According to subpart 2.1091 systems operating under the provisions of this section shall be operated in a manner that ensures the public is not exposed to RF energy level in excess of the communication guidelines.

Limits for General Population/Uncontrolled Exposure

Limits for General Population/Uncontrolled Exposure				
Frequency Range (MHz)	Electric Field Strength (V/m)	Magnetic Field Strength (A/m)	Power Density (mW/cm <sup>2</sup> )	Averaging Time (Minutes)
0.3-1.34	614	1.63	*(100)	30
1.34-30	824/f	2.19/f	*(180/f <sup>2</sup> )	30
30-300	27.5	0.073	0.2	30
300-1500	/	/	f/1500	30
1500-100,000	/	/	1.0	30

f = frequency in MHz

\* = Plane-wave equivalent power density

**Result**

**Calculated Formulary:**

Predication of MPE limit at a given distance

$$S = \frac{PG}{4\pi R^2}$$

S = power density (in appropriate units, e.g. mW/cm<sup>2</sup>)

P = power input to the antenna (in appropriate units, e.g., mW).

G = power gain of the antenna in the direction of interest relative to an isotropic radiator, the power gain factor, is normally numeric gain.

R = distance to the center of radiation of the antenna (appropriate units, e.g., cm)

Frequency (MHz)	Antenna Gain <sup>#</sup>		Tune up conducted power <sup>#</sup>		Evaluation Distance (cm)	Power Density (mW/cm <sup>2</sup> )	MPE Limit (mW/cm <sup>2</sup> )
	(dBi)	(numeric)	(dBm)	(mW)			
5180-5240	5.1	3.24	14.5	28.18	20	0.018	1
5260-5320	5.1	3.24	14.0	25.12	20	0.016	1
5500-5720	5.1	3.24	15.5	35.48	20	0.023	1
5745-5825	5.1	3.24	15.0	31.62	20	0.020	1

Note: To maintain compliance with the FCC’s RF exposure guidelines, place the equipment at least 20cm from nearby persons.

**Result: Compliant**

## **FCC §15.203 – ANTENNA REQUIREMENT**

### **Applicable Standard**

According to § 15.203, an intentional radiator shall be designed to ensure that no antenna other than that furnished by the responsible party shall be used with the device. The use of a permanently attached antenna or of an antenna that uses a unique coupling to the intentional radiator shall be considered sufficient to comply with the provisions of this section. The manufacturer may design the unit so that a broken antenna can be replaced by the user, but the user of a standard antenna jack or electrical connector is prohibited. The structure and application of the EUT were analyzed to determine compliance with section §15.203 of the rules. §15.203 state that the subject device must meet the following criteria:

- a. Antenna must be permanently attached to the unit.
- b. Antenna must use a unique type of connector to attach to the EUT.
- c. Unit must be professionally installed, and installer shall be responsible for verifying that the correct antenna is employed with the unit.

And according to FCC 47 CFR section 15.407 (a), if the transmitting antennas of directional gain greater than 6dBi are used, the transmit power and power spectral density shall be reduced by the amount in dB that the directional gain of the antenna exceeds 6 dBi.

### **Antenna Connector Construction**

The EUT has an internal antennas which was permanently attached, and the maximum antenna gain<sup>#</sup> is 5.1dBi, fulfill the requirement of this section. Please refer to the EUT photos.

**Result: Compliant**



**FCC §15.407 (b) (6) §15.207 (a) – CONDUCTED EMISSIONS**

**Applicable Standard**

FCC §15.207, §15.407(b) (6)

**EUT Setup**

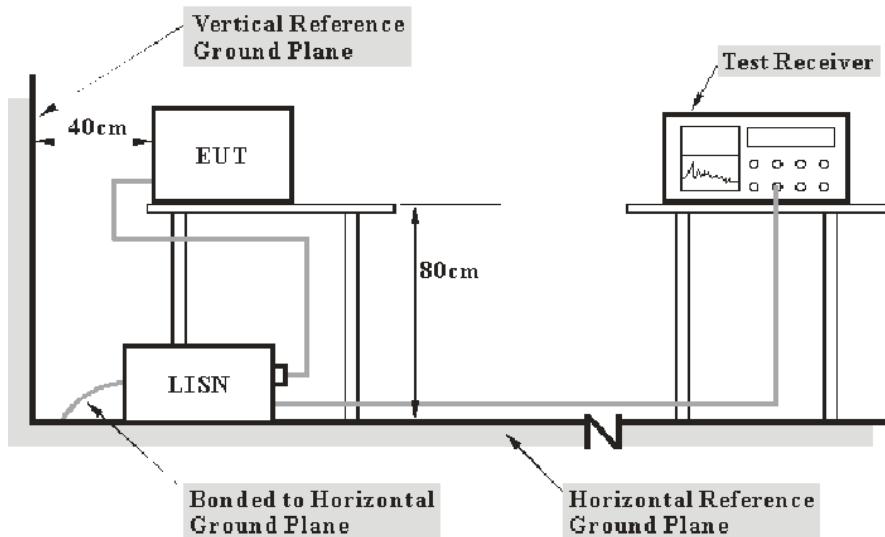

- Note: 1. Support units were connected to second LISN.  
 2. Both of LISNs (AMN) 80 cm from EUT and at the least 80 cm from other units and other metal planes support units.

The setup of EUT is according with per ANSI C63.10-2013 measurement procedure. The specification used was with the FCC Part 15.207 limits.

The spacing between the peripherals was 10 cm.

**EMI Test Receiver Setup**

The EMI test receiver was set to investigate the spectrum from 150 kHz to 30 MHz.

During the conducted emission test, the EMI test receiver was set with the following configurations:

Frequency Range	IF B/W
150 kHz – 30 MHz	9 kHz

**Test Procedure**

During the conducted emission test, the adapter was connected to the LISN.

Maximizing procedure was performed on the six (6) highest emissions of the EUT.

All data was recorded in the Quasi-peak and Average detection mode.

## Factor & Over Limit Calculation

The factor is calculated by adding LISN VDF (Voltage Division Factor) and Cable Loss. The basic equation is as follows:

$$\text{Factor} = \text{LISN VDF} + \text{Cable Loss}$$

The “**Over limit**” column of the following data tables indicates the degree of compliance with the applicable limit. For example, an Over limit of -7 dB means the emission is 7 dB below the limit. The equation for calculation is as follows:

$$\begin{aligned}\text{Over Limit} &= \text{Level} - \text{Limit} \\ \text{Level} &= \text{Read Level} + \text{Factor}\end{aligned}$$

Note: The term "cable loss" refers to the combination of a cable and a 10dB transient limiter (attenuator).

## Test Data

### Environmental Conditions

<b>Temperature:</b>	23 °C
<b>Relative Humidity:</b>	53 %
<b>ATM Pressure:</b>	101 kPa

*The testing was performed by Macy Shi on 2024-03-14.*

*EUT operation mode: Transmitting (Maximum output power mode 802.11a 5500MHz)*

*Note: according to the test result of BT report, the worse case is adapter 1 YLPS052000B1-US was tested.*

AC 120V/60 Hz, Line

Date: 2024-03-14

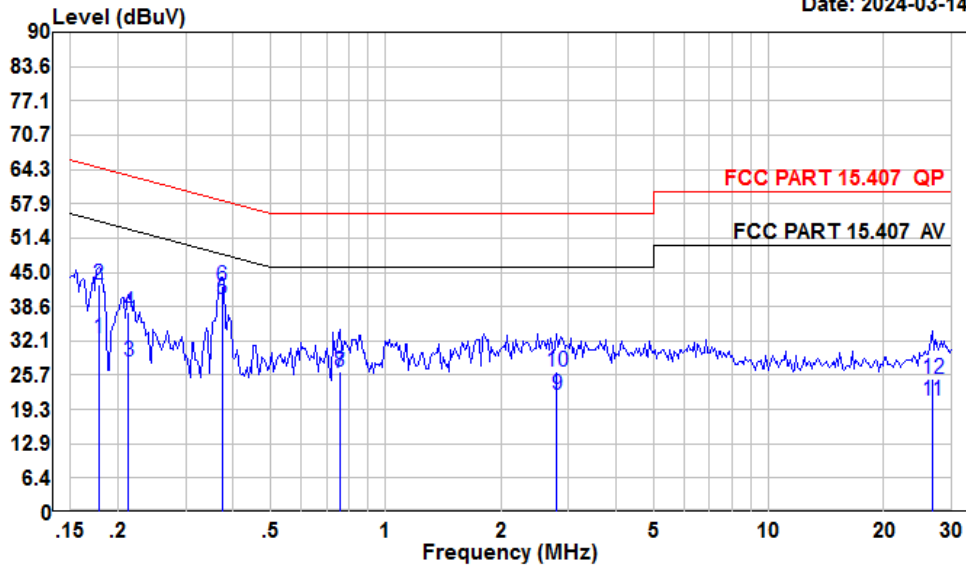

Condition: Line  
 Project : SZ1240109-02053E-RF  
 Tester : Macy shi  
 Note : 5G WIFI

	Read Freq	Read Level	LISN Level	LISN Factor	Cable Loss	Limit Line	Over Limit	Remark
	MHz	dBuV	dBuV	dB	dB	dBuV	dB	
1	0.18	11.62	32.59	10.84	10.13	54.59	-22.00	Average
2	0.18	21.69	42.66	10.84	10.13	64.59	-21.93	QP
3	0.21	7.27	28.17	10.78	10.12	53.10	-24.93	Average
4	0.21	16.64	37.54	10.78	10.12	63.10	-25.56	QP
5	0.37	19.30	40.09	10.60	10.19	48.43	-8.34	Average
6	0.37	21.59	42.38	10.60	10.19	58.43	-16.05	QP
7	0.76	5.37	26.04	10.48	10.19	46.00	-19.96	Average
8	0.76	5.76	26.43	10.48	10.19	56.00	-29.57	QP
9	2.79	1.27	21.98	10.46	10.25	46.00	-24.02	Average
10	2.79	5.81	26.52	10.46	10.25	56.00	-29.48	QP
11	26.70	0.22	21.08	10.61	10.25	50.00	-28.92	Average
12	26.70	4.22	25.08	10.61	10.25	60.00	-34.92	QP

AC 120V/60 Hz, Neutral

Date: 2024-03-14

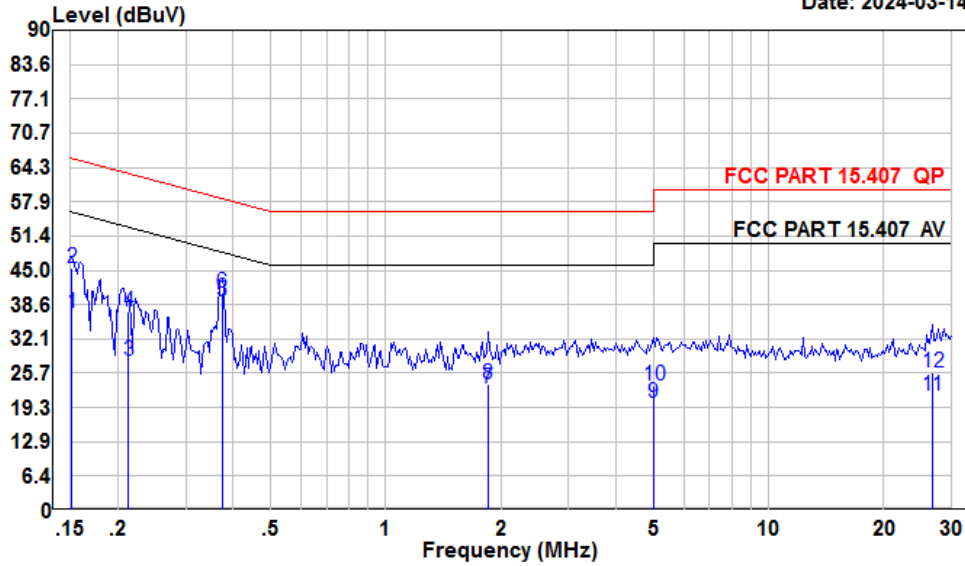

Condition: Neutral  
 Project : SZ1240109-02053E-RF  
 Tester : Macy shi  
 Note : 5G WIFI

	Read Freq	Read Level	LISN Level	LISN Factor	Cable Loss	Limit Line	Over Limit	Remark
	MHz	dBuV	dBuV	dB	dB	dBuV	dB	
1	0.15	16.25	36.99	10.59	10.15	55.91	-18.92	Average
2	0.15	24.71	45.45	10.59	10.15	65.91	-20.46	QP
3	0.21	7.44	27.98	10.42	10.12	53.10	-25.12	Average
4	0.21	16.73	37.27	10.42	10.12	63.10	-25.83	QP
5	0.37	18.27	39.06	10.60	10.19	48.43	-9.37	Average
6	0.37	20.13	40.92	10.60	10.19	58.43	-17.51	QP
7	1.85	2.25	22.86	10.46	10.15	46.00	-23.14	Average
8	1.85	3.07	23.68	10.46	10.15	56.00	-32.32	QP
9	5.01	-0.55	20.19	10.52	10.22	50.00	-29.81	Average
10	5.01	2.52	23.26	10.52	10.22	60.00	-36.74	QP
11	26.70	0.68	21.49	10.56	10.25	50.00	-28.51	Average
12	26.70	5.08	25.89	10.56	10.25	60.00	-34.11	QP

## §15.205 & §15.209 & §15.407(B)– UNDESIRABLE EMISSION

### Applicable Standard

FCC §15.407 (b); §15.209; §15.205;

(b) Undesirable emission limits. Except as shown in paragraph (b)(7) of this section, the maximum emissions outside of the frequency bands of operation shall be attenuated in accordance with the following limits:

- (1) For transmitters operating in the 5.15-5.25 GHz band: All emissions outside of the 5.15-5.35 GHz band shall not exceed an e.i.r.p. of  $-27$  dBm/MHz.
- (2) For transmitters operating in the 5.25-5.35 GHz band: All emissions outside of the 5.15-5.35 GHz band shall not exceed an e.i.r.p. of  $-27$  dBm/MHz.
- (3) For transmitters operating in the 5.47-5.725 GHz band: All emissions outside of the 5.47-5.725 GHz band shall not exceed an e.i.r.p. of  $-27$  dBm/MHz.
- (4) For transmitters operating in the 5.725-5.85 GHz band:
  - (i) All emissions shall be limited to a level of  $-27$  dBm/MHz at 75 MHz or more above or below the band edge increasing linearly to 10 dBm/MHz at 25 MHz above or below the band edge, and from 25 MHz above or below the band edge increasing linearly to a level of 15.6 dBm/MHz at 5 MHz above or below the band edge, and from 5 MHz above or below the band edge increasing linearly to a level of 27 dBm/MHz at the band edge.

Unwanted emissions below 1 GHz must comply with the general field strength limits set forth in §15.209.

### EUT Setup

9 kHz-30MHz:

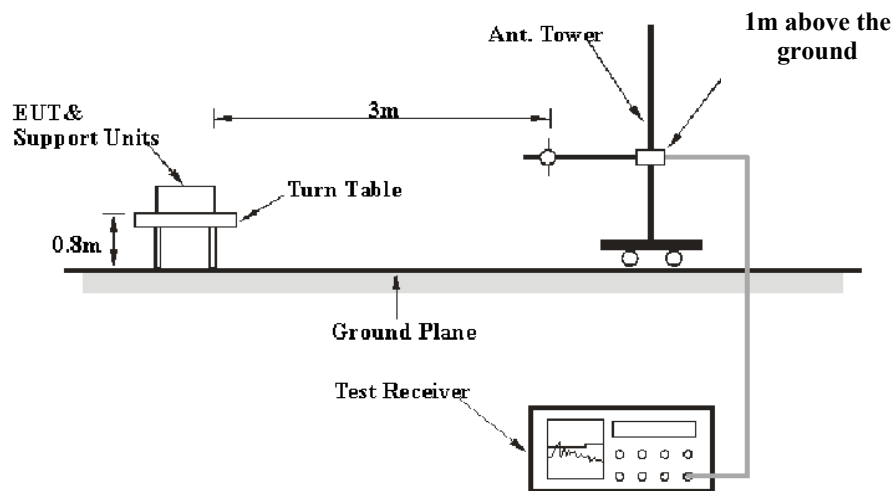

**30MHz-1GHz:**

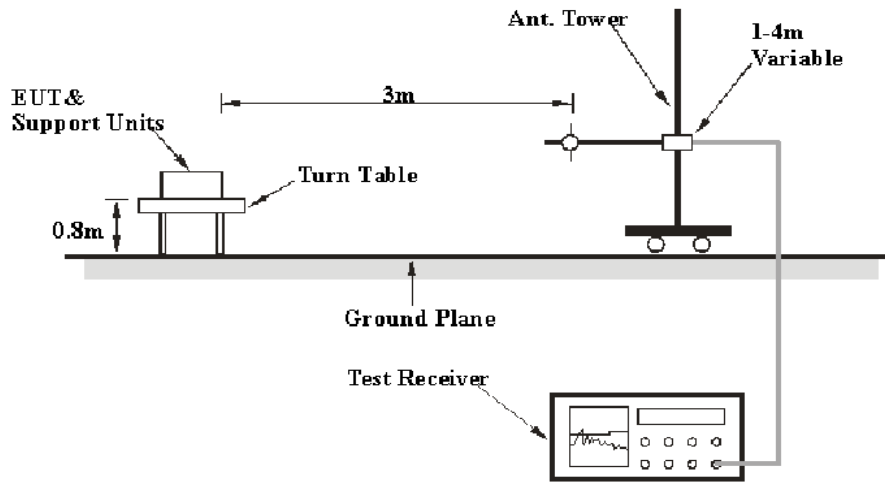

**Above 1 GHz:**

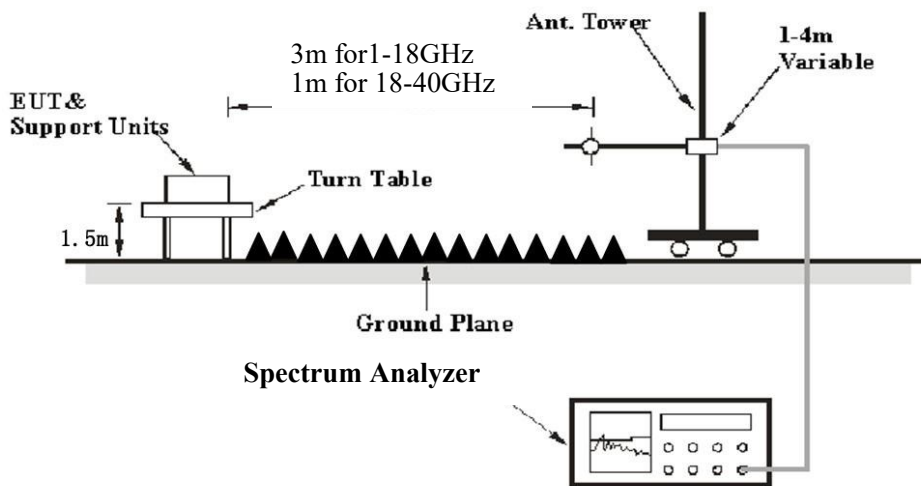

The setup of EUT is according with per ANSI C63.10-2013 measurement procedure. The specification used was with the FCC 15.209 and FCC 15.407 limits.

The external I/O cables were draped along the test table and formed a bundle 30 to 40 cm long in the middle.

## EMI Test Receiver & Spectrum Analyzer Setup

The system was investigated from 9 kHz to 40 GHz.

During the radiated emission test, the EMI test receiver & Spectrum Analyzer Setup were set with the following configurations:

9 kHz-1GHz:

Frequency Range	RBW	Video B/W	IF B/W	Measurement
9 kHz – 150 kHz	/	/	200 Hz	QP
	300 Hz	1 kHz	/	PK
150 kHz – 30 MHz	/	/	9 kHz	QP
	10 kHz	30 kHz	/	PK
30 MHz – 1000 MHz	/	/	120 kHz	QP
	100 kHz	300 kHz	/	PK

1-40GHz:

Frequency Range	Duty cycle	RBW	Video B/W
PK	Any	1MHz	3 MHz
AV	>98%	1MHz	10 Hz
	<98%	1MHz	≥1/Ton

Note: Ton is minimum transmission duration

If the maximized peak measured value complies with under the QP/Average limit more than 6dB, then it is unnecessary to perform an QP/Average measurement.

## Test Procedure

### Radiated Spurious Emission

During the radiated emission test, the adapter was connected to the AC floor outlet.

Maximizing procedure was performed on the highest emissions to ensure that the EUT complied with all the installation combinations.

All final data was recorded in Quasi-peak detection mode except for the frequency bands 9–90 kHz, 110–490 kHz and above 1000 MHz, average detection modes for frequency bands 9–90 kHz and 110–490 kHz, peak and average detection modes for frequencies above 1 GHz.

For 9 kHz-30MHz, the report shall list the six emissions with the smallest margin relative to the limit, for each of the three antenna orientations (parallel, perpendicular, and ground-parallel) unless the margin is greater than 20 dB.

All emissions under the average limit and under the noise floor have not recorded in the report.

According to ANSI C63.10-2013,9.4: For field strength measurements made at other than the distance at which the applicable limit is specified, extrapolate the measured field strength to the field strength at the distance specified by the limit using an inverse distance correction factor (20 dB/decade of distance). In some cases, a different distance correction factor may be required;

$$E_{\text{SpecLimit}} = E_{\text{Meas}} + 20 \log \left( \frac{d_{\text{Meas}}}{d_{\text{SpecLimit}}} \right)$$

where

- $E_{\text{SpecLimit}}$  is the field strength of the emission at the distance specified by the limit, in dB $\mu$ V/m
- $E_{\text{Meas}}$  is the field strength of the emission at the measurement distance, in dB $\mu$ V/m
- $d_{\text{Meas}}$  is the measurement distance, in m
- $d_{\text{SpecLimit}}$  is the distance specified by the limit, in m

So the extrapolation factor of 1m is  $20 \cdot \log(1/3) = -9.5$  dB, for 18-40GHz range, the limit of 1m distance was added by 9.5dB from limit of 3m to compared with the result measurement at 1m distance.

### Factor & Over Limit/Margin Calculation

The Factor is calculated by adding the Antenna Factor and Cable Loss, and subtracting the Amplifier Gain. The basic equation is as follows:

$$\text{Factor} = \text{Antenna Factor} + \text{Cable Loss} - \text{Amplifier Gain}$$

The “**Over Limit/Margin**” column of the following data tables indicates the degree of compliance with the applicable limit. For example, an Over Limit/margin of -7dB means the emission is 7dB below the limit. The equation for calculation is as follows:

$$\begin{aligned} \text{Over Limit} &= \text{Level} - \text{Limit}; \text{Margin} = \text{Limit} - \text{Corrected Amplitude} \\ \text{Level} / \text{Corrected Amplitude} &= \text{Read Level} + \text{Factor} \end{aligned}$$

### Test Data

#### Environmental Conditions

<b>Temperature:</b>	23~25.3 °C
<b>Relative Humidity:</b>	51~56 %
<b>ATM Pressure:</b>	101 kPa

The testing was performed by Anson Su on 2024-03-16 for below 1GHz and Zenos Qiao from 2024-03-09 to 2024-03-10 for above 1GHz.

EUT operation mode: Transmitting

Note: After pre-scan in the X, Y and Z axes of orientation, the worst case is below.



*Note: according to the test result of BT report, the worse case is adapter 1 YLPS052000B1-US was tested.*

**9 kHz-30MHz:** *(Maximum output power mode 802.11a 5500MHz)*

*The amplitude of spurious emissions attenuated more than 20 dB below the limit was not recorded.*

30 MHz–1 GHz: (Maximum output power mode 802.11a 5500MHz)

Horizontal

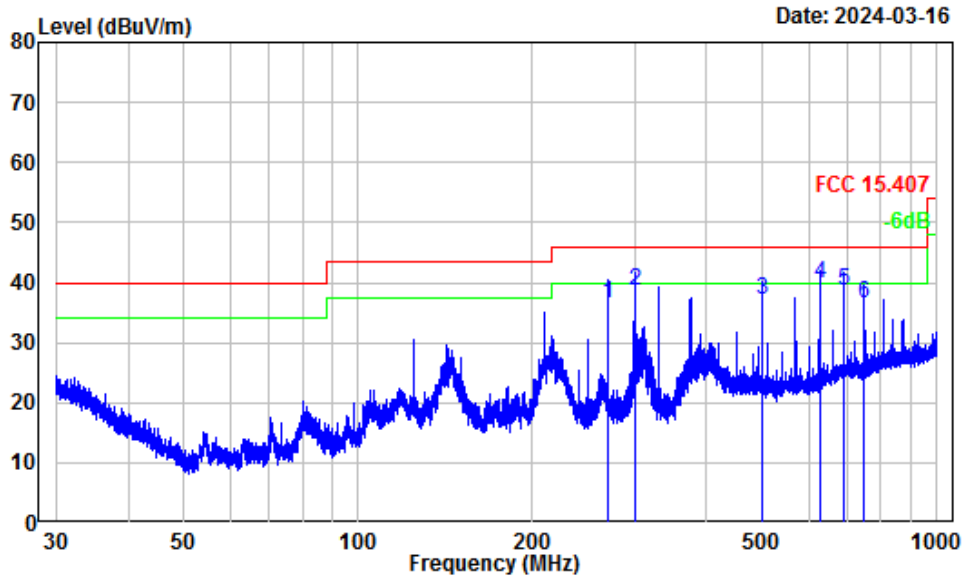

Site : Chamber A  
 Condition : 3m Horizontal  
 Project Number: SZ1240109-02053E-RF  
 Note : 5G WIFI  
 Tester : Anson Su

	Read	Limit	Over			
Freq	Level	Level	Limit	Limit	Remark	
MHz	dB/m	dBuV	dBuV/m	dBuV/m	dB	
1	270.02	-11.09	47.58	36.49	46.00	-9.51 QP
2	299.97	-9.96	48.65	38.69	46.00	-7.31 QP
3	500.08	-5.05	42.10	37.05	46.00	-8.95 QP
4	630.03	-3.25	43.00	39.75	46.00	-6.25 QP
5	690.17	-1.70	40.31	38.61	46.00	-7.39 QP
6	750.11	-1.67	38.15	36.48	46.00	-9.52 QP

**Vertical**

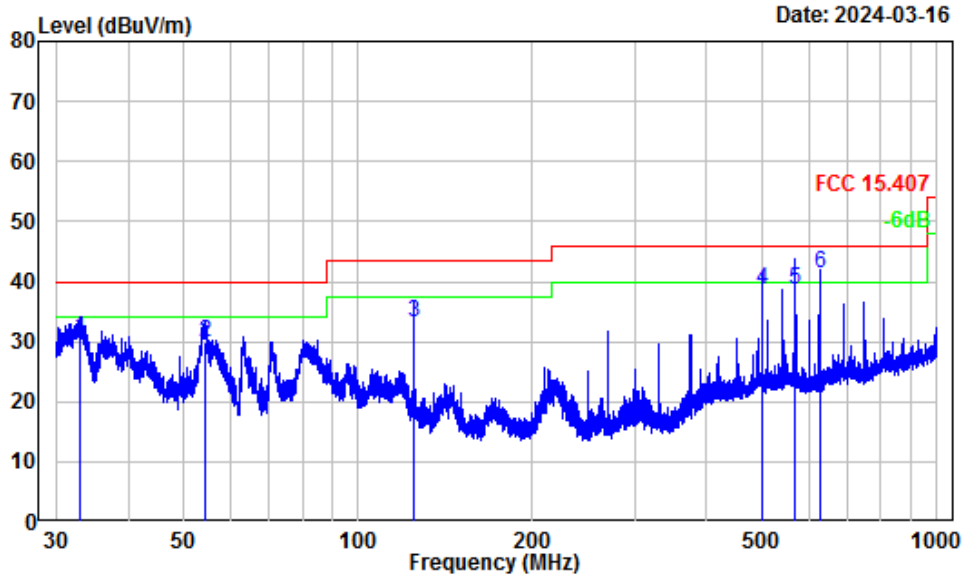

Site : Chamber A  
 Condition : 3m Vertical  
 Project Number: SZ1240109-02053E-RF  
 Note : 5G WIFI  
 Tester : Anson Su

	Freq	Factor	Read Level	Level	Limit	Over	Remark
	MHz	dB/m	dBuV	dBuV/m	dBuV/m	dB	
1	33.01	-7.49	38.10	30.61	40.00	-9.39	QP
2	54.26	-17.53	47.50	29.97	40.00	-10.03	QP
3	125.01	-10.77	44.06	33.29	43.50	-10.21	QP
4	500.08	-5.25	44.00	38.75	46.00	-7.25	QP
5	570.11	-4.71	43.20	38.49	46.00	-7.51	QP
6	630.03	-3.49	44.99	41.50	46.00	-4.50	QP

**Above 1GHz:**

**5150-5250 MHz:**

Frequency (MHz)	Receiver		Polar (H/V)	Factor (dB/m)	Corrected Amplitude (dBµV/m)	Limit (dBµV/m)	Margin (dB)
	Reading (dBµV)	PK/Ave					
<b>802.11a</b>							
<b>5180MHz</b>							
5148.90	60.31	PK	H	2.71	63.02	74	-10.98
5148.90	46.12	AV	H	2.71	48.83	54	-5.17
5148.90	59.62	PK	V	2.71	62.33	74	-11.67
5148.90	45.67	AV	V	2.71	48.38	54	-5.62
10360.00	47.42	PK	H	13.07	60.49	68.2	-7.71
10360.00	47.14	PK	V	13.07	60.21	68.2	-7.99
<b>5200MHz</b>							
10400.00	46.96	PK	H	13.12	60.08	68.2	-8.12
10400.00	46.64	PK	V	13.12	59.76	68.2	-8.44
<b>5240MHz</b>							
5459.69	55.2	PK	H	3.05	58.25	74	-15.75
5459.69	41.55	AV	H	3.05	44.6	54	-9.4
5411.84	54.92	PK	V	3.00	57.92	74	-16.08
5411.84	41.31	AV	V	3.00	44.31	54	-9.69
10480.00	46.51	PK	H	13.07	59.58	68.2	-8.62
10480.00	46.37	PK	V	13.07	59.44	68.2	-8.76

Frequency (MHz)	Receiver		Polar (H/V)	Factor (dB/m)	Corrected Amplitude (dBµV/m)	Limit (dBµV/m)	Margin (dB)
	Reading (dBµV)	PK/Ave					
<b>802.11ac20</b>							
<b>5180MHz</b>							
5148.27	84.16	PK	H	2.7	86.86	74	12.86
5148.27	45.99	AV	H	2.7	48.69	54	-5.31
5147.82	58.05	PK	V	2.70	60.75	74	-13.25
5147.82	45.58	AV	V	2.70	48.28	54	-5.72
10360.00	47.36	PK	H	13.07	60.43	68.2	-7.77
10360.00	47.03	PK	V	13.07	60.10	68.2	-8.10
<b>5200MHz</b>							
10400.00	46.84	PK	H	13.12	59.96	68.2	-8.24
10400.00	46.57	PK	V	13.12	59.69	68.2	-8.51
<b>5240MHz</b>							
5432.19	55.71	PK	H	3.03	58.74	74	-15.26
5432.19	41.7	AV	H	3.03	44.73	54	-9.27
5445.94	55.45	PK	V	3.06	58.51	74	-15.49
5445.94	41.52	AV	V	3.06	44.58	54	-9.42
10480.00	46.27	PK	H	13.07	59.34	68.2	-8.86
10480.00	46.05	PK	V	13.07	59.12	68.2	-9.08

Frequency (MHz)	Receiver		Polar (H/V)	Factor (dB/m)	Corrected Amplitude (dBµV/m)	Limit (dBµV/m)	Margin (dB)
	Reading (dBµV)	PK/Ave					
<b>802.11AC40</b>							
<b>5190MHz</b>							
5148.45	60.46	PK	H	2.7	63.16	74	-10.84
5148.45	48.25	AV	H	2.7	50.95	54	-3.05
5149.17	59.35	PK	V	2.71	62.06	74	-11.94
5149.17	47.83	AV	V	2.71	50.54	54	-3.46
10380.00	46.24	PK	H	13.09	59.33	68.2	-8.87
10380.00	46.01	PK	V	13.09	59.10	68.2	-9.10
<b>5230MHz</b>							
5431.14	55.54	PK	H	3.04	58.58	74	-15.42
5431.14	42.06	AV	H	3.04	45.1	54	-8.9
5457.89	55.39	PK	V	3.06	58.45	74	-15.55
5457.89	41.92	AV	V	3.06	44.98	54	-9.02
10460.00	45.69	PK	H	13.09	58.78	68.2	-9.42
10460.00	45.42	PK	V	13.09	58.51	68.2	-9.69
<b>802.11AC80</b>							
<b>5210MHz</b>							
5148.34	58.99	PK	H	2.7	61.69	74	-12.31
5148.34	48.21	AV	H	2.7	50.91	54	-3.09
5148.63	57.88	PK	V	2.71	60.59	74	-13.41
5148.63	47.78	AV	V	2.71	50.49	54	-3.51
5452.68	55.67	PK	H	3.06	58.73	74	-15.27
5452.68	42.85	AV	H	3.06	45.91	54	-8.09
5458.26	55.02	PK	V	3.06	58.08	74	-15.92
5458.26	42.66	AV	V	3.06	45.72	54	-8.28
10420.00	45.38	PK	H	13.12	58.50	68.2	-9.70
10420.00	45.13	PK	V	13.12	58.25	68.2	-9.95

**5250-5350MHz:**

Frequency (MHz)	Receiver		Polar (H/V)	Factor (dB/m)	Corrected Amplitude (dBµV/m)	Limit (dBµV/m)	Margin (dB)
	Reading (dBµV)	PK/Ave					
<b>802.11a</b>							
<b>5260MHz</b>							
4991.57	55.39	PK	H	2.91	58.3	74	-15.7
4991.57	41.58	AV	H	2.91	44.49	54	-9.51
5091.91	55.05	PK	V	2.76	57.81	74	-16.19
5091.91	41.43	AV	V	2.76	44.19	54	-9.81
10520.00	47.09	PK	H	13.05	60.14	68.2	-8.06
10520.00	46.78	PK	V	13.05	59.83	68.2	-8.37
<b>5280MHz</b>							
10560.00	46.56	PK	H	13.02	59.58	68.2	-8.62
10560.00	46.33	PK	V	13.02	59.35	68.2	-8.85
<b>5320MHz</b>							
5352.26	63.55	PK	H	2.91	66.46	74	-7.54
5352.26	47.48	AV	H	2.91	50.39	54	-3.61
5352.41	62.01	PK	V	2.91	64.92	74	-9.08
5352.41	46.69	AV	V	2.91	49.6	54	-4.4
10640.00	46.27	PK	H	13.19	59.46	74	-14.54
10640.00	32.86	AV	H	13.19	46.05	54	-7.95
10640.00	46.04	PK	V	13.19	59.23	74	-14.77
10640.00	32.65	AV	V	13.19	45.84	54	-8.16

Frequency (MHz)	Receiver		Polar (H/V)	Factor (dB/m)	Corrected Amplitude (dBµV/m)	Limit (dBµV/m)	Margin (dB)
	Reading (dBµV)	PK/Ave					
<b>802.11ac20</b>							
<b>5260MHz</b>							
5029.44	55.64	PK	H	2.96	58.6	74	-15.4
5029.44	41.68	AV	H	2.96	44.64	54	-9.36
5046.55	55.13	PK	V	2.95	58.08	74	-15.92
5046.55	41.51	AV	V	2.95	44.46	54	-9.54
10520.00	46.87	PK	H	13.05	59.92	68.2	-8.28
10520.00	46.56	PK	V	13.05	59.61	68.2	-8.59
<b>5280MHz</b>							
10560.00	46.54	PK	H	13.02	59.56	68.2	-8.64
10560.00	46.29	PK	V	13.02	59.31	68.2	-8.89
<b>5320MHz</b>							
5350.31	62.68	PK	H	2.90	65.58	74	-8.42
5350.31	46.77	AV	H	2.90	49.67	54	-4.33
5350.82	61.94	PK	V	2.90	64.84	74	-9.16
5350.82	46.1	AV	V	2.90	49.00	54	-5.00
10640.00	46.15	PK	H	13.19	59.34	74	-14.66
10640.00	32.83	AV	H	13.19	46.02	54	-7.98
10640.00	45.77	PK	V	13.19	58.96	74	-15.04
10640.00	32.69	AV	V	13.19	45.88	54	-8.12



Frequency (MHz)	Receiver		Polar (H/V)	Factor (dB/m)	Corrected Amplitude (dBµV/m)	Limit (dBµV/m)	Margin (dB)
	Reading (dBµV)	PK/Ave					
<b>802.11AC40</b>							
<b>5270MHz</b>							
4804.22	55.41	PK	H	2.42	57.83	74	-16.17
4804.22	42.27	AV	H	2.42	44.69	54	-9.31
5011.48	54.92	PK	V	2.97	57.89	74	-16.11
5011.48	42.03	AV	V	2.97	45.00	54	-9.00
10540.00	46.06	PK	H	13.03	59.09	68.2	-9.11
10540.00	45.75	PK	V	13.03	58.78	68.2	-9.42
<b>5310MHz</b>							
5351.06	66.36	PK	H	2.90	69.26	74	-4.74
5351.06	48.08	AV	H	2.90	50.98	54	-3.02
5351.19	64.71	PK	V	2.90	67.61	74	-6.39
5351.19	47.46	AV	V	2.90	50.36	54	-3.64
10620.00	45.71	PK	H	13.09	58.80	74	-15.20
10620.00	32.64	AV	H	13.09	45.73	54	-8.27
10620.00	45.36	PK	V	13.09	58.45	74	-15.55
10620.00	32.47	AV	V	13.09	45.56	54	-8.44
<b>802.11AC80</b>							
<b>5290MHz</b>							
4937.33	55.75	PK	H	2.62	58.37	74	-15.63
4937.33	43.32	AV	H	2.62	45.94	54	-8.06
5038.69	54.62	PK	V	2.95	57.57	74	-16.43
5038.69	43.12	AV	V	2.95	46.07	54	-7.93
5354.09	61.29	PK	H	2.92	64.21	74	-9.79
5354.09	47.96	AV	H	2.92	50.88	54	-3.12
5355.55	59.99	PK	V	2.92	62.91	74	-11.09
5355.55	47.25	AV	V	2.92	50.17	54	-3.83
10580.00	45.32	PK	H	13.00	58.32	68.2	-9.88
10580.00	45.06	PK	V	13.00	58.06	68.2	-10.14

**5470-5725MHz:**

Frequency (MHz)	Receiver		Polar (H/V)	Factor (dB/m)	Corrected Amplitude (dBµV/m)	Limit (dBµV/m)	Margin (dB)
	Reading (dBµV)	PK/Ave					
<b>802.11a</b>							
<b>5500MHz</b>							
5460.00	53.85	PK	H	3.05	56.90	74.00	-17.1
5460.00	41.77	AV	H	3.05	44.82	54.00	-9.18
5466.38	61.51	PK	H	3.06	64.57	68.20	-3.63
5460.00	53.35	PK	V	3.05	56.40	74.00	-17.6
5460.00	41.66	AV	V	3.05	44.71	54.00	-9.29
5466.75	60.47	PK	V	3.06	63.53	68.20	-4.67
11000.00	45.31	PK	H	13.98	59.29	74	-14.71
11000.00	31.22	AV	H	13.98	45.20	54	-8.80
11000.00	45.54	PK	V	13.98	59.52	74	-14.48
11000.00	31.39	AV	V	13.98	45.37	54	-8.63
<b>5580MHz</b>							
11160.00	45.72	PK	H	13.62	59.34	74	-14.66
11160.00	31.64	AV	H	13.62	45.26	54	-8.74
11160.00	45.96	PK	V	13.62	59.58	74	-14.42
11160.00	31.81	AV	V	13.62	45.43	54	-8.57
<b>5700MHz</b>							
5727.26	59.37	PK	H	3.49	62.86	68.20	-5.34
5728.75	60.06	PK	V	3.50	63.56	68.20	-4.64
11400.00	46.26	PK	H	14.08	60.34	74	-13.66
11400.00	32.05	AV	H	14.08	46.13	54	-7.87
11400.00	46.47	PK	V	14.08	60.55	74	-13.45
11400.00	32.18	AV	V	14.08	46.26	54	-7.74
<b>5720MHz</b>							
11440.00	45.51	PK	H	14.08	59.59	74	-14.41
11440.00	31.87	AV	H	14.08	45.95	54	-8.05
11440.00	45.69	PK	V	14.08	59.77	74	-14.23
11440.00	31.98	AV	V	14.08	46.06	54	-7.94

Frequency (MHz)	Receiver		Polar (H/V)	Factor (dB/m)	Corrected Amplitude (dBµV/m)	Limit (dBµV/m)	Margin (dB)
	Reading (dBµV)	PK/Ave					
<b>802.11ac20</b>							
<b>5500MHz</b>							
5460.00	52.87	PK	H	3.05	55.92	74.00	-18.08
5460.00	41.78	AV	H	3.05	44.83	54.00	-9.17
5467.58	61.93	PK	H	3.06	64.99	68.20	-3.21
5460.00	53.62	PK	V	3.05	56.67	74.00	-17.33
5460.00	41.63	AV	V	3.05	44.68	54.00	-9.32
5468.42	61.51	PK	V	3.05	64.56	68.20	-3.64
11000.00	45.43	PK	H	13.98	59.41	74	-14.59
11000.00	31.34	AV	H	13.98	45.32	54	-8.68
11000.00	45.62	PK	V	13.98	59.60	74	-14.40
11000.00	31.51	AV	V	13.98	45.49	54	-8.51
<b>5580MHz</b>							
11160.00	45.78	PK	H	13.62	59.40	74	-14.60
11160.00	31.69	AV	H	13.62	45.31	54	-8.69
11160.00	46.01	PK	V	13.62	59.63	74	-14.37
11160.00	31.87	AV	V	13.62	45.49	54	-8.51
<b>5700MHz</b>							
5727.37	60.89	PK	H	3.49	64.38	68.20	-3.82
5725.00	61.41	PK	V	3.48	64.89	68.20	-3.31
11400.00	46.14	PK	H	14.08	60.22	74	-13.78
11400.00	32.07	AV	H	14.08	46.15	54	-7.85
11400.00	46.35	PK	V	14.08	60.43	74	-13.57
11400.00	32.22	AV	V	14.08	46.30	54	-7.70
<b>5720MHz</b>							
11440.00	45.36	PK	H	14.08	59.44	74	-14.56
11440.00	31.74	AV	H	14.08	45.82	54	-8.18
11440.00	45.57	PK	V	14.08	59.65	74	-14.35
11440.00	31.88	AV	V	14.08	45.96	54	-8.04

Frequency (MHz)	Receiver		Polar (H/V)	Factor (dB/m)	Corrected Amplitude (dBµV/m)	Limit (dBµV/m)	Margin (dB)
	Reading (dBµV)	PK/Ave					
<b>802.11ac40</b>							
<b>5510MHz</b>							
5460.00	57.41	PK	H	3.05	60.46	74.00	-13.54
5460.00	42.37	AV	H	3.05	45.42	54.00	-8.58
5465.91	61.87	PK	H	3.06	64.93	68.20	-3.27
5460.00	61.55	PK	V	3.05	64.60	74.00	-9.40
5460.00	41.76	AV	V	3.05	44.81	54.00	-9.19
5465.07	61.54	PK	V	3.06	64.60	68.20	-3.60
11020.00	44.78	PK	H	13.89	58.67	74	-15.33
11020.00	31.62	AV	H	13.89	45.51	54	-8.49
11020.00	45.03	PK	V	13.89	58.92	74	-15.08
11020.00	31.89	AV	V	13.89	45.78	54	-8.22
<b>5550MHz</b>							
11100.00	45.12	PK	H	13.53	58.65	74	-15.35
11100.00	32.05	AV	H	13.53	45.58	54	-8.42
11100.00	45.36	PK	V	13.53	58.89	74	-15.11
11100.00	32.23	AV	V	13.53	45.76	54	-8.24
<b>5670MHz</b>							
5726.96	55.94	PK	H	3.49	59.43	68.20	-8.77
5727.22	56.69	PK	V	3.49	60.18	68.20	-8.02
11340.00	45.54	PK	H	13.99	59.53	74	-14.47
11340.00	32.47	AV	H	13.99	46.46	54	-7.54
11340.00	45.76	PK	V	13.99	59.75	74	-14.25
11340.00	32.65	AV	V	13.99	46.64	54	-7.36
<b>5710MHz</b>							
11420.00	45.38	PK	H	14.08	59.46	74	-14.54
11420.00	32.21	AV	H	14.08	46.29	54	-7.71
11420.00	45.54	PK	V	14.08	59.62	74	-14.38
11420.00	32.42	AV	V	14.08	46.50	54	-7.50

Frequency (MHz)	Receiver		Polar (H/V)	Factor (dB/m)	Corrected Amplitude (dBµV/m)	Limit (dBµV/m)	Margin (dB)
	Reading (dBµV)	PK/Ave					
<b>802.11ac80</b>							
<b>5530MHz</b>							
5460.00	56.84	PK	H	3.05	59.89	74.00	-14.11
5460.00	41.7	AV	H	3.05	44.75	54.00	-9.25
5467.95	61.7	PK	H	3.06	64.76	68.20	-3.44
5460.00	55.66	PK	V	3.05	58.71	74.00	-15.29
5460.00	59.26	AV	V	3.05	62.31	54.00	8.31
5464.59	60.86	PK	V	3.06	63.92	68.20	-4.28
5740.54	55.51	PK	H	3.51	59.02	68.20	-9.18
5729.43	56.27	PK	V	3.50	59.77	68.20	-8.43
11060.00	45.02	PK	H	13.71	58.73	74	-15.27
11060.00	32.58	AV	H	13.71	46.29	54	-7.71
11060.00	45.24	PK	V	13.71	58.95	74	-15.05
11060.00	32.87	AV	V	13.71	46.58	54	-7.42
<b>5690MHz</b>							
11380.00	45.64	PK	H	13.99	59.63	74	-14.37
11380.00	33.23	AV	H	13.99	47.22	54	-6.78
11380.00	45.42	PK	V	13.99	59.41	74	-14.59
11380.00	33.09	AV	V	13.99	47.08	54	-6.92

**5725-5850 MHz:**

Frequency (MHz)	Receiver		Polar (H/V)	Factor (dB/m)	Corrected Amplitude (dBµV/m)	Limit (dBµV/m)	Margin (dB)
	Reading (dBµV)	PK/Ave					
<b>802.11a</b>							
<b>5745MHz</b>							
5631.82	55.42	PK	H	3.12	58.54	68.20	-9.66
5699.34	57.43	PK	H	3.45	60.88	104.71	-43.83
5719.96	69.45	PK	H	3.48	72.93	110.79	-37.86
5723.17	74.13	PK	H	3.48	77.61	118.03	-40.42
5636.72	55.75	PK	V	3.17	58.92	68.20	-9.28
5696.88	56.88	PK	V	3.44	60.32	102.90	-42.58
5719.96	70.34	PK	V	3.48	73.82	110.79	-36.97
5723.11	74.19	PK	V	3.48	77.67	117.90	-40.23
11490.00	44.67	PK	H	14.31	58.98	74	-15.02
11490.00	31.04	AV	H	14.31	45.35	54	-8.65
11490.00	44.95	PK	V	14.31	59.26	74	-14.74
11490.00	31.21	AV	V	14.31	45.52	54	-8.48
<b>5785MHz</b>							
11570.00	45.08	PK	H	14.05	59.13	74	-14.87
11570.00	31.45	AV	H	14.05	45.50	54	-8.50
11570.00	45.37	PK	V	14.05	59.42	74	-14.58
11570.00	31.69	AV	V	14.05	45.74	54	-8.26
<b>5825MHz</b>							
5851.30	60.70	PK	H	3.68	64.38	119.24	-54.86
5856.10	59.07	PK	H	3.7	62.77	110.49	-47.72
5875.18	56.65	PK	H	3.77	60.42	105.07	-44.65
5928.66	54.46	PK	H	3.78	58.24	68.2	-9.96
5851.28	62.39	PK	V	3.68	66.07	119.28	-53.21
5856.48	59.58	PK	V	3.71	63.29	110.38	-47.09
5881.46	56.13	PK	V	3.79	59.92	100.4	-40.48
5928.92	54.63	PK	V	3.78	58.41	68.2	-9.79
11650.00	45.46	PK	H	13.83	59.29	74	-14.71
11650.00	31.92	AV	H	13.83	45.75	54	-8.25
11650.00	45.73	PK	V	13.83	59.56	74	-14.44
11650.00	32.09	AV	V	13.83	45.92	54	-8.08

Frequency (MHz)	Receiver		Polar (H/V)	Factor (dB/m)	Corrected Amplitude (dBµV/m)	Limit (dBµV/m)	Margin (dB)
	Reading (dBµV)	PK/Ave					
<b>802.11ac20</b>							
<b>5745MHz</b>							
5641.62	55.40	PK	H	3.20	58.60	68.20	-9.60
5692.66	59.07	PK	H	3.42	62.49	99.79	-37.30
5719.43	66.25	PK	H	3.48	69.73	110.64	-40.91
5723.79	71.98	PK	H	3.48	75.46	119.45	-43.99
5626.70	55.43	PK	V	3.09	58.52	68.20	-9.68
5699.32	61.39	PK	V	3.45	64.84	104.70	-39.86
5714.18	66.53	PK	V	3.47	70.00	109.17	-39.17
5723.54	74.45	PK	V	3.48	77.93	118.87	-40.94
11490.00	44.51	PK	H	14.31	58.82	74	-15.18
11490.00	31.05	AV	H	14.31	45.36	54	-8.64
11490.00	44.78	PK	V	14.31	59.09	74	-14.91
11490.00	31.19	AV	V	14.31	45.50	54	-8.50
<b>5785MHz</b>							
11570.00	44.84	PK	H	14.05	58.89	74	-15.11
11570.00	31.52	AV	H	14.05	45.57	54	-8.43
11570.00	45.07	PK	V	14.05	59.12	74	-14.88
11570.00	31.76	AV	V	14.05	45.81	54	-8.19
<b>5825MHz</b>							
5850.90	64.33	PK	H	3.67	68	120.15	-52.15
5856.02	59.95	PK	H	3.7	63.65	110.51	-46.86
5908.60	55.71	PK	H	3.83	59.54	80.3	-20.76
5940.22	54.96	PK	H	3.76	58.72	68.2	-9.48
5850.34	65.55	PK	V	3.67	69.22	121.42	-52.2
5855.10	61.90	PK	V	3.7	65.6	110.77	-45.17
5880.04	55.83	PK	V	3.78	59.61	101.46	-41.85
5938.44	55.07	PK	V	3.76	58.83	68.2	-9.37
11650.00	45.28	PK	H	13.83	59.11	74	-14.89
11650.00	31.96	AV	H	13.83	45.79	54	-8.21
11650.00	45.54	PK	V	13.83	59.37	74	-14.63
11650.00	32.17	AV	V	13.83	46.00	54	-8.00

Frequency (MHz)	Receiver		Polar (H/V)	Factor (dB/m)	Corrected Amplitude (dBµV/m)	Limit (dBµV/m)	Margin (dB)
	Reading (dBµV)	PK/Ave					
<b>802.11ac 40</b>							
<b>5755MHz</b>							
5623.72	55.54	PK	H	3.07	58.61	68.20	-9.59
5698.60	63.30	PK	H	3.44	66.74	104.17	-37.43
5715.67	70.12	PK	H	3.47	73.59	109.59	-36.00
5723.79	72.92	PK	H	3.48	76.40	119.43	-43.03
5638.49	55.37	PK	V	3.19	58.56	68.20	-9.64
5698.50	62.31	PK	V	3.44	65.75	104.09	-38.34
5719.11	70.69	PK	V	3.48	74.17	110.55	-36.38
5724.02	73.15	PK	V	3.48	76.63	119.96	-43.33
11510.00	44.64	PK	H	14.29	58.93	74	-15.07
11510.00	31.96	AV	H	14.29	46.25	54	-7.75
11510.00	44.87	PK	V	14.29	59.16	74	-14.84
11510.00	32.15	AV	V	14.29	46.44	54	-7.56
<b>5795MHz</b>							
5851.28	58.43	PK	H	3.68	62.11	119.27	-57.16
5855.70	57.50	PK	H	3.7	61.2	110.6	-49.4
5880.61	56.11	PK	H	3.78	59.89	101.04	-41.15
5929.28	54.51	PK	H	3.78	58.29	68.2	-9.91
5851.26	59.62	PK	V	3.68	63.3	119.33	-56.03
5861.01	58.62	PK	V	3.71	62.33	109.12	-46.79
5878.00	56.48	PK	V	3.77	60.25	102.97	-42.72
5926.75	54.92	PK	V	3.79	58.71	68.2	-9.49
11590.00	45.45	PK	H	13.97	59.42	74	-14.58
11590.00	32.32	AV	H	13.97	46.29	54	-7.71
11590.00	45.84	PK	V	13.97	59.81	74	-14.19
11590.00	32.56	AV	V	13.97	46.53	54	-7.47



Frequency (MHz)	Receiver		Polar (H/V)	Factor (dB/m)	Corrected Amplitude (dBµV/m)	Limit (dBµV/m)	Margin (dB)
	Reading (dBµV)	PK/Ave					
<b>802.11ac80</b>							
<b>5775MHz</b>							
5644.36	59.80	PK	H	3.22	63.02	68.20	-5.18
5689.14	69.68	PK	H	3.41	73.09	97.19	-24.10
5710.43	71.12	PK	H	3.46	74.58	108.12	-33.54
5721.22	71.69	PK	H	3.48	75.17	113.58	-38.41
5648.30	58.06	PK	V	3.26	61.32	68.20	-6.88
5695.23	69.21	PK	V	3.43	72.64	101.69	-29.05
5719.83	71.33	PK	V	3.48	74.81	110.75	-35.94
5725.00	74.55	PK	V	3.48	78.03	122.20	-44.17
5852.22	68.24	PK	H	3.69	71.93	117.14	-45.21
5861.05	65.95	PK	H	3.71	69.66	109.11	-39.45
5876.34	59.39	PK	H	3.78	63.17	104.2	-41.03
5948.42	55.32	PK	H	3.74	59.06	68.2	-9.14
5850.01	66.78	PK	V	3.67	70.45	122.19	-51.74
5860.79	67.12	PK	V	3.71	70.83	109.18	-38.35
5877.55	59.38	PK	V	3.77	63.15	103.31	-40.16
5933.32	56.28	PK	V	3.77	60.05	68.2	-8.15
11550.00	45.39	PK	H	14.13	59.52	74	-14.48
11550.00	33.17	AV	H	14.13	47.30	54	-6.70
11550.00	45.68	PK	V	14.13	59.81	74	-14.19
11550.00	33.45	AV	V	14.13	47.58	54	-6.42

**Note:**

Factor = Antenna factor (RX) + Cable Loss – Amplifier Factor

Corrected Amplitude = Factor + Reading

Margin = Corrected. Amplitude - Limit

The other spurious emission which is in the noise floor level was not recorded.

**Test plots for Band Edge Measurements (Radiated)**

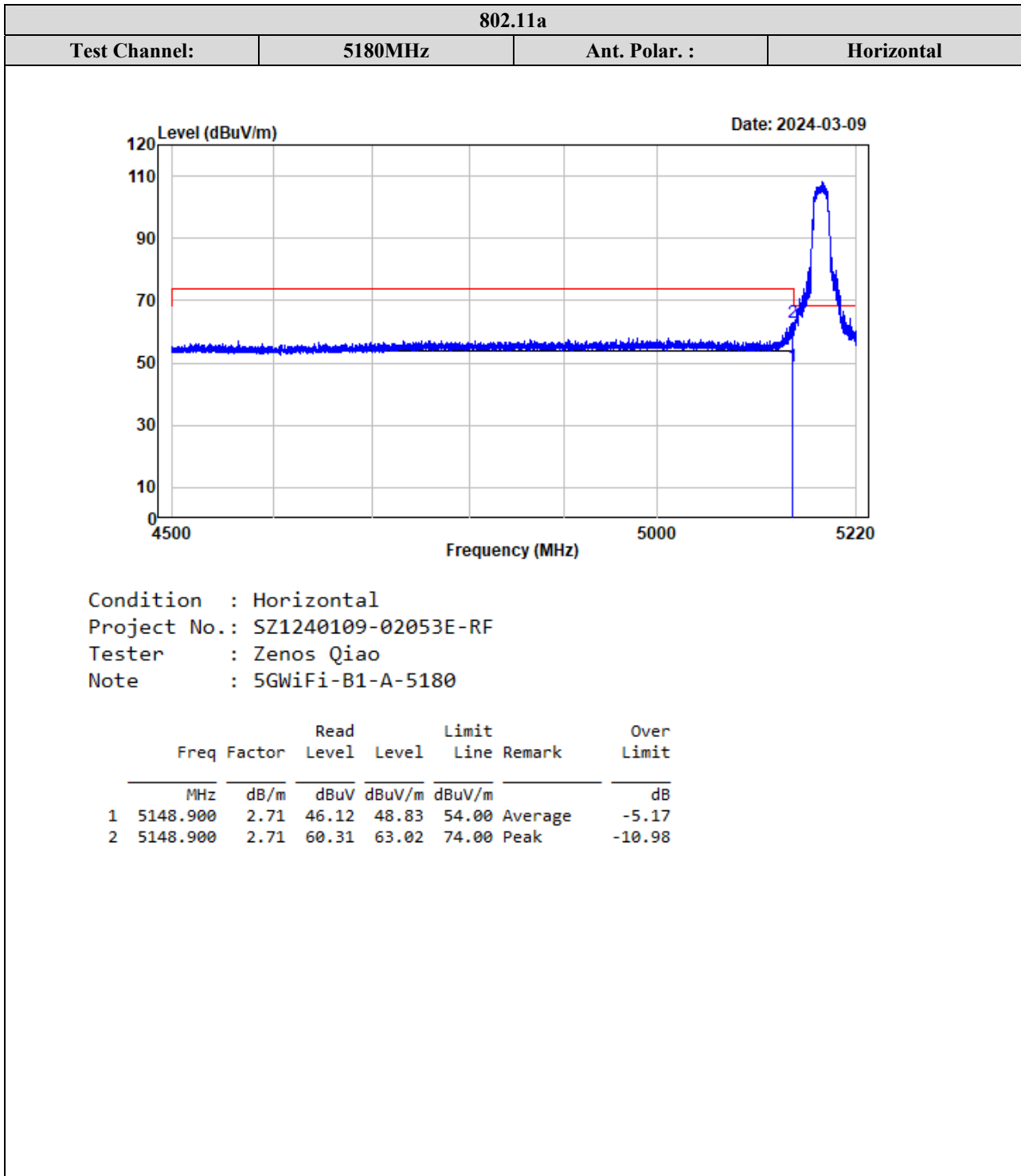

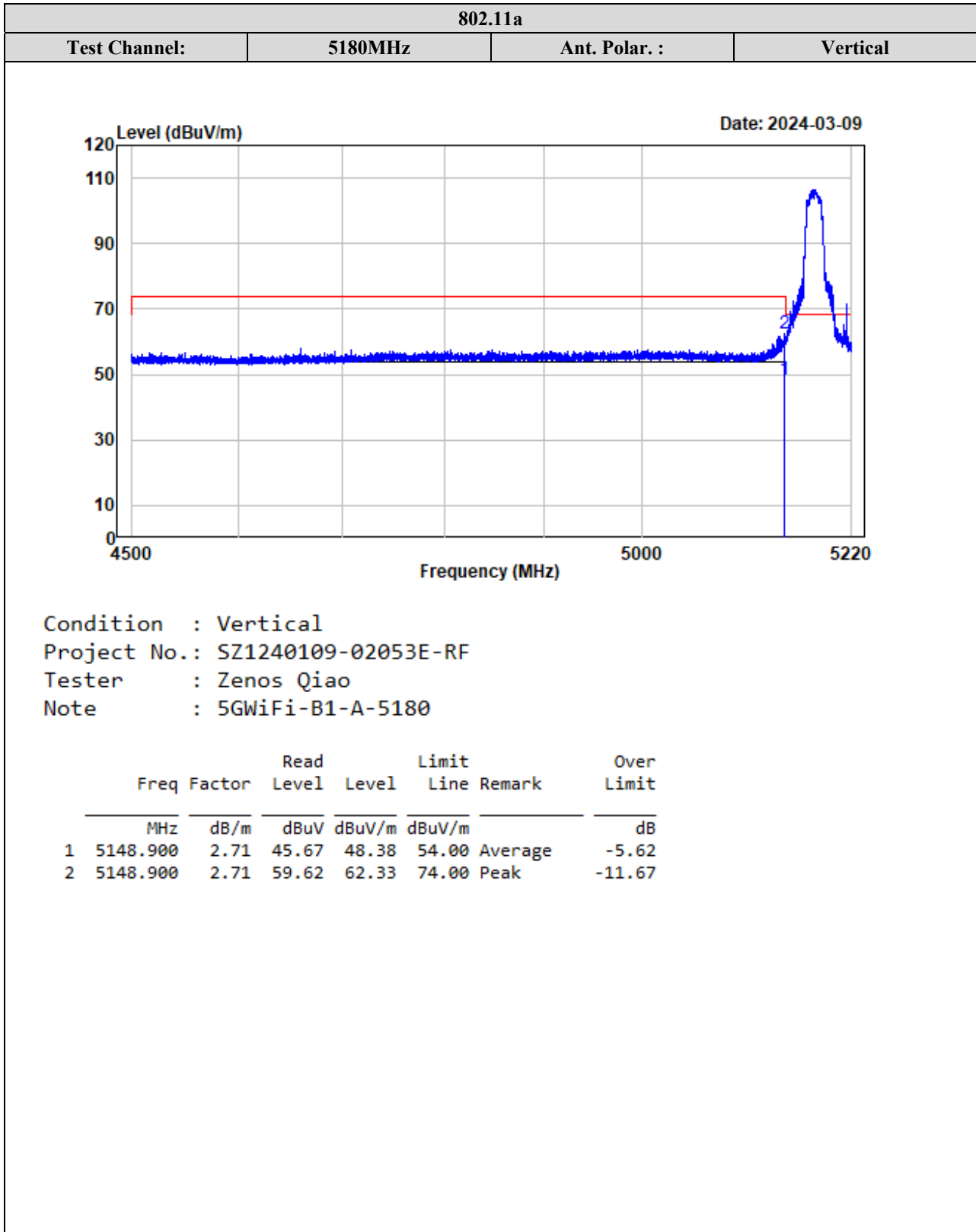

Listed with the worst harmonic margin test plot (802.11ac80, 5775MHz)

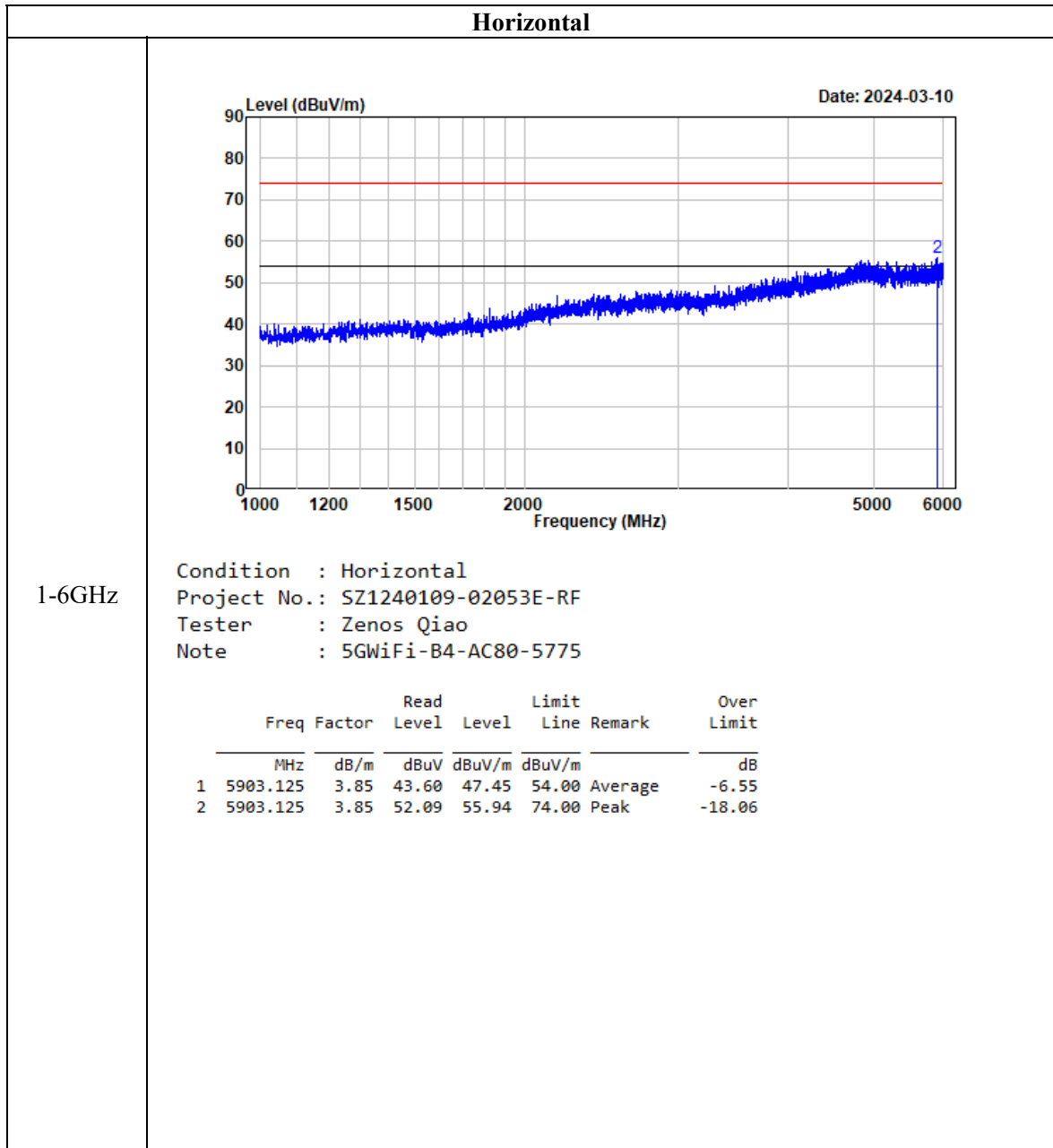

**Vertical**

1-6GHz

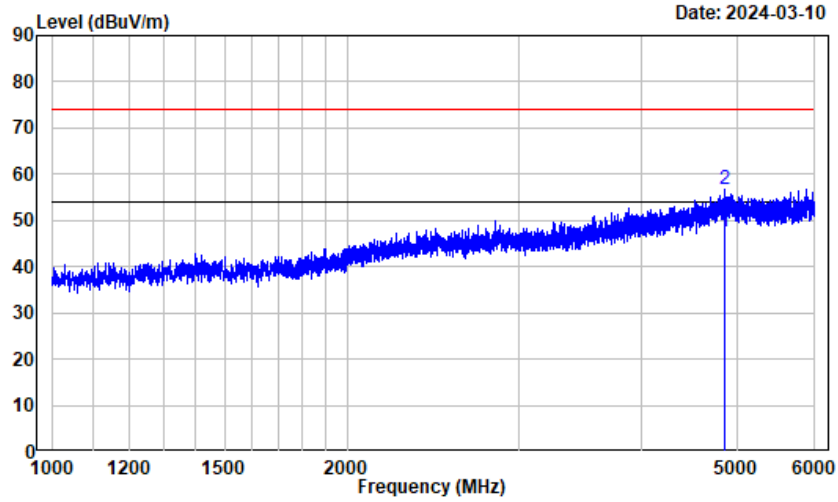

Condition : Vertical  
 Project No.: SZ1240109-02053E-RF  
 Tester : Zenos Qiao  
 Note : 5GWiFi-B4-AC80-5775

	Freq	Factor	Read Level	Level	Limit	Remark	Over Limit
	MHz	dB/m	dBuV	dBuV/m	dBuV/m		dB
1	4861.250	2.51	45.15	47.66	54.00	Average	-6.34
2	4861.250	2.51	54.13	56.64	74.00	Peak	-17.36

**Horizontal**

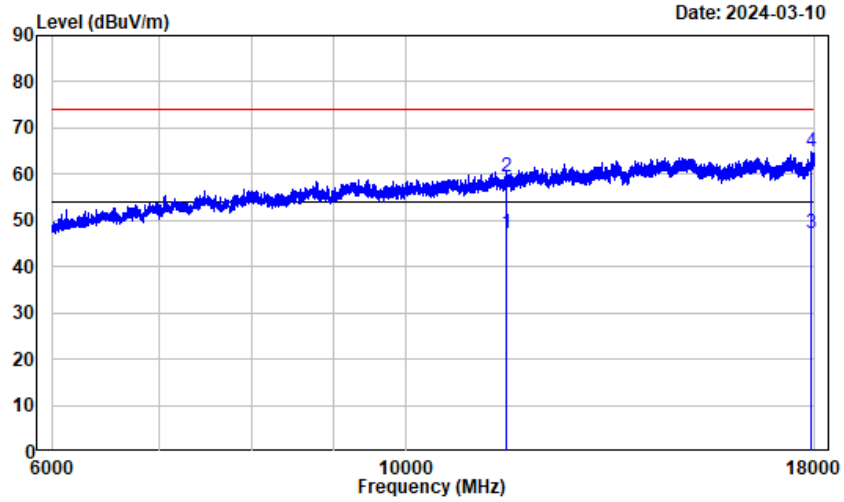

6-18GHz

Condition : Horizontal  
 Project No.: SZ1240109-02053E-RF  
 Tester : Zenos Qiao  
 Note : 5GWiFi-B4-AC80-5775

	Read	Limit	Over				
Freq	Factor	Level	Level	Line			
MHz	dB/m	dBuV	dBuV/m	dBuV/m			
1	11550.000	14.13	33.17	47.30	54.00	-6.70	Average
2	11550.000	14.13	45.39	59.52	74.00	-14.48	Peak
3	17905.500	23.95	23.11	47.06	54.00	-6.94	Average
4	17905.500	23.95	40.76	64.71	74.00	-9.29	Peak

Vertical

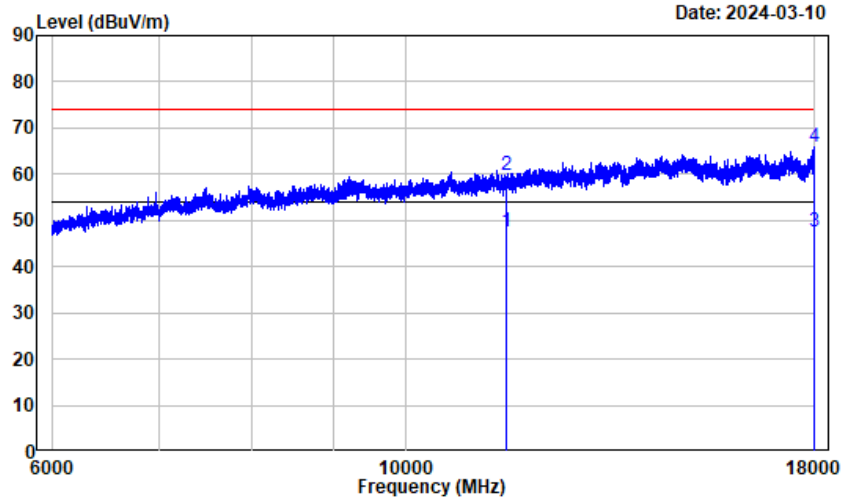

6-18GHz

Condition : Vertical  
 Project No.: SZ1240109-02053E-RF  
 Tester : Zenos Qiao  
 Note : 5GWiFi-B4-AC80-5775

	Read	Limit	Over				
Freq	Factor	Level	Level	Line			
MHz	dB/m	dBuV	dBuV/m	dBuV/m			
1	11550.000	14.13	33.45	47.58	54.00	-6.42	Average
2	11550.000	14.13	45.68	59.81	74.00	-14.19	Peak
3	17998.500	24.61	22.89	47.50	54.00	-6.50	Average
4	17998.500	24.61	41.42	66.03	74.00	-7.97	Peak

**Horizontal**

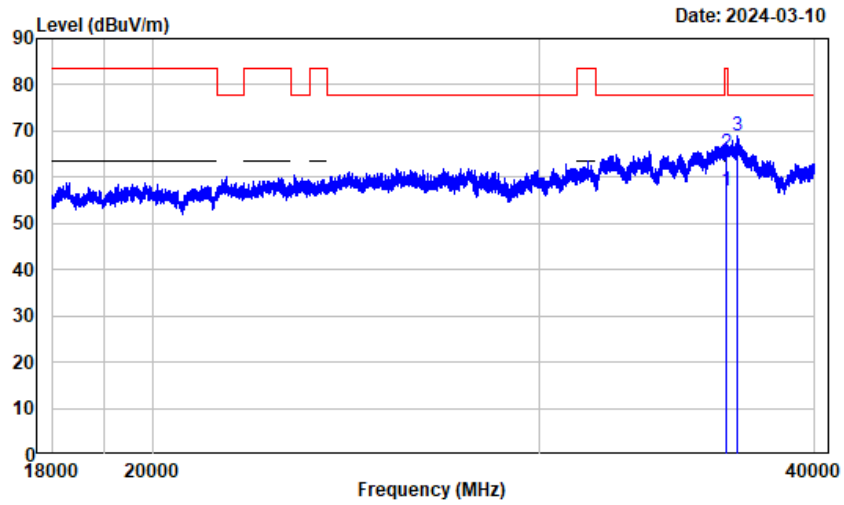

18-40GHz

Condition : Horizontal  
 Project No.: SZ1240109-02053E-RF  
 Tester : Zenos Qiao  
 Note : 5GWiFi-B4-AC80-5775

	Read	Limit	Over				
Freq	Factor	Level	Level	Line			
MHz	dB/m	dBuV	dBuV/m	dBuV/m			
1	36441.500	25.20	31.74	56.94	63.50	-6.56	Average
2	36441.500	25.20	39.96	65.16	83.50	-18.34	Peak
3	36884.250	25.01	43.86	68.87	77.70	-8.83	Peak



Vertical

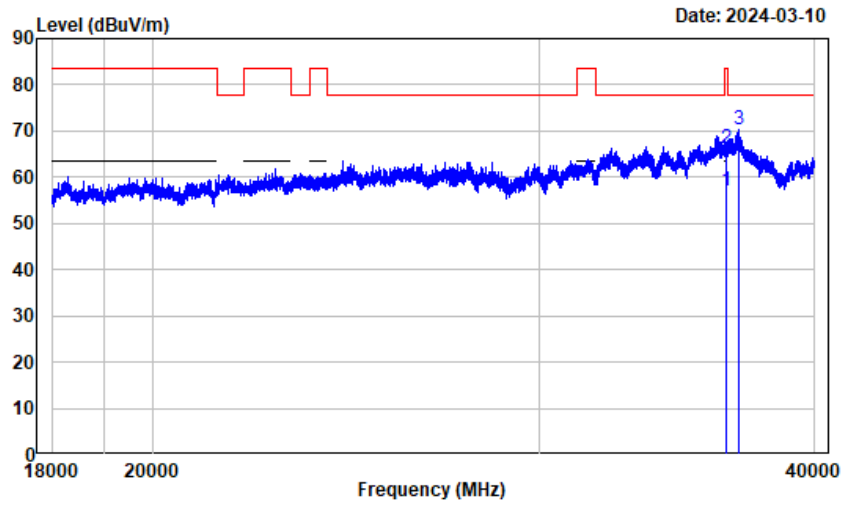

18-40GHz

Condition : Vertical  
 Project No.: SZ1240109-02053E-RF  
 Tester : Zenos Qiao  
 Note : 5GWiFi-B4-AC80-5775

	Read	Limit	Over				
Freq	Factor	Level	Level	Line			
MHz	dB/m	dBuV	dBuV/m	dBuV/m			
1	36491.000	25.36	31.63	56.99	63.50	-6.51	Average
2	36491.000	25.36	40.97	66.33	83.50	-17.17	Peak
3	36958.500	24.94	45.37	70.31	77.70	-7.39	Peak

## **FCC §15.407(a), (e) – 26 dB & 6dB EMISSION BANDWIDTH**

### **Applicable Standard**

The maximum power spectral density is measured as a conducted emission by direct connection of a calibrated test instrument to the equipment under test. If the device cannot be connected directly, alternative techniques acceptable to the Commission may be used. Measurements in the 5.725-5.85 GHz band are made over a reference bandwidth of 500 kHz or the 26 dB emission bandwidth of the device, whichever is less. Measurements in the 5.15-5.25 GHz, 5.25-5.35 GHz, and the 5.47-5.725 GHz bands are made over a bandwidth of 1 MHz or the 26 dB emission bandwidth of the device, whichever is less. A narrower resolution bandwidth can be used, provided that the measured power is integrated over the full reference bandwidth.

Within the 5.725-5.85 GHz band, the minimum 6 dB bandwidth of U-NII devices shall be at least 500 kHz.

### **Test Procedure**

According to KDB789033 D02 section II.C and section II.D

#### **1. Emission Bandwidth (EBW)**

- a) Set RBW = approximately 1% of the emission bandwidth.
- b) Set the VBW > RBW.
- c) Detector = Peak.
- d) Trace mode = max hold.
- e) Measure the maximum width of the emission that is 26 dB down from the maximum of the emission. Compare this with the RBW setting of the analyzer. Readjust RBW and repeat measurement as needed until the RBW/EBW ratio is approximately 1%.

#### **2. Minimum Emission Bandwidth for the band 5.725-5.85 GHz**

Section 15.407(e) specifies the minimum 6 dB emission bandwidth of at least 500 KHz for the band 5.725-5.85 GHz. The following procedure shall be used for measuring this bandwidth:

- a) Set RBW = 100 kHz.
- b) Set the video bandwidth (VBW)  $\geq 3 \times$  RBW.
- c) Detector = Peak.
- d) Trace mode = max hold.
- e) Sweep = auto couple.
- f) Allow the trace to stabilize.
- g) Measure the maximum width of the emission that is constrained by the frequencies associated with the two outermost amplitude points (upper and lower frequencies) that are attenuated by 6 dB relative to the maximum level measured in the fundamental emission.

#### **3. 99% Occupied Bandwidth:**

According to ANSI C63.10-2013 Section 12.4.2&6.9.3

The occupied bandwidth is the frequency bandwidth such that, below its lower and above its upper frequency limits, the mean powers are each equal to 0.5% of the total mean power of the given emission. The following procedure shall be used for measuring 99% power bandwidth:

- a) The instrument center frequency is set to the nominal EUT channel center frequency. The frequency span for the spectrum analyzer shall be between 1.5 times and 5.0 times the OBW.
- b) The nominal IF filter bandwidth (3 dB RBW) shall be in the range of 1% to 5% of the OBW, and VBW shall be approximately three times the RBW, unless otherwise specified by the applicable requirement.

- c) Set the reference level of the instrument as required, keeping the signal from exceeding the maximum input mixer level for linear operation. In general, the peak of the spectral envelope shall be more than  $[10 \log (OBW/RBW)]$  below the reference level. Specific guidance is given in 4.1.5.2.
- d) Step a) through step c) might require iteration to adjust within the specified range.
- e) Video averaging is not permitted. Where practical, a sample detection and single sweep mode shall be used. Otherwise, peak detection and max hold mode (until the trace stabilizes) shall be used.
- f) Use the 99% power bandwidth function of the instrument (if available) and report the measured bandwidth.
- g) If the instrument does not have a 99% power bandwidth function, then the trace data points are recovered and directly summed in linear power terms. The recovered amplitude data points, beginning at the lowest frequency, are placed in a running sum until 0.5% of the total is reached; that frequency is recorded as the lower frequency. The process is repeated until 99.5% of the total is reached; that frequency is recorded as the upper frequency. The 99% power bandwidth is the difference between these two frequencies.
- h) The occupied bandwidth shall be reported by providing plot(s) of the measuring instrument display; the plot axes and the scale units per division shall be clearly labeled. Tabular data may be reported in addition to the plot(s).

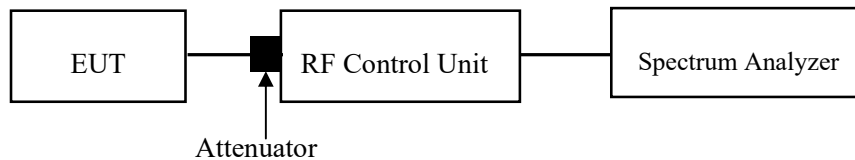

**Test Data**

**Environmental Conditions**

<b>Temperature:</b>	22~26 °C
<b>Relative Humidity:</b>	48~56 %
<b>ATM Pressure:</b>	101 kPa

*The testing was performed by Tom Tan from 2024-03-12 to 2024-04-09.*

*EUT operation mode: Transmitting*

*Test Result: Compliant. Please refer to the Appendix.*

## FCC §15.407(a) – CONDUCTED TRANSMITTER OUTPUT POWER

### Applicable Standard

For an indoor access point operating in the band 5.15-5.25 GHz, the maximum conducted output power over the frequency band of operation shall not exceed 1 W provided the maximum antenna gain does not exceed 6 dBi. In addition, the maximum power spectral density shall not exceed 17 dBm in any 1 megahertz band. If transmitting antennas of directional gain greater than 6 dBi are used, both the maximum conducted output power and the maximum power spectral density shall be reduced by the amount in dB that the directional gain of the antenna exceeds 6 dBi.

For client devices in the 5.15-5.25 GHz band, the maximum conducted output power over the frequency band of operation shall not exceed 250 mW provided the maximum antenna gain does not exceed 6 dBi. In addition, the maximum power spectral density shall not exceed 11 dBm in any 1 megahertz band. If transmitting antennas of directional gain greater than 6 dBi are used, both the maximum conducted output power and the maximum power spectral density shall be reduced by the amount in dB that the directional gain of the antenna exceeds 6 dBi.

For the 5.25-5.35 GHz and 5.47-5.725 GHz bands, the maximum conducted output power over the frequency bands of operation shall not exceed the lesser of 250 mW or  $11 \text{ dBm} + 10 \log B$ , where B is the 26 dB emission bandwidth in megahertz. In addition, the maximum power spectral density shall not exceed 11 dBm in any 1 megahertz band. If transmitting antennas of directional gain greater than 6 dBi are used, both the maximum conducted output power and the maximum power spectral density shall be reduced by the amount in dB that the directional gain of the antenna exceeds 6 dBi.

For the band 5.725-5.85 GHz, the maximum conducted output power over the frequency band of operation shall not exceed 1 W. In addition, the maximum power spectral density shall not exceed 30 dBm in any 500-kHz band. If transmitting antennas of directional gain greater than 6 dBi are used, both the maximum conducted output power and the maximum power spectral density shall be reduced by the amount in dB that the directional gain of the antenna exceeds 6 dBi. However, fixed point-to-point U-NII devices operating in this band may employ transmitting antennas with directional gain greater than 6 dBi without any corresponding reduction in transmitter conducted power. Fixed, point-to-point operations exclude the use of point-to-multipoint systems, omnidirectional applications, and multiple collocated transmitters transmitting the same information. The operator of the U-NII device, or if the equipment is professionally installed, the installer, is responsible for ensuring that systems employing high gain directional antennas are used exclusively for fixed, point-to-point operations.

### Test Procedure

According to KDB 789033 D02 General UNII Test Procedures New Rules v02r01 Method PM-G should be applied, for cross-band channels was according to KDB 789033 D02 v02r01 section III.A.3.

- a. Place the EUT on a bench and set it in transmitting mode.
- b. Remove the antenna from the EUT and then connect a low loss RF cable from the antenna port to one test equipment.

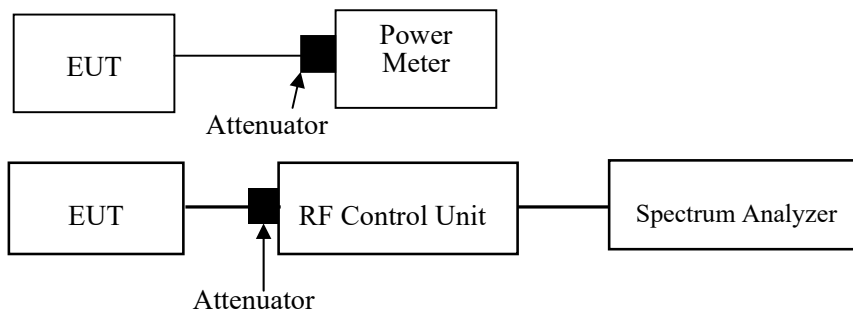

**Test Data****Environmental Conditions**

<b>Temperature:</b>	22~26 °C
<b>Relative Humidity:</b>	48~56 %
<b>ATM Pressure:</b>	101 kPa

*The testing was performed by Tom Tan from 2024-03-12 to 2024-04-09.*

*EUT operation mode: Transmitting*

*Test Result: Compliant. Please refer to the Appendix.*

## **FCC §15.407(a) - POWER SPECTRAL DENSITY**

For client devices in the 5.15-5.25 GHz band, the maximum conducted output power over the frequency band of operation shall not exceed 250 mW provided the maximum antenna gain does not exceed 6 dBi. In addition, the maximum power spectral density shall not exceed 11 dBm in any 1 megahertz band. If transmitting antennas of directional gain greater than 6 dBi are used, both the maximum conducted output power and the maximum power spectral density shall be reduced by the amount in dB that the directional gain of the antenna exceeds 6 dBi.

For the 5.25-5.35 GHz and 5.47-5.725 GHz bands, the maximum conducted output power over the frequency bands of operation shall not exceed the lesser of 250 mW or  $11 \text{ dBm} + 10 \log B$ , where B is the 26 dB emission bandwidth in megahertz. In addition, the maximum power spectral density shall not exceed 11 dBm in any 1 megahertz band. If transmitting antennas of directional gain greater than 6 dBi are used, both the maximum conducted output power and the maximum power spectral density shall be reduced by the amount in dB that the directional gain of the antenna exceeds 6 dBi.

For the band 5.725-5.85 GHz, the maximum conducted output power over the frequency band of operation shall not exceed 1 W. In addition, the maximum power spectral density shall not exceed 30 dBm in any 500-kHz band. If transmitting antennas of directional gain greater than 6 dBi are used, both the maximum conducted output power and the maximum power spectral density shall be reduced by the amount in dB that the directional gain of the antenna exceeds 6 dBi. However, fixed point-to-point U-NII devices operating in this band may employ transmitting antennas with directional gain greater than 6 dBi without any corresponding reduction in transmitter conducted power. Fixed, point-to-point operations exclude the use of point-to-multipoint systems, omnidirectional applications, and multiple collocated transmitters transmitting the same information. The operator of the U-NII device, or if the equipment is professionally installed, the installer, is responsible for ensuring that systems employing high gain directional antennas are used exclusively for fixed, point-to-point operations.

### **Test Procedure**

According to KDB 789033 D02 General UNII Test Procedures New Rules v02r01

Duty cycle  $\geq 98\%$

KDB 789033 D02 General UNII Test Procedures New Rules v02r01 Method SA-1 should be applied.

Duty cycle  $< 98\%$ , duty cycle variations are less than  $\pm 2\%$

KDB 789033 D02 General UNII Test Procedures New Rules v02r01 Method SA-2 should be applied.

Duty cycle  $< 98\%$ , duty cycle variations exceed  $\pm 2\%$

KDB 789033 D02 General UNII Test Procedures New Rules v02r01 Method SA-3 should be applied.

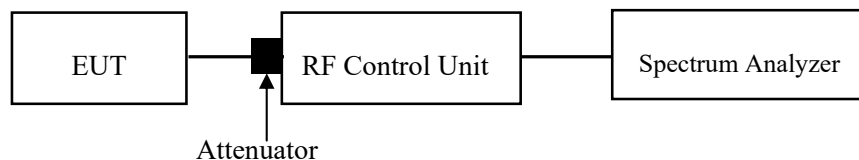

**Test Data****Environmental Conditions**

<b>Temperature:</b>	22~26 °C
<b>Relative Humidity:</b>	48~56 %
<b>ATM Pressure:</b>	101 kPa

*The testing was performed by Tom Tan from 2024-03-12 to 2024-04-09.*

*EUT operation mode: Transmitting*

*Test Result: Compliant. Please refer to the Appendix.*

## **EUT PHOTOGRAPHS**

---

Please refer to the attachment SZ1240109-02053E-RF External photo and SZ1240109-02053E-RF Internal photo.



## **TEST SETUP PHOTOGRAPHS**

---

Please refer to the attachment SZ1240109-02053E-RFB Test Setup photo.

**APPENDIX**

**Appendix A1: Emission Bandwidth  
Test Result**

Test Mode	Antenna	Channel	26db EBW [MHz]	Limit[MHz]	Verdict
11A	Ant1	5180	21.36	---	---
		5200	21.32	---	---
		5240	21.48	---	---
		5260	21.08	---	---
		5280	21.36	---	---
		5320	21.72	---	---
		5500	21.28	---	---
		5580	21.20	---	---
		5700	21.52	---	---
		5720	21.44	---	---
		5720 UNII-2C	15.76	---	---
5720 UNII-3	5.68	---	---		
11AC20SISO	Ant1	5180	21.72	---	---
		5200	21.76	---	---
		5240	21.68	---	---
		5260	21.48	---	---
		5280	21.56	---	---
		5320	21.72	---	---
		5500	21.64	---	---
		5580	21.56	---	---
		5700	22.00	---	---
		5720	21.60	---	---
		5720 UNII-2C	15.88	---	---
5720 UNII-3	5.72	---	---		
11AC40SISO	Ant1	5190	40.64	---	---
		5230	41.04	---	---
		5270	40.96	---	---
		5310	40.88	---	---
		5510	40.16	---	---
		5550	40.56	---	---
		5670	40.48	---	---
		5710	40.24	---	---
		5710 UNII-2C	35.16	---	---
5710 UNII-3	5.08	---	---		
11AC80SISO	Ant1	5210	81.92	---	---
		5290	82.08	---	---
		5530	82.08	---	---
		5690	82.56	---	---
		5690 UNII-2C	76.12	---	---
5690 UNII-3	6.44	---	---		

### Test Graphs

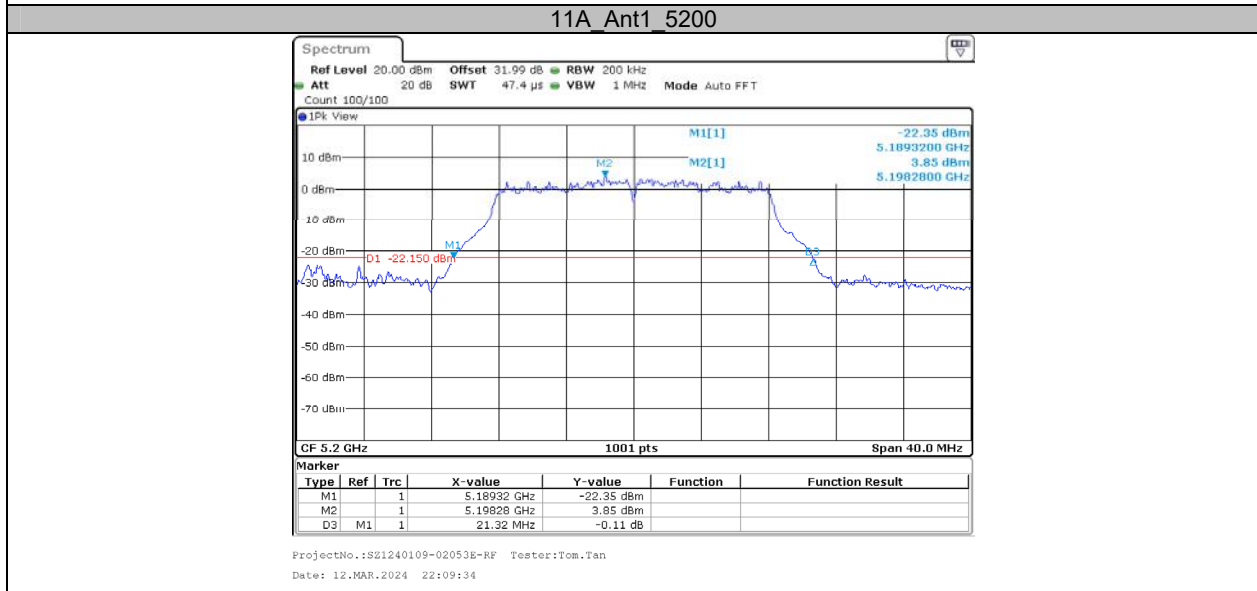
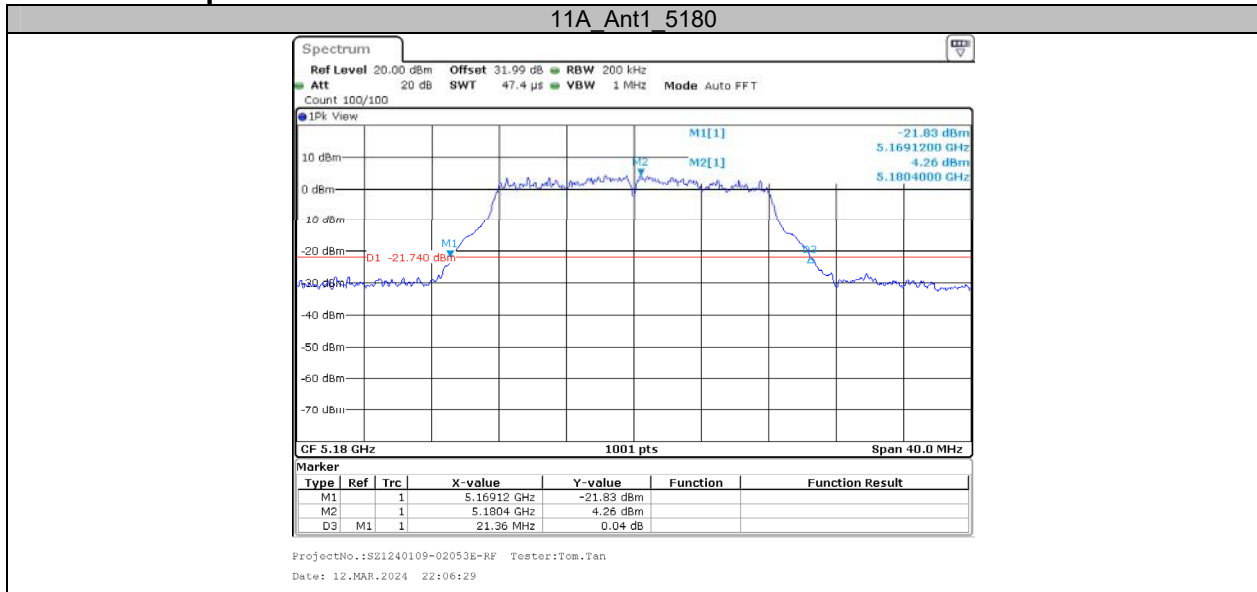

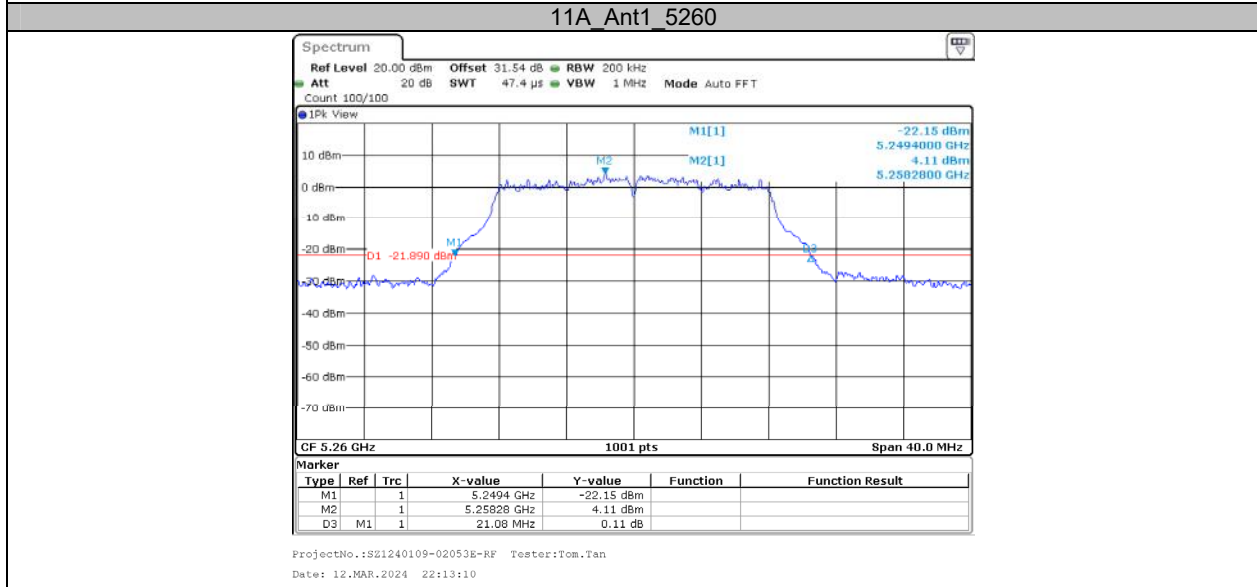
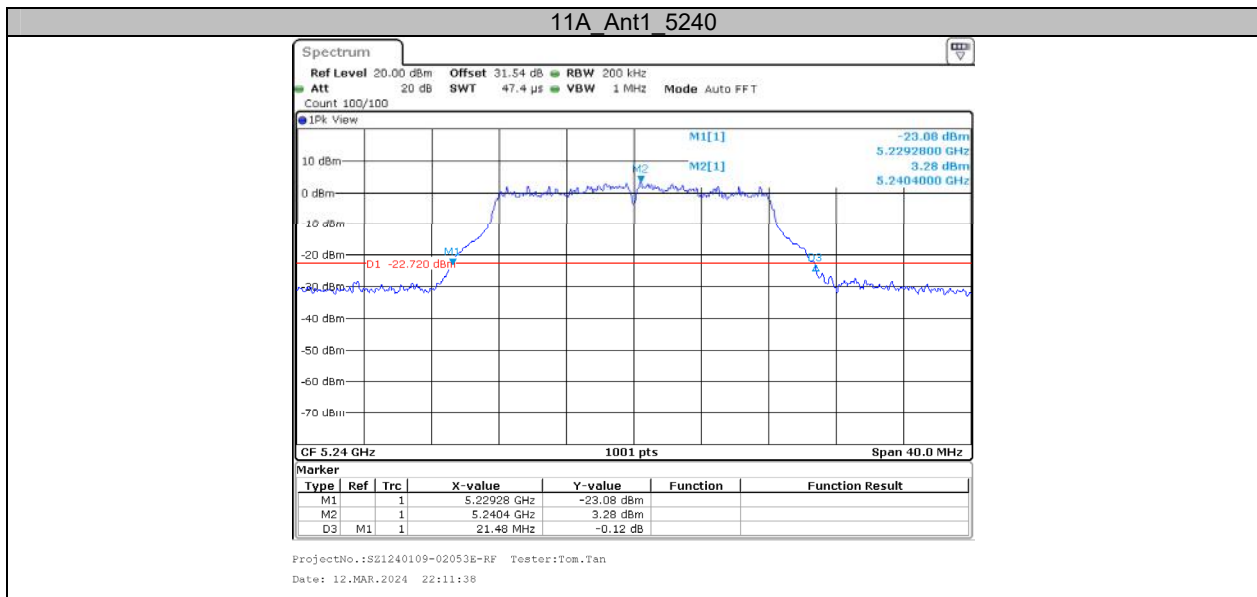

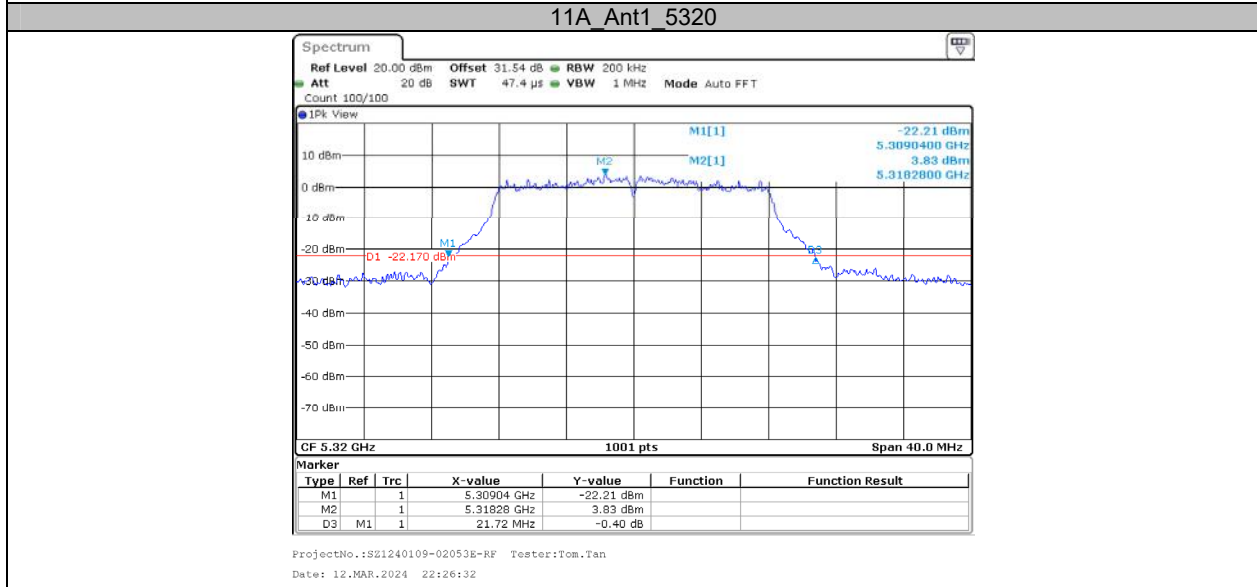
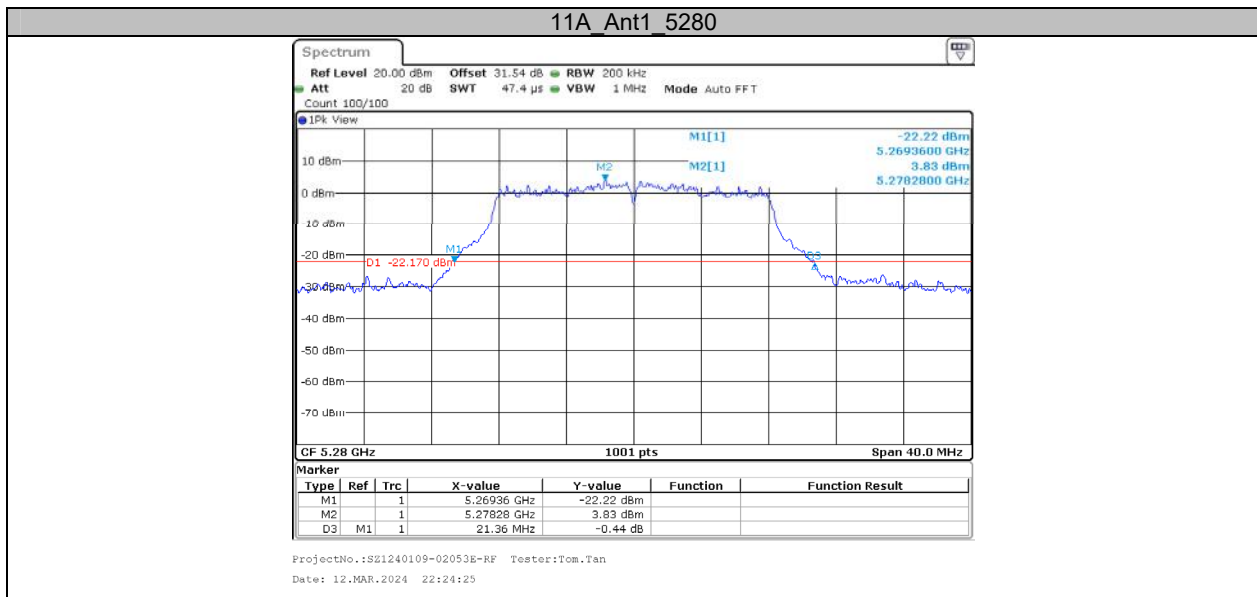

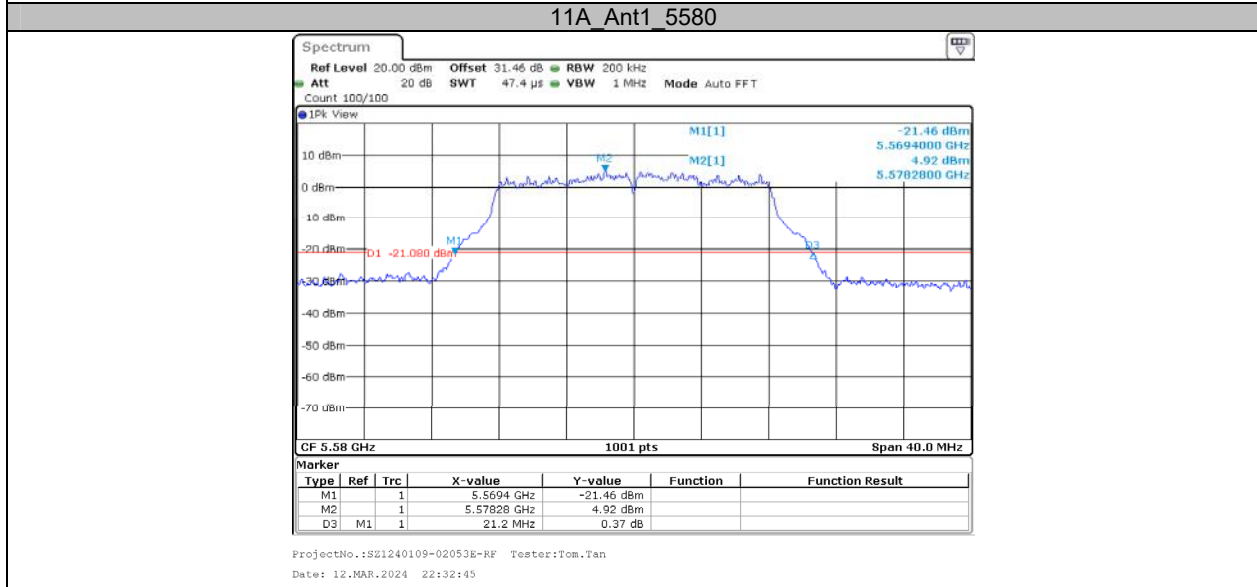
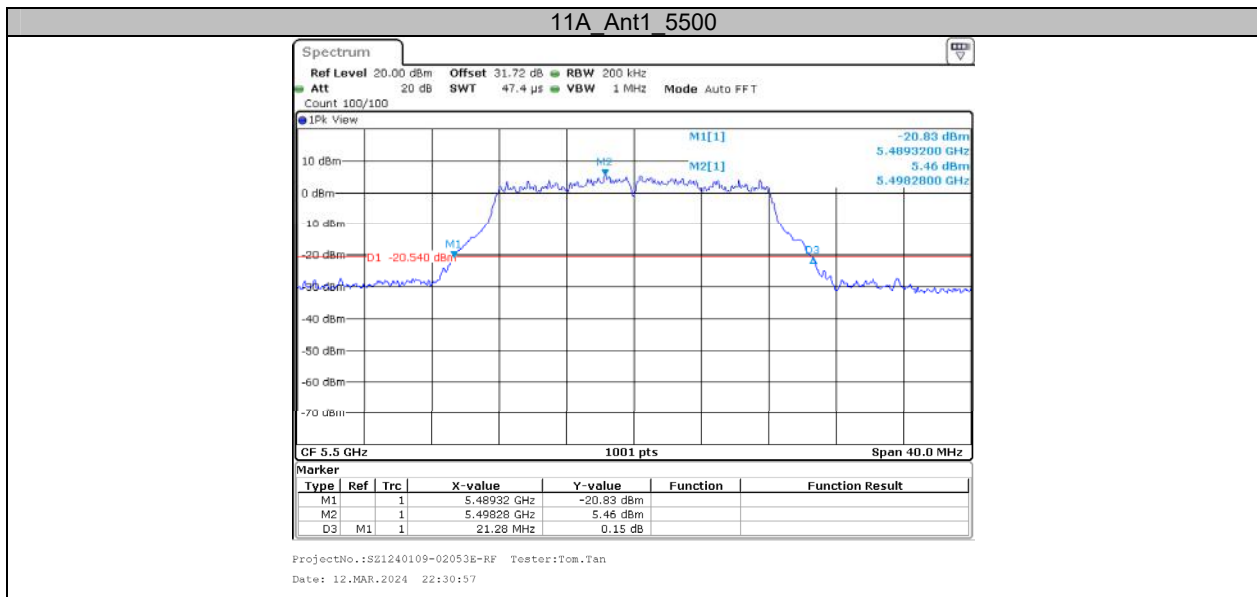

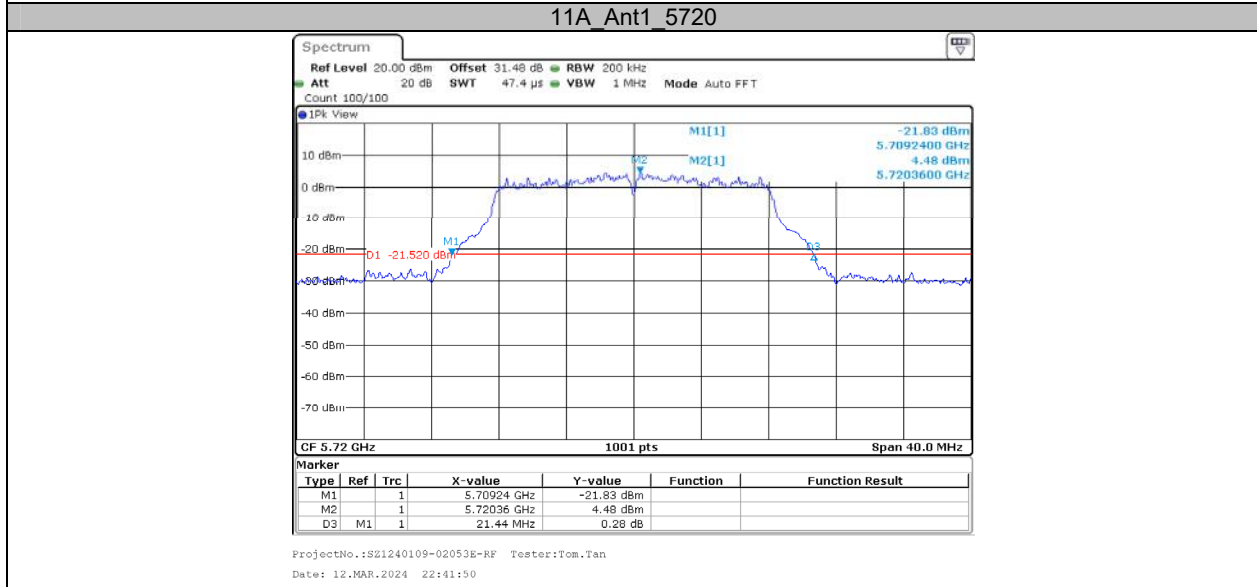
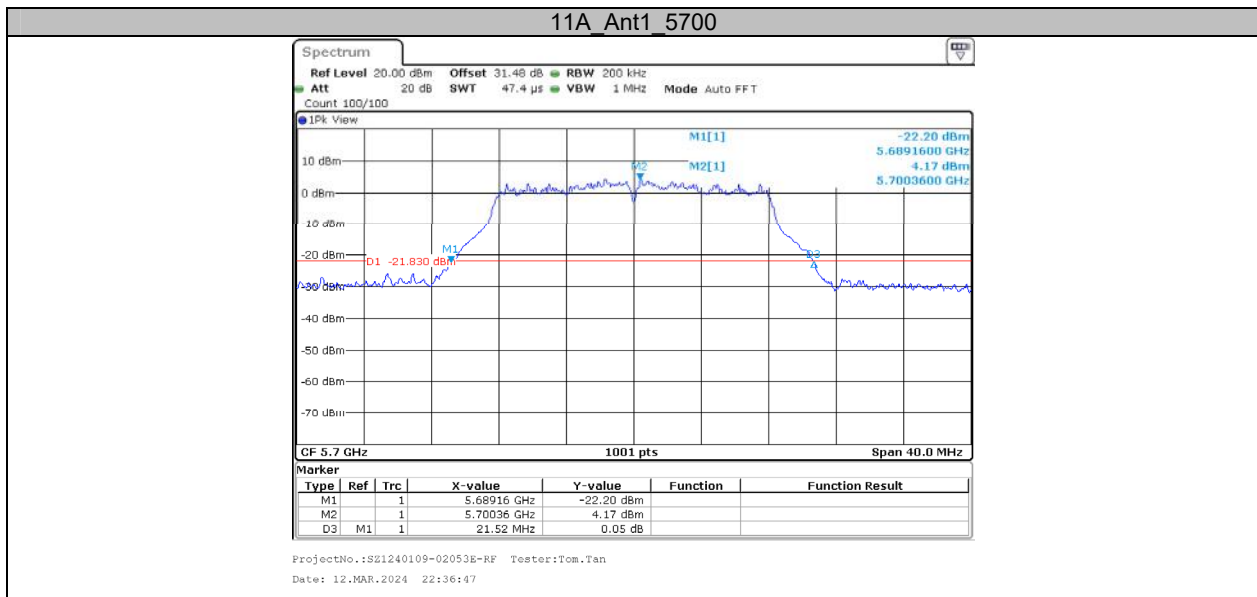

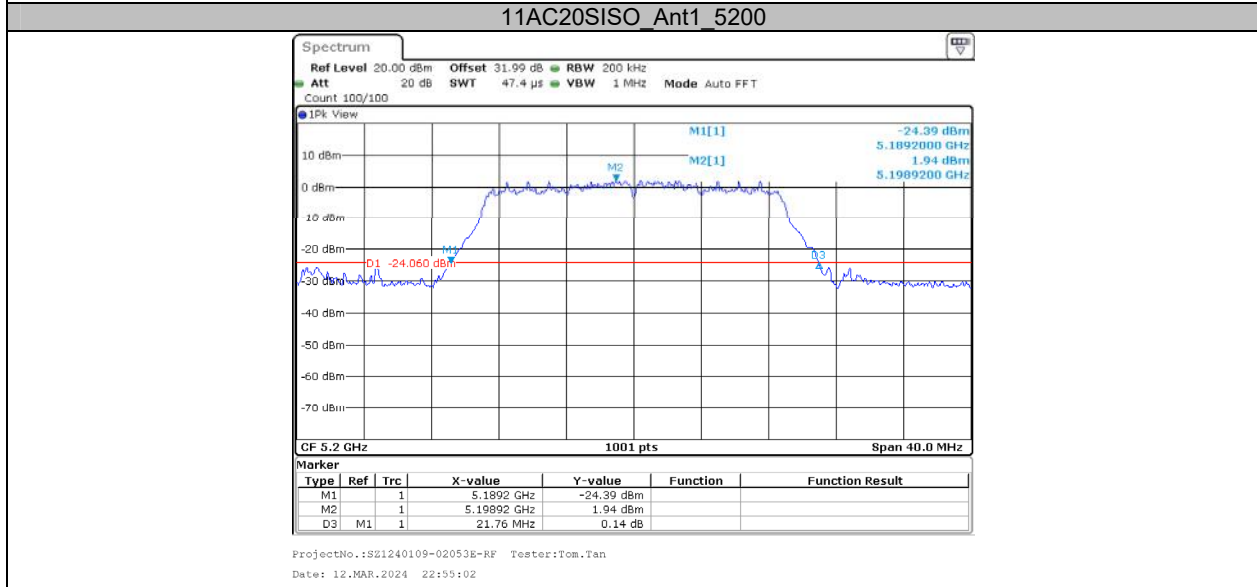
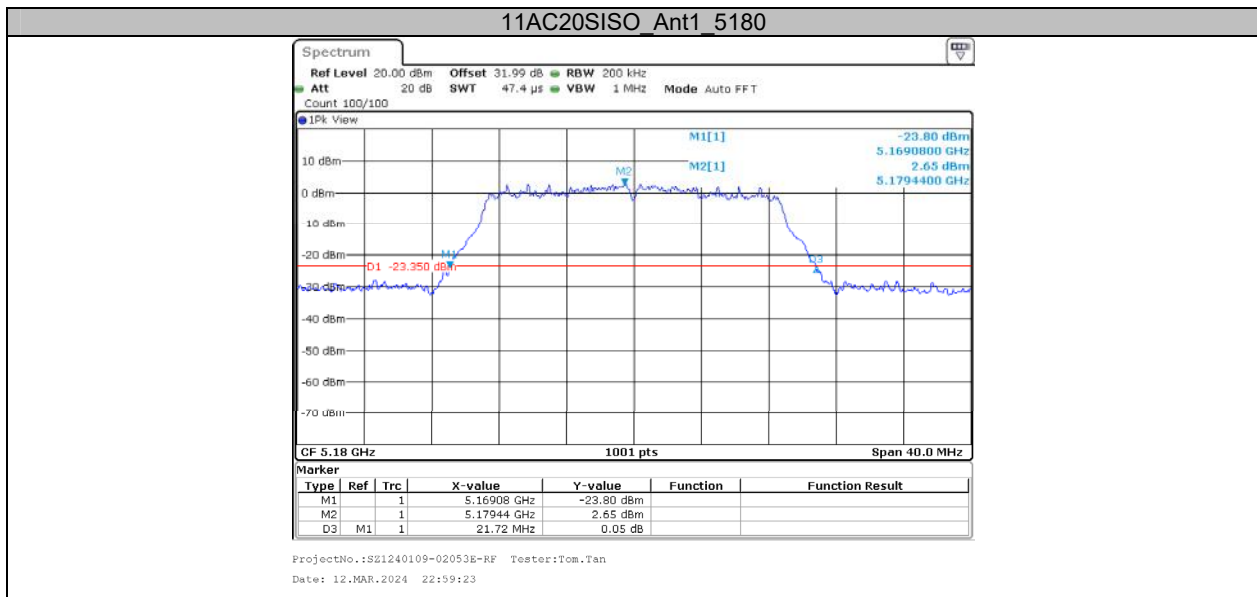



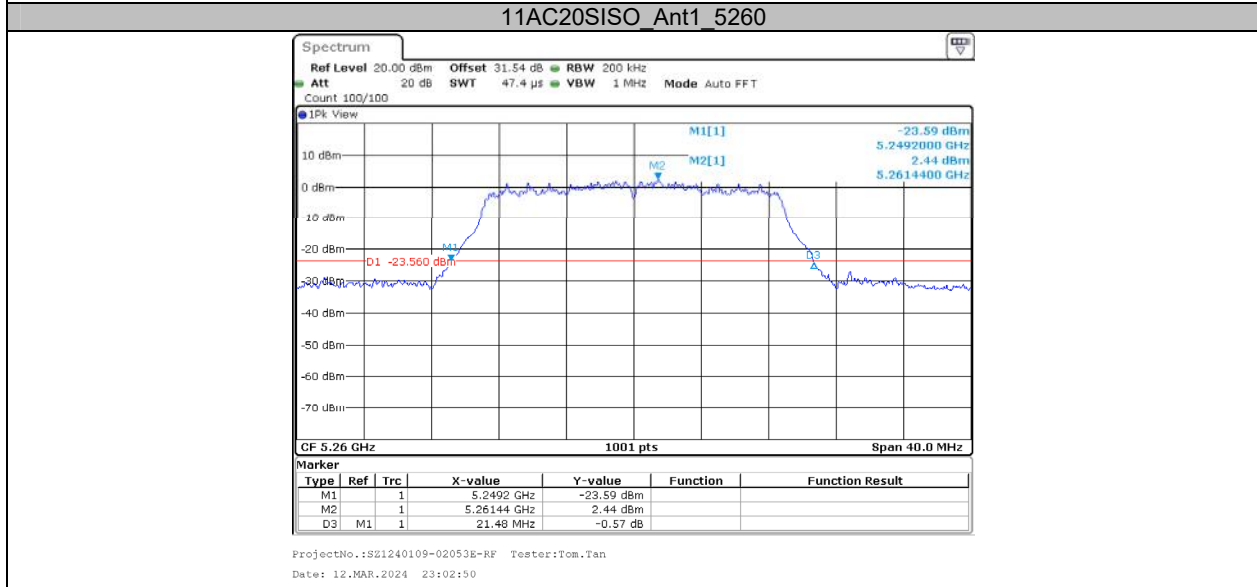
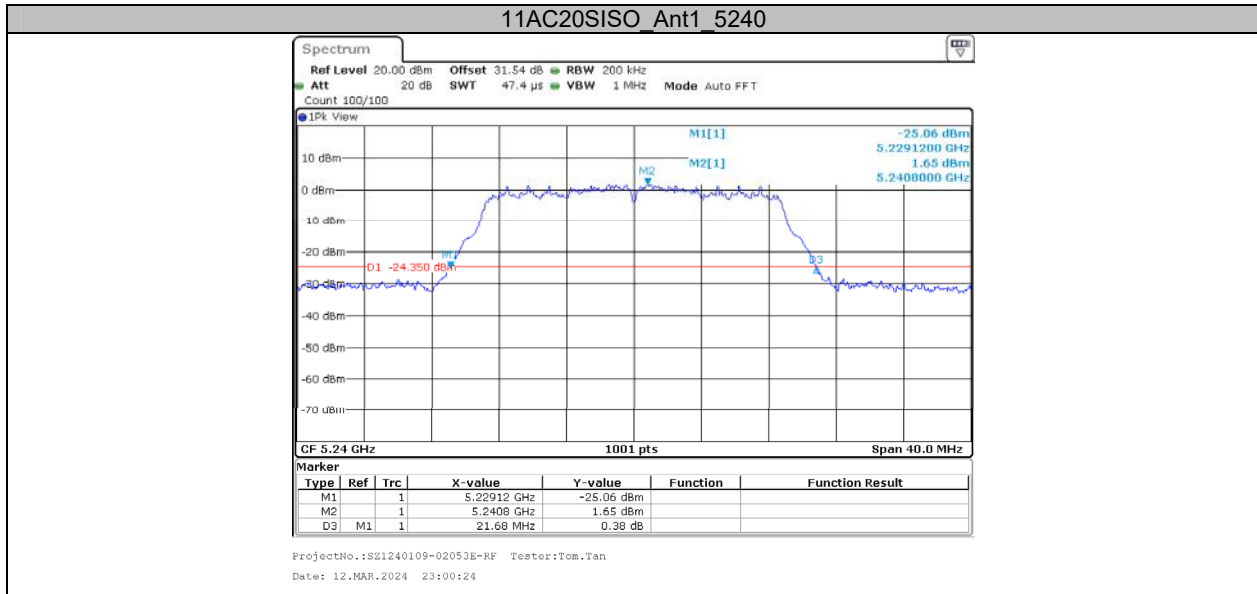

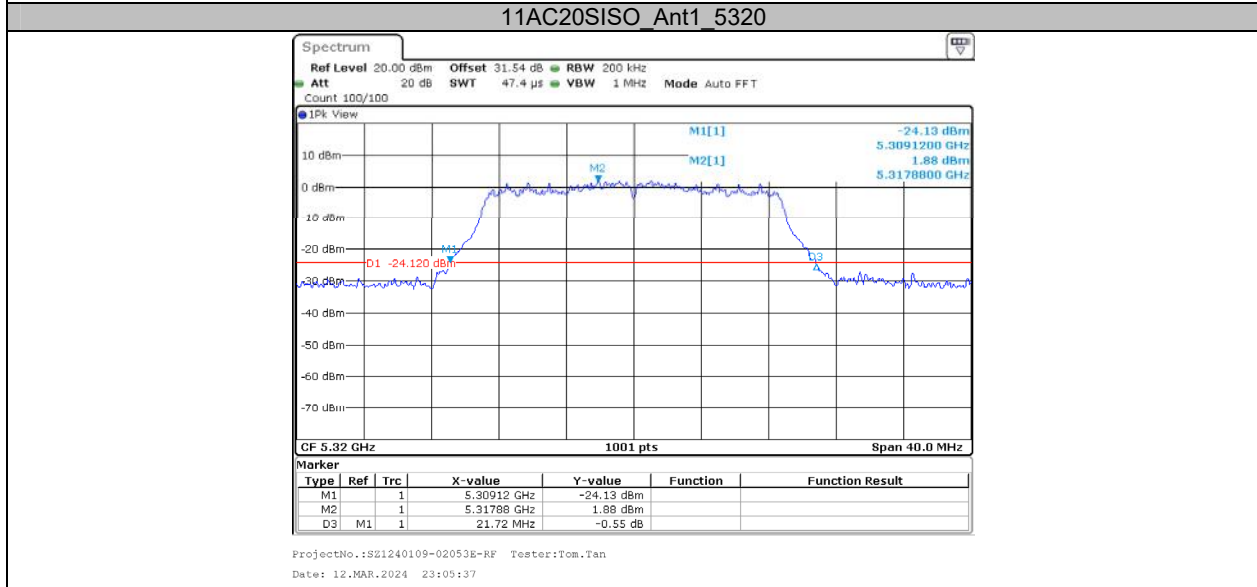
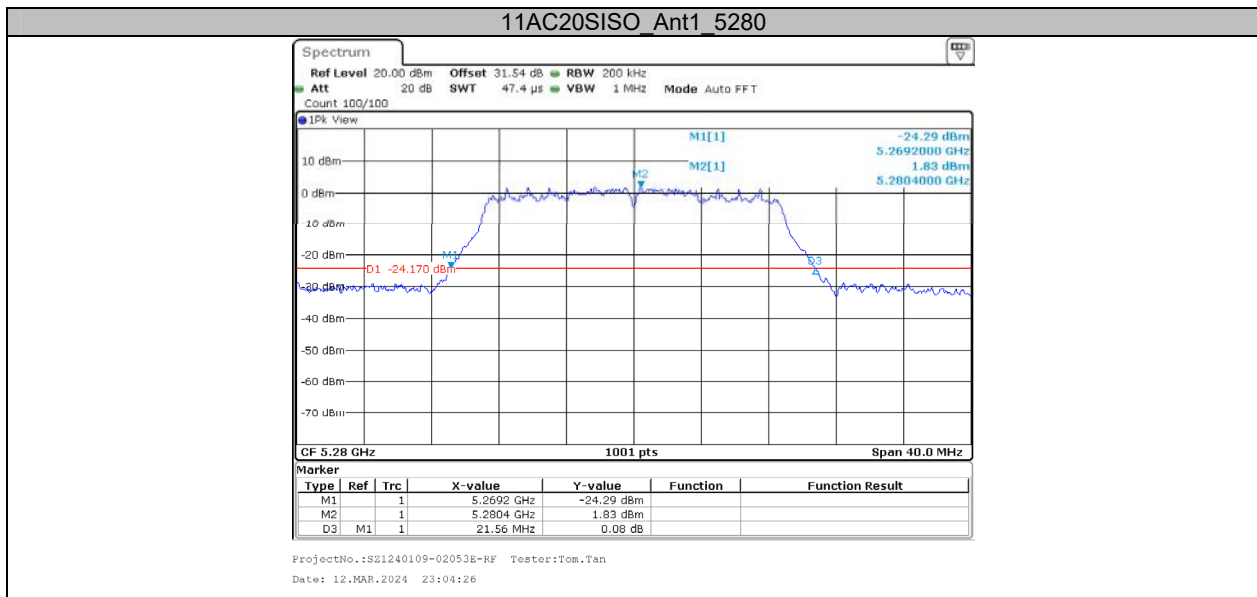

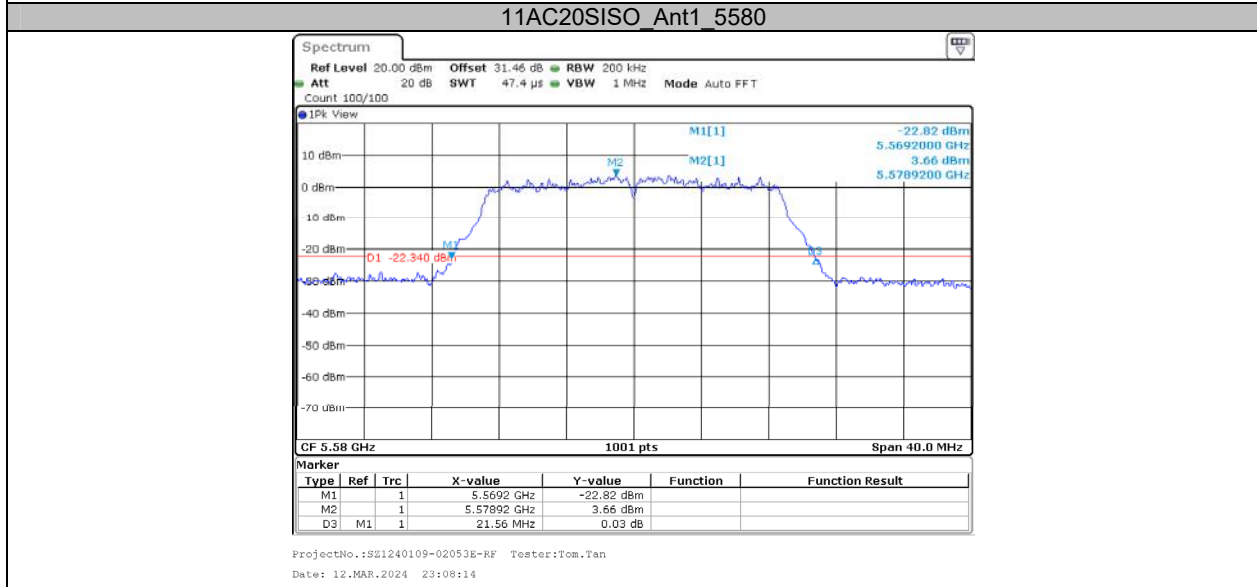
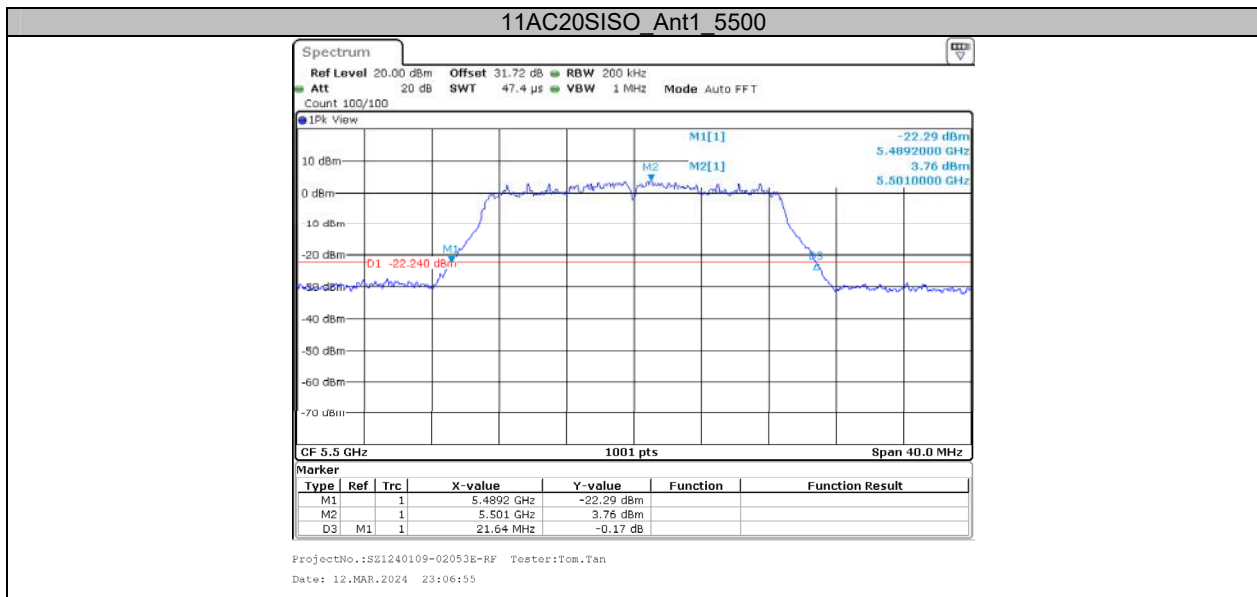

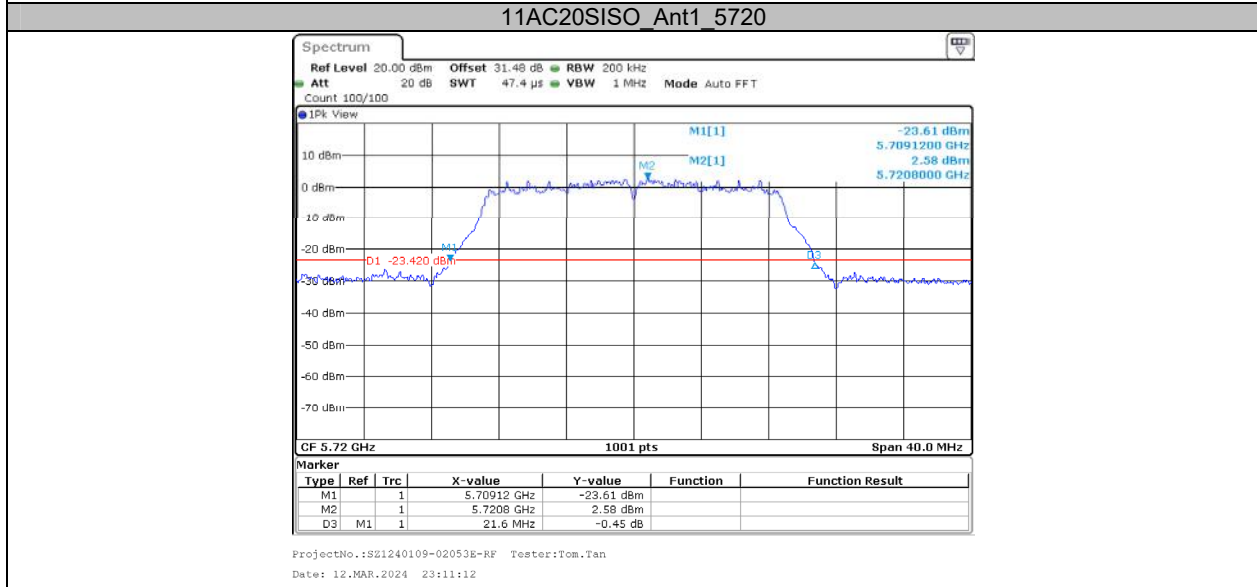
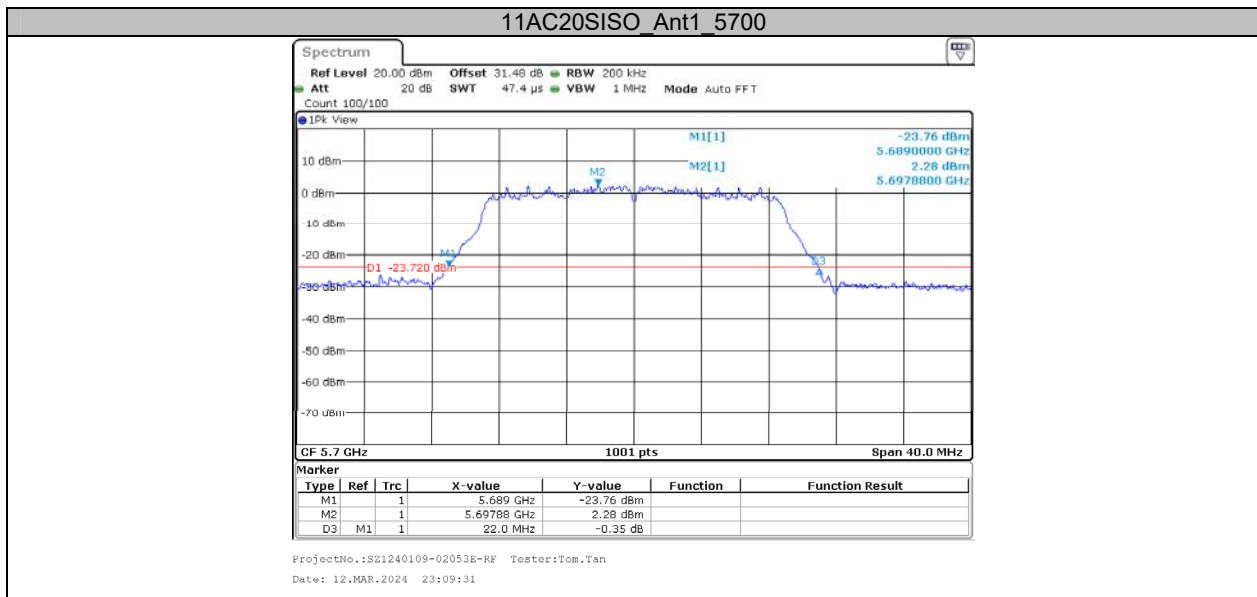

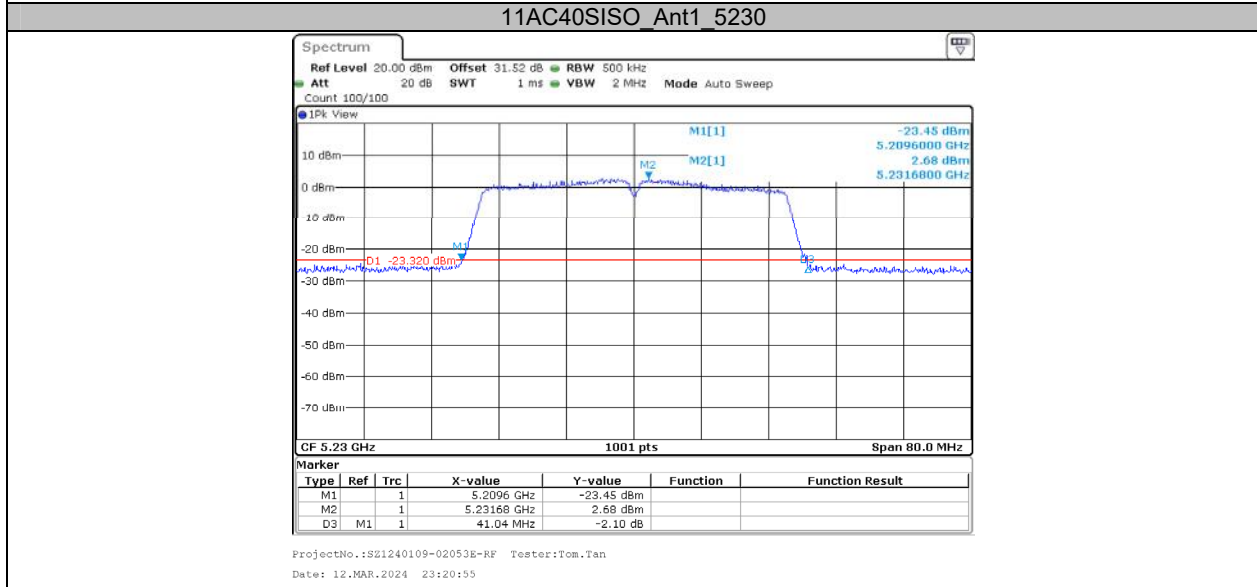
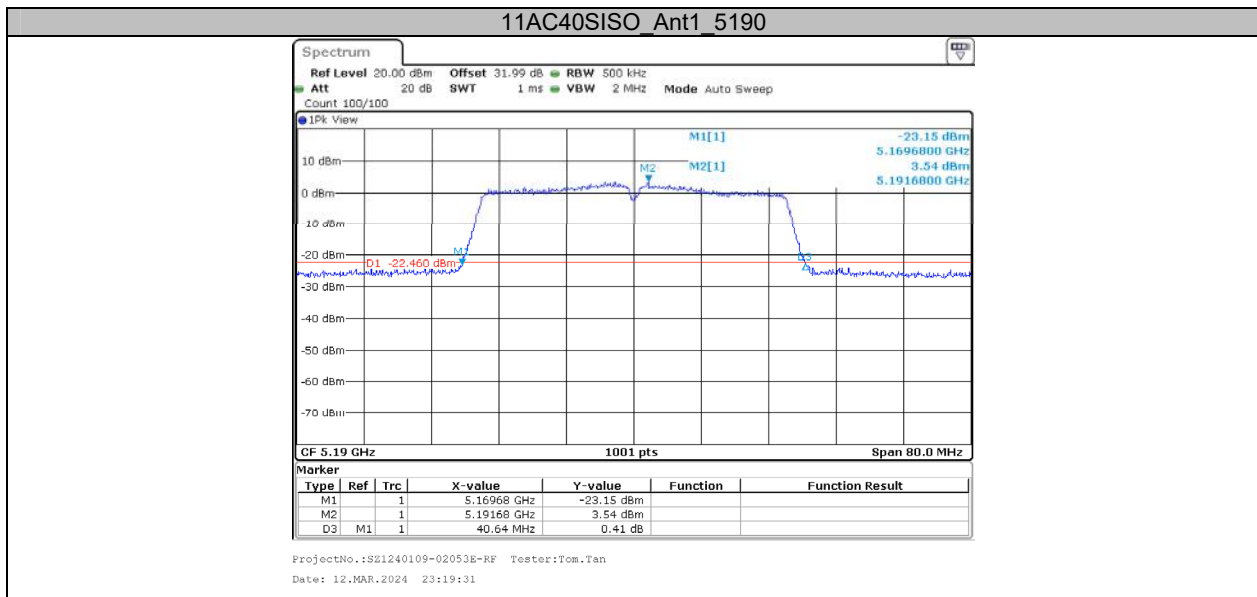

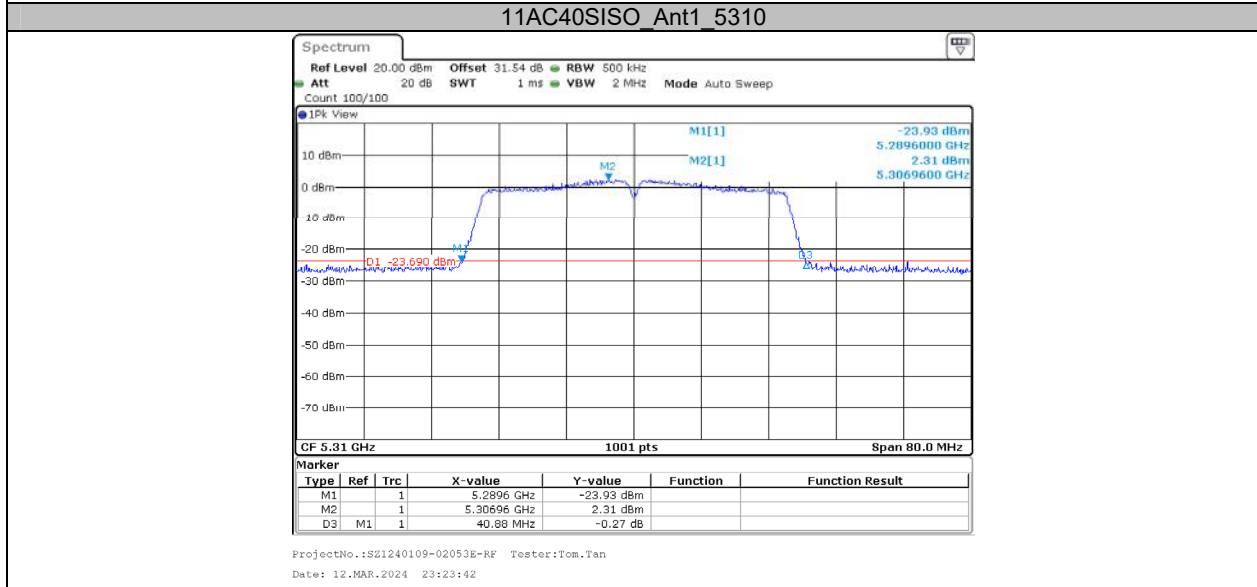
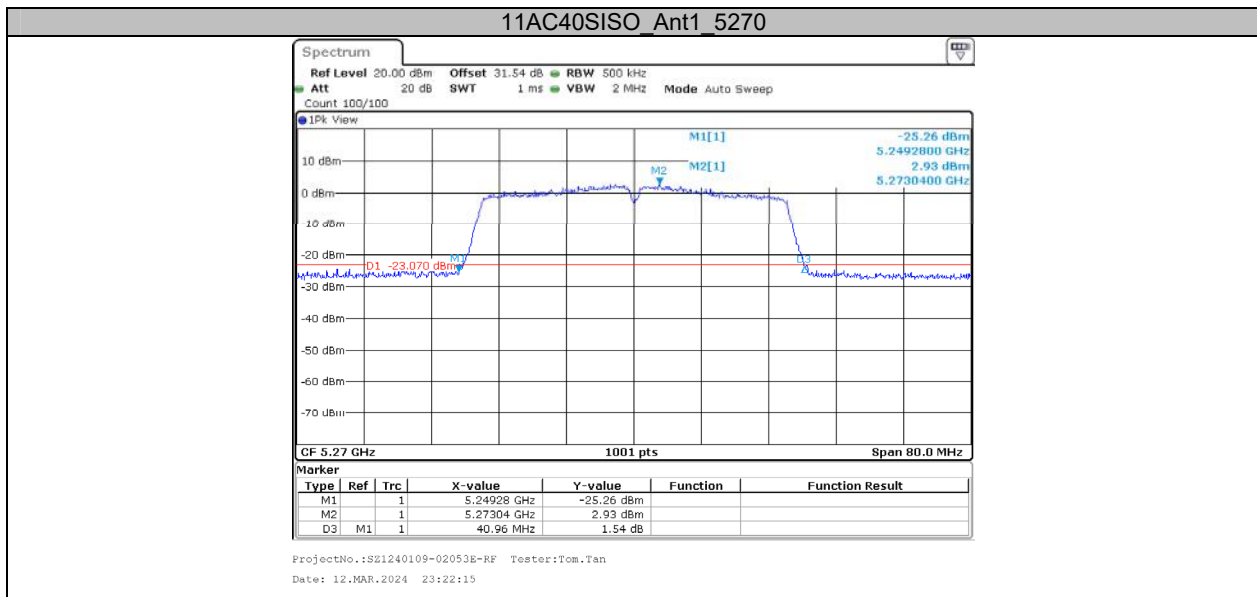

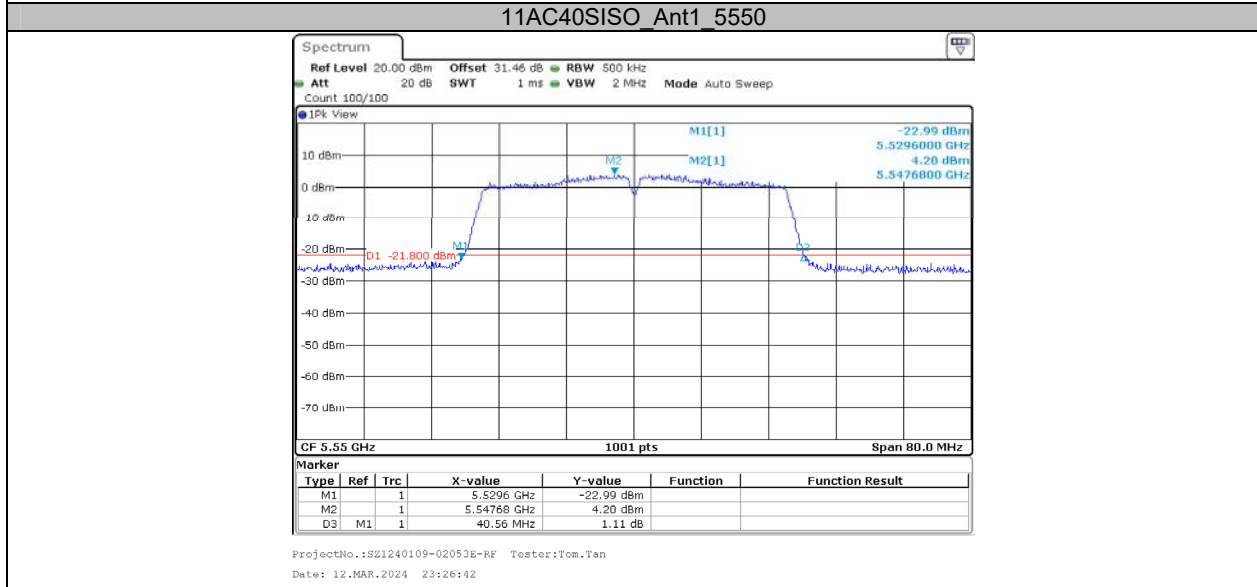
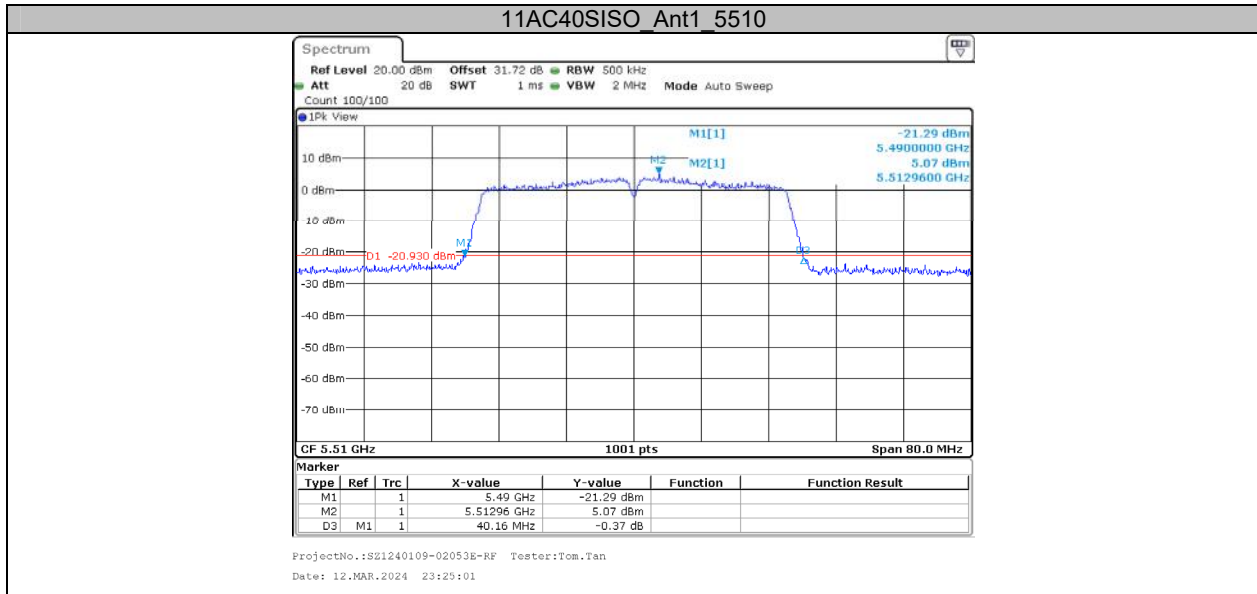

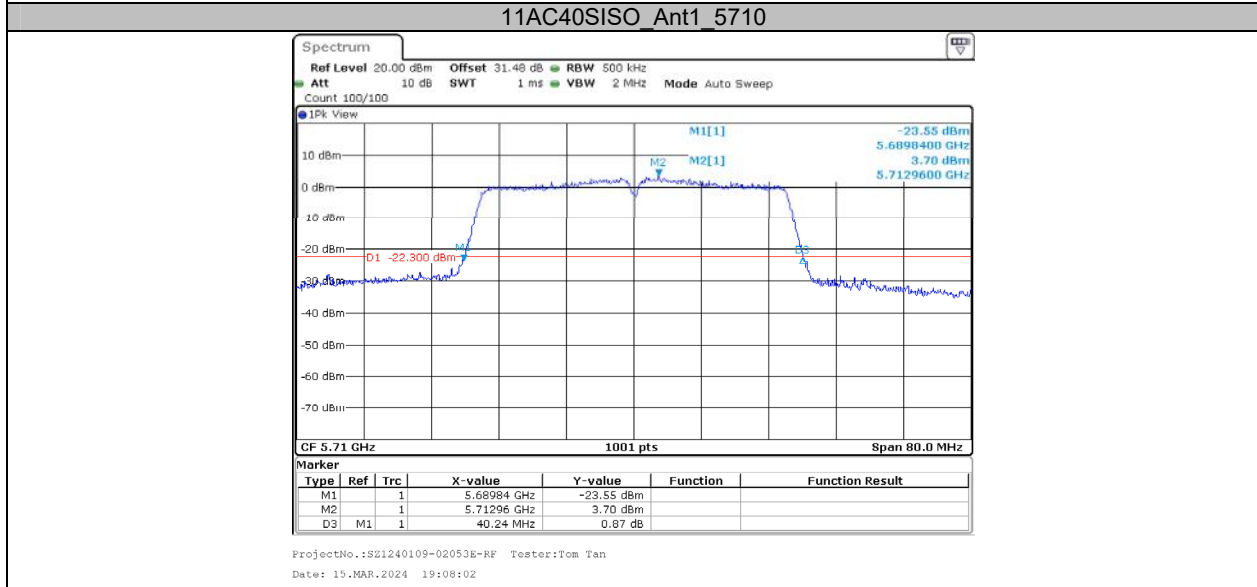
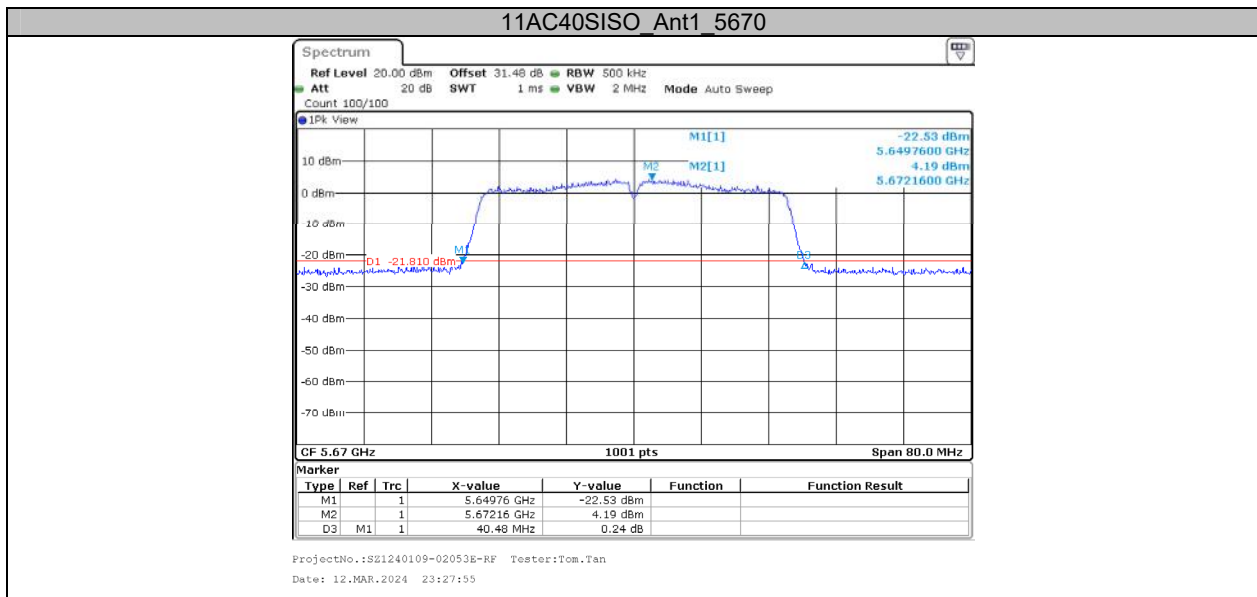



11AC80SISO Ant1 5210

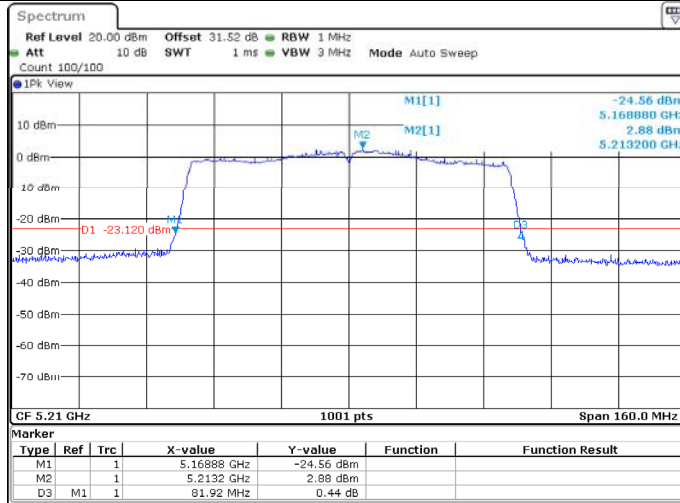

ProjectNo.:SZ1240109-02053E-RF Tester:Tom.Tan  
 Date: 12.MAR.2024 23:36:50

11AC80SISO Ant1 5290

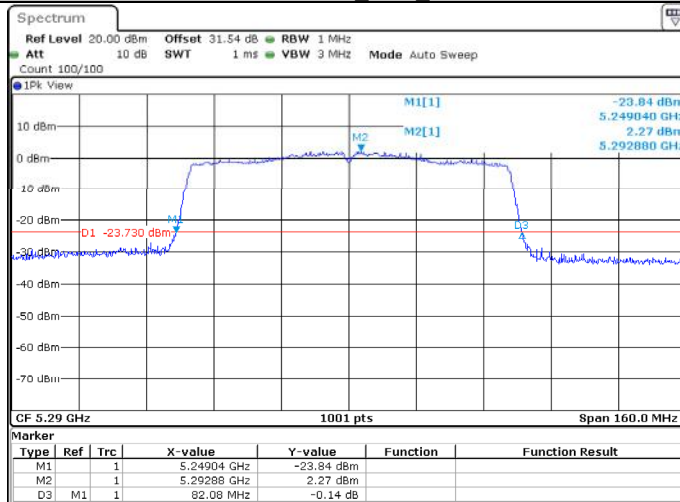

ProjectNo.:SZ1240109-02053E-RF Tester:Tom.Tan  
 Date: 12.MAR.2024 23:38:37

11AC80SISO Ant1\_5530

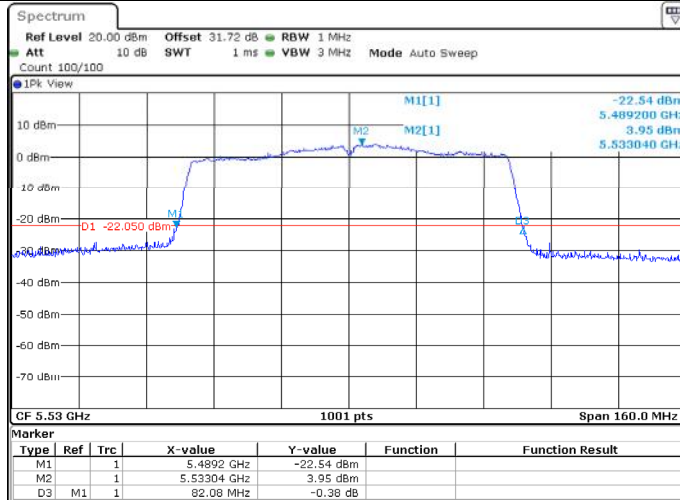

ProjectNo.:SZ1240109-02053E-RF Tester:Tom.Tan  
Date: 12.MAR.2024 23:39:54

11AC80SISO Ant1\_5690

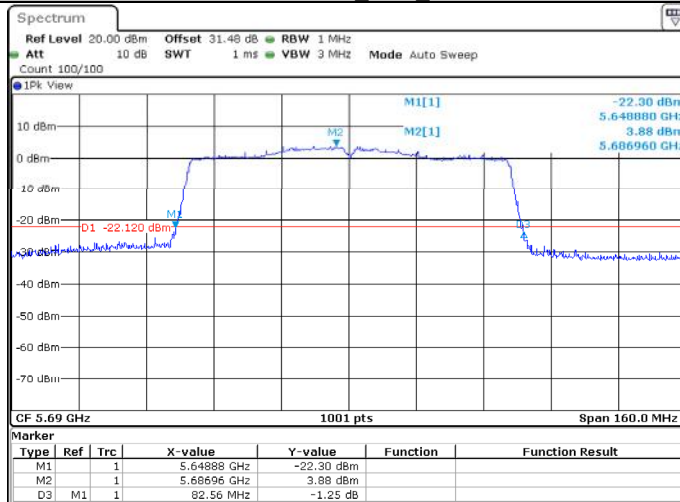

ProjectNo.:SZ1240109-02053E-RF Tester:Tom.Tan  
Date: 15.MAR.2024 19:11:16

**Appendix A2: Occupied channel bandwidth  
Test Result**

Test Mode	Antenna	Channel	OCB [MHz]	Limit[MHz]	Verdict
11A	Ant1	5180	17.782	---	---
		5200	17.902	---	---
		5240	17.902	---	---
		5260	17.862	---	---
		5280	17.982	---	---
		5320	17.942	---	---
		5500	17.782	---	---
		5580	17.782	---	---
		5700	17.942	---	---
		5720	17.822	---	---
		5720_UNII-2C	13.951	---	---
		5720_UNII-3	3.871	---	---
		5745	17.942	---	---
		5785	17.862	---	---
5825	17.862	---	---		
11AC20SISO	Ant1	5180	18.621	---	---
		5200	18.901	---	---
		5240	18.701	---	---
		5260	18.621	---	---
		5280	18.701	---	---
		5320	18.741	---	---
		5500	18.661	---	---
		5580	18.661	---	---
		5700	18.781	---	---
		5720	18.661	---	---
		5720_UNII-2C	14.351	---	---
		5720_UNII-3	4.311	---	---
		5745	18.741	---	---
		5785	18.741	---	---
5825	18.701	---	---		
11AC40SISO	Ant1	5190	36.843	---	---
		5230	36.843	---	---
		5270	36.683	---	---
		5310	36.763	---	---
		5510	36.683	---	---
		5550	36.683	---	---
		5670	36.763	---	---
		5710	36.923	---	---
		5710_UNII-2C	33.462	---	---
		5710_UNII-3	3.462	---	---
		5755	37.003	---	---
		5795	37.083	---	---
11AC80SISO	Ant1	5210	76.563	---	---
		5290	76.563	---	---
		5530	76.244	---	---
		5690	76.404	---	---
		5690_UNII-2C	73.042	---	---
		5690_UNII-3	3.362	---	---
		5775	76.883	---	---

### Test Graphs

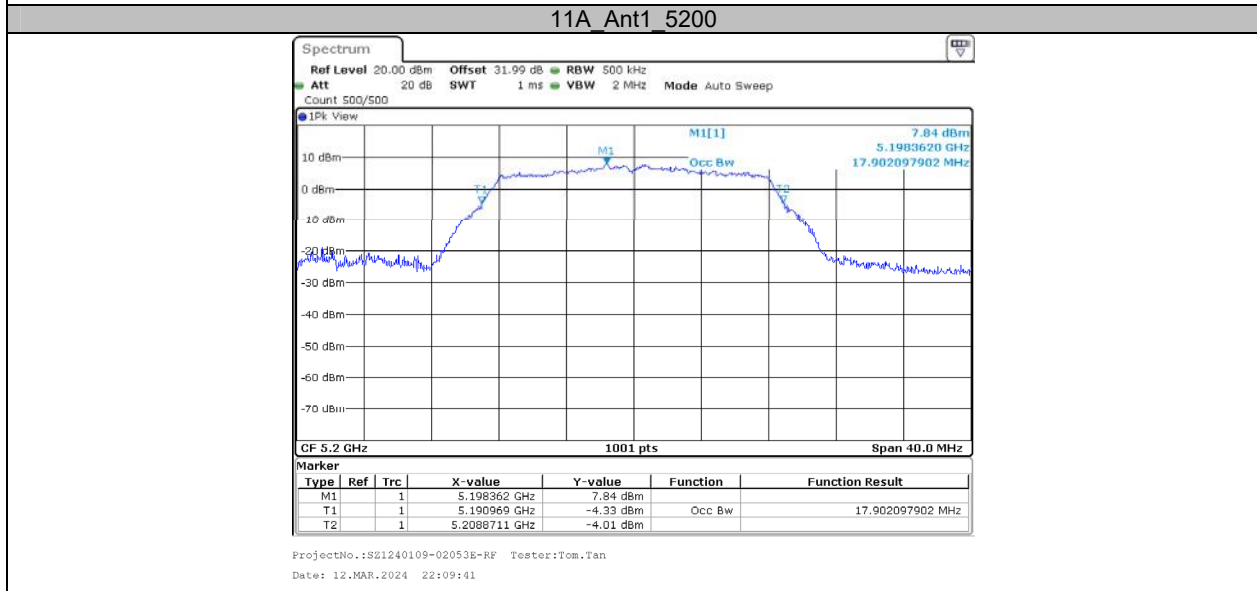
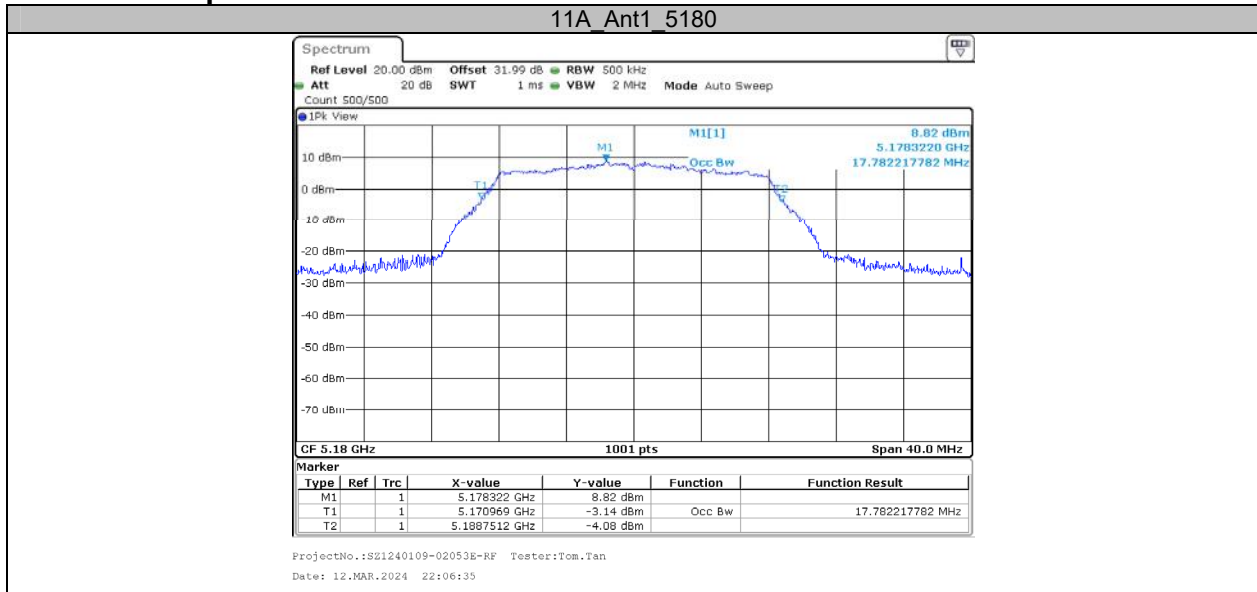

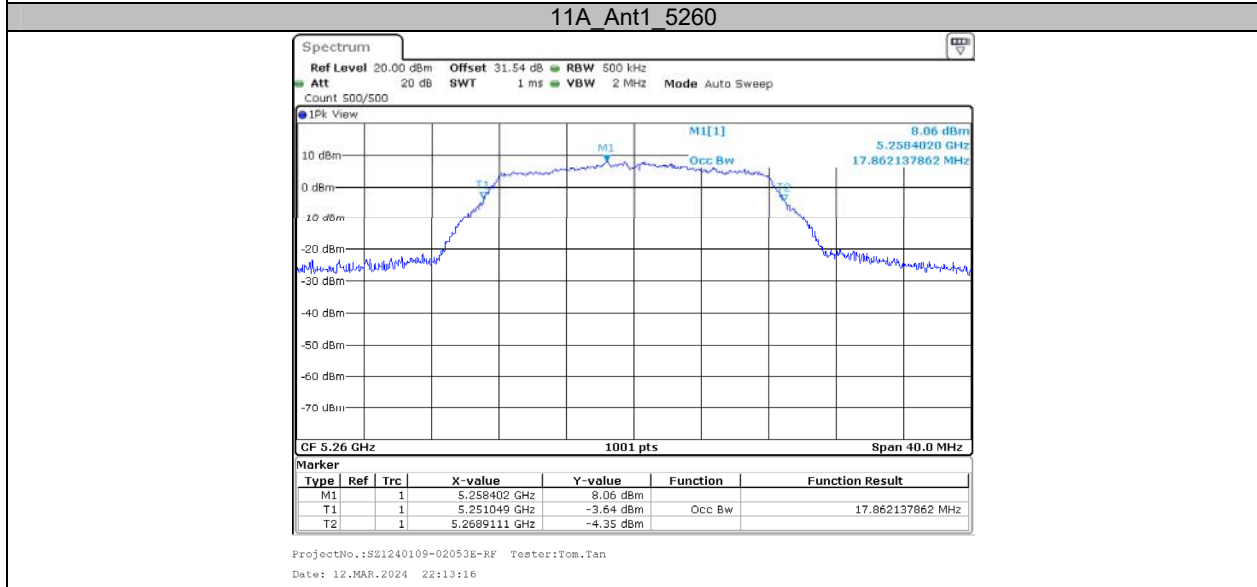
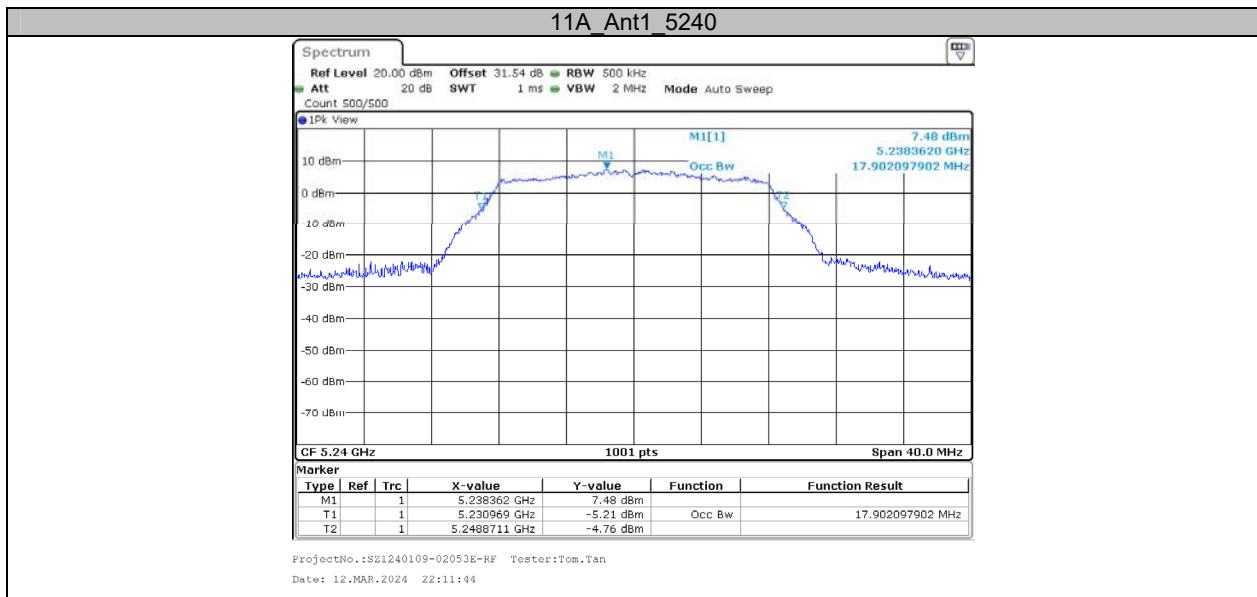

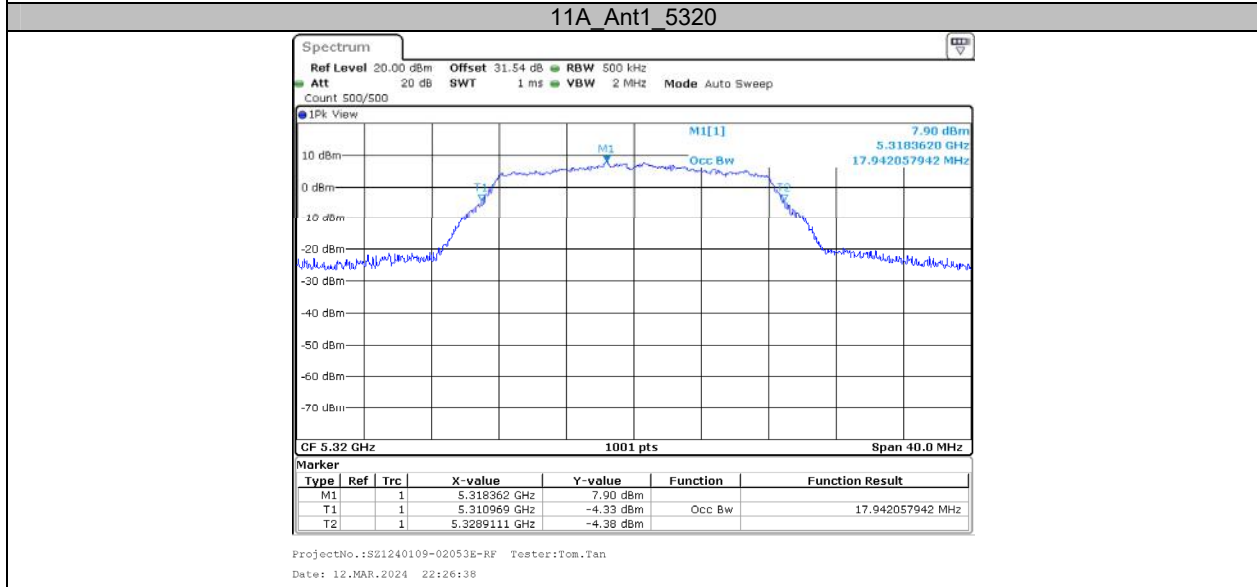
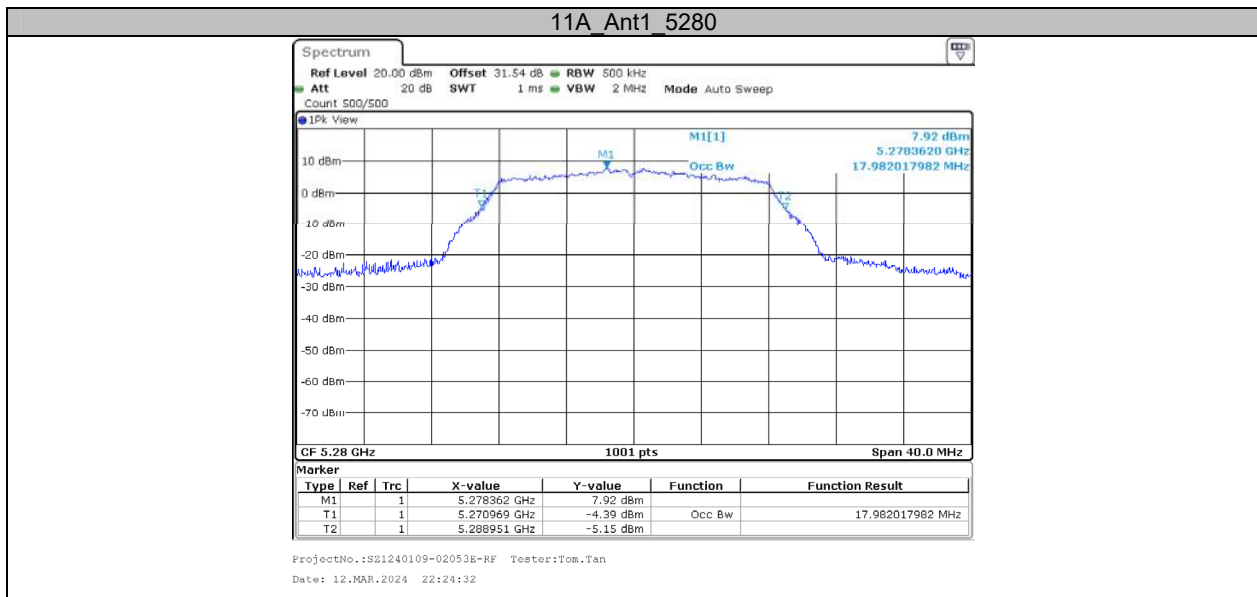

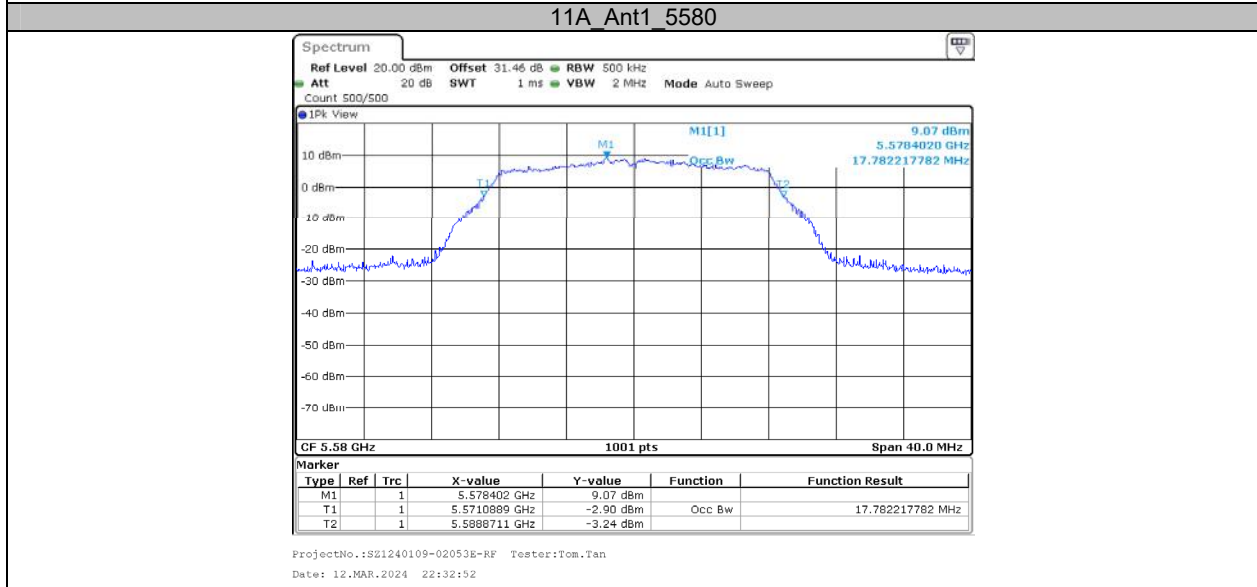
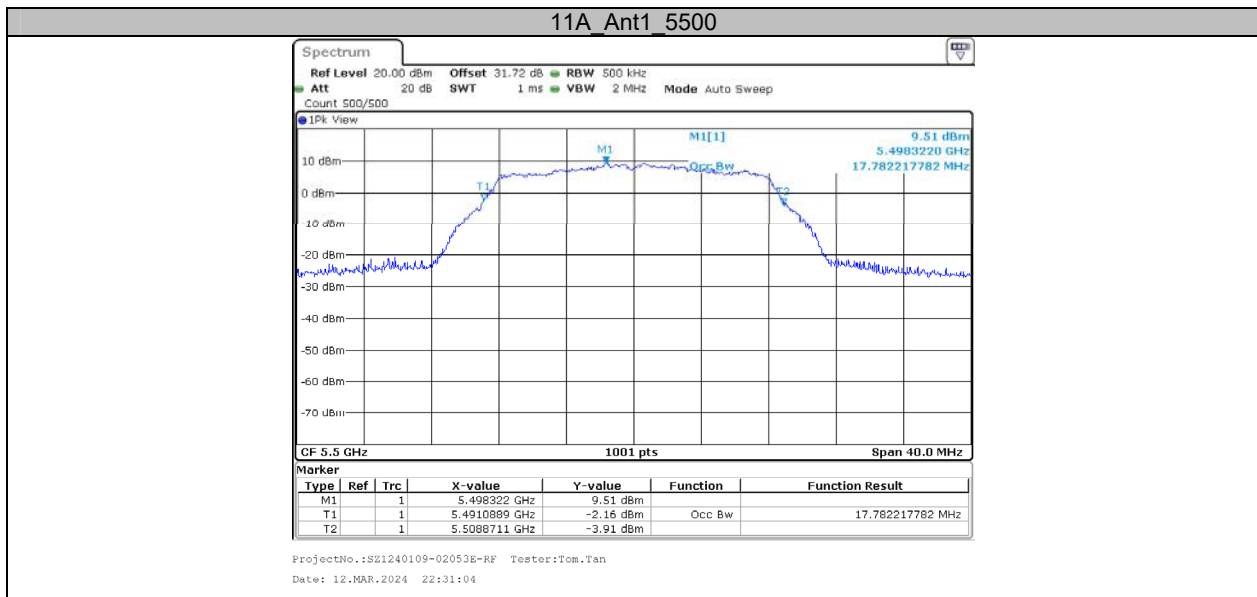

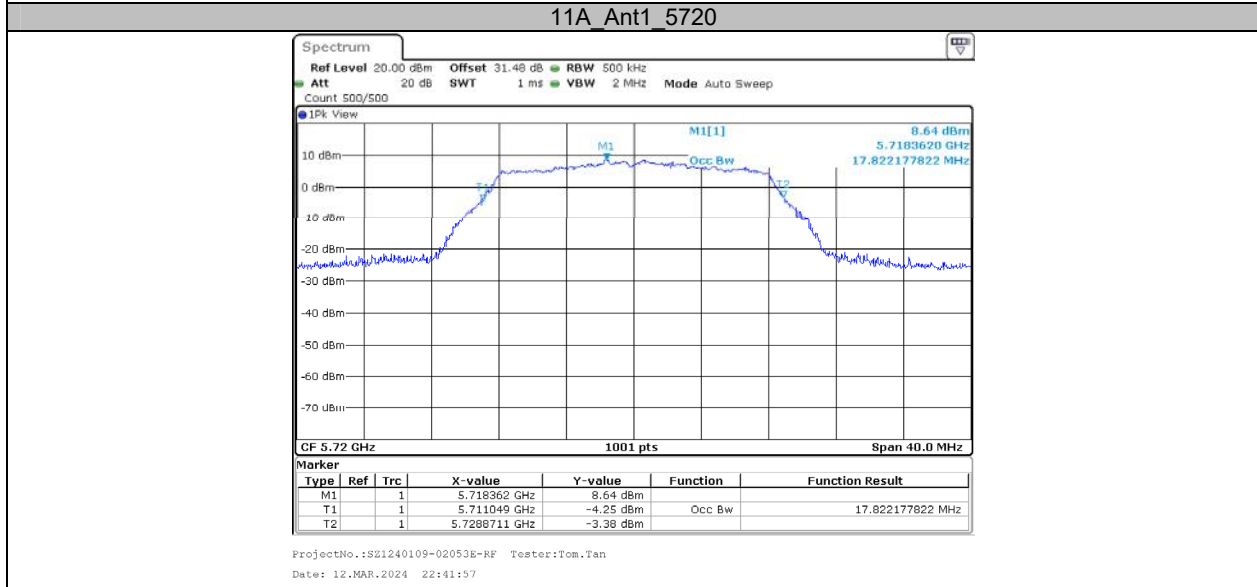
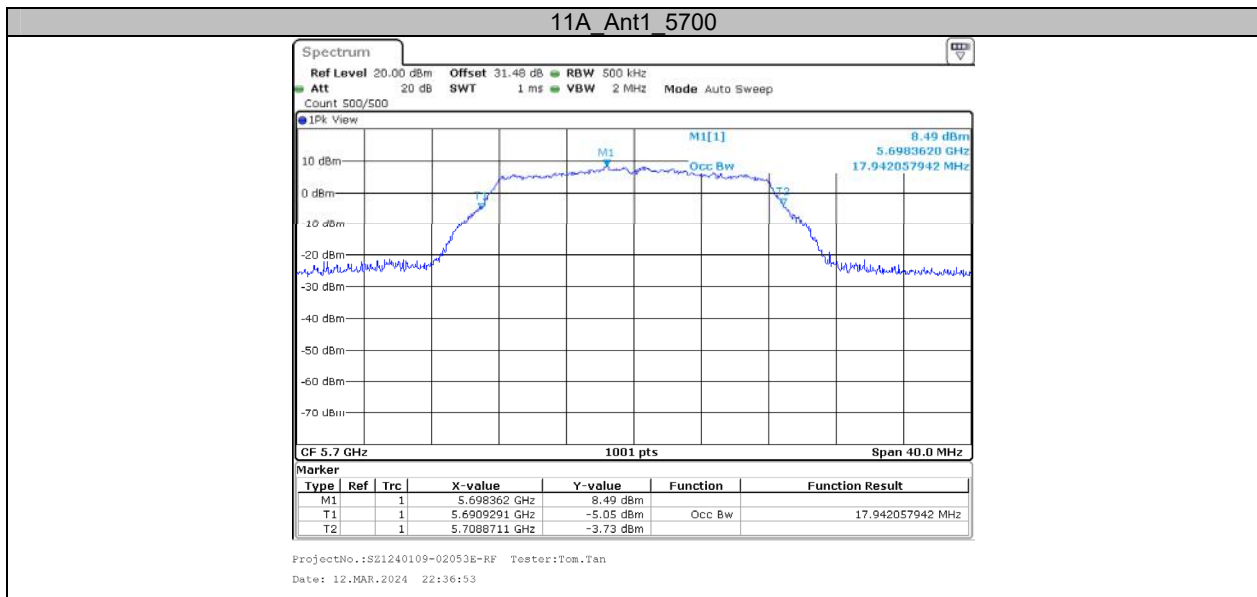



11A\_Ant1\_5745

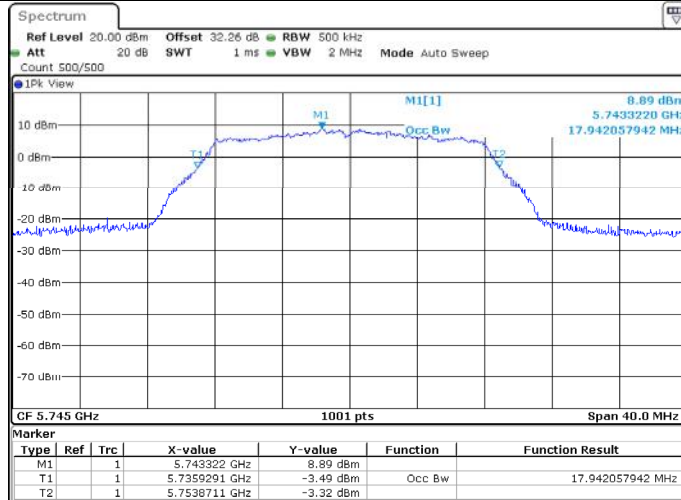

ProjectNo.:SZ1240109-02053E-RF Tester:Tom.Tan  
 Date: 12.MAR.2024 22:44:49

11A\_Ant1\_5785

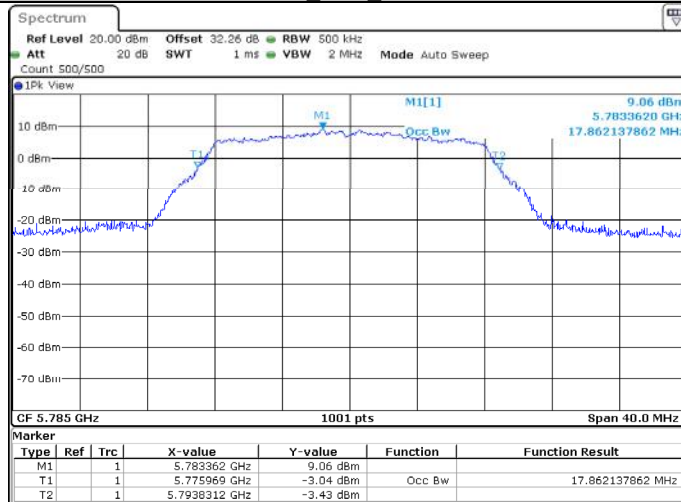

ProjectNo.:SZ1240109-02053E-RF Tester:Tom.Tan  
 Date: 12.MAR.2024 22:46:21

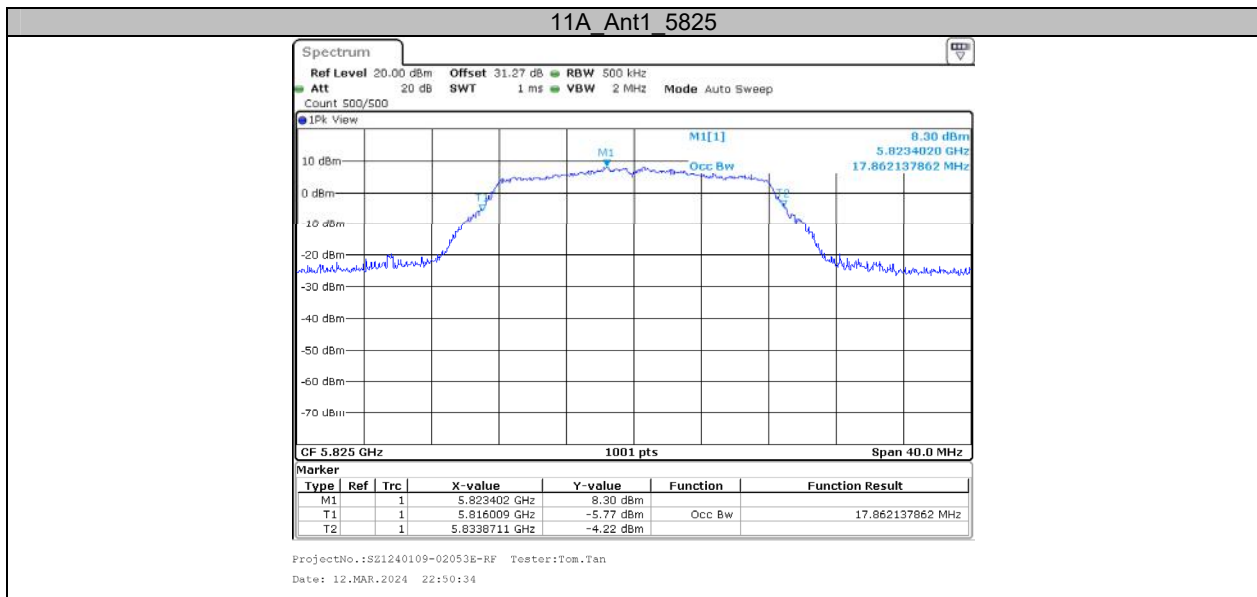

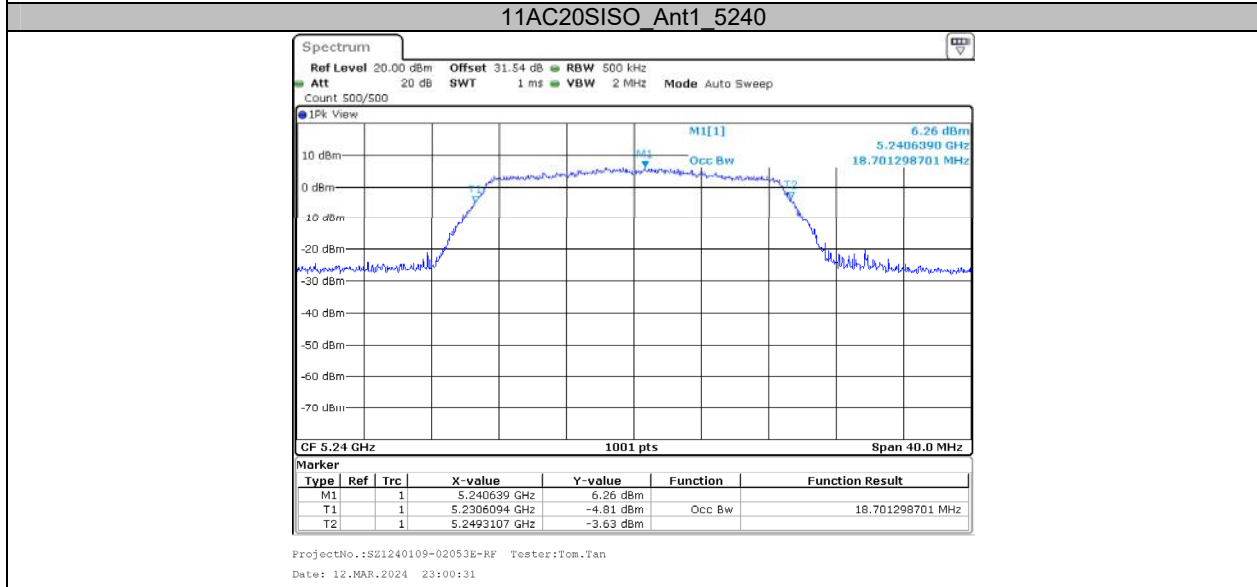
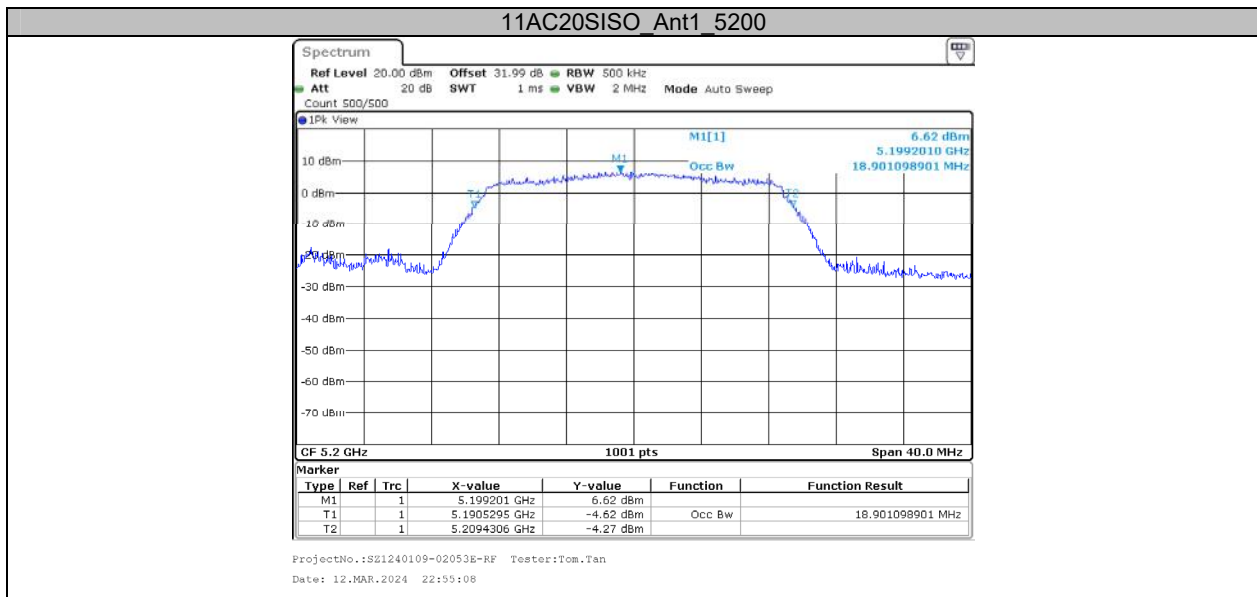

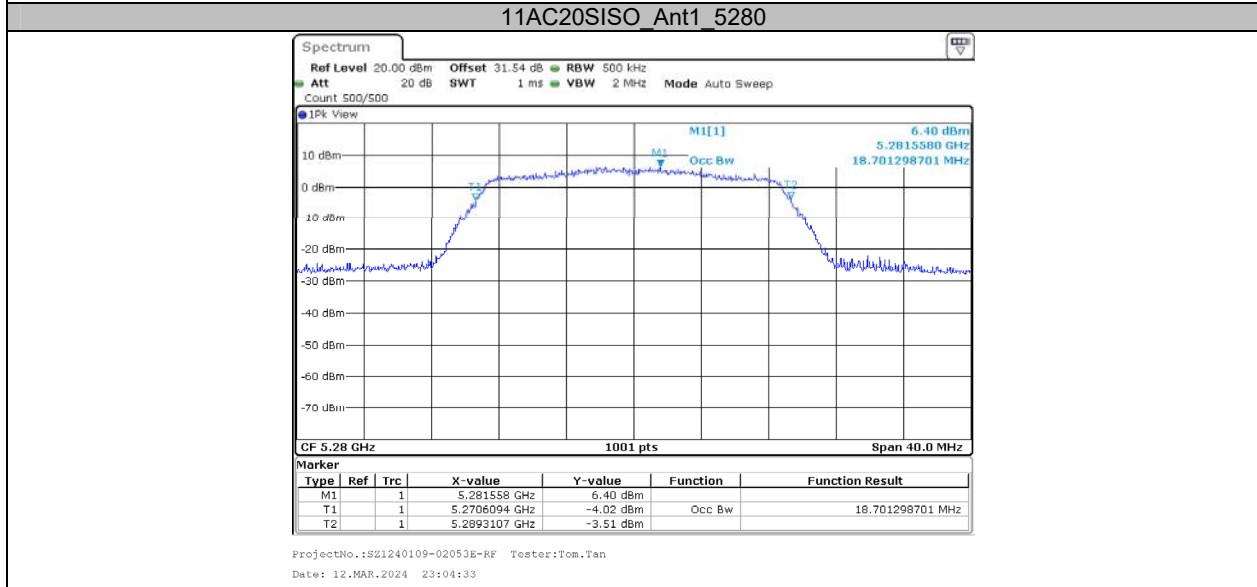
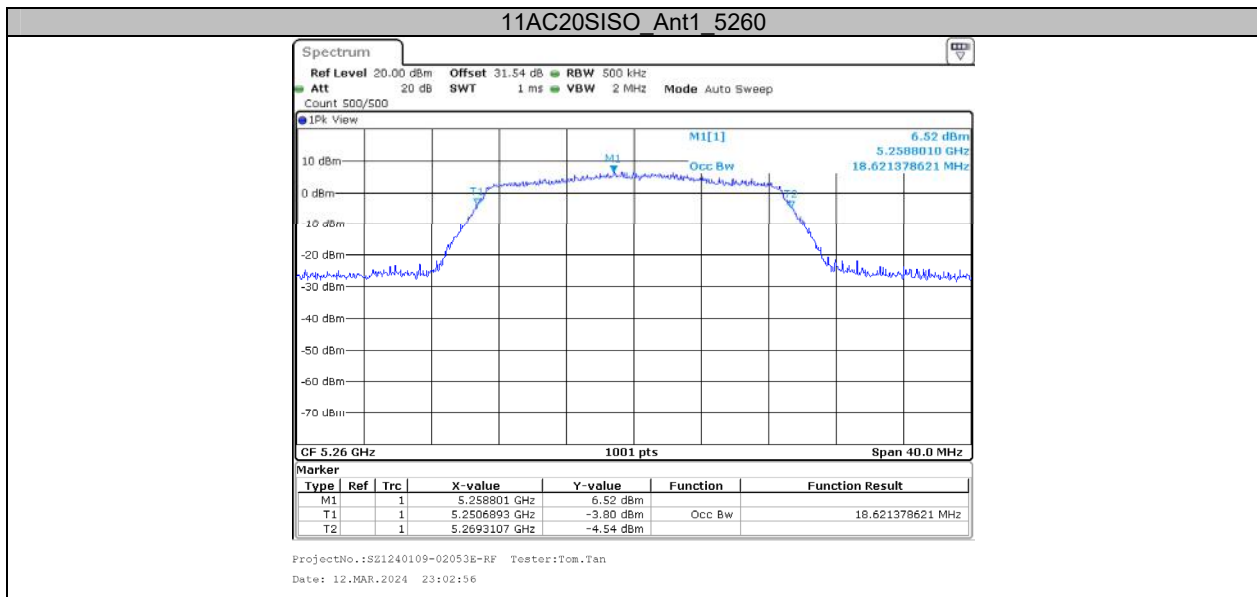

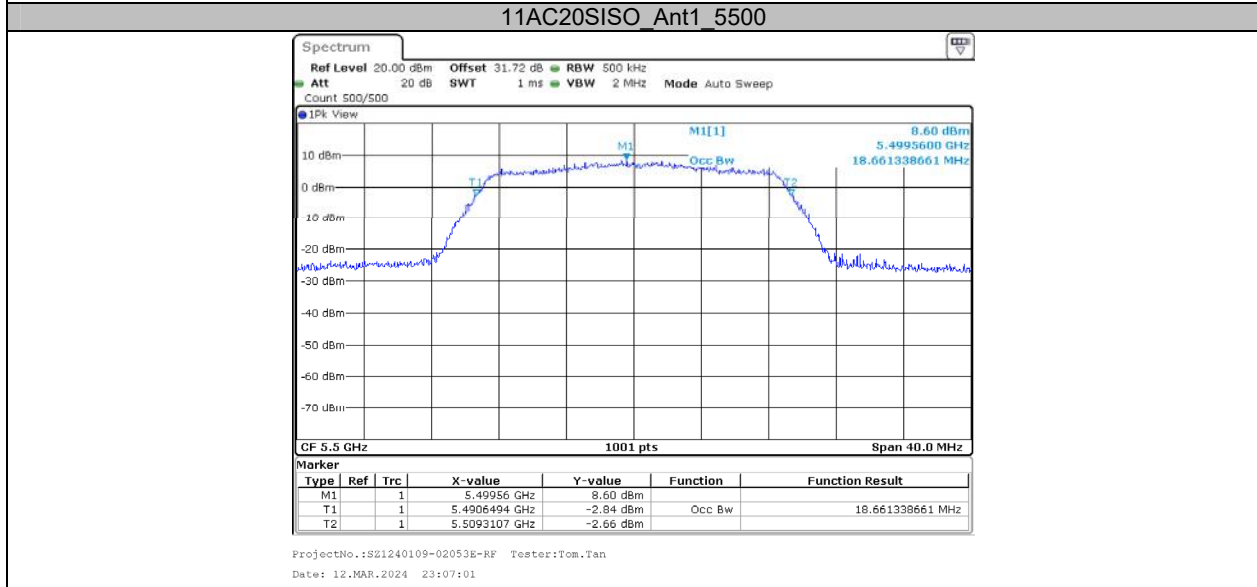
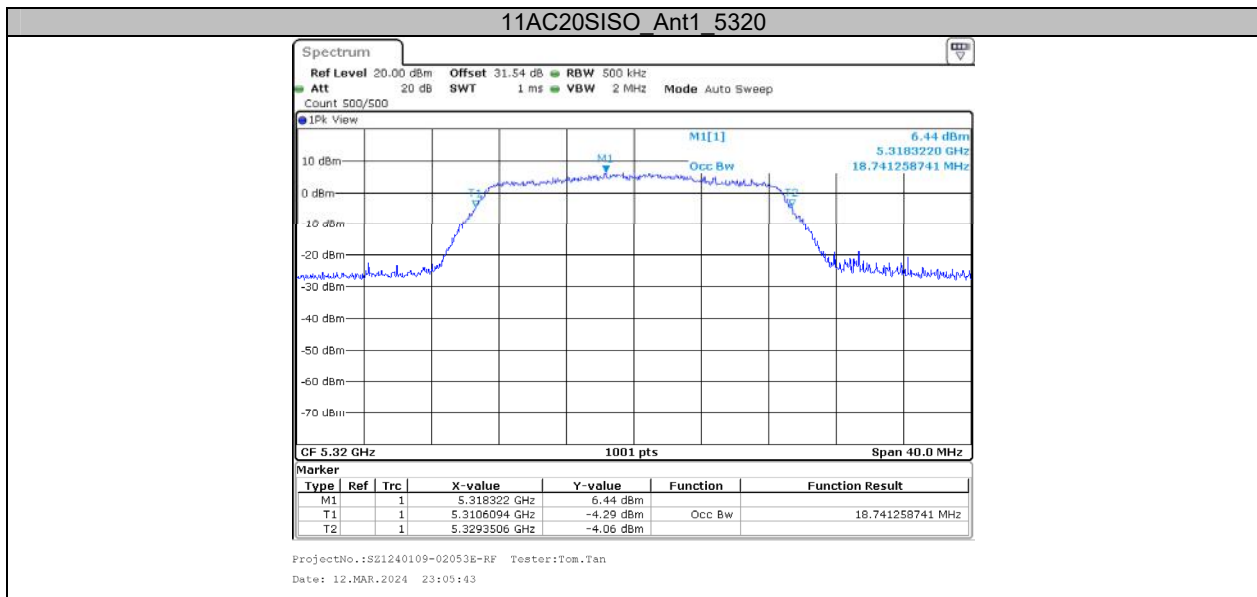

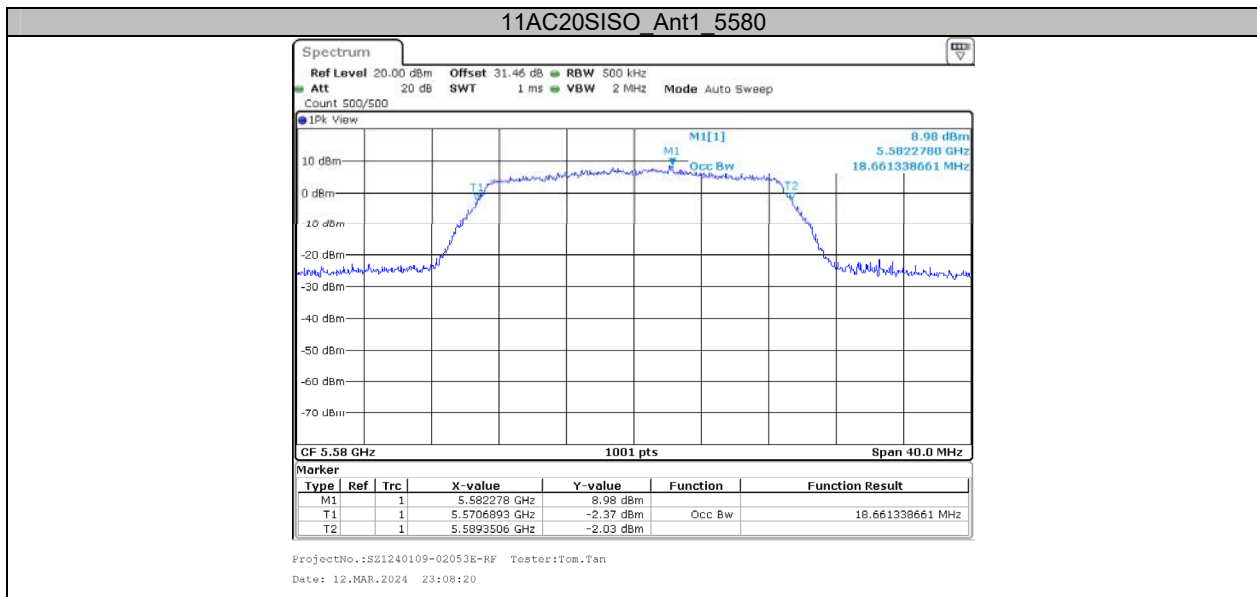

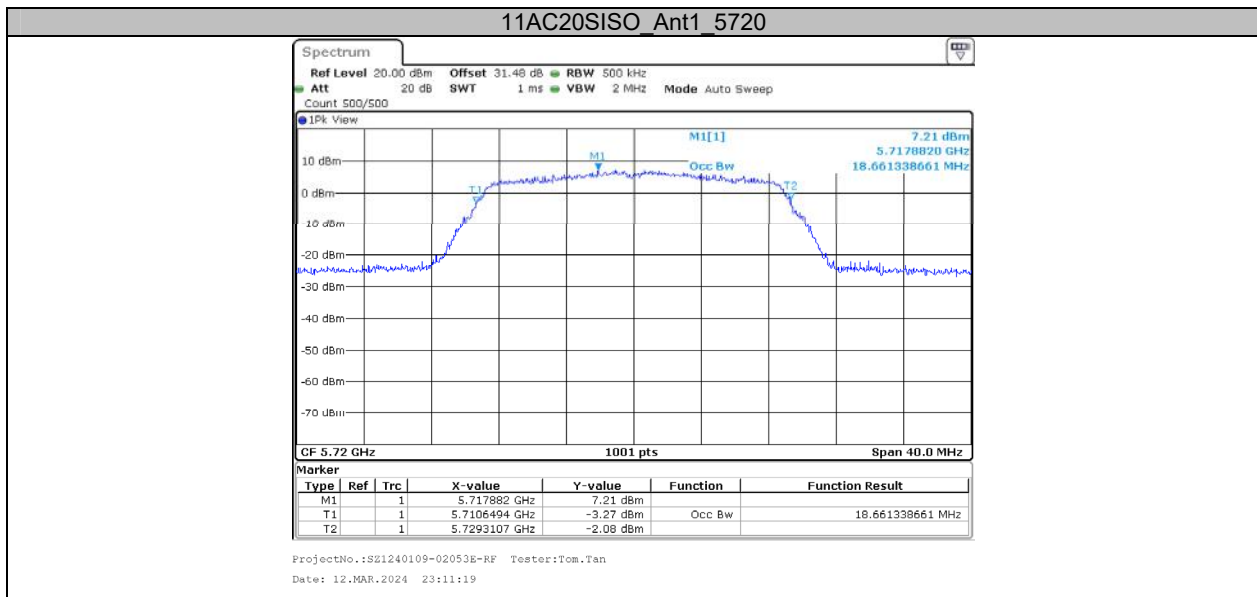

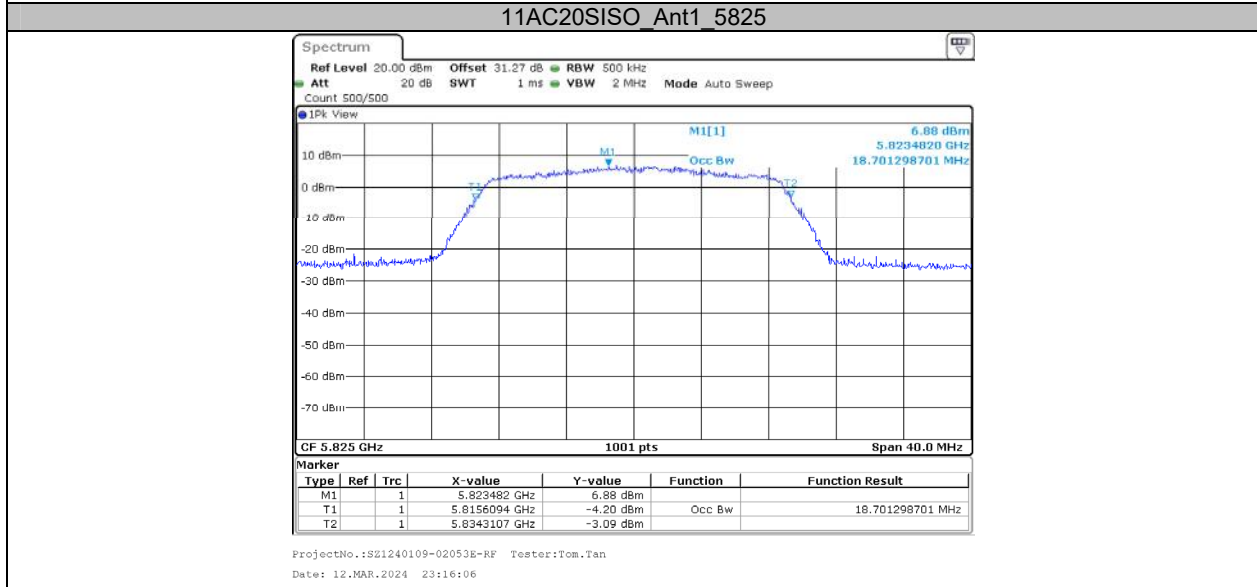
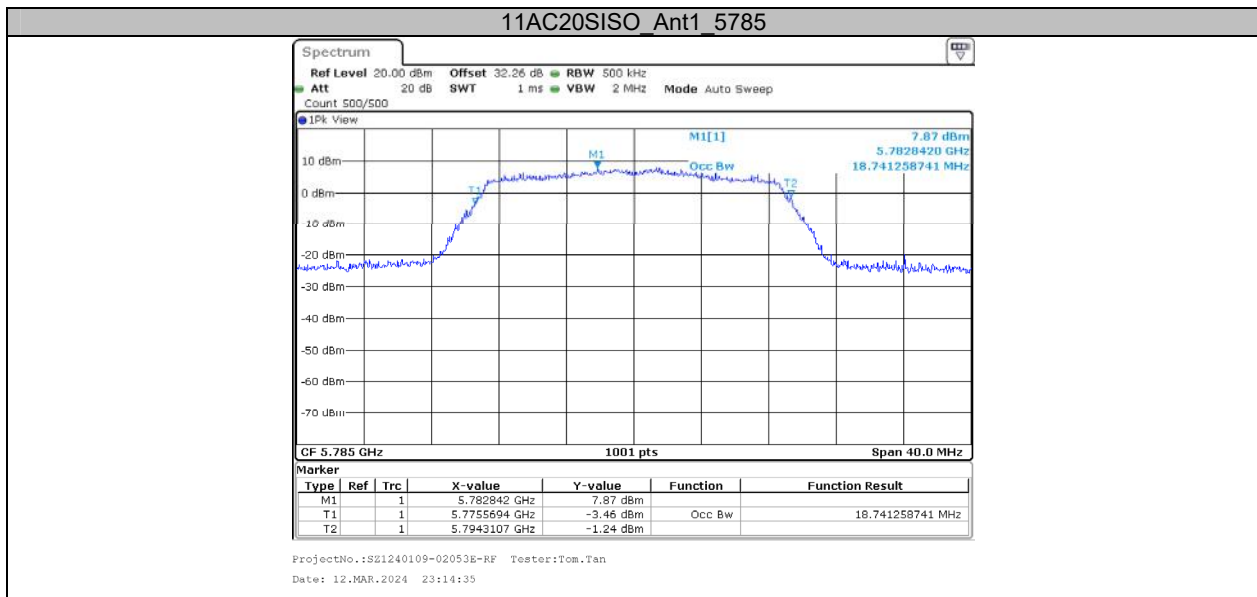



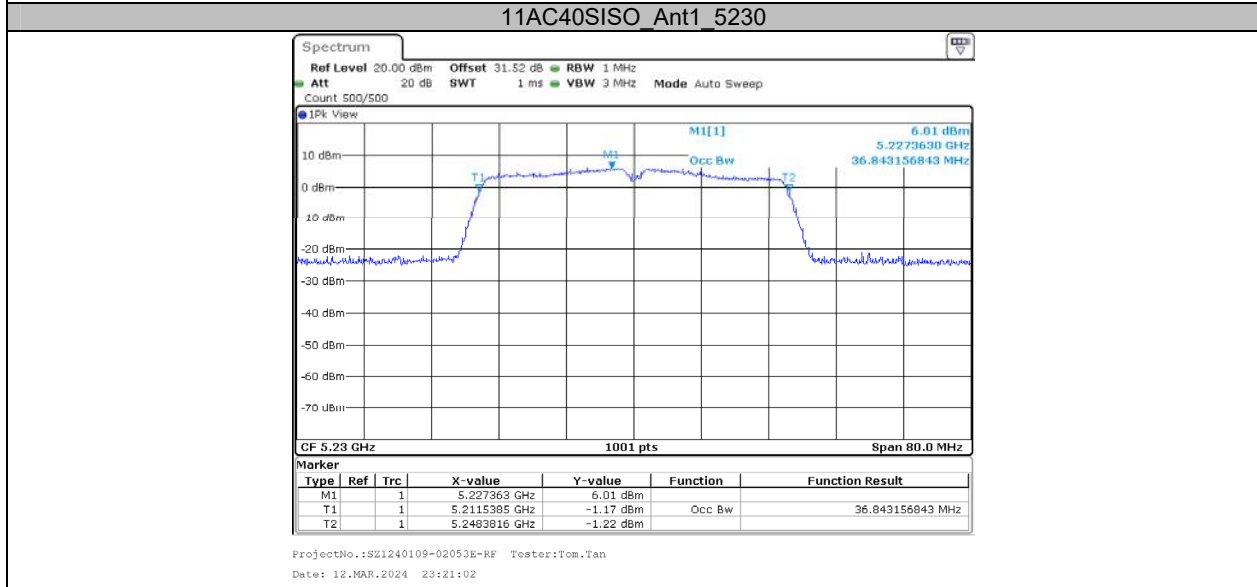
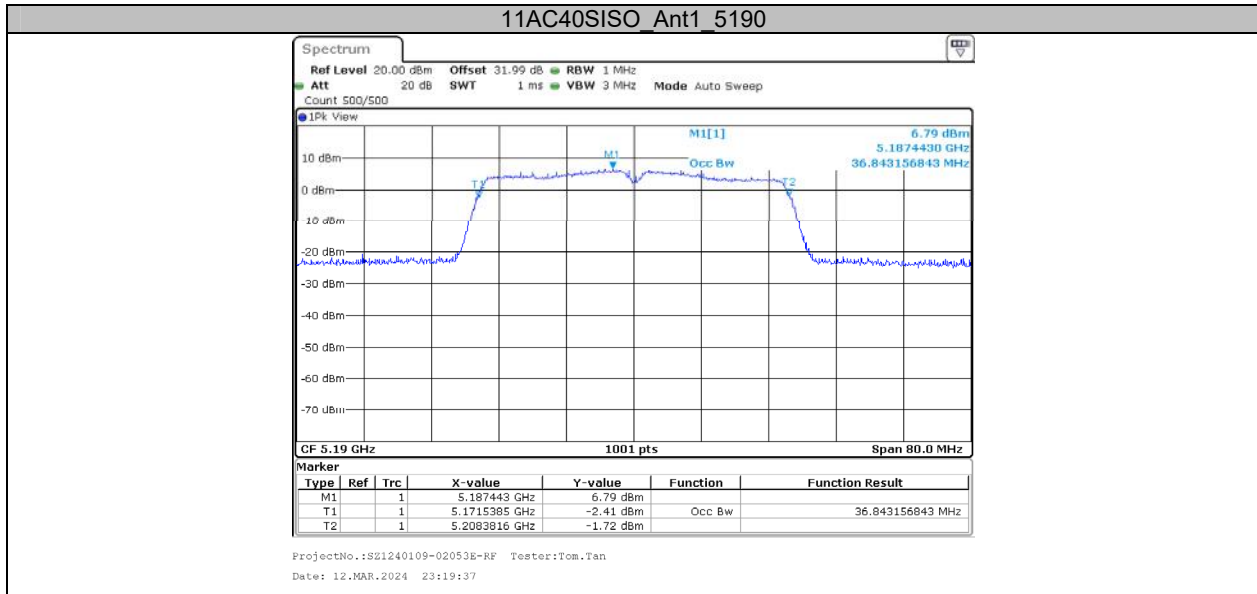

11AC40SISO Ant1 5270

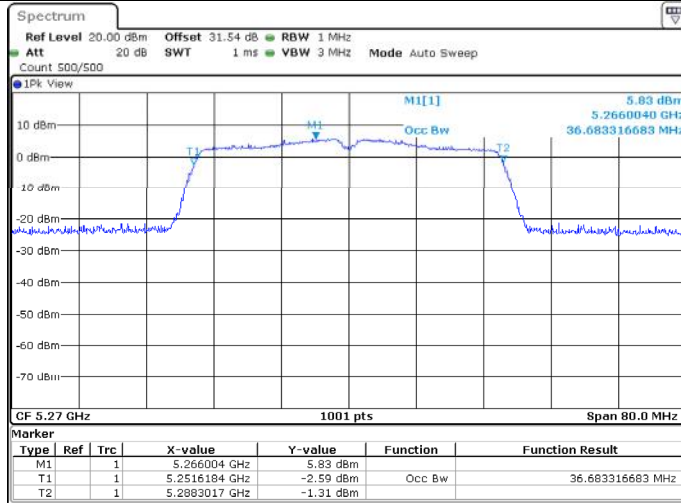

ProjectNo.:SZ1240109-02053E-RF Tester:Tom.Tan  
 Date: 12.MAR.2024 23:22:21

11AC40SISO Ant1 5310

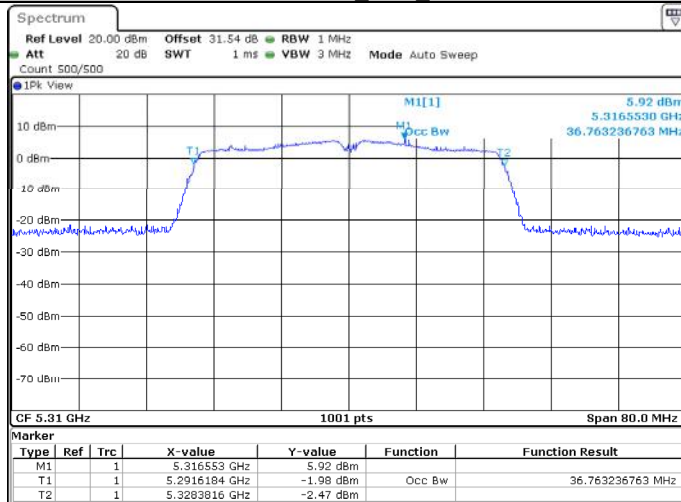

ProjectNo.:SZ1240109-02053E-RF Tester:Tom.Tan  
 Date: 12.MAR.2024 23:23:49

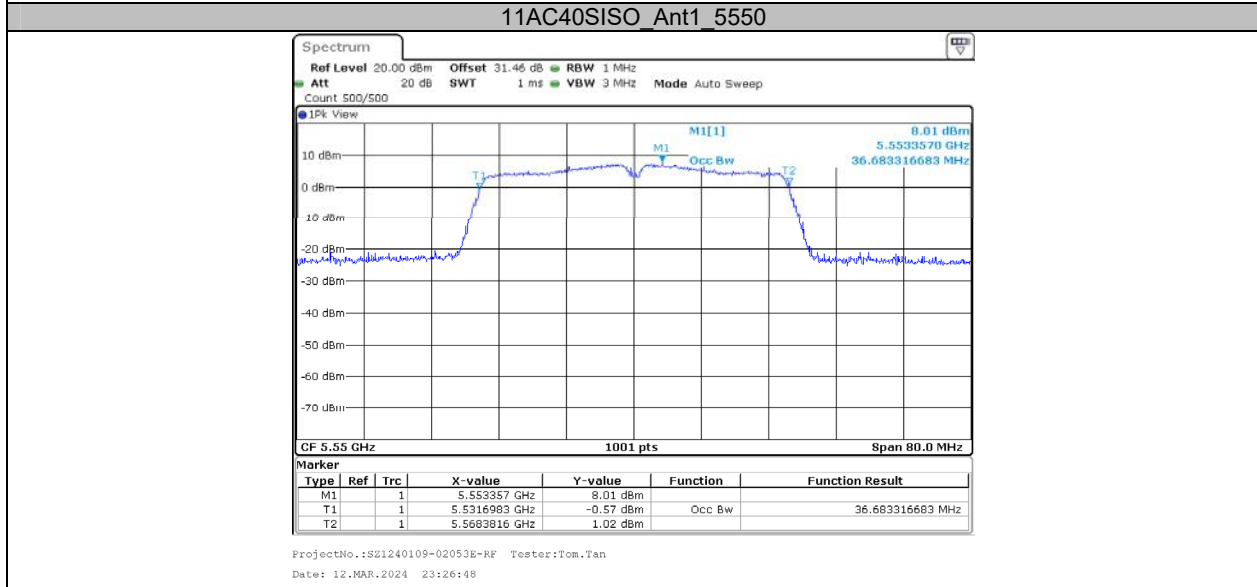
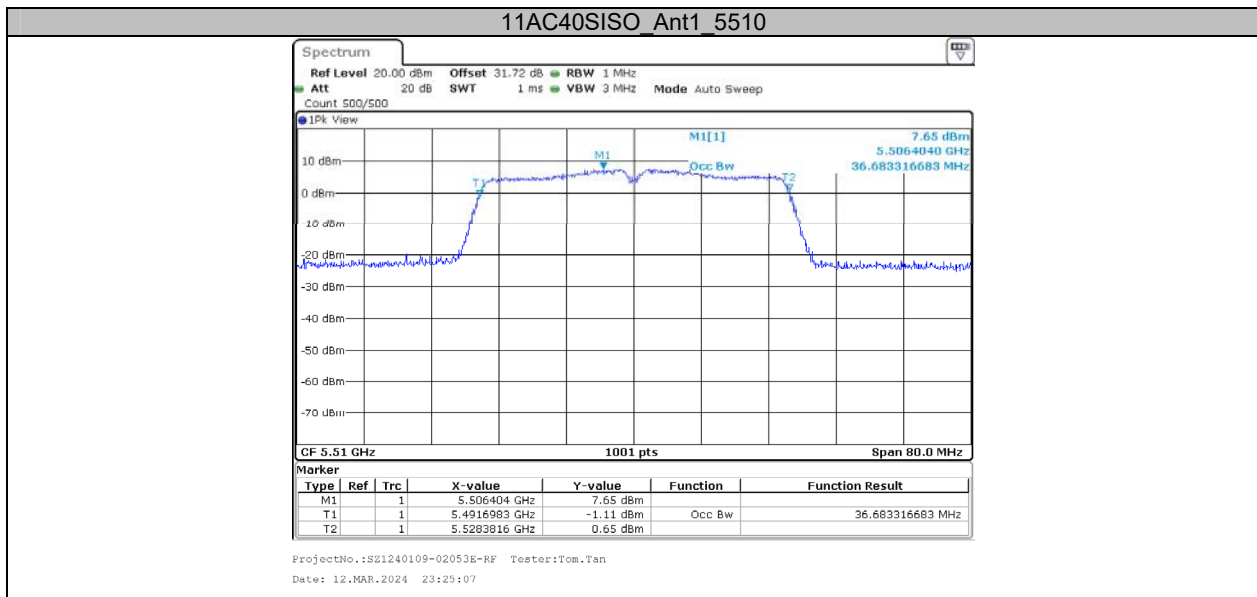

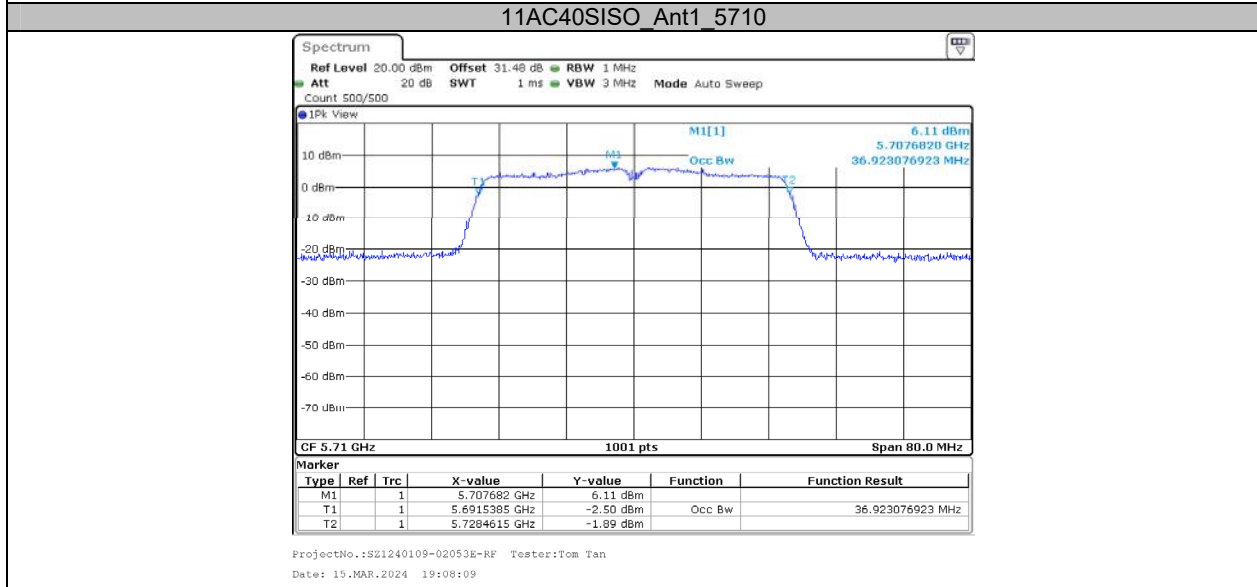
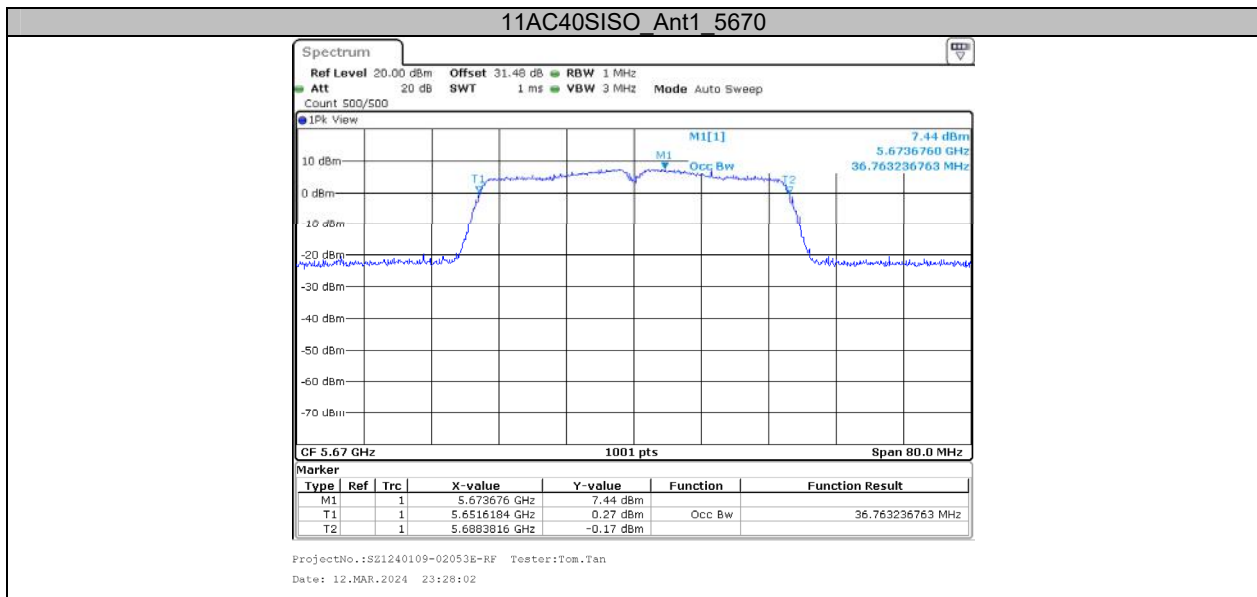

11AC40SISO Ant1\_5755



ProjectNo.:SZ1240109-02053E-RF Tester:Tom.Tan  
 Date: 12.MAR.2024 23:31:24

11AC40SISO Ant1\_5795

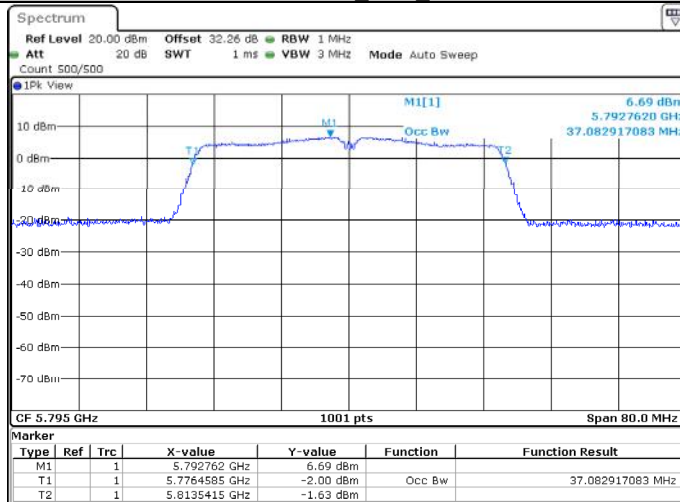

ProjectNo.:SZ1240109-02053E-RF Tester:Tom.Tan  
 Date: 12.MAR.2024 23:34:54

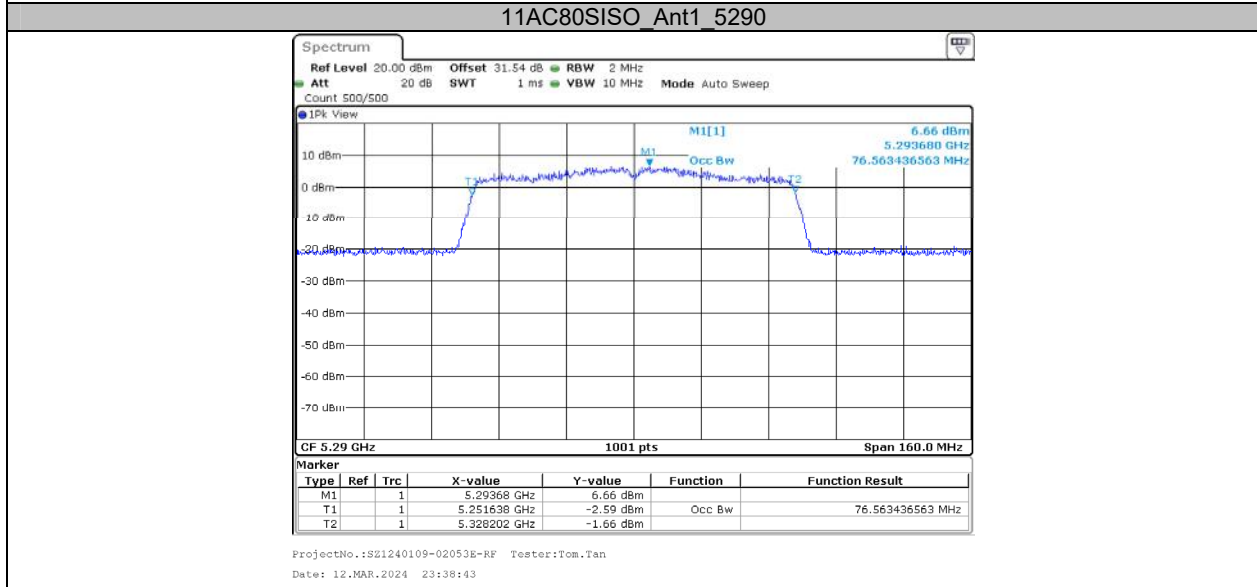
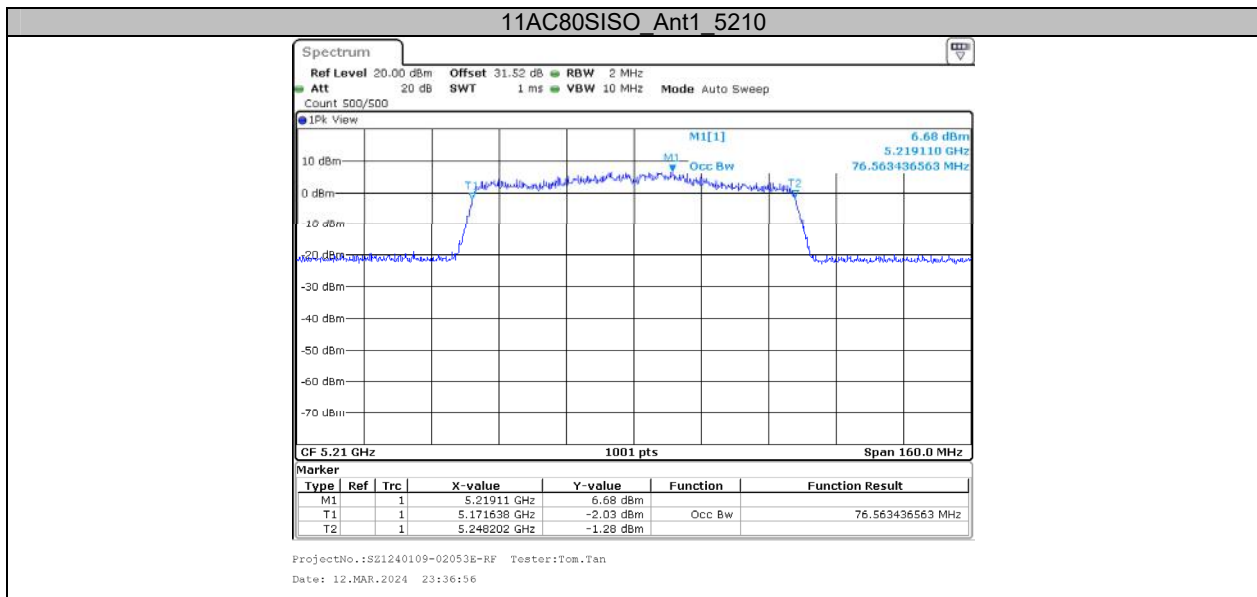

11AC80SISO Ant1 5530

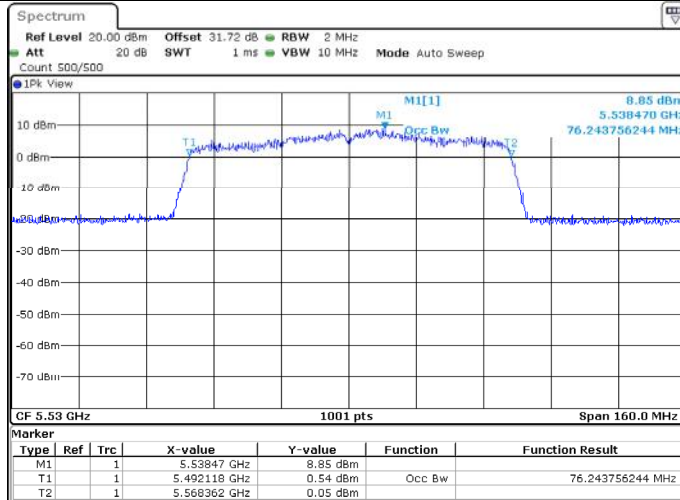

ProjectNo.:SZ1240109-02053E-RF Tester:Tom.Tan  
 Date: 12.MAR.2024 23:40:00

11AC80SISO Ant1 5690

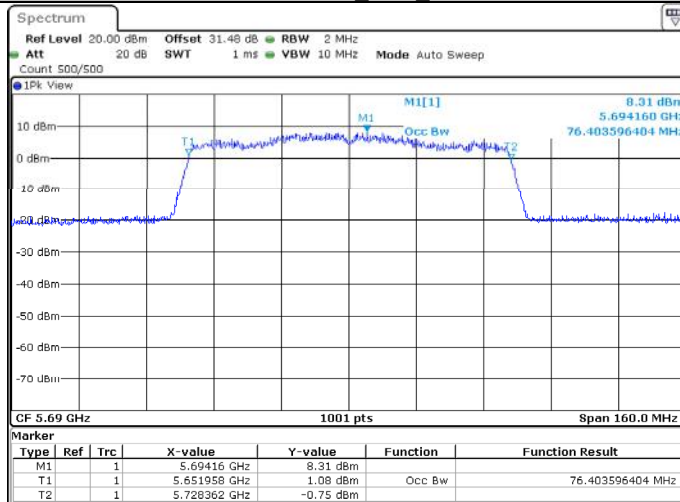

ProjectNo.:SZ1240109-02053E-RF Tester:Tom.Tan  
 Date: 19.MAR.2024 19:11:23

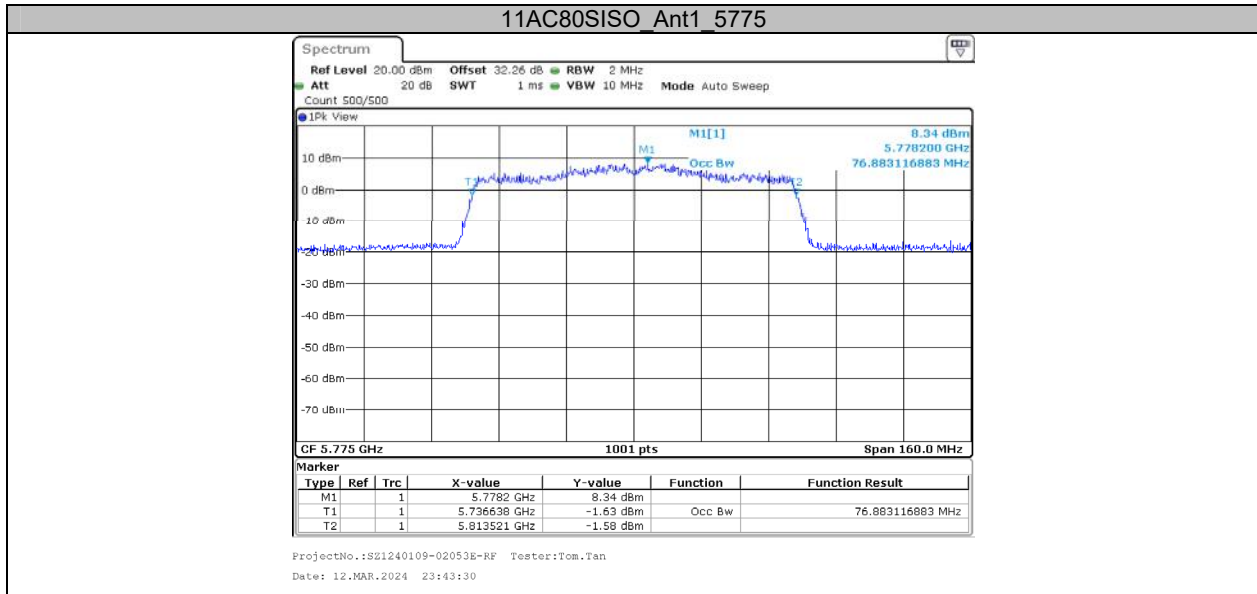



**Appendix A3: Min emission bandwidth  
Test Result**

Test Mode	Antenna	Frequency[MHz]	6db EBW [MHz]	Limit[MHz]	Verdict
11A	Ant1	5720	16.36	0.5	PASS
		5720 UNII-3	3.16	0.5	PASS
		5745	16.32	0.5	PASS
		5785	16.32	0.5	PASS
		5825	16.32	0.5	PASS
11AC20SISO	Ant1	5720	17.28	0.5	PASS
		5720 UNII-3	3.72	0.5	PASS
		5745	17.52	0.5	PASS
		5785	17.56	0.5	PASS
11AC40SISO	Ant1	5710	35.76	0.5	PASS
		5710 UNII-3	3.16	0.5	PASS
		5755	36.32	0.5	PASS
		5795	36.32	0.5	PASS
11AC80SISO	Ant1	5690	75.20	0.5	PASS
		5690 UNII-3	2.6	0.5	PASS
		5775	75.20	0.5	PASS

**Test Graphs**

