

Antenna Specification

Specifications Summary

ITEM	SPEC.	
	2.4GHz	
Center Frequency	2402 MHz	0.15dBi
	2442 MHz	0.29dBi
	2484 MHz	0.69dBi
MAX. GAIN	0.69dBi	

ITEM	SPEC.	
	5 GHz	
Center Frequency	5150 MHz	4.44dBi
	5300 MHz	4.05dBi
	5500 MHz	3.80dBi
	5800 MHz	5.10dBi
MAX. GAIN	5.10dBi	

天线类型/ ANT Type: FPC
 天线型号/ ANT Model: MP54E2ANTV10A
 制造商/ Manufacturer: YEALINK(XIAMEN) NETWORK TECHNOLOGY CO.,LTD. No.666 Hu'an Rd. Huli District Xiamen City, Fujian, P.R. China

Antenna Photo & Length

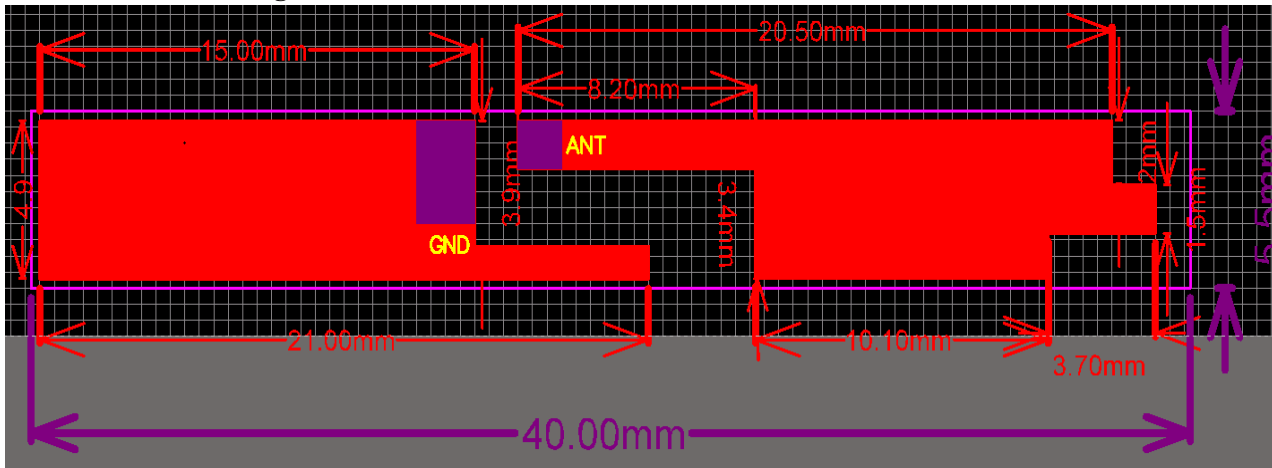

2402MHz

3D Antenna Pattern

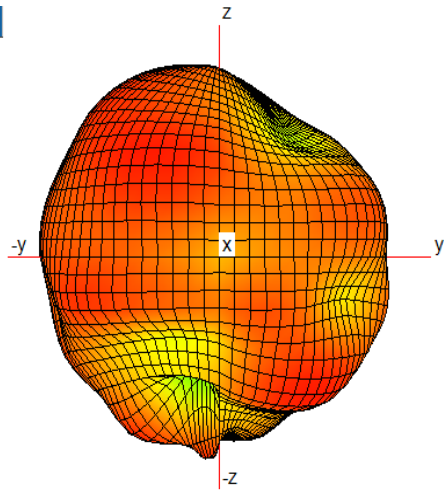

2D Antenna Pattern (X->Y;X->Z;Y->Z)

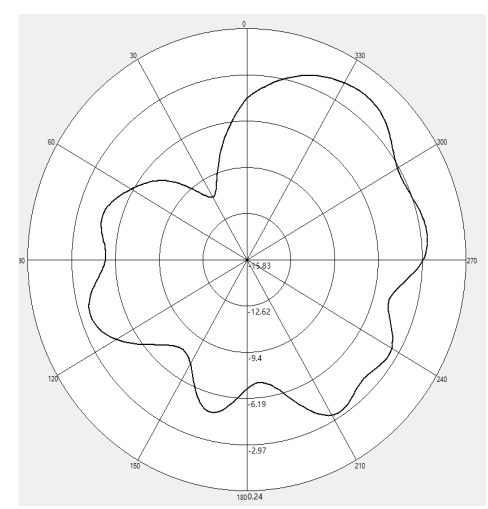
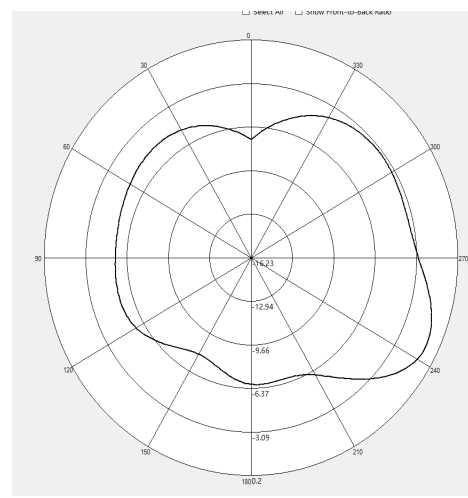
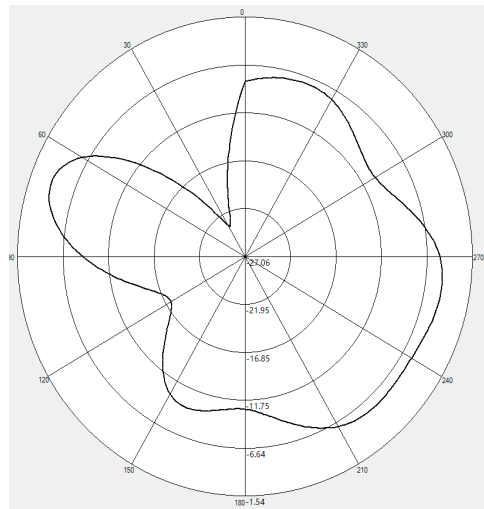

2442MHz

3D Antenna Pattern

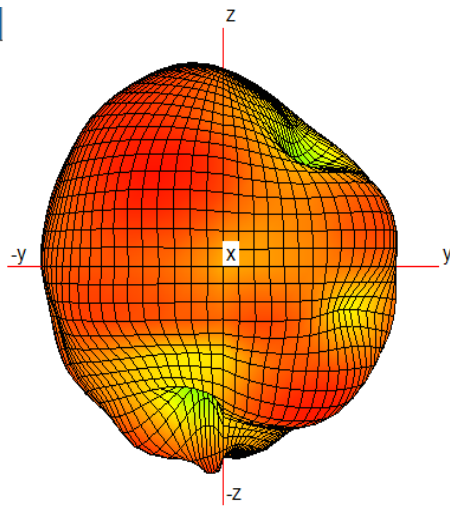

2D Antenna Pattern (X->Y;X->Z;Y->Z)

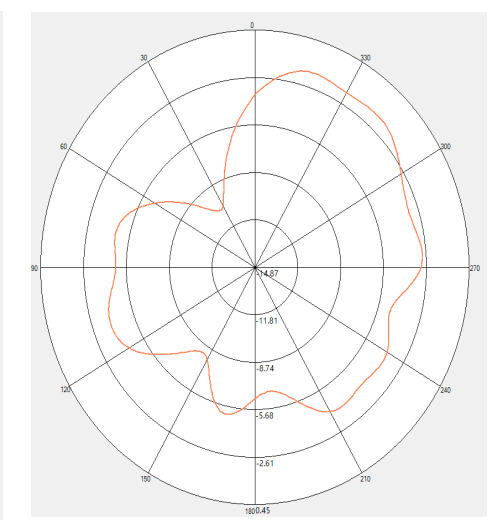
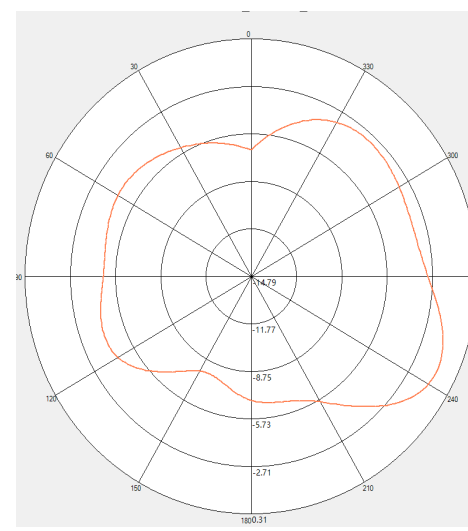
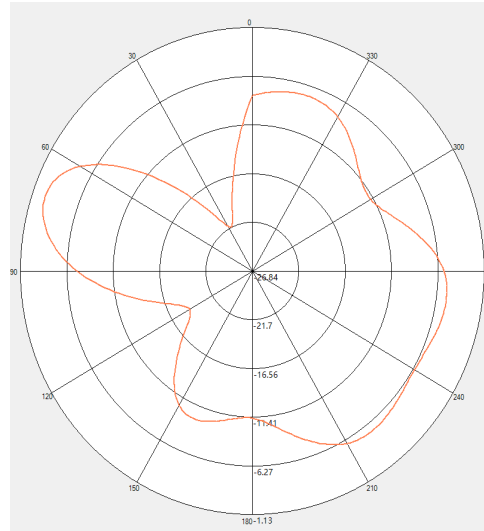

2484MHz

3D Antenna Pattern

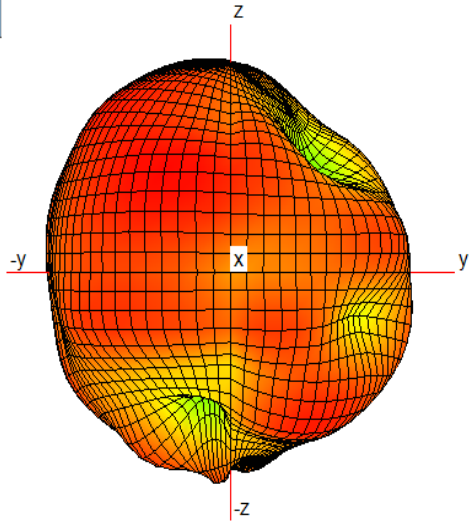

2D Antenna Pattern (X->Y;X->Z;Y->Z)

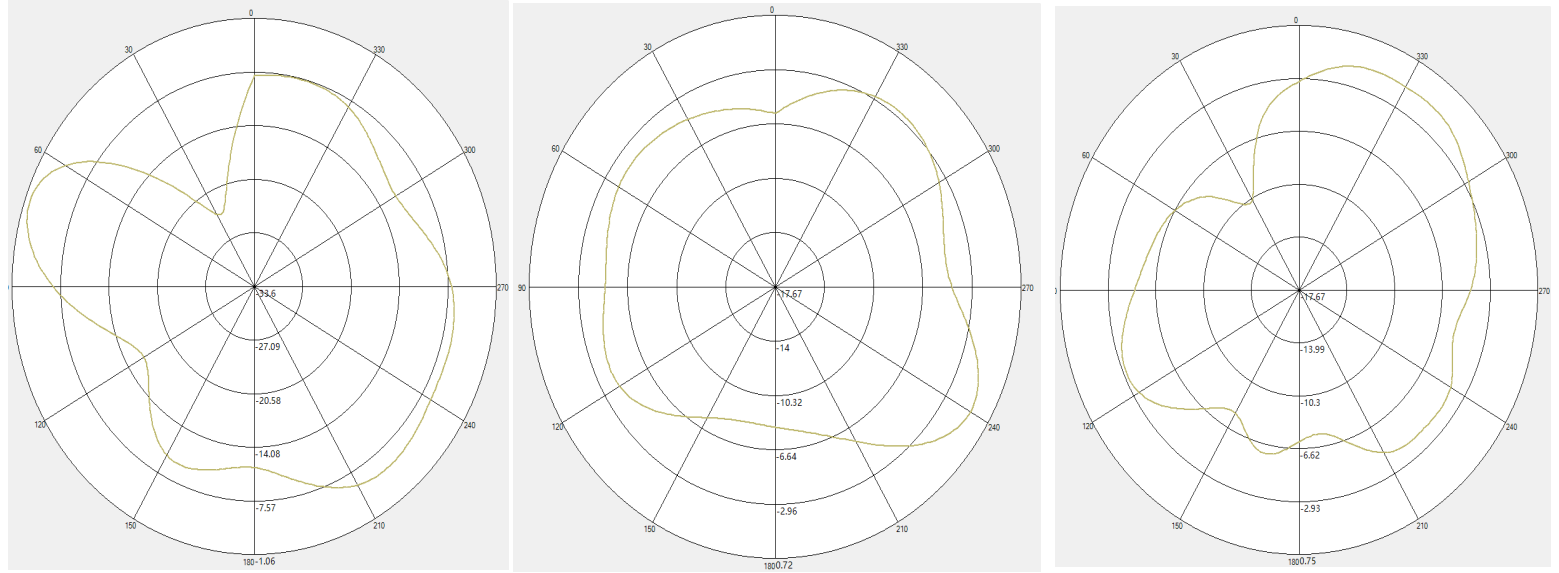

Point Values	Maximum Gain (dBi)
Frequency (MHz)	
2402	0.14958
2442	0.29364
2484	0.68851

5150MHz

3D Antenna Pattern

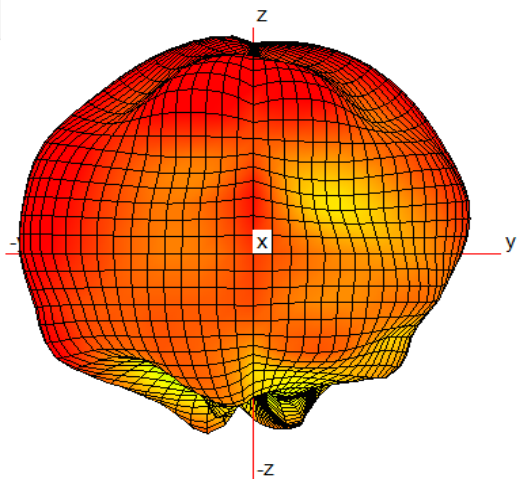

2D Antenna Pattern (X->Y;X->Z;Y->Z)

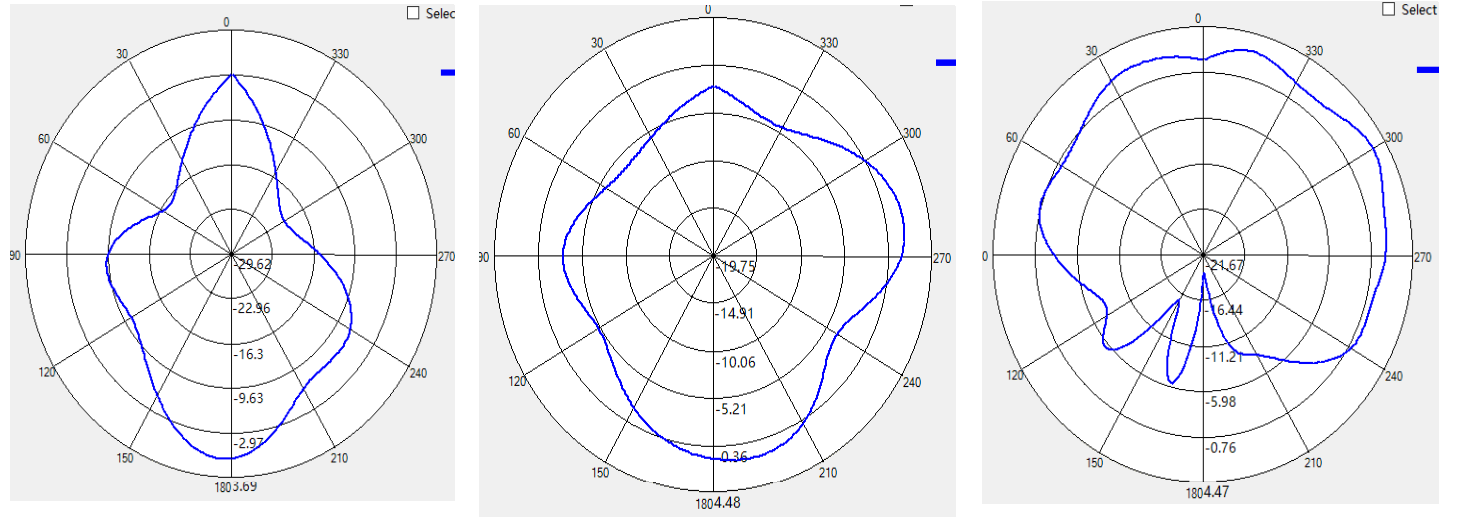

5300MHz

3D Antenna Pattern

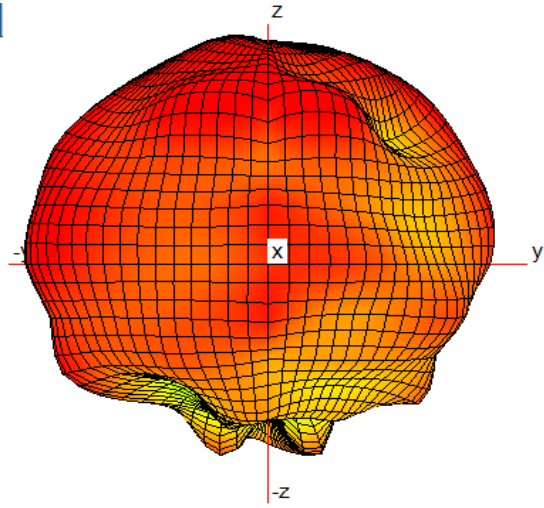

2D Antenna Pattern (X->Y;X->Z;Y->Z)

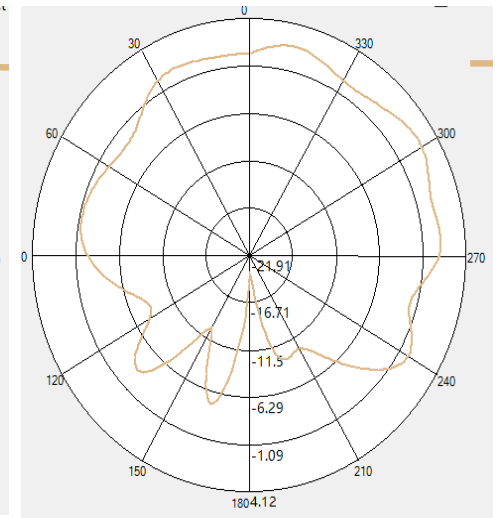
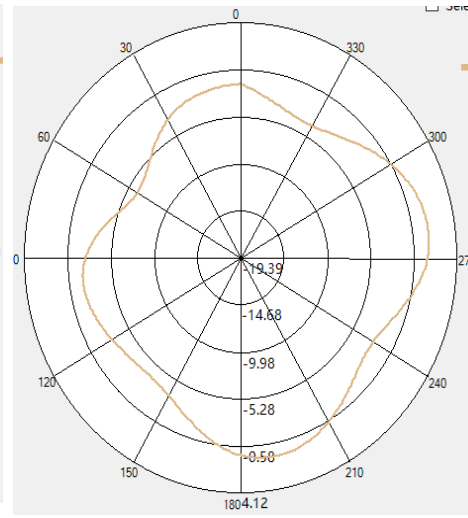
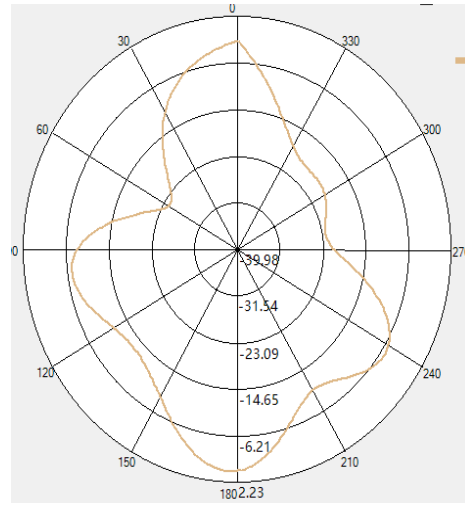

5500MHz

3D Antenna Pattern

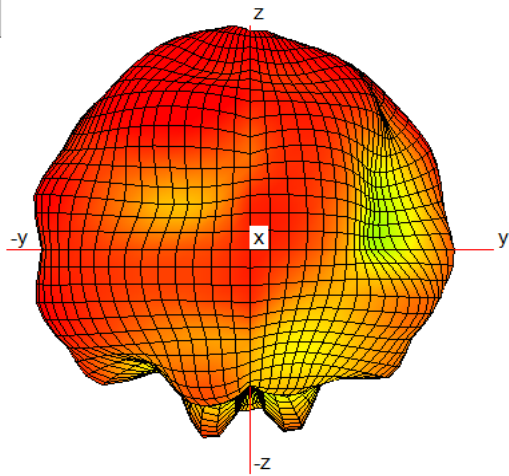

2D Antenna Pattern (X->Y;X->Z;Y->Z)

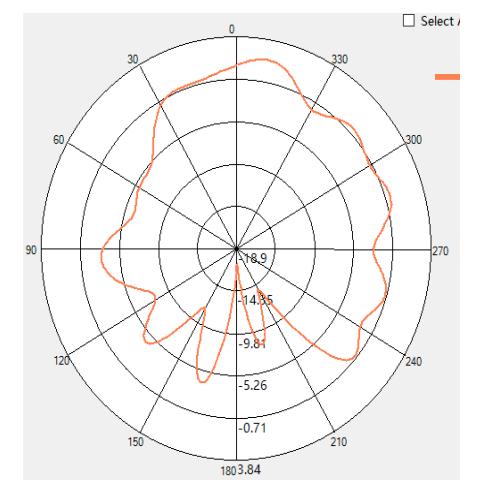
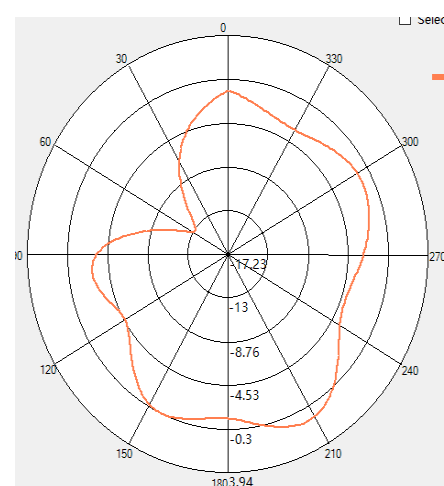
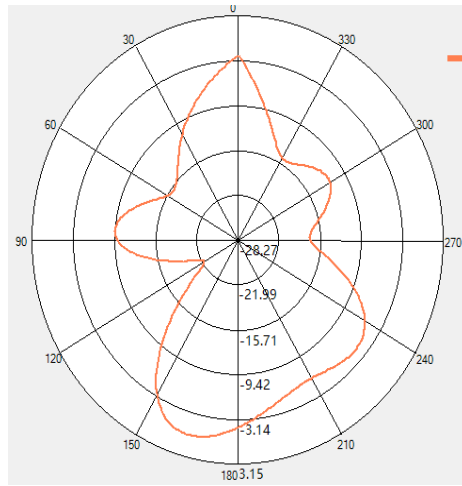

5800MHz

3D Antenna Pattern

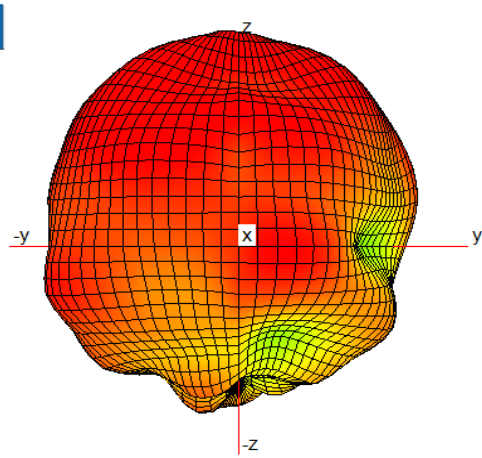

2D Antenna Pattern (X->Y;X->Z;Y->Z)

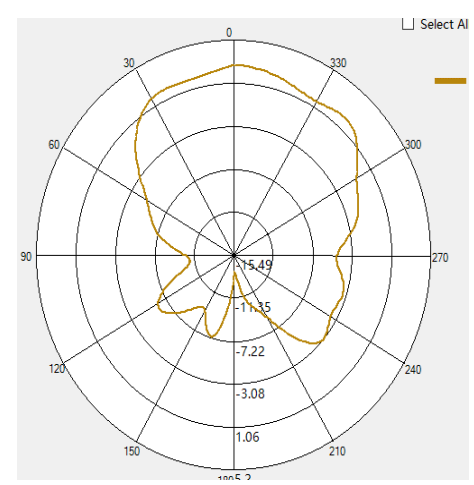
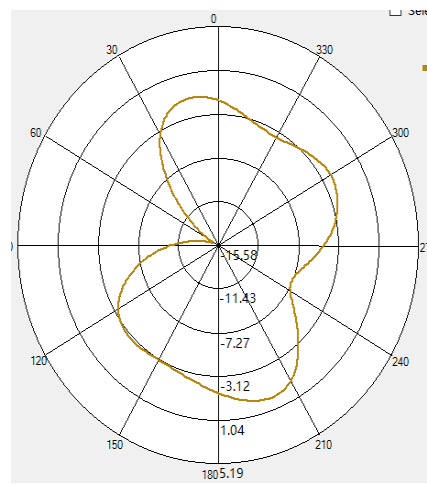
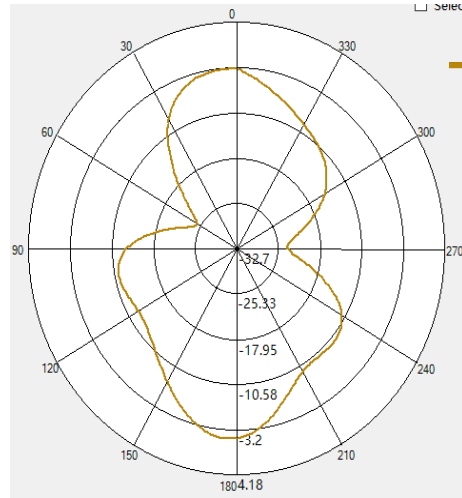

Point Values	Maximum Gain (dBi)
Frequency (MHz)	
5150	4.43906
5300	4.04663
5500	3.79532
5800	5.10284