

FCC Test Report

Report No.: RWAY202300002A

Applicant: YEALINK(XIAMEN) NETWORK TECHNOLOGY CO.,LTD.

Address: No.666 Hu'an Rd. Huli District Xiamen City, Fujian, P.R. China

Product Name: Bluetooth USB Dongle

Product Model: BT51C

Multiple Models: N/A

Trade Mark: Yealink

FCC ID: T2C-BT51CV1

Standards: FCC CFR Title 47 Part 15C (§15.247)

Test Date: 2023-11-14 to 2023-11-16

Test Result: Complied

Report Date: 2023-11-27

Reviewed by:

Abel chen

Approved by:

Jacob Gong

Abel Chen

Project Engineer

Jacob Kong

Manager

Prepared by:

World Alliance Testing and Certification (Shenzhen) Co., Ltd

No. 1002, East Block, Laobing Building, Xingye Road 3012, Xixiang street, Bao'an District, Shenzhen,
Guangdong, People's Republic of China



This report may contain data that are not covered by the NVLAP accreditation and shall be marked with an asterisk “★”

Announcement

1. This test report shall not be reproduced in full or partial, without the written approval of World Alliance Testing and Certification (Shenzhen) Co., Ltd
2. The results in this report apply only to the sample tested.
3. This sample tested is in compliance with the limits of the above regulation.
4. This report must not be used by the client to claim product certification, approval, or endorsement by NVLAP, NIST, or any agency of the U.S. Government.
5. The information marked “#” is provided by the applicant, the laboratory is not responsible for its authenticity and this information can affect the validity of the result in the test report. Customer model name, addresses, names, trademarks etc. are included.

Revision History

Version No.	Issued Date	Description
00	2023-11-27	Original

Contents

1	General Information	4
1.1	Client Information	4
1.2	Product Description of EUT	4
1.3	Antenna information	4
1.4	Related Submittal(s)/Grant(s).....	5
1.5	Measurement Uncertainty	5
1.6	Laboratory Location.....	5
1.7	Test Methodology	5
2	Description of Measurement.....	6
2.1	Test Configuration.....	6
2.2	Test Auxiliary Equipment	6
2.3	Test Setup.....	7
2.4	Test Procedure	9
2.5	Measurement Method.....	10
2.6	Measurement Equipment	10
3	Test Results	12
3.1	Test Summary.....	12
3.2	Limit	13
3.3	AC Line Conducted Emissions Test Data.....	14
3.4	Radiated emission Test Data.....	16
3.5	RF Conducted Test Data	24
3.5.1	20 dB Emission Bandwidth and 99% Occupied Bandwidth.....	24
3.5.2	Maximum Conducted Peak Output Power.....	24
3.5.3	Channel separation	25
3.5.4	Number of hopping Frequency	25
3.5.5	Time of occupancy (dwell time).....	25
3.5.6	100 kHz Bandwidth of Frequency Band Edge	26
4	Test Setup Photo.....	38
5	E.U.T Photo.....	39

1 General Information

1.1 Client Information

Applicant:	YEALINK(XIAMEN) NETWORK TECHNOLOGY CO.,LTD.
Address:	No.666 Hu'an Rd. Huli District Xiamen City, Fujian, P.R. China
Manufacturer:	YEALINK(XIAMEN) NETWORK TECHNOLOGY CO.,LTD.
Address:	No.666 Hu'an Rd. Huli District Xiamen City, Fujian, P.R. China

1.2 Product Description of EUT

The EUT is Bluetooth USB Dongle that contains classic Bluetooth(BDR/EDR) radio, this report covers the full testing of the classic Bluetooth(BDR/EDR) radio.

Sample Serial Number	2ACQ-1 for CE&RE test, 2ACQ-2 for RF test conducted test (assigned by WATC)
Sample Received Date	2023-11-11
Sample Status	Good Condition
Frequency Range	2402MHz - 2480MHz
Maximum Conducted Peak Output Power	12.14dBm
Modulation Technology	GFSK, $\pi/4$ DQPSK, 8DPSK
Antenna Gain [#]	2.28dBi
Spatial Streams	SISO (1TX, 1RX)
Power Supply	DC 5.0V
Operating temperature [#]	-10 deg.C to +50 deg.C
Adapter Information	N/A
Modification	Sample No Modification by the test lab

1.3 Antenna information

<p>15.203 requirement:</p> <p>An intentional radiator shall be designed to ensure that no antenna other than that furnished by the responsible party shall be used with the device. The use of a permanently attached antenna or of an antenna that uses a unique coupling to the intentional radiator, the manufacturer may design the unit so that a broken antenna can be replaced by the user, but the use of a standard antenna jack or electrical connector is prohibited.</p>	
<p>Device Antenna information:</p>	
<p>The BLE antenna is an internal antenna which cannot replace by end-user. Please see product internal photos for details.</p>	

1.4 Related Submittal(s)/Grant(s)

No related submittal(s)/Grant(s)

1.5 Measurement Uncertainty

Parameter	Expanded Uncertainty (Confidence of 95%(U = 2Uc(y)))	
AC Power Lines Conducted Emissions	±3.14dB	
Emissions, Radiated	Below 30MHz	±2.78dB
	Below 1GHz	±4.84dB
	Above 1GHz	±5.44dB
Emissions, Conducted	1.75dB	
Conducted Power	0.74dB	
Frequency Error	150Hz	
Bandwidth	0.34%	
Power Spectral Density	0.74dB	

Note: The extended uncertainty given in this report is obtained by combining the standard uncertainty times the coverage factor K with the 95% confidence interval. Otherwise required by the applicant or Product Regulations, Decision Rule in this report did not consider the uncertainty.

1.6 Laboratory Location

<p>World Alliance Testing and Certification (Shenzhen) Co., Ltd No. 1002, East Block, Laobing Building, Xingye Road 3012, Xixiang street, Bao'an District, Shenzhen, Guangdong, People's Republic of China Tel: +86-755-29691511, Email: qa@watc.com.cn</p> <p>The lab has been recognized as the FCC accredited lab under the KDB 974614 D01 and is listed in the FCC Public Access Link (PAL) database, FCC Registration No. : 463912, the FCC Designation No. : CN5040.</p> <p>The lab has been recognized by Innovation, Science and Economic Development Canada to test to Canadian radio equipment requirements, the CAB identifier: CN0160.</p>
--

1.7 Test Methodology

FCC CFR 47 Part 2

FCC CFR 47 Part 15

KDB 558074 D01 DTS Meas Guidance v05r02

ANSI C63.10-2020

2 Description of Measurement

2.1 Test Configuration

Operating channels:					
Channel No.	Frequency (MHz)	Channel No.	Frequency (MHz)	Channel No.	Frequency (MHz)
0	2402	39	2441	76	2478
1	2403	40	2442	77	2479
...	78	2480
38	2440	/	/

According to ANSI C63.10-2020 chapter 5.6.1 Table 11 requirement, select lowest channel, middle channel, and highest channel in the frequency range in which device operates for testing. The detailed frequency points are as follows:

Lowest channel		Middle channel		Highest channel	
Channel No.	Frequency (MHz)	Channel No.	Frequency (MHz)	Channel No.	Frequency (MHz)
0	2402	39	2441	78	2480

Test Mode:					
Transmitting mode:		Keep the EUT in continuous transmitting with modulation			
Exercise software [#] :		Airoha_Tool_Kit.exe			
Mode	Data rate	Powel Level Setting [#]			
		Low Channel	Middle Channel	High Channel	
GFSK	1Mbps	63	63	63	
$\pi/4$ DQPSK	2Mbps	63	63	63	
8DPSK	3Mbps	63	63	63	

The exercise software and the maximum power setting that provided by manufacturer.

Worst-Case Configuration:	
For radiated emissions, EUT was investigated in three orthogonal orientation, the worst-case orientation was recorded in report	
For AC power line conducted emission and radiated emission 9kHz-1GHz and above 18GHz were performed with the EUT transmits at the channel with highest output power as worst-case scenario.	

2.2 Test Auxiliary Equipment

Manufacturer	Description	Model	Serial Number
/	Laptop	/	/

2.3 Test Setup

1) Conducted emission measurement:

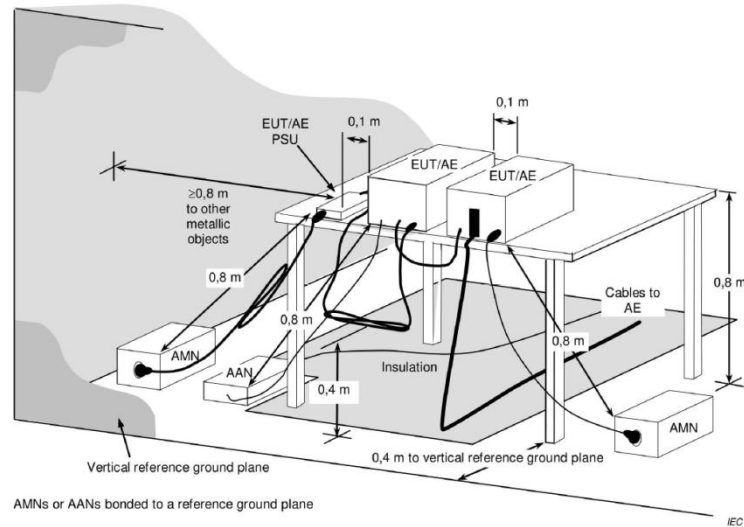

Note: The 0.8 m distance specified between EUT/AE/PSU and AMN/AAN, is applicable only to the EUT being measured. If the device is AE then it shall be >0.8 m.

2) Radiated emission measurement:

Below 30MHz (3m SAC)

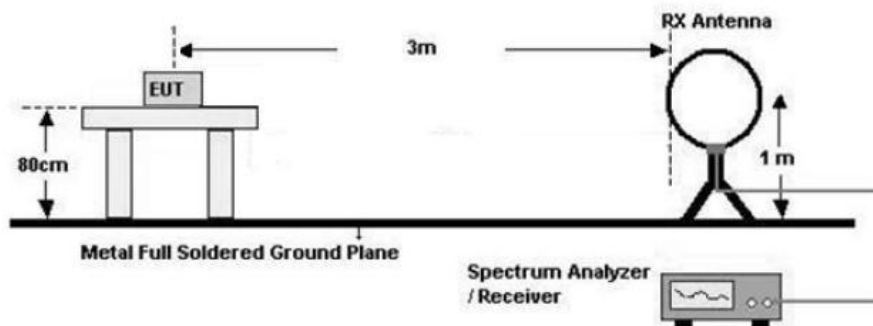

30MHz-1GHz (3m SAC)

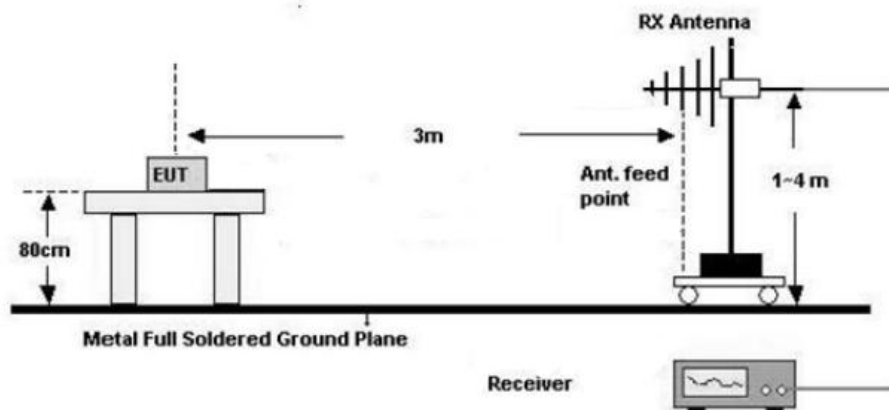

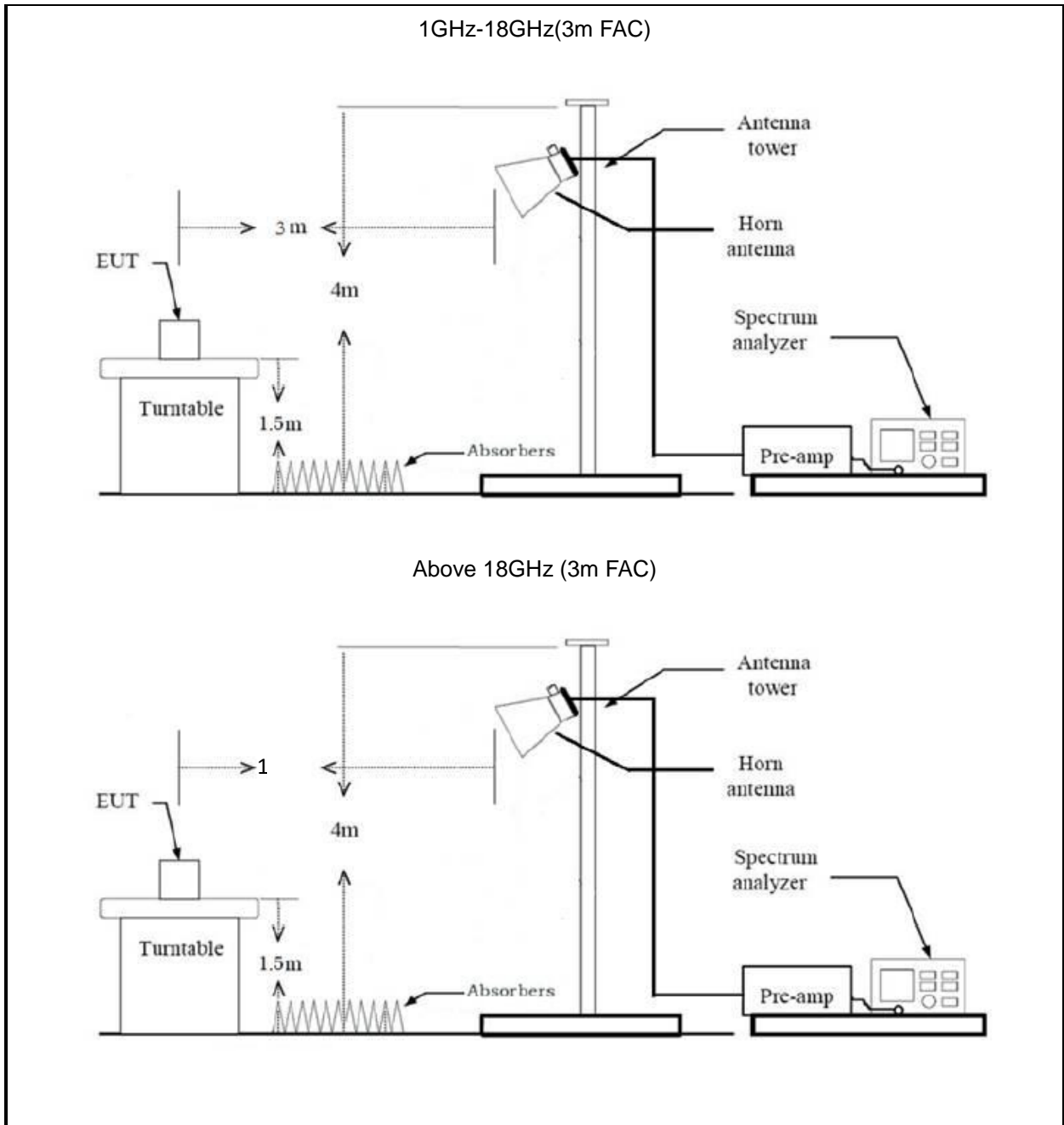

3) RF Conducted Test

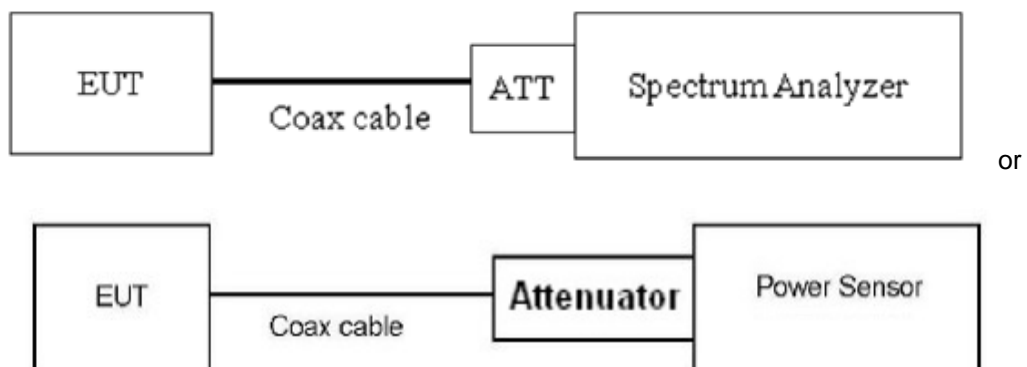

2.4 Test Procedure

Conducted emission:

1. The E.U.T is placed on a non-conducting table 40cm from the vertical ground plane and 80cm above the horizontal ground plane (Please refer to the block diagram of the test setup and photographs).
2. Both sides of A.C. line are checked for maximum conducted interference. In order to find the maximum emission, the relative positions of equipment and all of the interface cables must be changed according to ANSI C63.10 on conducted measurement.
3. Line conducted data is recorded for both Line and Neutral

Radiated Emission Procedure:

a) For below 30MHz

1. All measurements were made at a test distance of 3 m. The measured data was extrapolated from the test distance (3m) to the specification distance (300 m from 9-490 kHz and 30 m from 490 kHz- 30 MHz) to clearly show the relative levels of fundamental and spurious emissions and demonstrate compliance with the requirement that the level of any spurious emissions be below the level of the intentionally transmitted signal. The extrapolation factor for the limits were $40 \cdot \log(\text{test distance} / \text{specification distance})$.
2. Loop antenna use, investigation was done on the three antenna orientations (parallel, perpendicular, ground-parallel)

b) For 30MHz-1GHz:

1. The EUT was placed on the tabletop of a rotating table 0.8 m the ground at a 3 m semi anechoic chamber. The measurement distance from the EUT to the receiving antenna is 3 m.
2. EUT works in each mode of operation that needs to be tested. The highest signal levels relative to the limit shall be determined by rotating the EUT from 0° to 360° and with varying the measurement antenna height between 1 m and 4 m in vertical and horizontal polarizations.

c) For above 1GHz:

1. The EUT was placed on the tabletop of a rotating table 1.5 m the ground at a 3 m fully anechoic room. The measurement distance from the EUT to the receiving antenna is 3 m (1-18GHz) and 1.5 m (above 18GHz).
2. EUT works in each mode of operation that needs to be tested, and having the EUT continuously working. The highest signal levels relative to the limit shall be determined by rotating the EUT from 0° to 360° and with varying the measurement antenna height between 1 m and 4 m in vertical and horizontal polarizations.
3. Open the test software to control the test antenna and test turntable. Perform the test, save the test results, and export the test data.
4. Base on FCC 15.31 (f) (2): measurements may be performed at a distance closer than that specified in the regulations; however, an attempt should be made to avoid making measurements in the near field.

RF Conducted Test:

1. The antenna port of EUT was connected to the RF port of the test equipment (Power Meter or

- Spectrum analyzer) through Attenuator and RF cable.
2. The cable assembly insertion loss of 7.0dB (including 6.0 dB Attenuator and 1.0 dB cable) was entered as an offset in the power meter. Note: Actual cable loss was unavailable at the time of testing, therefore a loss of 1.0dB was assumed as worst case. This was later verified to be true by laboratory. (if the RF cable provided by client, the cable loss declared by client)
 3. The EUT is keeping in continuous transmission mode and tested in all modulation modes.

2.5 Measurement Method

Description of Test	Measurement Method
AC Line Conducted Emissions	ANSI C63.10-2020 Section 6.2
Maximum Conducted Output Power	ANSI C63.10-2020 Section 7.8.5
20 dB Emission Bandwidth	ANSI C63.10-2020 Section 6.9.2
99% Occupied Bandwidth	ANSI C63.10-2020 Section 6.9.3
Channel separation	ANSI C63.10-2020 Section 7.8.2
Number of hopping Frequency	ANSI C63.10-2020 Section 7.8.3
Time of occupancy (dwell time)	ANSI C63.10-2020 Section 7.8.4
100kHz Bandwidth of Frequency Band Edge	ANSI C63.10-2020 Section 7.8.7.2&6.10
Radiated emission	ANSI C63.10-2020 Section 7.8&6.3&6.4&6.5&6.6

2.6 Measurement Equipment

Manufacturer	Description	Model	Management No.	Calibration Date	Calibration Due Date
AC Line Conducted Emission Test					
ROHDE& SCHWARZ	EMI TEST RECEIVER	ESR	101817	2023/7/3	2024/7/2
R&S	LISN	ENV216	101748	2023/7/3	2024/7/2
N/A	Coaxial Cable	NO.12	N/A	2023/7/3	2024/7/2
Farad	Test Software	EZ-EMC	Ver. EMEC-3A1	/	/
Radiated Emission Test					
R&S	EMI test receiver	ESR3	102758	2023/7/3	2024/7/2
ROHDE& SCHWARZ	SPECTRUM ANALYZER	FSV40-N	101608	2023/7/3	2024/7/2
SONOMA	Low frequency	310	186014	2023/7/12	2024/7/11

INSTRUMENT	amplifier				
COM-POWER	preamplifier	PAM-118A	18040152	2023/8/21	2024/8/20
COM-POWER	Amplifier	PAM-840A	461306	2023/8/8	2024/8/7
ETS	Passive Loop Antenna	6512	29604	2023/7/7	2024/7/6
SCHWARZBECK	Log - periodic wideband antenna	VULB 9163	9163-872	2023/7/7	2024/7/6
Astro Antenna Ltd	Horn antenna	AHA-118S	3015	2023/7/6	2024/7/5
Ducommun technologies	Horn Antenna	ARH-4223-02	1007726-03	2023/7/10	2024/7/9
Oulitong	Band Reject Filter	OBSF-2400-248 3.5-50N	OE02103119	2023/9/15	2024/9/14
N/A	Coaxial Cable	N/A	NO.9	2023/8/8	2024/8/7
N/A	Coaxial Cable	N/A	NO.10	2023/8/8	2024/8/7
N/A	Coaxial Cable	N/A	NO.11	2023/8/8	2024/8/7
Audix	Test Software	E3	191218 V9	/	/
RF Conducted Test					
ROHDE& SCHWARZ	SPECTRUM ANALYZER	FSU-26	200680/026	2023/7/12	2024/7/11
ANRITSU	USB Power Sensor	MA24418A	12620	2023/7/12	2024/7/11
narda	6dB attenuator	603-06-1	N/A	2023/7/26	2024/7/25

Note: All equipment is calibrated with valid calibrations. Each measurement data is traceable to the national or International standards.

3 Test Results

3.1 Test Summary

FCC Rules	Description of Test	Result
§15.203	Antenna Requirement	Compliance
§15.207 (a)	AC Line Conducted Emissions	Compliance
§15.247 (a)(1)	20dB Emission Bandwidth	Report only
-	99% Occupied Bandwidth	Report only
§15.247 (a)(1)	Channel separation	Compliance
§15.247 (a)(1)(iii)	Number of hopping Frequency	Compliance
§15.247 (a)(1)(iii)	Time of occupancy (dwell time)	Compliance
§15.247(b)(1)	Maximum Conducted Output Power	Compliance
§15.247(d)	100kHz Bandwidth of Frequency Band Edge	Compliance
§15.205, §15.209, §15.247(d)	Radiated emission	Compliance

3.2 Limit

Test items	Limit
AC Line Conducted Emissions	See details §15.207 (a)
Conducted Output Power	For frequency hopping systems operating in the 2400–2483.5 MHz band employing at least 75 non-overlapping hopping channels, and all frequency hopping systems in the 5725–5850 MHz band: 1 watt. For all other frequency hopping systems in the 2400–2483.5 MHz band: 0.125 watts.
Channel separation	Frequency hopping systems shall have hopping channel carrier frequencies separated by a minimum of 25 kHz or the 20 dB bandwidth of the hopping channel, whichever is greater. Alternatively, frequency hopping systems operating in the 2400–2483.5 MHz band may have hopping channel carrier frequencies that are separated by 25 kHz or two-thirds of the 20 dB bandwidth of the hopping channel, whichever is greater, provided the systems operate with an output power no greater than 125 mW.
Number of hopping Frequency	Frequency hopping systems in the 2400–2483.5 MHz band shall use at least 15 channels.
Time of occupancy (dwell time)	The average time of occupancy on any channel shall not be greater than 0.4 seconds within a period of 0.4 seconds multiplied by the number of hopping channels employed.
Spurious Emissions, 100kHz Bandwidth of Frequency Band Edge	In any 100 kHz bandwidth outside the frequency band in which the spread spectrum or digitally modulated intentional radiator is operating, the radio frequency power that is produced by the intentional radiator shall be at least 20 dB below that in the 100 kHz bandwidth within the band that contains the highest level of the desired power, based on either an RF conducted or a radiated measurement, provided the transmitter demonstrates compliance with the peak conducted power limits. If the transmitter complies with the conducted power limits based on the use of RMS averaging over a time interval, as permitted under paragraph (b)(3) of this section, the attenuation required under this paragraph shall be 30 dB instead of 20 dB. Attenuation below the general limits specified in §15.209(a) is not required. In addition, radiated emissions which fall in the restricted bands, as defined in §15.205(a), must also comply with the radiated emission limits specified in §15.209(a) (see §15.205(c)).

3.3 AC Line Conducted Emissions Test Data

Test Date:	2023-11-15	Test By:	Lirou Li
Environment condition:	Temperature: 26.3°C; Relative Humidity:48%; ATM Pressure: 100.5kPa		

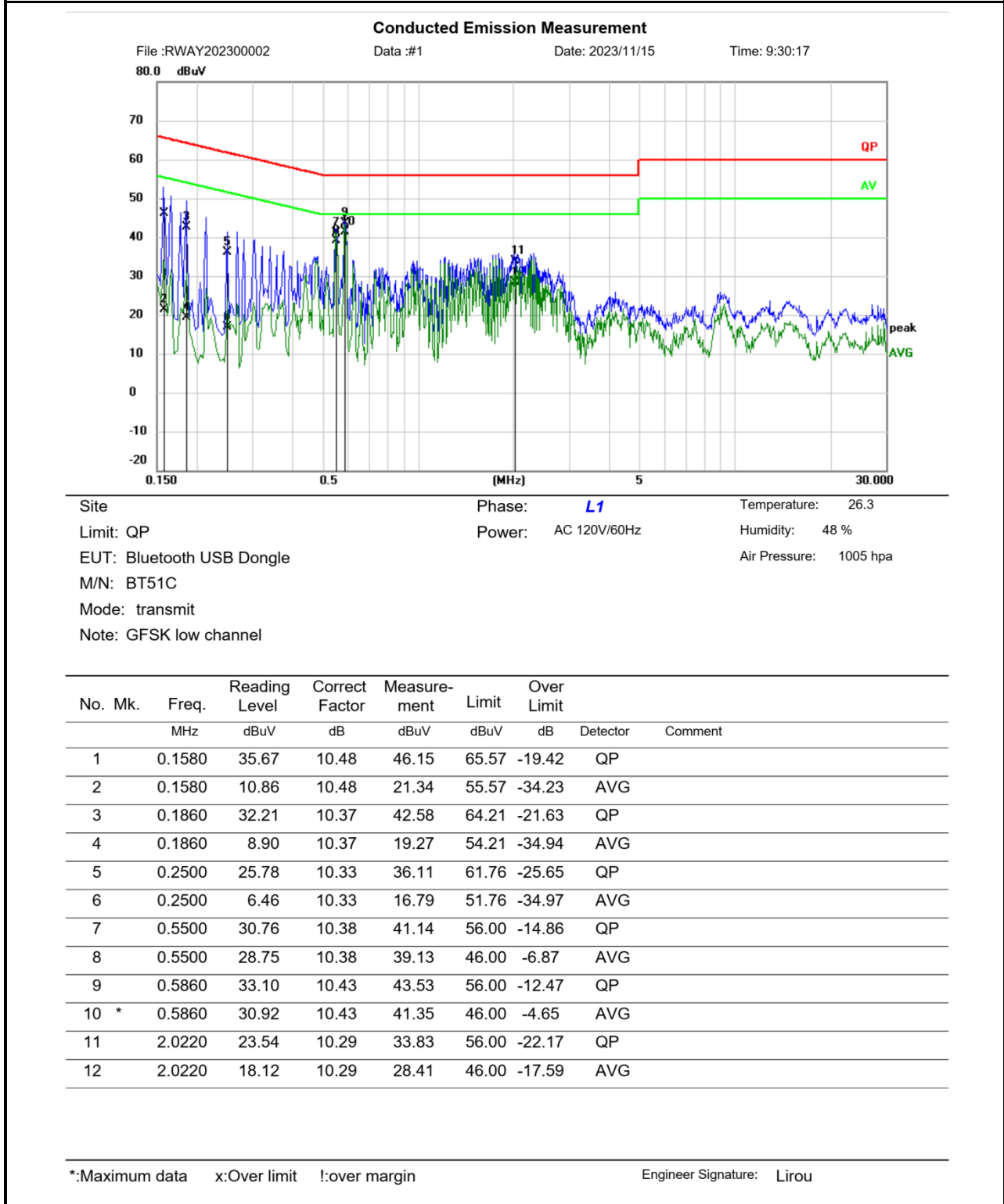

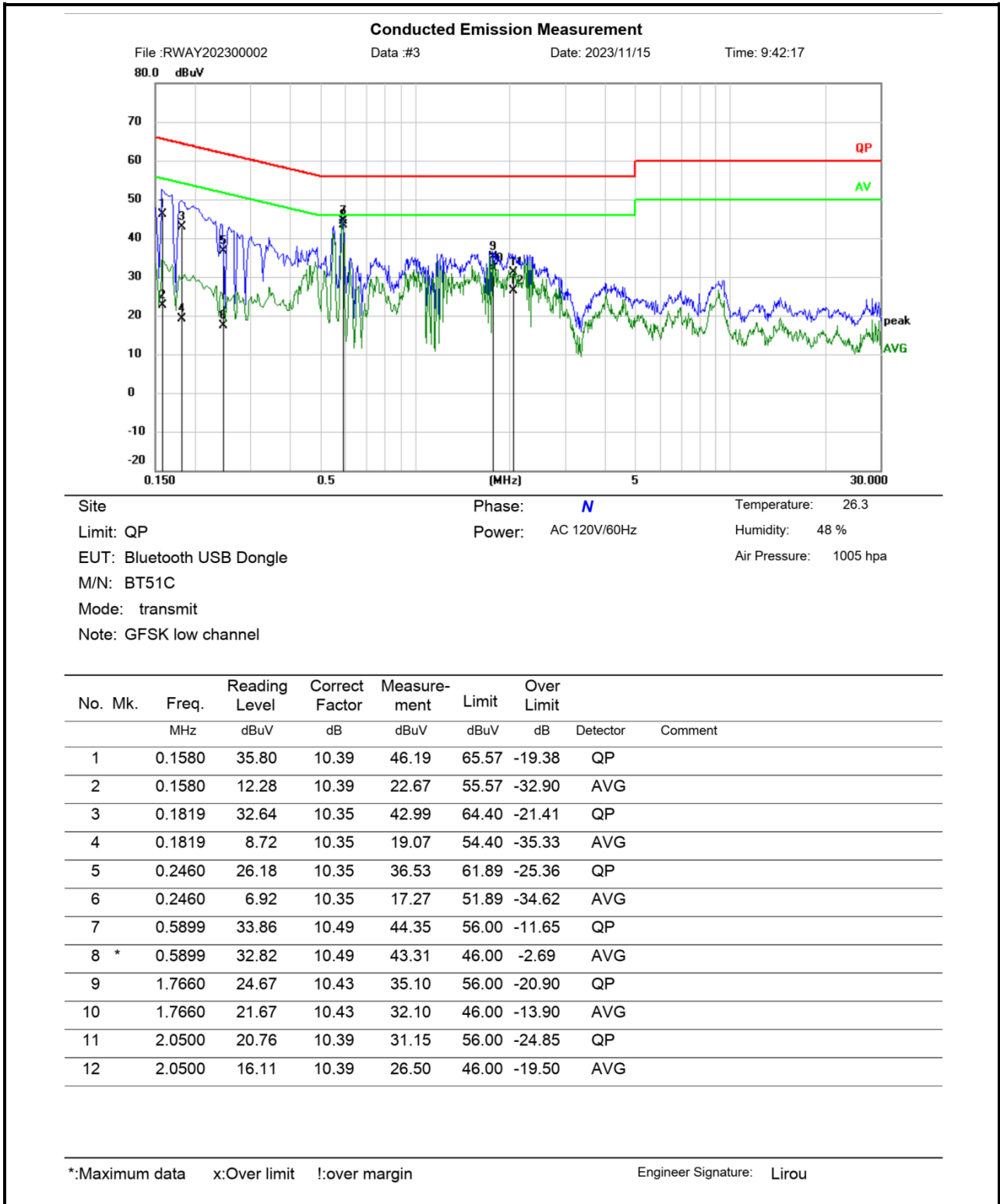

Remark:

Measurement (dBuV)= Reading Level (dBuV) + Correct Factor(dB)

Correct Factor(dB)= LISN Voltage Division Factor (dB)+ Cable loss(dB)

Over = Measurement – Limit

3.4 Radiated emission Test Data

9 kHz-30MHz:

Test Date:	2023-11-15	Test By:	Luke Li
Environment condition:	Temperature: 24°C; Relative Humidity:51%; ATM Pressure: 101kPa		

For radiated emissions below 30MHz, there were no emissions found within 20dB of limit.

30MHz-1GHz:

Test Date:	2023-11-15	Test By:	Luke Li
Environment condition:	Temperature: 24°C; Relative Humidity:51%; ATM Pressure: 101kPa		

EUT/Model No.: BT51C
 Test Mode : Transmitting
 Test Voltage : DC 5V
 Environment : 24°C/51%/1010hPa
 Tested by : Luke Li
 Polarization : horizontal
 Remark : GFSK Low Channel

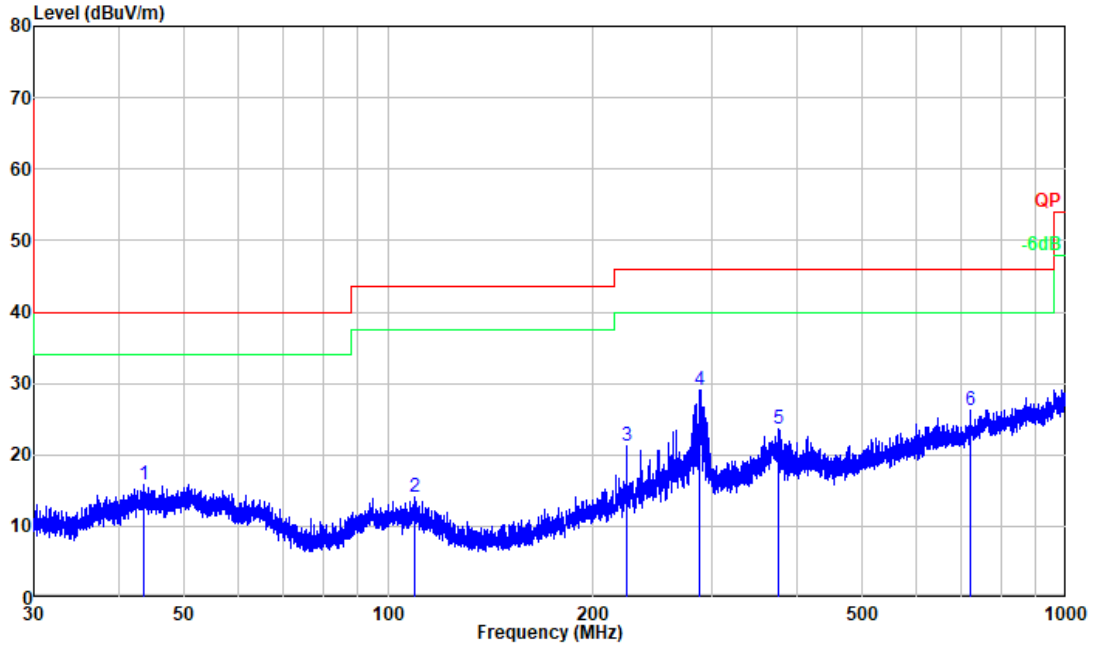

--No.	Frequency (MHz)	Reading (dBμV)	Factor (dB/m)	Result (dBμV/m)	Limit (dBμV/m)	Margin (dB)	Detector
1	43.622	27.93	-12.11	15.82	40.00	24.18	Peak
2	109.094	27.87	-13.86	14.01	43.50	29.49	Peak
3	225.069	34.29	-13.11	21.18	46.00	24.82	Peak
4	287.567	40.41	-11.40	29.01	46.00	16.99	Peak
5	375.728	32.68	-9.04	23.64	46.00	22.36	Peak
6	721.380	29.35	-3.02	26.33	46.00	19.67	Peak

Remarks: Factor = Antenna factor + Cable loss - Preamp gain

EUT/Model No.: BT51C
 Test Mode : Transmitting
 Test Voltage : DC 5V
 Environment : 24°C/51%/1010hPa
 Tested by : Luke Li
 Polarization : vertical
 Remark : GFSK Low Channel

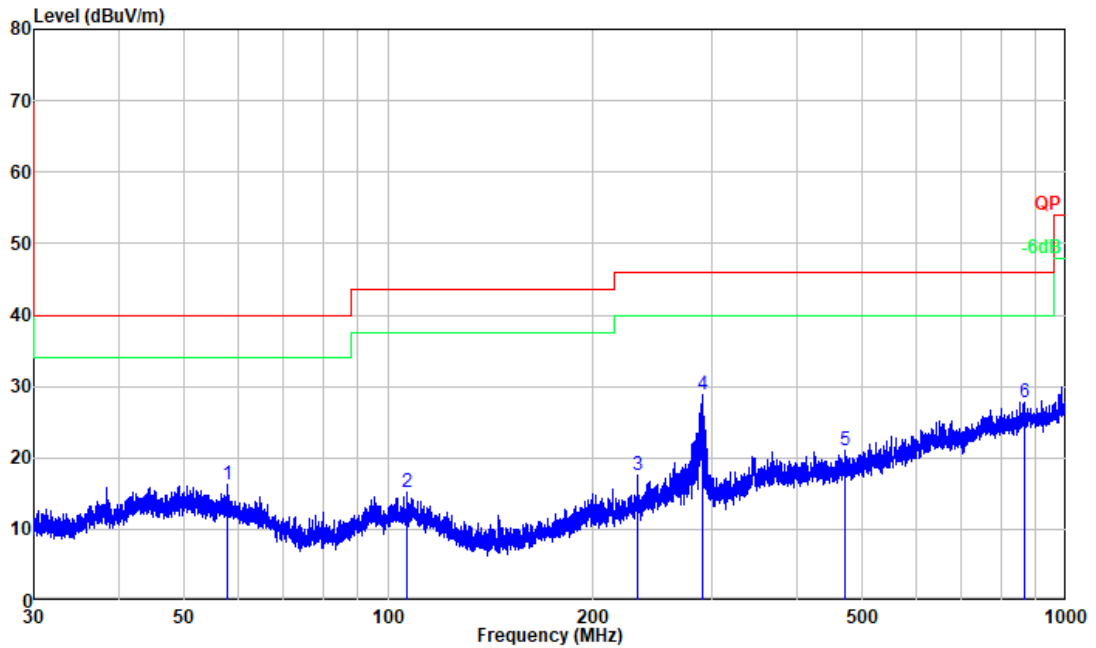

--No.	Frequency (MHz)	Reading (dBμV)	Factor (dB/m)	Result (dBμV/m)	Limit (dBμV/m)	Margin (dB)	Detector
1	57.902	29.32	-13.01	16.31	40.00	23.69	Peak
2	106.682	28.88	-13.74	15.14	43.50	28.36	Peak
3	233.409	30.30	-12.67	17.63	46.00	28.37	Peak
4	291.374	40.21	-11.32	28.89	46.00	17.11	Peak
5	472.339	28.50	-7.52	20.98	46.00	25.02	Peak
6	868.734	28.60	-0.86	27.74	46.00	18.26	Peak

Remarks: Factor = Antenna factor + Cable loss - Preamp gain

Remark:

Level = Reading + Factor

Factor = Antenna factor + Cable loss – Amplifier gain

Over Limit = Level – Limit

Above 1GHz:

Test Date:	2023-11-15	Test By:	Luke Li
Environment condition:	Temperature: 24°C; Relative Humidity:51%; ATM Pressure: 101kPa		

Frequency (MHz)	Reading level (dB μ V)	Polar	Corrected Factor (dB/m)	Corrected Amplitude (dB μ V/m)	Limit (dB μ V/m)	Margin (dB)	Remark
GFSK							
Low Channel							
2390.000	36.02	horizontal	7.55	43.57	54.00	-10.43	Average
2390.000	48.05	horizontal	7.55	55.60	74.00	-18.40	Peak
2390.000	35.80	vertical	7.55	43.35	54.00	-10.65	Average
2390.000	49.84	vertical	7.55	57.39	74.00	-16.61	Peak
4804.000	39.27	horizontal	-0.29	38.98	54.00	-15.02	Average
4804.000	47.66	horizontal	-0.29	47.37	74.00	-26.63	Peak
4804.000	37.73	vertical	-0.29	37.44	54.00	-16.56	Average
4804.000	47.65	vertical	-0.29	47.36	74.00	-26.64	Peak
Middle Channel							
4882.000	37.89	horizontal	0.13	38.02	54.00	-15.98	Average
4882.000	47.77	horizontal	0.13	47.90	74.00	-26.10	Peak
4882.000	36.54	vertical	0.13	36.67	54.00	-17.33	Average
4882.000	47.13	vertical	0.13	47.26	74.00	-26.74	Peak
High Channel							
2483.500	36.95	horizontal	7.57	44.52	54.00	-9.48	Average
2483.500	49.79	horizontal	7.57	57.36	74.00	-16.64	Peak
2483.500	36.19	vertical	7.57	43.76	54.00	-10.24	Average
2483.500	48.39	vertical	7.57	55.96	74.00	-18.04	Peak
4960.000	37.12	horizontal	0.45	37.57	54.00	-16.43	Average
4960.000	46.68	horizontal	0.45	47.13	74.00	-26.87	Peak
4960.000	36.11	vertical	0.45	36.56	54.00	-17.44	Average
4960.000	46.89	vertical	0.45	47.34	74.00	-26.66	Peak
$\pi/4$ DQPSK							
Low Channel							
2390.000	35.97	horizontal	7.55	43.52	54.00	-10.48	Average
2390.000	49.31	horizontal	7.55	56.86	74.00	-17.14	Peak
2390.000	36.05	vertical	7.55	43.60	54.00	-10.40	Average

2390.000	49.51	vertical	7.55	57.06	74.00	-16.94	Peak
4804.000	36.76	horizontal	-0.29	36.47	54.00	-17.53	Average
4804.000	47.38	horizontal	-0.29	47.09	74.00	-26.91	Peak
4804.000	36.58	vertical	-0.29	36.29	54.00	-17.71	Average
4804.000	48.23	vertical	-0.29	47.94	74.00	-26.06	Peak
Middle Channel							
4882.000	35.83	horizontal	0.13	35.96	54.00	-18.04	Average
4882.000	47.85	horizontal	0.13	47.98	74.00	-26.02	Peak
4882.000	36.19	vertical	0.13	36.32	54.00	-17.68	Average
4882.000	47.52	vertical	0.13	47.65	74.00	-26.35	Peak
High Channel							
2483.500	37.14	horizontal	7.57	44.71	54.00	-9.29	Average
2483.500	50.21	horizontal	7.57	57.78	74.00	-16.22	Peak
2483.500	36.94	vertical	7.57	44.51	54.00	-9.49	Average
2483.500	49.40	vertical	7.57	56.97	74.00	-17.03	Peak
4960.000	34.96	horizontal	0.45	35.41	54.00	-18.59	Average
4960.000	46.02	horizontal	0.45	46.47	74.00	-27.53	Peak
4960.000	35.89	vertical	0.45	36.34	54.00	-17.66	Average
4960.000	46.68	vertical	0.45	47.13	74.00	-26.87	Peak
8DPSK							
Low Channel							
2390.000	35.95	horizontal	7.55	43.50	54.00	-10.50	Average
2390.000	48.71	horizontal	7.55	56.26	74.00	-17.74	Peak
2390.000	36.42	vertical	7.55	43.97	54.00	-10.03	Average
2390.000	48.61	vertical	7.55	56.16	74.00	-17.84	Peak
4802.000	36.57	horizontal	-0.30	36.27	54.00	-17.73	Average
4802.000	47.58	horizontal	-0.30	47.28	74.00	-26.72	Peak
4802.000	36.12	vertical	-0.30	35.82	54.00	-18.18	Average
4802.000	47.27	vertical	-0.30	46.97	74.00	-27.03	Peak
Middle Channel							
4882.000	35.78	horizontal	0.13	35.91	54.00	-18.09	Average
4882.000	47.78	horizontal	0.13	47.91	74.00	-26.09	Peak

4882.000	35.96	vertical	0.13	36.09	54.00	-17.91	Average
4882.000	46.84	vertical	0.13	46.97	74.00	-27.03	Peak
High Channel							
2483.500	37.15	horizontal	7.57	44.72	54.00	-9.28	Average
2483.500	49.42	horizontal	7.57	56.99	74.00	-17.01	Peak
2483.500	36.67	vertical	7.57	44.24	54.00	-9.76	Average
2483.500	48.77	vertical	7.57	56.34	74.00	-17.66	Peak
4960.000	35.34	horizontal	0.45	35.79	54.00	-18.21	Average
4960.000	46.23	horizontal	0.45	46.68	74.00	-27.32	Peak
4960.000	35.67	vertical	0.45	36.12	54.00	-17.88	Average
4960.000	47.94	vertical	0.45	48.39	74.00	-25.61	Peak

Remark:

Corrected Amplitude= Reading level + corrected Factor

Corrected Factor = Antenna factor + Cable loss – Amplifier gain

Margin = Corrected Amplitude – Limit

The emission levels of other frequencies that were lower than the limit 20dB, not show in test report.

For emissions in 18GHz-25GHz range, all emissions were investigated and in the noise floor level.

Mode:	BLE 1M	Channel:	2402MHz
--------------	--------	-----------------	---------

EUT/Model No.: BT51C
 Test Mode : Transmitting
 Test Voltage : DC 5V
 Environment : 24°C/51%/1010hPa
 Tested by : Luke Li
 Polarization : horizontal
 Remark : GFSK Low channel

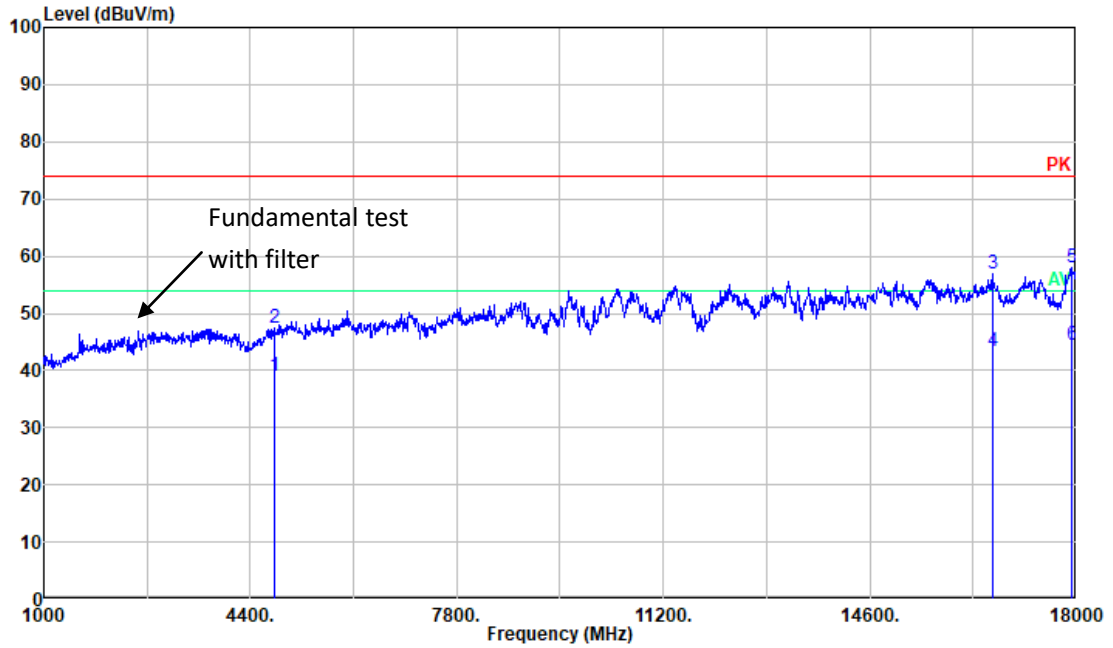

--No.	Frequency (MHz)	Reading (dBμV)	Factor (dB/m)	Result (dBμV/m)	Limit (dBμV/m)	Margin (dB)	Detector
1	4804.000	39.27	-0.29	38.98	54.00	15.02	Average
2	4804.000	47.66	-0.29	47.37	74.00	26.63	Peak
3	16613.810	48.30	8.56	56.86	74.00	17.14	Peak
4	16613.810	34.82	8.56	43.38	54.00	10.62	Average
5	17931.970	47.56	10.32	57.88	74.00	16.12	Peak
6	17931.970	34.23	10.32	44.55	54.00	9.45	Average

Remarks: Factor = Antenna factor + Cable loss - Preamp gain

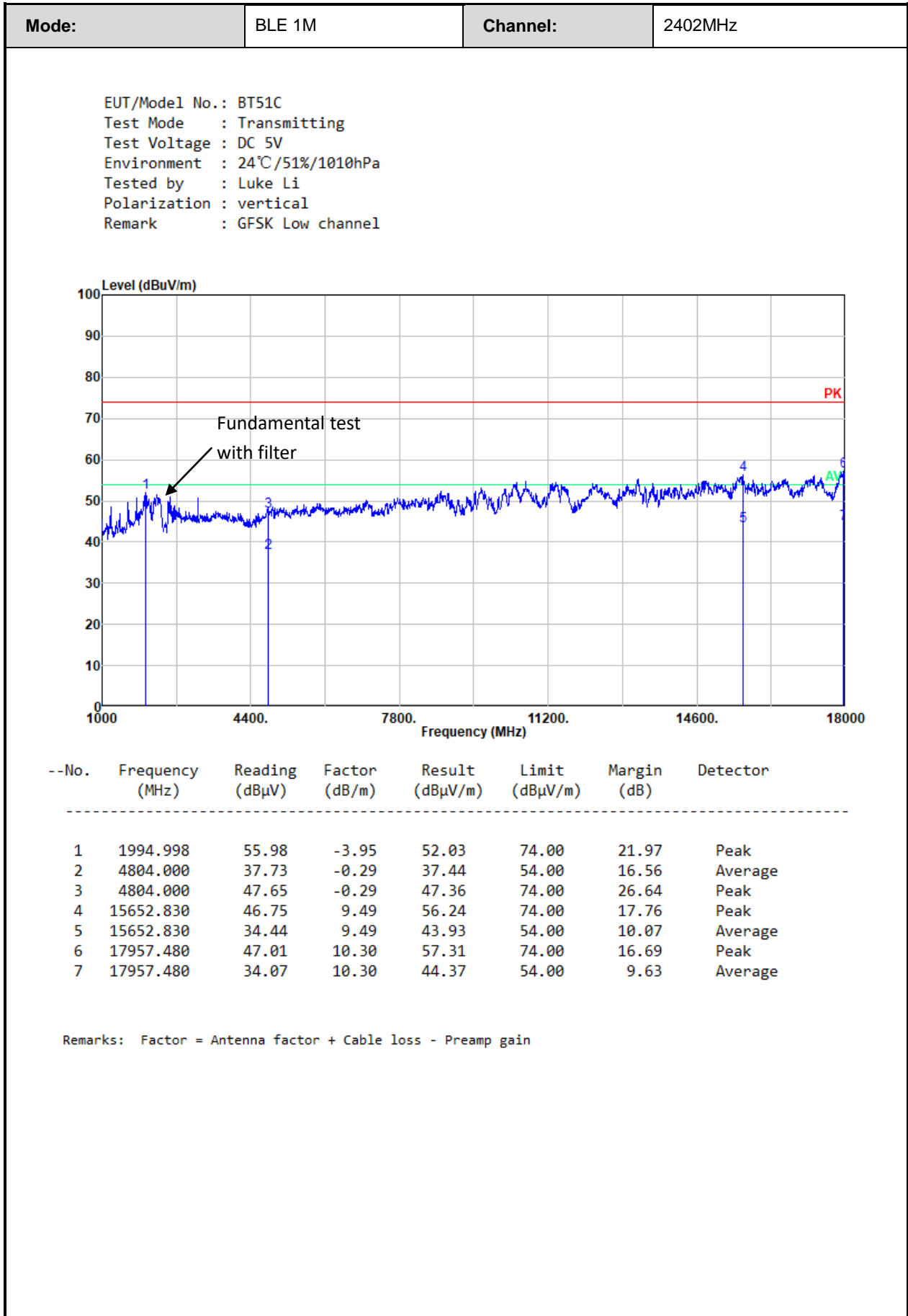

3.5 RF Conducted Test Data

Test Date:	2023-11-14	Test By:	Ryan Zhang
Environment condition:	Temperature: 23.5~24.8°C; Relative Humidity:51~62%; ATM Pressure: 101~103kPa		

3.5.1 20 dB Emission Bandwidth and 99% Occupied Bandwidth

Test Mode	Channel	20dB BW [MHz]	99% OBW[MHz]
GFSK	2402	0.974	0.894
	2441	0.974	0.891
	2480	0.974	0.891
$\pi/4$ DQPSK	2402	1.264	1.170
	2441	1.266	1.170
	2480	1.266	1.170
8DPSK	2402	1.280	1.174
	2441	1.294	1.174
	2480	1.294	1.174

3.5.2 Maximum Conducted Peak Output Power

Test Mode	Channel[MHz]	Result[dBm]	Limit[dBm]	Verdict
GFSK	2402	12.14	21	Pass
	2441	12.13	21	Pass
	2480	11.99	21	Pass
$\pi/4$ DQPSK	2402	12.09	21	Pass
	2441	12.11	21	Pass
	2480	11.98	21	Pass
8DPSK	2402	12.06	21	Pass
	2441	12.07	21	Pass
	2480	11.95	21	Pass

3.5.3 Channel separation

Test Mode	Channel[MHz]	Result[MHz]	Limit[MHz]	Verdict
GFSK	2402	1.000	0.649	Pass
	2441	1.000	0.649	Pass
	2480	1.005	0.649	Pass
π/4 DQPSK	2402	1.000	0.843	Pass
	2441	1.005	0.844	Pass
	2480	1.000	0.844	Pass
8DPSK	2402	1.000	0.853	Pass
	2441	1.005	0.863	Pass
	2480	1.000	0.863	Pass

Note: $Limit \leq 2/3 * 20dB BW$

3.5.4 Number of hopping Frequency

Test Mode	Frequency Range [MHz]	Number of hopping Frequency	Limit	Verdict
GFSK	2400-2483.5	79	≥15	Pass
π/4 DQPSK	2400-2483.5	79	≥15	Pass
8DPSK	2400-2483.5	79	≥15	Pass

3.5.5 Time of occupancy (dwell time)

Test Mode	Packet Type	Channel[MHz]	Pulse Time [ms]	Result[s]	Limit[s]	Verdict
GFSK	DH1	2402	0.399	0.128	0.400	Pass
	DH3	2441	1.675	0.268	0.400	Pass
	DH5	2480	2.923	0.312	0.400	Pass
π/4 DQPSK	2DH1	2402	0.404	0.129	0.400	Pass
	2DH3	2441	1.676	0.268	0.400	Pass
	2DH5	2480	2.925	0.312	0.400	Pass
8DPSK	3DH1	2402	0.404	0.129	0.400	Pass
	3DH3	2441	1.672	0.268	0.400	Pass
	3DH5	2480	2.933	0.313	0.400	Pass

Note:

DH1: Dwell time=Pulse time (ms) *(1600/2/79)*31.6s

DH3: Dwell time=Pulse time (ms) *(1600/4/79)*31.6s

DH5: Dwell time=Pulse time (ms) *(1600/6/79)*31.6s

3.5.6 100 kHz Bandwidth of Frequency Band Edge

Test Mode	Channel	Result	Limit	Verdict
GFSK	2402	Refer test plot	Refer test plot	Pass
	2480	Refer test plot	Refer test plot	Pass
$\pi/4$ DQPSK	2402	Refer test plot	Refer test plot	Pass
	2480	Refer test plot	Refer test plot	Pass
8DPSK	2402	Refer test plot	Refer test plot	Pass
	2480	Refer test plot	Refer test plot	Pass

Test Plots:

20 dB Emission Bandwidth & 99% Occupied Bandwidth:

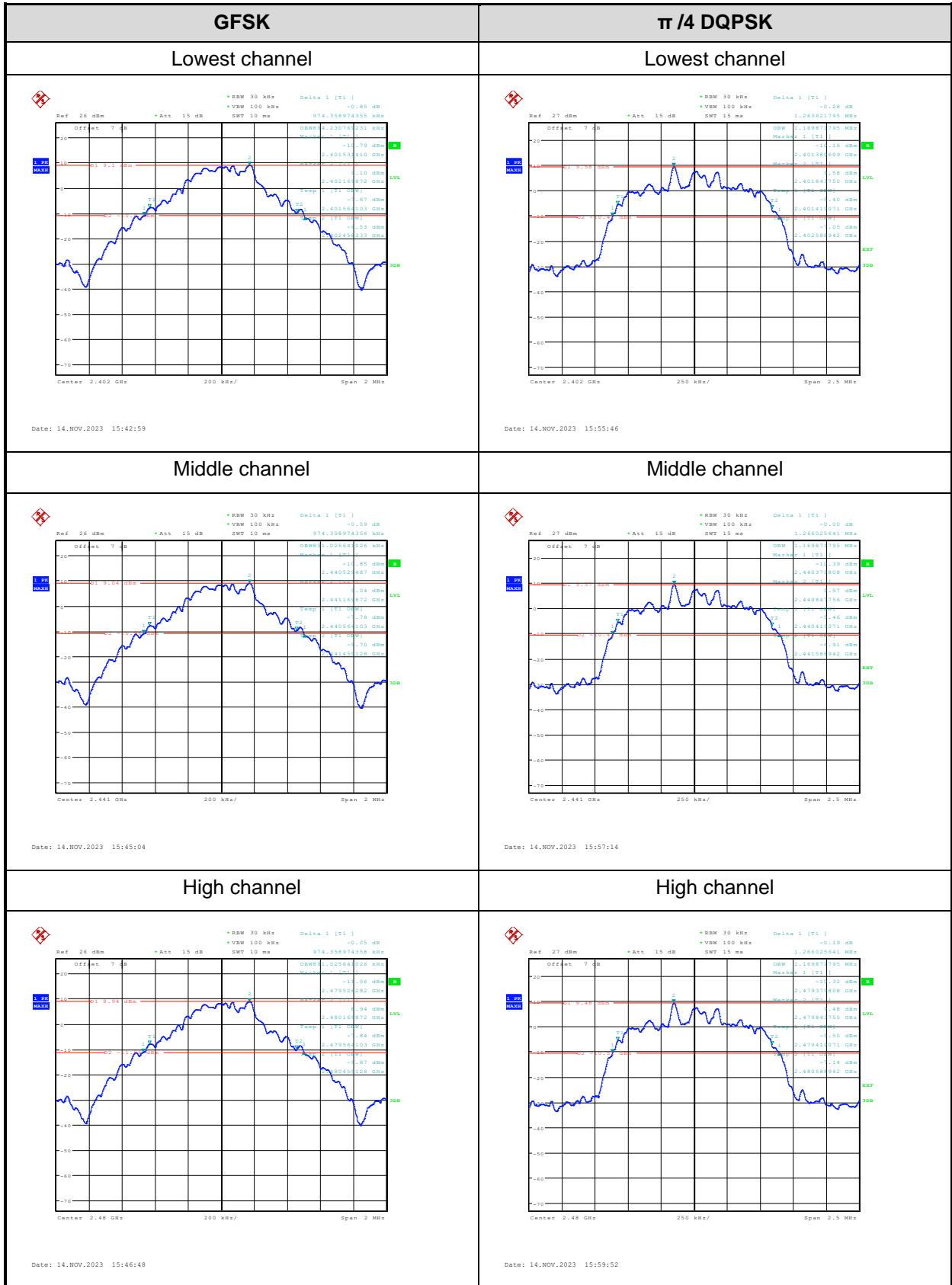

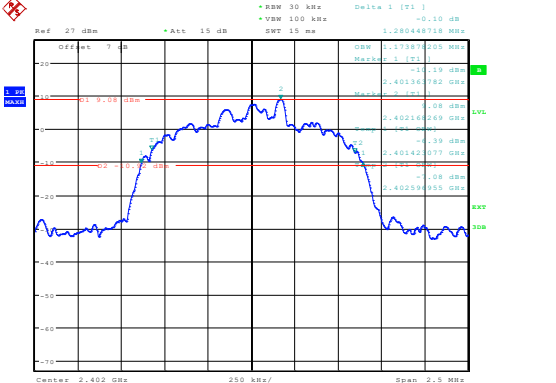
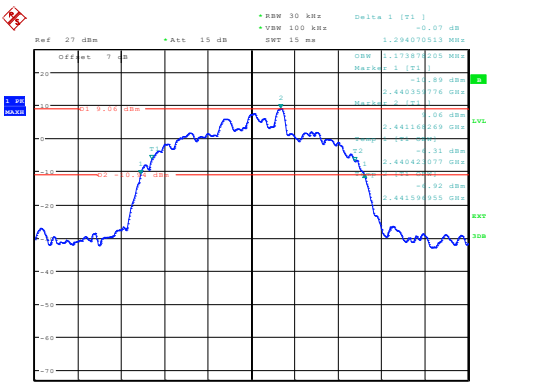
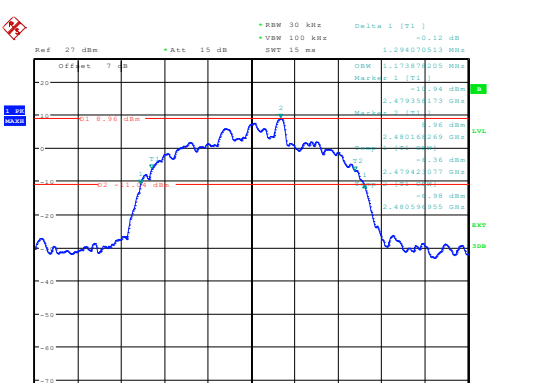
8DPSK	/
Lowest channel	/
 <p>Ref: 27 dBm Att: 15 dB BW: 30 kHz VM: 100 kHz SW: 15 ms Delta 1 [71]</p> <p>OSW: 1.17387205 MHz Masked: 1 [01]</p> <p>Center: 2.402 GHz 250 kHz/ Span: 2.5 MHz</p> <p>Date: 14.NOV.2023 16:01:25</p>	/
Middle channel	/
 <p>Ref: 27 dBm Att: 15 dB BW: 30 kHz VM: 100 kHz SW: 15 ms Delta 1 [71]</p> <p>OSW: 1.17387205 MHz Masked: 1 [01]</p> <p>Center: 2.441 GHz 250 kHz/ Span: 2.5 MHz</p> <p>Date: 14.NOV.2023 16:03:14</p>	/
High channel	/
 <p>Ref: 27 dBm Att: 15 dB BW: 30 kHz VM: 100 kHz SW: 15 ms Delta 1 [71]</p> <p>OSW: 1.17387205 MHz Masked: 1 [01]</p> <p>Center: 2.48 GHz 250 kHz/ Span: 2.5 MHz</p> <p>Date: 14.NOV.2023 16:06:36</p>	/

Maximum Conducted Peak Output Power:

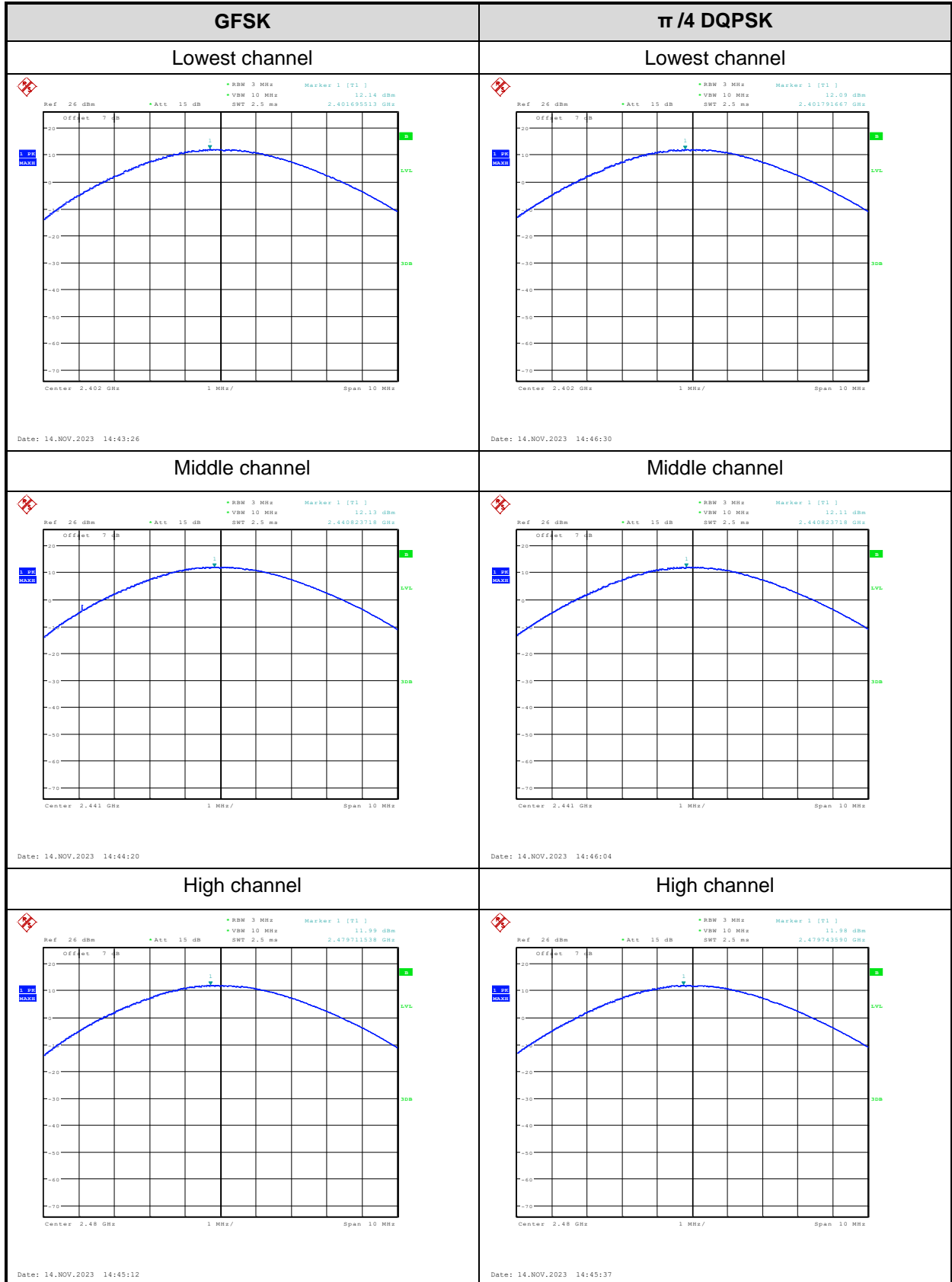

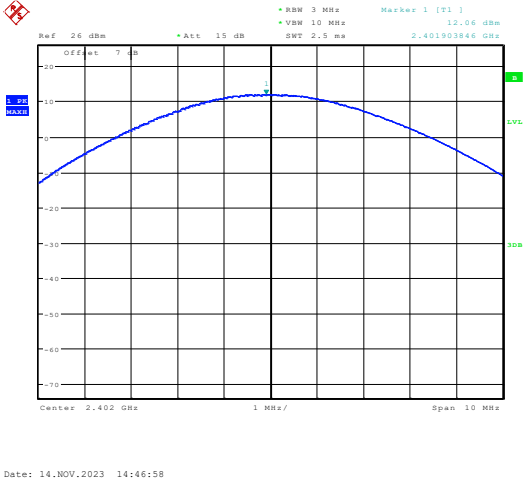
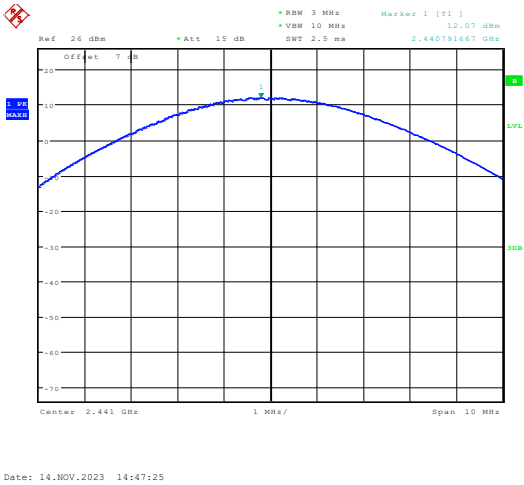
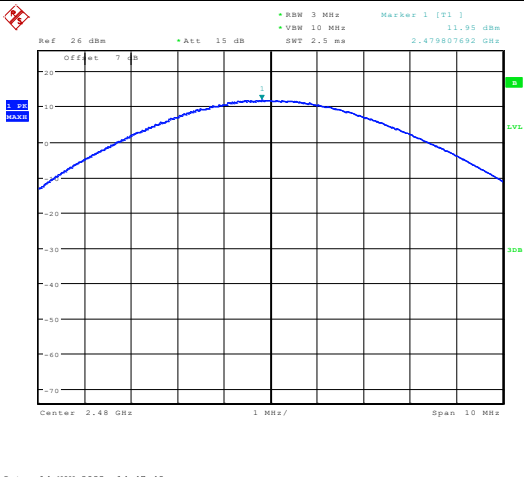
8DPSK	/
Lowest channel	/
 <p>Date: 14.NOV.2023 14:46:58</p>	/
Middle channel	/
 <p>Date: 14.NOV.2023 14:47:25</p>	/
High channel	/
 <p>Date: 14.NOV.2023 14:47:48</p>	/

Channel separation:

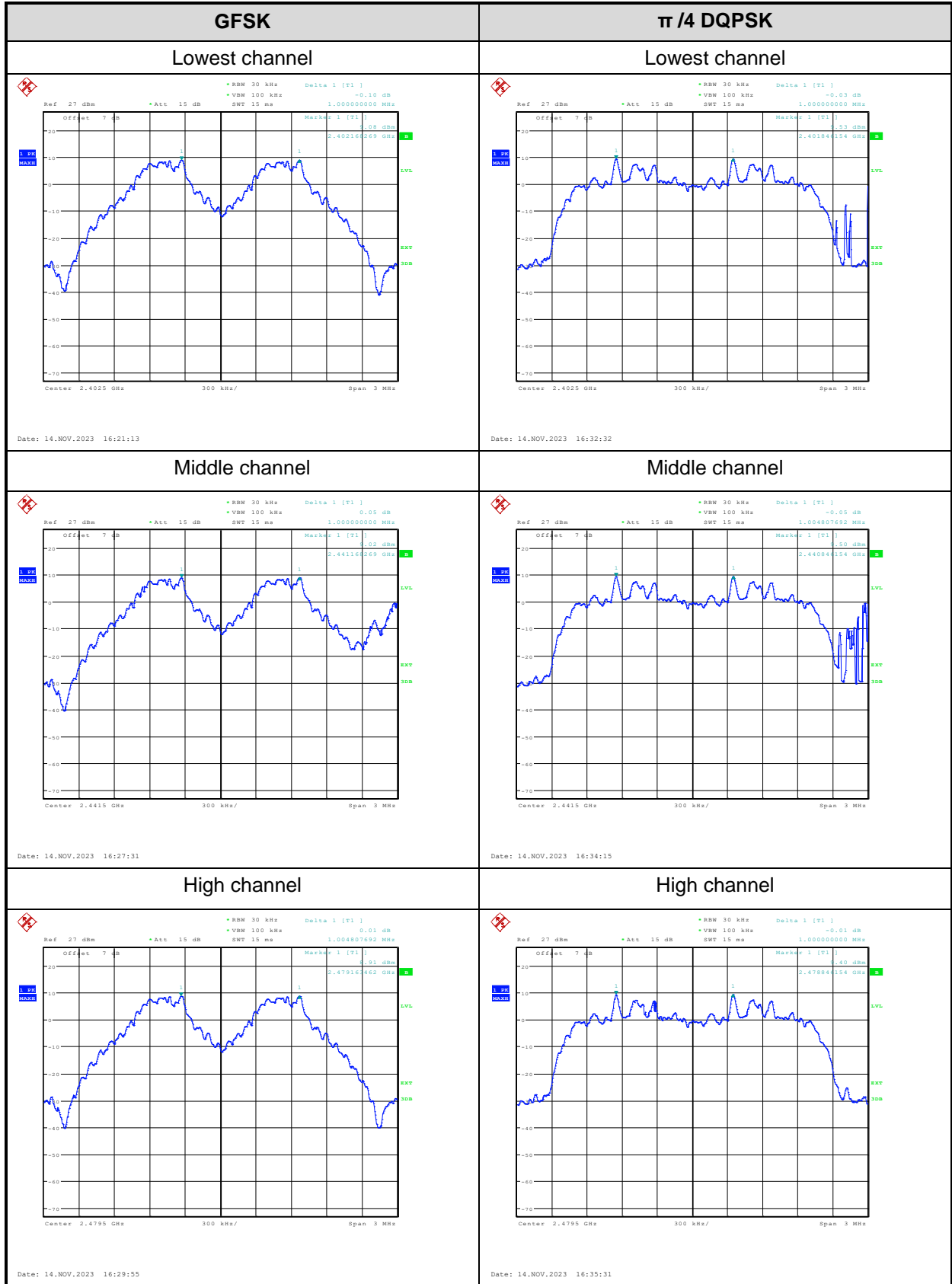

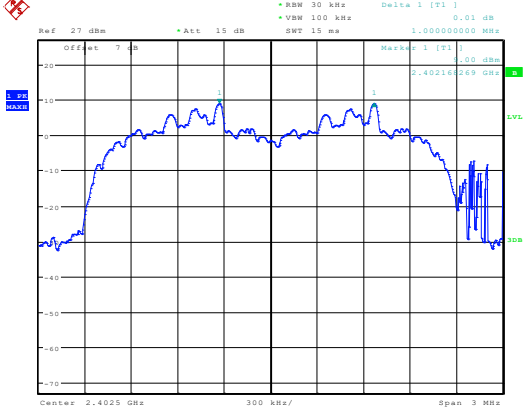
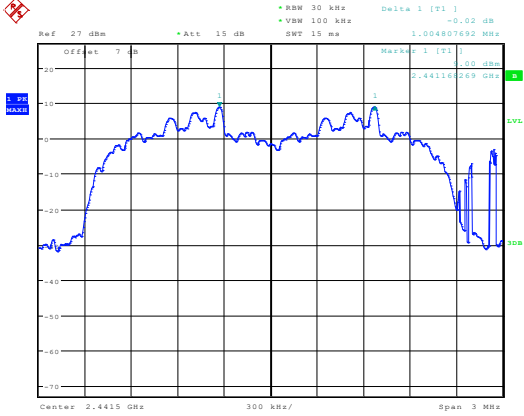
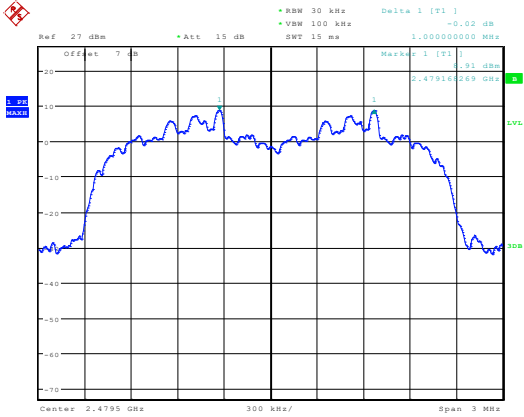
8DPSK	/
Lowest channel	/
 <p>Date: 14.NOV.2023 16:38:46</p>	/
Middle channel	/
 <p>Date: 14.NOV.2023 16:40:14</p>	/
High channel	/
 <p>Date: 14.NOV.2023 16:44:33</p>	/

Number of hopping Frequency

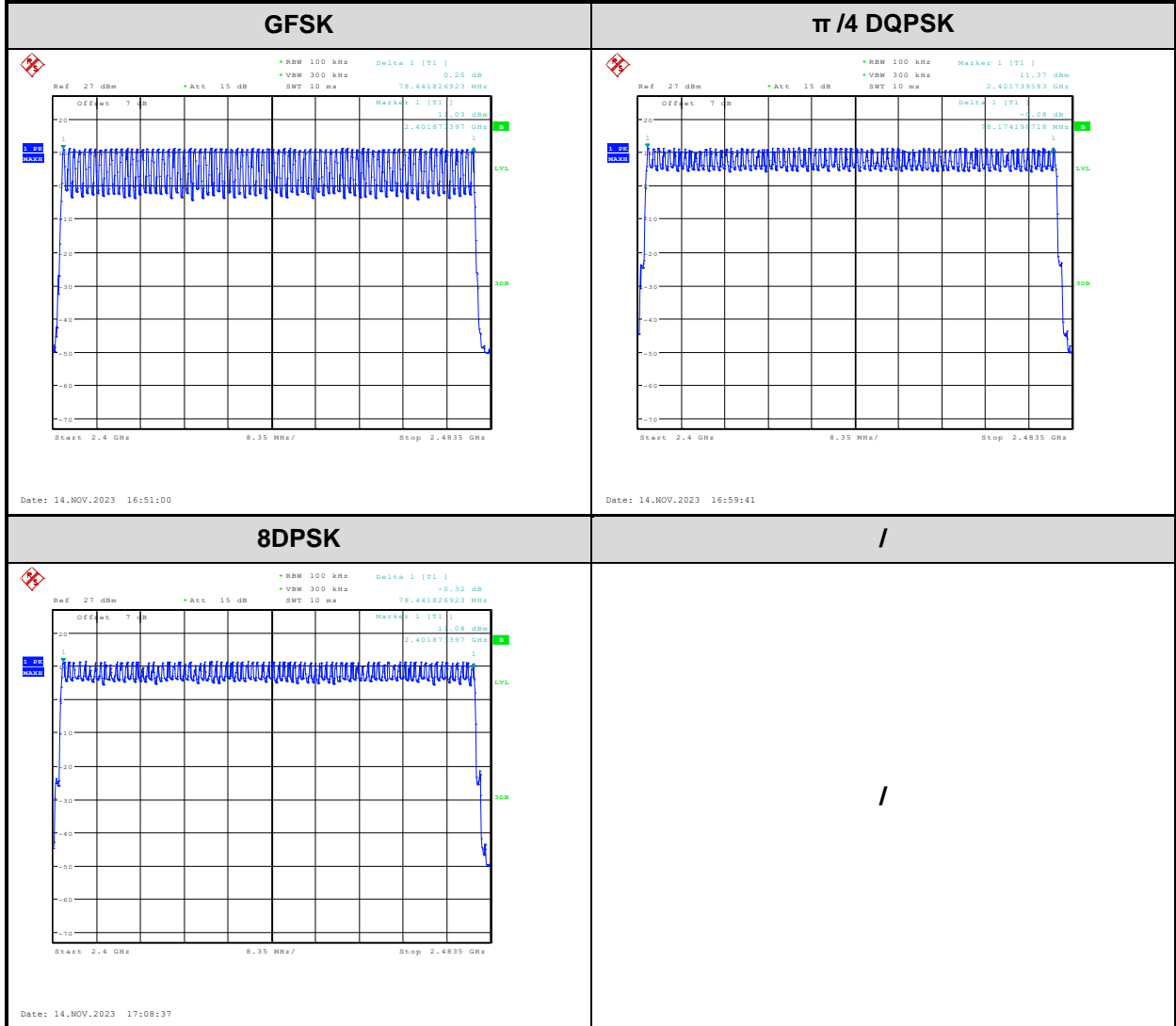

Time of occupancy (dwell time)

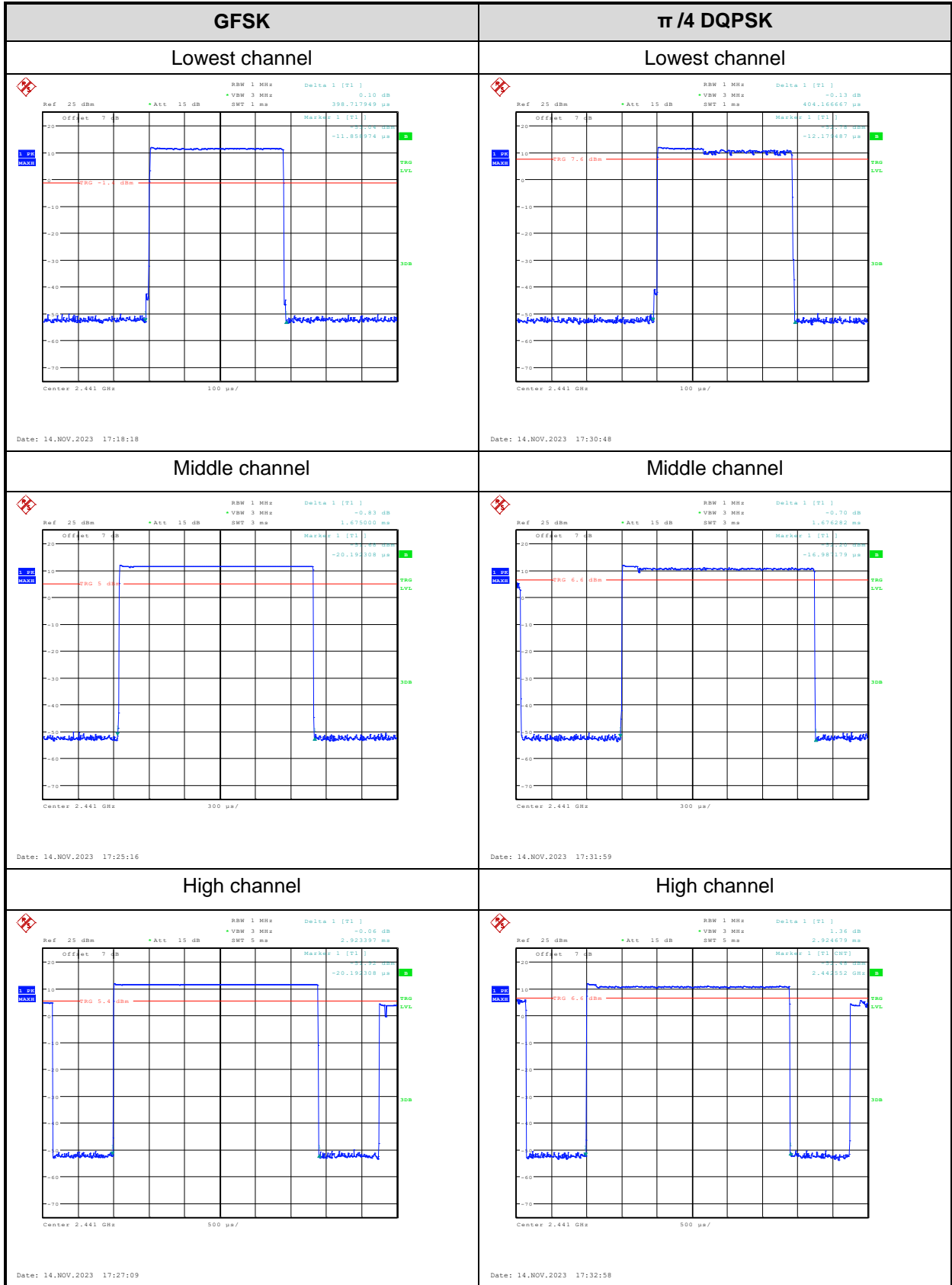

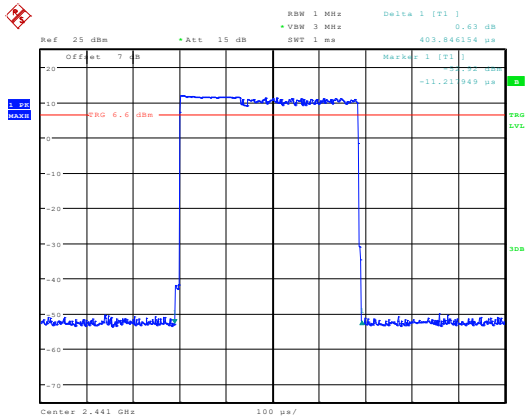
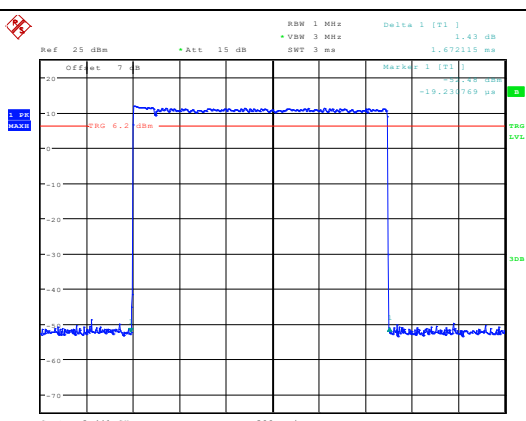
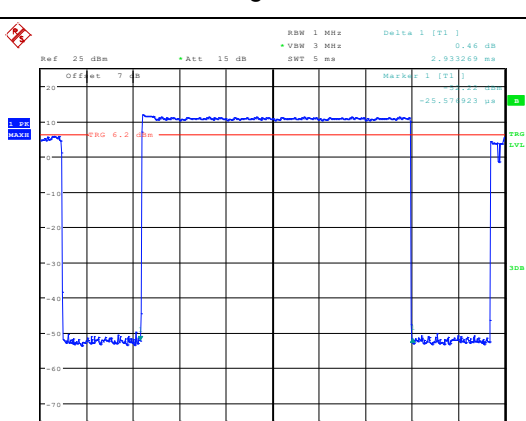
8DPSK	/
<p style="text-align: center;">Lowest channel</p>  <p>Date: 14.NOV.2023 17:37:03</p>	/
<p style="text-align: center;">Middle channel</p>  <p>Date: 14.NOV.2023 17:36:12</p>	/
<p style="text-align: center;">High channel</p>  <p>Date: 14.NOV.2023 17:35:13</p>	/

100kHz Bandwidth of Frequency Band Edge:

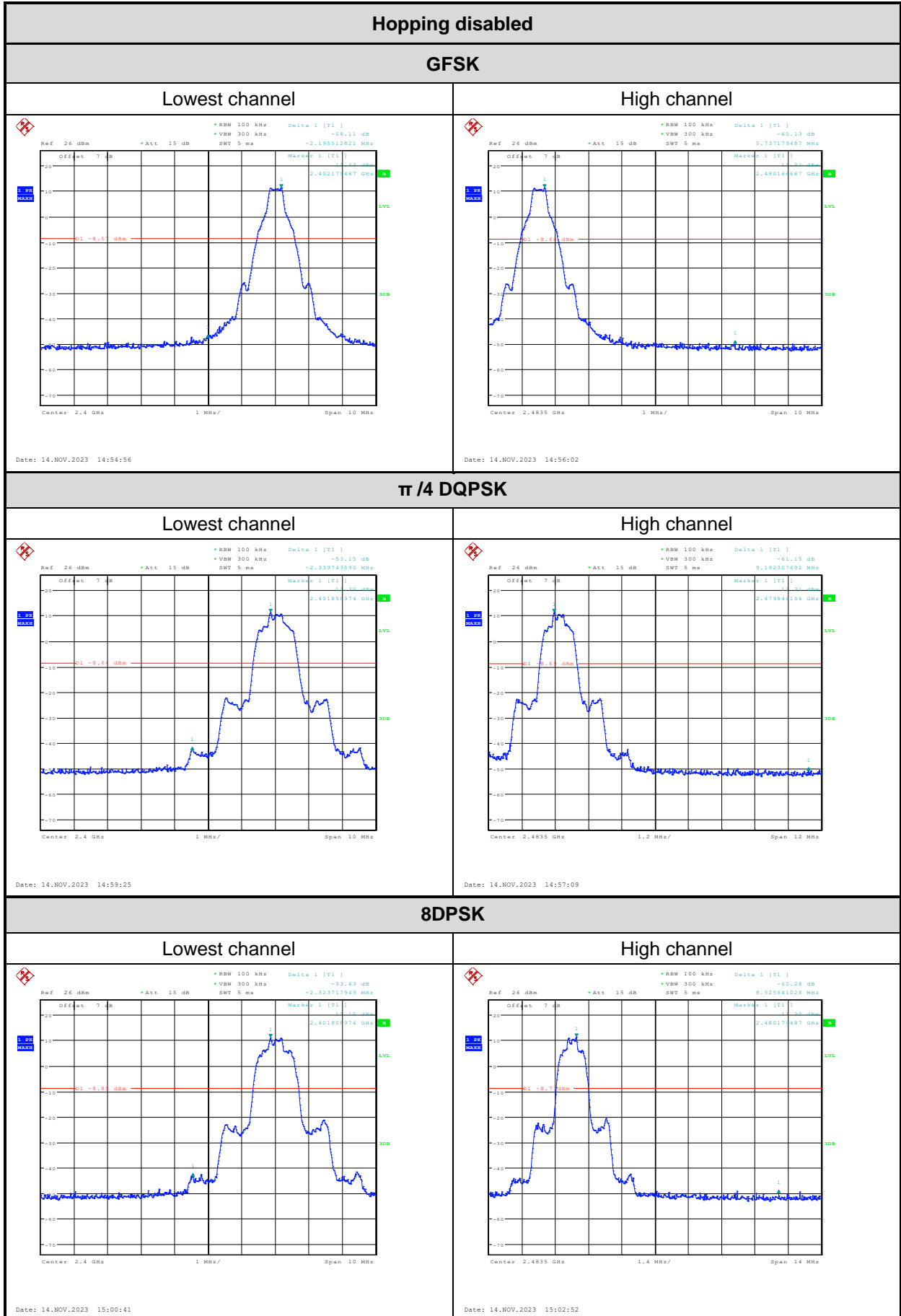

Hopping enabled

GFSK

Lowest channel

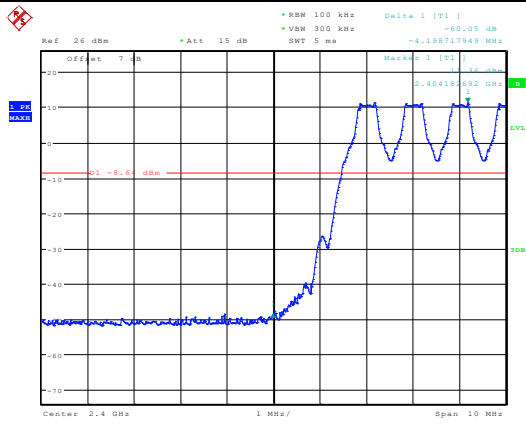

Date: 14.NOV.2023 15:10:58

High channel

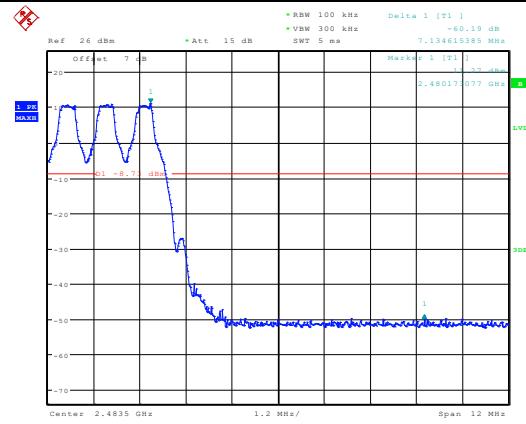

Date: 14.NOV.2023 15:15:30

$\pi/4$ DQPSK

Lowest channel

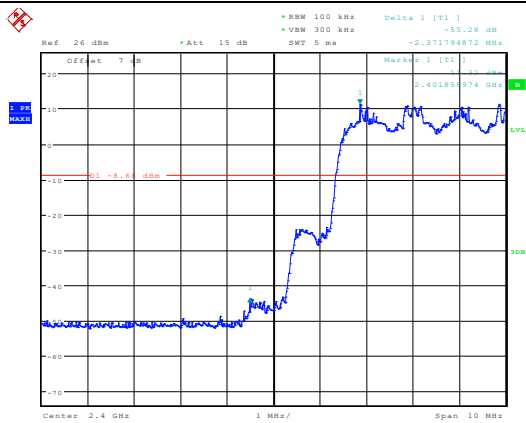

Date: 14.NOV.2023 15:22:44

High channel

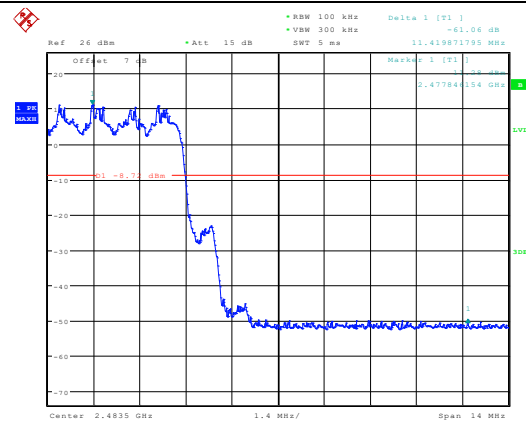

Date: 14.NOV.2023 15:19:34

8DPSK

Lowest channel

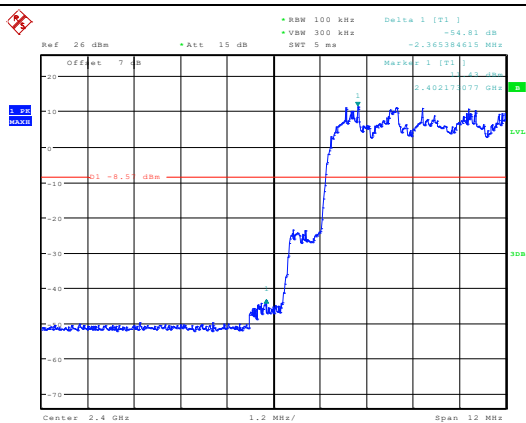

Date: 14.NOV.2023 15:37:20

High channel

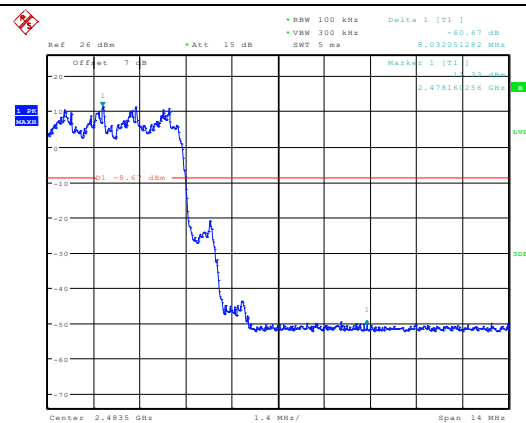

Date: 14.NOV.2023 15:30:52

4 Test Setup Photo

Please refer to the attachment RWAY202300002 Test Setup photo.

5 E.U.T Photo

Please refer to the attachment RWAY202300002 External photo and RWAY202300002 Internal photo.

---End of Report---