

# FCC Test Report

**Report No.:** RWAZ202300088A

**Applicant:** YEALINK(XIAMEN) NETWORK TECHNOLOGY CO.,LTD.

**Address:** No.666 Hu'an Rd. Huli District Xiamen City, Fujian, P.R. China

**Product Name:** Bluetooth Headset

**Product Model:** BHM711

**Multiple Models:** N/A

**Trade Mark:** 

**FCC ID:** T2C-BHM711V1

**Standards:** FCC CFR Title 47 Part 15C (§15.247)

**Test Date:** 2023-12-28 to 2024-01-05

**Test Result:** Complied

**Report Date:** 2024-01-18

**Reviewed by:**

*Abel chen*

**Approved by:**

*Jacob Gong*

Abel Chen

Project Engineer

Jacob Kong

Manager

**Prepared by:**

World Alliance Testing and Certification (Shenzhen) Co., Ltd

No. 1002, East Block, Laobing Building, Xingye Road 3012, Xixiang street, Bao'an District, Shenzhen, Guangdong, People's Republic of China



This report may contain data that are not covered by the NVLAP accreditation and shall be marked with an asterisk “★”

## Announcement

1. This test report shall not be reproduced in full or partial, without the written approval of World Alliance Testing and Certification (Shenzhen) Co., Ltd
2. The results in this report apply only to the sample tested.
3. This sample tested is in compliance with the limits of the above regulation.
4. This report must not be used by the client to claim product certification, approval, or endorsement by NVLAP, NIST, or any agency of the U.S. Government.
5. The information marked “#” is provided by the applicant, the laboratory is not responsible for its authenticity and this information can affect the validity of the result in the test report. Customer model name, addresses, names, trademarks etc. are included.

## Revision History

Version No.	Issued Date	Description
00	2024-01-18	Original

# Contents

<b>1</b>	<b>General Information .....</b>	<b>4</b>
1.1	Client Information .....	4
1.2	Product Description of EUT .....	4
1.3	Antenna information .....	4
1.4	Related Submittal(s)/Grant(s).....	5
1.5	Measurement Uncertainty .....	5
1.6	Laboratory Location.....	5
1.7	Test Methodology .....	5
<b>2</b>	<b>Description of Measurement.....</b>	<b>6</b>
2.1	Test Configuration.....	6
2.2	Test Auxiliary Equipment .....	6
2.3	Test Setup.....	7
2.4	Test Procedure .....	9
2.5	Measurement Method.....	10
2.6	Measurement Equipment .....	10
<b>3</b>	<b>Test Results .....</b>	<b>12</b>
3.1	Test Summary.....	12
3.2	Limit .....	13
3.3	AC Line Conducted Emissions Test Data.....	14
3.4	Radiated emission Test Data.....	15
3.5	RF Conducted Test Data .....	22
3.5.1	20 dB Emission Bandwidth and 99% Occupied Bandwidth.....	22
3.5.2	Maximum Conducted Peak Output Power.....	22
3.5.3	Channel separation .....	23
3.5.4	Number of hopping Frequency .....	23
3.5.5	Time of occupancy (dwell time).....	23
3.5.6	100 kHz Bandwidth of Frequency Band Edge .....	24
<b>4</b>	<b>Test Setup Photo.....</b>	<b>38</b>
<b>5</b>	<b>E.U.T Photo.....</b>	<b>39</b>

# 1 General Information

## 1.1 Client Information

Applicant:	YEALINK(XIAMEN) NETWORK TECHNOLOGY CO.,LTD.
Address:	No.666 Hu'an Rd. Huli District Xiamen City, Fujian, P.R. China
Manufacturer:	YEALINK(XIAMEN) NETWORK TECHNOLOGY CO.,LTD.
Address:	No.666 Hu'an Rd. Huli District Xiamen City, Fujian, P.R. China

## 1.2 Product Description of EUT

The EUT is Bluetooth Headset that contains classic Bluetooth(BDR/EDR)radio, this report covers the full testing of the classic Bluetooth(BDR/EDR)radio.

Sample Serial Number	1T-1 for CE&RE test, 1T-2 for RF test conducted test (assigned by WATC)
Sample Received Date	2023-12-26
Sample Status	Good Condition
Frequency Range	2402MHz - 2480MHz
Maximum Conducted Peak Output Power	1.20dBm
Modulation Technology	GFSK, $\pi/4$ -DQPSK, 8DPSK
Antenna Gain <sup>#</sup>	2.35dBi
Spatial Streams	SISO (1TX, 1RX)
Power Supply	DC 3.8V from Battery
Operating temperature <sup>#</sup>	0 deg.C to +40 deg.C
Adapter Information	N/A
Modification	Sample No Modification by the test lab

## 1.3 Antenna information

<p><b>15.203 requirement:</b></p> <p>An intentional radiator shall be designed to ensure that no antenna other than that furnished by the responsible party shall be used with the device. The use of a permanently attached antenna or of an antenna that uses a unique coupling to the intentional radiator, the manufacturer may design the unit so that a broken antenna can be replaced by the user, but the use of a standard antenna jack or electrical connector is prohibited.</p>	
<b>Device Antenna information:</b>	
<p>The BLE antenna is an internal antenna which cannot replace by end-user. Please see product internal photos for details.</p>	

## 1.4 Related Submittal(s)/Grant(s)

No related submittal(s)/Grant(s)

## 1.5 Measurement Uncertainty

Parameter		Expanded Uncertainty (Confidence of 95%(U = 2Uc(y)))
AC Power Lines Conducted Emissions		±3.14dB
Emissions, Radiated	Below 30MHz	±2.78dB
	Below 1GHz	±4.84dB
	Above 1GHz	±5.44dB
Emissions, Conducted		1.75dB
Conducted Power		0.74dB
Frequency Error		150Hz
Bandwidth		0.34%
Power Spectral Density		0.74dB

**Note:** The extended uncertainty given in this report is obtained by combining the standard uncertainty times the coverage factor K with the 95% confidence interval. Otherwise required by the applicant or Product Regulations, Decision Rule in this report did not consider the uncertainty.

## 1.6 Laboratory Location

World Alliance Testing and Certification (Shenzhen) Co., Ltd

No. 1002, East Block, Laobing Building, Xingye Road 3012, Xixiang street, Bao'an District, Shenzhen, Guangdong, People's Republic of China

Tel: +86-755-29691511, Email: [qa@watc.com.cn](mailto:qa@watc.com.cn)

The lab has been recognized as the FCC accredited lab under the KDB 974614 D01 and is listed in the FCC Public Access Link (PAL) database, FCC Registration No. : 463912, the FCC Designation No. : CN5040.

The lab has been recognized by Innovation, Science and Economic Development Canada to test to Canadian radio equipment requirements, the CAB identifier: CN0160.

## 1.7 Test Methodology

FCC CFR 47 Part 2

FCC CFR 47 Part 15

KDB 558074 D01 DTS Meas Guidance v05r02

ANSI C63.10-2020

## 2 Description of Measurement

### 2.1 Test Configuration

Operating channels:					
Channel No.	Frequency (MHz)	Channel No.	Frequency (MHz)	Channel No.	Frequency (MHz)
0	2402	39	2441	76	2478
1	2403	40	2442	77	2479
...	...	...	...	78	2480
38	2440	...	...	/	/

According to ANSI C63.10-2020 chapter 5.6.1 Table 11 requirement, select lowest channel, middle channel, and highest channel in the frequency range in which device operates for testing. The detailed frequency points are as follows:

Lowest channel		Middle channel		Highest channel	
Channel No.	Frequency (MHz)	Channel No.	Frequency (MHz)	Channel No.	Frequency (MHz)
0	2402	39	2441	78	2480

Test Mode:				
Transmitting mode:	Keep the EUT in continuous transmitting with modulation			
Exercise software#:	AB1565_AB1568_Airoha_Tool_Kit(ATK)_v3.8.0			
Mode	Data rate	Powel Level Setting <sup>#</sup>		
		Low Channel	Middle Channel	High Channel
BDR(GFSK)	1Mbps	41	41	41
EDR( $\pi/4$ -DQPSK)	2Mbps	41	41	41
EDR(8DPSK)	3Mbps	41	41	41

The exercise software and the maximum power setting that provided by manufacturer.

Worst-Case Configuration:
For radiated emissions, EUT was investigated in three orthogonal orientation, the worst-case orientation was recorded in report
For radiated emission 9kHz-1GHz and above 18GHz were performed with the EUT transmits at the channel with highest output power as worst-case scenario.

### 2.2 Test Auxiliary Equipment

Manufacturer	Description	Model	Serial Number
/	/	/	/

## 2.3 Test Setup

### 1) Conducted emission measurement:

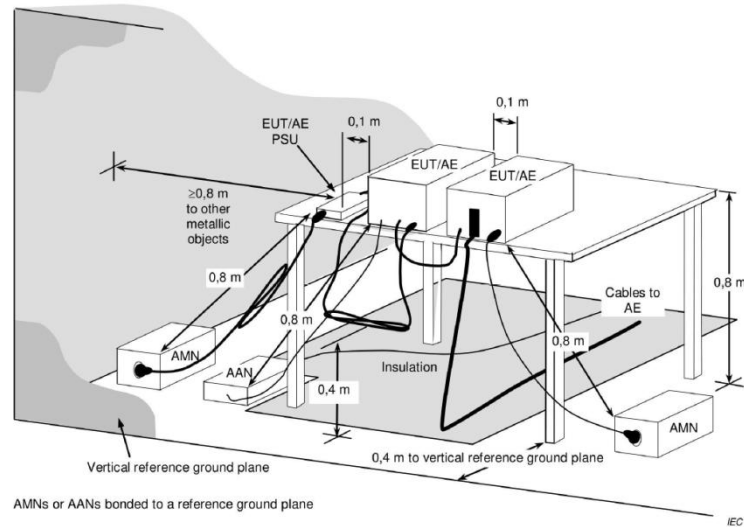

**Note:** The 0.8 m distance specified between EUT/AE/PSU and AMN/AAN, is applicable only to the EUT being measured. If the device is AE then it shall be >0.8 m.

### 2) Radiated emission measurement:

Below 30MHz (3m SAC)

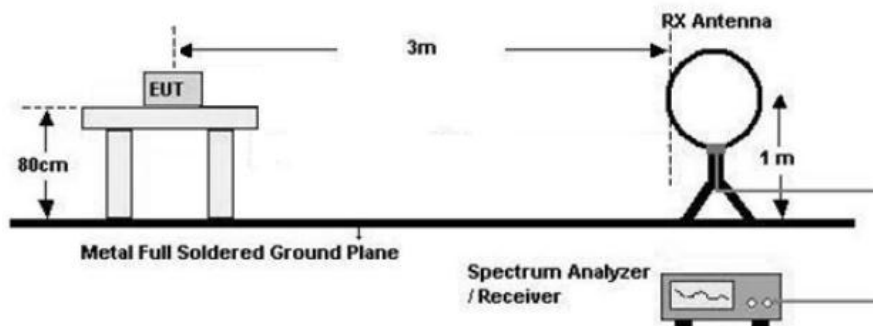

30MHz-1GHz (3m SAC)

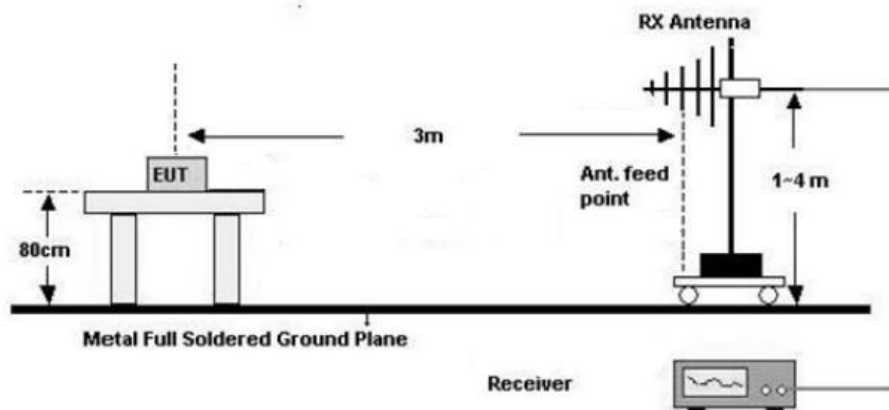

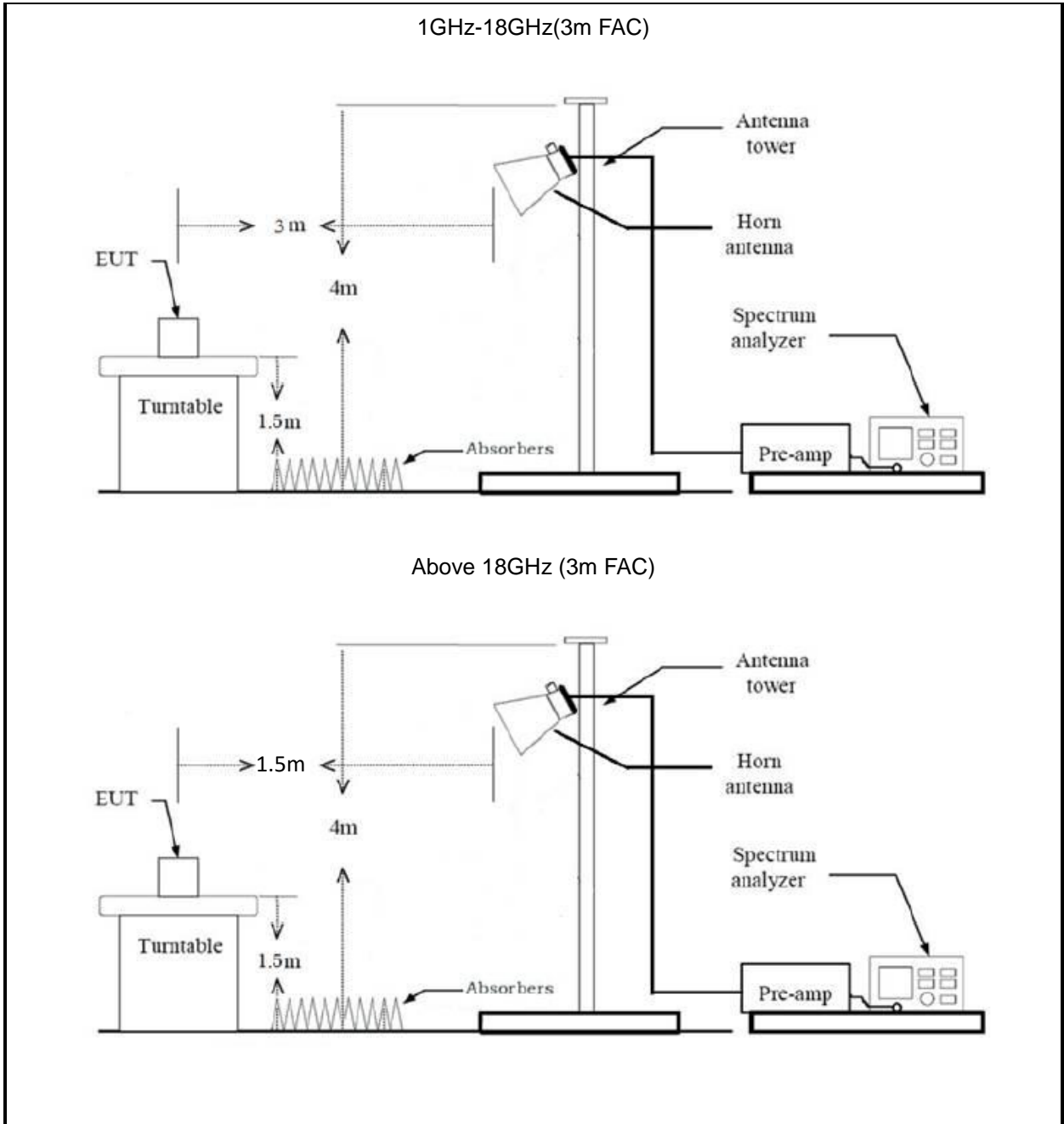

**3) RF Conducted Test**

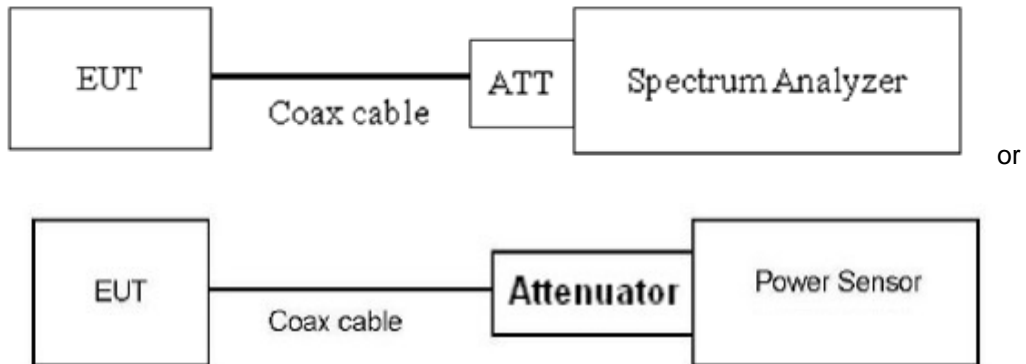



## 2.4 Test Procedure

### Conducted emission:

1. The E.U.T is placed on a non-conducting table 40cm from the vertical ground plane and 80cm above the horizontal ground plane (Please refer to the block diagram of the test setup and photographs).
2. Both sides of A.C. line are checked for maximum conducted interference. In order to find the maximum emission, the relative positions of equipment and all of the interface cables must be changed according to ANSI C63.10 on conducted measurement.
3. Line conducted data is recorded for both Line and Neutral

### Radiated Emission Procedure:

#### a) For below 30MHz

1. All measurements were made at a test distance of 3 m. The measured data was extrapolated from the test distance (3m) to the specification distance (300 m from 9-490 kHz and 30 m from 490 kHz- 30 MHz) to clearly show the relative levels of fundamental and spurious emissions and demonstrate compliance with the requirement that the level of any spurious emissions be below the level of the intentionally transmitted signal. The extrapolation factor for the limits were  $40 \cdot \log(\text{test distance} / \text{specification distance})$ .
2. Loop antenna use, investigation was done on the three antenna orientations (parallel, perpendicular, ground-parallel)

#### b) For 30MHz-1GHz:

1. The EUT was placed on the tabletop of a rotating table 0.8 m the ground at a 3 m semi anechoic chamber. The measurement distance from the EUT to the receiving antenna is 3 m.
2. EUT works in each mode of operation that needs to be tested. The highest signal levels relative to the limit shall be determined by rotating the EUT from 0° to 360° and with varying the measurement antenna height between 1 m and 4 m in vertical and horizontal polarizations.

#### c) For above 1GHz:

1. The EUT was placed on the tabletop of a rotating table 1.5 m the ground at a 3 m fully anechoic room. The measurement distance from the EUT to the receiving antenna is 3 m (1-18GHz) and 1.5 m (above 18GHz).
2. EUT works in each mode of operation that needs to be tested, and having the EUT continuously working. The highest signal levels relative to the limit shall be determined by rotating the EUT from 0° to 360° and with varying the measurement antenna height between 1 m and 4 m in vertical and horizontal polarizations.
3. Open the test software to control the test antenna and test turntable. Perform the test, save the test results, and export the test data.
4. Base on FCC 15.31 (f) (2): measurements may be performed at a distance closer than that specified in the regulations; however, an attempt should be made to avoid making measurements in the near field.

### RF Conducted Test:

1. The antenna port of EUT was connected to the RF port of the test equipment (Power Meter or

- Spectrum analyzer) through Attenuator and RF cable.
2. The cable assembly insertion loss of 6.5dB (including 6.0 dB Attenuator and 0.5dB cable) was entered as an offset in the power meter. Note: Actual cable loss was unavailable at the time of testing, therefore a loss of 0.5dB was assumed as worst case. This was later verified to be true by laboratory. ( if the RF cable provided by client, the cable loss declared by client)
  3. The EUT is keeping in continuous transmission mode and tested in all modulation modes.

## 2.5 Measurement Method

Description of Test	Measurement Method
AC Line Conducted Emissions	ANSI C63.10-2020 Section 6.2
Maximum Conducted Output Power	ANSI C63.10-2020 Section 7.8.5
20 dB Emission Bandwidth	ANSI C63.10-2020 Section 6.9.2
99% Occupied Bandwidth	ANSI C63.10-2020 Section 6.9.3
Channel separation	ANSI C63.10-2020 Section 7.8.2
Number of hopping Frequency	ANSI C63.10-2020 Section 7.8.3
Time of occupancy (dwell time)	ANSI C63.10-2020 Section 7.8.4
100kHz Bandwidth of Frequency Band Edge	ANSI C63.10-2020 Section 7.8.7.2&6.10
Radiated emission	ANSI C63.10-2020 Section 7.8&6.3&6.4&6.5&6.6

## 2.6 Measurement Equipment

Manufacturer	Description	Model	Management No.	Calibration Date	Calibration Due Date
Radiated Emission Test					
R&S	EMI test receiver	ESR3	102758	2023/7/3	2024/7/2
ROHDE& SCHWARZ	SPECTRUM ANALYZER	FSV40-N	101608	2023/7/3	2024/7/2
SONOMA INSTRUMENT	Low frequency amplifier	310	186014	2023/7/12	2024/7/11
COM-POWER	preamplifier	PAM-118A	18040152	2023/8/21	2024/8/20
COM-POWER	Amplifier	PAM-840A	461306	2023/8/8	2024/8/7
ETS	Passive Loop Antenna	6512	29604	2023/7/7	2024/7/6
SCHWARZBECK	Log - periodic wideband antenna	VULB 9163	9163-872	2023/7/7	2024/7/6
Astro Antenna Ltd	Horn antenna	AHA-118S	3015	2023/7/6	2024/7/5

Ducommun technologies	Horn Antenna	ARH-4223-02	1007726-03	2023/7/10	2024/7/9
Ducommun technologies	Horn Antenna	ARH-2823-02	1007726-03	2023/7/10	2024/7/9
Oulitong	Band Reject Filter	OBSF-2400-248 3.5-50N	OE02103119	2023/9/15	2024/9/14
N/A	Coaxial Cable	N/A	NO.9	2023/8/8	2024/8/7
N/A	Coaxial Cable	N/A	NO.10	2023/8/8	2024/8/7
N/A	Coaxial Cable	N/A	NO.11	2023/8/8	2024/8/7
Audix	Test Software	E3	191218 V9	/	/
RF Conducted Test					
ROHDE& SCHWARZ	SPECTRUM ANALYZER	FSU-26	200680/026	2023/7/12	2024/7/11
narda	6dB attenuator	603-06-1	N/A	2023/7/26	2024/7/25

Note: All equipment is calibrated with valid calibrations. Each measurement data is traceable to the national or International standards.

### 3 Test Results

#### 3.1 Test Summary

FCC Rules	Description of Test	Result
§15.203	Antenna Requirement	Compliance
§15.207 (a)	AC Line Conducted Emissions	N/A
§15.247 (a)(1)	20dB Emission Bandwidth	Compliance
-	99% Occupied Bandwidth	Report only
§15.247 (a)(1)	Channel separation	Compliance
§15.247 (a)(1)(iii)	Number of hopping Frequency	Compliance
§15.247 (a)(1)(iii)	Time of occupancy (dwell time)	Compliance
§15.247(b)(1)	Maximum Conducted Output Power	Compliance
§15.247(d)	100kHz Bandwidth of Frequency Band Edge	Compliance
§15.205, §15.209, §15.247(d)	Radiated emission	Compliance

### 3.2 Limit

Test items	Limit
AC Line Conducted Emissions	See details §15.207 (a)
Conducted Output Power	For frequency hopping systems operating in the 2400–2483.5 MHz band employing at least 75 non-overlapping hopping channels, and all frequency hopping systems in the 5725–5850 MHz band: 1 watt. For all other frequency hopping systems in the 2400–2483.5 MHz band: 0.125 watts.
Channel separation	Frequency hopping systems shall have hopping channel carrier frequencies separated by a minimum of 25 kHz or the 20 dB bandwidth of the hopping channel, whichever is greater. Alternatively, frequency hopping systems operating in the 2400–2483.5 MHz band may have hopping channel carrier frequencies that are separated by 25 kHz or two-thirds of the 20 dB bandwidth of the hopping channel, whichever is greater, provided the systems operate with an output power no greater than 125 mW.
Number of hopping Frequency	Frequency hopping systems in the 2400–2483.5 MHz band shall use at least 15 channels.
Time of occupancy (dwell time)	The average time of occupancy on any channel shall not be greater than 0.4 seconds within a period of 0.4 seconds multiplied by the number of hopping channels employed.
Spurious Emissions, 100kHz Bandwidth of Frequency Band Edge	In any 100 kHz bandwidth outside the frequency band in which the spread spectrum or digitally modulated intentional radiator is operating, the radio frequency power that is produced by the intentional radiator shall be at least 20 dB below that in the 100 kHz bandwidth within the band that contains the highest level of the desired power, based on either an RF conducted or a radiated measurement, provided the transmitter demonstrates compliance with the peak conducted power limits. If the transmitter complies with the conducted power limits based on the use of RMS averaging over a time interval, as permitted under paragraph (b)(3) of this section, the attenuation required under this paragraph shall be 30 dB instead of 20 dB. Attenuation below the general limits specified in §15.209(a) is not required. In addition, radiated emissions which fall in the restricted bands, as defined in §15.205(a), must also comply with the radiated emission limits specified in §15.209(a) (see §15.205(c)).

### 3.3 AC Line Conducted Emissions Test Data

*Not Applicable, the device only powered by battery when use Bluetooth function.*

### 3.4 Radiated emission Test Data

9 kHz-30MHz:

<b>Test Date:</b>	2024-01-04	<b>Test By:</b>	Luke Li
<b>Environment condition:</b>	Temperature: 24.2°C; Relative Humidity:37%; ATM Pressure: 101.6kPa		

For radiated emissions below 30MHz, there were no emissions found within 20dB of limit.

**30MHz-1GHz:**

<b>Test Date:</b>	2023-01-04	<b>Test By:</b>	Luke Li
<b>Environment condition:</b>	Temperature: 24.2°C; Relative Humidity:37%; ATM Pressure: 101.6kPa		

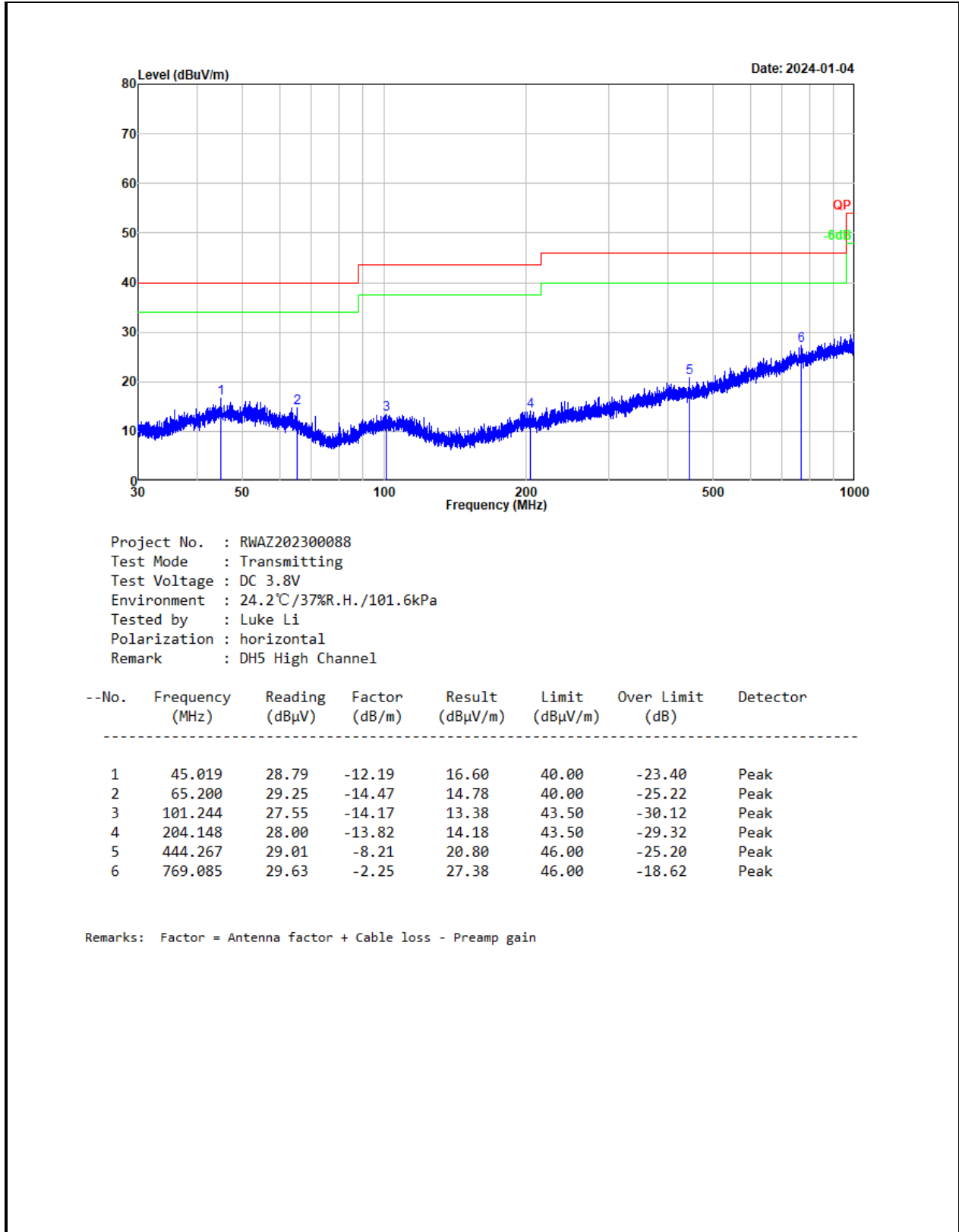



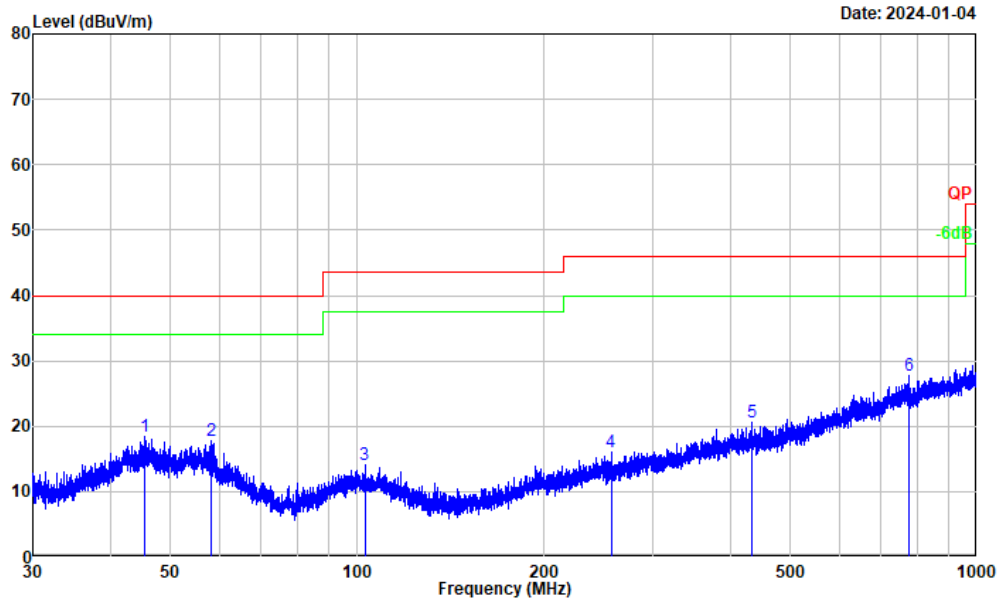

Project No. : RWAZ202300088  
 Test Mode : Transmitting  
 Test Voltage : DC 3.8V  
 Environment : 24.2°C/37%R.H./101.6kPa  
 Tested by : Luke Li  
 Polarization : vertical  
 Remark : DH5 High Channel

--No.	Frequency (MHz)	Reading (dBμV)	Factor (dB/m)	Result (dBμV/m)	Limit (dBμV/m)	Over Limit (dB)	Detector
1	45.455	30.59	-12.19	18.40	40.00	-21.60	Peak
2	58.280	31.27	-13.43	17.84	40.00	-22.16	Peak
3	102.945	28.09	-14.07	14.02	43.50	-29.48	Peak
4	256.971	28.42	-12.29	16.13	46.00	-29.87	Peak
5	433.115	28.90	-8.25	20.65	46.00	-25.35	Peak
6	778.582	30.00	-2.21	27.79	46.00	-18.21	Peak

Remarks: Factor = Antenna factor + Cable loss - Preamp gain

**Remark:**

Level = Reading + Factor

Factor = Antenna factor + Cable loss – Amplifier gain

Over Limit = Level – Limit

**Above 1GHz:**

<b>Test Date:</b>	2024-01-05	<b>Test By:</b>	Bard Huang
<b>Environment condition:</b>	Temperature: 24.6°C; Relative Humidity:45%; ATM Pressure: 101.4kPa		

Frequency (MHz)	Reading level (dBμV)	Polar	Corrected Factor (dB/m)	Corrected Amplitude (dBμV/m)	Limit (dBμV/m)	Margin (dB)	Remark
<b>DH5</b>							
Low Channel							
2390.000	37.00	horizontal	8.25	45.25	54.00	-8.75	Average
2390.000	49.01	horizontal	8.25	57.26	74.00	-16.74	Peak
2390.000	37.92	vertical	8.25	46.17	54.00	-7.83	Average
2390.000	49.90	vertical	8.25	58.15	74.00	-15.85	Peak
4804.000	49.66	horizontal	0.21	49.87	74.00	-24.13	Peak
4804.000	49.52	vertical	0.21	49.73	74.00	-24.27	Peak
Middle Channel							
4882.000	49.53	horizontal	0.45	49.98	74.00	-24.02	Peak
4882.000	48.41	vertical	0.45	48.86	74.00	-25.14	Peak
High Channel							
2483.500	37.85	horizontal	8.25	46.10	54.00	-7.90	Average
2483.500	48.85	horizontal	8.25	57.10	74.00	-16.90	Peak
2483.500	37.86	vertical	8.25	46.11	54.00	-7.89	Average
2483.500	49.87	vertical	8.25	58.12	74.00	-15.88	Peak
2054.527	38.34	vertical	-2.96	35.38	54.00	-18.62	Average
2054.527	58.42	vertical	-2.96	55.46	74.00	-18.54	Peak
4960.000	49.71	horizontal	0.93	50.64	74.00	-23.36	Peak
4960.000	48.27	vertical	0.93	49.20	74.00	-24.80	Peak
<b>2DH5</b>							
Low Channel							
2390.000	37.36	horizontal	8.25	45.61	54.00	-8.39	Average
2390.000	49.87	horizontal	8.25	58.12	74.00	-15.88	Peak
2390.000	37.84	vertical	8.25	46.09	54.00	-7.91	Average
2390.000	49.78	vertical	8.25	58.03	74.00	-15.97	Peak
4804.000	50.22	horizontal	0.21	50.43	74.00	-23.57	Peak
4804.000	50.02	vertical	0.21	50.23	74.00	-23.77	Peak
Middle Channel							
4882.000	50.00	horizontal	0.45	50.45	74.00	-23.55	Peak
4882.000	47.96	vertical	0.45	48.41	74.00	-25.59	Peak

High Channel							
2483.500	37.25	horizontal	8.25	45.50	54.00	-8.50	Average
2483.500	49.85	horizontal	8.25	58.10	74.00	-15.90	Peak
2483.500	38.59	vertical	8.25	46.84	54.00	-7.16	Average
2483.500	51.01	vertical	8.25	59.26	74.00	-14.74	Peak
4960.000	48.25	horizontal	0.93	49.18	74.00	-24.82	Peak
4960.000	48.13	vertical	0.93	49.06	74.00	-24.94	Peak
3DH5							
Low Channel							
2390.000	37.55	horizontal	8.25	45.80	54.00	-8.20	Average
2390.000	49.65	horizontal	8.25	57.90	74.00	-16.10	Peak
2390.000	37.58	vertical	8.25	45.83	54.00	-8.17	Average
2390.000	49.97	vertical	8.25	58.22	74.00	-15.78	Peak
4804.000	50.29	horizontal	0.21	50.50	74.00	-23.50	Peak
4804.000	49.08	vertical	0.21	49.29	74.00	-24.71	Peak
Middle Channel							
4882.000	48.75	horizontal	0.45	49.20	74.00	-24.80	Peak
4882.000	48.72	vertical	0.45	49.17	74.00	-24.83	Peak
High Channel							
2483.500	37.56	horizontal	8.25	45.81	54.00	-8.19	Average
2483.500	48.55	horizontal	8.25	56.80	74.00	-17.20	Peak
2483.500	37.31	vertical	8.25	45.56	54.00	-8.44	Average
2483.500	49.33	vertical	8.25	57.58	74.00	-16.42	Peak
4960.000	47.82	horizontal	0.93	48.75	74.00	-25.25	Peak
4960.000	48.04	vertical	0.93	48.97	74.00	-25.03	Peak

Remark:

*Corrected Amplitude = Reading level + corrected Factor*

*Corrected Factor = Antenna factor + Cable loss – Amplifier gain*

*Margin = Corrected Amplitude – Limit*

*For the test result of Peak below the Peak limit more than 20dB, which can compliance with the average limit, just the Peak level was recorded.*

*The emission levels of other frequencies that were lower than the limit 20dB, not show in test report.*

*For emissions in 18GHz-25GHz range, all emissions were investigated and in the noise floor level.*

**Test plot for example as below:**

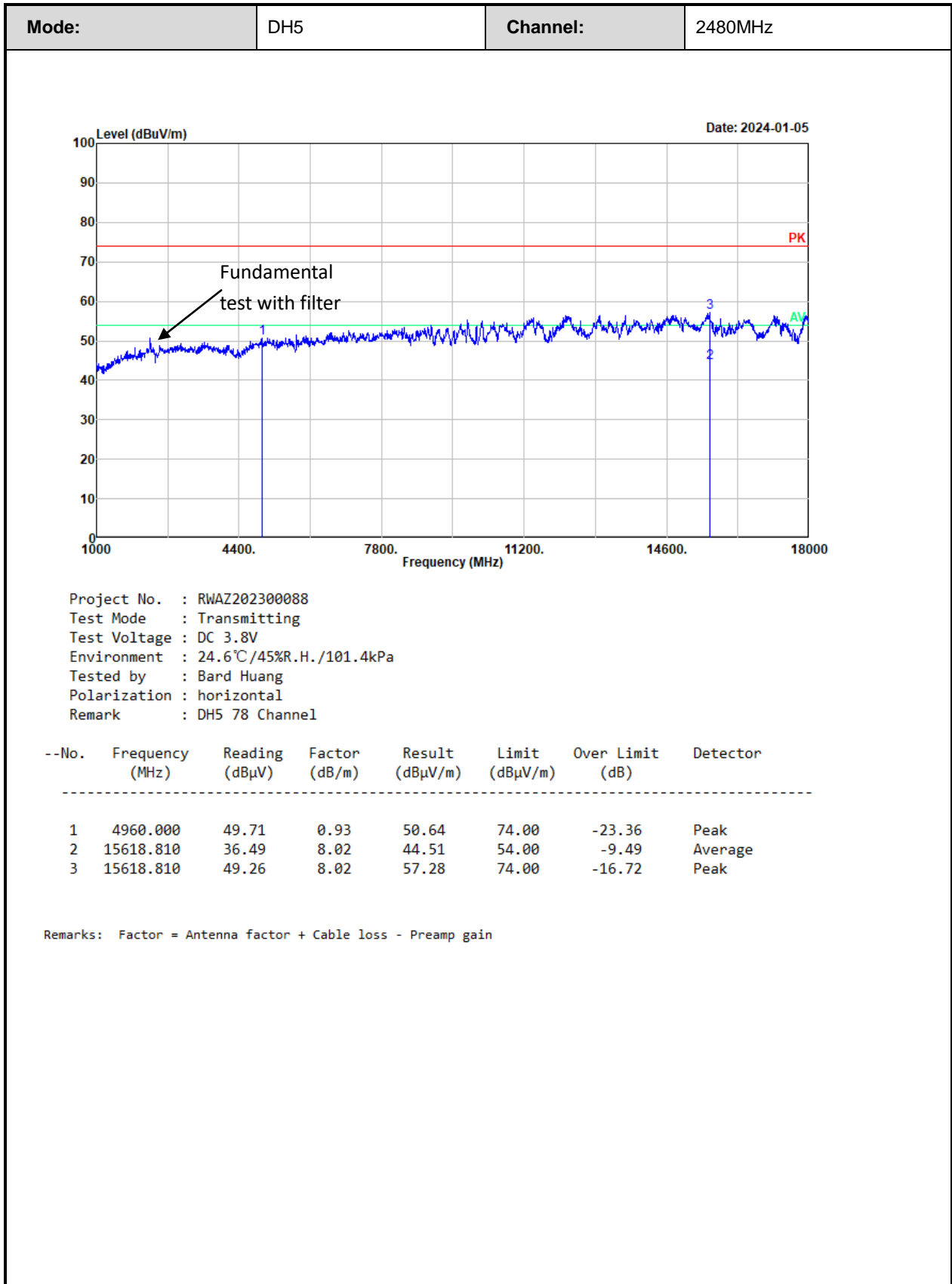

<b>Mode:</b>	DH5	<b>Channel:</b>	2480MHz
--------------	-----	-----------------	---------

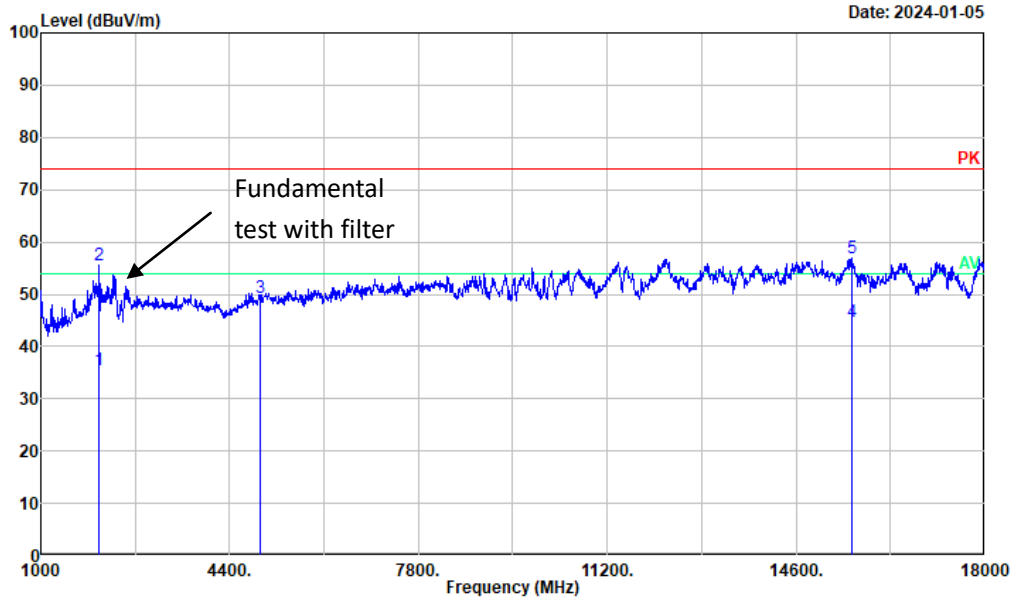

Project No. : RWAZ202300088  
 Test Mode : Transmitting  
 Test Voltage : DC 3.8V  
 Environment : 24.6°C/45%R.H./101.4kPa  
 Tested by : Bard Huang  
 Polarization : vertical  
 Remark : DH5 78 Channel

--No.	Frequency (MHz)	Reading (dBμV)	Factor (dB/m)	Result (dBμV/m)	Limit (dBμV/m)	Over Limit (dB)	Detector
1	2054.527	38.34	-2.96	35.38	54.00	-18.62	Average
2	2054.527	58.42	-2.96	55.46	74.00	-18.54	Peak
3	4960.000	48.27	0.93	49.20	74.00	-24.80	Peak
4	15601.800	36.53	8.09	44.62	54.00	-9.38	Average
5	15601.800	48.75	8.09	56.84	74.00	-17.16	Peak

Remarks: Factor = Antenna factor + Cable loss - Preamp gain

### 3.5 RF Conducted Test Data

<b>Test Date:</b>	2023-12-28~2023-12-29	<b>Test By:</b>	Baylor Li
<b>Environment condition:</b>	Temperature: 23.9~24.5°C; Relative Humidity: 55~68%; ATM Pressure: 99~102.1kPa		

#### 3.5.1 20 dB Emission Bandwidth and 99% Occupied Bandwidth

Test Mode	Channel	20dB BW [MHz]	99% OBW[MHz]
BDR Mode (GFSK)	2402	0.948	0.884
	2441	0.948	0.884
	2480	0.944	0.884
EDR Mode ( $\pi/4$ -DQPSK)	2402	1.212	1.156
	2441	1.208	1.156
	2480	1.208	1.156
EDR Mode (8DPSK)	2402	1.260	1.156
	2441	1.260	1.156
	2480	1.264	1.156

#### 3.5.2 Maximum Conducted Peak Output Power

Test Mode	Channel[MHz]	Result[dBm]	Limit[dBm]	Verdict
BDR Mode (GFSK)	2402	0.59	21	Pass
	2441	0.98	21	Pass
	2480	1.20	21	Pass
EDR Mode ( $\pi/4$ -DQPSK)	2402	0.58	21	Pass
	2441	0.98	21	Pass
	2480	1.17	21	Pass
EDR Mode (8DPSK)	2402	0.44	21	Pass
	2441	0.96	21	Pass
	2480	1.17	21	Pass

### 3.5.3 Channel separation

Test Mode	Channel[MHz]	Result[MHz]	Limit[MHz]	Verdict
BDR Mode (GFSK)	2402	0.996	0.632	Pass
	2441	1.002	0.632	Pass
	2480	1.002	0.629	Pass
EDR Mode ( $\pi/4$ -DQPSK)	2402	1.002	0.808	Pass
	2441	1.002	0.805	Pass
	2480	1.002	0.805	Pass
EDR Mode (8DPSK)	2402	1.002	0.840	Pass
	2441	1.002	0.840	Pass
	2480	1.002	0.843	Pass

Note: Limit  $\leq 2/3 * 20\text{dB BW}$

### 3.5.4 Number of hopping Frequency

Test Mode	Frequency Range [MHz]	Number of hopping Frequency	Limit	Verdict
GFSK	2400-2483.5	79	$\geq 15$	Pass
$\pi/4$ -DQPSK	2400-2483.5	79	$\geq 15$	Pass
8DPSK	2400-2483.5	79	$\geq 15$	Pass

### 3.5.5 Time of occupancy (dwell time)

Test Mode	Packet Type	Channel[MHz]	Pulse Time [ms]	Result[s]	Limit[s]	Verdict
BDR Mode (GFSK)	DH1	2441	0.396	0.127	0.400	Pass
	DH3	2441	1.668	0.267	0.400	Pass
	DH5	2441	2.917	0.311	0.400	Pass
EDR Mode ( $\pi/4$ -DQPSK)	2DH1	2441	0.404	0.129	0.400	Pass
	2DH3	2441	1.668	0.267	0.400	Pass
	2DH5	2441	2.907	0.310	0.400	Pass
EDR Mode (8DPSK)	3DH1	2441	0.402	0.129	0.400	Pass
	3DH3	2441	1.673	0.268	0.400	Pass
	3DH5	2441	2.934	0.313	0.400	Pass

Note:

DH1: Dwell time=Pulse time (ms)  $\times (1600/2/79) \times 31.6\text{s}$

DH3: Dwell time=Pulse time (ms)  $\times (1600/4/79) \times 31.6\text{s}$

DH5: Dwell time=Pulse time (ms)  $\times (1600/6/79) \times 31.6\text{s}$

### 3.5.6 100 kHz Bandwidth of Frequency Band Edge

Test Mode	Channel	Result	Limit	Verdict
BDR Mode (GFSK)	2402	Refer test plot	Refer test plot	Pass
	2480	Refer test plot	Refer test plot	Pass
EDR Mode ( $\pi/4$ -DQPSK)	2402	Refer test plot	Refer test plot	Pass
	2480	Refer test plot	Refer test plot	Pass
EDR Mode (8DPSK)	2402	Refer test plot	Refer test plot	Pass
	2480	Refer test plot	Refer test plot	Pass



# Test Plots:

## 20 dB Emission Bandwidth:

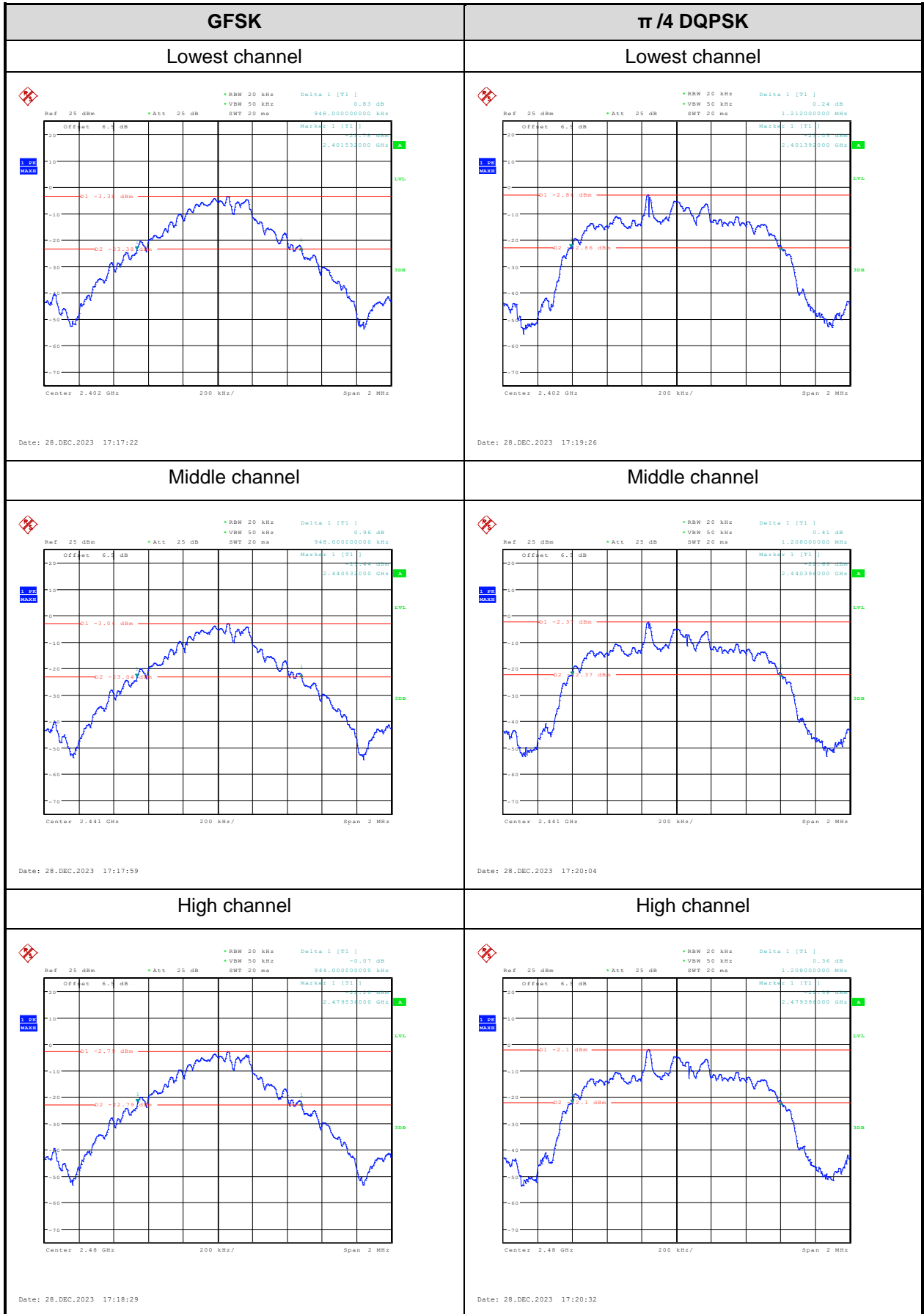

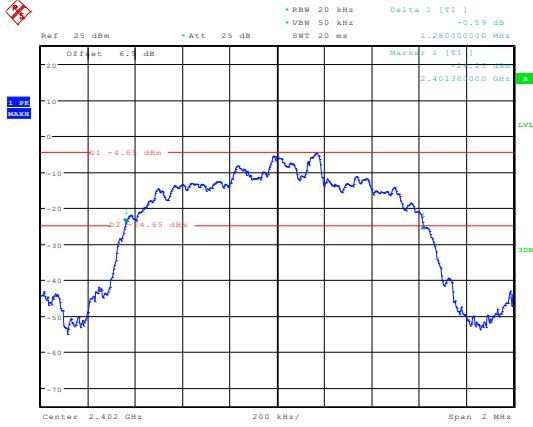
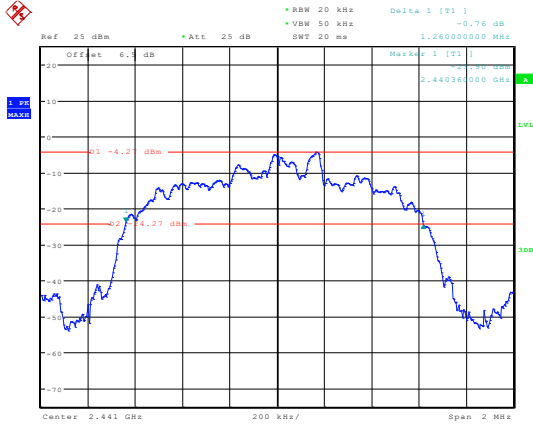
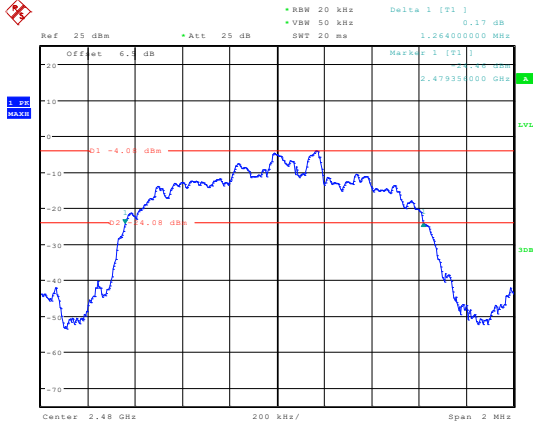
8DPSK	/
Lowest channel	/
 <p>Ref 25 dBm *Att 25 dB *RBW 20 kHz Delta 1 [F1] -0.59 dB *VBW 50 kHz SWT 20 ms 1.260000000 MHz</p> <p>Offset 6.3 dB Marker 1 [F1] 2.40198000 GHz -01 -4.65 dBm -02 -4.65 dBm</p> <p>Center 2.402 GHz 200 kHz/ Span 2 MHz</p> <p>Date: 28.DEC.2023 17:21:03</p>	/
Middle channel	/
 <p>Ref 25 dBm *Att 25 dB *RBW 20 kHz Delta 1 [F1] -0.76 dB *VBW 50 kHz SWT 20 ms 1.260000000 MHz</p> <p>Offset 6.3 dB Marker 1 [F1] 2.44036000 GHz -01 -4.27 dBm -02 -4.27 dBm</p> <p>Center 2.441 GHz 200 kHz/ Span 2 MHz</p> <p>Date: 28.DEC.2023 17:21:58</p>	/
High channel	/
 <p>Ref 25 dBm *Att 25 dB *RBW 20 kHz Delta 1 [F1] 0.17 dB *VBW 50 kHz SWT 20 ms 1.260000000 MHz</p> <p>Offset 6.3 dB Marker 1 [F1] 2.47935000 GHz -01 -4.08 dBm -02 -4.08 dBm</p> <p>Center 2.48 GHz 200 kHz/ Span 2 MHz</p> <p>Date: 28.DEC.2023 17:22:37</p>	/

**99% Occupied Bandwidth:**

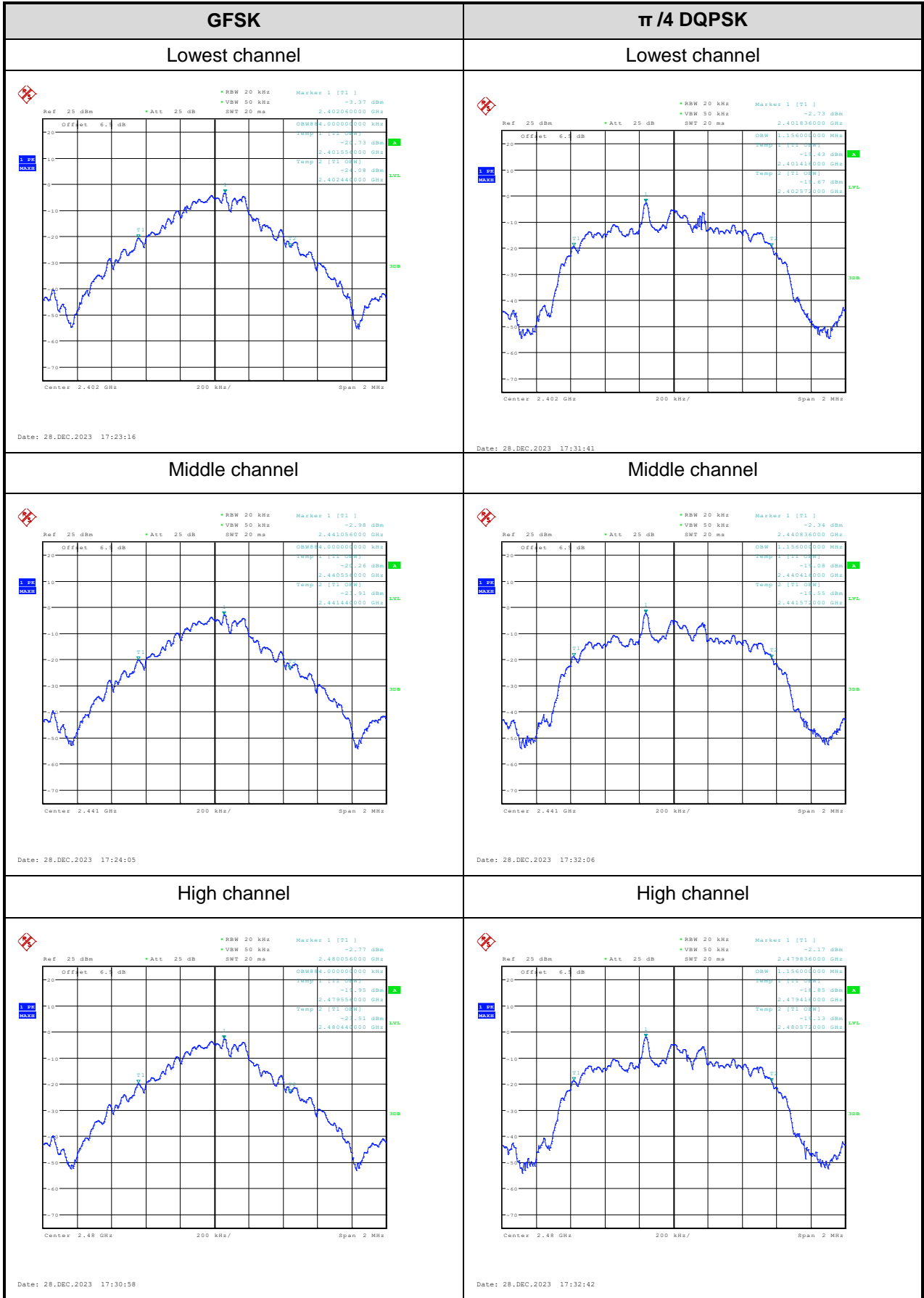

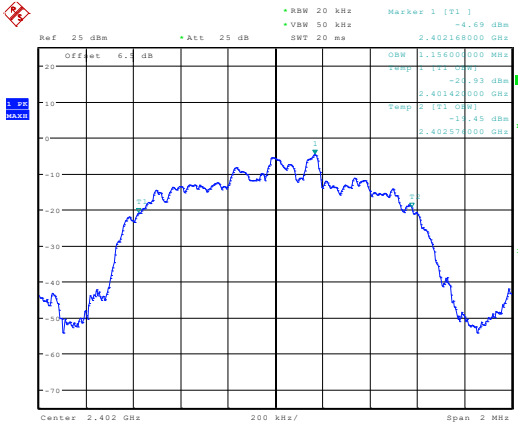
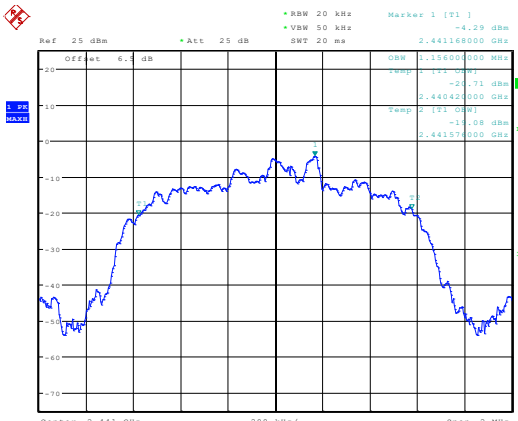
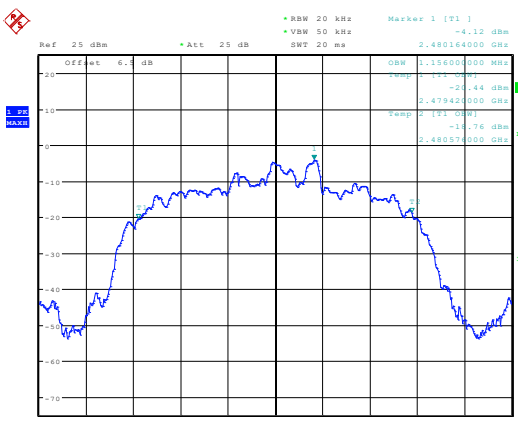
8DPSK	/
Lowest channel	/
 <p>Date: 28.DEC.2023 17:33:59</p>	/
Middle channel	/
 <p>Date: 28.DEC.2023 17:34:25</p>	/
High channel	/
 <p>Date: 28.DEC.2023 17:35:07</p>	/

**Maximum Conducted Peak Output Power:**

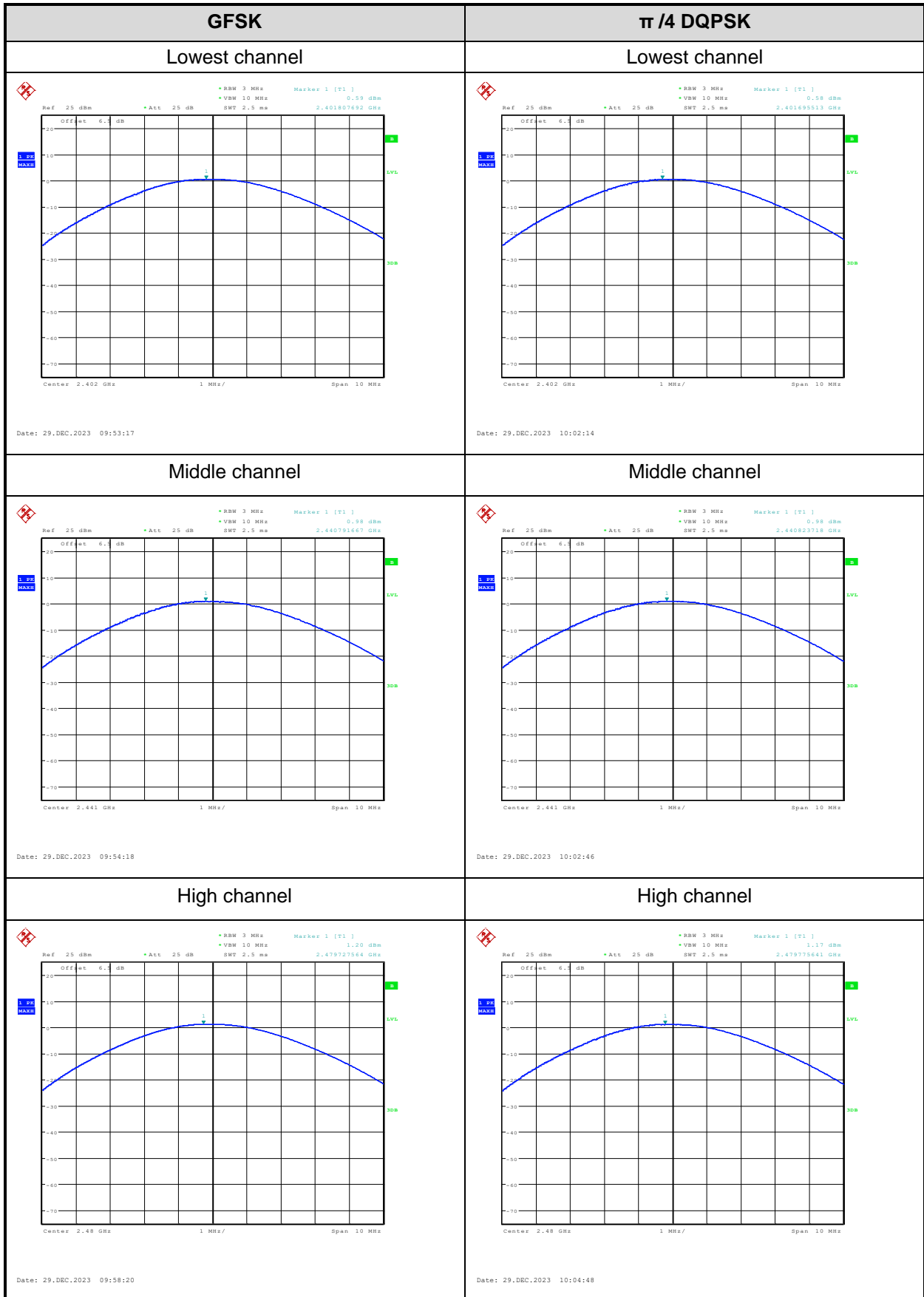

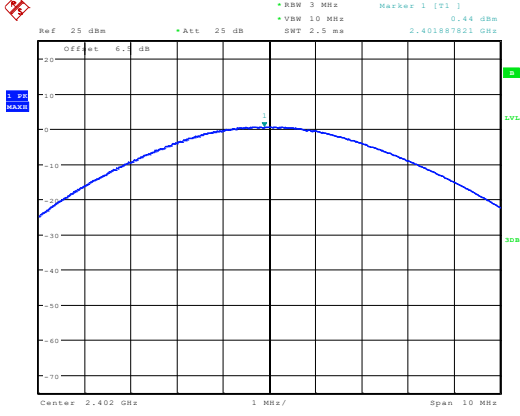
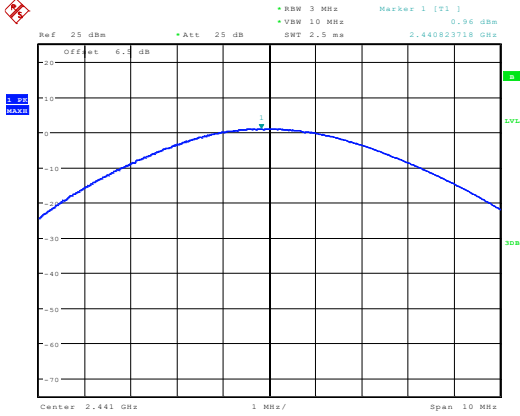
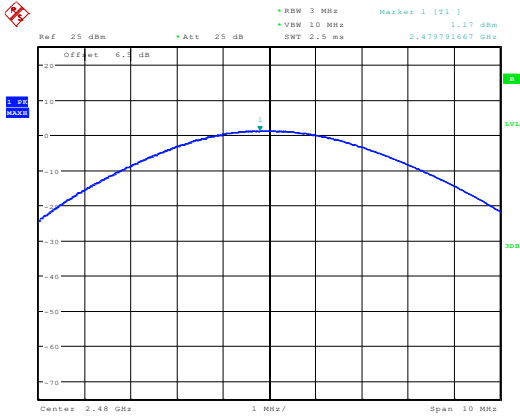
8DPSK	/
<p style="text-align: center;">Lowest channel</p>	/
 <p>Date: 29.DEC.2023 10:06:04</p>	/
<p style="text-align: center;">Middle channel</p>	/
 <p>Date: 29.DEC.2023 10:06:32</p>	/
<p style="text-align: center;">High channel</p>	/
 <p>Date: 29.DEC.2023 10:07:29</p>	/

**Channel separation:**

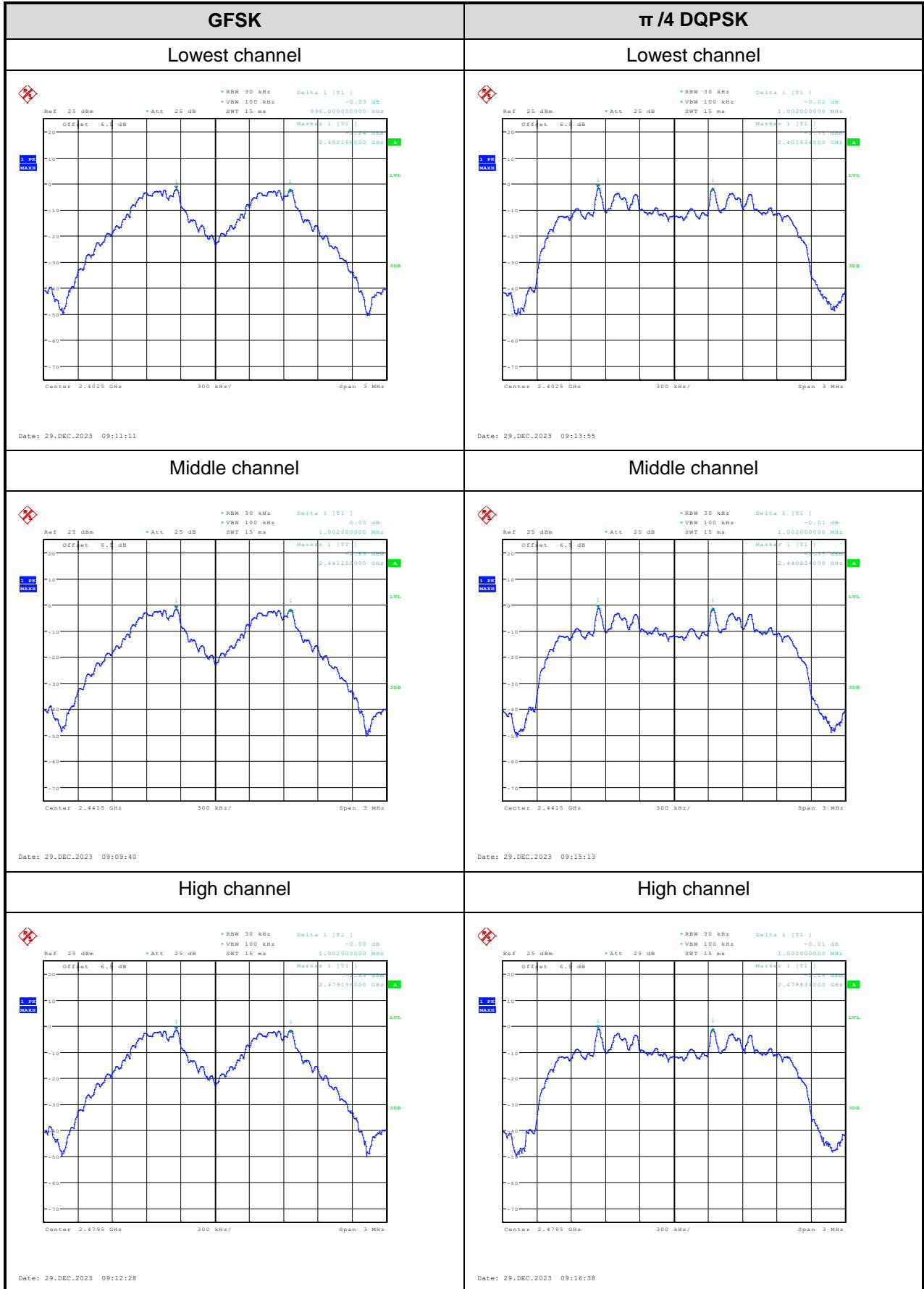

8DPSK	/
Lowest channel	/
<p>Ref: 25 dBm    Att: 25 dB    RBW: 30 kHz    VBW: 100 kHz    SWT: 15 ms    Delta: 1 [F1]    -0.00 dB</p> <p>Center: 2.4025 GHz    Span: 3 MHz</p>	/
Middle channel	/
<p>Ref: 25 dBm    Att: 25 dB    RBW: 30 kHz    VBW: 100 kHz    SWT: 15 ms    Delta: 1 [F1]    -0.03 dB</p> <p>Center: 2.4415 GHz    Span: 3 MHz</p>	/
High channel	/
<p>Ref: 25 dBm    Att: 25 dB    RBW: 30 kHz    VBW: 100 kHz    SWT: 15 ms    Delta: 1 [F1]    0.01 dB</p> <p>Center: 2.4795 GHz    Span: 3 MHz</p>	/



**Number of hopping Frequency**

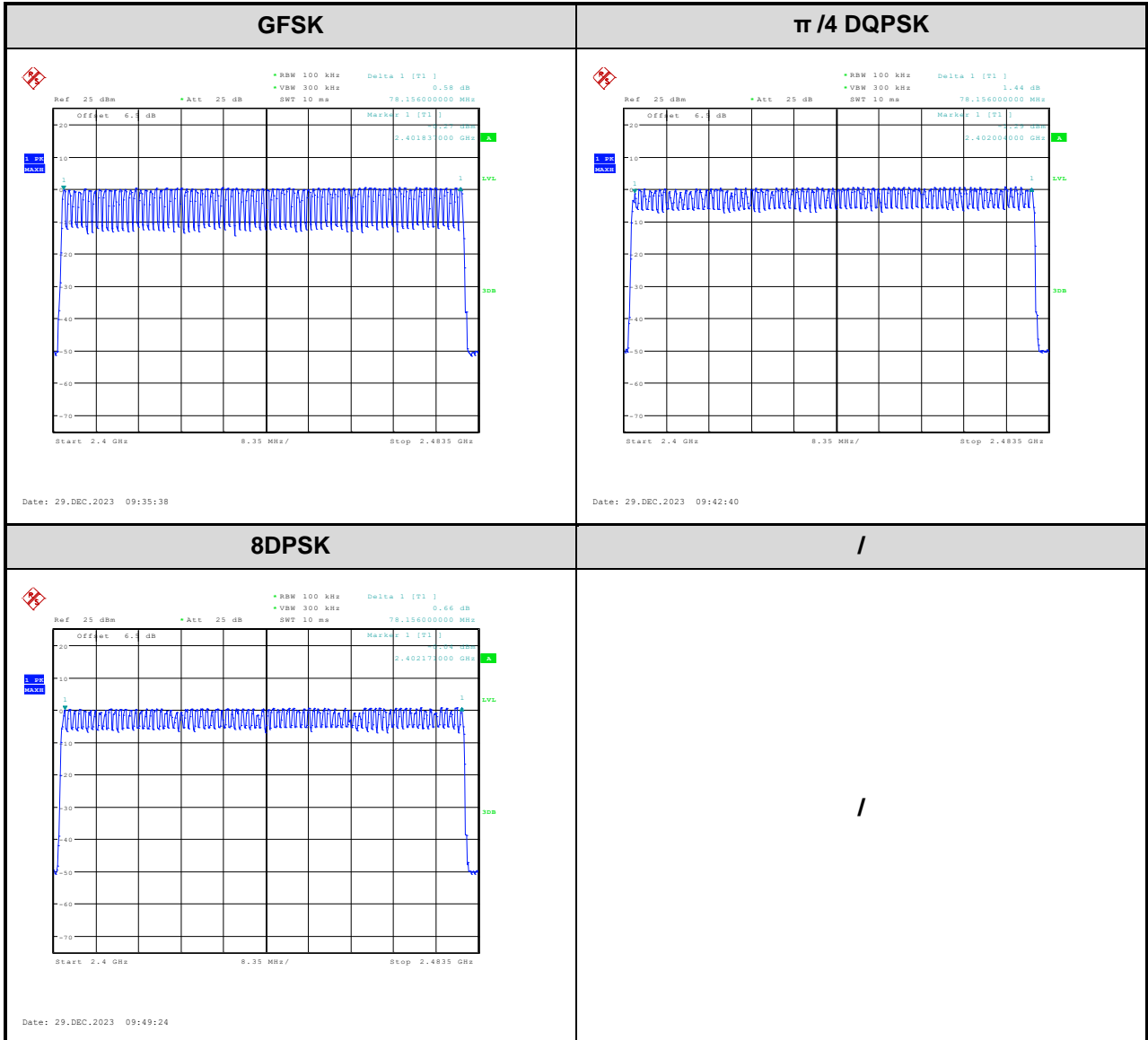

**Time of occupancy (dwell time)**

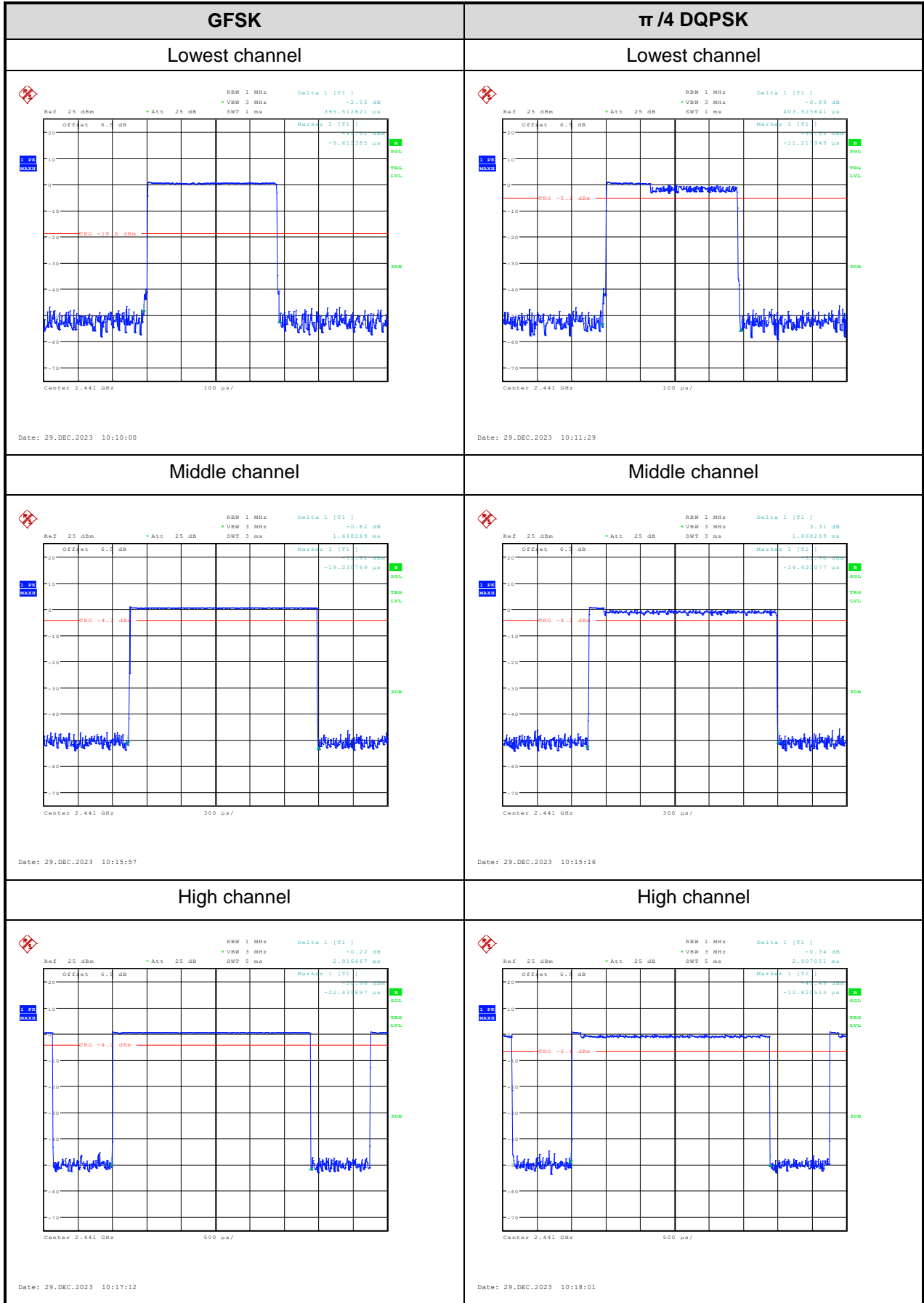

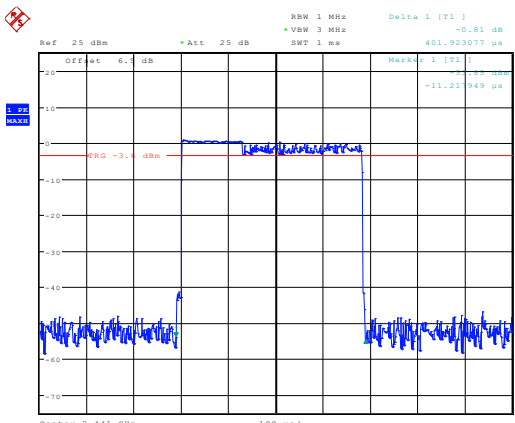
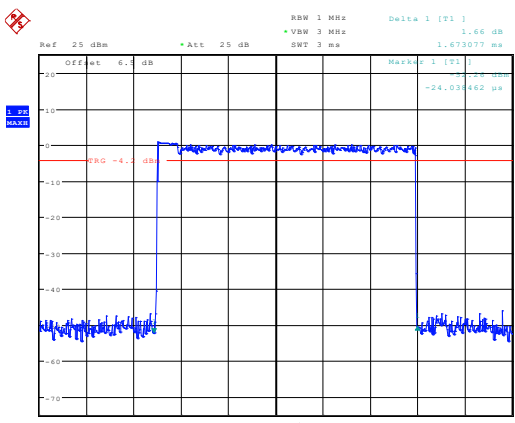
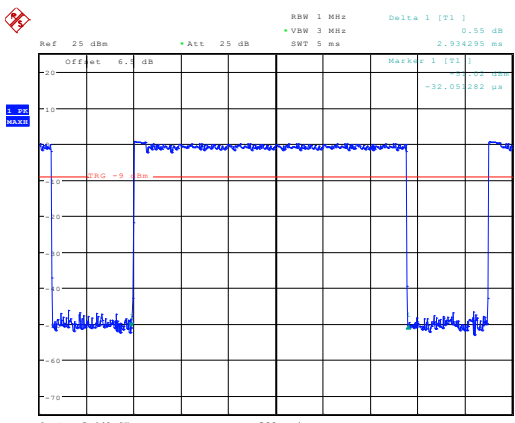
8DPSK	/
Lowest channel	/
 <p>Date: 29.DEC.2023 10:12:42</p>	/
Middle channel	/
 <p>Date: 29.DEC.2023 10:14:30</p>	/
High channel	/
 <p>Date: 29.DEC.2023 10:18:44</p>	/

**100kHz Bandwidth of Frequency Band Edge:**

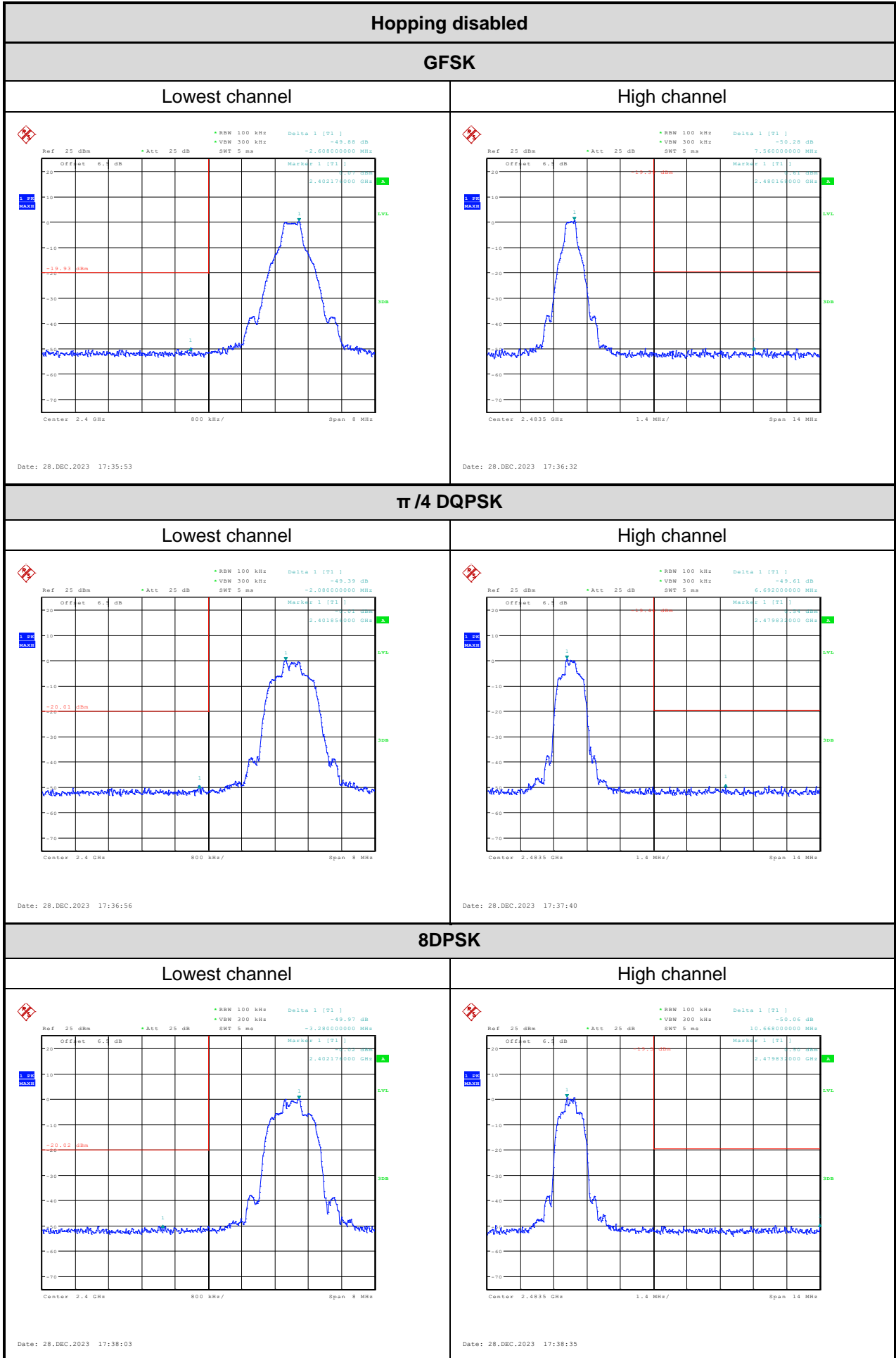

**Hopping enabled**

**GFSK**

**Lowest channel**

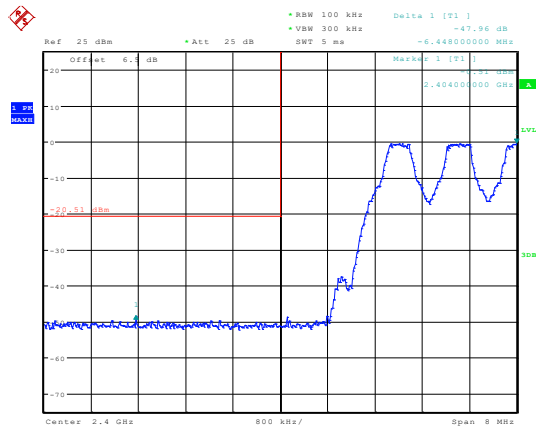

Date: 28.DEC.2023 17:40:52

**High channel**

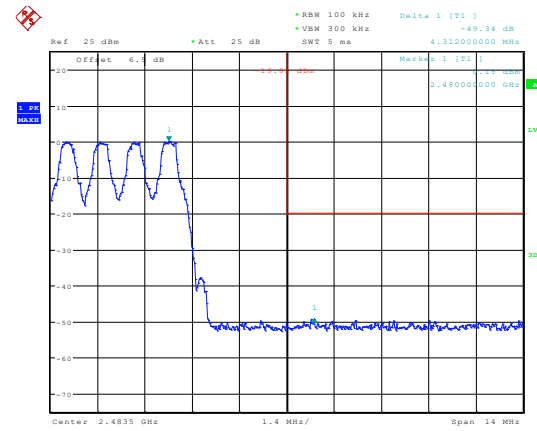

Date: 28.DEC.2023 17:41:53

**$\pi/4$  DQPSK**

**Lowest channel**

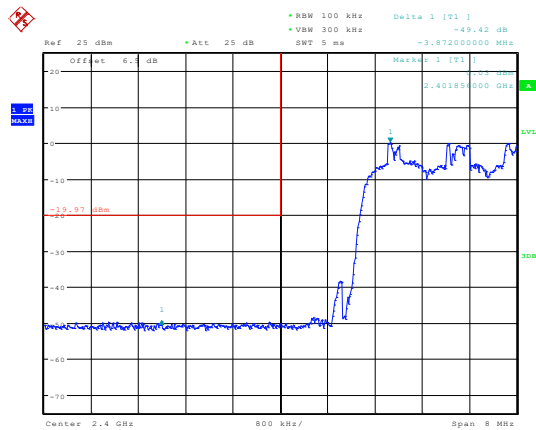

Date: 28.DEC.2023 17:44:07

**High channel**

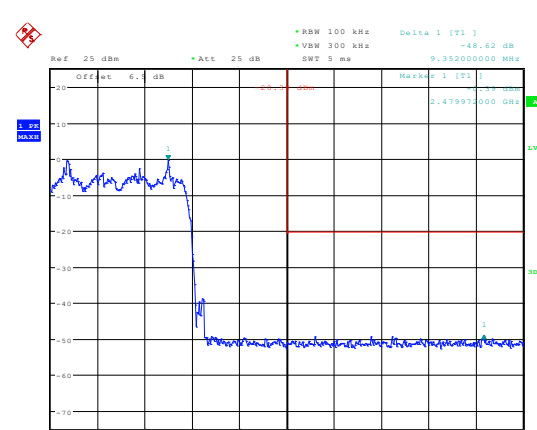

Date: 28.DEC.2023 17:46:16

**8DPSK**

**Lowest channel**

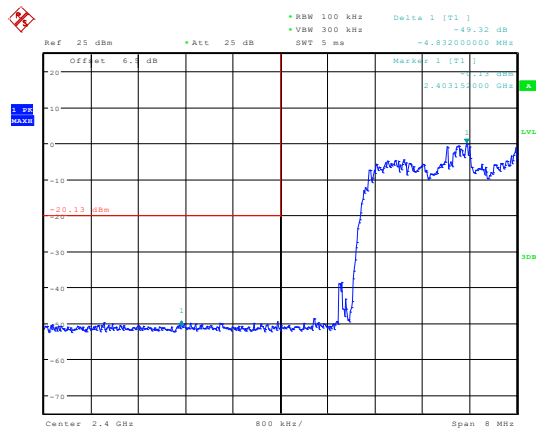

Date: 28.DEC.2023 17:54:08

**High channel**

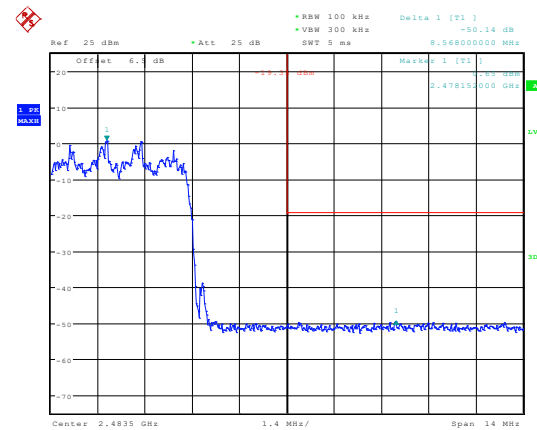

Date: 28.DEC.2023 17:57:18

## 4 Test Setup Photo

Please refer to the attachment RWAZ202300088 Test Setup photo.

## 5 E.U.T Photo

Please refer to the attachment RWAZ202300088 External photo and RWAZ202300088 Internal photo.

**---End of Report---**