

Antenna Specification

Specifications Summary

ITEM	SPEC.	
	2.4GHz	
Center Frequency	2402 MHz	2.70 dBi
	2442 MHz	3.01 dBi
	2484 MHz	3.08dBi
MAX. GAIN	3.08 dBi	

ITEM	SPEC.	
	5 GHz	
Center Frequency	5150 MHz	3.56 dBi
	5300 MHz	3.90 dBi
	5500 MHz	4.17dBi
	5800 MHz	3.96dBi
MAX. GAIN	4.17 dBi	

Antenna Photo & Length

天线类型/
ANT Type:

PCB

天线型号/
ANT Model:

2.4G&5G ANT1

制造商/
Manufactory:

YEALINK(XIAMEN) NETWORK TECHNOLOGY CO.,LTD.
No.666 Hu'an Rd. Huli District Xiamen City, Fujian, P.R. China

天线尺寸/ANT Size

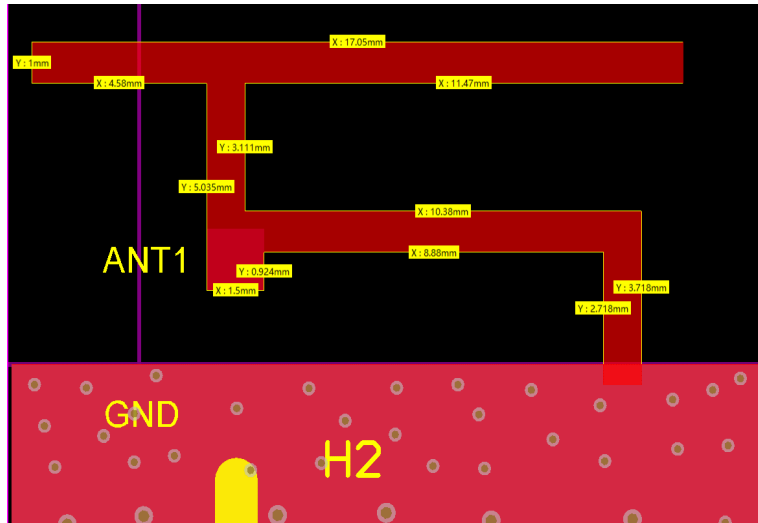

2402MHz

3D Antenna Pattern

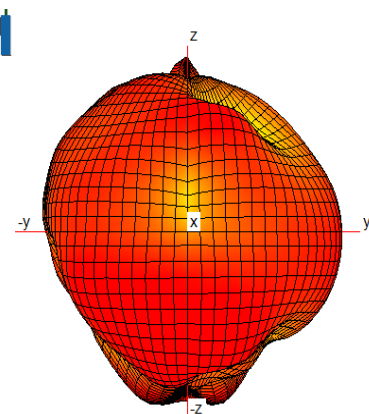

2D Antenna Pattern (X->Y; X->Z; Y->Z)

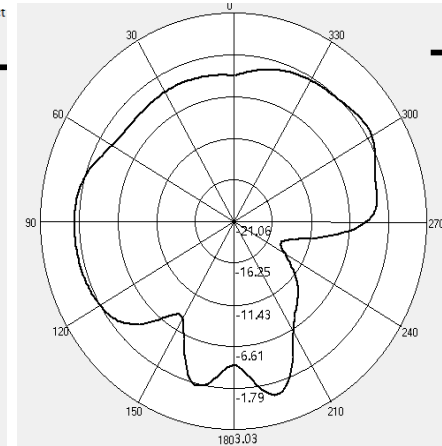
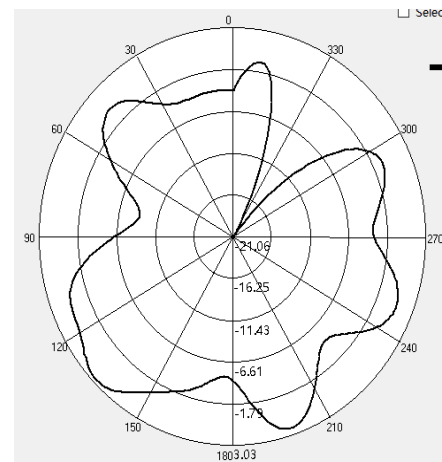
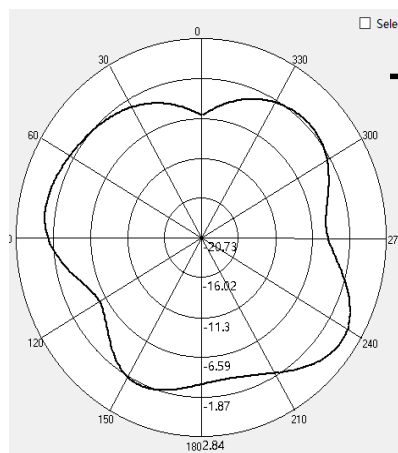

2442MHz

3D Antenna Pattern

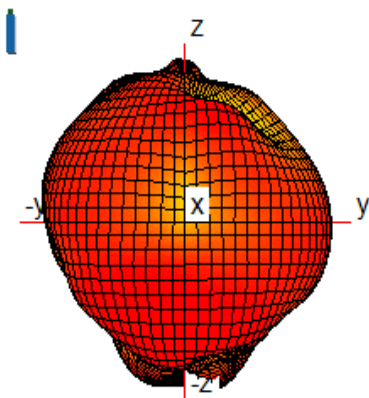

2D Antenna Pattern (X->Y; X->Z; Y->Z)

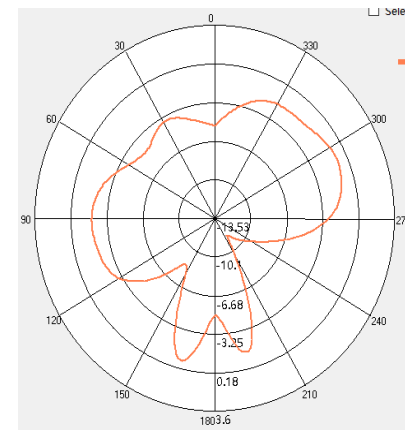
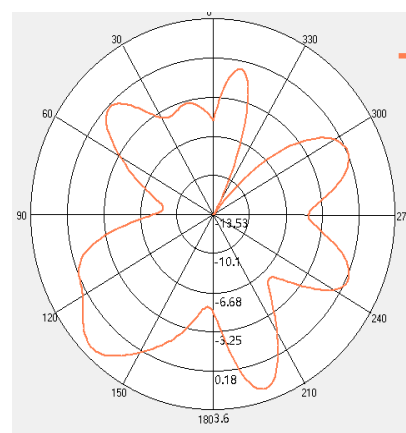
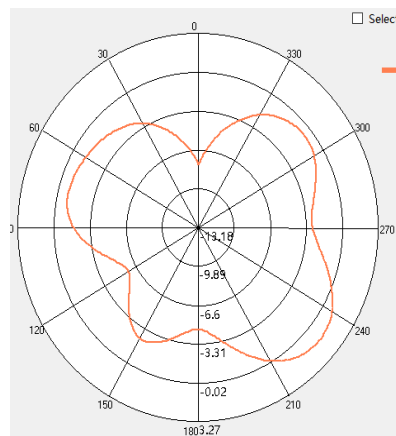

2484MHz

3D Antenna Pattern

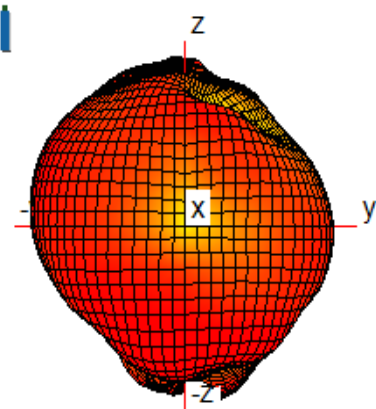

2D Antenna Pattern (X->Y;X->Z;Y->Z)

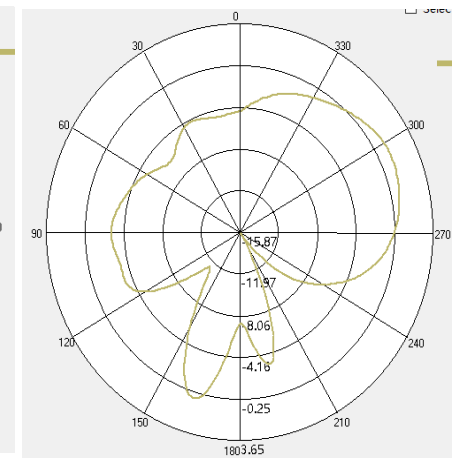
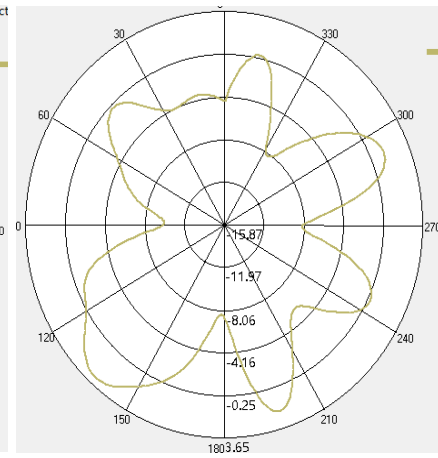
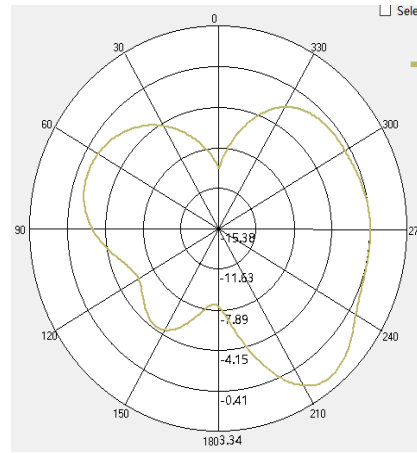

Point Values	Minimum Gain (dBi)	Maximum Gain (dBi)	Average Gain (dBi)
Frequency (MHz)			
2402	-20.5626	2.69034	-2.22547
2442	-13.1450	3.01236	-2.08147
2484	-15.0996	3.07903	-2.03502

5150MHz

3D Antenna Pattern

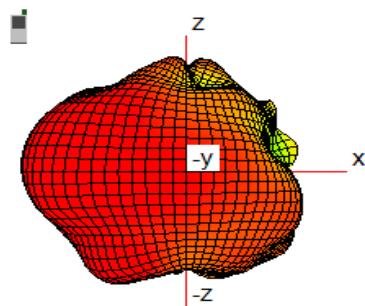

2D Antenna Pattern (X->Y;X->Z;Y->Z)

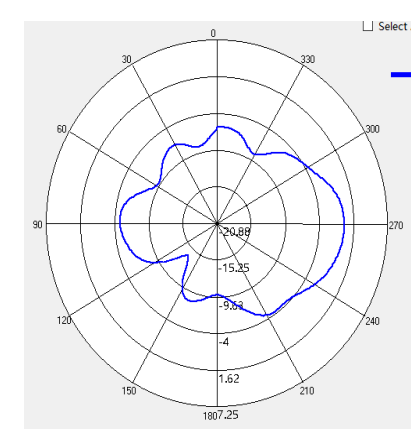
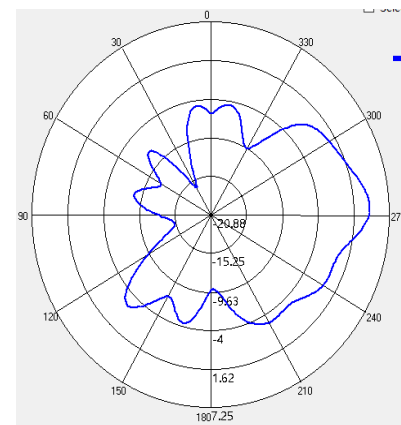
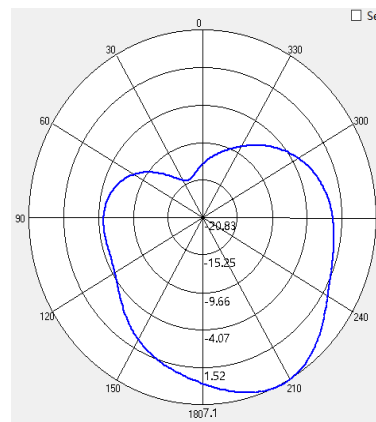

5300MHz

3D Antenna Pattern

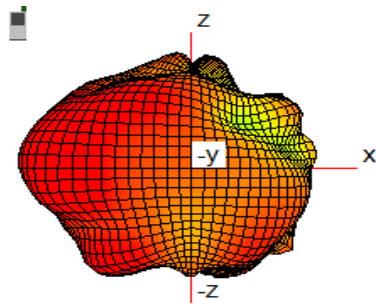

2D Antenna Pattern (X->Y;X->Z;Y->Z)

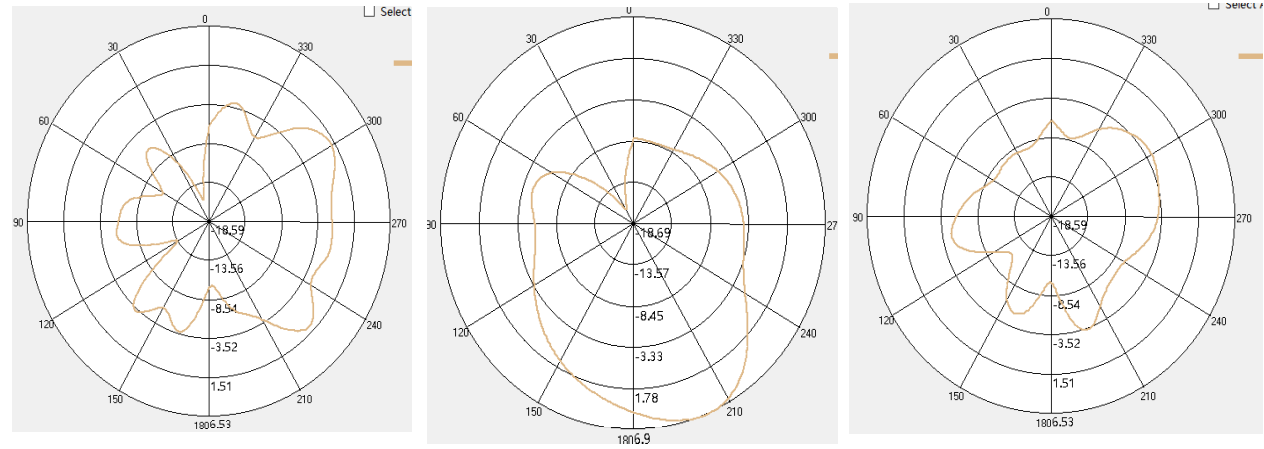

5500MHz

3D Antenna Pattern

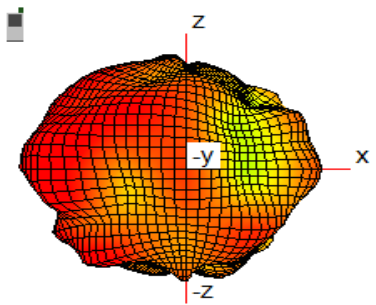

2D Antenna Pattern (X->Y;X->Z;Y->Z)

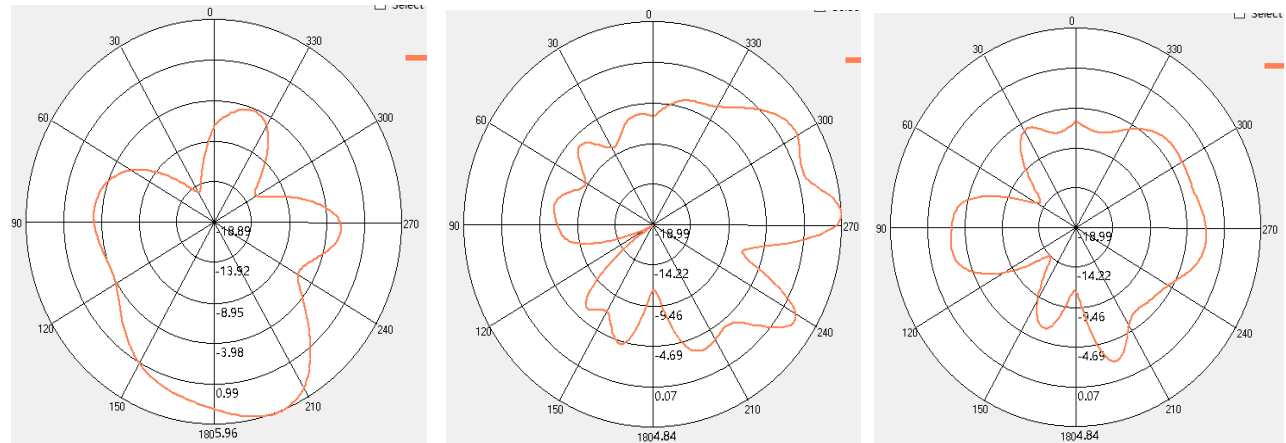

5800MHz

3D Antenna Pattern

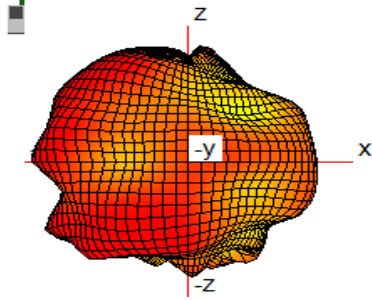

2D Antenna Pattern (X->Y; X->Z; Y->Z)

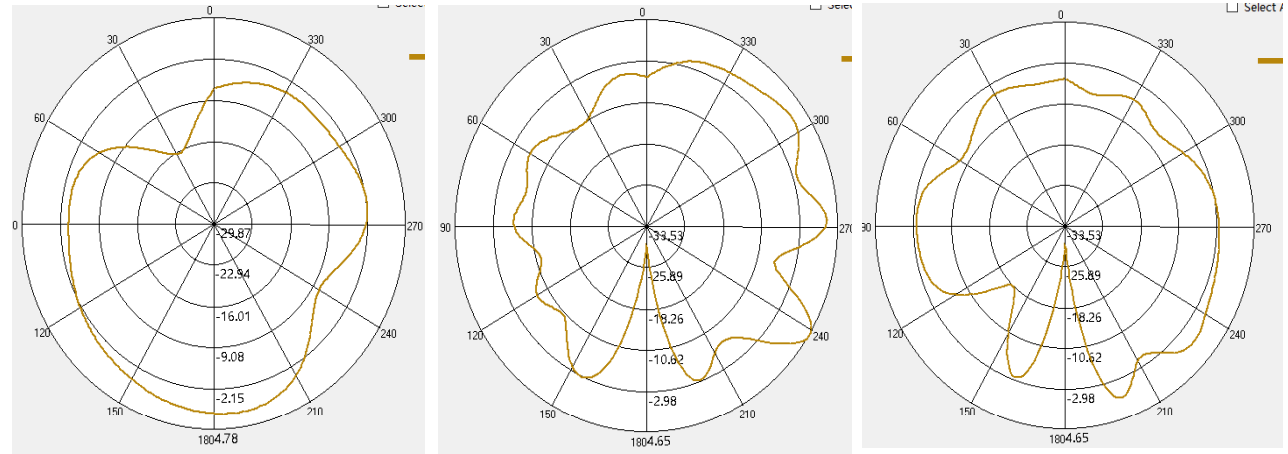

Point Values	Minimum Gain (dBi)	Maximum Gain (dBi)	Average Gain (dBi)
Frequency (MHz)			
5150	-20.7504	3.56123	-2.21183
5300	-18.5852	3.89654	-2.82318
5500	-18.8947	4.17349	-3.44260
5800	-29.7918	3.95516	-3.40713