

Transceiver Module
TCM 300 / TCM 300C
TCM 320 / TCM 320C

February 26, 2010



Observe precautions! Electrostatic sensitive devices!

Patent protected:

WO98/36395, DE 100 25 561, DE 101 50 128,
WO 2004/051591, DE 103 01 678 A1, DE 10309334,
WO 04/109236, WO 05/096482, WO 02/095707,
US 6,747,573, US 7,019,241

REVISION HISTORY

The following major modifications and improvements have been made to the first version of this document:

No	Major Changes
0.6	Chapter 4 modified, Drawing in 1.3 corrected; Chapter 3.6 added.
0.7	Chapter 3.8 added; Operating temperature range limited to -25 °C/+85 °C; RX sensitivity reduced to -94 dBm; Layout recommendation in 3.5 modified; Change in 2.2.: Do not connect pins marked as n.c.; Maximum Ratings (non-operating) modified in 2.3; Maximum Ratings (operating) added in 2.4
0.75	Section 2.2.1 updated; output currents reduced in 2.2
0.8	Receive current increased to typ. 33 mA; Section 3.5 modified; recommended foot pattern added in 3.6.1; new drawings in 1.3; section 2.7 Repeater Configuration added; section 2.10 Smart Acknowledge added; section 3.8 Tape&Reel spec. added; RX sensitivity reduced to -93dBm; section 3.10 added
0.9	Max. ripple at VDD reduced to 50 mVpp; Connect external 1 kΩ pull-down to RESET and PROG_EN; Supply voltage range modified: starting at 2.6V; section 3.11 added

Published by EnOcean GmbH, Kolpingring 18a, 82041 Oberhaching, Germany
 www.enocean.com, info@enocean.com, phone +49 (89) 6734 6890

© EnOcean GmbH
 All Rights Reserved

Important!

This information describes the type of component and shall not be considered as assured characteristics. No responsibility is assumed for possible omissions or inaccuracies. Circuitry and specifications are subject to change without notice. For the latest product specifications, refer to the EnOcean website: <http://www.enocean.com>.

As far as patents or other rights of third parties are concerned, liability is only assumed for modules, not for the described applications, processes and circuits.

EnOcean does not assume responsibility for use of modules described and limits its liability to the replacement of modules determined to be defective due to workmanship. Devices or systems containing RF components must meet the essential requirements of the local legal authorities.

The modules must not be used in any relation with equipment that supports, directly or indirectly, human health or life or with applications that can result in danger for people, animals or real value.

Components of the modules are considered and should be disposed of as hazardous waste. Local government regulations are to be observed.

Packing: Please use the recycling operators known to you. By agreement we will take packing material back if it is sorted. You must bear the costs of transport. For packing material that is returned to us unsorted or that we are not obliged to accept, we shall have to invoice you for any costs incurred.

TABLE OF CONTENT

1	GENERAL DESCRIPTION	5
1.1	Basic functionality	5
1.2	Technical data.....	5
1.3	Physical dimensions	6
1.4	Environmental conditions.....	7
1.5	Ordering information.....	7
2	FUNCTIONAL DESCRIPTION	8
2.1	Pin out.....	8
2.2	Pin description and operational characteristics	9
2.2.1	Interface supply voltage - IOVDD.....	11
2.3	Absolute maximum ratings (non operating).....	12
2.4	Maximum ratings (operating).....	12
2.5	Operating modes.....	13
2.6	Mode selection	14
2.7	Repeater configuration	15
2.8	Teach-in procedure.....	16
2.8.1	Setting the receiver to learning mode.....	16
2.8.2	Confirmation of Learning Mode	16
2.8.3	Teaching in a transmitter.....	16
2.8.4	Confirmation of correct learning/deletion	17
2.8.5	Learning of further transmitters.....	17
2.8.6	Selecting the next channel.....	17
2.8.7	Leaving learning mode	17
2.8.8	Deleting a transmitter	17
2.9	Remote management.....	18
2.9.1	Remote Management Control Commands (RMCC)	18
2.9.2	Remote Procedure Calls (RPC).....	18
2.10	Smart Acknowledge	19
2.11	Transmit timing.....	19
3	APPLICATIONS INFORMATION	20
3.1	Transmission range	20
3.2	Antenna options TCM 300 / TCM 300C.....	21
3.2.1	Overview.....	21
3.2.2	Whip antenna	22
3.2.3	Chip antenna	23
3.2.4	Splatch antenna	25
3.2.5	Helical antenna	26
3.3	Antenna options TCM 320 / 320C.....	27
3.3.1	Mounting the whip antenna	27
3.3.2	Mounting 50 Ω antennas.....	28
3.4	Recommendations for laying a whip antenna	29
3.5	Power supply requirements.....	30
3.6	Layout recommendations.....	30
3.6.1	TCM 300/300C recommended foot pattern	31
3.7	Soldering information.....	34
3.7.1	TCM 300 / TCM 300C	34
3.7.2	TCM 320 / TCM 320C	35
3.8	Tape & Reel specification TCM 300 / TCM 300C.....	35



- 3.9 Backward compatibility to TCM 220C36
- 3.10 Using RVDD36
- 3.11 Voltage dips.....36
- 4 AGENCY CERTIFICATIONS (after release for series production)37
 - 4.1 CE approval.....37
 - 4.2 FCC (United States) Certification38
 - 4.3 IC (Industry Canada) Certification.....40
- A APPENDIX41
 - A.1 EnOcean serial protocol41
 - A.1.1 Message format.....41
 - A.1.2 Byte signals and bit order41
 - A.2 Radio transmission/reception commands42
 - A.2.1 Description of serial data structure.....42
 - A.2.2 Detailed description of ORG field.....43
 - A.2.3 Detailed description of STATUS field43
 - A.2.4 Detailed description of DATA_BYTE 3..0 fields.....44
 - A.3 Command telegrams and messages47
 - A.3.1 ID Range commands.....47
 - A.3.2 Receiver sensitivity commands47
 - A.3.3 Reset command47
 - A.3.4 SW Version.....47
 - A.3.5 Error messages47
 - A.3.6 Command Encoding48

PRELIMINARY

1 GENERAL DESCRIPTION

1.1 Basic functionality

The transceiver modules TCM 300 / 300C and TCM 320 / 320C enable the realization of highly efficient RF repeaters and transceivers for the EnOcean 868 MHz and 315 MHz radio systems.

The module provides several built-in operating modes. In addition repeater functionality (1 or 2 level) can be activated. Using the Dolphin API library it is possible to write custom software for the module. All module variants are in-system programmable.

Built-in operating modes

- Unidirectional serial communication
- Bidirectional serial communication
- 1-channel relay mode
- 4-channel relay mode
- 1-channel dimming mode

Product variants

- TCM 300/300C: SMD mountable module for use with external antenna (868/315 MHz)
- TCM 320/320C: Variant for vertical mounting with pin connector. Whip antenna. (868/315 MHz). TCM 320C is backward compatible to TCM 220C

Features accessible via API:

- Integrated 16 MHz 8051 CPU with 32 KB FLASH and 2 kB SRAM
- Various power down and sleep modes down to 0.2 μ A current consumption (TCM 320/TCM 320C limited to 1.4 mA current consumption!)
- Up to 14 configurable I/Os
- 10 bit ADC, 8 bit DAC

1.2 Technical data

Antenna	Pre-installed 8.6 cm/15 cm whip antenna (TCM 320/TCM 320C) External whip or 50 Ω antenna mountable (TCM 300/TCM 300C)
Frequency	315.0 MHz (TCM 3X0C)/868.3 MHz (TCM 3X0)
Radio Standard	EnOcean 868 MHz/315 MHz
Data rate/Modulation type	125 kbps/ASK
Receiver Sensitivity (at 25°C)	typ. -93 dBm
Conducted Output Power	typ. 5 dBm
Power Supply	2.6 V-3.3 V (TCM 320/320C), 2.6 V-4.5 V (TCM 300/300C)
Current Consumption	Receive mode: typ. 33 mA, max. 43 mA (RX) Transmit mode: typ. 24 mA, max. 33 mA (TX)
Radio Regulations	R&TTE EN 300 220 (TCM 300/TCM 320) FCC CFR-47 Part 15 (TCM 300C/TCM 320C)

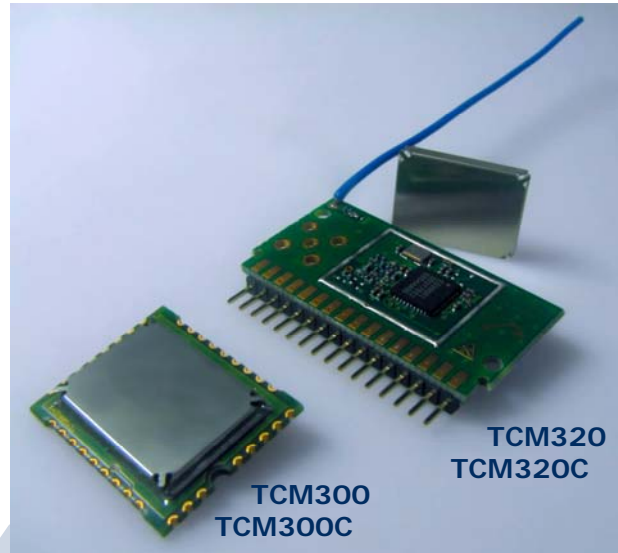

TCM 300 / 300C / 320 / 320C

1.3 Physical dimensions

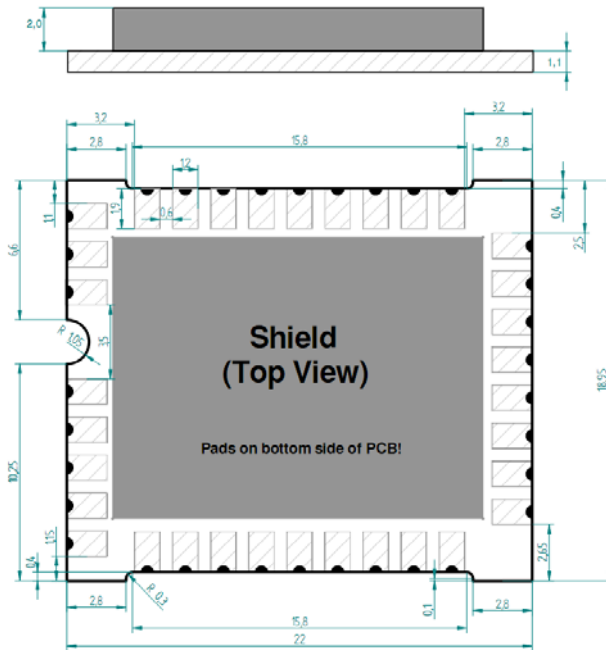

Unless otherwise specified dimensions are in mm.

Tolerances:
 PCB outline dimensions ± 0.2 mm
 All other tolerances ± 0.1 mm

TCM 300 / TCM 300C (pads on bottom side of PCB!)

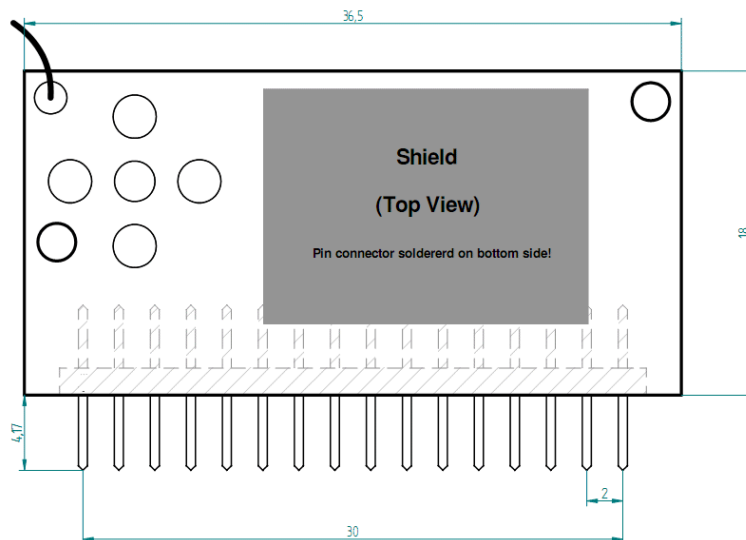
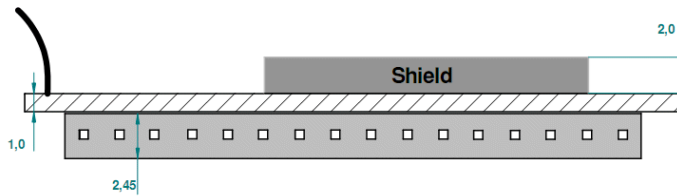

Unless otherwise specified dimensions are in mm.

Tolerances:
 PCB outline dimensions ± 0.2 mm
 All other tolerances ± 0.1 mm

TCM 320 / TCM 320C

PCB dimensions	TCM 320/TCM 320C (without pin connector): 36.5 x 19 x 5.5 mm TCM 300/TCM 300C: 22 x 19 x 3.1 mm
Pin connector	16 pins, grid 2.0 mm (4.0 mm in length, □ 0.5 mm)

1.4 Environmental conditions

Operating temperature	-25 °C ... +85 °C
Storage temperature	-40 °C ... +85 °C
Storage temperature in tape & reel package	-20 °C ... +50 °C
Humidity	0% ... 93% r.H., non-condensing

1.5 Ordering information

Type	Ordering Code	Frequency
TCM 300	S3003-K300	868.3 MHz
TCM 320	S3003-K320	868.3 MHz
TCM 300C	S3033-K300	315.0 MHz
TCM 320C	S3033-K320	315.0 MHz

2 FUNCTIONAL DESCRIPTION

2.1 Pin out

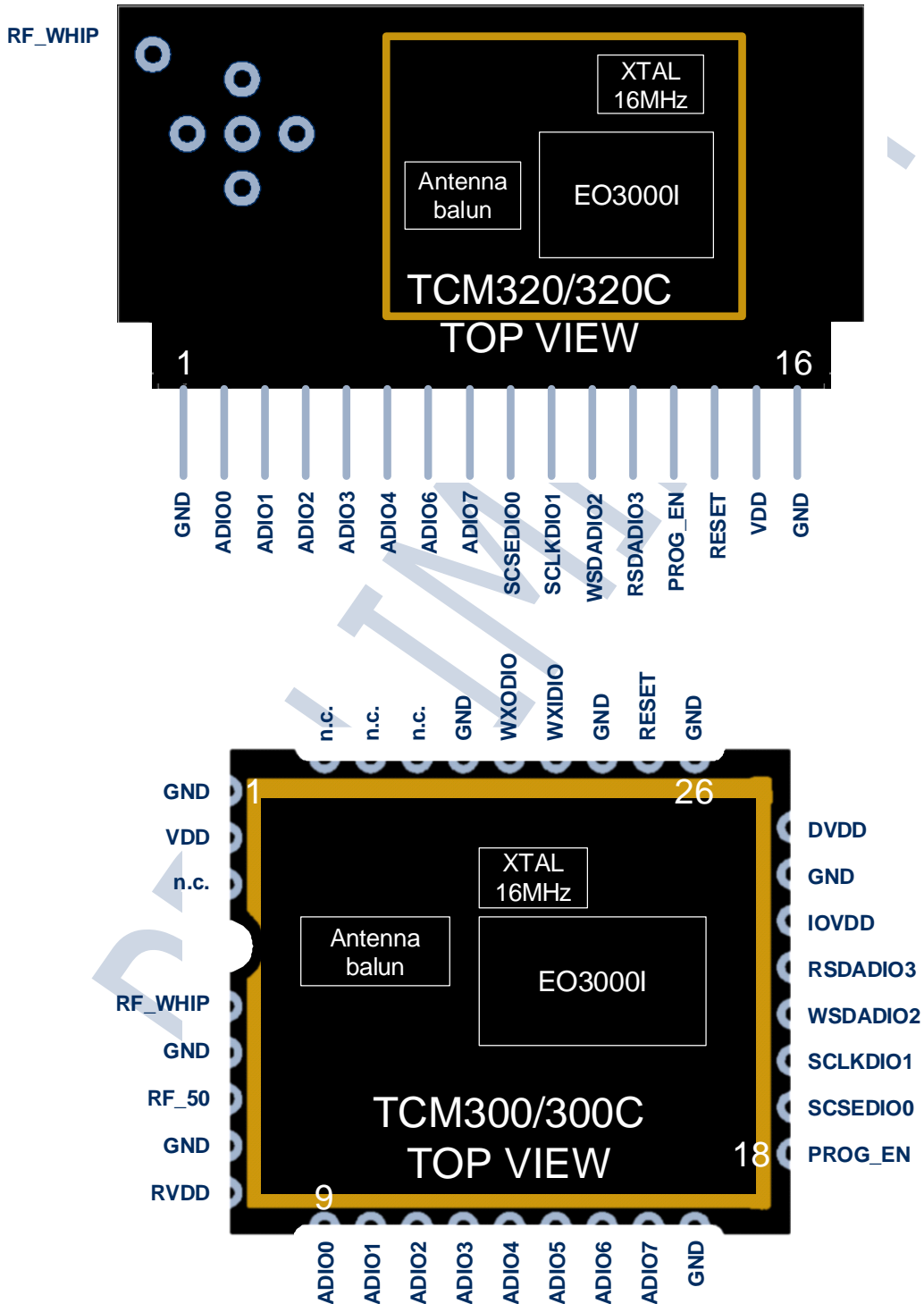

2.2 Pin description and operational characteristics

Symbol	Function	Characteristics
GND	Ground connection	Must be connected to GND
VDD	Supply voltage	TCM 300/300C: 2.6 V – 4.5 V TCM 320/320C: 2.6 V – 3.3 V Max. ripple: see 2.4
RVDD	RF supply voltage regulator output	1.8 V Output current: <ul style="list-style-type: none"> ■ max. 100 µA with built-in firmware (RX on) ■ max. 10 mA while not in RX/TX mode
DVDD	Digital supply voltage regulator output	1.8 V Output current: max. 5 mA
IOVDD	Digital interface supply voltage	TCM 320/320C: internally connected to VDD TCM 300/300C: Must be connected to desired interface supply between 1.8 V and 3.3 V See also 2.2.1.
RESET	Reset input Programming I/F	Active high reset (1.8 V). External 1 kΩ pull-down required.
PROG_EN	Programming I/F	HIGH: programming mode active LOW: operating mode Digital input, external 1 kΩ pull-down required.
ADIO0	MODE_SEL	Analog input: At start-up input voltage is measured and mode is selected. See chapter 0
ADIO1	MODE 0: not used	In mode 0 the repeater level is 1 and cannot be modified.
	MODE 1-4: REP_LEVEL	Mode 1-4: At start-up the repeater level is selected: Repeater level 1: LOW Repeater level 2: HIGH Digital input, internal pull-up active
ADIO2	REPEATER	At start-up the repeater can be switched on: Repeater on: LOW Repeater off: HIGH Digital input, internal pull-up active
ADIO3	MODE 0: Sensitivity	Low sensitivity: LOW High sensitivity: HIGH Digital input, internal pull-up active
	MODE 1-4: LRN	Enter/leave teach-in mode. See chapter 2.8 Digital input, internal pull-up active
ADIO4	MODE 0: not used	Internal pull-up active
	MODE 1-4: CLR	Clear ID memory. See chapter 2.8 Digital input, internal pull-up active
ADIO5	Not used	Digital output, internally set to LOW
ADIO6	MODE 0-1: SER_RX	UART input
	MODE 2-4: not used	Digital input, internal pull-up active

ADIO7	MODE 0-1: SER_TX	UART output Max. output current: 2 mA @ IOVDD=3.3 V 0.65 mA @ IOVDD=1.8 V
	MODE 2-3: CHANNEL0	Digital output channel 0 Max. output current: 2 mA @ IOVDD=3.3 V 0.65 mA @ IOVDD=1.8 V
	MODE 4: not used	Digital output, internally set to LOW
	Programming I/F	
SCSEDIO0	MODE 0, 2: not used	Digital output, internally set to LOW
	MODE 1: LRN_TOGGLE	Digital output Max. output current: 2 mA @ IOVDD=3.3 V 0.65 mA @ IOVDD=1.8 V
	MODE 3: CHANNEL1	Digital output channel 1 Max. output current: 2 mA @ IOVDD=3.3 V 0.65 mA @ IOVDD=1.8 V
	MODE 4: PWM	Dimmer output, 50 kHz
	Programming I/F	
SCLKDIO1	MODE 0-2: not used	Digital output, internally set to LOW
	MODE 3: CHANNEL2	Digital output channel 2 Max. output current: 2 mA @ IOVDD=3.3 V 0.65 mA @ IOVDD=1.8 V
	MODE 4: PWM_IND	Indicating if PWM is active. Digital output. Max. output current: 2 mA @ IOVDD=3.3 V 0.65 mA @ IOVDD=1.8 V
	Programming I/F	
WSDADIO2	MODE 0-2, 4: not used	Digital output, internally set to LOW
	MODE 3: CHANNEL3	Digital output channel 3 Max. output current: 2 mA @ IOVDD=3.3 V 0.65 mA @ IOVDD=1.8 V
	Programming I/F	
RSDADIO3	MODE 0: RMI	Normal operation: Digital output, internally set to LOW Remote Management: ACTION command indicator (see 2.9.1) Max. output current: 2 mA @ IOVDD=3.3 V 0.65 mA @ IOVDD=1.8 V
	MODE 1-4: LMI	Normal operation: Learn mode indicator Remote Management: ACTION command indicator (see 2.9.1) Digital output

		Max. output current: 2 mA @ IOVDD=3.3 V 0.65 mA @ IOVDD=1.8 V
	Programming I/F	
WXIDIO	Not used	Digital output, internally set to LOW
WXODIO	Not used	Digital output, internally set to LOW
RF_WHIP	RF output	Output for whip antenna
RF_50	RF output	50 Ohm output for external antenna
n.c.	Not connected	Do not connect!

2.2.1 Interface supply voltage - IOVDD

For digital communication with other circuitry (peripherals) the digital I/O configured pins of the mixed signal sensor interface (ADIO0 to ADIO7) and the pins of the serial interface (SCSEDIO0, SCLKDIO1, WSDADIO2, RSDADIO3) may be operated from supply voltages different from DVDD. Therefore an interface voltage supply pin IOVDD is available which can be connected either to DVDD or to an external supply within the tolerated voltage range of IOVDD.



If DVDD=0 V (e.g. in any sleepmode) and IOVDD is supplied, there may be unpredictable and varying current from IOVDD caused by internal floating nodes. It must be taken care that the current into IOVDD does not exceed 10 mA while DVDD=0.

If DVDD=0 V and IOVDD is not supplied, do not apply voltage to any above mentioned pin. This may lead to unpredictable malfunction of the device.

In TCM 320/TCM 320C VDD is internally connected to IOVDD! Therefore the above mentioned issues have to be considered when writing own firmware based on API.



IOVDD voltage must not exceed VDD voltage! A malfunction of the module may be caused by such inverse supply!



For I/O pins configured as analog pins the IOVDD voltage level is not relevant!

2.3 Absolute maximum ratings (non operating)

Symbol	Parameter	Min	Max	Units
VDD	Supply voltage at VDD TCM 300	-0.5	5.5	V
	TCM 320 (limitation due to internal VDD-IOVDD connection)	-0.5	3.6	V
IOVDD	Supply voltage for mixed signal sensor interface and serial interface pins	-0.5	3.6	V
GND	Ground connection	0	0	V
VINA	Voltage at every analog input pin	-0.5	2	V
VIND1	Voltage at RESET, and every digital input pin except WXIDIO/WXODIO	-0.5	3.6	V
VIND2	Voltage at WXIDIO / WXODIO input pin	-0.5	2	V

2.4 Maximum ratings (operating)

Symbol	Parameter	Min	Max	Units
VDD	Supply voltage at VDD			
	TCM 300	2.6	4.5	V
	TCM 320	2.6	3.6	V
IOVDD	Digital interface supply voltage (see also 2.2.1)	1.7	MIN (3.6; VDD)	V
GND	Ground connection	0	0	V
VINA	Voltage at every analog input pin	0	2.0	V
VIND1	Voltage at RESET, and every digital input pin except WXIDIO / WXODIO	0	3.6	V
VIND2	Voltage at WXIDIO / WXODIO input pin	0	2.0	V
VDDR	Max. ripple at VDD		50	mVpp

2.5 Operating modes

Mode	Function	Output signal description	No. of channels
0	Unidirectional serial interface compatible with TCM 220C, no teach-in capability	SER_TX: UART output, supplies standard data blocks of information from all received EnOcean radio telegrams (9600 bps; 8 data bits, no parity bit, one start bit, one stop bit). For further information see chapter A.1	
1	Bidirectional serial interface, teach-in capability for up to 30 entries ¹	SER_RX, SER_TX: Asynchronous bidirectional Interface, supplies standard data blocks of information from all received EnOcean radio telegrams (9600 bps; 8 data bits, no parity bit, one start bit, one stop bit). For further information see chapter A.1 LRN_TOGGLE: Learning mode status indicator	
2	Rocker Switch - 1 channel, teach-in capability for up to 30 entries ¹	Supplies the desired logic switching state "on/off" at CHANNEL0 when pushing the switch rockers	1
3	Rocker Switch - 4 channels, teach-in capability for up to 30 entries ²	Same as Mode 2 but operation of 4 receiver channels (CHANNEL0, CHANNEL1, CHANNEL2, CHANNEL3)	4
4	Dimming - 1 channel, teach-in capability for up to 30 entries ¹	PWM is the PWM output <ul style="list-style-type: none"> ■ I-button pressed for shorter than 0.5 s: ON (Restore duty cycle stored before last switch-off). ■ O-button pressed for shorter than 0.5 s: OFF ■ O-/I-button pressed longer than 0.5 s: Duty cycle variation from 10% up to 100% (O=less, I=more). Duty cycle variation stops when button is released. PWM_IND is active as long as duty cycle is not 0%	1
5	Reserved		

¹ Each rocker of a PTM transmitter is counted as 1 entry

² Each rocker is counted as 1 entry. If the same rocker is taught into several channels, 1 entry per channel is needed.

2.6 Mode selection

The operating mode is defined at start-up of the module via a measurement of the voltage at ADIO0.



As long as IDs are stored in ID memory, the operating mode can only be changed after deleting all IDs from memory, e.g. via CLR!

Mode	ADIO0 (MODE_SEL) input voltage range	Proposed component values
0	0% to 3.99% VDD	R1: 0 Ohm R2: leave open R3: leave open C1: leave open
1	4% to 11.99% VDD	R1: 1k2 ±1% R2: 15k ±1% R3: 150k ±1% C1: 100p
2	12% to 19.99% VDD	R1: 2k2 ±1% R2: 12k ±1% R3: 270k ±1% C1: 100p
3	20% to 27.99% VDD	R1: 3k9 ±1% R2: 15k ±1% R3: 68k ±1% C1: 100p
4	28% to 35.99% VDD	R1: 4k7 ±1% R2: 12k ±1% R3: 56k ±1% C1: 100p
5	36% to 39.99% VDD	R1: 5k6 ±1% R2: 10k ±1% R3: 56k ±1% C1: 100p

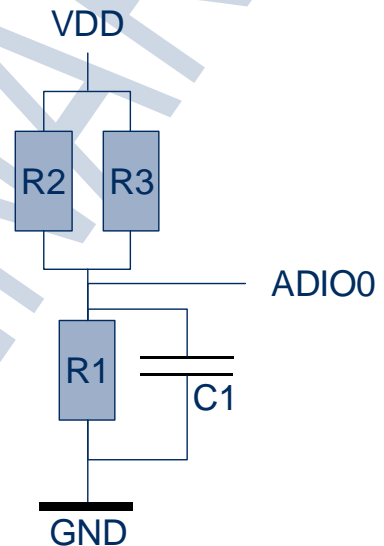

2.7 Repeater configuration

TCM 3x0 provides the option to activate a one or two-level repeater for EnOcean radio telegrams.

1-level repeater: If a received telegram is a valid and original (not yet repeated), the telegram is repeated after a random delay.

2-level repeater: If a received telegram is valid and original or repeated once, the telegram is repeated after a random delay.



2-level repeating function should only be activated if really needed! Otherwise the system function can be compromised by collisions of telegrams.

The repeated telegram is marked as "repeated" by an increased repeater counter.

Setting the repeater level:

At start-up of the module repeater on/off and repeater level are determined. Please refer to the table in 2.2 regarding the configuration options.



Please note that in Mode 0 2-level repeating is not possible (for backward compatibility to TCM 220C)!

The figure below shows an example circuit for a repeater.

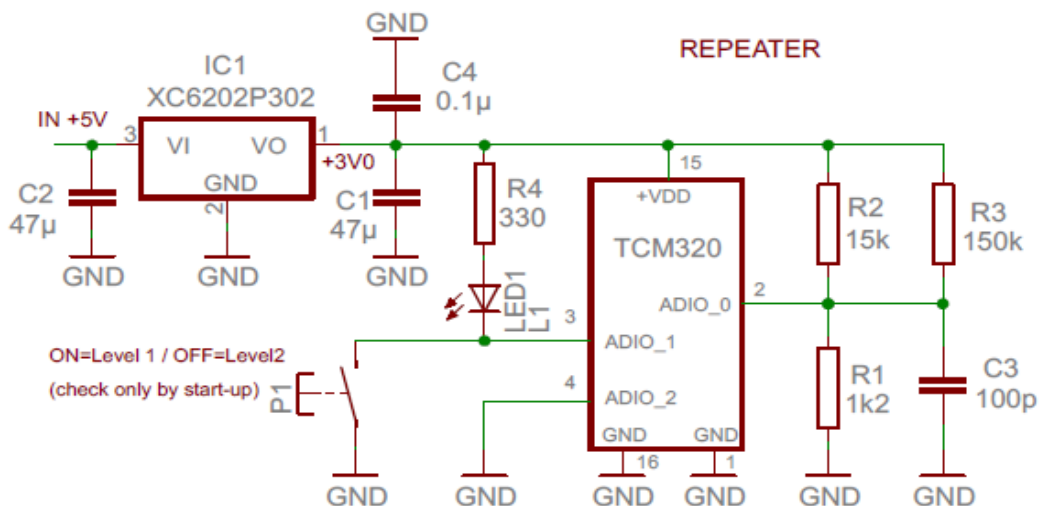

2.8 Teach-in procedure

Modes 1 to 4 support teach-in of transmitters.



Please make sure not to remove supply voltage while in LRN mode! The flash content could get corrupted!

2.8.1 Setting the receiver to learning mode

- **Via CLR Pin (ADIO4):** Contact to GND longer than $t = 2$ seconds. Learning Mode LRN is entered after clearing ID memory.
- **Via LRN Pin (ADIO3):** Contact to GND longer than $t = 0.5$ seconds. In multi-channel receiver mode, the pin has to be contacted several times until the desired channel number is selected (the number of channels is given by the selected operating mode).
- **Via Remote Config Control:** Please refer to documentation of remote management.

2.8.2 Confirmation of Learning Mode

Mode	Confirmation
0	No Learn capability
1	LMI HIGH continuously, LRN_TOGGLE toggling every 1 s.
2	LMI HIGH continuously, CHANNEL0 toggling every 1 s.
3	LMI HIGH continuously, current CHANNELx toggling every 1 s.
4	LMI HIGH continuously, DIM IND HIGH, and PWM toggling every 1 s between 10% and 100%
5	Reserved for future use

2.8.3 Teaching in a transmitter

In learning mode LRN, the sensitivity of the module is limited to in-room operations and learning of repeater powered signals is disabled (to avoid unintentional learning). Therefore ensure that the associated radio transmitter will be in a distance less than 5 m to the receiver (not necessary within Remote Learn Mode).

Trigger the telegram of the associated radio transmitter within 30 seconds:

- Operate the switch radio transmitter (RPS or HRC) at least once (press I-button or O-button of the rocker that is to be assigned to the selected receiver channel). If the same rocker is operated again within 4 seconds it will still be learned. If the same rocker is operated again after more than 4 seconds it will be deleted again. Please note that teach-in without rocker information is not possible! Please note that scene switches (HRC and last 3 ID bits 0B111) cannot be teach-in!
- Or activate the sensor radio transmitter (1BS, 4BS) least once with active LRN bit (DI_3=0, please refer to "Standardization EnOcean Communication Profiles"). If the same transmitter is operated again after more than 4 seconds with active LRN bit it will be deleted again.



Please note that in modes 2, 3, and 4 only RPS or HRC telegrams can be learned!

2.8.4 Confirmation of correct learning/deletion

The output which is toggling every second while in teach-in mode (see above) will stay switched high for 4 seconds to signal that a transmitter has been learned. In case a transmitter ID has been deleted it will stay 4 seconds low.

2.8.5 Learning of further transmitters

After confirmation, the receiver changes again to readiness for learning. Further transmitters can be learned immediately. If available the next receiver channel can be entered by connecting the LRN pin to GND longer than $t = 0.5$ seconds. A maximum of 30 radio transmitters can be learned (further attempts will be ignored; instead of learning confirmation, operating mode is entered). Each rocker of a radio transmitter is counted as one transmitter.

2.8.6 Selecting the next channel

By fresh contacting of the LRN pin to GND the next remaining channel is selected. In one-channel mode or after the last channel, the operating mode is entered again.

2.8.7 Leaving learning mode

LRN mode is left in either one of the following events:

- Output of last available channel is toggling and a fresh contacting of the LRN pin to GND for 0.5 seconds is performed
- No ID has been added/deleted during the last 30 seconds.
- Memory was full and another ID was sent to be learnt

2.8.8 Deleting a transmitter

Deletion of one specific transmitter: Use the same procedure as learning the associated transmitter.

As transmitter delete confirmation, the corresponding function outputs remain in inactive state for 4 seconds while LMI keeps active. After that, a wrongly deleted transmitter can be learned again immediately.



In order to delete a PTM transmitter the same rocker as during learn has to be operated. If several rockers of a PTM transmitter have been learned, all have to be deleted separately.

Deletion of all learned transmitters: Connect the CLR pin longer than 2 seconds to GND

All learned transmitters on all channels are deleted at the same time. After this, the receiver enters Learning Mode.

2.9 Remote management

TCM 300 supports the remote management specification which is available from EnOcean upon request. This allows controlling the teach-in procedure via a Remote Config Control device.

2.9.1 Remote Management Control Commands (RMCC)

All RMCCs supported.

Mode	Reaction to ACTION COMMAND (Function code 0x005)
0	RMI HIGH for 1 s.
1	LMI HIGH, and LRN_TOGGLE on for 1 s.
2	LMI HIGH, and CHANNEL0 invert for 1 s.
3	LMI HIGH, and all CHANNELx inverted for 1 s.
4	LMI HIGH, DIM IND inverted, and PWM inverted for 1 s.
5	Reserved for future use

2.9.2 Remote Procedure Calls (RPC)

Supported RPCs:

- Remote learn command, function code 0x201
- Smart ACK: Read mailbox settings, function code 0x205, settings type 0x01
- Smart ACK: Delete mailbox, function code 0x206, operation type 0x02

REMOTE LEARN COMMAND:

EEP: 0x000000

Mode	Flag in command	Reaction
0	n.a.	No reaction, no Learn Mode available
1	0x01	Start Remote Learn Mode
	0x03	Stop Remote Learn Mode
2	0x01	Start Remote Learn Mode
	0x03	Stop Remote Learn Mode
3	0x01	Start Remote Learn Mode
	0x02	Next channel
	0x03	Stop Remote Learn Mode
4	0x01	Start Remote Learn Mode
	0x03	Stop Remote Learn Mode
5	n.a.	No reaction, reserved for future use

The signalling is the same as described above in 2.8.

Differences between remote learn mode and normal learn mode:

- In remote learn mode also repeated telegrams will be accepted
- 3 transmissions within 2 seconds are required, instead of 1 transmission

For detailed information on remote management please refer to the Remote Management system specification.

2.10 Smart Acknowledge

TCM 3x0 provides a post master function with 15 mail boxes for systems using EnOcean smart acknowledge technology. This functionality is switched on in all operating modes. For detailed information on smart acknowledge please refer to the Smart Acknowledge system specification.



When teaching-in a device using Smart Acknowledge please take care to switch off all TCM3xy devices which are not continuously powered. Otherwise these TCM3xy modules could be declared postmaster. As soon as the power supply is switched off a postmaster would be missing and Smart Acknowledge would not work any longer!

2.11 Transmit timing

The setup of the transmission timing allows avoiding possible collisions with data packages of other EnOcean transmitters as well as disturbances from the environment. With each transmission cycle, 3 identical subtelegrams are transmitted within 40 ms. The transmission of a subtelegram lasts approximately 1.2 ms. The delay between the three transmission bursts is affected at random.

3 APPLICATIONS INFORMATION

3.1 Transmission range

The main factors that influence the system transmission range are type and location of the antennas of the receiver and the transmitter, type of terrain and degree of obstruction of the link path, sources of interference affecting the receiver, and “dead” spots caused by signal reflections from nearby conductive objects. Since the expected transmission range strongly depends on this system conditions, range tests should categorically be performed before notification of a particular range that will be attainable by a certain application.

The following figures for expected transmission range are considered by using a PTM, a STM or a TCM radio transmitter device and the TCM radio receiver device with preinstalled whip antenna and may be used as a rough guide only:

- Line-of-sight connections: Typically 30 m range in corridors, up to 100 m in halls
- Plasterboard walls / dry wood: Typically 30 m range, through max. 5 walls
- Line-of-sight connections: Typically 30 m range in corridors, up to 100 m in halls
- Ferro concrete walls / ceilings: Typically 10 m range, through max. 1 ceiling
- Fire-safety walls, elevator shafts, staircases and supply areas should be considered as screening.

The angle at which the transmitted signal hits the wall is very important. The effective wall thickness – and with it the signal attenuation – varies according to this angle. Signals should be transmitted as directly as possible through the wall. Wall niches should be avoided. Other factors restricting transmission range:

- Switch mounted on metal surfaces (up to 30% loss of transmission range)
- Hollow lightweight walls filled with insulating wool on metal foil
- False ceilings with panels of metal or carbon fibre
- Lead glass or glass with metal coating, steel furniture

The distance between EnOcean receivers and other transmitting devices such as computers, audio and video equipment that also emit high-frequency signals should be at least 0.5 m

A summarized application note to determine the transmission range within buildings is available as download from www.enocean.com.

3.2 Antenna options TCM 300 / TCM 300C

3.2.1 Overview

Several antenna types have been investigated by EnOcean. They all have advantages and disadvantages as shown in the following table.

Advantages	Disadvantages
Whip Antenna (15 cm @ 315 MHz, 8.6 cm @ 868 MHz)	
Cheap	Automatic placement difficult
Omnidirectional	Bending influences performance
	Large size
Chip Antenna (AMD1103-ST01 @ 315 MHz/868 MHz)	
Omnidirectional	Expensive
Small size	Very sensitive to environment (GND plane, components), minimum distance space to other components needed
Automatic placement possible	
Splatch Antenna (ANT-315-SP1 @ 315 MHz, ANT-868-SP1 @ 868 MHz)	
Omnidirectional	Expensive
Not very sensitive to environment, low distance space to other components required	Large size
Automatic placement possible	
Helical Antenna (ANT-315-HE @ 315 MHz)	
Omnidirectional	Large distance space to other components required
Cheap	Large size (3D)
	Through hole component, no SMT

868 MHz modules used in Europe do not need additional approval if the external antenna fulfils the following requirements:

Antenna type	Passive	Mandatory for radio approval
Frequency band	868MHz ISM	Antenna must be suited for this band
Impedance	~50 Ohm	Mandatory for radio approval
Maximum gain	≤ 8 dBd	Mandatory for radio approval
VSWR	≤ 1.5:1	Important for compatibility with EnOcean protocol
Return Loss	> 14 dB	Important for compatibility with EnOcean protocol
Bandwidth	≤ 20 MHz	Important if 10 V/m EMI robustness required for device



For 315 MHz modules (STM 300C and TCM 3X0C) please note that a full approval is needed if modules are used with antennas other than the specified whip antenna.

3.2.2 Whip antenna

315 MHz

Antenna: 150 mm wire, connect to RF_WHIP

Minimum GND plane: 50 mm x 50 mm

Minimum distance space: 10 mm

868 MHz

Antenna: 86 mm wire, connect to RF_WHIP

Minimum GND plane: 38 mm x 18 mm

Minimum distance space: 10 mm

PRELIMINARY

3.2.3 Chip antenna

315 MHz

Antenna: AMD1103-ST01

Manufacturer: Mitsubishi

Matching circuit:

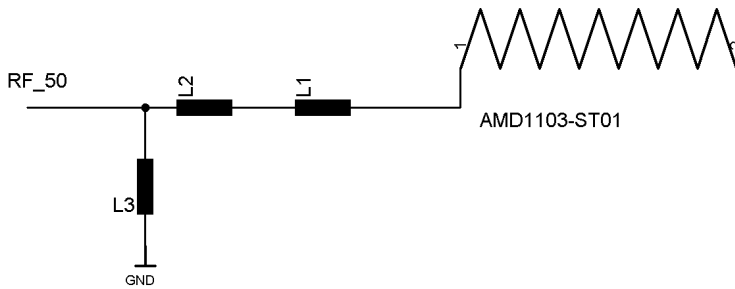

L1=47 nH

L2=390 nH

L3 optional for additional optimization

Minimum distance space and layout:

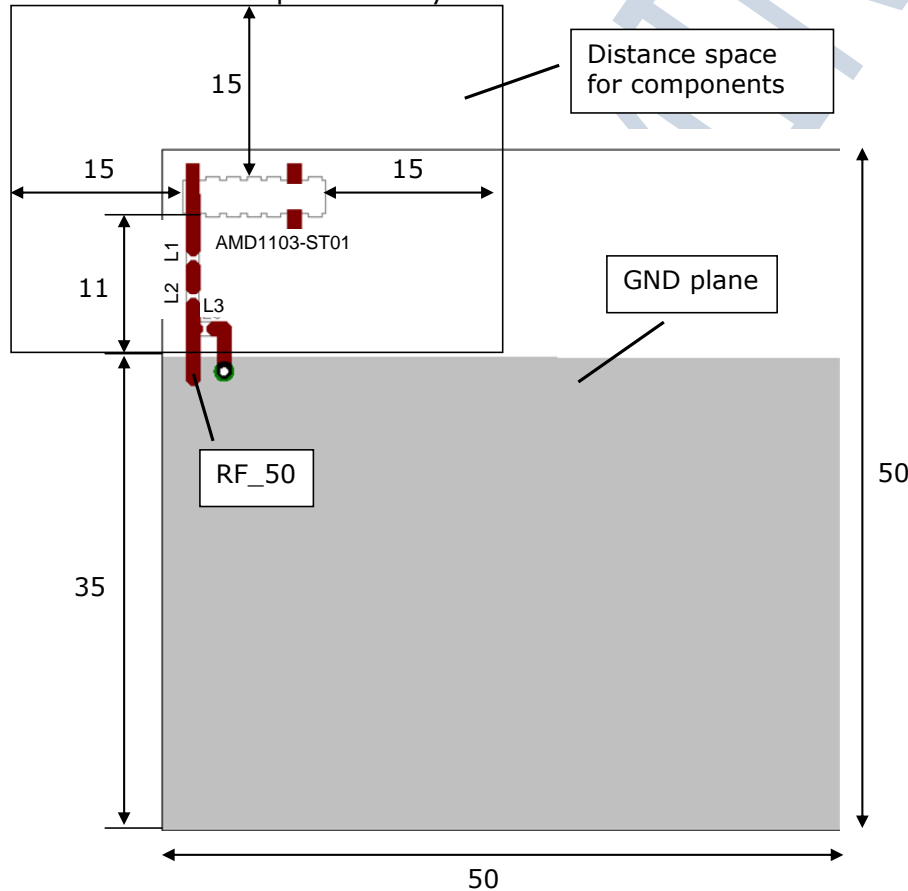

Minimum distance space above and below PCB: 11 mm

868 MHz

Antenna: AMD1103-ST01

Manufacturer: Mitsubishi

Matching circuit:

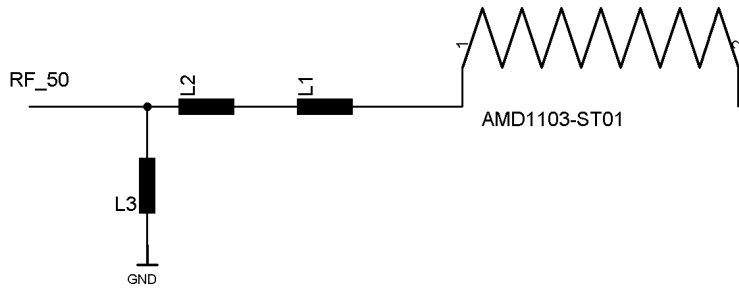

L1=6,8 nH

L2=39 nH

L3=8,2 nH

Minimum distance space and layout:

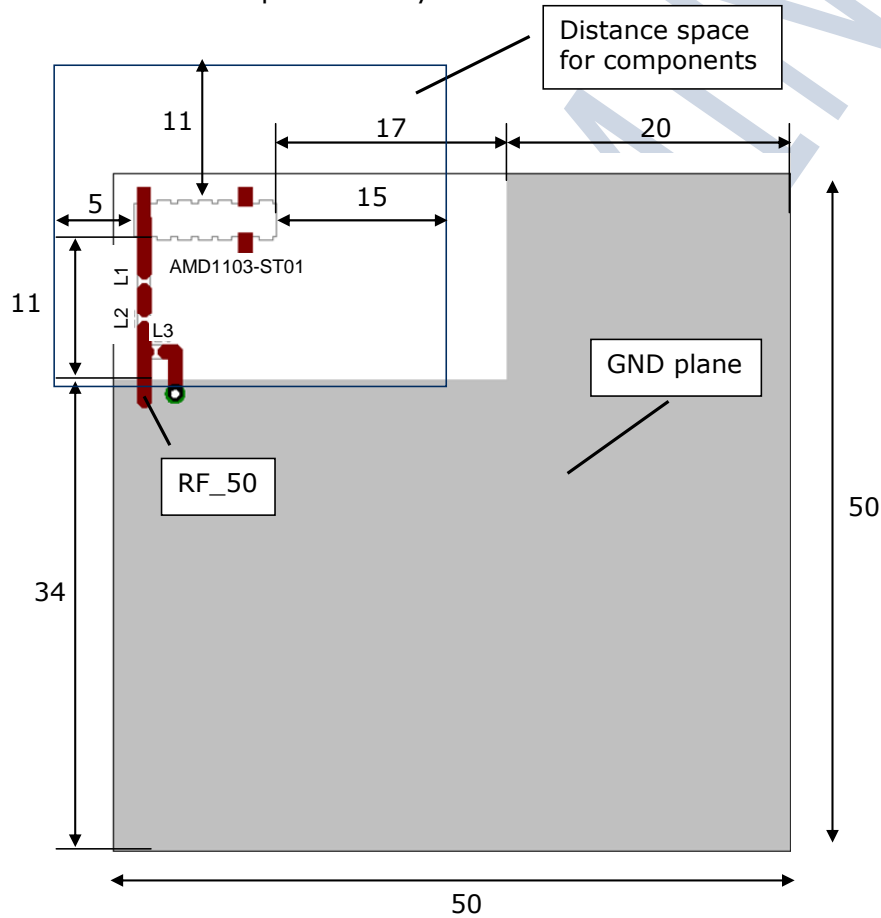

Minimum distance space above and below PCB: 11 mm

3.2.4 Splat antenna

315/868 MHz

Antenna: ANT-315-SP

Manufacturer: Linx Technologies / Antenna Factor

Matching circuit: Not needed

Minimum distance space and layout:

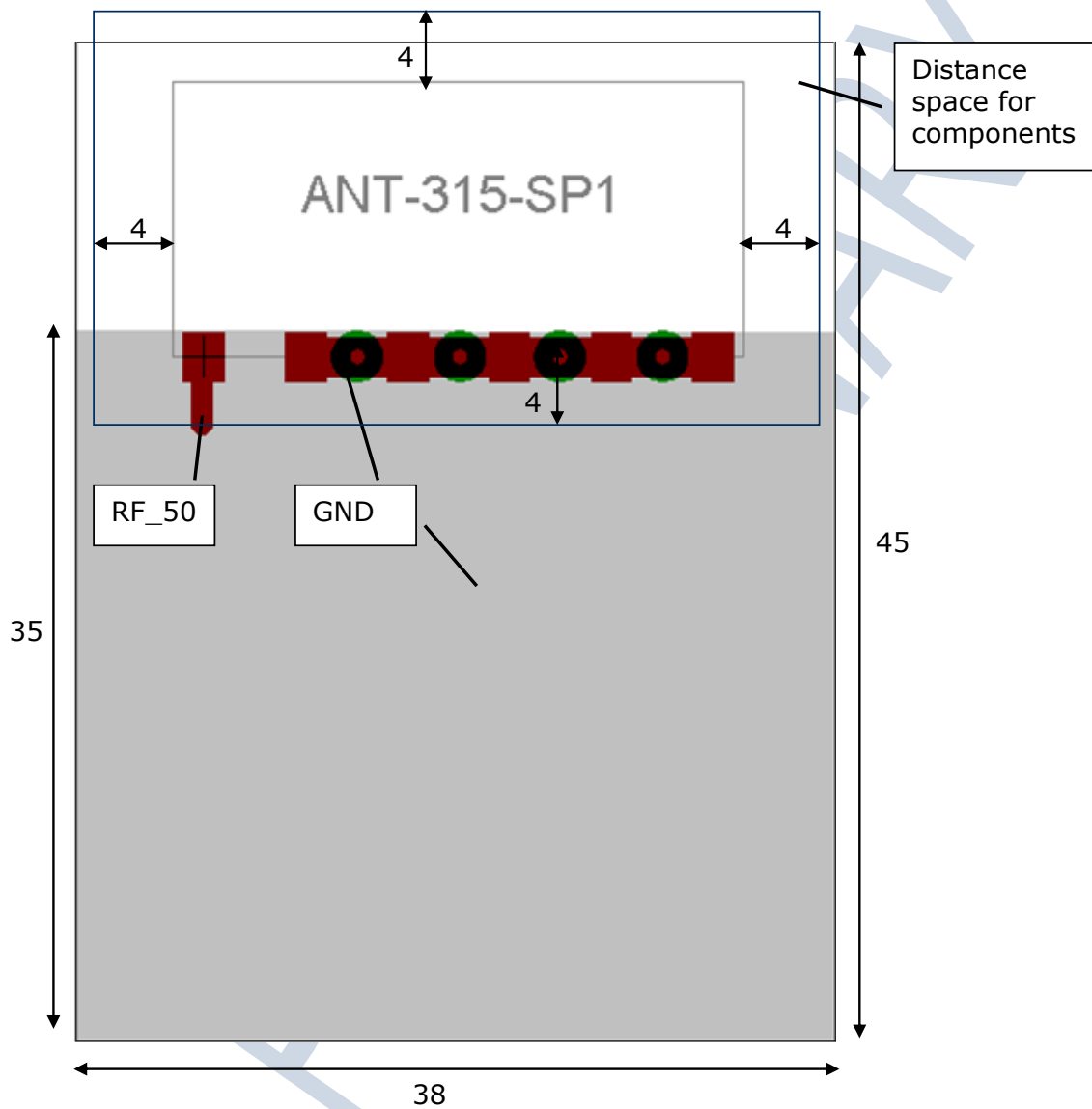

Minimum distance space above and below PCB: 12 mm

3.2.5 Helical antenna

315 MHz

Antenna: ANT-315-HE

Manufacturer: Linx Technologies / Antenna Factor

Matching circuit:

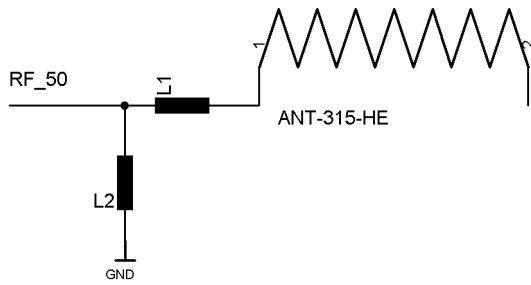

L1=5,1 nH

L2=18 nH

Minimum distance space and layout:

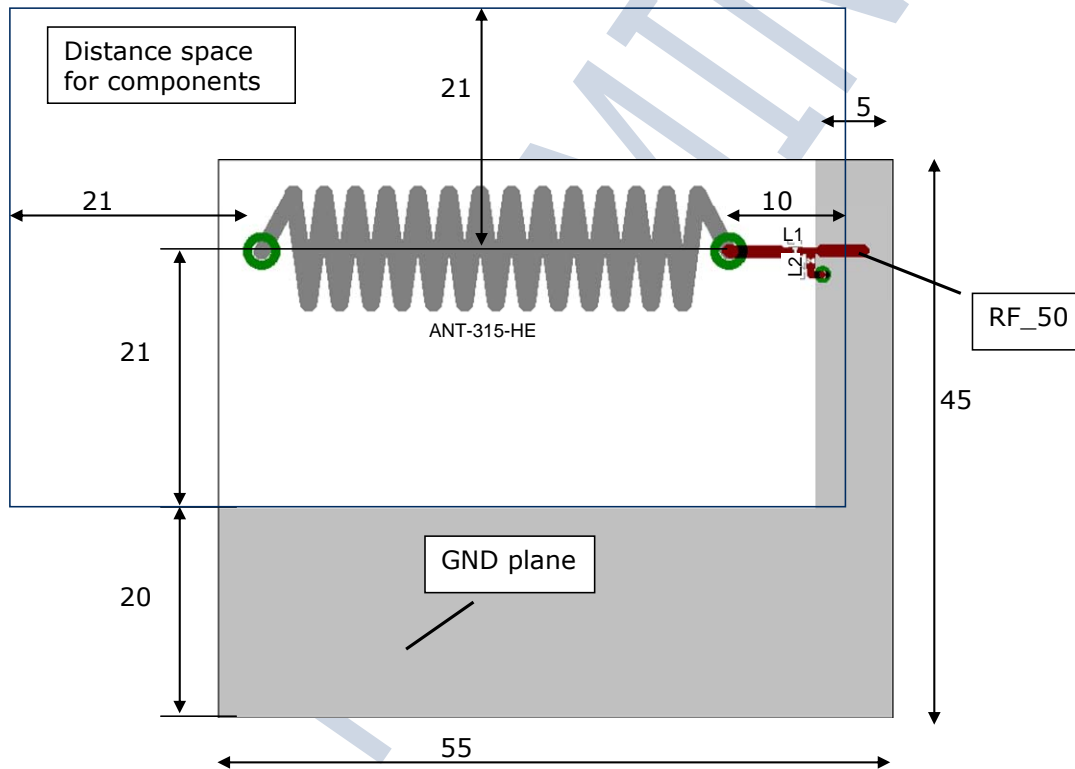

Minimum distance above and below axis of antenna: 21 mm

3.3 Antenna options TCM 320 / 320C

Positioning and choice of receiver and transmitter antennas are the most important factors in determining system transmission range.

3.3.1 Mounting the whip antenna

For good receiver performance, great care must be taken about the space immediately around the antenna since this has a strong influence on screening and detuning the antenna. The antenna should be drawn out as far as possible and must never be cut off. Mainly the far end of the wire should be mounted as far away as possible (at least 15 mm) from all metal parts, ground planes, PCB strip lines and fast logic components (e.g. microprocessors).

Do not roll up or twist the whip antenna!

Radio frequency hash from the motherboard desensitizes the receiver. Therefore:

- PCB strip lines on the user board should be designed as short as possible
- A PCB ground plane layer with sufficient ground vias is strongly recommended
- See also section 3.5 for power supply requirements. Problems may especially occur with switching power supplies!

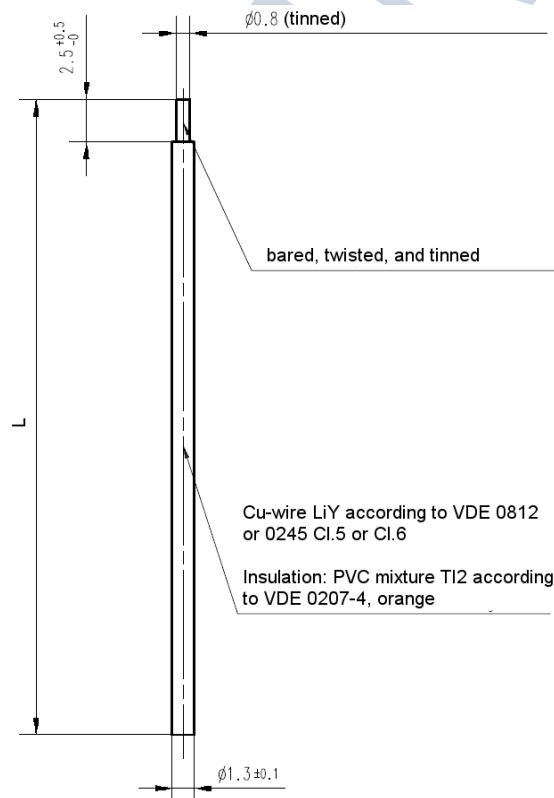

Specification of the TCM whip antenna; L=150 mm @ 315 MHz, L=86 mm @ 868 MHz



Isolation material may brake at temperatures below -15 °C.
Please take care to fix the antenna cable in case vibrations are expected.

3.3.2 Mounting 50 Ω antennas

For mounting the receiver at bad RF locations (e.g. within a metal cabinet), an external 50 Ω antenna may be connected. The whip antenna must be removed in this case!

TCM 320 provides soldering pads for an SMA connector, e.g. from Tyco Electronics:

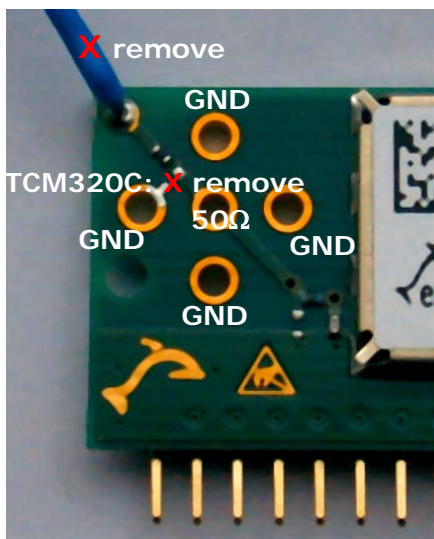

Modification procedure:

- TCM320: Remove whip antenna and mount SMA connector
- TCM320C: Remove whip antenna and 12pF capacitor (see figure above). Then mount SMA connector



For 315 MHz modules (TCM 300C and TCM 320C) please note that a full approval is needed if modules are used with external antennas other than the pre-installed whip antenna.



When using the SMA connector pads please make sure no mechanical forces are exerted on the 16-pin connector! It is recommended to use a strain relief for that purpose.

3.4 Recommendations for laying a whip antenna

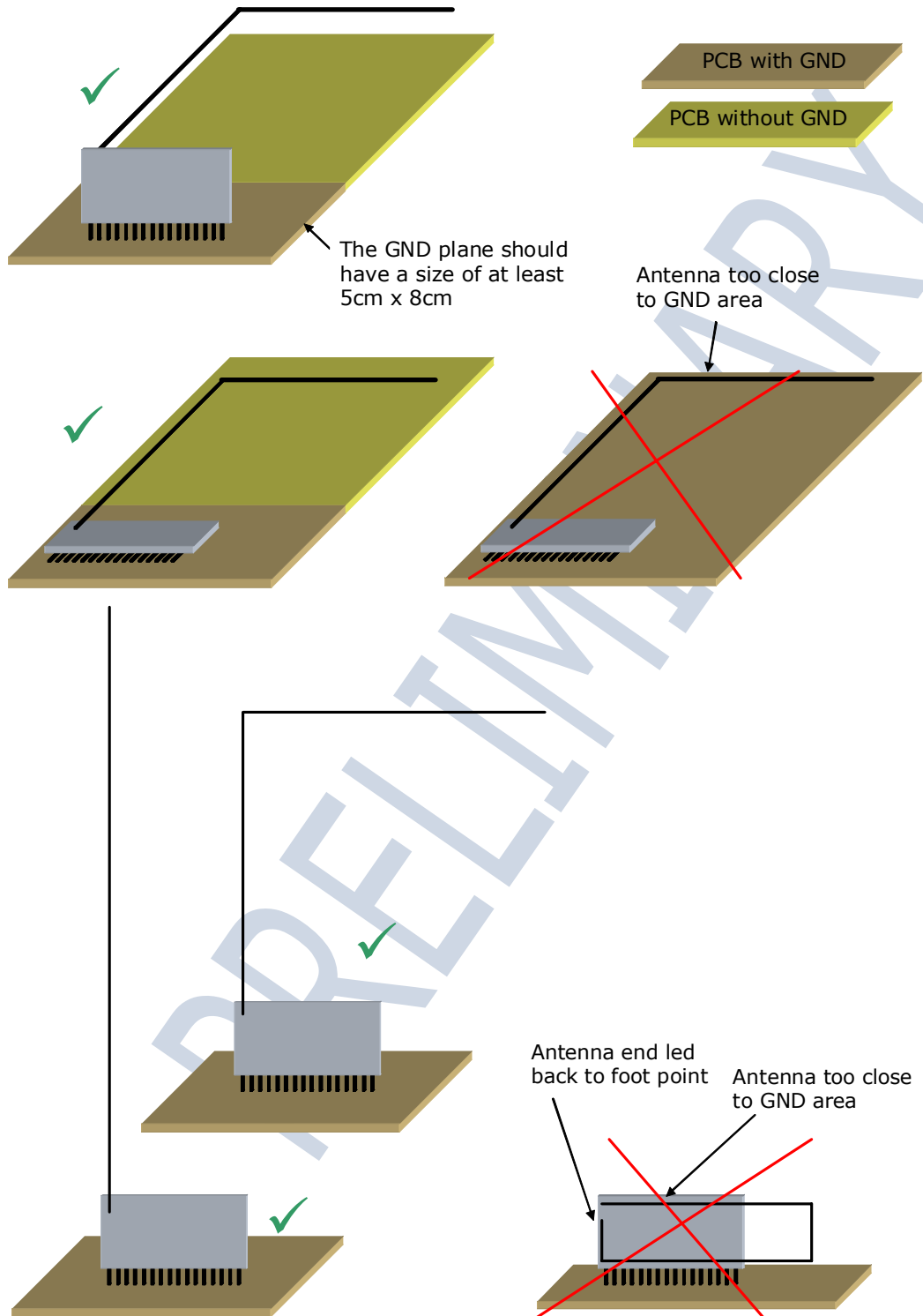

3.5 Power supply requirements

In order to provide a good radio performance, great attention must be paid to the power supply and a correct layout and shielding. It is recommended to place a 22 μ F ceramic capacitor between VDD and GND close to the module (material: X5R, X7R, min 6.3 V to avoid derating effects). In addition a 470 nH coil shall be inserted (Murata LQW18A, 0603) in the power supply line.

It is recommended to keep the ripple on the power supply rail below 10 mVpp (see 2.4).

3.6 Layout recommendations



The length of lines connected to I/Os should not exceed 5cm.



It is recommended to have a complete GND layer, at least below the module and directly connected components.



The RVDD line should be kept as short as possible. Please consider recommendations in section 3.10.

3.6.1 TCM 300/300C recommended foot pattern

Top layer

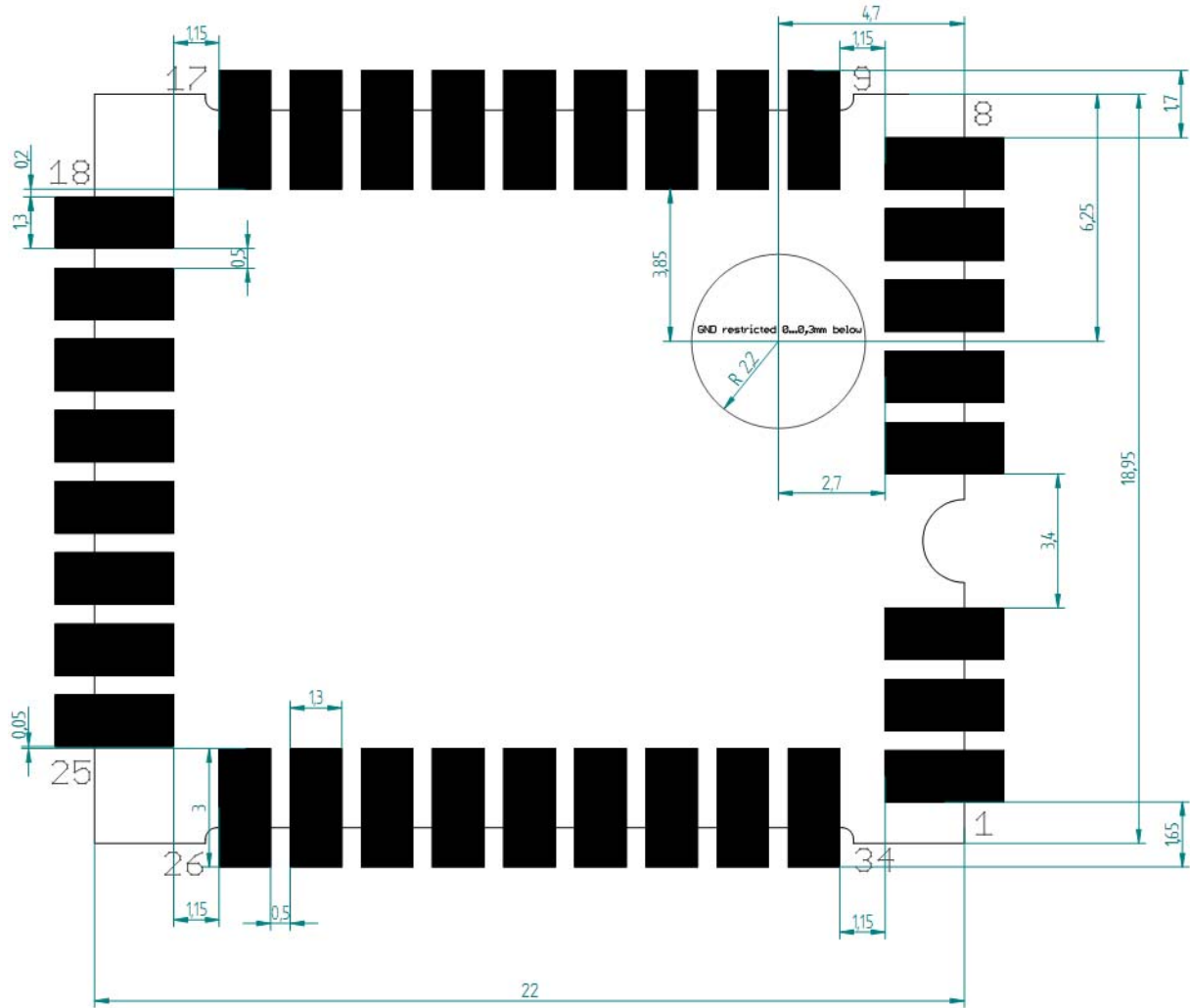

PRZ

Solder resist top layer

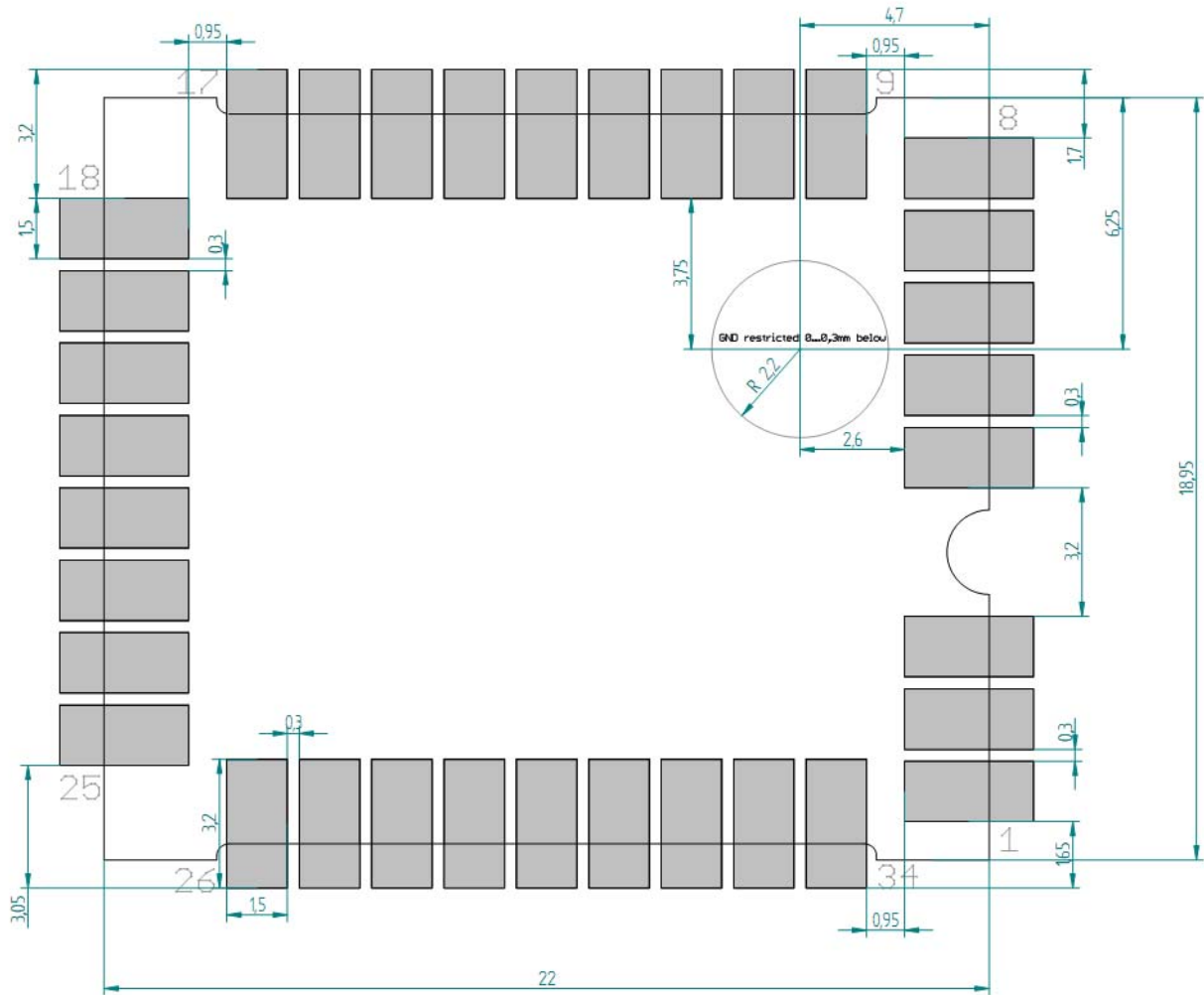

PRE

Solder paste top layer

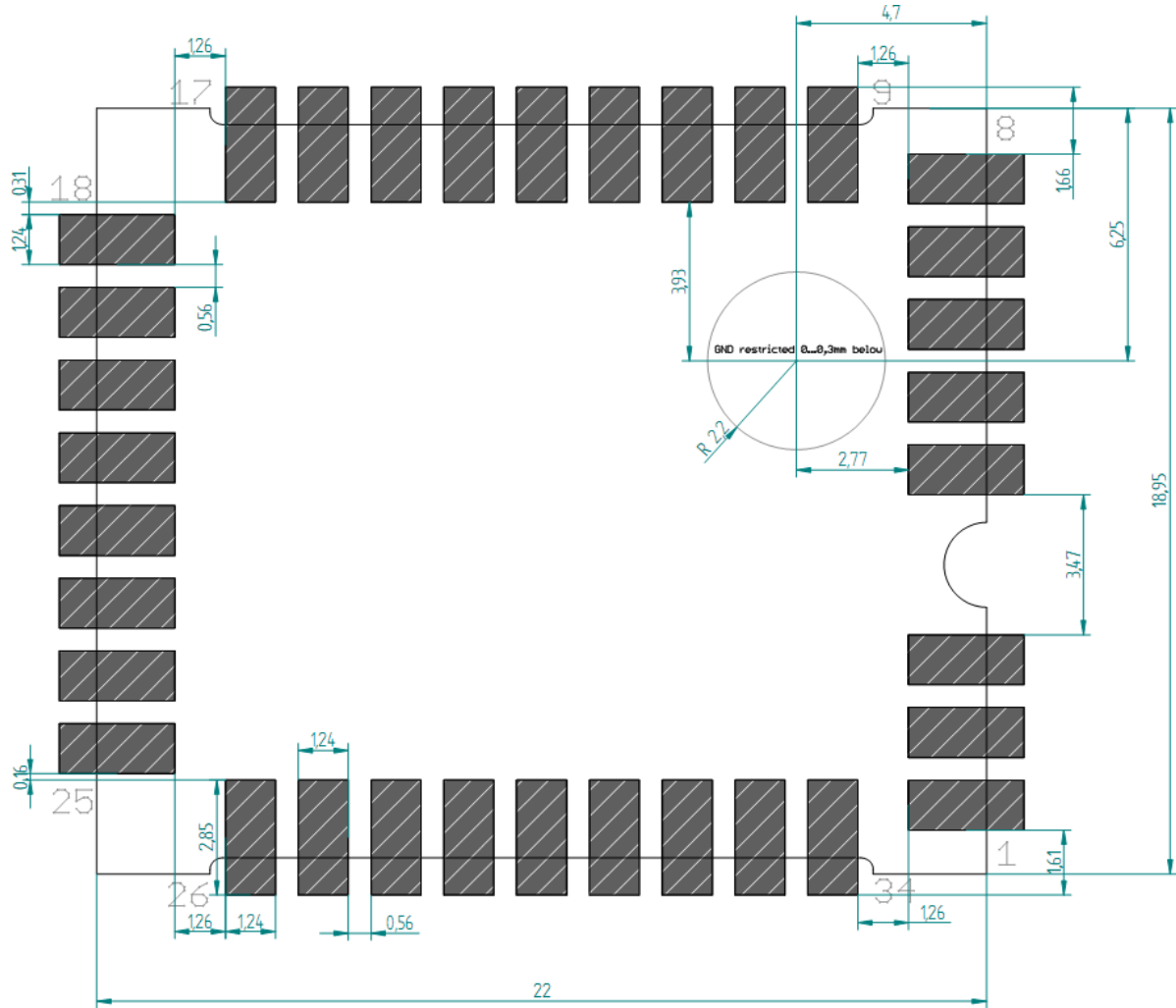

The data above is also available as EAGLE library.

3.7 Soldering information

3.7.1 TCM 300 / TCM 300C

TCM 300 has to be soldered according to IPC/JEDEC J-STD-020C standard.

Profile Feature	Pb-Free Assembly
Average Ramp-Up Rate (TS _{max} to Tp)	3° C/second max.
Preheat	
- Temperature Min (TS _{min})	150 °C
- Temperature Max (TS _{max})	200 °C
- Time (ts _{min} to ts _{max})	60-180 seconds
Time maintained above:	
- Temperature (TL)	217 °C
- Time (tL)	60-150 seconds
Peak/Classification Temperature (Tp)	260 °C
Time within 5 °C of actual Peak Temperature (tp)	20-40 seconds
Ramp-Down Rate	6 °C/second max.
Time 25 °C to Peak Temperature	8 minutes max.

Note 1: All temperatures refer to topside of the package, measured on the package body surface.

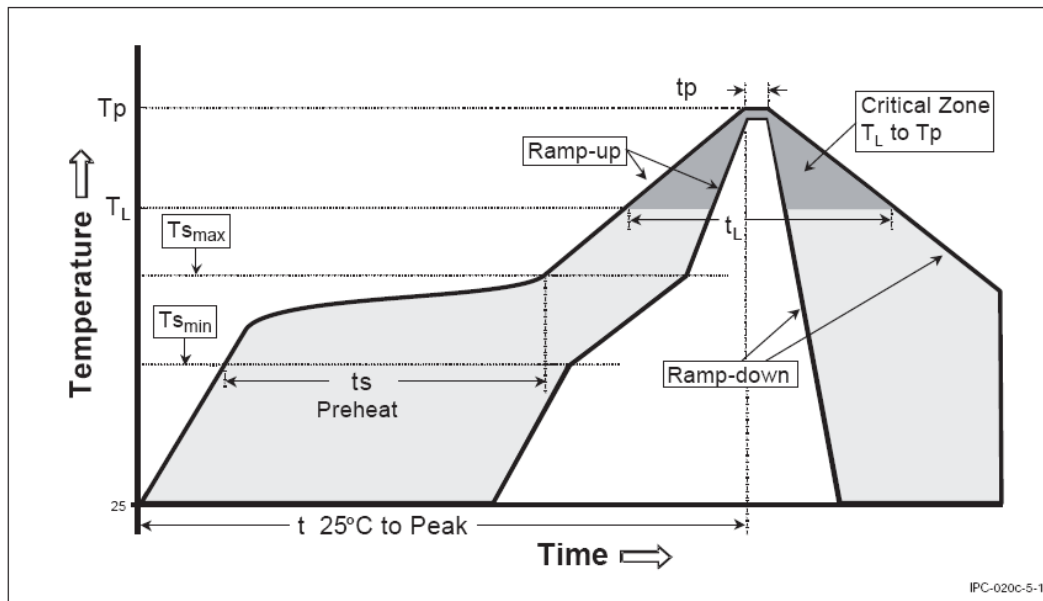

TCM 300 shall be handled according to Moisture Sensitivity Level MSL4 which means a floor time of 72 h. TCM 300 may be soldered only once, since one time is already consumed at production of the module itself.

Once the dry pack bag is opened, the desired quantity of units should be removed and the bag resealed within two hours. If the bag is left open longer than 30 minutes the desiccant should be replaced with dry desiccant. If devices have exceeded the specified floor life time of 72 h, they may be baked according IPC/JEDEC J-STD-033B. Devices packaged in moisture-proof packaging should be stored in ambient conditions not exceeding temperatures of 40 °C or humidity levels of 90% r.H.

TCM 300 modules have to be soldered within 6 months after delivery!

TCM 300 / 300C / 320 / 320C

3.7.2 TCM 320 / TCM 320C



The EO30001 chip inside the module is a moisture sensitive device. In case of wave soldering the modules should be baked in advance.

3.8 Tape & Reel specification TCM 300 / TCM 300C

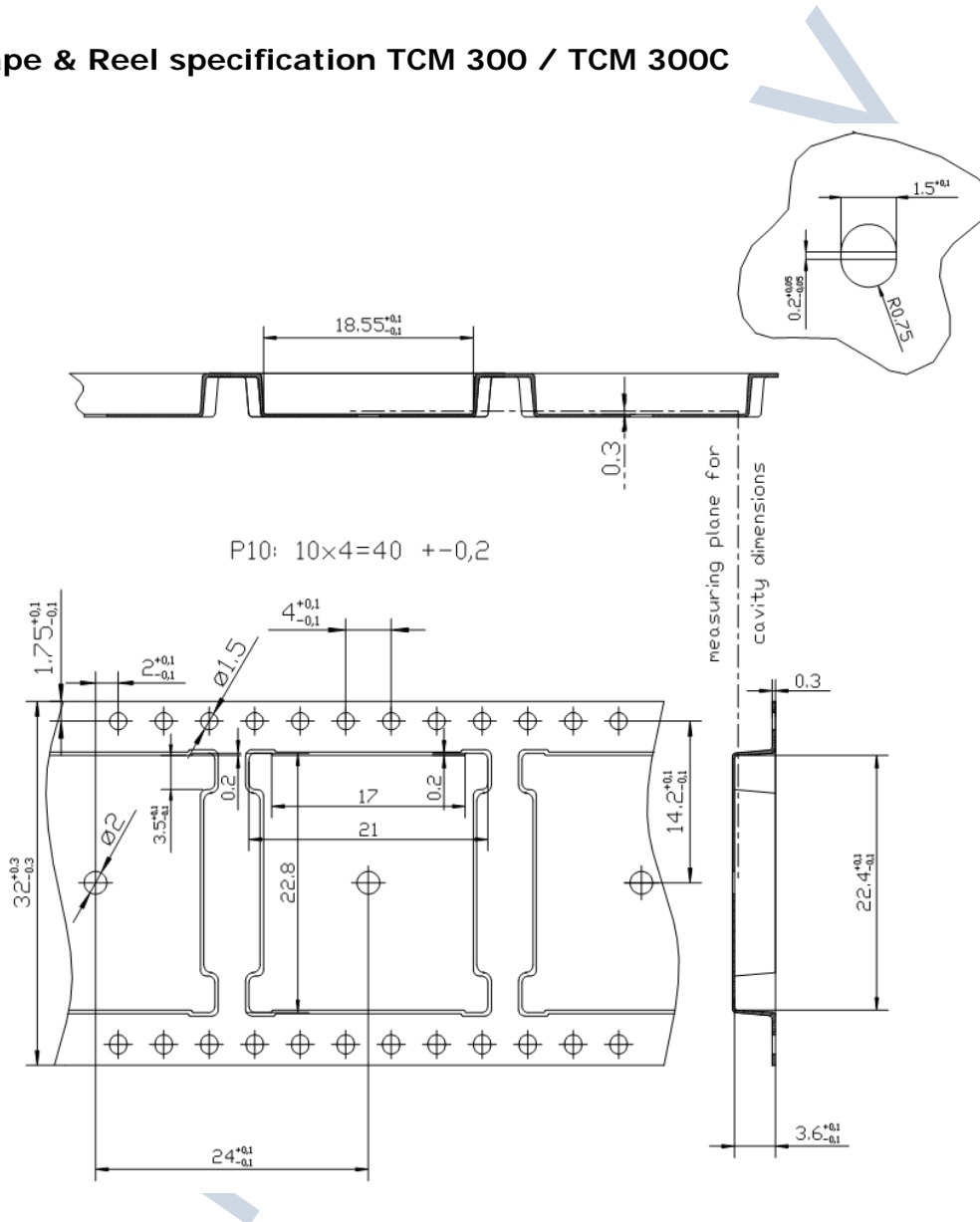

3.9 Backward compatibility to TCM 220C

In Mode 0 TCM 320C is backward compatible to its predecessor TCM 220C.

There are a few minor restrictions of compatibility which are listed here:

Parameter	TCM 220C	TCM 320C
Maximum current consumption	34 mA	43 mA
Maximum output current of outputs	25 mA	2 mA (external driver transistor may be needed)
Thickness of module	4.6 mm	5.5 mm
Maximum voltage rating at pin7 (TCM 320C: ADIO6; TCM 220C: IN_5)	6 V	3.6 V
Minimum HIGH voltage level at input pins	1.55 V	2.0 V
Post master function for systems with smart acknowledge	No	Yes, 15 mail boxes

3.10 Using RVDD

If RVDD is used in an application circuit a serial ferrite bead shall be used and wire length should be as short as possible (<3 cm). The following ferrite beads have been tested: 74279266 (0603), 74279205 (0805) from Würth. During radio transmission and reception only small currents may be drawn ($I < 100 \mu\text{A}$).

Pulsed current drawn from RVDD has to be avoided. If pulsed currents are necessary, sufficient blocking has to be provided.

3.11 Voltage dips

The moduls are supporting the handling of supply voltage dips (as requested e.g. by EN60669-2-1). As soon as the supply voltage drops below the VON threshold level the current consumption is reduced. TCM 300 will enter standby sleep mode (worst case $35 \mu\text{A}$), TCM 320 will enter short term sleep mode (1.8mA) for 200 ms. As long as the voltage at VDD does not drop below VOFF during that phase the module will restore the output state as set before the voltage dip. The minimal difference between VON and VOFF is 0.35 V.

The electric charge needed to bridge this interval is:

$$1.8 \text{mA} \times 200 \text{ms} = 360 \mu\text{C} \text{ for TCM 320}$$

$$0.035 \text{mA} \times 200 \text{ms} = 7 \mu\text{C} \text{ for TCM 300}$$

This electric charge can be stored in an external capacitor. The required capacity (do not forget to add component specific tolerances and some extra margin) calculates as:

$$360 \mu\text{C} / 0.35 \text{V} = 1028 \mu\text{F} \text{ for TCM 320}$$

$$7 \mu\text{C} / 0.35 \text{V} = 20 \mu\text{F} \text{ for TCM 300}$$

If other external circuitry has to be supplied the calculations have to be done accordingly, using the total current consumption of module and external circuitry.

4 AGENCY CERTIFICATIONS (after release for series production)

The modules have been tested to fulfil the approval requirements for CE (TCM 3x0) and FCC/IC (TCM 3x0C) based on the built-in firmware.



When developing customer specific firmware based on the API for this module, special care must be taken not to exceed the specified regulatory limits, e.g. the duty cycle limitations!

4.1 CE approval

The modules bear the EC conformity marking CE and conforms to the R&TTE EU-directive on radio equipment. The assembly conforms to the European and national requirements of electromagnetic compatibility. The conformity has been proven and the according documentation has been deposited at EnOcean. The modules can be operated without notification and free of charge in the area of the European Union, and in Switzerland. The following provisos apply:

- EnOcean RF modules must not be modified or used outside their specification limits.
- EnOcean RF modules may only be used to transfer digital or digitized data. Analog speech and/or music are not permitted.
- The final product incorporating EnOcean RF modules must itself meet the essential requirement of the R&TTE Directive and a CE marking must be affixed on the final product and on the sales packaging each. Operating instructions containing a Declaration of Conformity has to be attached.
- If the transmitter is used according to the regulations of the 868.3 MHz band, a so-called "Duty Cycle" of 1% per hour must not be exceeded. Permanent transmitters such as radio earphones are not allowed.
- The module must be used with only the following approved antenna(s).

Type	Parameter	Value
Wire/Monopole at RF_WHIP	Maximum gain	1.0 dBi
External antenna at RF_50	Antenna type	Passive
	Impedance	~50 Ohm
	Maximum gain	≤ 8 dBd

4.2 FCC (United States) Certification

TCM 300C and TCM 320C LIMITED MODULAR APPROVAL

This is an RF module approved for Limited Modular use operating as an intentional transmitting device with respect to 47 CFR 15.231(a-c) and is limited to OEM installation. The module is optimized to operate using small amounts of energy, and may be powered by a battery. The module transmits short radio packets comprised of control signals, (in some cases the control signal may be accompanied with data) such as those used with alarm systems, door openers, remote switches, and the like. The module does not support continuous streaming of voice, video, or any other forms of streaming data; it sends only short packets containing control signals and possibly data. The module is designed to comply with, has been tested according to 15.231(a-c), and has been found to comply with each requirement. Thus, a finished device containing the TCM 300C/TCM 320C radio module can be operated in the United States without additional Part 15 FCC approval (approval(s) for unintentional radiators may be required for the OEM's finished product), under EnOcean's FCC ID number. This greatly simplifies and shortens the design cycle and development costs for OEM integrators. The module can be triggered manually or automatically, which cases are described below.

Manual Activation

The radio module can be configured to transmit a short packetized control signal if triggered manually. The module can be triggered, by pressing a switch, for example. The packet contains one (or more) control signals that is(are) intended to control something at the receiving end. The packet may also contain data. Depending on how much energy is available from the energy source, subsequent manual triggers can initiate the transmission of additional control signals. This may be necessary if prior packet(s) was(were) lost to fading or interference. Subsequent triggers can also be initiated as a precaution if any doubt exists that the first packet didn't arrive at the receiver. Each packet that is transmitted, regardless of whether it was the first one or a subsequent one, will only be transmitted if enough energy is available from the energy source.

Automatic Activation

The radio module also can be configured to transmit a short packetized control signal if triggered automatically, by a relevant change of its inputs or in response to receiving a signal from another transmitter, for example. Again, the packet contains a control signal that is intended to control something at the receiving end and may also contain data. As above, it is possible for the packet to get lost and never reach the receiver. However, if enough energy is available from the energy source, and the module has been configured to do so, then another packet or packets containing the control signal may be transmitted at a later time.

The device is capable to operate as a repeater, which can receive signals from the following list of FCC/IC approved transmitters, and retransmit the signals.

■ PTM 200C	FCC ID:SZV-PTM200C	IC:5713A-PTM200C
■ STM 110C	FCC ID:SZV-STM110C	IC:5713A-STM110C
■ TCM 200C	FCC ID:SZV-TCM2XXC	IC:5713A-TCM2XXC
■ TCM 220C	FCC ID:SZV-TCM2XXC	IC:5713A-TCM2XXC
■ TCM 300C	FCC ID:SZV-STM300C	IC:5713A-STM300C
■ STM 300C	FCC ID:SZV-STM300C	IC:5713A-STM300C
■ TCM 320C	FCC ID:SZV-TCM320C	IC:5713A-TCM320C

OEM Requirements

In order to use EnOcean’s FCC ID number, the OEM must ensure that the following conditions are met:

- End users of products, which contain the module, must not have the ability to alter the firmware that governs the operation of the module. The agency grant is valid only when the module is incorporated into a final product by OEM integrators.
- The end-user must not be provided with instructions to remove, adjust or install the module.
- The Original Equipment Manufacturer (OEM) must ensure that FCC labeling requirements are met. This includes a clearly visible label on the outside of the final product. Attaching a label to a removable portion of the final product, such as a battery cover, is not permitted. The label must include the following text:

TCM300C:

*Contains FCC ID: SZV-STM300C
 The enclosed device complies with Part 15 of the FCC Rules. Operation is subject to the following two conditions: (i.) this device may not cause harmful interference and (ii.) this device must accept any interference received, including interference that may cause undesired operation.*

TCM320C:

*Contains FCC ID: SZV-TCM320C
 The enclosed device complies with Part 15 of the FCC Rules. Operation is subject to the following two conditions: (i.) this device may not cause harmful interference and (ii.) this device must accept any interference received, including interference that may cause undesired operation.*

The user manual for the end product must also contain the text given above.

- Changes or modifications not expressly approved by EnOcean could void the user's authority to operate the equipment.
- The module must be used with only the following approved antenna(s).

Part Number	Type	Gain
N.A.	Wire/Monopole	1.0 dBi

- The OEM must ensure that timing requirements according to 47 CFR 15.231(a-c) are met.
- The OEM must sign the OEM Limited Modular Approval Agreement with EnOcean

4.3 IC (Industry Canada) Certification

In order to use EnOcean's IC number, the OEM must ensure that the following conditions are met:

- Labeling requirements for Industry Canada are similar to those required by the FCC. The Original Equipment Manufacturer (OEM) must ensure that IC labeling requirements are met. A clearly visible label on the outside of a non-removable part of the final product must include the following text:

TCM300C:

Contains IC: 5713A-STM300C

TCM320C:

Contains IC: 5713A-TCM320C

- The OEM must sign the OEM Limited Modular Approval Agreement with EnOcean

PRELIMINARY

A APPENDIX

A.1 EnOcean serial protocol

When the receiver is in "Serial Interface" mode, it transfers out data blocks of information from the received RF telegrams. As long as no transmitter has been learned, all received EnOcean telegrams are transferred. As soon as at least one transmitter has been learned only telegrams of transmitters learned by the receiver are transmitted via the serial interface. The data block format is explained later in this document; it depends on the type of sensor from which the telegram has been received.

A.1.1 Message format

The following figure shows the message format. A block is composed of 2 synchronization bytes, 1 byte for the header and N bytes for the message data.

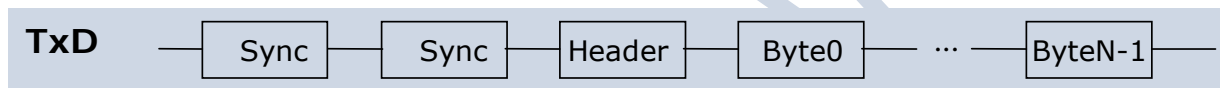

Message format for asynchronous serial communication

A.1.2 Byte signals and bit order

- 9600 bps; 8 data bits, no parity bit, one start bit, one stop bit
- Line idle is binary 1 (standard)
- Each character has one start bit (binary 0), 8 information bits (least significant bit first) and one stop bit (binary 1)

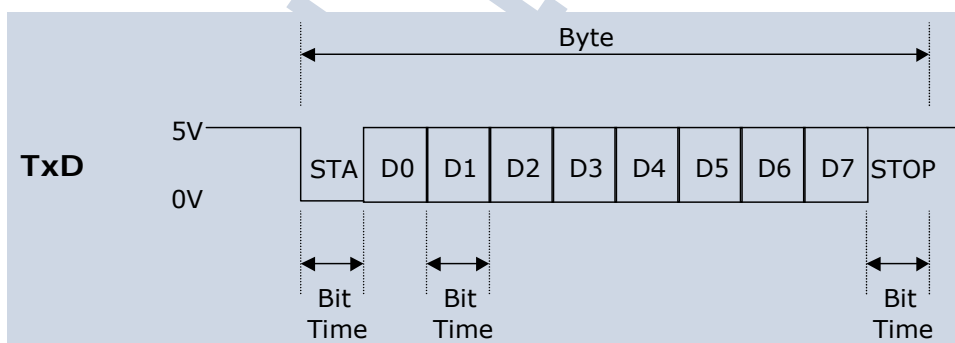

Signals and bit order sending a byte

A.2 Radio transmission/reception commands

The following commands are used to transmit and receive radio telegrams.

Command	Response (RMT)
TX_TELEGRAM (TRT)	OK, ERR, ERR_TX_IDRANGE
RX_TELEGRAM (RRT)	

The TX_TELEGRAM and RX_TELEGRAM telegrams have the same structure. The only difference is in the H_SEQ code, TX_TELEGRAM is identified by "3". RX Telegrams are identified by the H_SEQ codes according to table in A.2.1.

A.2.1 Description of serial data structure

Bit 7 Bit 0

SYNC_BYTE1 (A5 Hex)
SYNC_BYTE0 (5A Hex)
H_SEQ LENGTH
ORG
DATA_BYTE3
DATA_BYTE2
DATA_BYTE1
DATA_BYTE0
ID_BYTE3
ID_BYTE2
ID_BYTE1
ID_BYTE0
STATUS
CHECKSUM

SYNC_BYTE 0..1 (8 bit each)

Synchronization Bytes

H_SEQ (3 bit)

Header identification

H_SEQ	Meaning	Mode
0b000	<ul style="list-style-type: none"> Unknown transmitter ID received (serial telegram only if no ID has been learned so far!) For RPS also: <ul style="list-style-type: none"> Known transmitter ID and unknown rocker U-message from known transmitter ID received For HRC also: <ul style="list-style-type: none"> Known transmitter ID and unknown rocker Scene switch command (last three bits of ID 0b111) from known transmitter ID (only first 29 bits are compared!) 	Operating Mode
0b001	<ul style="list-style-type: none"> For 1BS and 4BS: Known transmitter ID received For RPS: Known transmitter ID and at least 1 known rocker (1 or 2 rockers operated) For HRC: Known transmitter ID and known rocker 	Operating Mode
0b010	<ul style="list-style-type: none"> New transmitter learned (If a switch telegram is received (RPS or HRC), the rocker code (RID) is stored together with the ID.) 	Learn Mode
0b110	<ul style="list-style-type: none"> Transmitter just deleted (If a switch telegram is received (RPS or HRC), the rocker code (RID) and module ID are checked. The entry is only deleted if module ID and rocker are known.) 	Learn Mode

LENGTH	(5 bit)	Number of octets following the header octet (11 dec)
ORG	(8 bit)	Type of telegram (see detailed description below)
DATA_BYTE 0..3	(8 bit each)	Data bytes 0..3 (see detailed description below)
ID_BYTE 0..3	(8 bit each)	32-bit transmitter ID ³ For transmission of unique ID enter 0x00000000
STATUS	(8 bit)	Status field (see detailed description below)
CHECKSUM	(8 bit)	Checksum (Last LSB from addition of all octets except sync bytes and checksum)

A.2.2 Detailed description of ORG field

ORG field (hex)	Acronym	Description
0x05	RPS Repeated Switch	Telegram from a PTM switch module received (e.g. PTM 100 or PTM 200)
0x06	1BS 1 Byte Sensor	1 byte data telegram from a STM sensor module (e.g. STM 250)
0x07	4BS 4 Byte Sensor	4 byte data telegram from a STM sensor module (e.g. STM 100)
0x08	HRC Hand Remote Control	Telegram from a CTM module received
0xC5	SYS_EX System Extended	Remote Management Telegrams (see separate specification)



Please note that 6DT and MDA telegrams, which were available in TCM 1x0 / TCM 200C are no longer supported!

A.2.3 Detailed description of STATUS field

If ORG = 5 (Telegram from a PTM switch module):

7				0
Reserved	T21	NU	RP_COUNTER	

Reserved	(2 bit)	For future use
T21	(1 bit)	T21=0 → PTM switch module of type 1, T21=1 → PTM switch module of type 2
NU	(1 bit)	NU=1 → N-message, NU=0 → U-message.
RP_COUNTER	(4 bit) =0..15	Repeater level: 0 is original message (not repeated)



IMPORTANT NOTE FOR SYSTEMS USING AN ENOCEAN RADIO REPEATER:
Within toggle switch applications using the serial receiver mode in combination with a separate repeater, please ensure that no serial command interpretation error may occur at the connected control unit. A toggle signal means that the same telegram is sent for switching something on and off. If e.g. the light is

³ This module allows using a unique ID or one of 128 IDs starting from BaseID. See A.3.1.

switched on receiving the I-button telegram from a PTM 200C, the repeated telegram (delay <100 ms) may switch off the light again. It is therefore mandatory to interpret the RP_COUNTER field. If a repeated telegram (RP_COUNTER>0) is received it has to be verified if the same telegram with a lower RP_COUNTER state has already been received in the previous 100 ms. In this case the repeated message has to be discarded.

PTM switch modules of Type 2 (e.g. PTM 200) allow interpretation of operating two buttons simultaneously:

- N-message received → Only one or two pushbuttons have been pressed.
- U-message received → No pushbutton was pressed when activating the energy generator, or more than two pushbuttons have been pressed.

Note for telegrams from PTM transmitters: Due to the mechanical hysteresis of the energy bow, in most rocker switch device implementations, pressing the rocker sends an N-message and releasing the rocker sends a U-message!

If ORG = 6, 7 or 8 (all other telegrams):

7	0
Reserved	RP_COUNTER

Reserved	(4 bit)	For future use	
RP_COUNTER	(4 bit)	Repeater level: 0 is original message (not repeated)	

Please consider the "IMPORTANT NOTE" above!

A.2.4 Detailed description of DATA_BYTE 3..0 fields

If ORG = 5 and NU = 1 (N-message from a PTM switch module):

DATA_BYTE2..0 always = 0
 DATA_BYTE3 as follows:

7						0
RID	UD	PR	SRID	SUD	SA	

RID	(2 bit)	Rocker ID, from left (A) to right (D): 0, 1, 2 and 3
UD	(1 bit)	UD=1 → O-button, UD=0 → I-button
PR	(1 bit)	PR=1 → Energy bow pressed, PR=0 → Energy bow released
SRID	(2 bit)	Second Rocker ID, from left to right: 0, 1, 2 and 3
SUD	(1 bit)	(Second) SUD=1 → O-button, SUD=0 → I-button
SA	(1 bit)	SA=1 → Second action (2 buttons pressed simultaneously), SA=0 → No second action

If ORG = 5 and NU = 0 (U-message from a PTM switch module):

DATA_BYTE2..0 always = 0
 DATA_BYTE3 as follows:

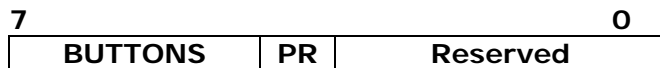

BUTTONS (3 bit) Number of simultaneously pressed buttons, as following:

PTM 100 (Type1):	PTM200 (Type2):
0 = 0 Buttons	0 = 0 Button
1 = 2 Buttons	1 = not possible
2 = 3 Buttons	2 = not possible
3 = 4 Buttons	3 = 3 or 4 buttons
4 = 5 Buttons	4 = not possible
5 = 6 Buttons	5 = not possible
6 = 7 Buttons	6 = not possible
7 = 8 Buttons	7 = not possible

PR (1 bit) PR = 1 → Energy bow pressed,
 PR = 0 → Energy bow released

Reserved (4 bit) for future use

If ORG = 6 (Telegram from a 1 Byte STM sensor):

DATA_BYTE2..0 always = 0
 DATA_BYTE3 Sensor data byte.

If ORG = 7 (Telegram from a 4 Byte STM sensor):

DATA_BYTE3 Value of third sensor analog input (AD_2)
 DATA_BYTE2 Value of second sensor analog input (AD_1)
 DATA_BYTE1 Value of first sensor analog input (AD_0)
 DATA_BYTE0 Sensor digital inputs as follows:



According to "Standardization EnOcean Communication Profiles" which defines interoperable communication profiles for devices based on EnOcean Technology DI_3=0 indicates a teach-in telegram! DI_3 should therefore not be used for other purposes than signalling a teach-in telegram.

If ORG = 8 (Telegram from a HRC transmitter):

DATA_BYTE2..0 always = 0
 DATA_BYTE3 as follows:

7	0
RID	Reserved

RID	(2 bit)	Rocker ID, from left (A) to right (D): 0, 1, 2 and 3
UD	(1 bit)	UD=1 → O-button, UD=0 → I-button
PR	(1 bit)	PR=1 → Button pushed, PR=0 → Button released
SR	(1 bit)	SR=1 → Store, SR=0 → Recall (see note)
Reserved	(3 bit)	for future use

Note: The bit SR is used only when the lower 3 Bits from ID_BYTE0 = 0b111 (scene switch), and RID ≠ 0 (indicates that the memory buttons M0-M5 are operated in the hand-held remote control).

PRELIMINARY

A.3 Command telegrams and messages

A.3.1 ID Range commands

Every TCM 300 supports a unique 32 bit ID and in addition a range of 128 IDs starting at an BaseID address. At production, every TCM 300 is programmed with a unique ID and a BaseID address. The BaseID number can be read via the serial interface. In order to allow a replacement of one unit with another unit (without having to go through the learning procedure with every receiver), the ID range can be changed via the serial interface. The allowed ID range is from 0xFF800000 to 0xFFFFFFFF. In order to prevent misuse, this feature can only be used 10 times! Please note: The unique ID cannot be changed.

Command (TCT)	Response (RMT)
SET_BASEID	OK, ERR, ERR_IDRANGE
RD_BASEID	INF_BASEID

A.3.2 Receiver sensitivity commands

The receiver sensitivity can be changed by the following commands. In LOW sensitivity mode, only transmitters in the vicinity of the module are received.

Command (TCT)	Response (RMT)
SET_RX_SENSITIVITY	OK
RD_RX_SENSITIVITY	INF_RX_SENSITIVITY

A.3.3 Reset command

Command (TCT)	Response (RMT)
RESET	

A.3.4 SW Version

Command (TCT)	Response (RMT)
RD_SW_VER	INF_SW_VER

A.3.5 Error messages

Error Messages (RMT)
ERR
ERR_TX_IDRANGE
ERR_IDRANGE
ERR_SYNTAX

A.3.6 Command Encoding

OK

Bit 7

Bit 0

0xA5
0x5A
0x8B
0x58
X
X
X
X
X
X
X
X
X
ChkSum

Standard message used to confirm that an action was performed correctly by the TCM.

In case of full duplex communication it may happen that serial telegrams get corrupted and lost. Therefore it is recommended to check for "OK" where applicable.

ERR

Bit 7

Bit 0

0xA5
0x5A
0x8B
0x19
X
X
X
X
X
X
X
X
X
ChkSum

Standard error message response if after a TCT command the operation could not be carried out successfully by the TCM.

SET_BASEID

Bit 7

Bit 0

0xA5
0x5A
0xAB
0x18
BaseIDByte3
BaseIDByte2
BaseIDByte1
BaseIDByte0
X
X
X
X
ChkSum

With this command the user can rewrite its ID range base number. The most significant ID byte is BaseIDByte3. The information of the 25 most significant bits is stored in FLASH.

The allowed ID range is from 0xFF800000 to 0xFFFFFFFF.

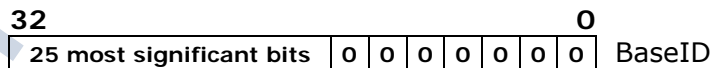

This command can only be used a maximum number of 10 times. After successfully ID range reprogramming, the TCM answers with an OK telegram. If reprogramming was not successful, the TCM answers sending an ERR telegram if the maximum number of 10 times is exceeded or an ERR_IDRANGE telegram if the

BaseID is not within the allowed range.

RD_BASEID

Bit 7 Bit 0

<i>0xA5</i>
<i>0x5A</i>
<i>0xAB</i>
<i>0x58</i>
X
X
X
X
X
X
X
X
X
<i>ChkSum</i>

When this command is sent to the TCM, the base ID range number is retrieved though an INF_BASEID telegram.

INF_BASEID

Bit 7 Bit 0

<i>0xA5</i>
<i>0x5A</i>
<i>0x8B</i>
<i>0x98</i>
<i>BaseIDByte3</i>
<i>BaseIDByte2</i>
<i>BaseIDByte1</i>
<i>BaseIDByte0</i>
X
X
X
X
X
<i>ChkSum</i>

This message informs the user about the ID range base number. BaseIDByte3 is the most significant byte.

SET_RX_SENSITIVITY

Bit 7 Bit 0

<i>0xA5</i>
<i>0x5A</i>
<i>0xAB</i>
<i>0x08</i>
<i>Sensitivity</i>
X
X
X
X
X
X
X
X
<i>ChkSum</i>

This command is used to set the TCM radio sensitivity. In LOW radio sensitivity, signals from remote transmitters are not detected by the TCM receiver. This feature is useful when only information from transmitters in the vicinity should be processed. An OK confirmation telegram is generated after TCM sensitivity has been changed.

Sensitivity=0x00 Low sensitivity
Sensitivity=0x01 High sensitivity

RD_RX_SENSITIVITY

Bit 7

Bit 0

<i>0xA5</i>
<i>0x5A</i>
<i>0xAB</i>
<i>0x48</i>
<i>X</i>
<i>X</i>
<i>X</i>
<i>X</i>
<i>X</i>
<i>X</i>
<i>X</i>
<i>X</i>
<i>X</i>
<i>ChkSum</i>

This command is sent to the TCM to retrieve the current radio sensitivity mode (HIGH or LOW). This information is sent via a INF_RX_SENSITIVITY command.

INF_RX_SENSITIVITY

Bit 7

Bit 0

<i>0xA5</i>
<i>0x5A</i>
<i>0x8B</i>
<i>0x88</i>
<i>Sensitivity</i>
<i>X</i>
<i>X</i>
<i>X</i>
<i>X</i>
<i>X</i>
<i>X</i>
<i>X</i>
<i>ChkSum</i>

This message informs the user about the current TCM radio sensitivity.
 Sensitivity= 0x00 Low sensitivity
 Sensitivity= 0x01 High sensitivity

RESET

Bit 7

Bit 0

<i>0xA5</i>
<i>0x5A</i>
<i>0xAB</i>
<i>0x0A</i>
<i>X</i>
<i>X</i>
<i>X</i>
<i>X</i>
<i>X</i>
<i>X</i>
<i>X</i>
<i>X</i>
<i>ChkSum</i>

Performs a reset of the TCM microcontroller.

RD_SW_VER

Bit 7 Bit 0

<i>0xA5</i>
<i>0x5A</i>
<i>0xAB</i>
<i>0x4B</i>
<i>X</i>
<i>X</i>
<i>X</i>
<i>X</i>
<i>X</i>
<i>X</i>
<i>X</i>
<i>X</i>
<i>X</i>
<i>ChkSum</i>

This command requests the TCM to send its current software version number. This information is provided via an INF_SW_VER telegram by the TCM.

INF_SW_VER

Bit 7 Bit 0

<i>0xA5</i>
<i>0x5A</i>
<i>0x8B</i>
<i>0x8C</i>
<i>TCM SW Version Pos.1</i>
<i>TCM SW Version Pos.2</i>
<i>TCM SW Version Pos.3</i>
<i>TCM SW Version Pos.4</i>
<i>API Version Pos.1</i>
<i>API Version Pos.2</i>
<i>API Version Pos.3</i>
<i>API Version Pos.4</i>
<i>X</i>
<i>ChkSum</i>

Informs the user about the current software version of the TCM. Example: Version 1.0.1.16
 TCM SW Version Pos.1 = 1
 TCM SW Version Pos.2 = 0
 TCM SW Version Pos.3 = 1
 TCM SW Version Pos.4 = 16

ERR_SYNTAX

Bit 7 Bit 0

<i>0xA5</i>
<i>0x5A</i>
<i>0x8B</i>
<i>Field</i>
<i>X</i>
<i>X</i>
<i>X</i>
<i>X</i>
<i>X</i>
<i>X</i>
<i>X</i>
<i>X</i>
<i>X</i>
<i>ChkSum</i>

This telegram is sent automatically through the serial port after the TCM has detected a syntax error in a TCT telegram. Errors can occur in the H_SEQ, LENGTH, ORG or CHKSUM fields/bytes.

Field code:
 H_SEQ=0x08 ORG=0x0B
 LENGTH=0x09 CHKSUM=0x0A

ERR_TX_IDRANGE

Bit 7

Bit 0

<i>0xA5</i>
<i>0x5A</i>
<i>0x8B</i>
<i>0x22</i>
<i>X</i>
<i>X</i>
<i>X</i>
<i>X</i>
<i>X</i>
<i>X</i>
<i>X</i>
<i>X</i>
<i>X</i>
<i>X</i>
<i>ChkSum</i>

When a radio telegram intended to be sent has an ID number outside the ID range, this error message is generated. The radio telegram is not delivered.

ERR_IDRANGE

Bit 7

Bit 0

<i>0xA5</i>
<i>0x5A</i>
<i>0x8B</i>
<i>0x1A</i>
<i>X</i>
<i>X</i>
<i>X</i>
<i>X</i>
<i>X</i>
<i>X</i>
<i>X</i>
<i>X</i>
<i>X</i>
<i>ChkSum</i>

This message is generated when the user tries to change the ID range base using the SET_BASEID command to a value outside the allowed range from 0xFF800000 to 0xFFFFFFFF.

PRELIMINARY