

# PTM 210 / PTM 215 PTM 215U PTM 215J

## Pushbutton transmitter modules DC Step code and later

The product is protected by the following granted Patents:

US7710227, DE10315765B4

US9614553, EP1312171B1, CN100508406C

EP1389358B1, JP4225792B2

US7019241, EP1550202B1, DE50303733D1, CN1689218B

US7391135, EP1611663B1, DE10315764B4,

US8502470, JP5617103B2

EP2524572B1

And also by pending or not yet published Patents and Designs.

---

## REVISION HISTORY

The following major modifications and improvements have been made from the first version of this document:

No	Major Changes
2.0	Update to modules with step code DC.
2.1	Update of certification numbers in US and Japan.

**Published by EnOcean GmbH, Kolpingring 18a, 82041 Oberhaching, Germany**  
**www.enocean.com, info@enocean.com, phone ++49 (89) 6734 6890**

© EnOcean GmbH  
All Rights Reserved

### Important!

This information describes the type of component and shall not be considered as assured characteristics. No responsibility is assumed for possible omissions or inaccuracies. Circuitry and specifications are subject to change without notice. For the latest product specifications, refer to the EnOcean website: <http://www.enocean.com>.

As far as patents or other rights of third parties are concerned, liability is only assumed for devices, not for the described applications, processes and circuits.

EnOcean does not assume responsibility for use of devices described and limits its liability to the replacement of devices determined to be defective due to workmanship. Devices or systems containing RF components must meet the essential requirements of the local legal authorities.

The devices must not be used in any relation with equipment that supports, directly or indirectly, human health or life or with applications that can result in danger for people, animals or real value.

Components of the devices are considered and should be disposed of as hazardous waste. Local government regulations are to be observed.

Packing: Please use the recycling operators known to you. By agreement we will take packing material back if it is sorted. You must bear the costs of transport. For packing material that is returned to us unsorted or that we are not obliged to accept, we shall have to invoice you for any costs incurred.

## TABLE OF CONTENT

1	GENERAL DESCRIPTION.....	5
1.1	Product variant and ordering codes .....	5
1.2	Basic Functionality .....	6
1.3	Typical Applications .....	8
1.4	Technical Data .....	10
1.5	Mechanical Interface.....	10
1.6	Environmental Conditions.....	11
1.7	References .....	11
2	FUNCTIONAL DESCRIPTION.....	12
2.1	Block Diagram .....	12
2.2	Contact Nipples assignment.....	13
2.3	Available EnOcean Equipment Profiles.....	13
3	OPERATING MODES.....	15
3.1	Normal mode operation .....	15
3.2	Secure mode operation .....	15
3.2.1	Implicit RLC – legacy, not recommended.....	17
3.2.2	Explicit RLC – recommended .....	17
3.2.3	Security Teach-in .....	17
3.3	Switching between modes .....	18
3.4	Factory reset .....	20
4	Radio Communication .....	21
4.1	ERP 1 Communication.....	21
4.1.1	ULP Frames .....	21
4.1.2	Common Frames.....	23
4.2	ERP 2 Communication.....	24
4.2.1	Normal mode Telegram.....	24
4.2.2	Secure mode Telegram .....	24

5	NFC INTERFACE CONFIGURATION – PTM 215 / PTM 215J / PTM 215U .....	25
5.1	NFC interface overview .....	25
5.2	NFC access protection.....	25
5.3	NFC parameters – Memory map.....	25
5.3.1	Device identification NDEF.....	27
5.3.2	User information NDEF .....	27
5.3.3	NFC Header.....	27
5.3.4	Configuration.....	29
5.4	NFC Interaction with the PTM Application .....	33
5.5	Accessing NFC with tools.....	33
5.5.1	EnOcean Tool .....	33
5.5.2	EnOcean NFC Configurator .....	35
5.5.3	Including NFC functionality into existing toolchains.....	35
6	APPLICATIONS INFORMATION .....	37
6.1	Product Label.....	37
6.2	Content of QR codes.....	39
6.3	Construction of application specific Switch Rockers.....	40
6.4	Device Mounting .....	41
6.5	Transmission Range .....	42
7	AGENCY APPROVALS .....	43
7.1	PTM 210 and PTM 215: Radio Approval for the European Market.....	43
7.3	PTM 215U: FCC and Industry Canada Regulatory Statements .....	44
7.4	PTM 215J: Japanese Type Approval .....	45

## 1 GENERAL DESCRIPTION

The pushbutton transmitter family PTM 21x from EnOcean enables the implementation of wireless switches and remote controls without batteries. The PTM 21x pushbutton transmitters are self-powered (no batteries) and therefore maintenance-free. The power is provided by a built-in electro-dynamic power generator.

The main application are wireless switches in smart buildings. Products based on PTM 21x modules can also be used in hermetically sealed systems or in remote (not easily accessible) locations.

PTM 21x devices are available in variants supporting the 868 MHz, 902 MHz and 928MHz radio interface protocols of EnOcean Alliance Radio Standard ERP 1 & ERP 2.

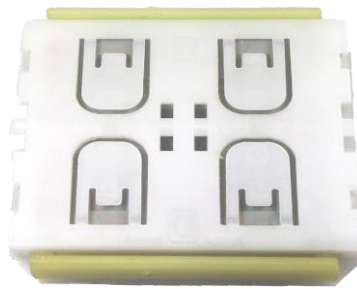

Figure 1 Electro-dynamic powered pushbutton transmitter module PTM 21x

With the major product update to the step code DC an additional NFC interface was added and the security mode option was extended to all PTM21x family members and frequencies.

### 1.1 Product variants and ordering codes

The PTM 21x product family contains the following product variants with product revision DC:

Type	Frequency	Ordering Code	Product specifics
<b>PTM 210</b>	<b>868.300 MHz</b>	<b>S3001-A210</b>	Encryption capability
<b>PTM 215</b>	<b>868.300 MHz</b>	<b>S3001-A215</b>	Encryption capability & NFC Interface
<b>PTM 215U</b>	<b>902.875 MHz</b>	<b>S3051-A215</b>	Encryption capability & NFC Interface
<b>PTM 215J</b>	<b>928.350 MHz</b>	<b>S3061-A215</b>	Encryption capability & NFC Interface

Table 1 Product Variants

### 1.1.1 Previous / other product variants

Previous versions of the PTM 21x product family (identified by step codes (DA and DB) contain only a subset of the functionality described in the document. Should you need information related to these products then please do not use this document as reference and refer to EnOcean support ([support@enocean.com](mailto:support@enocean.com)) for more details.

This document describes PTM modules with the EnOcean Radio Standard. For other radio standards PTMs (e.g. BLE, ZigBee) please visit the EnOcean Product page<sup>1</sup> and select the product type to find the available information.

## 1.2 Basic Functionality

PTM 21x devices contain an electro-dynamic energy transducer which is actuated by a bow.

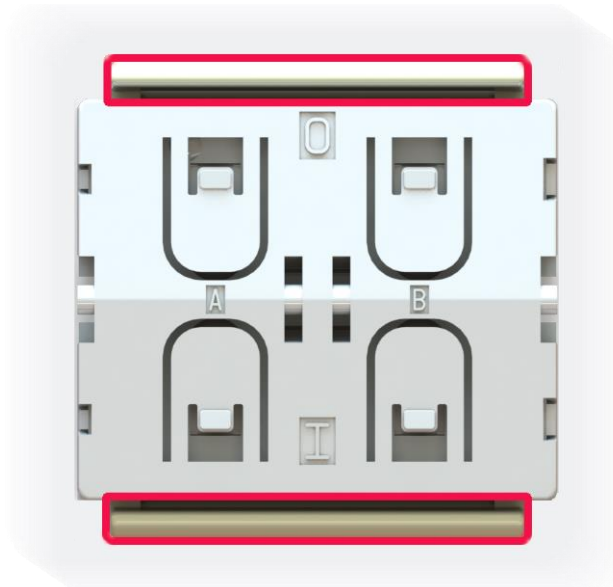

Figure 2 Drawing with highlighted energy bow

This bow is pushed by an appropriate push button, switch rocker or a similar construction mounted onto the device. An internal spring will release the energy bow as soon as it is not pushed down anymore.

When the energy bow is pushed down, electrical energy is harvested and a radio telegram is transmitted. Releasing the energy bow similarly generates energy which is used to transmit an another radio telegram.

---

<sup>1</sup> <https://www.enocean.com/en/products/>

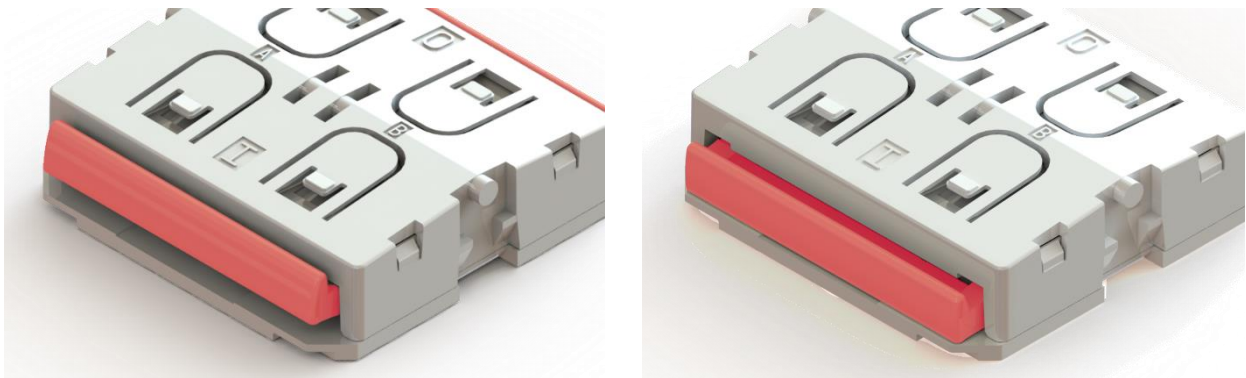

Figure 3 Energy bow released & pressed

It is therefore possible to distinguish between radio telegrams sent when the energy bow was pushed and radio telegrams sent when the energy bow was released. This makes it possible to distinguish between button press and button release actions.

By identifying these different telegram types and measuring the time between pushing and releasing at the receiver, it is possible to distinguish between “Long” and “Short” push button presses. This enables simple implementation of applications such as dimming or blinds control.

The radio telegram used by PTM 21x devices identifies the status of the four contact nipples when the energy bow was pushed or released. This enables the implementation of up to two switch rockers or up to four pushbuttons.

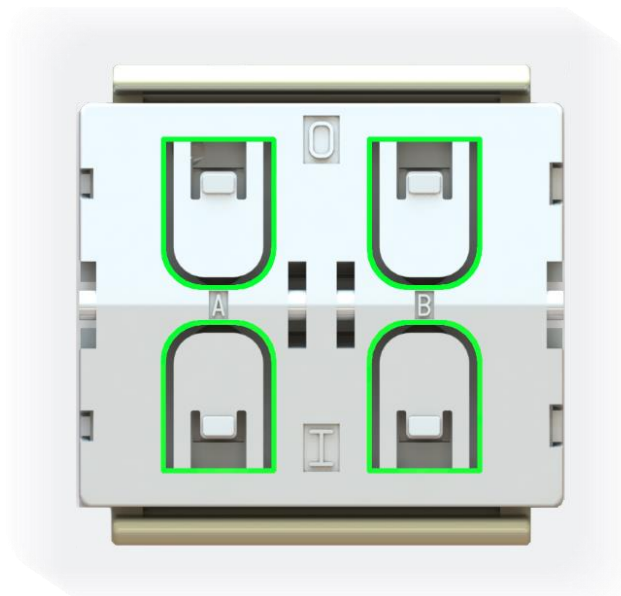

Figure 4 Drawing with highlighted coding nipples

All PTM 21x devices support two operating modes - a normal mode and a secure mode with rolling code encryption to enable use in secure applications.

Additionally, to the EnOcean Radio interface the PTM 215 modules include a NFC interface for device configuration. This NFC interface is powered by the NFC field of an NFC Reader or an NFC capable smartphone. This makes the communication with the PTM 215 modules possible even when the PTM is not being actuated. With a smartphone and an App e.g. [EnOcean Tool](#) or with an NFC Reader and a PC tool e.g. [EnOcean NFC Configurator](#) it is therefore possible to read information about the PTM module and write configuration parameters.

### 1.3 Typical Applications

PTM 21x modules are commonly used in the following areas:

- Building installation
- Industrial automation
- Consumer electronics

Key products include wall-mounted switches and handheld remote controls supporting up to two rockers or up to four pushbuttons.

Please find below two examples of an PTM module assembled into a white housing. The left example shows a double rocker application and the right a single rocker application. This is commonly used in the European market. A wide range of custom designs with different shapes, materials and colours can be used together with PTM modules as long they respect the standardized mechanical interface. Refer to the PTM module mounting instructions for details [1]. This allows customizable designs with well tested and promoted PTM modules.



Figure 5 Example of an assembled PTM Module (single and double rocker wall switch)

To illustrate the stack up in complete switch please find below an explosion drawing showing a possible switch frame mounting with highlighted PTM module highlighted red.



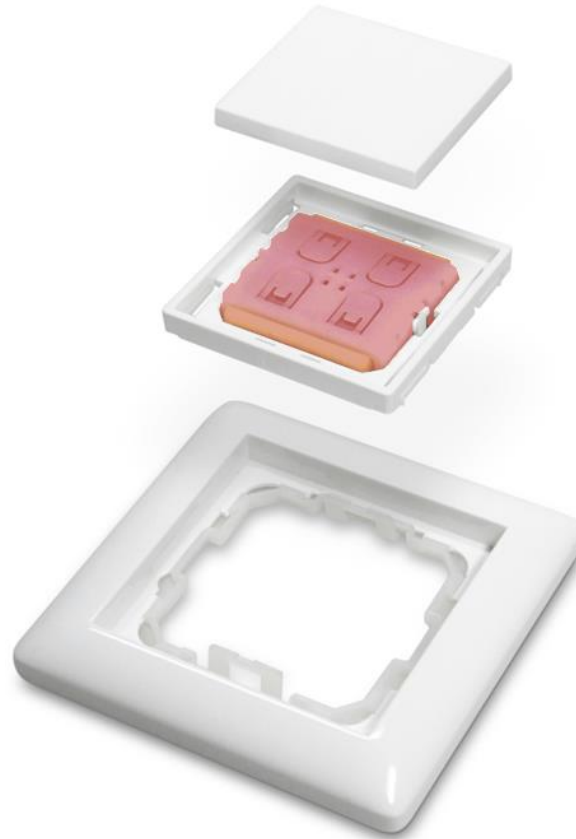

Figure 6 Explosion drawing of complete wall switch with highlighted PTM Module

## 1.4 Technical Data

<b>Power supply</b>	Electro-dynamic power generator
<b>Antenna</b>	PCB antenna
<b>Frequency</b>	PTM 210: 868.300 MHz (ASK) <sup>2</sup> PTM 215: 868.300 MHz (ASK) <sup>1</sup> PTM 215U: 902.875 MHz (FSK) PTM 215J: 928.350 MHz (FSK)
<b>Data rate</b>	125 kbps
<b>Conducted output power</b>	PTM 210 / PTM 215 / PTM 210U: +5 dBm PTM 210J: 0 dBm
<b>Channels</b>	Two channels with two pushbuttons per channel Four action states per channel (upper/lower/pressed/not pressed)
<b>EnOcean Radio Standard</b>	ERP1 based on ISO/IEC 14543-3-10: PTM 210, PTM 215 ERP2 based on ISO/IEC 14543-3-11: PTM 215U, PTM 215J
<b>EnOcean Equipment Profile supported</b>	F6-02-xx, F6-04-xx (normal mode) D2-03-00 (secure mode)
<b>Security mode</b>	Rolling code with AES128
<b>Transmission range</b>	PTM 210 / PTM 215 / PTM 210U: typ. 300 m free field, typ. 30 m indoor PTM 210J: typ. 200m free field, typ. 30m indoor
<b>Device identifier</b>	Individual 32 or 48 bit ID (factory programmed)
<b>Redundant sub-telegram count per radio transmission</b>	3 normal mode / 2 secure mode

## 1.5 Mechanical Interface

<b>Device dimensions (inclusive rotation axis and energy bow)</b>	40.0 x 40.0 x 11.2 mm
<b>Device weight</b>	20 g ± 1 g
<b>Energy bow travel / operating force</b>	1.8 mm / typ. 9 N At room temperature
<b>Restoring force at energy bow</b>	typ. 0.7 N to 4 N Minimum restoring force of 0.5 N is required for correct operation
<b>Number of operations at 25°C</b>	typ. 100.000 actuations tested according to EN 60669 / VDE 0632
<b>Cover material</b>	Hostaform (POM)
<b>Energy bow material</b>	PBT (50% GV)

<sup>2</sup> According the international standard for energy harvesting wireless radio protocol for self-powered applications: ISO/IEC 14543-3-10

## 1.6 Environmental Conditions

<b>Operating temperature</b>	-25 °C up to +65 °C <sup>3</sup>
<b>Storage temperature</b>	-25 °C up to +65 °C
<b>Humidity</b>	0% to 95% r.h.



Typical max. temperature difference between the PTM module (TX) and a receiver (RX) should not be bigger than 60 C°.

## 1.7 References

- [1] Mounting Instructions PTM  
[https://www.enocean.com/products/enocean\\_modules/ptm-215/](https://www.enocean.com/products/enocean_modules/ptm-215/)
- [2] 2D and 3D model for PTM Rockers  
[https://www.enocean.com/products/enocean\\_modules/ptm-215/](https://www.enocean.com/products/enocean_modules/ptm-215/)
- [3] EnOcean Alliance Standards (incl. EEP, Security, Labelling, NFC)  
<https://www.enocean-alliance.org/specifications/>
- [4] EnOcean Radio Protocol 1&2  
<https://www.enocean.com/en/support/knowledge-base/>

---

<sup>3</sup> Operation below – 10°C might result in reduction of redundant sub telegram counts by 1.

## 2 FUNCTIONAL DESCRIPTION

### 2.1 Block Diagram

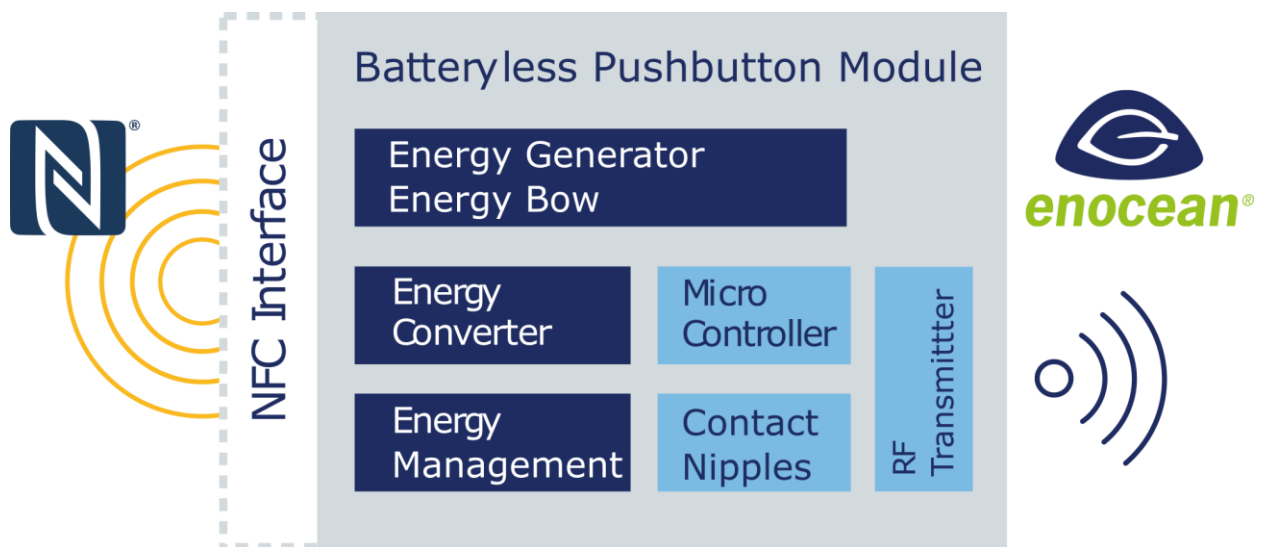

Figure 7 Block diagram of PTM 21x

#### Energy Generator / Energy Bow

Converts the motion of the energy bow into electrical energy. This is the main energy source for the operation of PTM Modules.

#### Energy Converter

Converts the energy of the energy generator into a stable DC supply voltage for the device electronics.

#### Energy Management

Secures energy supply of the module for the required period. The generator provides an burst of energy which needs to be conserved for the much longer period than the burst lasts.

#### Microcontroller

Determines the status of the contact nipples and the energy bow, encodes this status into a EnOcean Data telegram, if required it encrypts this data and computes the authentication signature, generates the proper radio telegram structure and sends it to the radio transmitter.

#### RF Transmitter

Transmits the data as a series of short EnOcean radio telegrams.

#### Contact Nipples

Via the 4 contact nipples the rockers or other custom plastics can code specific information into the radio telegram triggering different functions at the receiver.

## NFC Interface

The NFC interface represents the second communication interface of the PTM and it is designed for commissioning of the PTM device. Using the NFC module information, modes and runtime parameters can be read and in selected parameters also written.

### 2.2 Contact Nipples Assignment

PTM 21x devices provide four contact nipples. They are grouped into two channels (Channel A and Channel B) each containing two contact nipples (State O and State I). Resulting the nipples are referred to as: AO, AI, BO and BI.

The state of all four contact nipples is transmitted together with a unique device identification whenever the energy bow is pushed or released as a part of an EnOcean radio telegram. The exact encoding is defined in the EEP Profile. Which EEP is used is based on the Radio Standard (ERP1 or ERP2) and operating mode (normal or secure). See chapter 2.3 for details on used EEPs.

The picture below shows the arrangement of the four nipples and their designation:

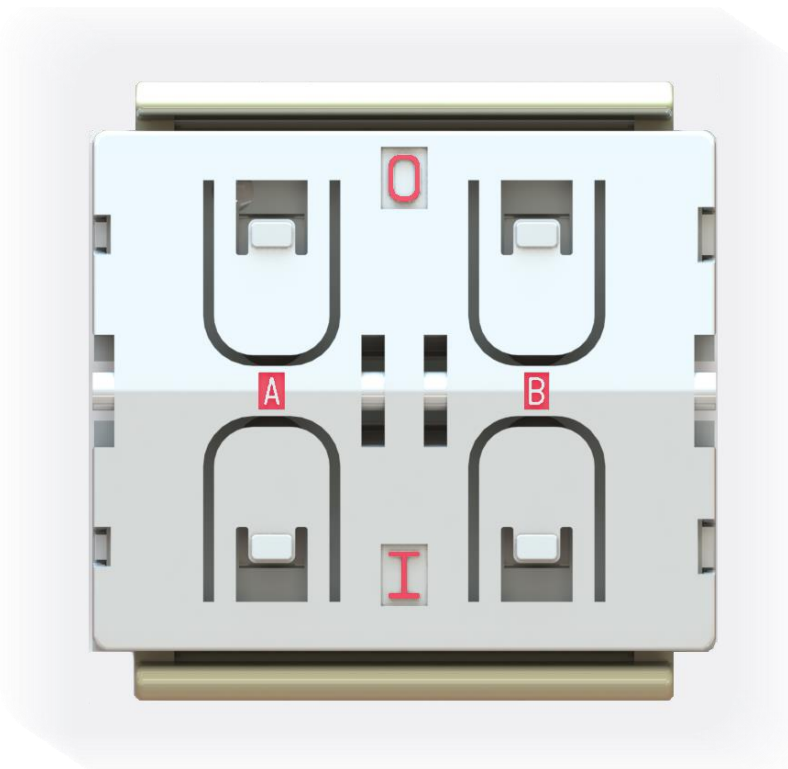

Figure 8 Contact nipple designation

### 2.3 Available EnOcean Equipment Profiles

The (EnOcean Equipment Profile) EEP profile defines how the data inside the EnOcean telegram is encoded. It practically means how the nipples and energy bow state are represented

in the radio telegram. Based on the EEP the receiver knows how to interpret telegrams received from a PTM module.

In contrast to sensors which usually support one profile at a time, the encoding of PTM module does not vary between profiles (RPS profiles) and it up to the receiver to decide how the data should be interpreted. The receiver can describe what action (switch on / off the light, dim up / down, move shutters, ...) to take. This makes PTM modules very flexible to use.

The table below summarizes the EEP supported by the different members of the PTM 21x product family.

	Normal Mode	Secure Mode
<b>ERP 1 (PTM 210, PTM 215)</b>	F6-01-01 F6-02-01 F6-02-02 F6-02-03 F6-04-01	D2-03-00
<b>ERP 2 (PTM 215J, PTM 215U)</b>	F6-02-04 F6-04-02	D2-03-00

Table 2 Possible EEPs

For the normal mode profiles (Starting with F6) there is no EEP Teach-in message sent. For secure mode profile (starting D2) there is Secure Teach In. See chapter 3.2.3 for details.



TCM 515U and TCM 310U convert ERP2 profiles to EPR1 profiles internally. On the ESP3 interface the messages look like "ERP1".



Due to the mechanical hysteresis of the energy bow, in most rocker switch device implementations, pressing the rocker sends an N-message and releasing the rocker sends a U-message.



Note that PTM 21x in will not send a data telegram when pressing 2, 3 or 4 nipple SBC and actuating the energy bow. This button combination is reserved for mode change. Please see chapter 3.3 for details.

### 3 OPERATING MODES

This chapter describes the standard “out of the box” behaviour of PTM 21x devices. This standard behaviour e.g. mode selection or secure teach-in telegram transmission can be altered by the NFC Interface. Please refer to the chapter 5.4 for details.

PTM 21x devices support two operating modes:

- Normal mode
- Secure mode, this mode has two additional sub options
  - Implicit RLC (legacy, not recommended)
  - Explicit RLC (recommended)

In production the PTM 21x is set into “normal mode” operation. This is therefore the “out of the box” behaviour of PTM 21x devices.

#### 3.1 Normal Mode Operation

In normal mode, PTM 21x transmits telegrams in the EEP profile respectively defined by ERP1 or ERP2. Please refer to Chapter 2.3. for details.

In Normal mode, transmission of PTM 21x modules is secured by the secure concept includes unique transmitter IDs. This means EnOcean products cannot be configured to transmit with identical transmitter ID except for the special case of Base IDs.

#### 3.2 Secure Mode Operation

While operating in secure mode, the PTM 21x sends secure telegrams in accordance to EEP D2-03-00. Please refer to Chapter 2.3. for details.

In secure mode, the PTM modules use advanced security protection with data encryption and message authentication. These mechanisms offer effective protection against a series of different attacks. One of the most concerning are Eavesdropping and Replay attacks.

Eavesdropping means somebody can receive and interpret the data correctly. Replay attacks means an intruder receives and records the message to be retransmitted (replayed) later in order to trigger an action.

An illustration of these attack scenarios are shown in the figure below.

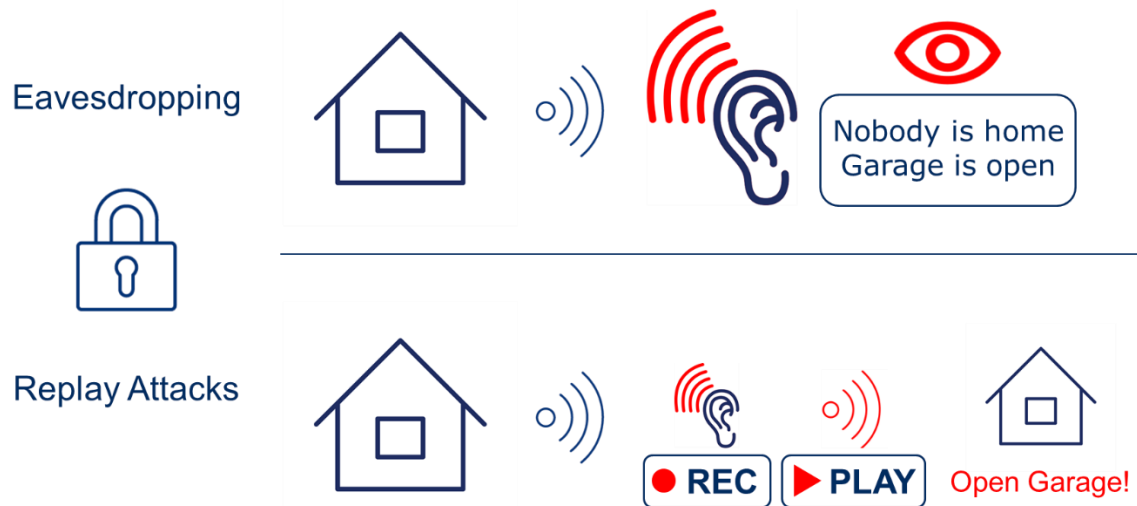

Figure 9 Example of harmful attacking scenarios PTM Modules are protected from

For details on the secure mechanisms please refer to the security specification of the EnOcean Radio Protocol [3] together with the examples given in the application note<sup>4</sup>.

Secure telegrams include a rolling code based on an incrementing counter (RLC) which guarantees that identical message content will be encrypted differently.

The counter can be:

- Included in each data message - explicit (recommended)

Or

- Not included in data messages – implicit (legacy, not recommended)

The counter value is also part of the teach-in telegram. The selection if the counter is implicit or explicit is done via the NFC interface (see chapter 5.3.4.3) or special button combinations at mode switching (see chapter 3.3).

There is no advantage in term of being “more secure” or “more protected” by using the implicit mode over explicit or vice versa. The “protection level” and security mechanisms are identical.

The RLC counter bit-size (24 bit explicit mode) practically ensures no “run over” will ever occur and one RLC value is never reused during the PTMs lifetime twice. It is initialized to 0 at production.

<sup>4</sup> [http://www.enocean.com/fileadmin/redaktion/pdf/app\\_notes/AN509\\_Overview\\_of\\_EnOcean\\_Security\\_features.pdf](http://www.enocean.com/fileadmin/redaktion/pdf/app_notes/AN509_Overview_of_EnOcean_Security_features.pdf)



The RLC counter is internally restarted to 0x0 once the AES key was changed via the NFC interface.

After executing a factory reset (see chapter 3.4 for details), the PTM module returns to using the factory set security key but does not reset the RLC counter associated with the key. The last used RLC value associated with the factory security set key will be used.

### **3.2.1 Implicit RLC – legacy, not recommended**

This mode is relevant only for the European market (868 MHz) because of certain legacy receivers. For the J and U market 928 MHz and 902 MHz, there are no such legacy receivers and thus this mode is completely deprecated in these markets.

The initial RLC counter value is transmitted from PTM 21x to the receiver only as part of the teach-in telegram. Subsequent secure telegrams do not include it. Therefore, receiver has to automatically increment its counter at every received telegram to keep it synchronized with the PTM Module.

When telegrams are not received by the receiver then this may lead to a de-synchronization of the RLC counter in the PTM module and the RLC counter in the receiver, i.e. the PTM module counter will have a greater value than the receiver counter.

In order to mitigate this issue, the receiver will usually test the received rolling code against a defined number – a window - of future expected rolling codes. If a RLC from within the window can be validated then the receiver will resynchronize its counter automatically to the new value.

The size of this rolling code window is defined on the receiver side.

For the correct function it is essential that the number of consecutive, non-received telegrams does not exceed the size of this window.

### **3.2.2 Explicit RLC – recommended**

This is the recommended secure mode for all frequencies and new applications.

In this mode the PTM module sends the RLC value as part of every data telegram. With transmission of the RLC in every data telegram a desynchronization of the RLC counters between receivers and transmitter like described above cannot happen.

The receiver uses the RLC value inside the radio telegram to decrypt and authenticate the received message. The receiver has to check if the received RLC is higher than the last known value and he does not have to apply any RLC window search mechanism.

### **3.2.3 Security Teach-in**

The Security teach-in includes required information for the receiver to decrypt future data communication. A security teach-in telegram is sent by PTM 21x after:

- Executing the special button combination for secure mode 2x nipple SBC or 3x nipple SBC – see chapter 3.3 for details.
- Trigger through the NFC interface.

Key Secure Teach-in Parameters are specified as following:

- *Type* of the *Teach-in\_info* in the secure teach-in telegram (`Teach_In_Info : Type`) is: 1-PTM.
- *Info* of the *Teach-in\_info* in the secure teach-in telegram (`Teach_In_Info : Info`) is: 0-Rocker A / 1-Rocker B.

The opposite nipple (e.g. A0&AI or B0&BI) of the used 2xSBC or 3xSBC define the rocker value (Rocker A or Rocker B) .

When then Secure Teach-in is triggered by NFC then the rocker is used which was used to generate energy and transmit the Secure Teach-in telegram. If both or no rocker was used, then Rocker A is coded.

- *SLF* is set to:
  - For implicit RLC (legacy, not recommended)  
24 bit MAC, VAES Encryption, 16 bit RLC, RLC no TX:
  - For explicit RLC (recommended)  
24 bit MAC, VAES Encryption, 24 bit RLC, RLC TX

For more information on the structure of the teach-in telegram please refer to the EnOcean Security specification [3].



If the teach-in process is not successful, please repeat the procedure. Due to the enhanced telegram length of teach-in telegrams in secure mode only a single teach-in sub-telegram is sent at every actuation (no redundancy).

### 3.3 Switching between modes

PTM 21x can be switched between normal mode and the secure modes by a special button combination SBC. There are three types of SBC:

- 2 nipple SBC – pressing both nipples of a channel i.e. AI & AO or BI & BO.  
This SBC is used to enter the secure mode with implicit RLC – legacy, not recommended. The picture below shows both variants of this combination.

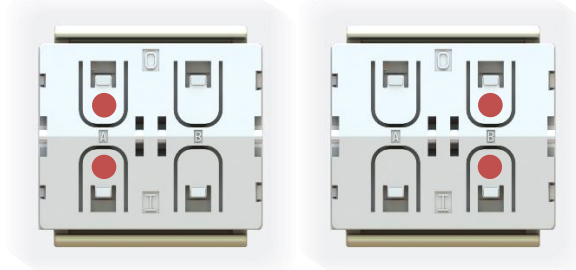

Figure 10 2 nipple SBC - channel A left, channel B right

- 3 nipple SBC – pressing any 3 nipples, which results in 4 different combinations. This SBC is used to enter the secure mode with explicit RLC. The picture below shows the possible options for this SBC.

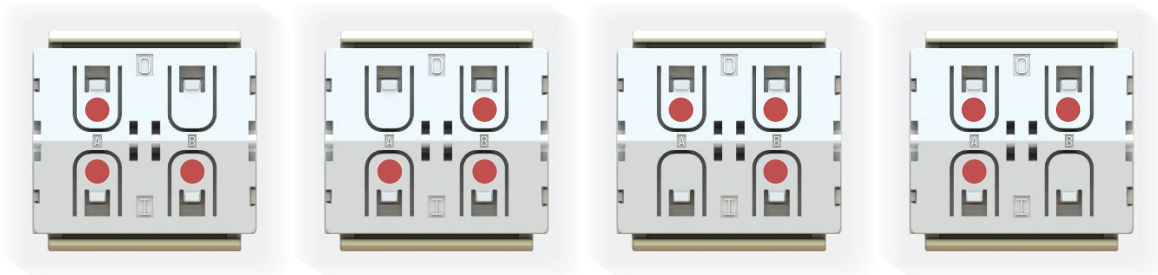

Figure 11 3 nipple SBC - 4 different options

- 4 nipple SBC – pressing all 4 nipples. This SBC is used to enter the normal mode and execute factory reset. The Picture below illustrates this.

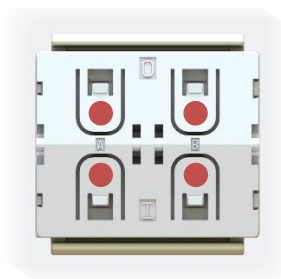

Figure 12 4 nipple SBC

To execute a mode change using any of these SBC, the energy bow must be activated in a defined sequence simultaneously. The SBC must be hold for the complete sequence.

The following transitions apply:

	2 SBC	3 SBC	4 SBC
Energy bow press	N/A	N/A	Switch to Normal Mode
Energy bow press/release	Transmit secure teach in – if current mode is security with <b>implicit</b> RLC.	Transmit secure teach in – if current mode is security with <b>explicit</b> RLC.	N/A
Energy bow press/release/press	Switch to Security mode with <b>implicit</b> RLC & transmit secure teach-in.	Switch to Security mode with <b>explicit</b> RLC & transmit secure teach-in.	N/A

Table 3 Transition table



Before changing the operating mode please make sure to clear the device from all receivers which have been taught-in with this device before. Otherwise the receiver will ignore the telegrams and the application will not work.

### 3.4 Factory Reset

The PTM module can execute a factory reset to return to the defined factory defaults. All changes done via SBC or the NFC interface with the exception of the following will be reset:

- Custom NFC message described in chapter 5.3.2.

The factory reset is executed with the 4 nipple SBC and simultaneously the sequence of 7x times pressing & releasing the energy bow.

## 4 Radio Communication

The PTM module transmits radio telegrams based on the EnOcean Alliance Radio standard. The Radio standard uses the ISO/IEC standard on the lowest protocol level.

There are two version of the EnOcean Radio Protocol:

1. "EnOcean Radio Protocol 1" – ERP 1 based on ISO/IEC 14543-3-10 mostly present in Europe & China
2. "EnOcean Radio Protocol 2" – ERP 2 based on ISO/IEC 14543-3-11 mostly present in US & Japan

The used radio standard defines the radio telegram structure. In the ERP1 there is also a difference between ultra-low power (ULP) frames and common frames.

### 4.1 ERP 1 Communication

The ERP1 uses different radio telegram structures depending on the operation mode of the PTM module. These structures are:

- Normal mode uses "normal mode ULP"
- Secure mode with implicit RLC – legacy, not recommended uses "Secure mode ULP"
- Secure mode with explicit RLC – recommended uses "Encrypted RPS Telegram"

The above-mentioned telegram frames are described in the chapters below.

#### 4.1.1 ULP Frames

To save energy the ULP Frames have effectively less payload than the common telegrams. The ULP Telegrams are also described in the EnOcean Alliance Air Interface Certification [3].

##### 4.1.1.1 Normal mode ULP

The normal mode ULP has total length of 6 bytes. The common frame (RPS), which the ULP is extend to, is 8 bytes long.

Please consider that EnOcean based receivers & repeaters will transform the ULP telegrams to common frames by default.

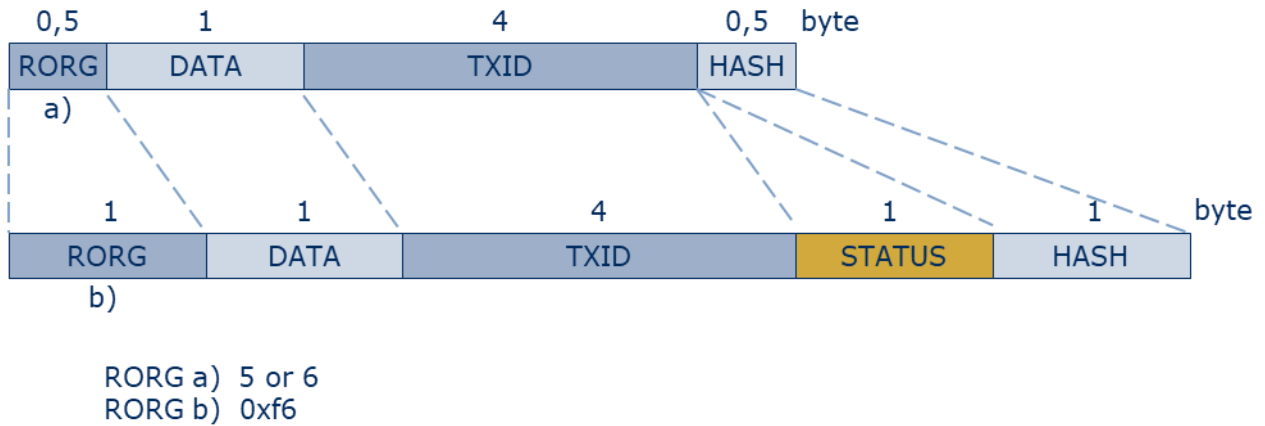

Figure 13 Normal mode ULP substitution to RPS

#### RORG

- The ULP has a value of 0x5 or 0x6 defined by the switch action. It is described in the EEP, see chapter 2.3 for details on the EEP. It is then substituted to 0xF6 (RPS).

#### DATA

- Is defined as payload of the EEP, see chapter 2.3 for details on EEP. No change during extension.

#### TXID

- Represents the EnOcean Unique ID. No change during extension.

#### STATUS

- Is created according to the EEP and EPR 1 specification.

#### HASH

- A 4-bit CHECKSUM in extended to an 8 bit CRC or CHECKSUM. For details please see the ERP 1 specification [4].

#### 4.1.1.2 Secure mode ULP

The secure mode ULP follows the same concept. The payload is reduced to save energy.

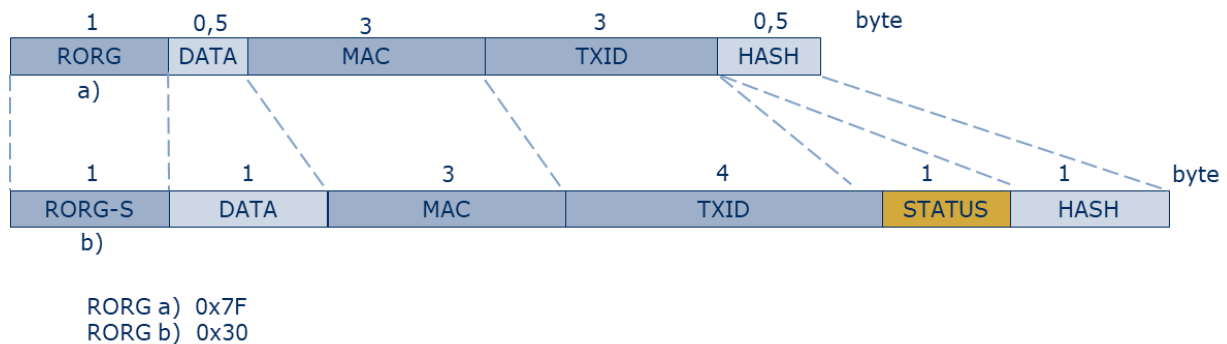

Figure 14 Secure mode ULP substitution to encrypted RPS

### RORG

- The secure low power switch RORG field code 0x7F is substituted by the secure telegram RORG (0x30) defined in the EnOcean Security Specification [3].

### DATA

- Is defined as payload of the EEP, see chapter 2.3 for details on EEP. No change in field when extended.

### MAC

- Message Authentication Cypher – defined in the EnOcean Security Specification. No change in this field when extended.

### TXID

- Represents the EnOcean Unique ID. On substitution the field is extended by 1 byte in the MSB position with 0xFE.

### STATUS

- Is created according the EEP and EPR 1 specification.

### HASH

- A 4-bit CHECKSUM is extended to an 8 bit CRC or CHECKSUM. For details please see the ERP 1 specification [4].

## 4.1.2 Common Frames

### 4.1.2.1 Encrypted RPS Telegram

The secure mode ULP supports only a selected type of Security Level Format - SLF. It does not support SLF with transmission of RLC – “explicit RLC”. To use SLFs with explicit RLC the definition had to be extended. Instead of redefining the secure mode ULP, the common RPS was used with encryption which did not require any additional specification work.

For details on encrypted RPS telegrams please see the EnOcean Security specification [3].

## 4.2 ERP 2 Communication

The ERP2 frames are fully described by the ERP2 specification. In the ERP2, there are no ULP frames defined and the PTM module uses the common definition. The ERP2 frame is defined as follows:



The relevant fields are defined below, for other fields and details please consult the ERP2 specification. Optional Data is not used in any type of the PTM module telegram.

### 4.2.1 Normal Mode Telegram

#### HEADER

- ADDRESS CONTROL: 0b001: Originator-ID 32 bit; no Destination-ID
- EXT. HEADER: 0b0: No extended header
- TELERGAM TYPE: 0b0000: RPS telegram (0xF6)

#### DATA OF DATALINK LAYER

- Is defined as payload of the EEP, see chapter 2.3 for details on EEP.

### 4.2.2 Secure Mode Telegram

#### HEADER

- ADDRESS CONTROL: 0b001: Originator-ID 32 bit; no Destination-ID
- EXT. HEADER: 0b0: No extended header
- TELERGAM TYPE: 0111: Secure telegram (0x30)

#### DATA OF DATA LINK LAYER

- Is defined as payload of the EEP, see chapter 2.3 for details on EEP.



## 5 NFC INTERFACE CONFIGURATION – PTM 215 / PTM 215J / PTM 215U

### 5.1 NFC Interface Overview

PTM 215 implements an NFC configuration interface that can be used to access (read and write) the PTM 215 configuration memory and thereby configure the device as described in the following chapters.

NFC communication distance is for security reasons set to require direct contact between the NFC reader and the PTM 215 device.

The NFC interface of PTM 215 uses NFC Forum Type 2 Tag functionality as specified in the ISO/IEC 14443 Part 2 and 3 standards. It is implemented using an NXP NT3H2111 Mifare Ultralight tag.

For specific implementation aspects related to the NXP implementation in NT3H2111, please refer to the NXP documentation which at the time of writing was available under this link: [https://www.nxp.com/docs/en/data-sheet/NT3H2111\\_2211.pdf](https://www.nxp.com/docs/en/data-sheet/NT3H2111_2211.pdf)

For a detailed description about the NFC functionality, please refer to the ISO/IEC 14443 standard.

### 5.2 NFC Access Protection

Protected data access is only possible after unlocking the configuration memory with the correct 32-bit PIN code. By default, the protected area is locked and the default pin code for unlocking access is 0x000E215.

The default pin code shall be changed to a user-defined value as part of the installation process. This can be done by unlocking the NFC interface with the old PIN code and then writing the new PIN code. For details please refer to chapter 5.3.

### 5.3 NFC Parameters – Memory Map

The NFC memory is organized in pages (a page is the smallest addressable unit) where each page contains 4 byte of data. Several pages with similar functionality form an NFC memory area.

These NFC pages are allocated into the following areas:

1. NDEF based (UTF-8)
  - Device Identification NDEF string (Public read-only access; no PIN required)  
This area contains an NDEF string identifying key device parameters

- User Information NDEF string (Public read / write access; no PIN required)  
This area allows any user to read or write information about the device such as the intended installation location or additional instructions.

2. Binary data area

- NFC HEADER (Public read-only access; no PIN required)  
This area contains information about the NFC revision.
- CONFIGURATION (Read and Write access, PIN required)  
This area contains device configuration registers
- INTERNAL DATA (Non-accessible)  
This area contains calibration values and internal parameters and cannot be used

The organization of the PTM 215 NFC memory map is shown in Table 4 below.

NFC Address	PIN Required	Operations	Memory Area	Content
0x01 - 0x1F	NO	Read only	PRODUCT NDEF	Device identification NDEF string
0x20 - 0x2F	NO	Read / Write	USER NDEF	User information NDEF string
Dynamic	NO	Read only	NFC HEADER	NFC memory revision
0x40 - 0x4A	YES	Read / Write	CONFIGURATION	Configuration registers
0x4B - 0x9F	N/A	N/A	INTERNAL DATA	Internal data (Do not use)

Table 4 – PTM 215 NFC memory areas

### 5.3.1 Device Identification NDEF

The NDEF area contains a device identification string using the NDEF (NFC Data Exchange Format) standard that is readable by most NFC-capable reader devices (including smartphones).

The NDEF content can be read also by conventional NTAG commands, but this is then executed in "binary" mode. The conversion to a string is achieved by applying UTF-8 decoding.

The contents of the NDEF container are defined by the EnOcean Alliance Labelling specification. For more details please see [3].

An example device identification string from the NDEF area of a PTM 215 module could be:

```
6PEN0+30S000012345678+1P000B00000053+30PS3001-A215+2PDC22+2Z01234567891234
+3C31+16S01000000
```

This NDEF string encodes the parameters shown in Table 5 below.

Identifier	Length of data (excl. identifier)	Value
6P	3 characters	Standard: "ENO"
30S	12 characters	EURID (6 byte, variable)
1P	12 characters	EnOcean Alliance Product ID PTM 215: „000B00000053“ PTM 215U: „000B00000055“ PTM 215J: „000B00000057“
30P	10 characters	Ordering Code PTM 215: "S3001-A215" PTM 215U: "S3051-A215" PTM 215J: "S3061-A215"
2P	4 characters	Step Code and Revision ("DC22")
2Z	14 characters	NFC UID (14 byte, globally unique)
3C	2 characters	Header Start Address ("31" = 0x31)
16S	8 characters	SW Version Example: 01000000 = 01.00.00.00

Table 5 – NDEF Parameters

### 5.3.2 User Information NDEF

The NDEF area allows the user to store a string of up to 64 characters starting at page 0x20 and ending at page 0x2F. The string is formatted in the UTF-8 encoding.

### 5.3.3 NFC Header

The NFC HEADER area contains information about the NFC memory structure and can therefore be used to distinguish between different NFC memory layouts. The start of the memory is defined by the Header Start Address from the device identification NDEF, see 5.3.1 for details.

The structure of the NFC HEADER area is described in detail in the EnOcean Alliance specification - NFC Memory Structure for Eco-system products, for details see reference [3]. Details are also shown in the table below.

NFC Address	Content			
	Byte 0	Byte 1	Byte 2	Byte 3
0x31	START (0xE0)	LENGTH (0x0A)	VERSION (0x01)	MAN ID MSB (0x00)
0x32	MAN ID LSB(0x0B)	NFC Struct ID (0x000001)		
0x33	REVISION (0x02)	END (0xFE)	UNUSED (0x0000)	

Figure 15 – NFC HEADER area structure

The NFC HEADER contains the following fields:

**START**

- This field identifies the start of the NFC header and is always set to 0xE0.

**LENGTH**

- This field identifies the length of the NFC header.
- This field is set to 0x0A since the header structure is 10 bytes long.

**VERSION**

- This field identifies the major revision of the NFC specification.

**MAN ID**

- The 16-bit Manufacturer ID is assigned by the EnOcean Alliance. The field identifies the manufacturer of the device so that manufacturer-specific layout implementations can be determined.
- For EnOcean GmbH products this field is set to 0x000B.

**NFC Struct ID**

- The 24-bit NFC Struct ID field identifies an individual device from the range of devices manufactured by the manufacturer specified in the Manufacturer ID field.
- For PTM 215, the NFC Struct ID is set to 0x000001.

**REVISION**

- The REVISION field identifies the exact revision of the NFC layout.
- The REVISION will be incremented whenever a change to the NFC layout is made. Changes are possible only when 100% backwards compatible to all previous revisions. If changes are not compatible a new NFC Struct ID must be defined.

**END**

- The END field identifies the end of the NFC header and is always set to 0xFE. The number of bytes from START to END must equal LENGTH, otherwise the NFC header is invalid.

### 5.3.4 Configuration

The CONFIGURATION area allows the configuration of the device parameters. Configuration registers larger than 8 bit use big endian format, i.e. the most significant byte comes first.

Read or write access to the CONFIGURATION area is only possible after unlocking the memory using the correct 32-bit PIN code. See chapter 5.2 for details.

Before making any changes to the default configuration, be sure to familiarize yourself with the functionality of the device and the effect of the intended changes.

The structure of the CONFIGURATION area is defined by the NFC Struct ID as described in chapter 5.3.3 and is shown in Figure 16 below.

NFC Address	Content			
	Byte 0	Byte 1	Byte 2	Byte 3
0x40	FLAG	RFU		
0x41	NEW NFC PIN			
0x42	SECURITY LEVEL	ALLOW TEACH IN	NEXT OPERATION IS TEACH IN	RFU
0x43	RFU			
0x44	USER KEY (128 Bit)			
...	(Write Only - Will be reset to zero after it has been copied to internal memory)			
0x47	Can be used as alternative security key instead of FACTORY_KEY			
0x48	PRODUCT ID			
0x49	(String with 12 characters "e.g. 000B00000053" in UTF-8 format – to be copied to NDEF)			
0x4A				

Figure 16 – CONFIGURATION area structure

Each field is explained in the following chapters.

#### 5.3.4.1 FLAG

This field needs to be changed to 0x55 to make the PTM application aware of the executed changes. Without setting this field to 0x55 the changes will not be considered by the PTM application.

#### 5.3.4.2 NEW NFC PIN

The NFC PIN used to protect access to the CONFIGURATION memory area should be changed from the default value to a user-specific value to avoid unauthorized access to the NFC device configuration interface.

To do so, first authenticate with the current NFC PIN and then write the new NFC PIN (32-bit value) to memory.

The new NFC PIN will be applied to the PTM module after pressing & releasing the energy bow. Until then, the previous NFC PIN will remain valid to unlock the NFC memory.

#### 5.3.4.3 SECURITY LEVEL

The security level register defines what encryption features are used in the radio transmission. If this register is changed from its default setting via the NFC interface, manual mode changes via SBC (as described in chapter 3.3) are no longer possible. Both 2 nipple SBC and 3 nipple SBC will still trigger the transmission of a Security Teach-in but in both cases the mode selected via NFC (If secure mode was selected)

To re-enable the "mode change by SBC", a factory reset needs to be executed. The mode change via NFC remains possible even after first write operation.

The operation and application behaviour of the selected mode is described in chapter 3. Following options can be selected:

- 0b00000000: Normal mode operation
- 0b00000001: Secure mode – Implicit RLC legacy
- 0b00000010: Secure mode – Explicit RLC (recommended)
- 0b00000011: Defined by SBC (default). This value cannot be set by NFC write operation.

0b0000 0100 – 0b1111 1111: RFU

#### 5.3.4.4 ALLOW TEACH IN

This flag controls if a Security Teach-in can be triggered by SBC. The Security Teach-in Telegram is described in chapter 3.2.3. The following values can be set:

- 0b00000000: OFF: SBC will not trigger a secure teach-in telegram
- 0b00000001: ON (default): SBC will trigger a secure teach-in telegram.

0b0000 0010 – 0b1111 1111: RFU

**5.3.4.5 NEXT OPERATION IS TEACH IN**

The module will send a Security Teach-in telegram the next time it is triggered. The module must first be set to the desired security level. After the secure Teach in telegram was send this flag is reset to default state. Following values can be set

- 0b00000000: OFF (default): Normal operation.
- 0b00000001: ON: Next telegram will be a Security Teach-in telegram.

0b0000 0010 – 0b1111 1111: RFU

**5.3.4.6 PRODUCT ID**

The EnOcean Alliance Product ID uniquely identifies each product within the EnOcean Alliance ecosystem. The Product ID consists of a 2-byte manufacturer identification code (assigned by EnOcean Alliance) and a 4-byte product identification code (assigned by the manufacturer.

EnOcean has been assigned the manufacturer identification code 0x000B. EnOcean has assigned the following product identification codes to PTM 215:

- PTM 215: 0x00000053
- PTM 215U: 0x00000055
- PTM 215J: 0x00000057

The PRODUCT ID register contains the Product ID in ASCII format (12 characters) and allows changing both manufacturer and product identification. Changing the PRODUCT ID will also cause the PRODUCT ID field in the NDEF string (described in chapter 5.3.1) to be updated.

Figure 17 below shows the structure of the PRODUCT ID register. This register contains the sequence of 12 ASCII characters (1 byte each) starting with CH0 and ending with CH11.

PRODUCT_ID											
CH0	CH1	CH2	CH3	CH4	CH5	CH6	CH7	CH8	CH9	CH10	CH11
Manufacturer ("000B")				Product ID ("00000053", "00000055" or "00000057")							

**Figure 17 – PRODUCT\_ID**

**5.3.4.7 USER\_KEY**

Each PTM 215 module is pre-programmed at the factory with a randomly generated 128-bit security key. This key will by default be used to encrypt and authenticate PTM 215 radio telegrams when operating in security mode. This key is also encoded inside the QR code on the label of the product.

In certain applications or situations, it might be desirable to assign a different (user-defined) security key. This can be done by writing the user-defined security key to the USER\_KEY.

Once the key was written the PTM 215 will automatically use the new written key and reset the RLC sequence to 0x0.

To return to the factory defined key a factory reset as described in chapter 3.4 must be executed.



Note that the USER\_KEY register is a write-only register meaning that it is not possible to read back a user-defined security key.



## 5.4 NFC Interaction with the PTM Application

The PTM 215 application is not powered by the NFC interface during NFC communication. After parameters in the NFC memory were changed, the energy bow has to be pressed and released so that the PTM application can read the new parameters, verify and apply them. For this purpose, also a special FLAG register must be set to notify the PTM Application about configuration changes. Description of the FLAG register can be found in chapter 5.3.4.

During the first press / release cycle immediately after an NFC configuration operation, the PTM module will update its internal parameters according to the provided configuration values and therefore not execute any radio communication. Afterwards e.g. during the second press / release cycle, normal operation will resume.

Configuring the following parameters will change the standard PTM module behaviour as explained in the chapter 3:

- SECURITY LEVEL, Chapter 5.3.4.3, Effect; Switching modes by SBC is not possible.
- ALLOW TEACH IN, Chapter 5.3.4.5, Effect: When entering Security Mode by SBC, a teach-in telegram is not transmitted anymore.

## 5.5 NFC Interface Tools

To operate the NFC interface of the PTM Modules there are different options:

- "EnOcean Tool" is a smartphone app available for iOS and Android
- "EnOcean NFC Configurator" is a PC application that can be used in conjunction with a specific NFC USB Reader
- Customer-developed tools
- 

### 5.5.1 EnOcean Tool



Figure 18 EnOcean Tool Icon

EnOcean Tool is a smartphone application for easy configuration and commissioning of EnOcean NFC devices such as the PTM 215 module, the STM 550 multisensor or the EMDC motion detector. This application serves as a configuration interface between NFC devices

and NFC readers such as NFC-enabled smartphones or tablets. It can be used to determine all essential product parameters.

The app is mainly aimed at OEMs and installers. They can also use the application to integrate NFC devices into existing systems. EnOcean Tool can be used to optimize the energy consumption of the respective device, monitor the energy-harvesting performance of the integrated solar cell (in sensors) and read out all product information such as product ID or device recognition. Access to the NFC interface is protected by a user-defined PIN code.

The EnOcean Tool app is available free of charge for the operating systems iOS and Android. For app downloads, tutorial videos and more details please visit the EnOcean Tool Product page: <https://www.enocean.com/products/enocean-software/enocean-tool/>

Direct download possible via these QR codes:



With EnOcean Tool you can configure only selected parameters of the products. Please check the Help Section of Product Manuals in EnOcean Tool for details.

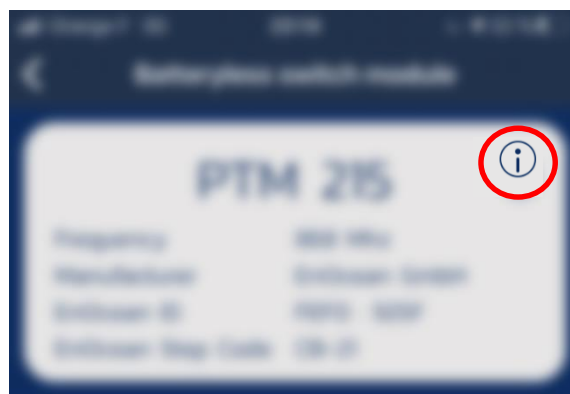

Figure 19 Help Section in EnOcean Tool

### 5.5.2 EnOcean NFC Configurator



Figure 20 EnOcean NFC Configurator

EnOcean provides the NFC Configurator for all OEM Partners to configure and commission EnOcean GmbH products with NFC interface. NFC Configurator is a PC application enabling to write / read all accessible parameters specified for the product. Configured parameters can also be stored into a separate file, reopened and shared with other users. It also includes a simple option to execute batch programming in small numbers and log the process.

The NFC Configurator is designed to work on PC running Windows 10 in conjunction with the external USB NFC reader TWN4 Multitech 2 HF NFC Reader (order code T4BT-FB2BEL2-SIMPL) from Elatec RFID Systems ([sales-rfid@elatec.com](mailto:sales-rfid@elatec.com)).

This reader is shown in Figure 21 below.



Figure 21 – Elatec TWN4 MultiTech Desktop NFC Reader

The EnOcean NFC Configurator SW can be downloaded from the EnOcean support & tools page: <https://www.enocean.com/support/download/>

### 5.5.3 Including NFC Functionality Into Existing Customer Tools

Reading and writing the NFC memory of the PTM module is done using the common NFC commands defined by the NFC Forum as described in chapter 5.1. This makes it easy for OEMs to include NFC configuration functionality into their own tools.

OEMs wanting to develop own NFC configuration tools or to include NFC configuration into their existing tools can accelerate their development by licensing the EnOcean SW libraries and the EnOcean reference implementation. Please contact EnOcean: [support@enocean.com](mailto:support@enocean.com) for more information or a commercial offer.

## 6 APPLICATIONS INFORMATION

### 6.1 Product Label

Listed below are the product labels for each of the PTM 21x modules. Each module can easily be identified by its name and the supported frequency (868.300 MHz 902.875 MHz, 928.350 MHz) on the label. Additionally, PTM 215 devices (which contain the NFC interface for configuration) can be identified by the NFC icon on the product label.

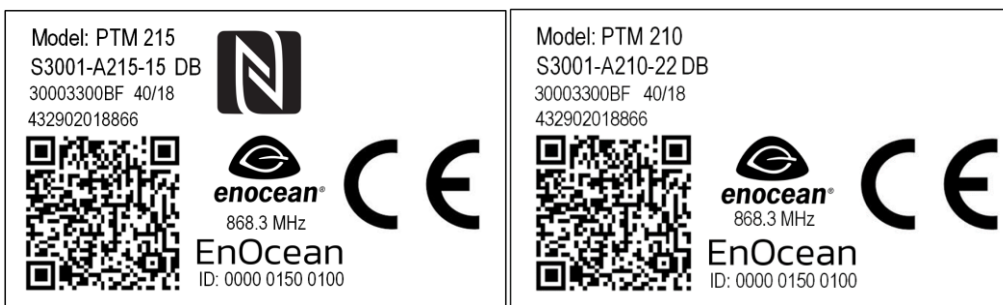

Figure 22 PTM 215 / PTM 210 EU labels

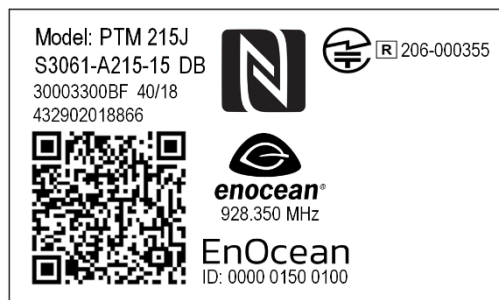

Figure 23 PTM 215J Japan / 928 MHz labels

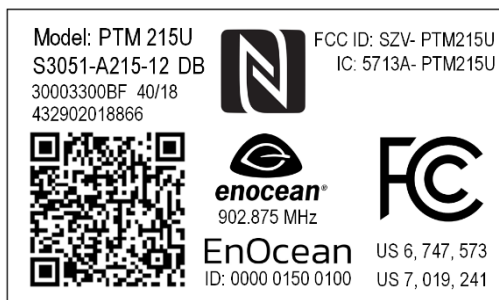

Figure 24 PTM 215U / US labels

The common customer relevant fields of the labelling have the following meaning:



Field	Meaning	Examples
Model	Product name	PTM 210 / PTM 215 / PTM 215J / PTM 215U
Order code	EnOcean Order code	S3001-A210 / S3001-A215 / S3051-A215 / S3061-A215
Step code	Product version	DC / DD / DE etc.
Production date	Week of year / production Year	40 / 18 (40 <sup>th</sup> week in 2018)
	NFC capability information – showing the position of the antenna.	
	Certification marking of the EnOcean Alliance with frequency specification.	Frequencies: 868.3 MHz, 902.875 MHz, 928.350 MHz
	Company name and Unique EnOcean ID in hexadecimal 48 bit format.	ID: 0x0000 0150 0100
	Production tracking in QR Code	See Chapter 0.

Table 6 QR Code containers

## 6.2 Content of QR codes

Reading the QR code will return a text string formatted according the EnOcean Alliance Labelling standard. Details about the labelling standard can be found here: <https://www.enocean-alliance.org/productid/>.

The same standard is also used to specify the NDEF String content.

The QR content example might look like this:

```
30S000001500100+13Z12345678123456781234567812345678+1P000B00000057+30PS3061-  
A215+2PDC22+S01123456789012
```

The string holds different information containers joined by "+". At the beginning of every container is an identifier e.g. "30S". The example string above consists of the following containers.

Identifier	Value	Length of data
30S	000001500100  Static Source Address (hex), <b>EnOcean Radio ID 48 bit format</b>	15 characters (12 data)
+	Field Separator	1 character
13Z	12345678123456781234567812345678  Security AES key (16 Bytes), generated and specific for each device	35 characters (32 data)
+	Field Separator	1 character
1P	000B00000057  Product ID (EnOcean Alliance),	14 characters (12 data)
+	Field Separator	1 character
30P	S3061-A215  Ordering Code (EnOcean module),	13 characters (10 data)
+	Field Separator	1 character
2P	DC22  Step Code - Revision (EnOcean module), e.g.	6 characters (4 data)
+	Field Separator	1 character
S	123456789012  Manufacturer recognition, 01 + DMC/Serial Number,	15 characters (2 + 12 data)
<b>Total: 102 characters</b>		

Table 7 QR code content example based on the above table

The length and content of the QR code can vary from the example for the case of different module revisions.

### 6.3 Construction of application specific Switch Rockers

EnOcean provides both 2D mechanical data and 3D construction data (in IGS format) of the mechanical interface of PTM 21x modules for the design of customer specific frames and rockers. This data is available here:

[https://www.enocean.com/produkte/enocean\\_module/ptm-215/](https://www.enocean.com/produkte/enocean_module/ptm-215/)

Polycarbonate is recommended as rocker material since it is both buckling resistant and wear-proof. It is also recommended to apply Teflon varnish in the areas of actuation.





It is recommended using non-conductive material for the rockers to ensure best transmission range. Avoid if possible metallic materials or plastics with conducting ingredients such as graphite.



If the rocker is not mounted on the rotation axis of PTM 21x several tolerances have to be considered! The measure from support plane to top of the energy bow is 7.70 mm +/- 0.3 mm!



The movement of the energy bow must not be limited by mounted rockers!



Catwalks of the switch rocker must not exert continuous forces on contact nipples!

## 6.4 Device Mounting

For mounting the PTM 21x device into an application specific case, the package outline drawings of the device are given in chapter 1.5. More detailed 3D construction data is available from EnOcean in IGS format as described in the previous chapter.



It is recommended not to mount the device directly onto metal surfaces or into metal frames since this can lead to significant loss of transmission range.

PTM is powered by the electromagnetic generator ECO 200. For proper function magnets or ferromagnetic materials are not permitted within a keep-out zone of 60mm around the centre of the PTM.

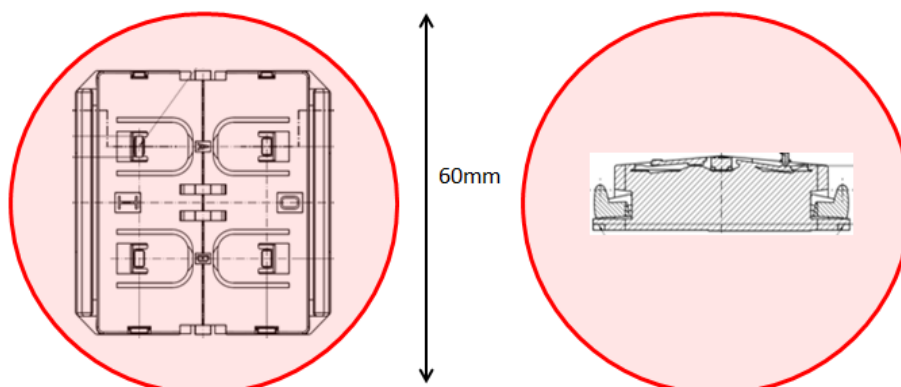

Figure 25 Keep of Area for magnetic and ferromagnetic materials

## 6.5 Transmission Range

The main factors that influence the system transmission range are:

- Type and location of the antennas of receiver and transmitter.
- Type of terrain and degree of obstruction of the link path.
- Sources of interference affecting the receiver.
- "Dead spots" caused by signal reflections from nearby conductive objects.

Since the expected transmission range strongly depends on this system conditions, range tests should always be performed to determine the reliably achievable range under the given conditions.

The following figures for expected transmission range are considered by using a PTM, an STM or a TCM radio transmitter device together with a TCM radio receiver device with preinstalled whip antenna.

These figures should be treated as a rough guide only:

- Line-of-sight connections  
Typically 30 m range in corridors, up to 100 m in halls
- Plasterboard walls / dry wood  
Typically 30 m range, through max. 5 walls
- Ferro concrete walls / ceilings  
Typically 10 m range, through max. 1 ceiling
- Fire-safety walls, elevator shafts, staircases and similar areas should be considered as shielded

The angle at which the transmitted signal hits the wall is very important. The effective wall thickness – and with it the signal attenuation – varies according to this angle. Signals should be transmitted as directly as possible through the wall. Wall niches should be avoided.

Other factors restricting transmission range include:

- Switch mounting on metal surfaces (up to 30% loss of transmission range).
- Hollow lightweight walls filled with insulating wool on metal foil.
- False ceilings with panels of metal or carbon fibre.
- Lead glass or glass with metal coating, steel furniture.

The distance between EnOcean receivers and other transmitting devices such as computers, audio and video equipment that also emit high-frequency signals should be at least 0.5 m.

A more detailed application note on how to determine the transmission range within buildings is available from: <https://www.enocean.com/support/application-notes/>

## 7 AGENCY APPROVALS

### 7.1 PTM 210 and PTM 215: Radio Approval for the European Market

The module is developed and tested according to the R&TTE EU-directive on radio equipment. The assembly conforms to the European and national requirements of electromagnetic compatibility. The conformity has been proven and the corresponding documentation has been deposited at EnOcean. The PTM devices can be operated without notification and free of charge in the area of the European Union, and in Switzerland.

From 12<sup>th</sup> of June 2016 the new European Radio Equipment Directive (RE-D) is in place. Unfortunately, necessary radio standards (e.g. EN 300 220) are still in definition and review phase, finalization is expected for Q1/2017. In order to overcome this issue a transition period till 12<sup>th</sup> of June 2017 has been defined by the European Union. During this period, products developed and tested according to R&TTE can be sold to the market.

The following provisos apply:

- EnOcean switch modules must not be modified or used outside specification limits.
- EnOcean switch modules may only be used to transfer digital sensor data
- The final product including EnOcean switch module must meet all necessary application specific requirement for CE conformity (e.g. product labelling, manual and conformity to all application specific directives and standards).

If transmitters are used according to the regulations of the 868.300 MHz SRD/ISM band, a so-called "Duty Cycle" of 1% per hour for each transmitter must not be exceeded. Permanent transmitters such as radio earphones are not allowed.

For conventional applications, it must be ensured that the PTM 215 or PTM 210 radio device is not operated more than 6000 times within one hour (one operation: energy bow is pressed and released). Within this calculation, the extraordinary short telegram length is considered including three sub-telegrams. Also a tolerance of 5% in the telegram length is included.

---

### 7.3 PTM 215U: FCC and Industry Canada Regulatory Statements

This device complies with part 15 of the FCC rules and Industry Canada ICES- 003. Operation is subject to the following two conditions: (1) This device may not cause harmful interference, and (2) this device must accept any interference received, including interference that may cause undesired operation. Any changes or modifications not expressly approved by manufacturer could void the user's authority to operate the equipment.

When the product is placed on the US / Canadian market, it must carry the Specified Radio Equipment marking as shown below:

FCC: SZV-PTM215U IC: 5713A-PTM215U
---------------------------------------

**IMPORTANT!** Any changes or modifications not expressly approved by the party responsible for compliance could void the user's authority to operate this equipment.

Le présent appareil est conforme aux CNR d'Industrie Canada applicables aux appareils radio exempts de licence. L'exploitation est autorisée aux deux conditions suivantes: (1) l'appareil ne doit pas produire de brouillage, et (2) l'utilisateur de l'appareil doit accepter tout brouillage radioélectrique subi, même si le brouillage est susceptible d'en compromettre le fonctionnement.

**IMPORTANT!** Tous les changements ou modifications pas expressément approuvés par la partie responsable de la conformité ont pu vider l'autorité de l'utilisateur pour actionner cet équipement.

#### 7.4 PTM 215J: Japanese Type Approval

PTM 215J complies with the Japanese radio law and is certified according to ARIB STD-T108 V1.0 (2012-02). There is a certification marking on the back side of the module.

When the product is placed on the Japanese market, it must carry the Specified Radio Equipment marking as shown below:

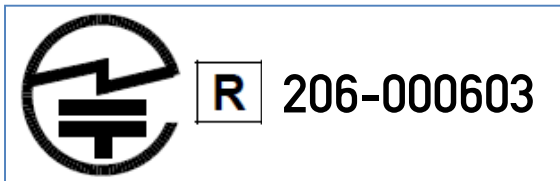

If the certification label cannot be recognized from outside (e.g. installation in a host) appropriate information must be referenced in the user manual.

Transmitting the secure teach in telegram the PTM 215J transmits a telegram with 48-bit ID as required by Japanese radio law.