

FCC/IC - TEST REPORT

Report Number : **68.950.20.0812.01** Date of Issue: **2021-01-05**

Model : **GPQY2**

FCC ID : **SZGGPQY2**

IC : **7702A-GPQY2**

Product Type : **Wireless Device**

Applicant : **Weifang Goertek Electronics Co., Ltd**

Address : **Gaoxin 2 Road, Free Trade Zone, 261205 Weifang, Shandong,**
PEOPLE'S REPUBLIC OF CHINA

Manufacturer : **Weifang Goertek Electronics Co., Ltd**

Address : **Gaoxin 2 Road, Free Trade Zone, 261205 Weifang, Shandong,**
PEOPLE'S REPUBLIC OF CHINA

Test Result : **Positive** **Negative**

Total pages including Appendices : **36**

TÜV SÜD Certification and Testing (China) Co., Ltd. Shenzhen Branch is a subcontractor to TÜV SÜD Product Service GmbH according to the principles outlined in ISO 17025.

TÜV SÜD Certification and Testing (China) Co., Ltd. Shenzhen Branch reports apply only to the specific samples tested under stated test conditions. Construction of the actual test samples has been documented. It is the manufacturer's responsibility to assure that additional production units of this model are manufactured with identical electrical and mechanical components. The manufacturer/importer is responsible to the Competent Authorities in Europe for any modifications made to the production units which result in non-compliance to the relevant regulations. TÜV SÜD Certification and Testing (China) Co., Ltd. Shenzhen Branch shall have no liability for any deductions, inferences or generalizations drawn by the client or others from TÜV SÜD Certification and Testing (China) Co., Ltd. Shenzhen Branch issued reports.

This report is the confidential property of the client. As a mutual protection to our clients, the public and ourselves, extracts from the test report shall not be reproduced except in full without our written approval.



1 Table of Contents

- 1 Table of Contents.....2
- 2 Details about the Test Laboratory3
- 3 Description of the Equipment under Test.....4
- 4 Summary of Test Standards5
- 5 Summary of Test Results.....6
- 6 General Remarks.....7
- 7 Test Setups8
- 8 Systems test configuration9
- 9 Technical Requirement.....10
 - 9.1 Conducted peak output power.....10
 - 9.2 6dB bandwidth12
 - 9.3 99% bandwidth14
 - 9.4 Power spectral density16
 - 9.5 Spurious RF conducted emissions.....18
 - 9.6 Band edge.....23
 - 9.7 Spurious radiated emissions for transmitter25
- 10 Test Equipment List.....35
- 11 System Measurement Uncertainty36

2 Details about the Test Laboratory

Details about the Test Laboratory

Test Site 1

Company name: TÜV SÜD Certification and Testing (China) Co., Ltd. Shenzhen Branch
 Building 12&13, Zhiheng Wisdomland Business Park,
 Nantou Checkpoint Road 2, Nanshan District,
 Shenzhen City, 518052,
 P. R. China

FCC Designation Number: CN5009

FCC Registration No.: 514049

IC Registration Number: 10320A

Telephone: 86 755 8828 6998
 Fax: 86 755 8828 5299

Report Version:

Revision	Release Date	History/Memo.
N/A	2021-01-05	Initial Release

3 Description of the Equipment under Test

Product:	Wireless Device
Model no.:	GPQY2
FCC ID:	SZGGPQY2
IC:	7702A-GPQY2
PMN:	GPQY2
HVIN:	GPQY2
Rating:	3.7V
RF Transmission Frequency:	2402MHz-2480MHz
No. of Operated Channel:	40
Modulation:	GFSK
Antenna Type:	Monopole
Antenna Gain:	-5.5dBi max for 2.4GHz
Description of the EUT:	The Equipment Under Test (EUT) is a Wireless Device with Bluetooth Low Energy/Bluetooth BDR+EDR functions.

4 Summary of Test Standards

Test Standards	
FCC Part 15 Subpart C 10-1-2019 Edition	PART 15 - RADIO FREQUENCY DEVICES Subpart C - Intentional Radiators
RSS-Gen Issue 5, Amendment 1, March 2019	General Requirements for the Certification of Radio Apparatus
RSS-247 Issue 2 February 2017	Digital Transmission Systems (DTSS), Frequency Hopping Systems (FHSS) and License-Exempt Local Area Network (LE-LAN) Devices

All the test methods were according to KDB558074 D01 v05r02 DTS Measurement Guidance and ANSI C63.10 (2013).

5 Summary of Test Results

Technical Requirements				
FCC Part 15 Subpart C/ RSS-247 Issue 2/RSS-Gen Issue 5				
Test Condition			Test Site	Test Result
§15.207	RSS-GEN 8.8	Conducted emission AC power port	--	N/A
§15.247 (b) (1)	RSS-247 Clause 5.4(d)	Conducted peak output power	Site 1	PASS
§15.247(a)(1)	RSS-247 Clause 5.1 (b)	20dB bandwidth	---	N/A
§15.247(a)(1)	RSS-247 Clause 5.1(b)	Carrier frequency separation	---	N/A
§15.247(a)(1)(iii)	RSS-247 Clause 5.1(d)	Number of hopping frequencies	---	N/A
§15.247(a)(1)(iii)	RSS-247 Clause 5.1(d)	Dwell Time	---	N/A
§15.247(a)(2)	RSS-247 Clause 5.2(a) & RSS-GEN 6.7	6dB bandwidth and 99% Occupied Bandwidth	Site 1	PASS
§15.247(e)	RSS-247 Clause 5.2(b)	Power spectral density	Site 1	PASS
§15.247(d)	RSS-247 Clause 5.5	Spurious RF conducted emissions	Site 1	PASS
§15.247(d)	RSS-247 Clause 5.5	Band edge	Site 1	PASS
§15.247(d) & §15.209 & §15.205	RSS-247 Clause 5.5 & RSS-GEN 6.13	Spurious radiated emissions for transmitter	Site 1	PASS
§15.203	RSS-GEN 6.8	Antenna requirement	See note 2	PASS

Remark:

Note 1: N/A=Not Applicable.

Note 2: The EUT uses a monopole antenna, which gain is -5.5dBi. In accordance to §15.203 and RSS-GEN 6.8, it is considered sufficiently to comply with the provisions of this section.



6 General Remarks

Remarks

This submittal(s) (test report) is intended for FCC ID: SZGGPQY2, IC: 7702A-GPQY2, complies with Section 15.205, 15.209, 15.247 of the FCC Part 15, Subpart C and RSS-247 issue 2 and RSS-Gen issue 5 rules.

The Equipment Under Test (EUT) is a Wireless Device with Bluetooth Low Energy/Bluetooth BDR+EDR functions.

This report is for the Bluetooth Low Energy part.

SUMMARY:

All tests according to the regulations cited on page 5 were

■ - Performed

□ - **Not** Performed

The Equipment under Test

■ - **Fulfills** the general approval requirements.

□ - **Does not** fulfill the general approval requirements.

Sample Received Date: 2020-12-16

Testing Start Date: 2020-12-16

Testing End Date: 2021-01-05

- TÜV SÜD Certification and Testing (China) Co., Ltd. Shenzhen Branch –

Reviewed by:

Prepared by:

Tested by:



John Zhi
Project Manager

Joe Gu
Project Engineer

Tree Zhan
Test Engineer

7 Test Setups

7.1 Radiated test setups

Below 1GHz

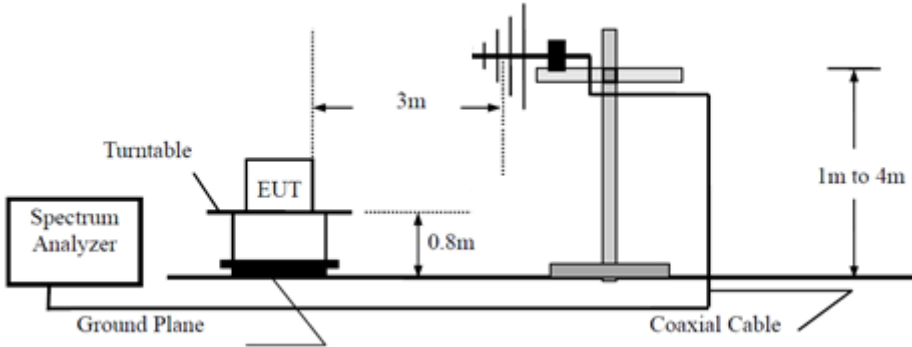

Above 1GHz

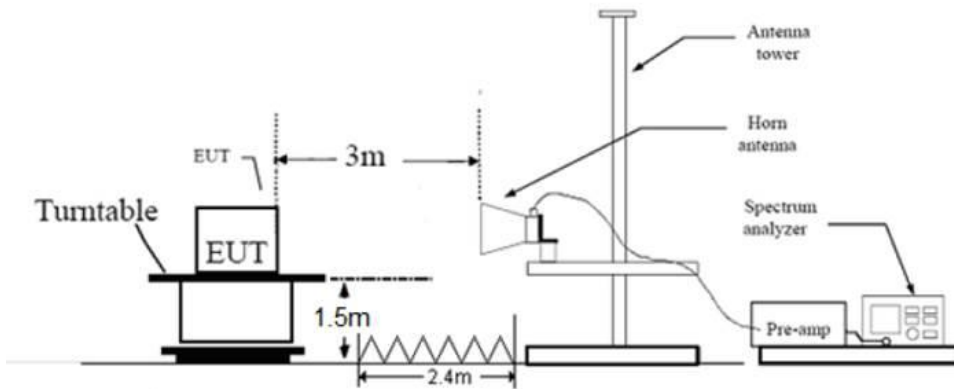

7.2 Conducted RF test setups

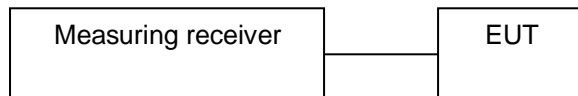

8 Systems test configuration

Auxiliary Equipment Used during Test:

Name	Model	Manufacturer	S/N	Cal Due Date
Notebook	X220	Lenovo	--	--

The system was configured to channel 0, 19, and 39 for the test.

9 Technical Requirement

9.1 Conducted peak output power

Test Method

1. The EUT was placed on 0.8m height table, the RF output of EUT was connected to the test receiver by RF cable. The path loss was compensated to the results for each measurement.
2. Use the following spectrum analyzer settings:
RBW > the 6dB bandwidth of the emission being measured, VBW \geq 3RBW, Span \geq 3RBW
Sweep = auto, Detector function = peak, Trace = max hold.
3. Allow the trace to stabilize. Use the marker-to-peak function to set the marker to the peak of the emission. The indicated level is the peak output power.

Limits:

Conducted peak output power:

Frequency Range MHz	Limit W	Limit dBm
2400-2483.5	≤ 1	≤ 30

For e.i.r.p:

Frequency Range MHz	Limit W	Limit dBm
2400-2483.5	≤ 4	≤ 36

Test result as below table

Frequency (MHz)	Conducted Peak Output Power (dBm)	Antenna Gain (dBi)	EIRP (dBm)	Result
Low channel 2402MHz	11.09	-5.5	5.59	Pass
Middle channel 2440MHz	11.22	-5.5	5.72	Pass
High channel 2480MHz	10.95	-5.5	5.45	Pass

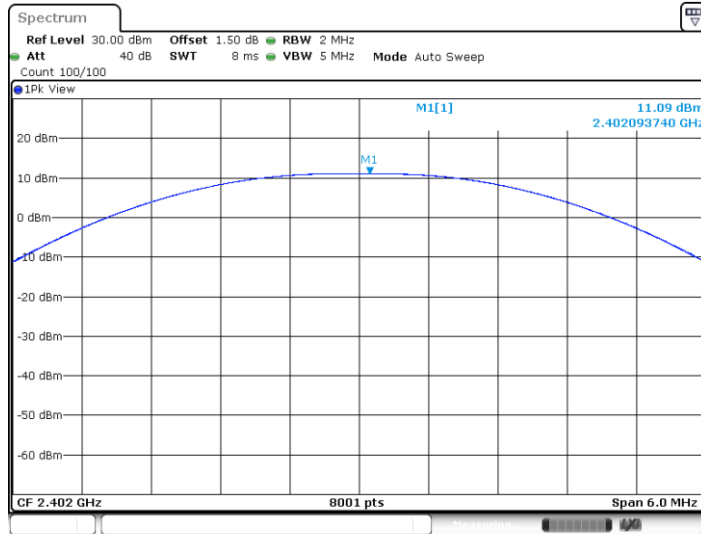

2402MHz

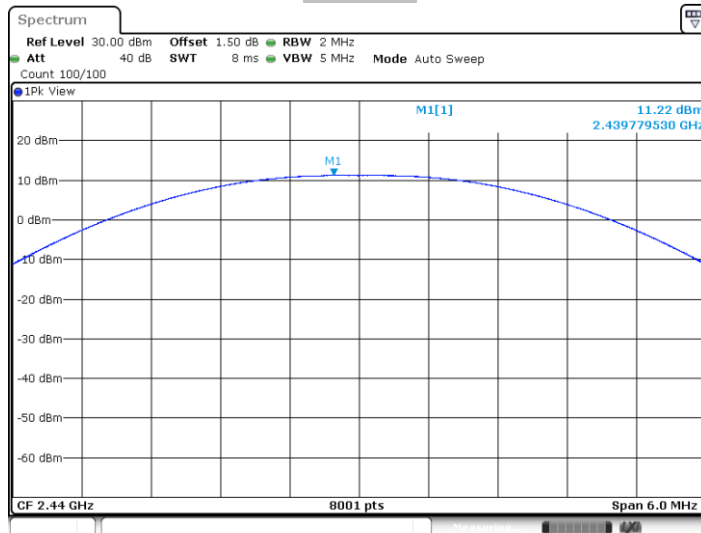

2440MHz

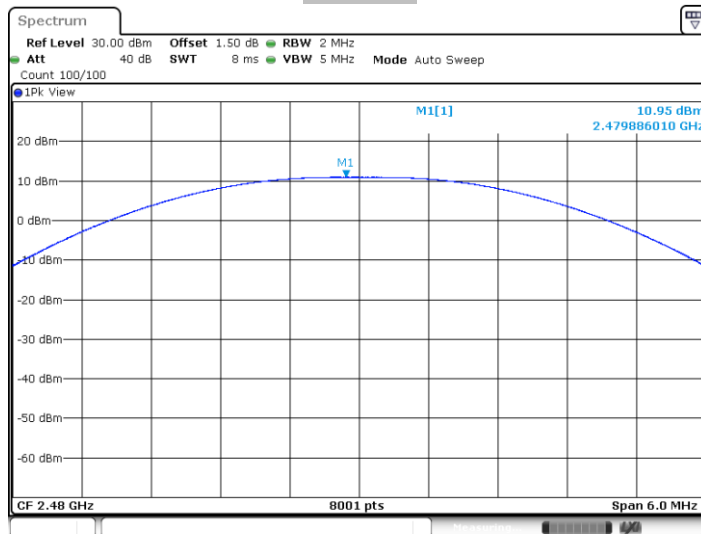

2480MHz

9.2 6dB bandwidth

Test Method

1. Connect EUT test port to spectrum analyzer.
2. Use the following spectrum analyzer settings:
RBW=100K, VBW≥3RBW, Sweep = auto, Detector function = peak, Trace = max hold
3. Use the automatic bandwidth measurement capability of an instrument, may be employed using the X dB bandwidth mode with X set to 6 dB, care shall be taken so that the bandwidth measurement is not influenced by any intermediate power nulls in the fundamental emission that might be ≥ 6 dB.
4. Allow the trace to stabilize, record the X dB Bandwidth value.

Limit

Limit [kHz]

≥500

Test result

Channel (MHz)	Result (MHz)	Limit (kHz)	Verdict
2402	0.712	≥500	PASS
2440	0.716	≥500	PASS
2480	0.716	≥500	PASS

Test Graphs

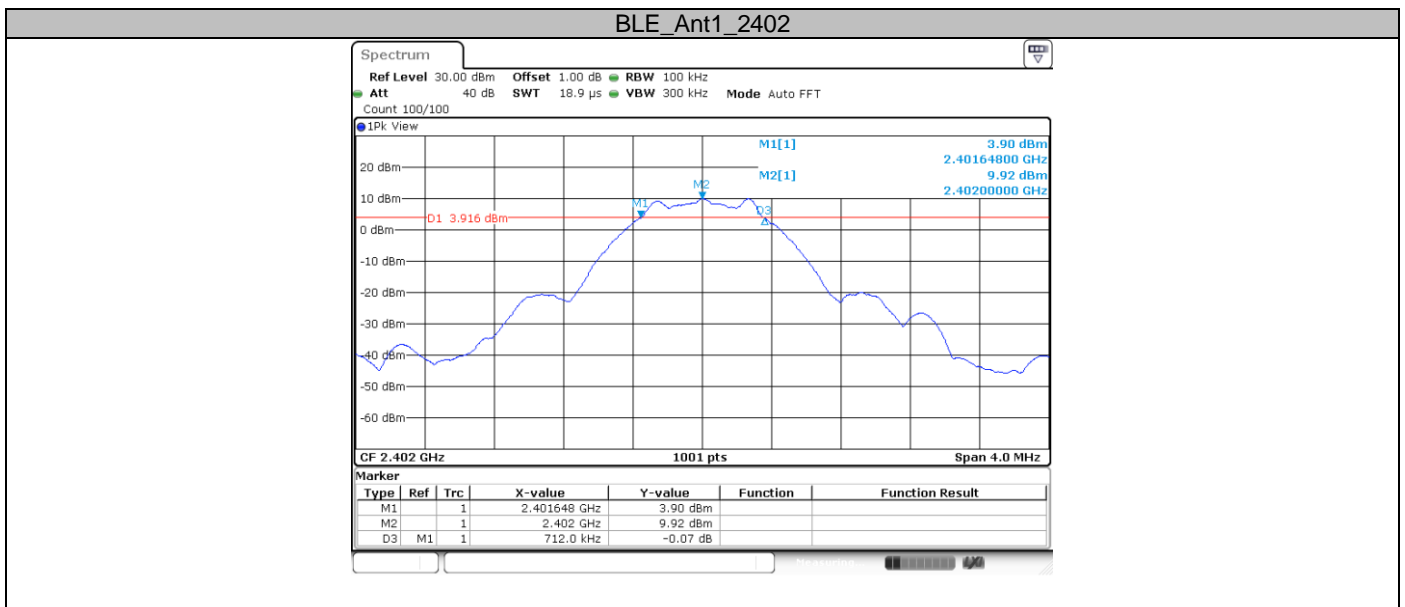

BLE_Ant1_2440

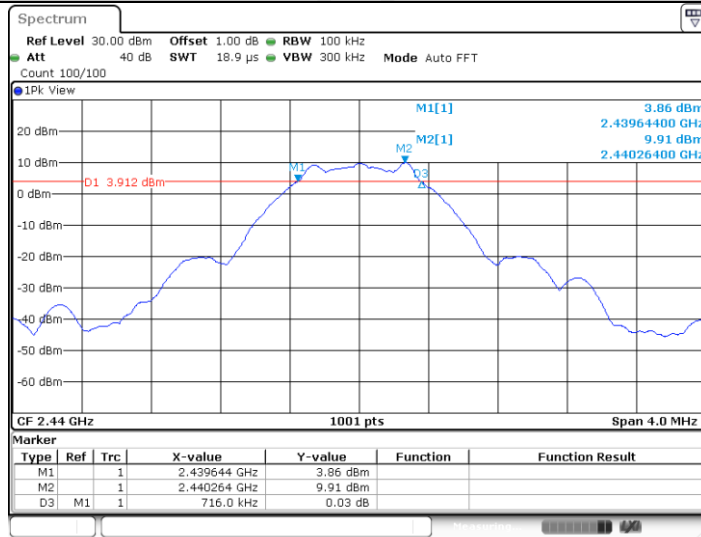

BLE_Ant1_2480

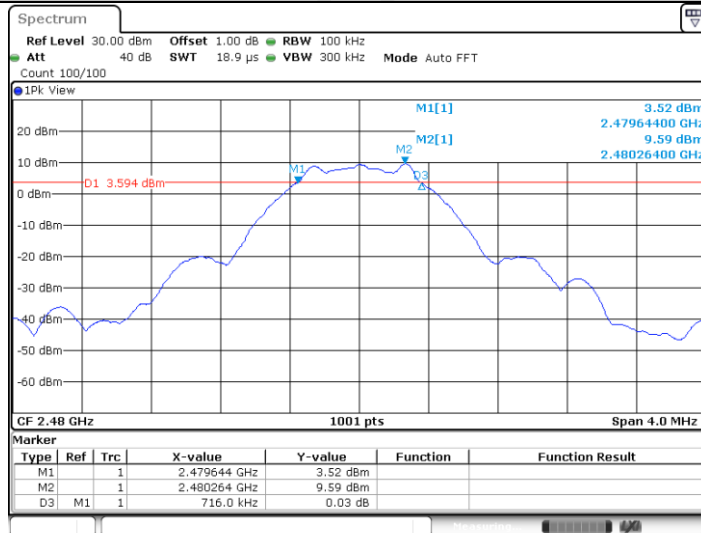

9.3 99% bandwidth

Test Method

1. Connect EUT test port to spectrum analyzer.
2. Use the following spectrum analyzer settings:
 RBW=1% to 5% of the actual occupied, VBW≥3RBW, Sweep = auto,
 Detector function = peak, Trace = max hold
3. Use the automatic bandwidth measurement capability of an instrument, care shall be taken so that the bandwidth measurement is not influenced by any intermediate power nulls in the fundamental emission that might be ≥ 6 dB.
4. Allow the trace to stabilize, record the X dB Bandwidth value.

Limit

Limit [kHz]

--

Test result

Channel (MHz)	Result (MHz)	Limit	Verdict
2402	1.027	---	PASS
2440	1.031	---	PASS
2480	1.031	---	PASS

Test Graphs

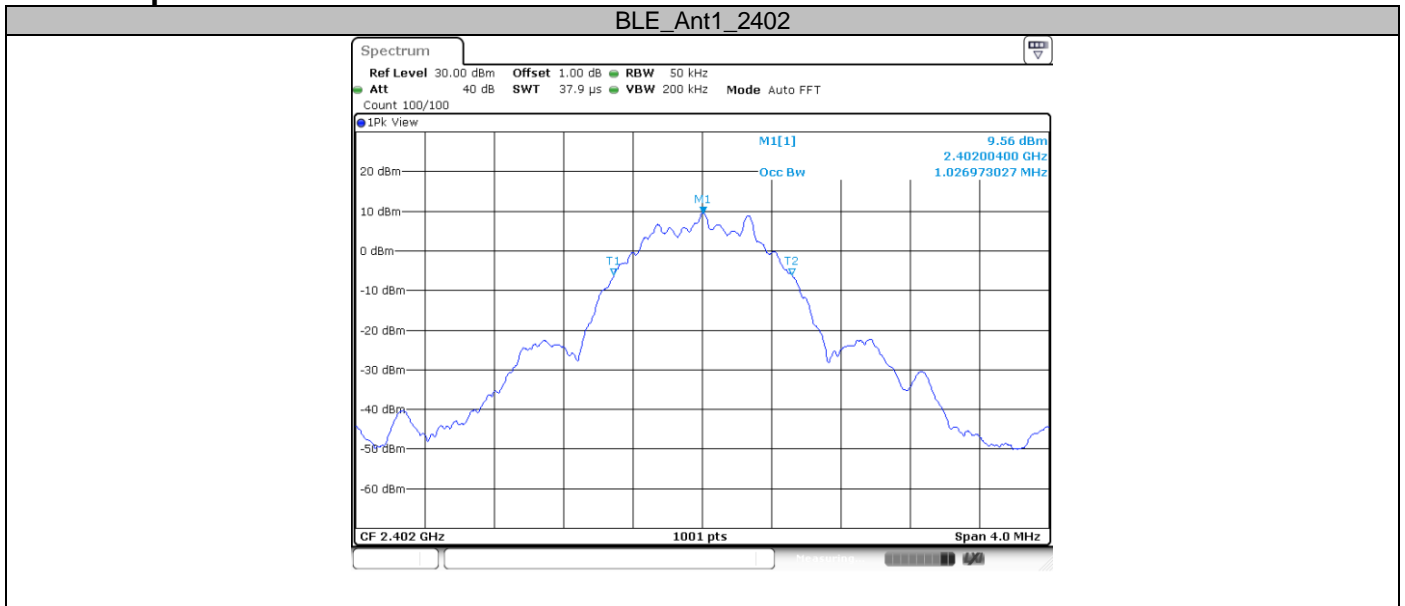

BLE_Ant1_2440

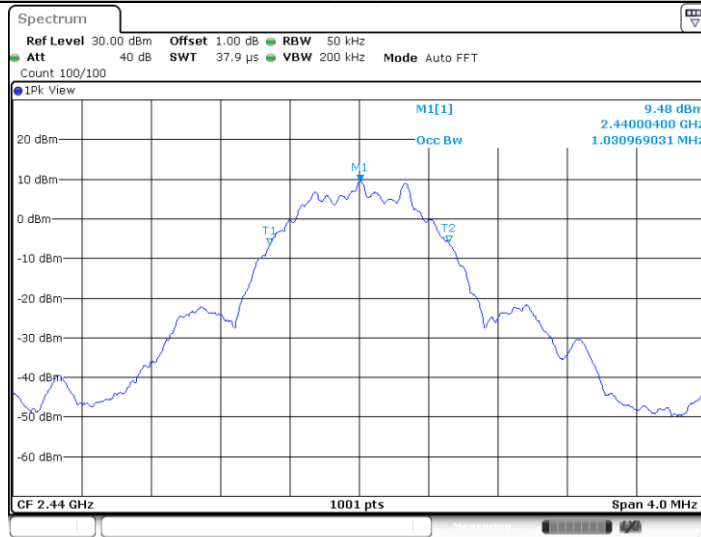

BLE_Ant1_2480

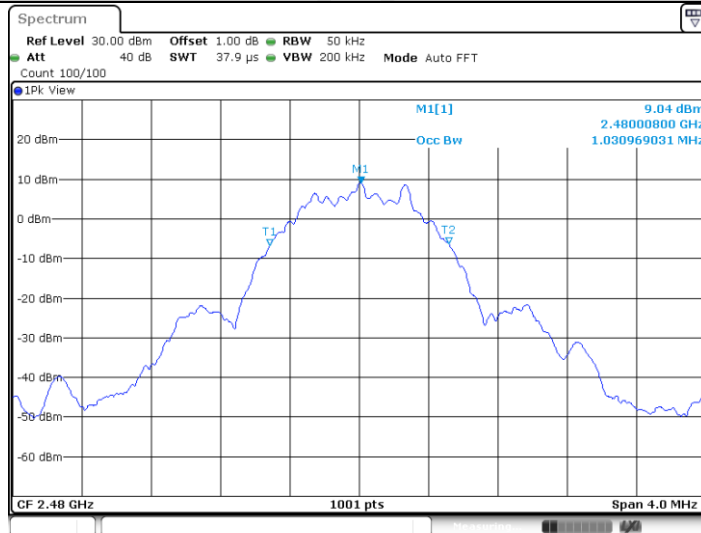

9.4 Power spectral density

Test Method

This procedure shall be used if maximum peak conducted output power was used to demonstrate compliance:

1. The RF output of EUT was connected to the test receiver by RF cable. The path loss was compensated to the results for each measurement.
2. Set analyzer center frequency to DTS channel center frequency. RBW=10kHz, VBW≥3RBW, Span=1.5 times DTS bandwidth, Detector=Peak, Sweep=auto, Trace= max hold.
3. Allow trace to fully stabilize, use the peak marker function to determine the maximum amplitude level within the RBW.
4. Repeat above procedures until other frequencies measured were completed.

Limit

Limit [dBm/3KHz]

≤8

Test result

Channel (MHz)	Result (dBm/3KHz)	Limit(dBm/3KHz)	Verdict
2402	-5.66	8	PASS
2440	-5.71	8	PASS
2480	-6.00	8	PASS

Test Graphs

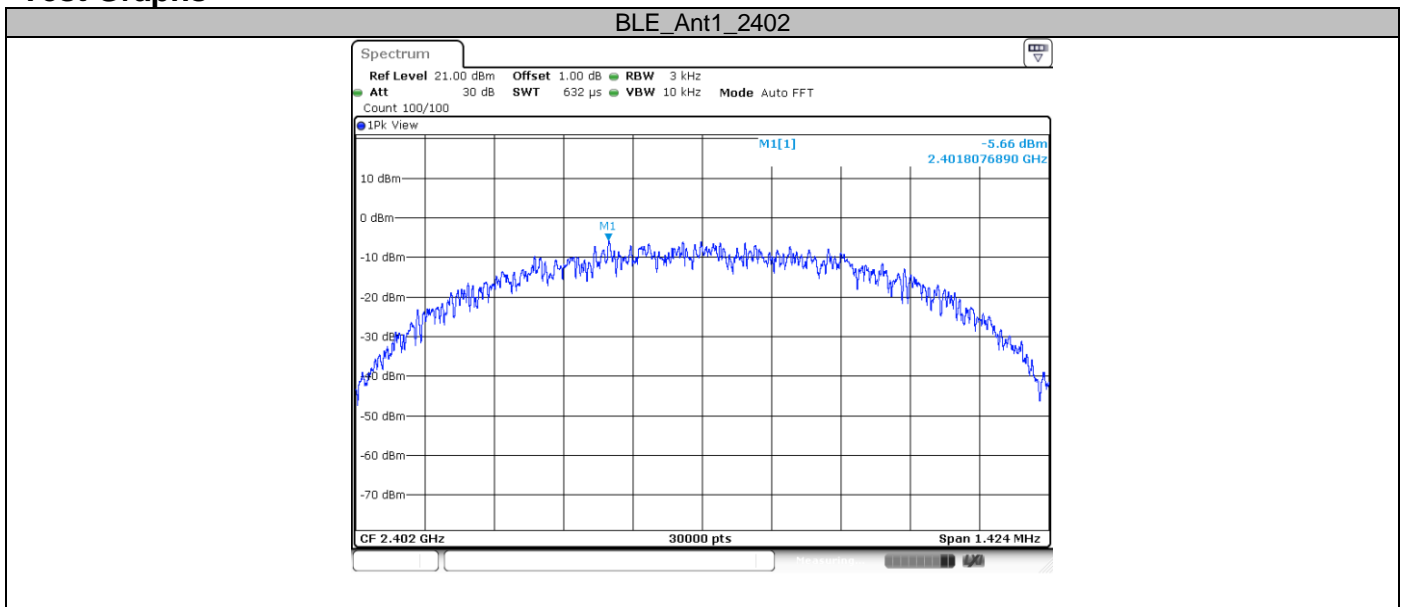

BLE_Ant1_2440

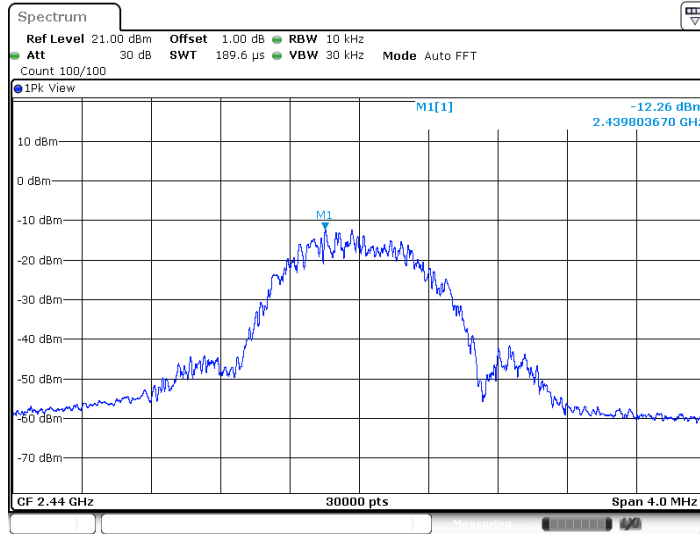

BLE_Ant1_2480

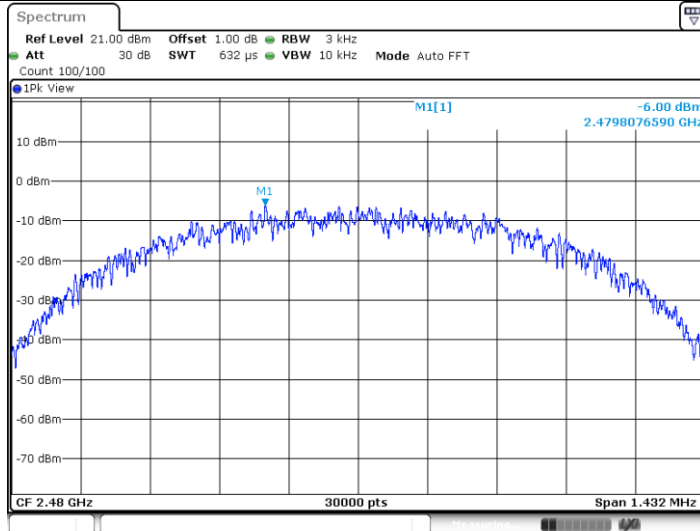

9.5 Spurious RF conducted emissions

Test Method

1. The RF output of EUT was connected to the spectrum analyzer by RF cable. The path loss was compensated to the results for each measurement.
2. Use the following spectrum analyzer settings:
Span = wide enough to capture the peak level of the in-band emission and all spurious emissions (e.g., harmonics) from the lowest frequency generated in the EUT up through the 10th harmonic. Typically, several plots are required to cover this entire span.
RBW = 100 kHz, VBW ≥ RBW, Sweep = auto, Detector function = peak, Trace = max hold
3. Allow the trace to stabilize. Set the marker on the peak of any spurious emission recorded.
4. The level displayed must comply with the limit specified in this Section. Submit these plots.
5. Repeat above procedures until all frequencies measured were complete.

Limit

Frequency Range MHz	Limit (dBc)
30-25000	-20

Test Result

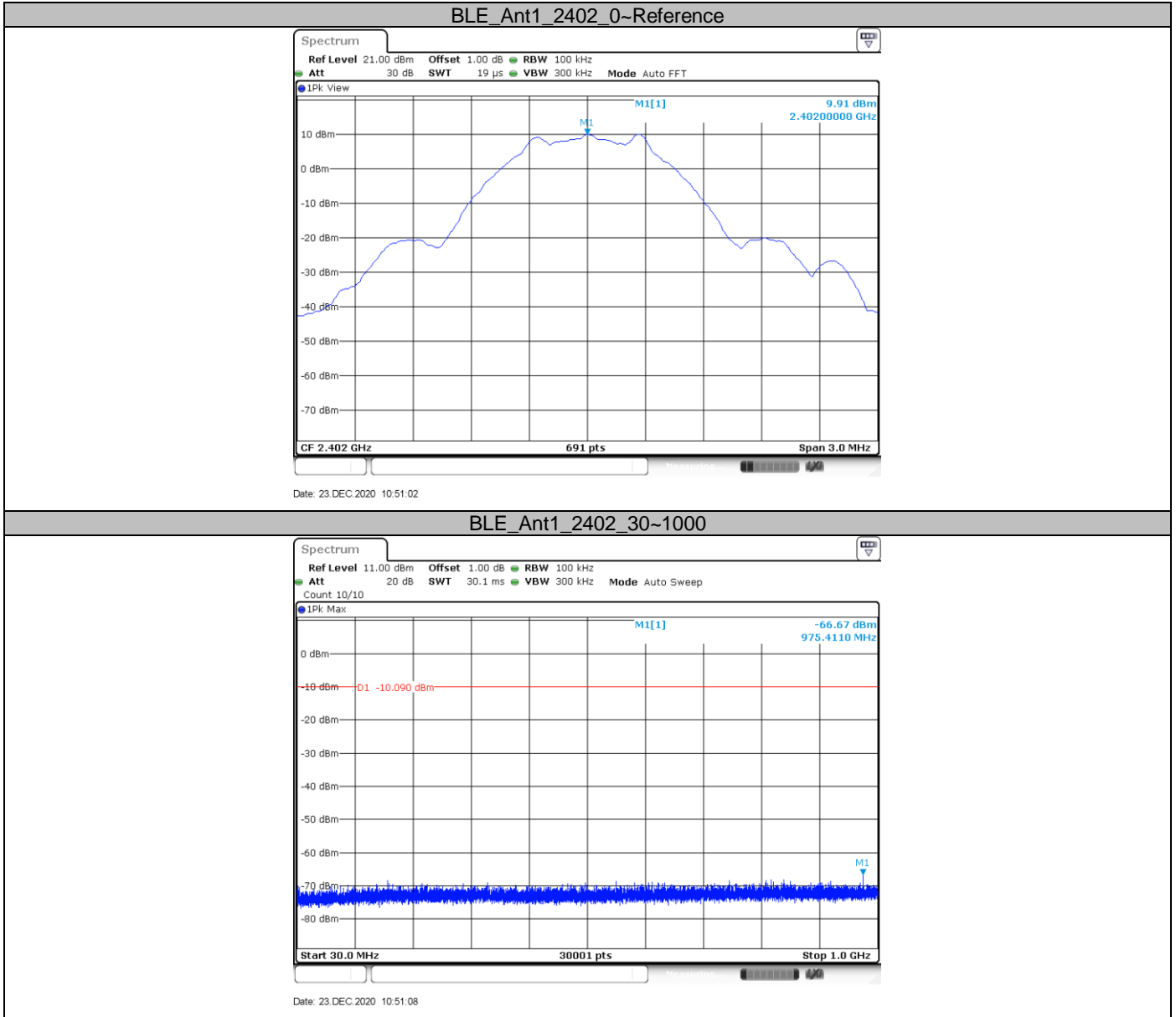

BLE_Ant1_2402_1000~26500

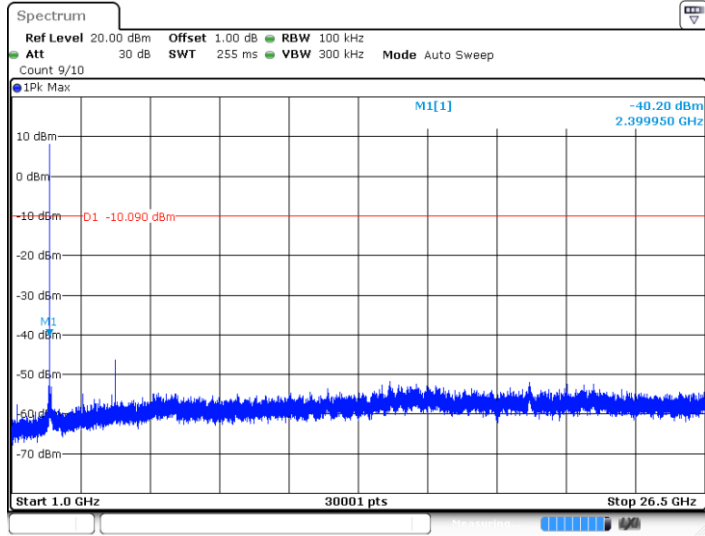

Date: 23 DEC 2020 10:51:16

BLE_Ant1_2440_0~Reference

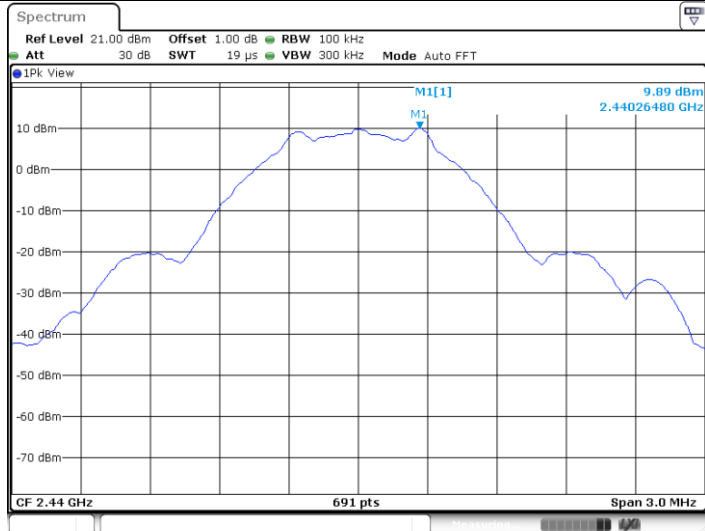

Date: 23 DEC 2020 10:52:49

BLE_Ant1_2440_30~1000

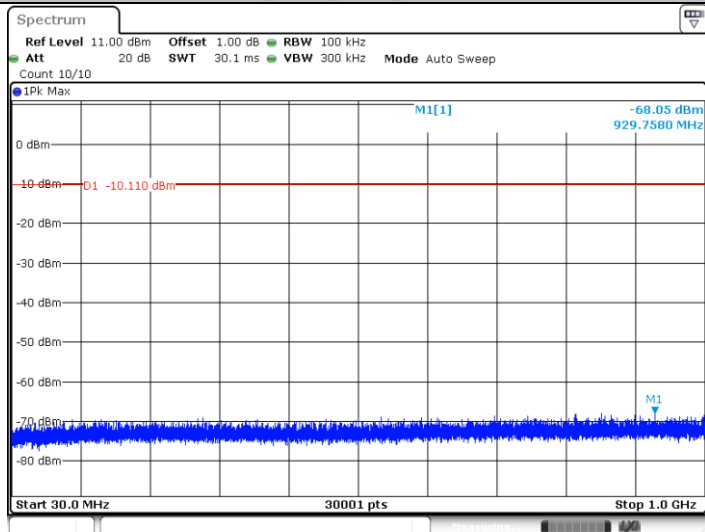

Date: 23 DEC 2020 10:52:55

BLE_Ant1_2440_1000~26500

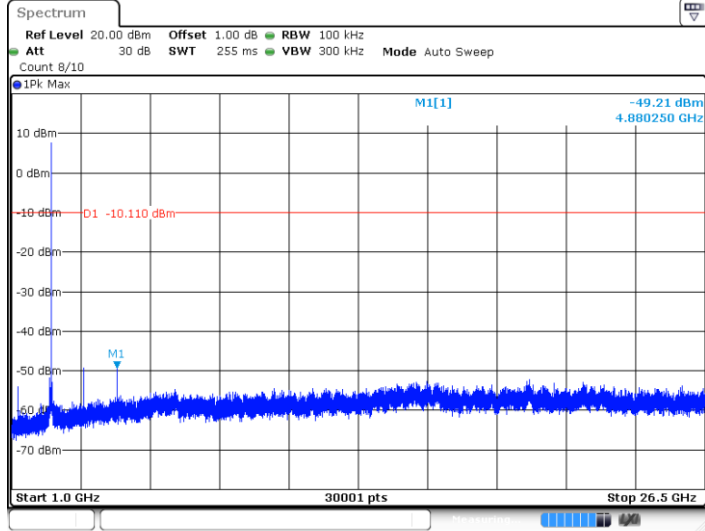

Date: 23 DEC 2020 10:53:03

BLE_Ant1_2480_0-Reference

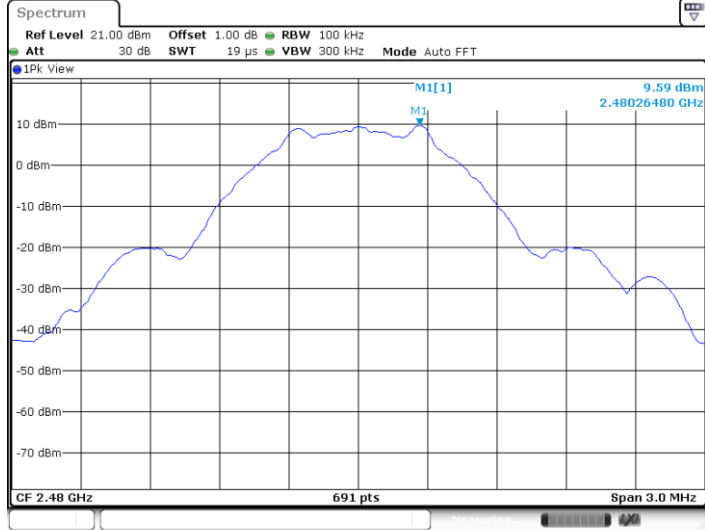

Date: 23 DEC 2020 10:56:04

BLE_Ant1_2480_30~1000

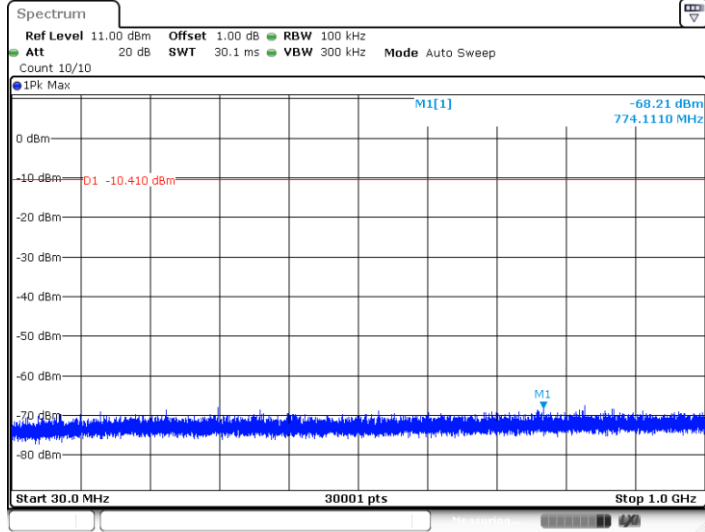

Date: 23 DEC 2020 10:56:10

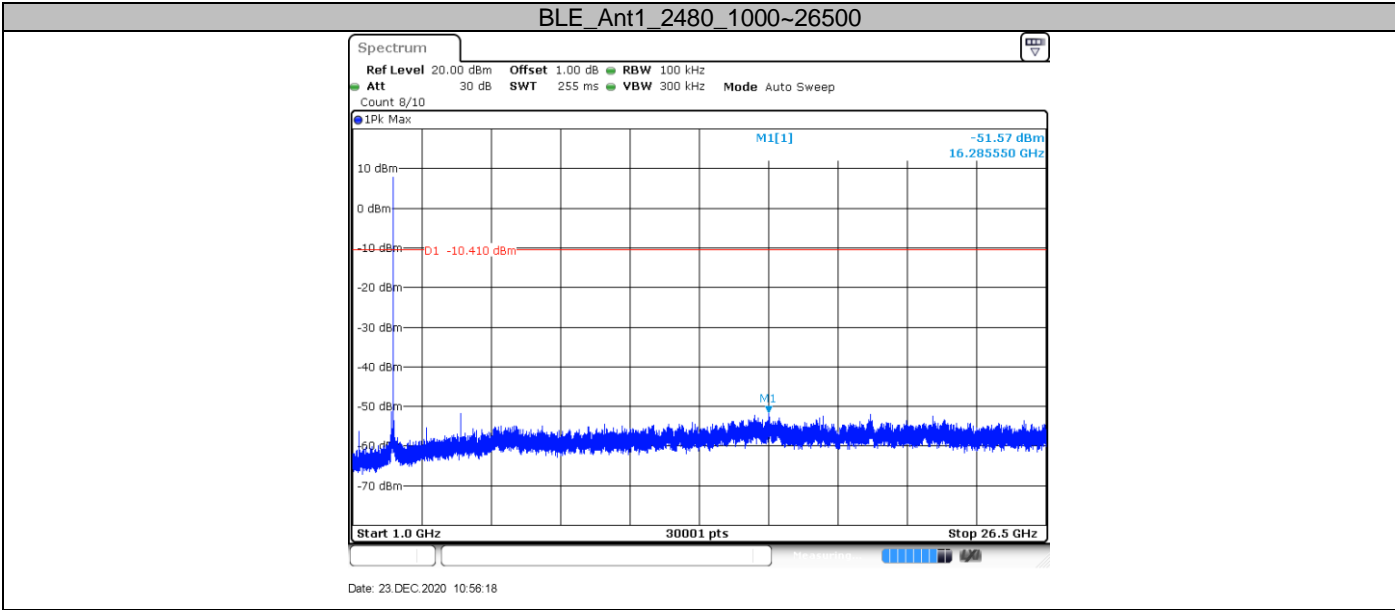

9.6 Band edge

Test Method

1. The RF output of EUT was connected to the spectrum analyzer by RF cable. The path loss was compensated to the results for each measurement.
2. Use the following spectrum analyzer settings:
Span = wide enough to capture the peak level of the in-band emission and all spurious
RBW = 100 kHz, VBW ≥ RBW, Sweep = auto, Detector function = peak, Trace = max hold
3. Allow the trace to stabilize, use the peak and delta measurement to record the result.
4. The level displayed must comply with the limit specified in this Section.
5. Repeat the test at the hopping off and hopping on mode, submit all the plots.

Limit:

Frequency Range MHz	Limit (dBc)
30-25000	-20

Test result

BLE_Ant1_Low_2402

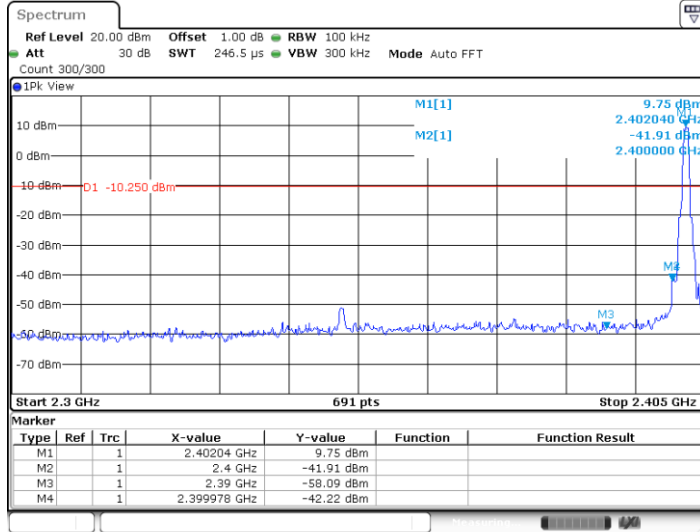

Date: 23 DEC 2020 10:50:56

BLE_Ant1_High_2480

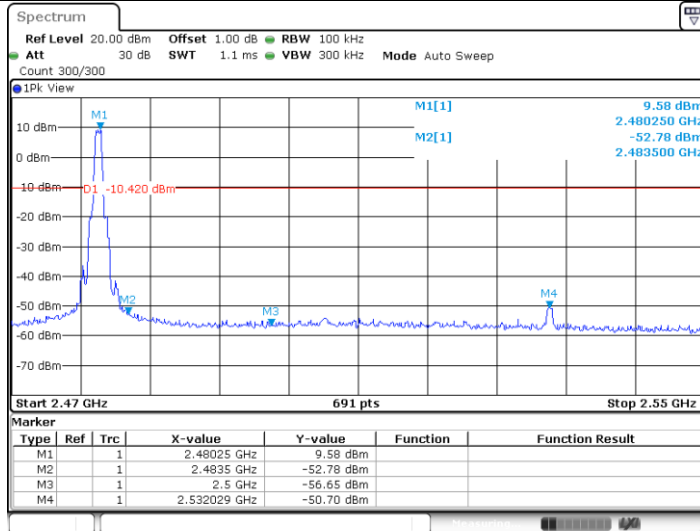

Date: 23 DEC 2020 10:55:59

9.7 Spurious radiated emissions for transmitter

Test Method

- 1: The EUT was placed on a turn table which is 1.5m above ground plane for above 1GHz and 0.8m above ground for below 1GHz at 3 meter chamber room for test. The table was rotated 360 degrees to determine the position of the highest radiation.
- 2: The EUT was set 3 meters away from the interference – receiving antenna, which was mounted on the top of a variable – height antenna tower.
- 3: The height of antenna is varied from one meter to four meters above the ground to determine the maximum value of the field strength. Both horizontal and vertical polarizations of the antenna are set to make the measurement.
- 4: For each suspected emission, the EUT was arranged to its worst case and then the antenna was tuned to heights from 1 meter to 4 meters and the rotatable table was turned from 0 degrees to 360 degrees to find the maximum reading.
- 5: Use the following spectrum analyzer settings According to C63.10:

For Below 1GHz

Use the following spectrum analyzer settings:

Span = wide enough to capture the peak level of the in-band emission and all spurious
 RBW = 100 KHz to 120KHz, VBW ≥ RBW for peak measurement, Sweep = auto, Detector function = peak, Trace = max hold.

For Peak unwanted emissions Above 1GHz:

Span = wide enough to capture the peak level of the in-band emission and all spurious
 RBW = 1MHz, VBW ≥ RBW for peak measurement, Sweep = auto, Detector function = peak, Trace = max hold.

Procedures for average unwanted emissions measurements above 1000 MHz

a) RBW = 1MHz.

b) VBW \ [3 × RBW].

c) Detector = RMS (power averaging), if [span / (# of points in sweep)] \ RBW / 2.

Satisfying this condition can require increasing the number of points in the sweep or reducing the span. If the condition is not satisfied, then the detector mode shall be set to peak.

d) Averaging type = power (i.e., rms) (As an alternative, the detector and averaging type may be set for linear voltage averaging. Some instruments require linear display mode to use linear voltage averaging. Log or dB averaging shall not be used.)

e) Sweep time = auto.

f) Perform a trace average of at least 100 traces if the transmission is continuous. If the transmission is not continuous, then the number of traces shall be increased by a factor of 1 / D, where D is the duty cycle. For example, with 50% duty cycle, at least 200 traces shall be averaged. (If a specific emission is demonstrated to be continuous—i.e., 100% duty cycle—then rather than turning ON and OFF with the transmit cycle, at least 100 traces shall be averaged.)

g) If tests are performed with the EUT transmitting at a duty cycle less than 98%, then a correction factor shall be added to the measurement results prior to comparing with the emission limit, to compute the emission level that would have been measured had the test been performed at 100% duty cycle. The correction factor is computed as follows:

1) If power averaging (rms) mode was used in the preceding step e), then the correction factor is $[10 \log (1 / D)]$, where D is the duty cycle. For example, if the transmit duty

cycle was 50%, then 3 dB shall be added to the measured emission levels.

2) If linear voltage averaging mode was used in the preceding step e), then the correction factor is $[20 \log (1 / D)]$, where D is the duty cycle. For example, if the transmit duty cycle was 50%, then 6 dB shall be added to the measured emission levels.

3) If a specific emission is demonstrated to be continuous (100% duty cycle) rather than turning ON and OFF with the transmit cycle, then no duty cycle correction is required for that emission (AV) at frequency above 1GHz.

Limit

The radio emission outside the operating frequency band shall be at least 20 dB below that in the 100 kHz bandwidth within the band that contains the highest level of the desired power. Radiated emissions which fall in the restricted bands, as defined in section 15.205, RSS-GEN 8.10, must comply with the radiated emission limits specified in section 15.209, section RSS-247.

Frequency MHz	Field Strength $\mu\text{V/m}$	Field Strength $\text{dB}\mu\text{V/m}$	Detector
30-88	100	40	QP
88-216	150	43.5	QP
216-960	200	46	QP
960-1000	500	54	QP
Above 1000	500	54	AV
Above 1000	5000	74	PK

Spurious radiated emissions for transmitter

According to C63.10, if the peak (or quasi-peak) measured value complies with the average limit, it is unnecessary to perform an average measurement, so AV emission value did not show in below table if the peak value complies with average limit.

Transmitting spurious emission test result as below:

Below 1G:

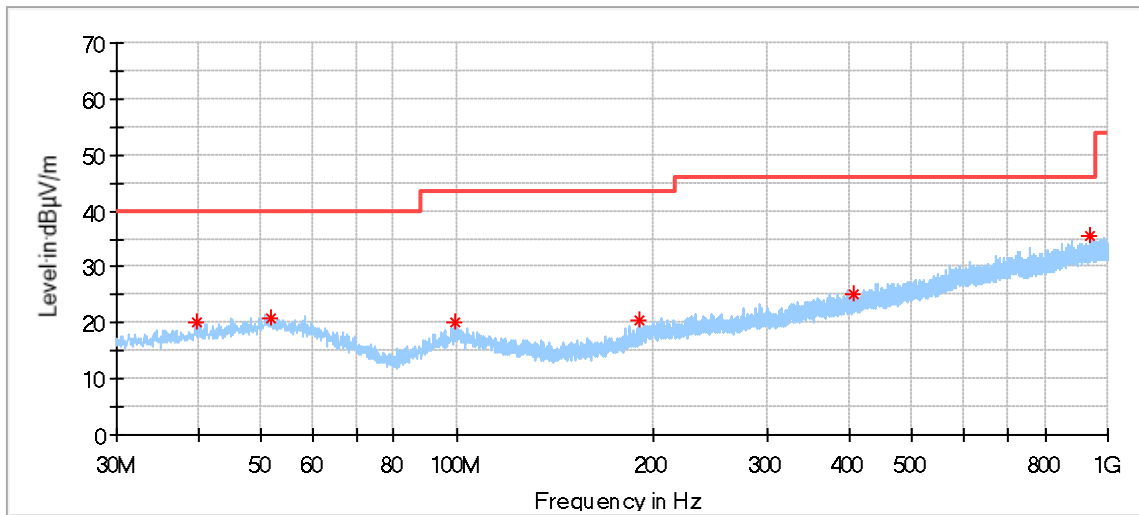

Frequency (MHz)	MaxPeak (dBµV/m)	Limit (dBµV/m)	Margin (dB)	Height (cm)	Pol	Azimuth (deg)	Corr. (dB/m)
39.700000	20.14	40.00	19.86	100.0	H	89.0	13.44
51.717222	20.73	40.00	19.27	200.0	H	341.0	15.04
99.408889	20.18	43.50	23.32	100.0	H	192.0	12.70
190.050000	20.59	43.50	22.91	200.0	H	160.0	11.75
406.467778	25.08	46.00	20.92	100.0	H	11.0	17.50
938.943889	35.56	46.00	10.44	100.0	H	74.0	25.44

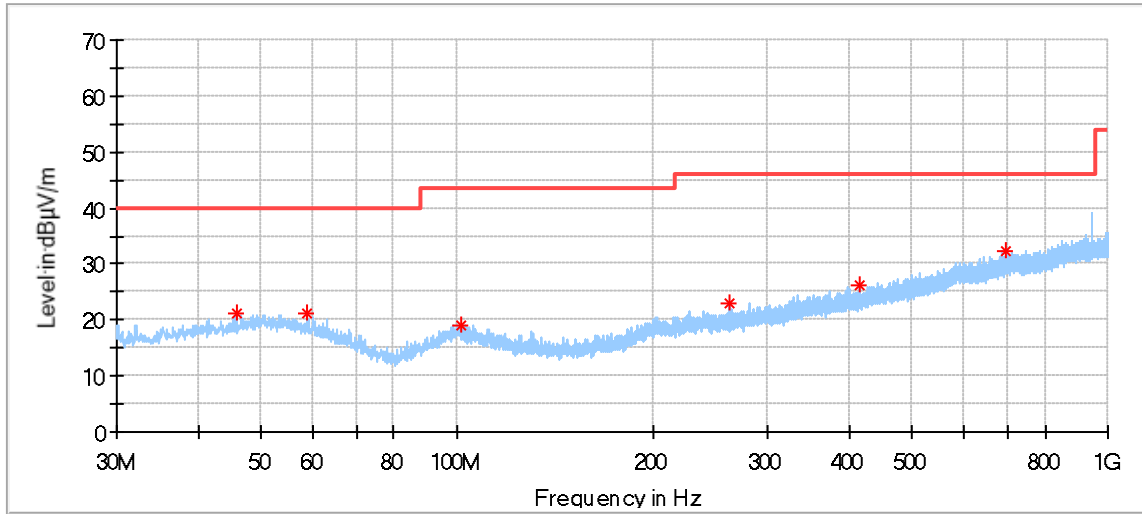

Frequency (MHz)	MaxPeak (dBµV/m)	Limit (dBµV/m)	Margin (dB)	Height (cm)	Pol	Azimuth (deg)	Corr. (dB/m)
45.735556	21.26	40.00	18.74	100.0	V	147.0	14.58
58.884444	21.11	40.00	18.89	100.0	V	234.0	14.16
101.133333	19.06	43.50	24.44	100.0	V	202.0	12.67
262.746111	23.05	46.00	22.95	100.0	V	257.0	13.93
415.628889	26.34	46.00	19.66	200.0	V	349.0	17.71
695.851111	32.26	46.00	13.74	100.0	V	210.0	22.35

Low channel 2402MHz

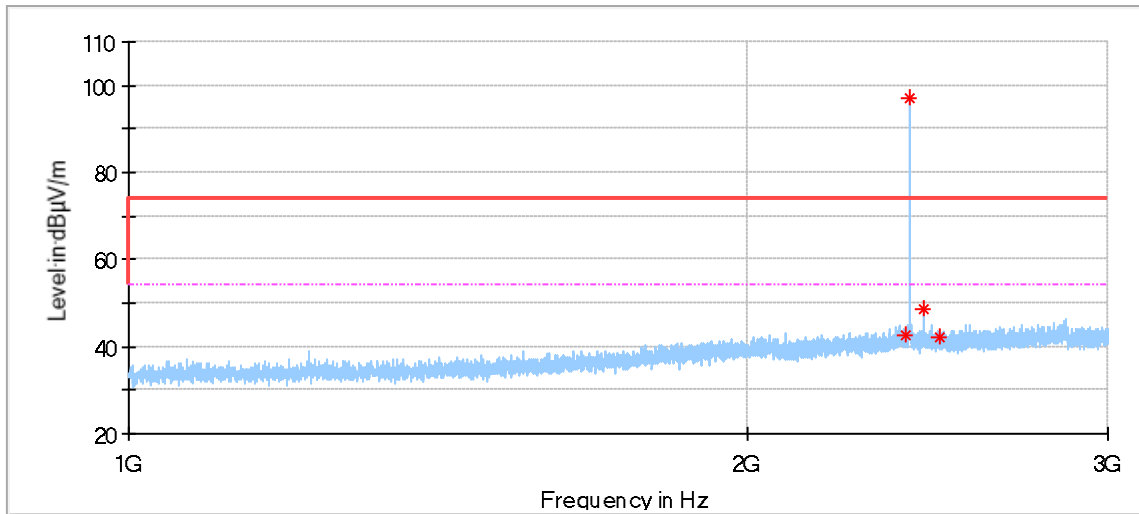

Frequency (MHz)	MaxPeak (dBµV/m)	Limit (dBµV/m)	Margin (dB)	Height (cm)	Pol	Azimuth (deg)	Corr. (dB/m)
2390.000000	42.50	74.00	31.50	150.0	H	149.0	-3.90
2402.400000	97.20	74.00	-23.20	150.0	H	91.0	-3.94
2440.200000	48.62	74.00	25.38	150.0	H	29.0	-3.86
2483.600000	41.95	74.00	32.05	150.0	H	63.0	-3.70

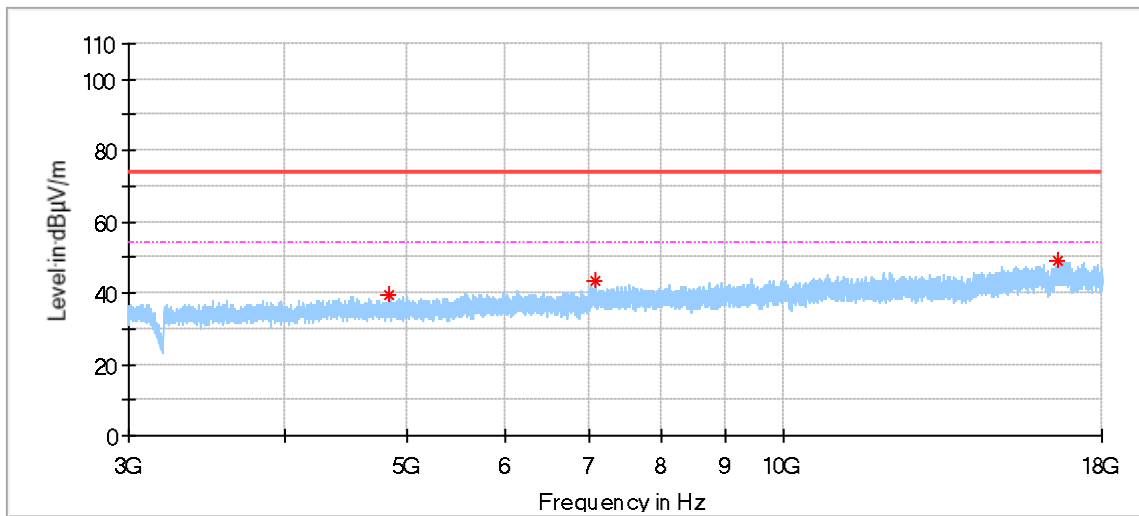

Frequency (MHz)	MaxPeak (dBµV/m)	Limit (dBµV/m)	Margin (dB)	Height (cm)	Pol	Azimuth (deg)	Corr. (dB/m)
4844.000000	39.52	74.00	34.48	150.0	H	175.0	1.12
7072.500000	43.25	74.00	30.75	150.0	H	259.0	4.89
16608.500000	49.20	74.00	24.80	150.0	H	110.0	15.77

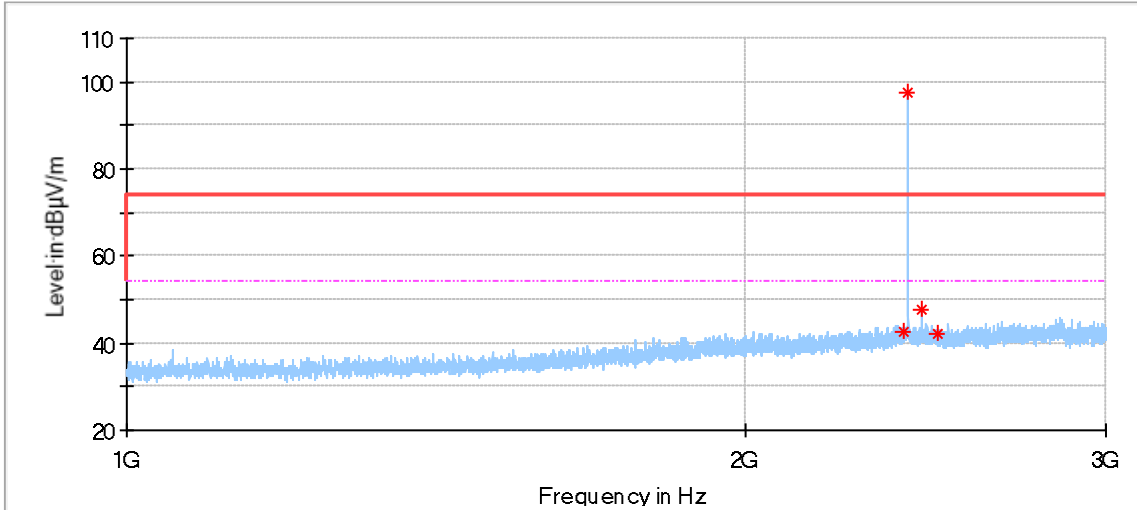

Frequency (MHz)	MaxPeak (dBµV/m)	Limit (dBµV/m)	Margin (dB)	Height (cm)	Pol	Azimuth (deg)	Corr. (dB/m)
2391.400000	42.58	74.00	31.42	150.0	V	115.0	-3.91
2402.400000	97.42	74.00	-23.42	150.0	V	245.0	-3.94
2440.600000	47.88	74.00	26.12	150.0	V	324.0	-3.86
2483.200000	42.00	74.00	32.00	150.0	V	331.0	-3.70

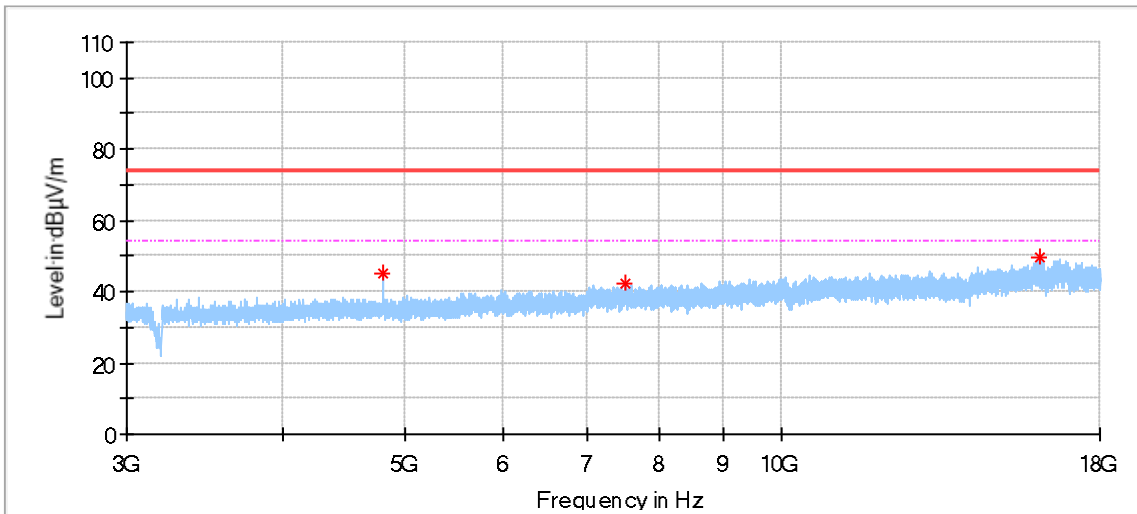

Frequency (MHz)	MaxPeak (dBµV/m)	Limit (dBµV/m)	Margin (dB)	Height (cm)	Pol	Azimuth (deg)	Corr. (dB/m)
4804.000000	45.08	74.00	28.92	150.0	V	0.0	1.10
7507.500000	42.13	74.00	31.87	150.0	V	39.0	5.49
16090.000000	49.38	74.00	24.62	150.0	V	259.0	14.78

Middle channel 2440MHz

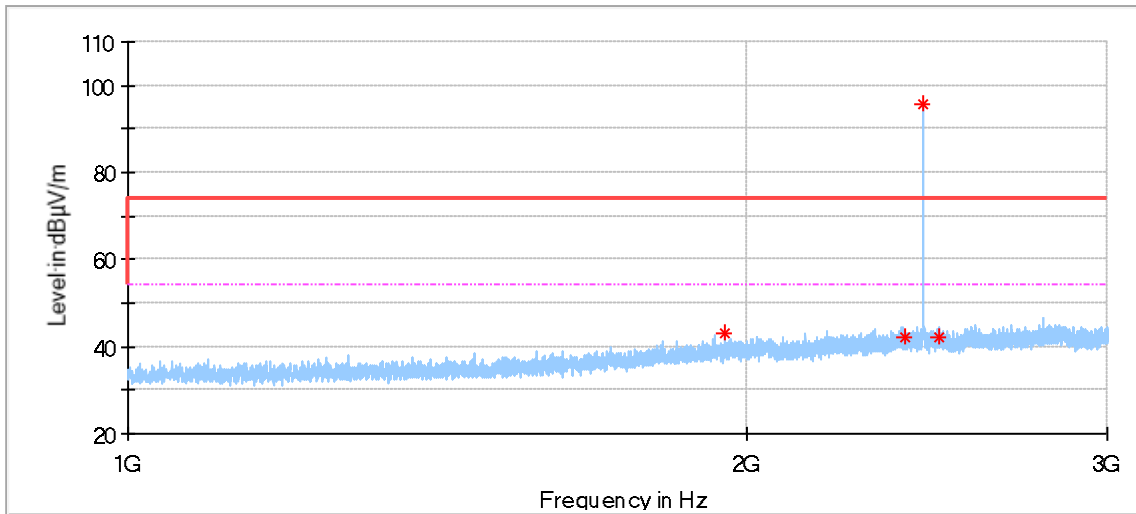

Frequency (MHz)	MaxPeak (dBµV/m)	Limit (dBµV/m)	Margin (dB)	Height (cm)	Pol	Azimuth (deg)	Corr. (dB/m)
1951.400000	43.04	74.00	30.96	150.0	H	322.0	-5.21
2390.800000	42.18	74.00	31.82	150.0	H	149.0	-3.90
2440.400000	95.56	74.00	-21.56	150.0	H	97.0	-3.86
2482.600000	41.94	74.00	32.06	150.0	H	290.0	-3.70

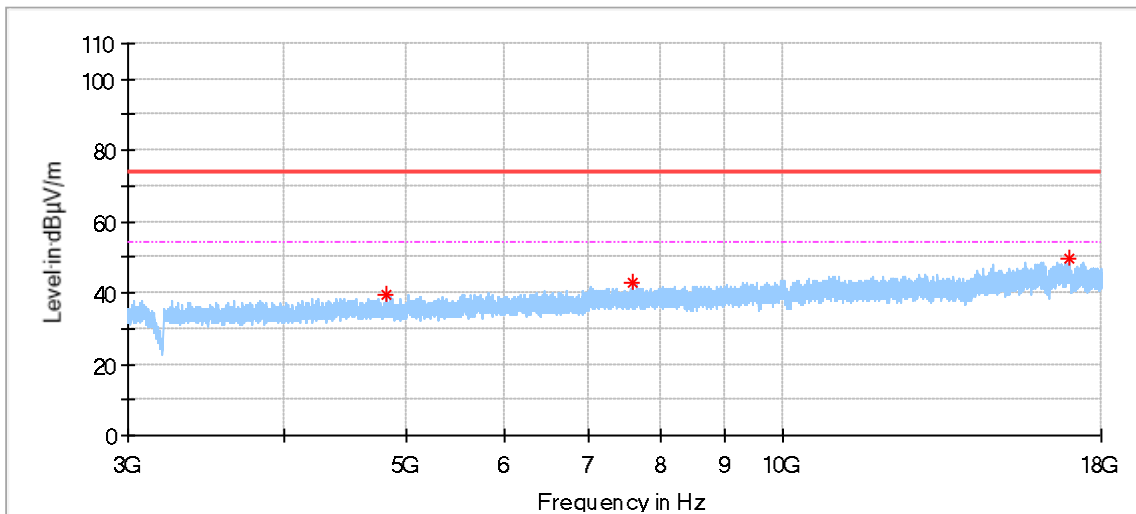

Frequency (MHz)	MaxPeak (dBµV/m)	Limit (dBµV/m)	Margin (dB)	Height (cm)	Pol	Azimuth (deg)	Corr. (dB/m)
4819.500000	39.34	74.00	34.66	150.0	H	192.0	1.12
7601.000000	43.10	74.00	30.90	150.0	H	358.0	5.48
16953.500000	49.77	74.00	24.23	150.0	H	151.0	16.46

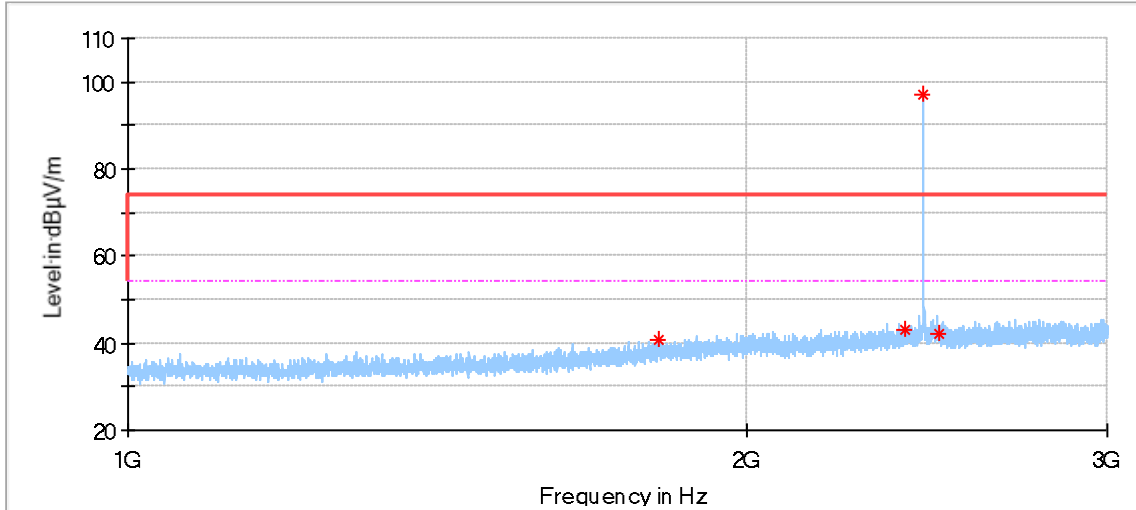

Frequency (MHz)	MaxPeak (dBµV/m)	Limit (dBµV/m)	Margin (dB)	Height (cm)	Pol	Azimuth (deg)	Corr. (dB/m)
1812.400000	40.94	74.00	33.06	150.0	V	140.0	-6.35
2390.600000	42.91	74.00	31.09	150.0	V	13.0	-3.90
2440.400000	97.00	74.00	-23.00	150.0	V	275.0	-3.86
2483.000000	42.03	74.00	31.97	150.0	V	160.0	-3.70

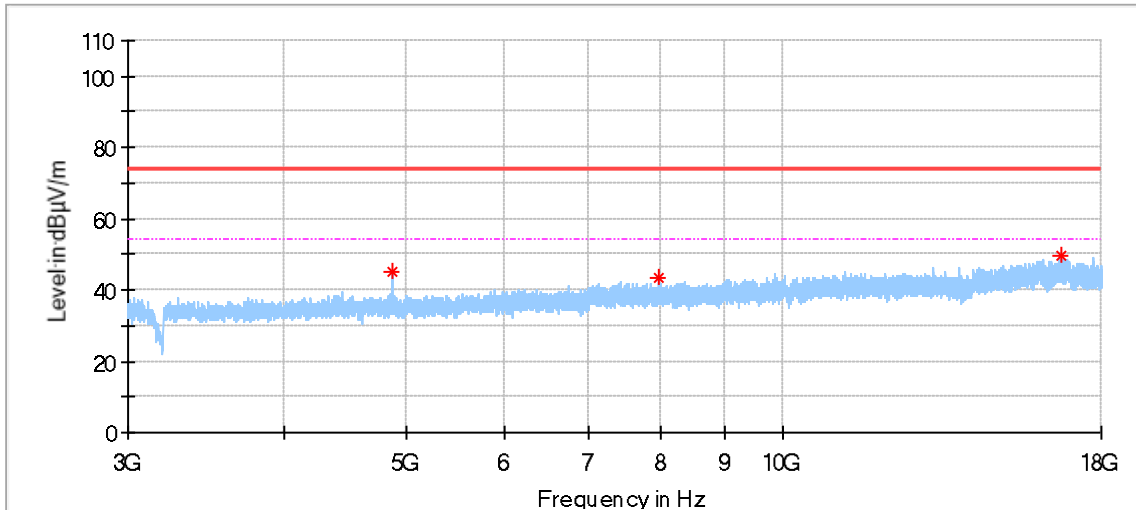

Frequency (MHz)	MaxPeak (dBµV/m)	Limit (dBµV/m)	Margin (dB)	Height (cm)	Pol	Azimuth (deg)	Corr. (dB/m)
4879.500000	45.33	74.00	28.67	150.0	V	0.0	1.11
7974.000000	43.39	74.00	30.61	150.0	V	137.0	6.04
16705.000000	49.65	74.00	24.35	150.0	V	112.0	15.92

High channel 2480MHz

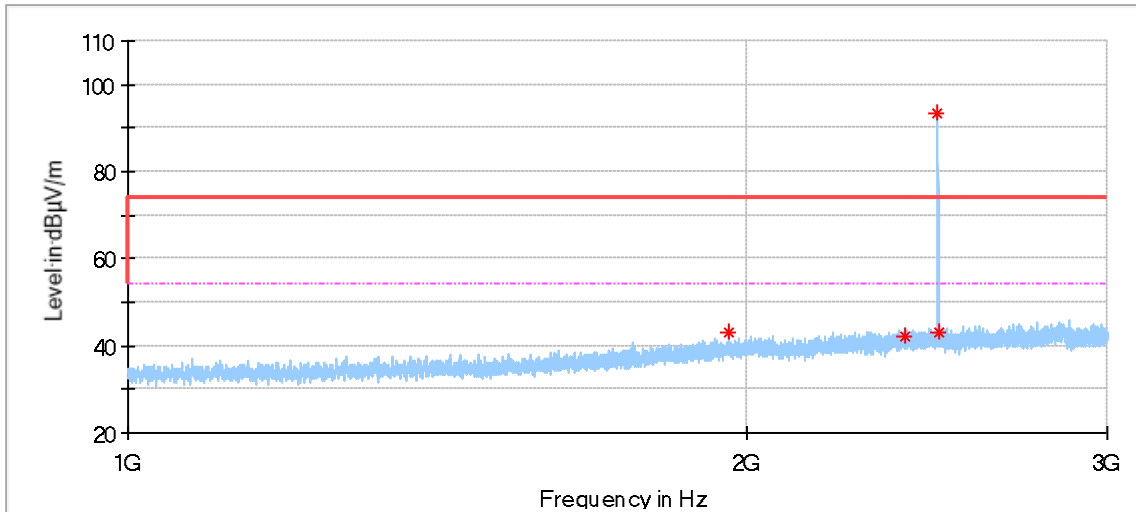

Frequency (MHz)	MaxPeak (dBµV/m)	Limit (dBµV/m)	Margin (dB)	Height (cm)	Pol	Azimuth (deg)	Corr. (dB/m)
1962.200000	42.86	74.00	31.14	150.0	H	101.0	-5.14
2390.400000	42.23	74.00	31.77	150.0	H	181.0	-3.90
2480.200000	93.21	74.00	-19.21	150.0	H	82.0	-3.70
2482.600000	42.97	74.00	31.03	150.0	H	239.0	-3.70

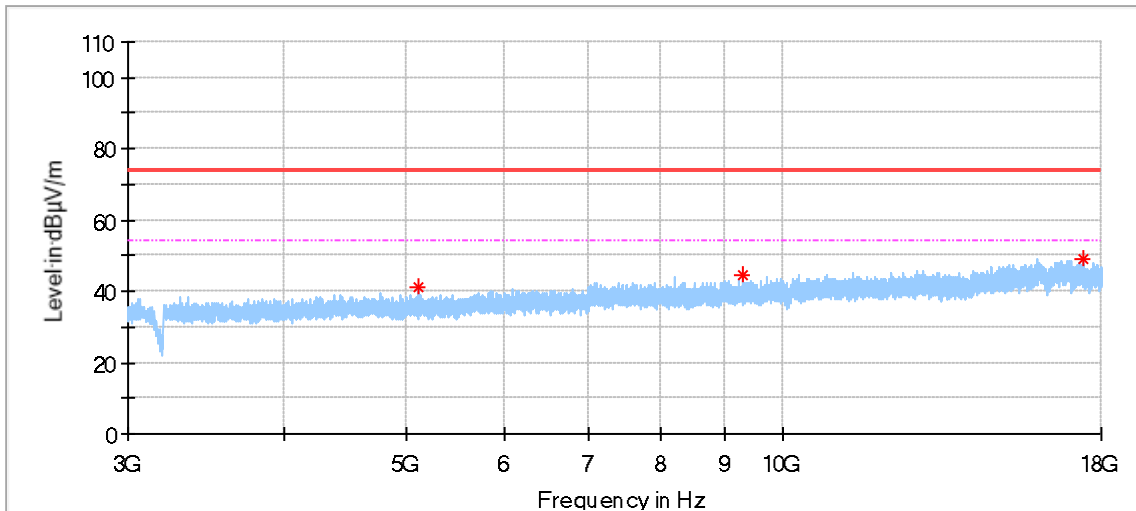

Frequency (MHz)	MaxPeak (dBµV/m)	Limit (dBµV/m)	Margin (dB)	Height (cm)	Pol	Azimuth (deg)	Corr. (dB/m)
5123.000000	40.91	74.00	33.09	150.0	H	173.0	1.36
9309.500000	44.49	74.00	29.51	150.0	H	343.0	7.01
17387.000000	49.19	74.00	24.81	150.0	H	68.0	16.42

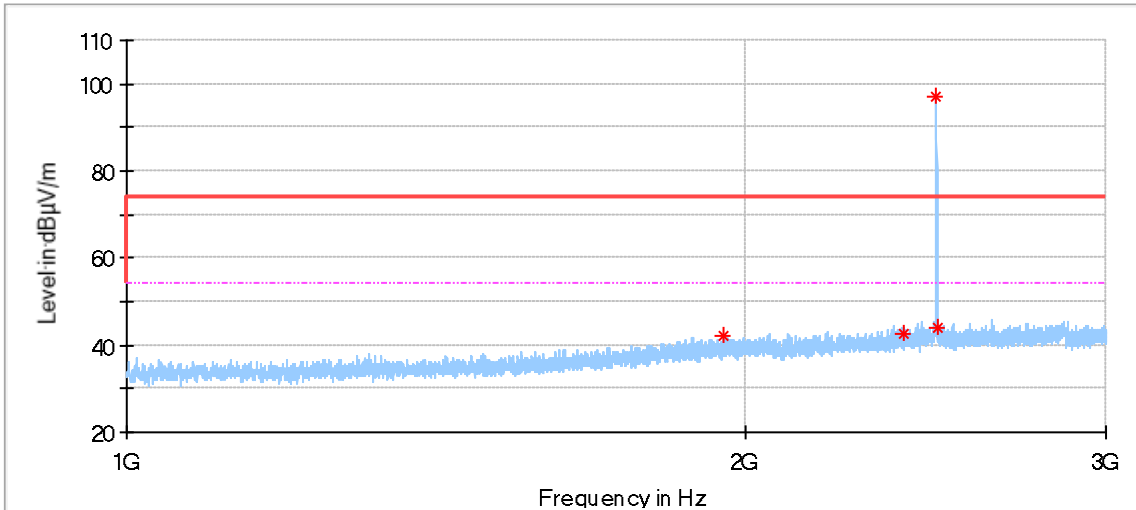

Frequency (MHz)	MaxPeak (dBµV/m)	Limit (dBµV/m)	Margin (dB)	Height (cm)	Pol	Azimuth (deg)	Corr. (dB/m)
1952.600000	42.32	74.00	31.68	150.0	V	57.0	-5.21
2389.600000	42.74	74.00	31.26	150.0	V	38.0	-3.90
2480.200000	96.90	74.00	-22.90	150.0	V	275.0	-3.70
2482.800000	44.05	74.00	29.95	150.0	V	243.0	-3.70

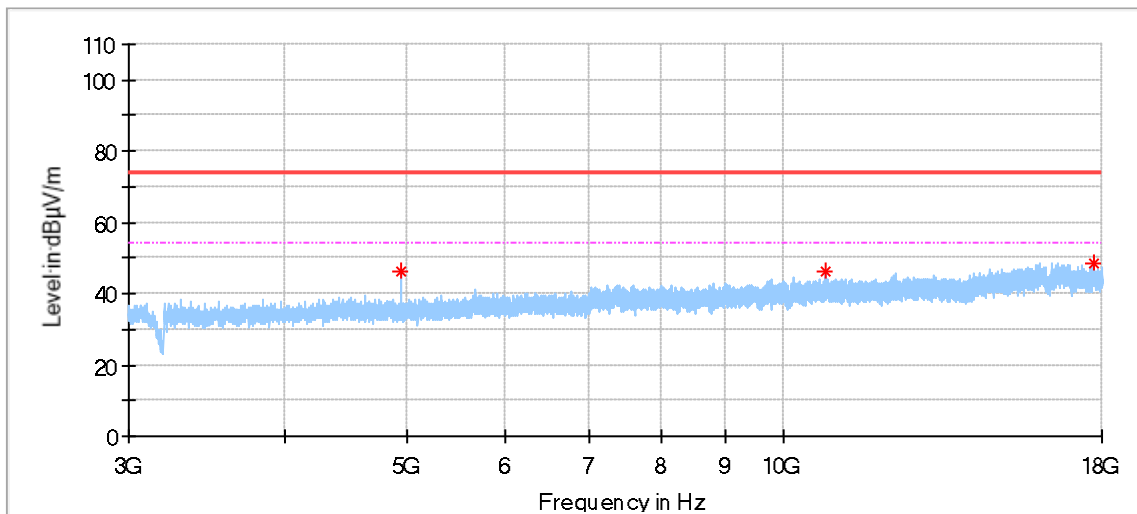

Frequency (MHz)	MaxPeak (dBµV/m)	Limit (dBµV/m)	Margin (dB)	Height (cm)	Pol	Azimuth (deg)	Corr. (dB/m)
4959.500000	46.04	74.00	27.96	150.0	V	1.0	1.10
10808.000000	46.03	74.00	27.97	150.0	V	335.0	8.41
17712.000000	48.57	74.00	25.43	150.0	V	163.0	16.32

Remark:

- (1) Data of measurement within frequency range 18-26GHz are the noise floor or attenuated more than 20dB below the permissible limits or the field strength is too small to be measured, so test data does not present in this report,
- (2) Level= Reading Level + Correction Factor
- (3) Above 1GHz: Corrector factor = Antenna Factor + Cable Loss- Amplifier Gain
 Below 1GHz: Corrector factor = Antenna Factor + Cable Loss
 (The Reading Level is recorded by software which is not shown in the sheet)

10 Test Equipment List

Radiated Emission Test

Description	Manufacturer	Model no.	Equipment ID	Serial no.	cal interval (year)	cal. due date
EMI Test Receiver	Rohde & Schwarz	ESR 26	68-4-74-14-002	101269	1	2021-6-29
Trilog Super Broadband Test Antenna	Schwarzbeck	VULB 9162	68-4-80-19-003	284	1	2021-2-24
Wave Guide Antenna	ETS	3117	68-4-80-19-001	00218954	1	2021-6-15
Pre-amplifier	Rohde & Schwarz	SCU 18F	68-4-29-19-001	100745	1	2021-12-14
Pre-amplifier	Rohde & Schwarz	SCU 08F2	68-4-29-19-004	08400018	1	2021-12-14
Sideband Horn Antenna	Q-PAR	QWH-SL-18-40-K-SG	68-4-80-14-008	12827	1	2021-8-5
Pre-amplifier	Rohde & Schwarz	SCU 40A	68-4-29-14-002	100432	1	2021-7-30
3m Semi-anechoic chamber	TDK	9X6X6	68-4-90-19-006	----	3	2022-12-29
Test software	Rohde & Schwarz	EMC32	68-4-90-19-006-A01	Version10.35.02	N/A	N/A

RF Conducted Test

Description	Manufacturer	Model no.	Equipment ID	Serial no.	cal interval (year)	cal. due date
Signal Analyzer	Rohde & Schwarz	FSV40	68-4-74-14-004	101030	1	2021-6-21

11 System Measurement Uncertainty

For a 95% confidence level, the measurement expanded uncertainties for defined systems, in accordance with the recommendations of ISO 17025 were:

System Measurement Uncertainty	
Test Items	Extended Uncertainty
Radiated Spurious Emission 30MHz-1000MHz	Horizontal: 4.70dB; Vertical: 4.67dB;
Radiated Spurious Emission 1000MHz-18000MHz	Horizontal: 4.65dB; Vertical: 4.63dB;
Conducted RF test with TS 8997	RF Power Conducted: 1.31dB Frequency test involved: 0.6×10 ⁻⁷ or 1%

---THE END OF REPORT---