

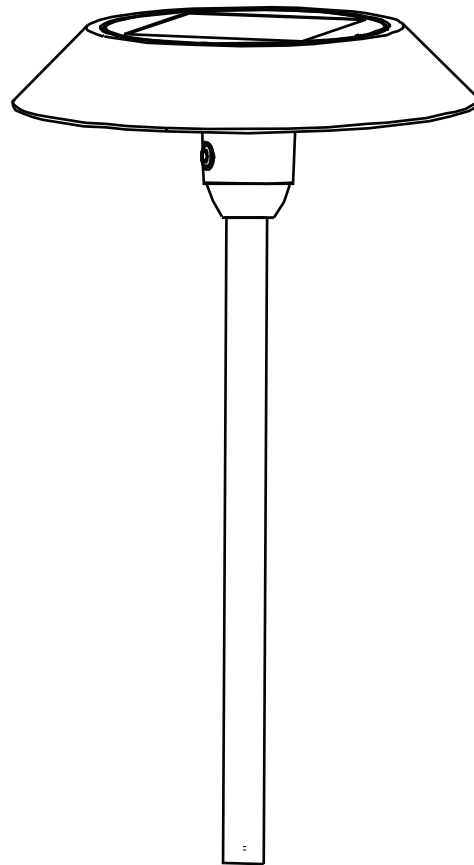

Model: PATH/SYNC/SOL/BZ (L)

USE AND CARE GUIDE

SOLAR LED PATHWAY LIGHT



Questions, problems, missing parts?

Before returning to store, visit feit.com/help for further assistance.





Table of Contents

Table of Contents 2
Safety Information 2
Warranty 2
Pre-Installation 3
 Tools Required 3
 Hardware Included 3
Pre-Charge 3
Pathway Light Installation 4
Operation without Remote 4
Operation with Remote 5
Battery Replacement 5
Set up with Smart Bridge 6
Troubleshooting 6

Safety Information

READ BEFORE INSTALLATION AND SAVE THESE INSTRUCTIONS

 **CAUTION:** Contains one 18650 rechargeable lithium-Ion battery. Risk of fire, explosion, or burns. Do not disassemble. Do not crush or damage the battery. Do not heat or incinerate. Do not open or disassemble. Do not make modifications to this product.

 **WARNING:** Dispose of used battery promptly according to local recycling or waste regulations. Keep battery out of reach of children and its original package until ready to use. Clean battery contacts and unit contacts prior to installing new battery. Ensure that the battery is installed correctly with regard to polarity (+ and -).

HOW SOLAR LIGHTS WORK:
Solar panels convert sunlight into electricity. During the day, while the sun is shining, electricity converted by the solar panel is stored in the rechargeable battery. At night, the solar light is powered by the battery using the electricity stored during the day. The operating time depends on geographical location, daily weather conditions and season.

CHOOSING THE RIGHT LOCATION:
It is important to select a location with as much sunlight as possible. Shady areas will not allow the battery to be fully charged and will reduce the nighttime working hours. Be sure that the selected location is not close to other nighttime light sources such as streetlights or porch lights. These light sources may keep the solar lights from turning on automatically.

DUSK TO DAWN OPERATION:
This product is designed to only operate at night. The light will remain off during the day and turn on automatically at dusk and remain on for up to six hours.
NOTE: To make sure this function works properly, the switch must be in the selected color position.

FCC STATEMENT

This device complies with part 15 of the FCC Rules. Operation is subject to the following two conditions: (1) This device may not cause harmful interference, and (2) this device must accept any interference received, including interference that may cause undesired operation. Note: This equipment has been tested and found to comply with the limits for a Class B digital device, pursuant to part 15 of the FCC Rules. These limits are designed to provide reasonable protection against harmful interference in a residential installation. This equipment generates, uses and can radiate radio frequency energy and, if not installed and used in accordance with the instructions, may cause harmful interference to radio communications. However, there is no guarantee that interference will not occur in a particular installation. If this equipment does cause harmful interference to radio or television reception, which can be determined by turning the equipment off and on, the user is encouraged to try to correct the interference by one or more of the following measures: Reorient or relocate the receiving antenna. Increase the separation between the equipment and receiver. Connect the equipment into an outlet on a circuit different from that to which the receiver is connected. Consult the dealer or an experienced radio/TV technician for help. Any changes or modifications not expressly approved by the manufacturer could void the user's authority to operate the equipment. RF Exposure. The equipment has been evaluated to meet general RF exposure requirement. The device can be used in portable condition without restriction.

Supplier's Declaration of Conformity:
47 CFR § 2.1077 Compliance Information
Responsible Party:
Feit Electric Company
4901 Gregg Road,
Pico Rivera, CA 90660, USA
Unique Identifier:
PATH/SYNC/SOL/BZ (L)

Limited Warranty

This product is warrantied to be free from defects in workmanship and materials for up to three years from date of purchase. If the product fails within the warranty period, please contact feit electric at info@feit.Com, visit feit.Com/contact-us for instructions on replacement or refund. Replacement or refund is your sole remedy. Except to the extent prohibited by applicable law, any implied warranties are limited in duration to the duration of this warranty. Liability for incidental or consequential damages is hereby expressly excluded. Some states and provinces do not allow the exclusion of incidental or consequential damages, so the above limitation or exclusion may not apply to you. This warranty gives you specific legal rights, and you may also have other rights which vary from state to state or province to province.

Pre-Installation

TOOLS REQUIRED

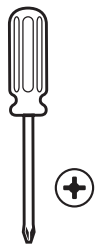

Phillips
screwdriver

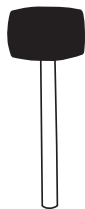

Rubber Mallet



AA



BB



CC

HARDWARE INCLUDED



NOTE: Hardware not shown to actual size.

Part	Description	Quantity
AA	LED Pathway Light	1
BB	12 in. Pole	1
CC	Ground Stake	1

Pre-Charge

1 For best performance, charge the unit for two (2) days prior to use

- Remove the insulating tab.
- In order to properly charge, the unit must be turned OFF. Use the On/Off/Cycle button to cycle through all of the colors (Soft White, Bright White, Cool White, Daylight, Deluxe Daylight, Red, Blue, Green, Yellow, Orange, Purple, Teal, and Pink) and reach the OFF position .
- Select a location with as much sunlight as possible.
- After the unit has charged in the sun for two (2) days, turn it back on by pressing the On/Off/Cycle button and selecting the color of your choice. If there is daylight outside, it will stay on for about 10 - 20 seconds and then turn off. If it is nighttime, the unit will remain on.

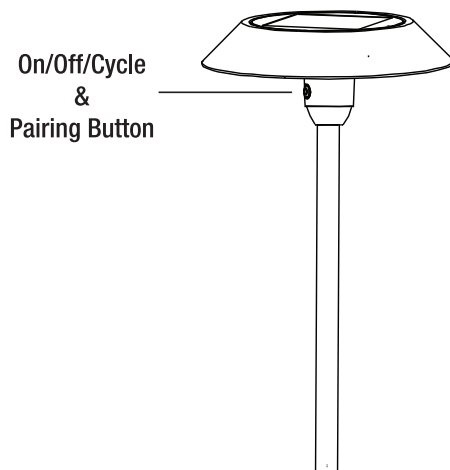

Pathway Light Installation

1 Peel off sticker from solar panel and remove insulating tab

- Peel off the sticker from the solar panel.
- Remove the insulating tab.
- It is recommended that you charge the unit for two (2) days before use to adequately charge the battery, following the Pre-Charge instructions.

2 Installing the stake

- Push the ground stake (CC) into the ground. Using rubber mallet, insert ground stake (CC) deep enough into the ground to ensure fully assembled pathway light (AA) is stable and does not tip over.

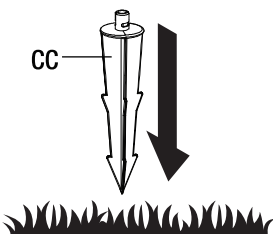

NOTE: When installing product in hard or dry soil, water the soil several hours beforehand to make the installation easier. You can also break up the ground lightly with a stake or a fork. Don't force stake into the ground as excess force can break or bend the stake.

3 Installing the Pathway Light

- Align the ground stake (CC) slot with the rivet indicator on the pathway light. Slide the pathway light (AA) base downward and then turn clockwise.
- Align the pathway light (AA) with the slot on the 12 in. pole (BB). Slide the pathway light (AA) downward then turn clockwise.



IMPORTANT: Do not push on the pathway light (AA) or you may damage the unit.

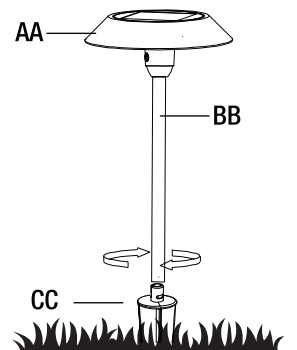

Operation without Remote

For expanded control, this OneSync Pathway Light is compatible with OneSync remote or WiFi Bridge (sold separately).

DUSK TO DAWN OPERATION:

The unit will automatically turn on at dusk and remain on through the night for 6 hours. The unit will remain off throughout the day, until dusk. **NOTE:** To make sure this function works properly, always have the switch in the 'ON' position (including daytime).

1 Turning on the Pathway Light

- Turn on the pathway light (AA) by pressing the button located on the base, below the light.

On/Off/Cycle
&
Pairing Button

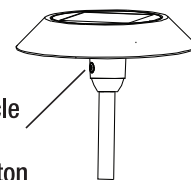

2 Selecting a Color

- To cycle through the colors, push the button.
- Select colors: Soft White, Bright White, Cool White, Daylight, Deluxe Daylight, Red, Blue, Green, Yellow, Orange, Purple, Teal, and Pink.
- The pathway light will remember the color setting when next turned on.

IMPORTANT: Light brightness is determined by the charge level of the batteries. Brightness will decrease during operation to extend battery life.

IMPORTANT: Selecting a color, other than white, will extend battery life.

Operation with Remote (sold separately)

Operating with a OneSync remote allows for expanded control. Modify settings of individual OneSync unit or multiple units in groups. The OneSync remote has a 100ft control range and will command all paired units within 100ft of the remote.

All OneSync units are equipped with a signal repeater that will repeat any remote commands to all other units within 100ft. Placing units within 100ft of at least one other unit creates a control network and allows for unlimited remote control range, as long as there is a functioning OneSync unit within 100ft to relay the command.

Example: You can install a OneSync unit, then another OneSync unit 100ft away from the first unit. Continue to install 3 more OneSync units in this way so that the last unit is 500ft away. Using this relay technology, the remote will control the farthest unit that is 500ft away.

1 Entering pairing mode

- Hold down the pairing button for 3 seconds. Once the pathway light (AA) starts to blink slowly it is in pairing mode. The pathway light (AA) remains in pairing mode for three minutes before timing out.

2 Pairing the remote to the Pathway Light

- While the pathway light (AA) is in pairing mode, press and hold the desired Groups button (1, 2, 3, 4, 5 or 6) for 3 seconds to pair the remote to the selected group. The unit will flash once, and the unit will exit pairing mode.

3 Unpairing the Pathway Light from the remote

- To unpair, first follow step 1 so that the unit is in pairing mode. Once the unit is in pairing mode, on the OneSync remote, press the pairing group button and hold the power button for 3 seconds. The unit will flash once and the unit will exit pairing mode.
- The light will flash once, and the unit will exit pairing mode.
- To unpair from all groups at once, hold down button on the OneSync unit for 10 seconds. It will flash three times rapidly to indicate that that all groups have been unpaired from the unit.

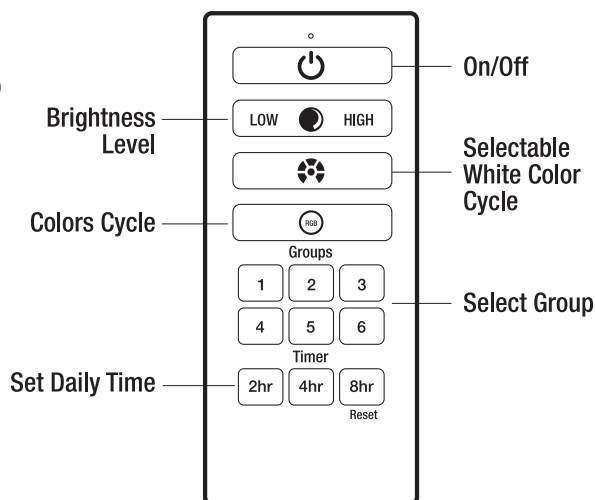

NOTE: The remote comes equipped with a universal Group #1. To create unique groups, pair using Groups #2-6. All units are pre-paired to the universal Group #1 so that they will immediately respond with any remote Group #1 command. To not operate on this universal group, follow the unpairing instructions in Step 3.

Battery Replacement

1 Replacing the battery

- To replace the rechargeable battery (B), unscrew the lid screws (4) located under the light using a Phillips head screwdriver.
- Replace current lithium-ion battery (B) with a new lithium-ion 18650 2600mAh 3.6V minimum 9.36Wh only.
WARNING: Install battery correctly with regard to the polarity (+ and -).
- Reattach the lid by securing the (4) screws using a Phillips head screwdriver.

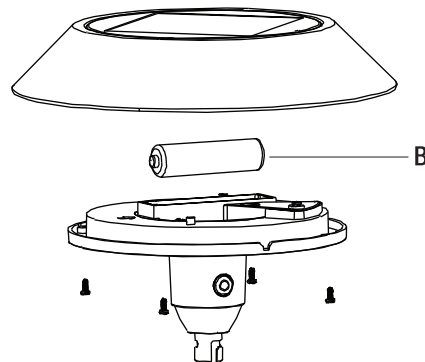

Set up with Smart Bridge

1 Downloading and installing the Feit Electric app

- Search for the Feit Electric app in the App Store or Google Play Store.
- Download and Install the Feit Electric app on your smart unit.
- Connect to a 2.4GHz Wi-Fi network that covers your installation location.
- Follow the instructions in the Feit Electric app & Smart Bridge manual to pair your OneSync units.



Feit Electric App



Only supports
2.4GHz Wi-Fi
Networks

Troubleshooting

PROBLEM	POSSIBLE CAUSES	CORRECTIVE ACTION
The unit will not turn on.	The battery is not making contact.	Loosen the battery cover screws, pull out the battery cover and inspect the battery connection. After inspection, reinsert the battery.
	The battery is not fully charged.	Ensure the solar panel is positioned in a location that provides full and direct sunlight. If installed in a shady area, the battery will take a longer time to charge, and may not fully charge, and reduce working hours.
	The panel is near an external light source that is inadvertently triggering the dusk to dawn sensor.	Relocate the panel to an area that does not have any external light sources or remove the external light sources from the panel's proximity.
The units go out too early.	The battery charge is low.	Allow the batteries to get a full charge by powering off the unit for 1-2 days. Or relocate the unit to an area with direct sunlight. Check panel for dirt, damage, or light obstruction.
The unit turns on and off continuously.	The solar panel is near an external light source that is inadvertently triggering the dusk to dawn sensor.	Relocate or shield the solar panel so that external light sources do not shine directly on it.
The unit turns on for 10 - 20 seconds and then turns off.	The dusk to dawn sensor is turning the unit off. This will happen during daytime.	The unit should automatically turn on at dusk.



Questions, problems, missing parts?

Before returning to store, visit feit.com/help for further assistance.

