

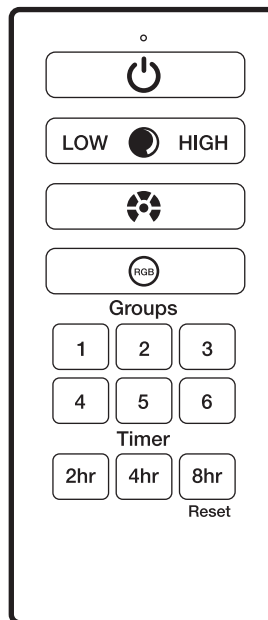

Model: SYNC/REMOTE

USE AND CARE GUIDE

HANDHELD REMOTE CONTROL



Questions, problems, missing parts?

Before returning to store, visit feit.com/help for further assistance.



Table of Contents

Safety Information 2
Warranty 2
Pre-Installation 3
 Tools Required 3
 Hardware Included 3
Backplate Screw Installation 4
Backplate Adhesive Installation 4
OneSync Remote Operation 5
Battery Installation/Replacement 5
Pairing the OneSync Fixture to the Remote 6
Transferring Groups from Remote to Smart Bridge 7
How to Transfer Groups from Smart Bridge to Remote 8
How to Delete Groups between Remote and Smart Bridge. 8

Safety Information

READ BEFORE INSTALLATION AND SAVE THESE INSTRUCTIONS

 **CAUTION:** Provided with two AAA batteries (1.5V).

- KEEP OUT OF THE REACH OF CHILDREN.
- Ensure the batteries are installed with the correct polarity (+ and -).
- Ensure the batteries are in good condition before installation.
- Remove batteries from remote if not used for an extended period.
- Replace used batteries promptly.
- These batteries are not intended for recharging.
- Dispose of batteries in accordance with local requirements.

FCC STATEMENT

This device complies with part 15 of the FCC Rules. Operation is subject to the following two conditions: (1) This device may not cause harmful interference, and (2) this device must accept any interference received, including interference that may cause undesired operation. Note: This equipment has been tested and found to comply with the limits for a Class B digital device, pursuant to part 15 of the FCC Rules. These limits are designed to provide reasonable protection against harmful interference in a residential installation. This equipment generates, uses and can radiate radio frequency energy and, if not installed and used in accordance with the instructions, may cause harmful interference to radio communications. However, there is no guarantee that interference will not occur in a particular installation. If this equipment does cause harmful interference to radio or television reception, which can be determined by turning the equipment off and on, the user is encouraged to try to correct the interference by one or more of the following measures: Reorient or relocate the receiving antenna. Increase the separation between the equipment and receiver. Connect the equipment into an outlet on a circuit different from that to which the receiver is connected. Consult the dealer or an experienced radio/TV technician for help. Any changes or modifications not expressly approved by the manufacturer could void the user's authority to operate the equipment.

Supplier's Declaration of Conformity:
47 CFR § 2.1077 Compliance Information
Responsible Party:
Feit Electric Company
4901 Gregg Road,
Pico Rivera, CA 90660, USA
Unique Identifier:
SYNC/REMOTE

RF EXPOSURE STATEMENT

This equipment complies with the FCC and ICED radiation exposure limits set forth for an uncontrolled environment. This transmitter must not be co-located or operating in conjunction with any other antenna or transmitter.

Limited Warranty

This product is warranted to be free from defects in workmanship and materials for up to three years from date of purchase. If the product fails within the warranty period, please contact **feit electric** at info@feit.com, visit feit.com/contact-us for instructions on replacement or refund. Replacement or refund is your sole remedy. Except to the extent prohibited by applicable law, any implied warranties are limited in duration to the duration of this warranty. Liability for incidental or consequential damages is hereby expressly excluded. Some states and provinces do not allow the exclusion of incidental or consequential damages, so the above limitation or exclusion may not apply to you. This warranty gives you specific legal rights, and you may also have other rights which vary from state to state or province to province.

Pre-Installation

TOOLS REQUIRED

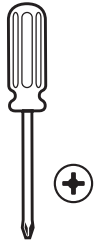

Phillips screwdriver



Pencil

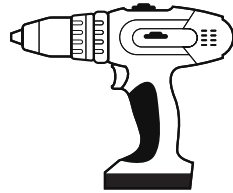

Power drill



7/32 in. Drill Bit

HARDWARE INCLUDED

 **NOTE:** Hardware not shown to actual size.



AA

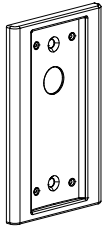

BB



CC



DD

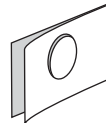

EE

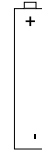

FF

Part	Description	Quantity
AA	Remote Control	1
BB	Remote Backplate	1
CC	Anchors	2
DD	Screws	2
EE	Double-Sided Adhesive	2
FF	AAA Remote Batteries	2

Backplate Screw Installation

1 Installing the backplate

- Position the backplate (BB) in the desired location. Utilize the holes on the backplate (BB) to mark the location for the wall anchors (CC).

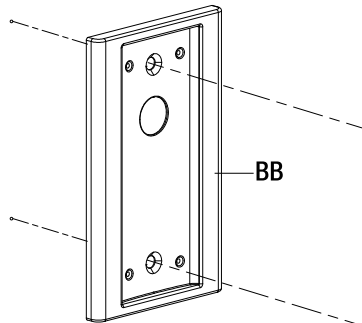

2 Drilling the holes

- Use a power drill to pierce two holes in the marked locations and insert the wall anchors (CC).

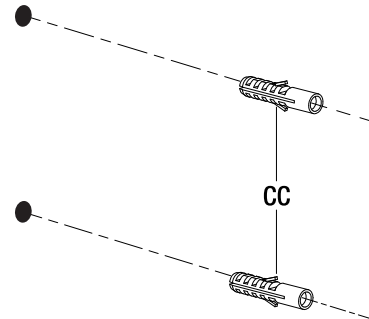

3 Attaching the backplate

- Align the backplate (BB) holes with the wall anchors (CC) and insert the screws (DD) using a Phillips screwdriver.

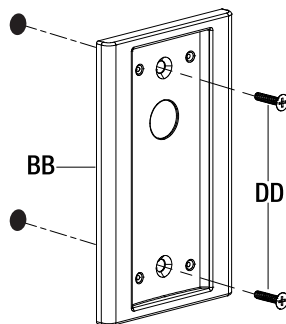

Backplate Adhesive Installation

Wipe down surface before installation.
For best results only install on smooth, clean surfaces.

1 Peeling off the protective film

- Peel off the protective film from one side of the double-sided adhesive (EE).

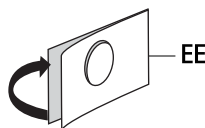

2 Attaching the double-sided tape

- Attach the double-sided adhesive (EE) to the backplate (BB). Peel off the other side of the double-sided adhesive (EE).

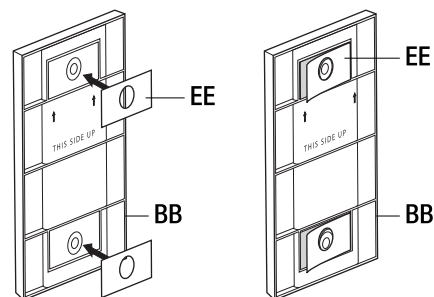

3 Pressing the backplate onto the surface

- Position the backplate (BB) to the desired area. Press the backplate (BB) onto the surface and hold for 30 seconds to assure the backplate (BB) is held securely.

OneSync Remote Operation

The OneSync remote has a 100ft control range and will command all paired fixtures within 100ft of the remote.

All OneSync fixtures are equipped with a signal repeater that will repeat any remote commands to all other fixtures within 100ft. Placing fixtures within 100ft of at least one other fixture creates a control network and allows for unlimited remote control range, as long as there is a functioning OneSync fixture within 100ft to relay the command.

Example: You can install a OneSync fixture, then another OneSync fixture 100ft away from the first unit. Continue to install 3 more OneSync fixtures in this way so that the last fixture is 500ft away. Using this relay technology, the remote will control the farthest fixture that is 500ft away.

1 Remote Control Button Configurations

- ❑ **LED Indicator Light:** LED indicator light will flash when a button is pressed to signify that the battery is still charged.
- ❑ **On / Off:** Press this button to turn all connected lights on & off.
- ❑ **Brightness Level:** Press the left and right sides of the dimming button to adjust the brightness.
- ❑ **Selectable White Color Cycle:** Press this button to rotate through Soft White (2700K), Bright White (3000K), Cool White (4000K), Daylight (5000K) and Deluxe Daylight (6500K).
- ❑ **Color Cycle:** Press this button to rotate through Red, Blue, Green, Yellow, Orange, Purple, Teal and Pink.
- ❑ **Select Group:** Press the group number before pressing function buttons to control the lights paired to the specific group.
- ❑ **Daily Timer:** Press the timer button to set how long the connected lights will remain on. Solar items will turn On automatically at dusk and turn off after the set amount of time. Non-solar powered devices will turn On every day at the exact time the timer was set. Press and hold the 8hr button for 5 seconds to reset timer back to 6hrs (default). For non-solar powered devices, the timer will be deactivated.

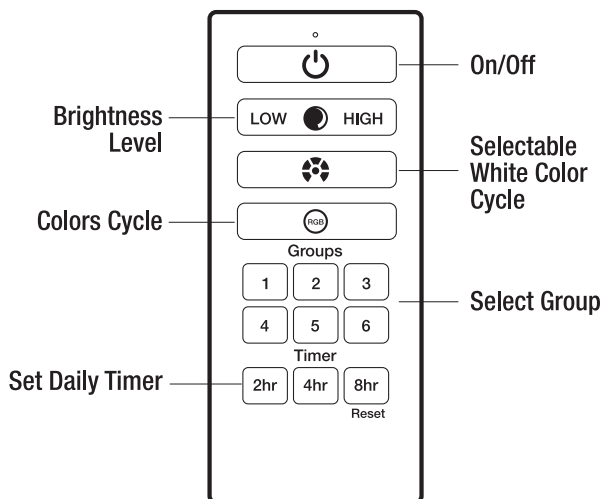

Battery Installation/Replacement

1 Accessing the Batteries

- ❑ Slide the battery cover off of the back of the remote control (AA) to expose the battery compartment and install or replace the AAA batteries.

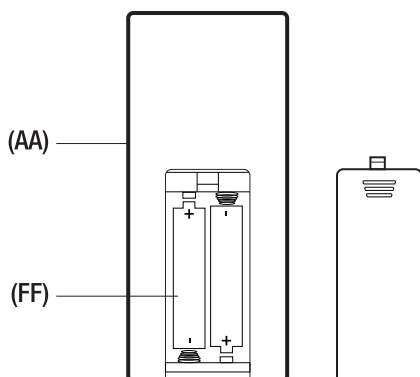

Remove the back cover to replace the batteries. Follow the correct polarity. Remote only uses AAA batteries.

Pairing the OneSync Fixture to the Remote



NOTE: The OneSync remote (AA) is compatible with: PATH/SYNC/SOL/BZ, PATH/SYNC/SOL/NK, BOLLARD/SYNC/SOL/BZ, BOLLARD/SYNC/SOL/NK, SPOT/SYNC/SOL/BZ, SPOT/SYNC/SOL/NK, SPOT/PANEL/SYNC, LAN4SQ/SYNC/SOL/BZ, LAN4RND/SYNC/SOL/BZ, LAN11SQ/SYNC/BZ, SYNC/PLUG/REM and SYNC/LV/BOX.

Operating with a OneSync remote (AA) allows for expanded control. Modify settings of individual OneSync fixtures or multiple fixtures by using Groups.

1 Entering pairing mode

- Hold down your device's pairing button for 3 seconds. Once the device starts to blink slowly, it is in pairing mode. Your device will remain in pairing mode for three minutes before timing out.

2 Pairing the remote to the fixture

- While the device is in pairing mode, press and hold the desired Groups button (1, 2, 3, 4, 5 or 6) for 3 seconds to pair the remote (AA) to the selected group. The light will flash once and the device will exit pairing mode.

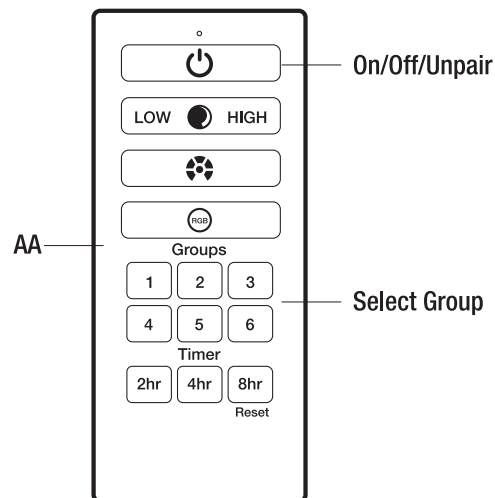

3 Unpairing the remote from the device

- To unpair, first follow step 1 so that the device is in pairing mode. Once the device is in pairing mode, on the OneSync remote (AA), press the pairing group button and hold the power button for 3 seconds.
- The light will flash once, and the device will exit pairing mode
- To unpair from all groups at once, hold down button on the OneSync device for 10 seconds. It will flash three times rapidly to indicate that that all groups have been unpaired from the fixture.



NOTE: The remote comes equipped with a universal Group #1. To create unique groups, pair using Groups #2-6. All fixtures are pre-paired to the universal Group #1 so that they will immediately respond with any remote Group #1 command. To deactivate this universal group, follow the unpairing instructions in Step 3.

Transferring Groups from Remote to Smart Bridge

If you have a remote with a preexisting pairing to OneSync lights, you can easily transfer these groups to a new smart bridge.



NOTE: The smart bridge must first be setup and connected to a phone or smart device before transferring.

1a Transferring all groups from the remote to the smart bridge by pairing.

- On the smart bridge, push pairing button five times consecutively to activate pairing mode. The LED indicator will start blinking rapidly and smart bridge will enter pairing mode for 30 seconds.
- On the remote, press and hold Groups button 1 for five seconds.
- The LED indicator will stop blinking once the remote and smart bridge have paired successfully.

1b Transferring a specific group from the remote to the smart bridge using the Feit app.

- On the remote, select the group number you wish to transfer (1, 2, 3, 4, 5 or 6).
- In the Feit app, press the Transfer button.
- On the remote, press and hold the 2hr Timer button for five seconds.
- The fixtures in the group will blink once to indicate a successful transfer.
- The Smart Bridge will now be able to control the fixtures under the group that has been transferred.

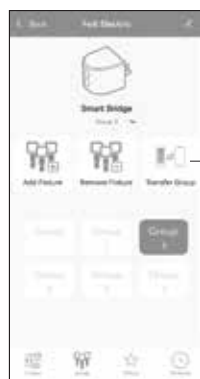

Transfer Button

How to Transfer Groups from Smart Bridge to Remote

If you have a smart bridge with a preexisting pairing to OneSync lights, you can easily transfer these groups to a new remote.



NOTE: The smart bridge must first be setup and connected to a phone or smart device before transferring.

1 Transferring a specific group from the smart bridge to the remote using the Feit app.

- In the Feit app, select a group number and press Transfer Group. Smart bridge will enter transfer mode for 30 seconds.
- On the remote (AA), press and hold the RGB button for five seconds.
- The fixtures in the existing group will blink once to indicate successful transfer.
- Remote will now be able to control the fixtures under the group that has been transferred.

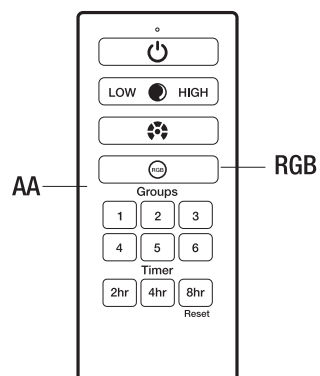

How to Delete Groups between Remote and Smart Bridge

1a Unpairing the smart bridge from the remote.

- On the smart bridge, push the pairing button five times to activate unpairing mode. The LED indicator will start blinking and smart bridge will be in unpairing mode for 30 seconds.
- On the remote (AA), press and hold the power button for five seconds.
- The LED indicator will stop blinking once the remote and smart bridge have unpaired successfully.
- The remote and the smart bridge will work independently.

1b Deleting transferred groups.

- Press the Transfer button in the Feit app.
- On the remote, press and hold the Selectable White Color Cycle button for five seconds.

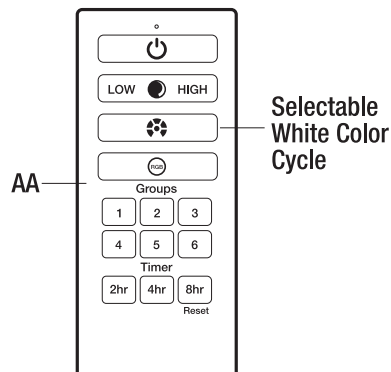



Contact Feit Electric at info@feit.com
7 a.m. - 5 p.m., PCT,
Monday - Friday for instructions on
replacement.
Do not return the product to the store.
FEITELECTRIC.COM
Retain this manual for future use.

Before returning to store, visit feit.com/help for further assistance.

