



USER MANUAL



SPECIAL REMINDING:

- 1.No matter air pressure over 3.0Bar(43Psi) or under 2.0Bar (29Psi) the system will also give alarm. When it is quick or slow air leakage, it will alarm.
- 2.This system have been set base on the standard, do not change any setting before using.
- 3.Suggested air pressure: 2.2~2.3Bar in hot summer, and 2.4~2.6Bar in cold winter.

Factory Tour



40100201240

LP506 Display



1. Press the setting button for 3 seconds to enter the system parameter setting.
2. Press the left button for 1 second, can view the temperature parameter.
3. Press the left button for 3 seconds turn off to the display.
4. Press the right button for 3 seconds, can restore factory default setting parameters, Be Be... Be...Sound , setting success .

LP503 Display

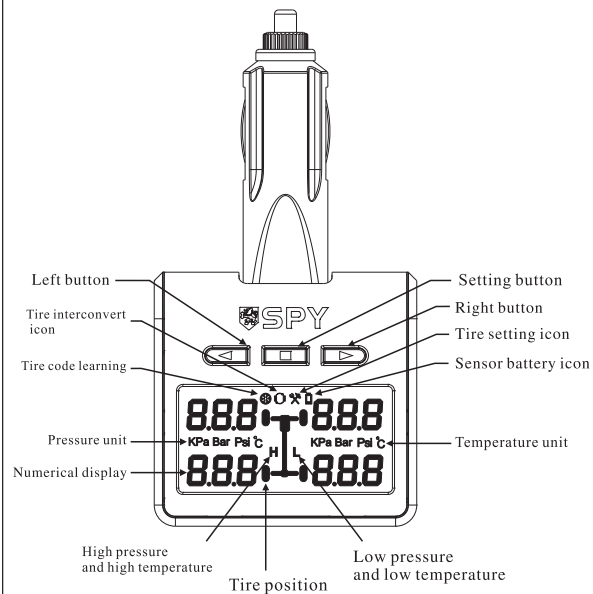

LP505 Display

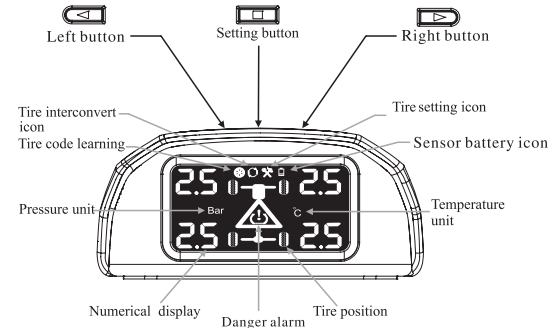

Connect the red wire from display to ACC power. Connect the black wire from display to negative output of battery.

LP508 Display

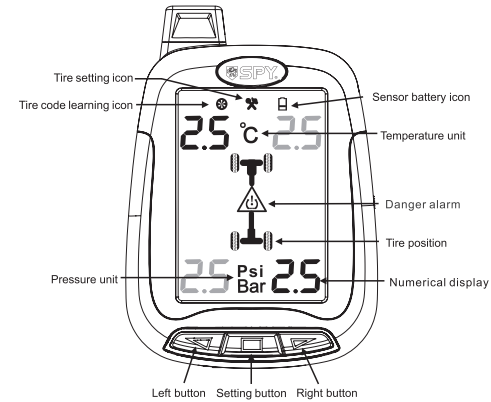

LP508H-6 Display

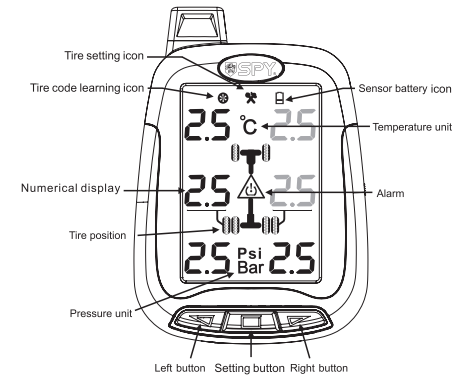

4. Press the right selection button for 3 seconds, can restore factory default setting parameters, Be Be... Be...Sound , setting success .

Note: LP508H-6 Default alarm settings for
 Low pressure : 5.5bar
 High pressure : 8.0bar

Sensor installation process

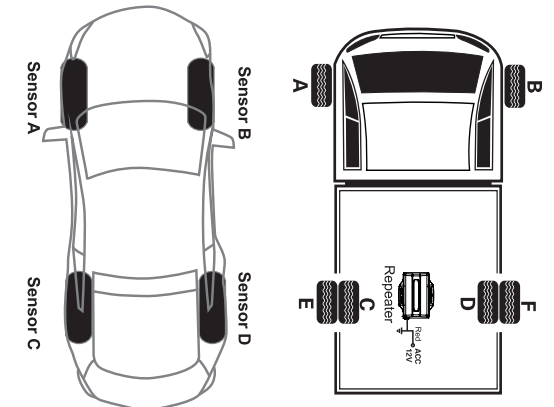

Tire pressure sensor installation by the graphic position

Repeater power supply:ACC12V
 Tire pressure sensor installation, by the graphic position

Unit Installation

1. Remove the origin valve and install the TPMS
2. Lock TPMS valve screw by sleeve.

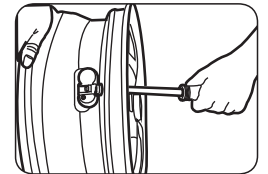
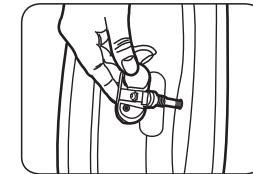

3. Put the sensor on the wheels in order to touch well

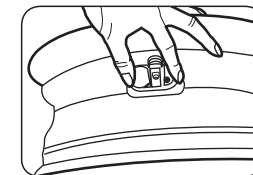

4. Hand on and press the sensor housing, tight the screw behind the sensor by hexagonal screw driver

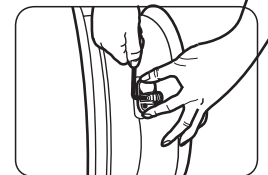

5. Don't fit the screw too tight

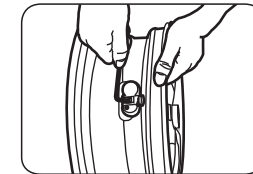

6. The pictures after installation .

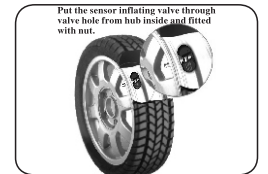

7. Charge Nitrogen gas

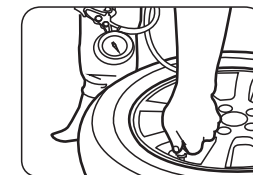

8. Dynamic balancing checking

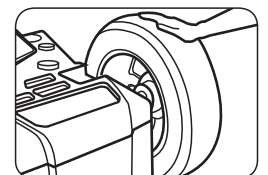

External TPMS Installation Diagram

1. Screw out the Valve dustproof cover
2. Screwed into the hex nut
3. Set into the tamper gasket
4. According to the sensor location identifier, screw in and tighten for the corresponding tire
5. Using nut wrench in Negative direction forced tension sensor
6. Check whether or not is leakage with soap and water

Battery Replacement Chart





1. Release the hex nut
2. Rotation sensor
3. Remove tamper gasket
4. With the cover opening spanner unscrew shell

5. Released by tool , and with a fingernail to bring out sensor
6. Change new CR1632 button battery
7. Reverse operation, the sensor will be refit

Tire Learning Code & Display Parameters Setting

WITHOUT SPECIAL DEMAND, DO NOT CHANGE ANY SETTING BEFORE USING





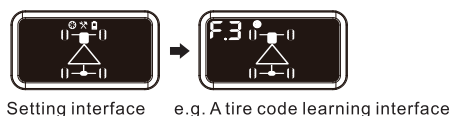









1. The Learning Code & Display Parameters Setting











Tire learning code method:
Press the setting button  for 3 seconds to enter the settings interface, see the tire learning icon  is flashing, press the left button  once to see A tire icon flashing, put the CR1632 battery into the battery holder of the A sensor for power (Note: Refer to external sensor battery replacement chart), when heard BE... sound once, it means A sensor code learning succeeds, the press right button  once, the B tire icon is flashing now , put the B sensor's battery into the holder for power, when heard BE... sound once, it means B sensor code learning succeeds. Using the same operating procedures, code learning C, D sensor, after finishing all 4 sensors code learning, then press setting button  twice to exit.





Note: 1. Interior sensor code learning by quick air exhaust.
2. Each tire code learning interface should not exceed 10 seconds, if exceeded, the system will automatically exit, should press the setting button for 3 seconds to enter settings again.

2. High pressure, low pressure and high temperature parameter settings

(1) Press the setting button  for 3 seconds to enter the settings interface, see the tire learning icon  is flashing, press the right button  once to see tire settings icon  is flashing;
Now press the left button  once, see the factory setting high pressure parameter interface (3.0Bar/43Psi), and then press the left button  once again, the first digit is flashing, press the right button  to transform digit, when transform to the desired digital number, press the left button  once to confirm, the second digit of high pressure is flashing, then press the right button  to transform digit, when transfer to the desired digital number, press the left button  once to confirm, will hear BE... sound, it means the high pressure parameter is set successfully.
(2) Then press the right button  once, the factory setting low pressure parameter interface (2.0Bar/29Psi) will appear, and the press the left button  once, the first digit is flashing, then press the right button  to transform digit, when transform to the desired digital number, press the left button  once to confirm, the second digit of low pressure

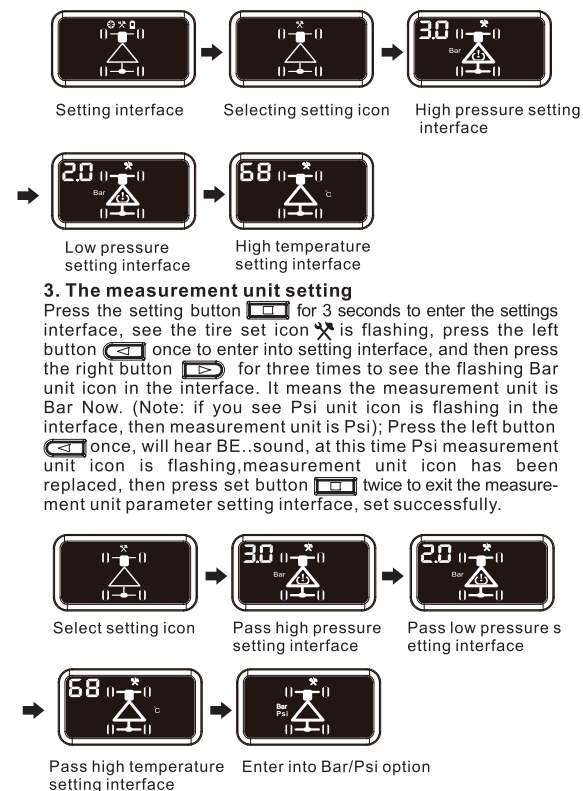
is flashing, then press the right button  to transform digit, when transform to the desired digital number, press the left button  once again to confirm, will hear BE... sound, it means the low pressure parameter is set successfully.
Note: If you do not want to change the high pressure, low pressure parameter, enter into the tire setting interface, press the right button  once to enter the settings, then press the right button  twice to set the high temperature parameter directly.
In the tire settings interface, after setting high pressure, low pressure parameter, will display the high temperature interface (68°C), then press the left button  once, the first digit is flashing, then press the right button  to transform digit, when transform to the desired digital number, press the left button  once to confirm, the second digit of high temperature is flashing now, press the right button  to transform digit, when transform to the desired digital number, press the left button  once to confirm, will hear Be... sound, it means the high temperature parameter is set successfully. Then press set button  twice to exit parameters setting, return to normal display interface.



4. Restore to factory setting:
Keep pressing right button  for 3 seconds until hear a be sound to restore to factory setting. The system will clear up all previous settings, and restore to factory settings automatically.

The Driving Test >20KM/H

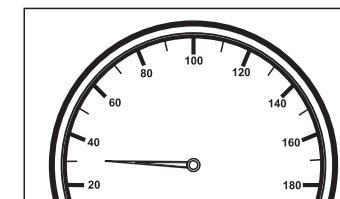

When driving speed is over than 20 KM/H, the display automatically refresh the data

The relevant parameters:
Display working voltage: 12V ± 3V
The default alarm settings:
High Pressure: 43Psi
3.0Bar
Low Pressure: 29Psi
2.0Bar
High Temperature: 68°C
Sensor working voltage: CR1632 Battery 3.0V
Sensor detecting range: 0Psi ~ 50 Psi
0Bar ~ 3.5Bar

Trouble Shootings:

Sensor interface leak gas: Nozzle edge is usually caused by uneven gap

Sensor lost

Buy new sensors from our company, then learn the new code for matching

The battery runs out

Please replace new CR1632 3.0V battery by yourself

Tire conversion processing

Such as the tire replacement position, the sensor must identify the location of their respective housing swap.

Notes and Statement

This product is only suitable for tire pressure within safe 3.5Bar (12V) battery model car; not suitable for use in trucks or 4 wheels with tire pressures over 50psi

Tire safety must not rely on this product;
Should regularly check the tire, make sure the tires pricking, fragmentation, drum kits and other damage.
External sensor battery life is related with car's mileage, working temperature can not exceed -20 ~ +70°C

Internal sensor working temperature range -40°C ~ +100°C

Note: This system can monitor effectively the automobile wheels' tire pressure and temperature, but could not prevent the occurrence of unexpected accidents.

The Company will not be liable for any resulting from the damage of this product caused by direct or indirect losses.

FCC: SY9WST002

Caution: The user is cautioned that changes or modifications not expressly approved by the party responsible for compliance could void the user's authority to operate the equipment.

This device complies with Part 15 of the FCC Rules. Operation is subject to the following two conditions: (1) this device may not cause harmful interference, and (2) this device must accept any interference received, including interference that may cause undesired operation.

NOTE: This equipment has been tested and found to comply with the limits for a Class B digital device, pursuant to Part 15 of the FCC Rules. These limits are designed to provide reasonable protection against harmful interference in a residential installation. This equipment generates, uses and can radiate radio frequency energy and, if not installed and used in accordance with the instructions, may cause harmful interference to radio communications. However, there is no guarantee that interference will not occur in a particular installation. If this equipment does cause harmful interference to radio or television reception, which can be determined by turning the equipment off and on, the user is encouraged to try to correct the interference by one or more of the following measures:

- Reorient or relocate the receiving antenna.
- Increase the separation between the equipment and receiver.
- Connect the equipment into an outlet on a circuit different from that to which the receiver is connected.
- Consult the dealer or an experienced radio/TV technician for help.