





Car Alarm GLC211 Operation & Function Instruction



Transmitter Button Functions

			
Arm	Disarm	Silent (Mute)	Locating & Help

1. In Arm:

Press the button  on the transmitter once, the siren would chirp once, the flash lights would gleam once, the central door locking system would lock up automatically, the power windows would roll up automatically. After 7 seconds, ACC ON and door switches would be detected; After 21 seconds, the shock sensor and the microwave sensor start working. The LED indicator would gleam.







2. Disarm:

- ① Press the button  on the transmitter once, the siren would chirp twice, the flash lights would gleam twice, the central door locking system would unlock automatically. If the door is not opened within 30 seconds, the system would re-arm automatically.
- ② Press the button  on the transmitter once for 2 seconds to release the trunk.

3. Silent (Mute):

Press the button  on the transmitter once, the flash lights would gleam once, the siren doesn't chirp, the central door locking system locks up automatically, power windows roll up, after 21 seconds, the system will be in arm automatically when the LED indicator gleams.

4. Locating:



- ① In arm, press the button  on the transmitter once for 2 seconds, the flash lights would gleam for 15 seconds, and the siren would chirp continuously. Press the button  on the transmitter once again to stop. After that, the system is still in arm status.**
- ② In arm, press the button  on the transmitter once for 2 seconds, the flash lights would gleam for 10 seconds, but the siren would keep silent. Press the button  on the transmitter once again to stop. After that, the system is still in arm status.**
- ② Anytime, press the button  on the transmitter once, the flash lights would gleam for 15 seconds, and the siren would chirp 15 times press the button  on the transmitter again to stop.**

Function Instruction:

1. In arm:

In arm, the system will be triggered while the door is opened by force, the vehicle is hit, bit or towed up, the siren would chirp loudly, the flash lights would gleam, the engine would be cut off. The siren will stop chirping automatically after chirping for 60 seconds / 10 sounds and the system would re-arm again.

2. Re-Arm Automatically (Optional)

When ignition off, all doors are closed, after 30 seconds, The system would be in lock automatically, If not in Arm after 15 seconds, it would be in Arm automatically when the central door locking system locks up. Put the key in the key lock and turn it to ACC/ON, press the button  on the transmitter once for 2 second, the siren would chirp twice and the flash lights would gleams once, it is in Re-Arm status, press the button  on the transmitter for 2 seconds, the siren would chirp once to cancel this function

3. Siren Pause:

The siren would chirp loudly while triggered. Press the button  on the transmitter once to stop the siren chirping but the system is still in arm.

4. Microwave Sensor :

Microwave Sensor: Press the button  on the transmitter once, the siren would chirp once, the flash lights would gleam once. The microwave sensor would start working after 7 seconds.

5. Power Window:

Press the button  on the transmitter once, the siren would chirp once, the flash lights would gleam once. The power window system would be closed one window by one window which time is 20 seconds.

6. Trigger Identification Function:

If triggered by hitting, when arm, the siren would chirp un-continuously for 10 seconds; If triggered by door opening or engine starting, when arm, the siren would chirp continuously for 60 seconds.



7. Central Lock System Automation : (optional)

a. When the vehicle is moving, press the button  or  on the transmitter once to make the central door locking system lock or unlock but the alarm system is not working at the same time.

b. All doors are closed, the car key is put into the key lock and turned to ACC ON position, after 5 seconds, you can press the footbrake once to make the central door locking system lock up.

c. When the car key in the key lock is turned to ACC OFF, the central door locking system would be unlocked for the passengers off conveniently.

When the car key put into key lock and turned to

ACC ON position, press the button  on the transmitter for 2 seconds, the siren would chirp twice, the 7.b. above function is ON; press the button  on the transmitter for 2 seconds again, the siren would chirp once, the 7.b. Above function is OFF.



NOTE: If any door is not closed completely or the car key in the key lock is not turned to ACC ON position, the central door locking system would not lock up automatically.

8. Reminding for Door Unclosed well (Optional):



a. When parked, one of doors is not closed well, and the key is not in the position ACC ON, the flash lights would gleam for 30 seconds to warn the passing vehicles.

B. When parked, one of doors is not closed well, and the key is in the position ACC ON, the flash lights would gleam which could not be stopped to warn the passing vehicles until every door is closed well.

9. Anti-Hijacking: (ACC ON)



When moving, press the button  on the transmitter for 5seconds, the flash lights would gleam urgently, press the button  on the transmitter once again to make the system into Anti-Hijacking status when the flash lights are gleaming quickly and the siren is chirping, after 40 seconds, the engine would cut off. You can press the Reset Switch once to cancel the Anti-Hijacking function.

10. Car Locating:

- a. **Locating by Sound & Light:** in arm, press the button  on the transmitter for 2 seconds, the siren would chirp for 15 seconds, at the same time the flash lights would gleam for 15 seconds also.
- b. **Silently Locating:** in arm, press the button  on the transmitter for 2 seconds, the flash lights would gleam 10 times but the siren would keep silent.

11. Security Re-arm (optional)

After disarm, if any door is not opened or the engine is not be started within 30 seconds, the system will be in arm again.

Press the button  on the transmitter once, the siren would chirp twice and the flash lights gleam once, it is in Re-arm status. Press the button  the transmitter once again, the siren would chirp once to cancel this function.

12. LED Indicator Status:

- a. **In Arm:** LED Indicator is gleaming un-continuously;
- b. **Warning:** LED Indicator is ON

13. Shock Sensor & Microwave Sensor Detecting:

Any hitting, any body invades the car, it will warn by both sound and light.

14. Engine Cut off:

In arm, any trigger would make the engine cut off.

15 . Parking on the Roadside Warning :

For safe, when parked and any door opened, the flash lights would gleam to warn the coming and going vehicles.



16. Intruding Warning:

If it was triggered by door opening, when disarm, the siren would chirp 5 sounds to warn maybe there is some body in the vehicle.

17. Help Calling and Going Ahead:

Press the button  on the transmitter once, the siren would chirp for 15 seconds, and the flash lights would gleam for 15 seconds at the same time, to call help, or to warn when you are going to go ahead the other vehicles.

18 .Car Washing Mode: (Optional)

This mode is for car washing. In this mode, press the button  or  on the transmitter once only to Lock or Unlock and no the other functions at this moment. In the car washing mode, it is impossible to be in arm.

Press the Reset Switch 5 times, be in the vehicle washing mode when the siren chirps twice; Press the Reset Switch 5 times again to cancel the vehicle washing mode and re-arm again when the siren chirps once and the flash lights gleam once.

19. Power off Memory:

When power off and later on again, the system can remember and remain the status before power off which is very important

20.Reset Switch:(ACC-ON)

Usually the Reset Switch is hidid in a enshrouded place. When the remote transmitter is out of work, you can open the door by your car key and press the Reset Switch to override the arming function.

21.Anti Hi-Jacking Switch: (ACC-ON)

Press the valid switch on, if a door is opened and closed again when the external LED indicator is ON, after 90 seconds, the siren chirps loudly, the flash lights gleam and the engine ignition is cut off. You can cancel this warning by pressing the Reset Switch once.

※ Central Door Locking System Time Option:

If it is not electric central lock system and it is pneumatic one, please open the brain cover and change the jumper JP1 on the main PCB from ON to OFF before installing the car alarm, and the central door locking system time would be changed from 0.5 to 3.5 seconds.

※Horn / Siren Option:

Usually it is set for siren off work when JP2 is connected to Power; If JP2 is connected to Ground, it is for horn.

※How to Learn New Code :

- ①Put the car key into the key lock, press the valid switch 5 seconds, the siren would chirp 5 sounds and the LED indicator is ON.**

- ② Press any button on one of the transmitters until the siren chirps twice, finish the first transmitter code learning.**
- 3. Press any button on the second transmitter until the siren chirps 3 times, finish the second transmitter code learning.**
- 4. Press any button on the third transmitter until the siren chirps 4 times, finish the third transmitter code learning.**
- 5. After finished all 4 transmitters code learning, the LED indicator is OFF. Max. 4 transmitters can be learnt code only.**
- 6. You can learn only one transmitter within 10 seconds after the siren chirping finish. Within this 10 seconds, if you don't press any button on the transmitter or take off the car key, code learning is finished.**
- 7. Every time learning code, please learn all 4 transmitters to make the lost remote transmitter (s) un-valued as the old code is covered by the new code.**

Central Lock Wiring Diagram

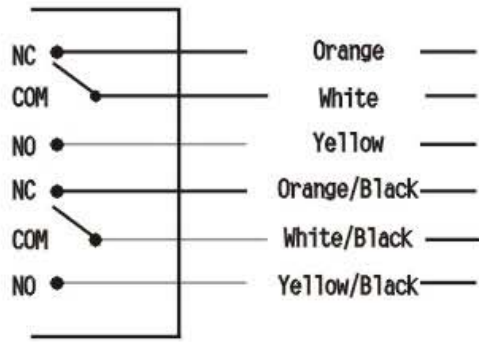

F1: Car Alarm Out-Port

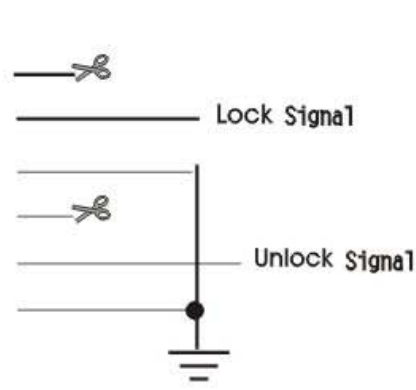

F2: Negative Trigger

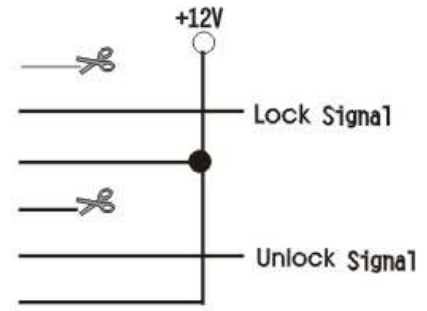

F3: Positive Trigger

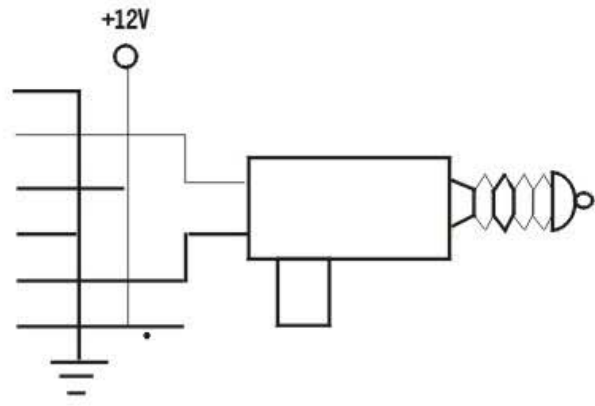

F4: Positive/Negative Trigger

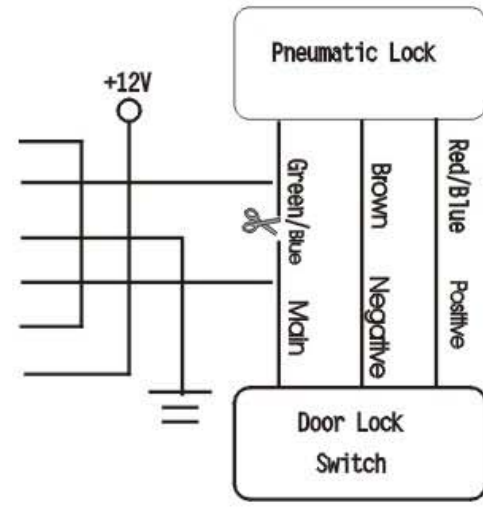

F5: Pneumatic Lock

Car Alarm Installation Instruction

The Brain Installation:

The installation location of the brain usually is installed under the instrument panel or the disguise place where is over the driver's feet in the front of the driver seat. Find the brain installation place first, and then find what the brain will connect to, such as ACC, flash lights, brake light, illumination lights, power, etc.. The wire connection should be made perfect. After all wires connected, connect the sockets by sequence 12p, 3p, 5p, 2p. Before re-assembly the decoration panels step by step, you should check and test the wire connection.

Shock Sensor Installation & Test:

After the brain installation finished, fix the shock sensor on the car. Adjust the sensitivity by the car size and your need. The sensitivity was set by our factory before off work, it is suggested that if not necessary, don't change it .

Shock Sensor Adjustment:

There is a LED in the shock sensor which would flash when the sensor triggered. There is a knob which you can adjust the sensitivity with a driver. Turn to the right H, make the sensitivity higher, turn to the left L, make lower.

The shock sensors should be fixed on the car body or instrument panel as tightly as possible, to ensure the sensors can feel the shock.

Car Alarm Electronic Specification:

A. Car Alarm Brain:

Working Voltage: $12V \pm 2V$

Static Current: 8mA (Exclusive of LED Display)

LED Display Current: 30mA (at Interval)

Shock Sensor Current: $<1 \text{ mA}$

Output Current(max.): Flash Lights: 5AX2

Siren: 10A

Central Lock System: 10A

Working Frequency: 300 ~ 350 MHz or 400~450 MHz

B. Transmitter:

Working Voltage: 12V

Static Current: 0mA

Battery: 12V

Working Frequency: 300 ~ 350 MHz or 400~450 MHz

Trouble Shootings:

- ★ **After the brain fixed in the car, the siren sounded nonstop and could not be stopped by the transmitter.**
 - ⊙ Check the socket connections correct or not.
 - ⊙ Check the wire connections correct or not.
 - ⊙ Check the switch positions correct or not.
 - ⊙ Check the fuses broken or not.
 - ⊙ Check the codes between the transmitter and the brain matched each other or not.
 - ⊙ If you have a spare battery siren, please check the switch positions correct or not.

- ★ **The alarm would be triggered and sound when the car parked on roadside in arm, and there is a heavy duty truck, lorry passed.**
 - ⊙ Check whether the sensitivity of shock sensor is too high.
 - ⊙ Make the sensitivity lower

- ★ **The siren did not sound while the alarm was triggered.**
 - ⊙ Check the siren first.
 - ⊙ Check the wires connection between siren and brain correct or not.

★ **Can't Remote Control by Transmitter and LED not light.**

- ⊙ Check the battery and the voltage measured by voltmeter should be $>10V$.
- ⊙ Whether the battery is released power too much? It is suggested the battery changed annually.
- ⊙ Check the battery holding rusted or not.
- ⊙ Check the transmitter watered or not.
- ⊙ Check the transmitter broken or not.

★ **Can't Remote Control by Transmitter but LED on.**

- ⊙ Check the battery and the voltage measured by voltmeter min. $10V$.
- ⊙ Whether the battery is released power too much?
- ⊙ Check the transmitter frequency changed or not.
- ⊙ Check the transmitter watered or not.
- ⊙ Check the transmitter broken or not.

Note: You can use an OK transmitter instead of the doubted problem one to test and find the Problem. If both can't remote control, please check the brain, wire connection and power. It is not necessary to open the case.

★ **When in arm, the siren would sound within 10 seconds. In arm again after disarm, the same.**

- ◎ Check the shock sensor(s) normal or not.
- ◎ Check the shock sensor whether too sensitive.
- ◎ Check the shock sensor LED indicator.
- ◎ Check the wire connection, especially the brake light and illumination light wire.
- ◎ Check the pin switches

★ **The central lock system can't act normally even no action.**

- ◎ Check the actuators.
- ◎ Check wire connection and fuse. If the fuse broken, there must be installation problem.
- ◎ Check the wire connection again.

Please read the central lock system installation instruction and the diagram again.