

TEST REPORT

OF

FCC Part 15 Subpart C §15.209 /
IC RSS-210, Issue 7 : 2007

FCC ID / IC Certification : SY5CMFNA03/ 267AL-CMFNA03

Equipment Under Test : Smart Key Fob
Model Name : SVI-CMFNA03
Serial No. : N/A
Applicant : Continental Automotive Systems Corporation
Manufacturer : Continental Automotive Systems Corporation
Date of Test(s) : 2009.03.10 ~ 2009.03.26
Date of Issue : 2009.03.27

In the configuration tested, the EUT complied with the standards specified above.

Tested By:



Date

2009.03.27

Grant Lee

Approved By



Date

2009.03.27

Denny Ham

The results shown in this test report refer only to the sample(s) tested unless otherwise stated. This test report cannot be reproduced, except in full, without prior written permission of the Company.

INDEX

<u>TABLE OF CONTENTS</u>	<u>Page</u>
1. General Information -----	3
2. Field Strength of Fundamental -----	6
3. Spurious Emission -----	11
4. Receiver Spurious Emission (Radiated) -----	13
5. Bandwidth of Operation Frequency -----	15
6. Transmission Time -----	17
7. Occupied Bandwidth -----	19
Appendix A. Photo of Field Strength fundamental & Spurious Emission Test	

The results shown in this test report refer only to the sample(s) tested unless otherwise stated. This test report cannot be reproduced, except in full, without prior written permission of the Company.

1. General Information

1.1. Testing Laboratory

SGS Testing Korea Co., Ltd.
 705,Dongchun-dong, Yongin-city, Gyeonggi-Do, Korea 449-840
www.electrolab.kr.sgs.ccom
 Telephone : +82 +31 428 5700
 FAX : +82 +31 427 2371

1.2. Details of Applicant

Applicant : Continental Automotive Systems Corporation
 Address : 29, Siemens-Road, Icheon-City, Gyeonggi-Do, 467-080, Korea
 Contact Person : Jang SungMin
 Phone No. : +82 +31 645 4864
 Fax No. : +82 +31 637 0371

1.3. Description of EUT

Kind of Product	Smart Key Fob
Model Name	SVI-CMFNA03
Serial Number	N/A
Power Supply	DC 3 V
Frequency Range	315 MHz(Tx) 125 kHz(Rx)
Modulation Technique	FSK
Number of Channels	1
Antenna Type	Integral Type (PCB Antenna)

1.4. Details of Modification

-N/A

The results shown in this test report refer only to the sample(s) tested unless otherwise stated. This test report cannot be reproduced, except in full, without prior written permission of the Company.

1.5. Test Equipment List

EQUIPMENT	MANUFACTURER	MODEL	CAL DUE.
Signal Generator	Agilent	E4438C	May 09, 2009
Spectrum Analyzer	Rohde & Schwarz	FSP40	Oct. 01, 2009
Preamplifier	Agilent	8449B	May 09, 2009
Attenuator	Agilent	8494B	May 09, 2009
Test Receiver	Rohde & Schwarz	ESVS10	Mar. 21, 2010
Ultra-Broadband Antenna	Rohde & Schwarz	HL562	Oct. 02, 2009
Horn Antenna	Electro-Metrics	HF906	Nov. 13, 2009
Anechoic Chamber	SY Corporation	L x W x H 9.6 m x 6.4 m x 6.6 m	Jan. 31, 2010

The results shown in this test report refer only to the sample(s) tested unless otherwise stated. This test report cannot be reproduced, except in full, without prior written permission of the Company.

1.6. Summary of Test Results

The EUT has been tested according to the following specifications:

APPLIED STANDARD			
Section in FCC 15 Subpart C §15.209	Section in RSS-210, Issue 7 : 2007	Test Item	Result
15.209(a) 15.231(b)	RSS-210, Issue 7, Table 4	Radiated emission, Spurious Emission and Field Strength of Fundamental	Complied
-	RSS-Gen, Issue 2, 7.2.3	Receiver Spurious Emission (Radiated)	Complied
15.231(c)	RSS-210, Issue 7, A1.1.3	Bandwidth of Operation frequency	Complied
15.231(a)	RSS-210, Issue 7, A1.1.1	Transmission Time	Complied
-	RSS-Gen, Issue 2, 4.6.1	Occupied Bandwidth	Complied

1.7 Test Report Revision

Revision	Report number	Description
0	F690501/RF-RTL002986	Initial

The results shown in this test report refer only to the sample(s) tested unless otherwise stated. This test report cannot be reproduced, except in full, without prior written permission of the Company.

2. Field Strength of Fundamental

2.1. Test Setup

The diagram below shows the test setup that is utilized to make the measurements for emission from 9 kHz to 30 MHz Emissions.

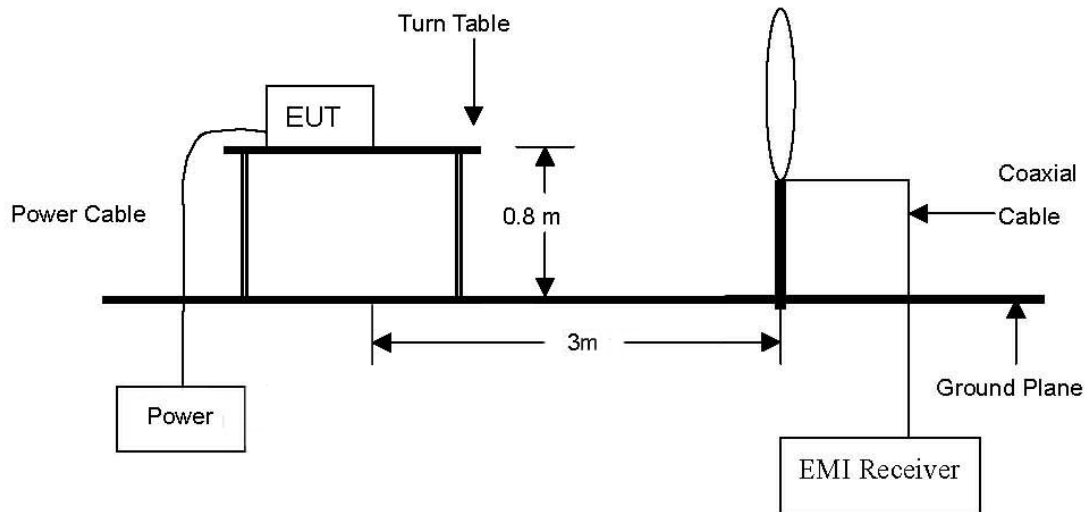

The diagram below shows the test setup that is utilized to make the measurements for emission from 30 MHz to 1 GHz Emissions.

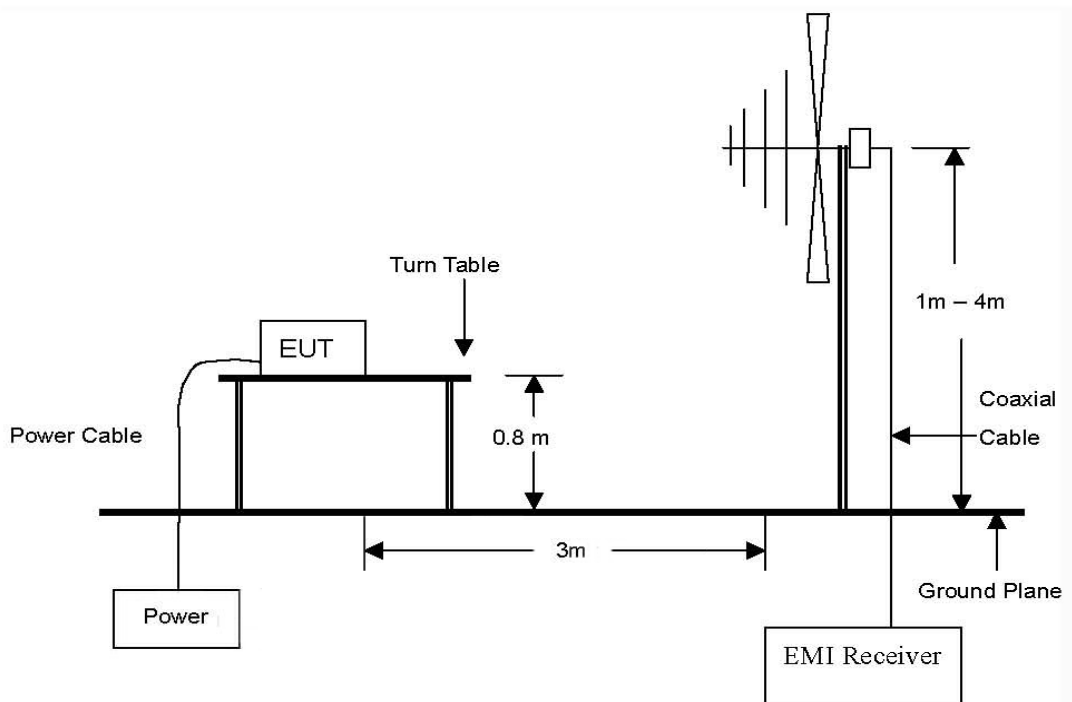

The results shown in this test report refer only to the sample(s) tested unless otherwise stated. This test report cannot be reproduced, except in full, without prior written permission of the Company.

The diagram below shows the test setup that is utilized to make the measurements for emission from 1 GHz to 18 GHz Emissions.

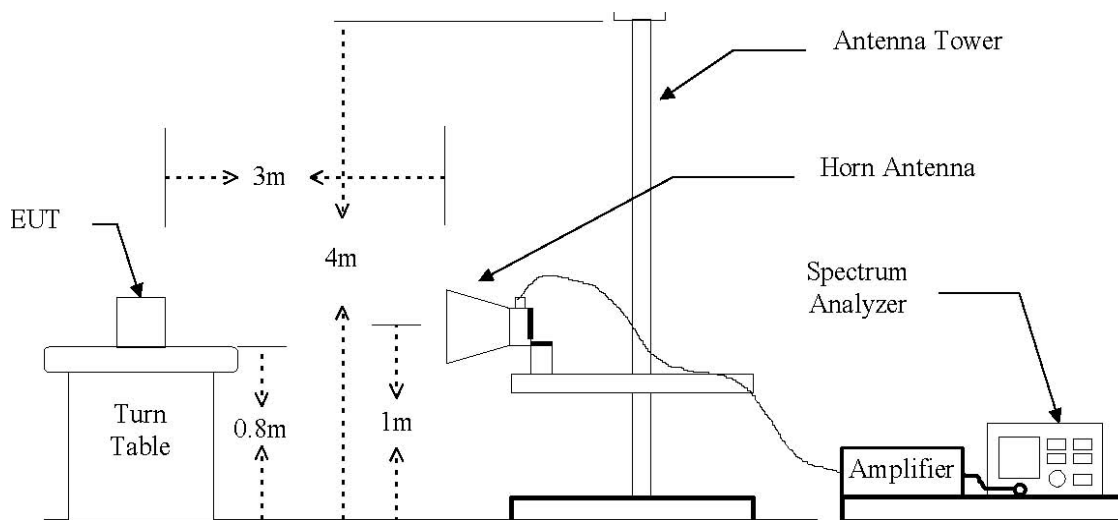

The results shown in this test report refer only to the sample(s) tested unless otherwise stated. This test report cannot be reproduced, except in full, without prior written permission of the Company.

2.2. Limit

2.2.1. Radiated emission limits, general requirements

Except as provided elsewhere in this Subpart, the emissions from an intentional radiator shall not exceed the field strength levels specified in the following table:

Frequency (MHz)	Field Strength (microvolts/meter)	Measurement Distance (meter)
0.009 – 0.490	2400/F(kHz)	300
0.490 – 1.705	2400/F(kHz)	30
1.705 – 30.0	30	30
30 -88	100**	3
88 -216	150**	3
216 - 960	200**	3
Above 960	500	3

** Except as provided in paragraph (g), fundamental emissions from intentional radiators operating under this Section shall not be located in the frequency bands 54-72 MHz, 76-88 MHz, 174-216 MHz or 470-806 MHz. However, operation within these frequency bands is permitted under other sections of this Part, e.g., Sections 15.231 and 15.241

2.2.2. Periodic operation in the band 40.66-40.70 MHz and above 70 MHz

In addition to the provisions of Section 15.205, the field strength of emissions from intentional radiators operated under this Section shall not exceed the following:

Fundamental Frequency (MHz)	Field Strength of Fundamental (microvolts/meter)	Field Strength of Spurious Emissions (microvolts/meter)
40.66 – 47.70	2,250	225
70 - 130	1,250	125
130 – 174	1,250 to 3,750 **	125 to 375 **
174 – 260	3,750	375
260 – 470	3,750 to 12,500 **	375 to 1,250 **
Above 470	12,500	1,250

** linear interpolations

Where F is the frequency in MHz, the formulas for calculating the maximum permitted fundamental field strengths are as follows : for the band 130-174 MHz, uV/m at 3 meters = 56.81818(F)-6136.3636; for the band 260-470 MHz, uV/m at 3 meters = 41.6667(F)-7083.333. The maximum permitted unwanted emission level is 20 dB below the maximum permitted fundamental level.

The results shown in this test report refer only to the sample(s) tested unless otherwise stated. This test report cannot be reproduced, except in full, without prior written permission of the Company.

2.3. Test Procedures

Radiated emissions from the EUT were measured according to the dictates of ANSI C63.4:2003

2.3.1. Test Procedures for emission from 9 kHz to 30 MHz

- a. The EUT was placed on the top of a rotating table 0.8 meters above the ground at a 3 meter anechoic chamber test site. The table was rotated 360 degrees to determine the position of the highest radiation.
- b. Then antenna is a loop antenna is fixed at one meter above the ground to determine the maximum value of the field strength. Both parallel and perpendicular of the antenna are set to make the measurement.
- c. For each suspected emission, the EUT was arranged to its worst case and then the table was turned from 0 degrees to 360 degrees to find the maximum reading.
- d. The test-receiver system was set to Peak Detect Function and Specified Bandwidth with Maximum Hold Mode.

2.3.2. Test Procedures for emission from 30 MHz to 1000 MHz

- a. The EUT was placed on the top of a rotating table 0.8 meters above the ground at a 3 meter anechoic chamber test site. The table was rotated 360 degrees to determine the position of the highest radiation.
- b. During performing radiated emission below 1 GHz, the EUT was set 3 meters away from the interference receiving antenna, which was mounted on the top of a variable-height antenna tower. During performing radiated emission above 1 GHz, the EUT was set 3 meter away from the interference-receiving antenna.
- c. The antenna is a broadband antenna, and its height is varied from one meter to four meters above the ground to determine the maximum value of the field strength. Both horizontal and vertical polarizations of the antenna are set to make the measurement.
- d. For each suspected emission, the EUT was arranged to its worst case and then the antenna was tuned to heights from 1 meter to 4 meters and the table was turned from 0 degrees to 360 degrees to find the maximum reading.
- e. The test-receiver system was set to Peak Detect Function and Specified Bandwidth with Maximum Hold Mode.
- f. If the emission level of the EUT in peak mode was 10 dB lower than the limit specified, then testing could be stopped and the peak values of the EUT would be reported. Otherwise the emissions that did not have 10 dB margin would be re-tested one by one using peak, quasi-peak or average method as specified and then reported in a data sheet.

The results shown in this test report refer only to the sample(s) tested unless otherwise stated. This test report cannot be reproduced, except in full, without prior written permission of the Company.

2.4. Test Result

Ambient temperature : 23 °C Relative humidity : 47 %

The following table shows the highest levels of radiated emissions on both polarizations of horizontal and vertical

Radiated Emissions			Ant	Correction Factors		Total	FCC Limit	
Frequency (MHz)	Reading (dBuV)	Detect Mode	Pol.	Ant. (dB/m)	Cable +Amp (dB)	Actual (dBuV/m)	Limit (dBuV/m)	Margin (dB)
315	82.7	Peak	H	11.33	-25.25	68.78	75.62	6.84

Remark:

To get a maximum emission level from the EUT, the EUT was moved throughout the XY, XZ and YZ planes.

Note:

1. A Peak limit is 20 dB above the average limit.
2. $3m \text{ Limit(dBuV/m)} = 20\log[41.6667(F_{(MHz)})-7083.3333]$
 $= 75.62$

The results shown in this test report refer only to the sample(s) tested unless otherwise stated. This test report cannot be reproduced, except in full, without prior written permission of the Company.

3. Spurious Emission

3.1. Test Setup

Same as section 2.1 of this report

3.2. Limit

Same as section 2.2 of this report

3.3. Test Procedures

Radiated emissions from the EUT were measured according to the dictates of ANSI C63.4:2003

3.3.1. Test Procedures for emission from 9 kHz to 30 MHz

- a. The EUT was placed on the top of a rotating table 0.8 meters above the ground at a 3 meter anechoic chamber test site. The table was rotated 360 degrees to determine the position of the highest radiation.
- b. Then antenna is a loop antenna is fixed at one meter above the ground to determine the maximum value of the field strength. Both parallel and perpendicular of the antenna are set to make the measurement.
- c. For each suspected emission, the EUT was arranged to its worst case and then the table was turned from 0 degrees to 360 degrees to find the maximum reading.
- d. The test-receiver system was set to Peak Detect Function and Specified Bandwidth with Maximum Hold Mode.

3.3.2. Test Procedures for emission from 30 MHz to 1000 MHz

- a. The EUT was placed on the top of a rotating table 0.8 meters above the ground at a 3 meter anechoic chamber test site. The table was rotated 360 degrees to determine the position of the highest radiation.
- b. During performing radiated emission below 1 GHz, the EUT was set 3 meters away from the interference receiving antenna, which was mounted on the top of a variable-height antenna tower. During performing radiated emission above 1 GHz, the EUT was set 3 meter away from the interference-receiving antenna.
- c. The antenna is a broadband antenna, and its height is varied from one meter to four meters above the ground to determine the maximum value of the field strength. Both horizontal and vertical polarizations of the antenna are set to make the measurement.
- d. For each suspected emission, the EUT was arranged to its worst case and then the antenna was tuned to heights from 1 meter to 4 meters and the table was turned from 0 degrees to 360 degrees to find the maximum reading.
- e. The test-receiver system was set to Peak Detect Function and Specified Bandwidth with Maximum Hold Mode.
- f. If the emission level of the EUT in peak mode was 10 dB lower than the limit specified, then testing could be stopped and the peak values of the EUT would be reported. Otherwise the emissions that did not have 10 dB margin would be re-tested one by one using peak, quasi-peak or average method as specified and then reported in a data sheet.

The results shown in this test report refer only to the sample(s) tested unless otherwise stated. This test report cannot be reproduced, except in full, without prior written permission of the Company.

3.4. Test Result

Ambient temperature : 23 °C Relative humidity : 47 %

The following table shows the highest levels of radiated emissions on both polarizations of horizontal and vertical

Radiated Emissions			Ant	Correction Factors		Total	FCC Limit	
Frequency (MHz)	Reading (dBuV)	Detect Mode	Pol.	AF/CL (dB/m)/(dB)	Amp Gain (dB)	Actual (dBuV/m)	Limit (dBuV/m)	Margin (dB)
631.400	38.4	Peak	H	17.61	-25.69	30.32	55.62	25.30
946.650	46.4	Peak	H	21.30	-24.20	43.50	55.62	12.12
Above 950.000	Not detected	-	-	-	-	-	-	-

Remark:

To get a maximum emission level from the EUT, the EUT was moved throughout the XY, XZ and YZ planes.

Note:

1. A Peak limit is 20 dB above the average limit.
2. Other spurious Frequencies were not detected up to 4000 MHz

The results shown in this test report refer only to the sample(s) tested unless otherwise stated. This test report cannot be reproduced, except in full, without prior written permission of the Company.

4. Receiver Spurious Emission (Radiated)

4.1. Test Setup

Same as section 2.1 of this report

4.2. Limit

See below for references

Spurious Frequency (MHz)	Field Strength (microvolt/m at 3 meters)
30 – 88	100
88 – 216	150
216 -960	200
Above 960	500

4.3. Test Procedures

Radiated emissions from the EUT were measured according to the dictates of ANSI C63.4:2003

The results shown in this test report refer only to the sample(s) tested unless otherwise stated. This test report cannot be reproduced, except in full, without prior written permission of the Company.

4.4. Test Result

Ambient temperature : 24 °C Relative humidity : 47%

The following table shows the highest levels of radiated emissions on both polarizations of horizontal and vertical

Radiated Emissions			Ant	Correction Factors		Total	IC Limit	
Frequency (MHz)	Reading (dBuV)	Detect Mode	Pol.	AF/CL (dB/m)/(dB)	Amp Gain (dB)	Actual (dBuV/m)	Limit (dBuV/m)	Margin (dB)
Above 30.000	Not detected	-	-	-	-	-	-	-

Remark:

To get a maximum emission level from the EUT, the EUT was moved throughout the XY, XZ and YZ planes.

Note:

1. Other spurious frequencies were not detected up to 1000 MHz.

The results shown in this test report refer only to the sample(s) tested unless otherwise stated. This test report cannot be reproduced, except in full, without prior written permission of the Company.

5. Bandwidth of Operation Frequency

5.1. Test Setup

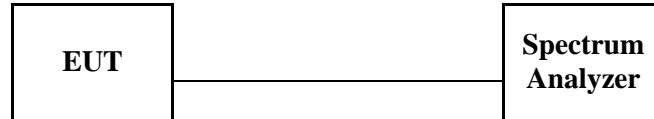

5.2. Limit

The bandwidth of the emission shall be no wider than 0.25% of the center frequency for devices operating above 70 MHz and below 900 MHz. Bandwidth is determined at the points 20 dB down from the modulated carrier.

5.3. Test Procedure

1. The transmitter output is connected to the spectrum analyzer.
2. The bandwidth of the fundamental frequency was measured with the spectrum analyzer using RBW=10 kHz, VBW=10 kHz and Span=1 MHz.
3. The bandwidth of fundamental frequency was measured and recorded.

The results shown in this test report refer only to the sample(s) tested unless otherwise stated. This test report cannot be reproduced, except in full, without prior written permission of the Company.

5.4. Test Result

Ambient temperature : 23 °C Relative humidity : 47 %

Carrier Frequency (MHz)	Bandwidth of the emission (kHz)	Limit (kHz)	Remark
315.00	126	787.50	The point 20 dB down from the modulated carrier

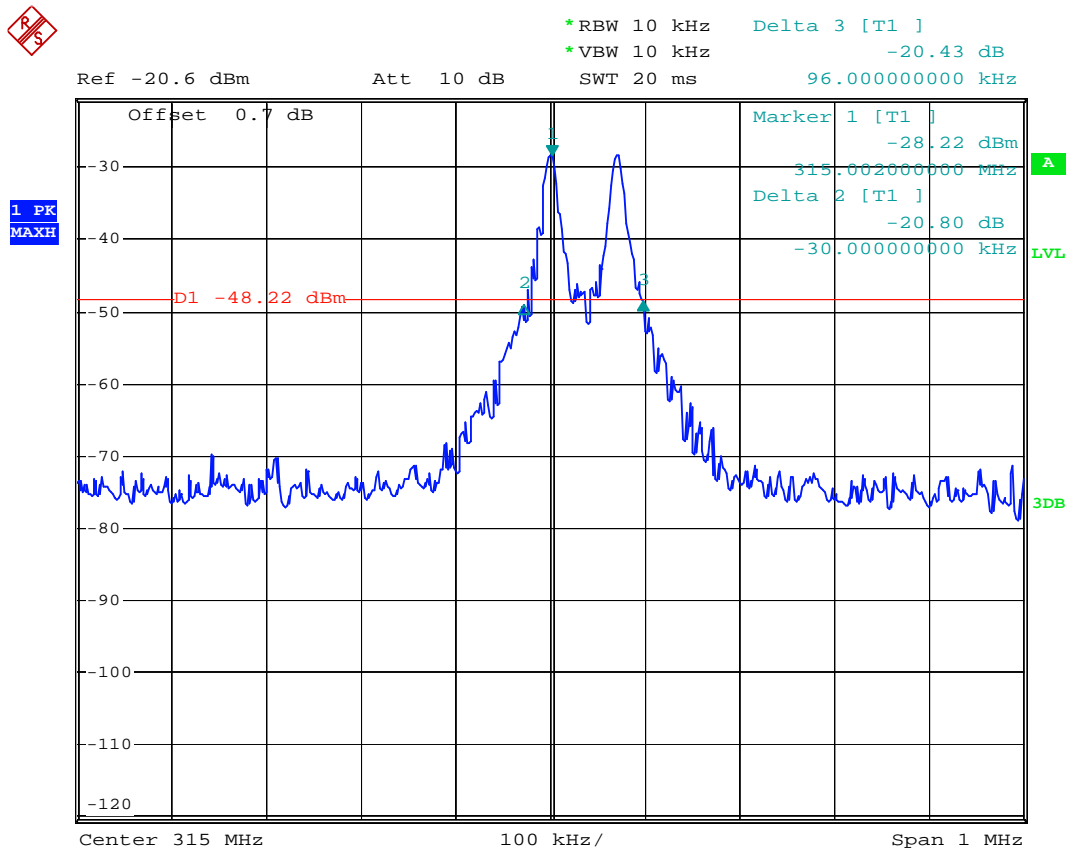

02

Date: 23.MAR.2009 10:26:31

The results shown in this test report refer only to the sample(s) tested unless otherwise stated. This test report cannot be reproduced, except in full, without prior written permission of the Company.

6. Transmission Time

6.1. Test Setup

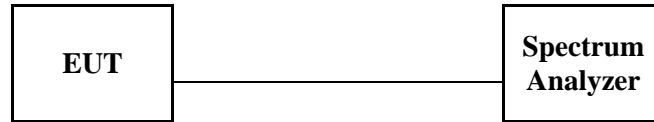

6.2. Limit

A manually operated transmitter shall employ a switch that will automatically deactivate the transmitter within not more than 5 seconds of being released.

6.3. Test Procedure

1. The transmitter output is connected to the spectrum analyzer.
2. The bandwidth of the fundamental frequency was measured with the spectrum analyzer using RBW=1 MHz, VBW=1 MHz, Span=0 Hz, Sweep Time=10 sec
3. The bandwidth of fundamental frequency was measured and recorded.

The results shown in this test report refer only to the sample(s) tested unless otherwise stated. This test report cannot be reproduced, except in full, without prior written permission of the Company.

6.4. Test Result

Ambient temperature : 23 °C Relative humidity : 47 %

Carrier Frequency (MHz)	Transmission Time (sec)	Limit (sec)	Remark
315.00	0.46	Same or less than 5 s	Pass

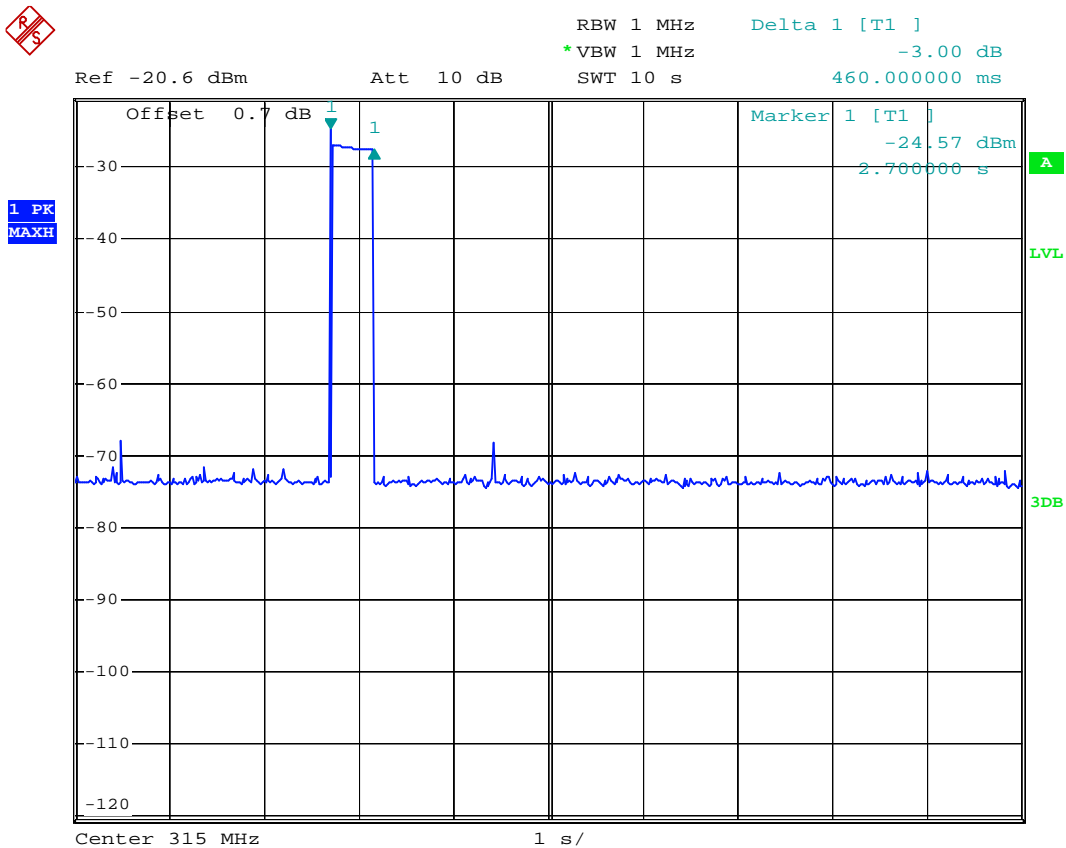

02

Date: 23.MAR.2009 10:29:22

The results shown in this test report refer only to the sample(s) tested unless otherwise stated. This test report cannot be reproduced, except in full, without prior written permission of the Company.

7. Occupied Bandwidth

7.1. Test Setup

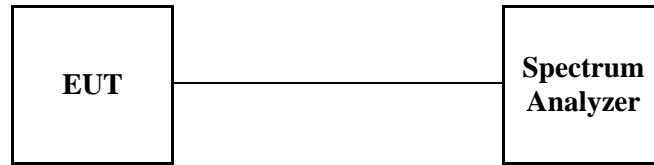

7.2. Limit

None; for reporting purposed only

7.3. Test Procedure

1. The transmitter output is connected to the spectrum analyzer.
2. The bandwidth of the fundamental frequency was measured with the spectrum analyzer using $RBW \geq 1\%$ of Span, VBW to 3 times RBW.
3. The bandwidth of fundamental frequency was measured and recorded.

The results shown in this test report refer only to the sample(s) tested unless otherwise stated. This test report cannot be reproduced, except in full, without prior written permission of the Company.

7.4. Test Result

Ambient temperature : 23 °C Relative humidity : 47 %

Carrier Frequency (MHz)	Occupied Bandwidth (kHz)	Limit (kHz)	Remark
315	114	-	99 % Occupied bandwidth

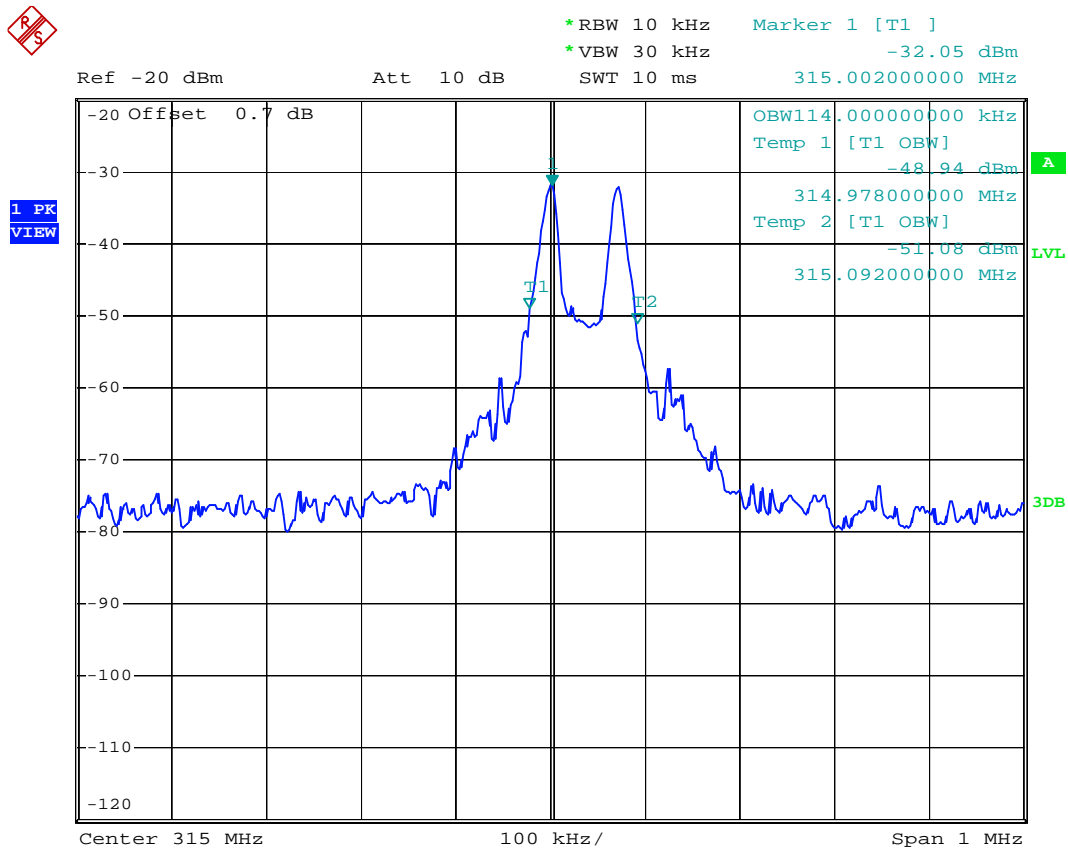

02

Date: 23.MAR.2009 03:57:00

The results shown in this test report refer only to the sample(s) tested unless otherwise stated. This test report cannot be reproduced, except in full, without prior written permission of the Company.