

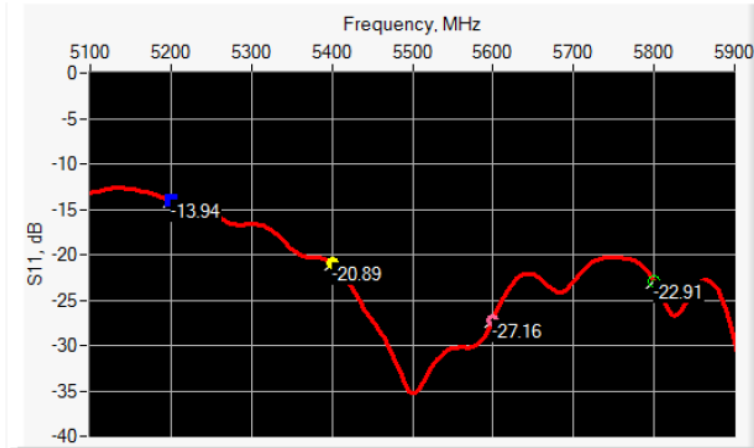

6.2 RETURN LOSS IN BODY LIQUID



Frequency (MHz)	Return Loss (dB)	Requirement (dB)
5000-6000	< -13.94	-8

6.3 MECHANICAL DIMENSIONS

Frequency (MHz)	L (mm)		W (mm)		L _f (mm)		W _f (mm)		T (mm)	
	Requirement	Measure	Requirement	Measure	Requirement	Measure	Requirement	Measure	Requirement	Measure
5200	40.39 ± 0.13	PASS	20.19 ± 0.13	PASS	81.03 ± 0.13	PASS	61.98 ± 0.13	PASS	5.3*	PASS
5800	40.39 ± 0.13	PASS	20.19 ± 0.13	PASS	81.03 ± 0.13	PASS	61.98 ± 0.13	PASS	4.3*	PASS

* The tolerance for the matching layer is included in the return loss measurement.

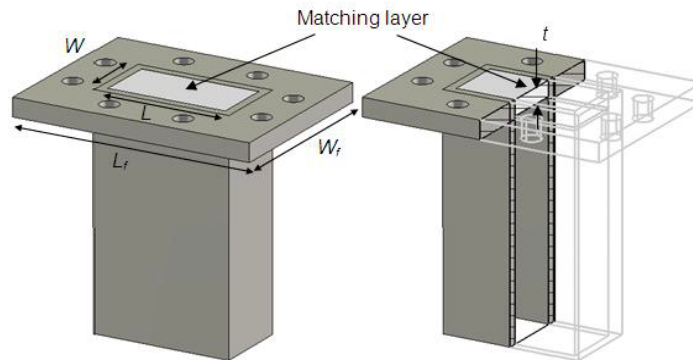

Figure 1: Validation Waveguide Dimensions

7 VALIDATION MEASUREMENT

The IEEE Std. 1528 and CEI/IEC 62209 standards state that the system validation measurements must be performed using a reference waveguide meeting the fore mentioned return loss and mechanical dimension requirements. The validation measurement must be performed with the matching layer placed in the open end of the waveguide, with the waveguide and matching layer in direct contact with the phantom shell.



7.1 HEAD LIQUID MEASUREMENT

Frequency MHz	Relative permittivity (ϵ_r')		Conductivity (σ) S/m	
	required	measured	required	measured
5000	36.2 ±10 %		4.45 ±10 %	
5100	36.1 ±10 %		4.56 ±10 %	
5200	36.0 ±10 %	PASS	4.66 ±10 %	PASS
5300	35.9 ±10 %		4.76 ±10 %	
5400	35.8 ±10 %	PASS	4.86 ±10 %	PASS
5500	35.6 ±10 %		4.97 ±10 %	
5600	35.5 ±10 %	PASS	5.07 ±10 %	PASS
5700	35.4 ±10 %		5.17 ±10 %	
5800	35.3 ±10 %	PASS	5.27 ±10 %	PASS
5900	35.2 ±10 %		5.38 ±10 %	
6000	35.1 ±10 %		5.48 ±10 %	

7.2 SAR MEASUREMENT RESULT WITH HEAD LIQUID

At those frequencies, the target SAR value can not be generic. Hereunder is the target SAR value defined by MVG, within the uncertainty for the system validation. All SAR values are normalized to 1 W net power. In bracket, the measured SAR is given with the used input power.

Software	OPENSAR V4
Phantom	SN 20/09 SAM71
Probe	SN 18/11 EPG122
Liquid	Head Liquid Values 5200 MHz: ϵ_s' :36.62 σ : 4.93 Head Liquid Values 5400 MHz: ϵ_s' :35.95 σ : 5.18 Head Liquid Values 5600 MHz: ϵ_s' :36.08 σ : 5.60 Head Liquid Values 5800 MHz: ϵ_s' :34.73 σ : 5.74
Distance between dipole waveguide and liquid	0 mm
Area scan resolution	dx=8mm/dy=8mm
Zoon Scan Resolution	dx=4mm/dy=4m/dz=2mm
Frequency	5200 MHz 5400 MHz 5600 MHz 5800 MHz
Input power	20 dBm
Liquid Temperature	21 °C
Lab Temperature	21 °C
Lab Humidity	45 %



SAR REFERENCE WAVEGUIDE CALIBRATION REPORT

Ref: ACR.256.12.15.SATU.A

Frequency (MHz)	1 g SAR (W/kg)		10 g SAR (W/kg)	
	required	measured	required	measured
5200	159.00	163.88 (16.39)	56.90	57.29 (5.73)
5400	166.40	172.23 (17.22)	58.43	59.16 (5.92)
5600	173.80	181.28 (18.13)	59.97	61.57 (6.16)
5800	181.20	188.95 (18.90)	61.50	63.45 (6.35)

SAR MEASUREMENT PLOTS @ 5200 MHz

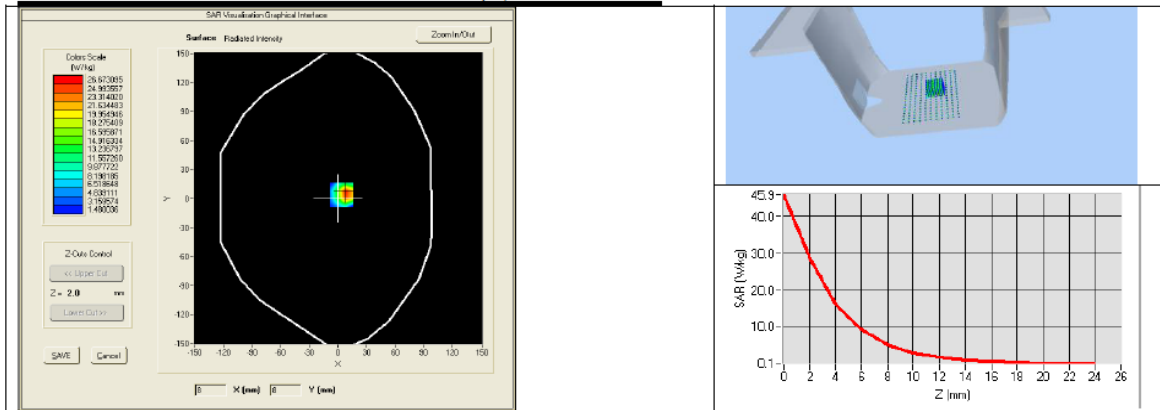

SAR MEASUREMENT PLOTS @ 5400 MHz

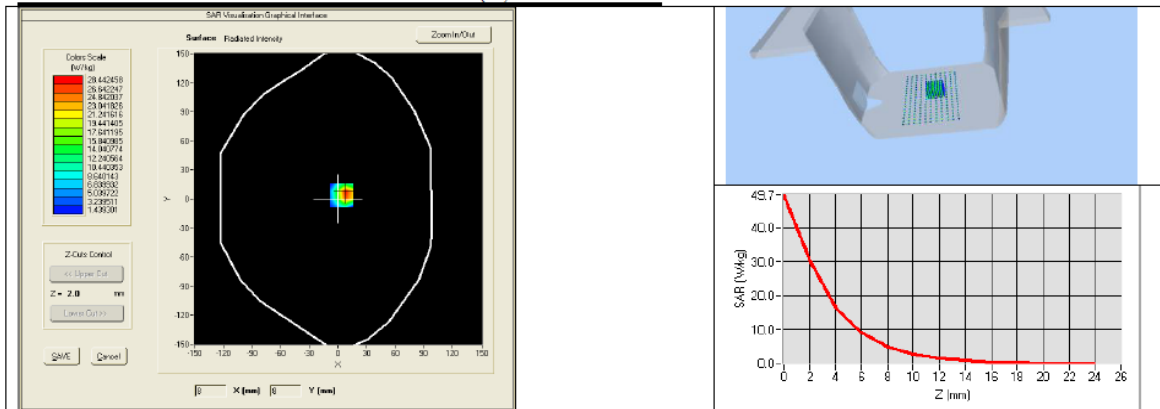

This document shall not be reproduced, except in full or in part, without the written approval of MVG. The information contained herein is to be used only for the purpose for which it is submitted and is not to be released in whole or part without written approval of MVG.



SAR REFERENCE WAVEGUIDE CALIBRATION REPORT

Ref: ACR.256.12.15.SATU.A

SAR MEASUREMENT PLOTS @ 5600 MHz

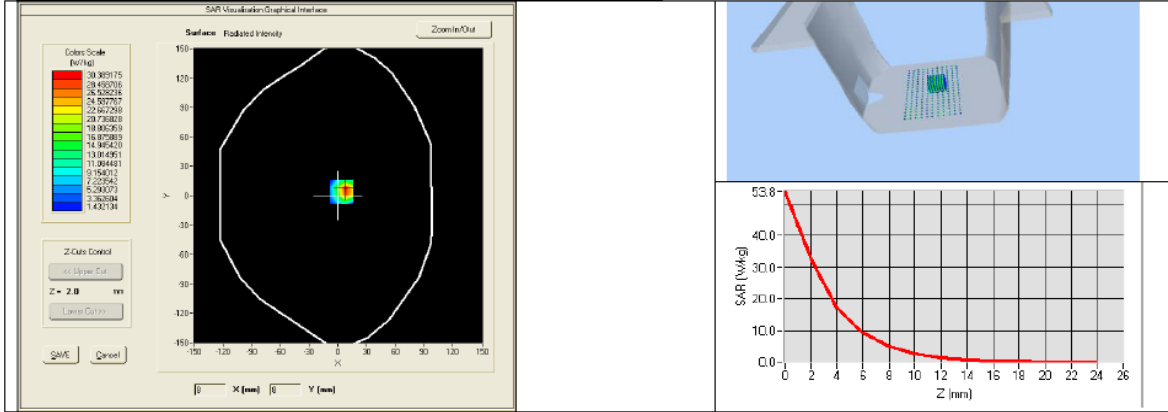

SAR MEASUREMENT PLOTS @ 5800 MHz

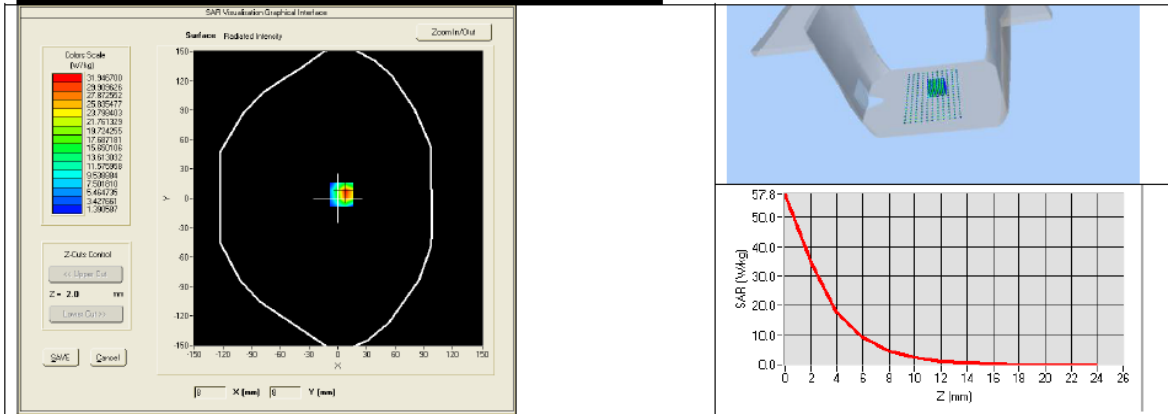



7.3 BODY LIQUID MEASUREMENT

Frequency MHz	Relative permittivity (ϵ_r')		Conductivity (σ) S/m	
	required	measured	required	measured
5200	49.0 \pm 10 %	PASS	5.30 \pm 10 %	PASS
5300	48.9 \pm 10 %		5.42 \pm 10 %	
5400	48.7 \pm 10 %	PASS	5.53 \pm 10 %	PASS
5500	48.6 \pm 10 %		5.65 \pm 10 %	
5600	48.5 \pm 10 %	PASS	5.77 \pm 10 %	PASS
5800	48.2 \pm 10 %	PASS	6.00 \pm 10 %	PASS

7.4 SAR MEASUREMENT RESULT WITH BODY LIQUID

Software	OPENSAR V4
Phantom	SN 20/09 SAM71
Probe	SN 18/11 EPG122
Liquid	Body Liquid Values 5200 MHz: ϵ_r' :50.69 σ : 4.98 Body Liquid Values 5400 MHz: ϵ_r' :48.45 σ : 5.82 Body Liquid Values 5600 MHz: ϵ_r' :50.57 σ : 6.37 Body Liquid Values 5800 MHz: ϵ_r' :48.19 σ : 6.45
Distance between dipole waveguide and liquid	0 mm
Area scan resolution	dx=8mm/dy=8mm
Zoon Scan Resolution	dx=4mm/dy=4m/dz=2mm
Frequency	5200 MHz 5400 MHz 5600 MHz 5800 MHz
Input power	20 dBm
Liquid Temperature	21 °C
Lab Temperature	21 °C
Lab Humidity	45 %

Frequency (MHz)	1 g SAR (W/kg) measured	10 g SAR (W/kg) measured
5200	158.49 (15.85)	55.40 (5.54)
5400	167.20 (16.72)	57.39 (5.74)
5600	175.65 (17.57)	59.48 (5.95)
5800	183.06 (18.31)	61.62 (6.16)



BODY SAR MEASUREMENT PLOTS @ 5200 MHz

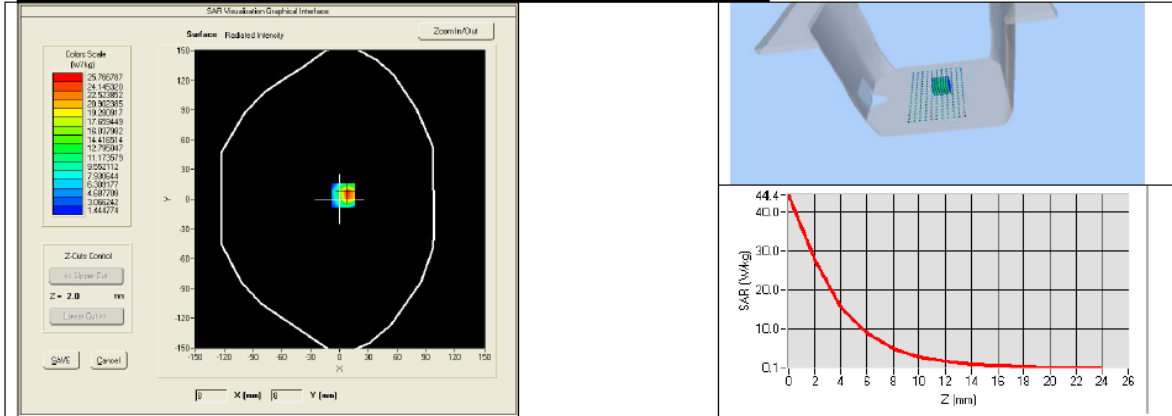

BODY SAR MEASUREMENT PLOTS @ 5400 MHz

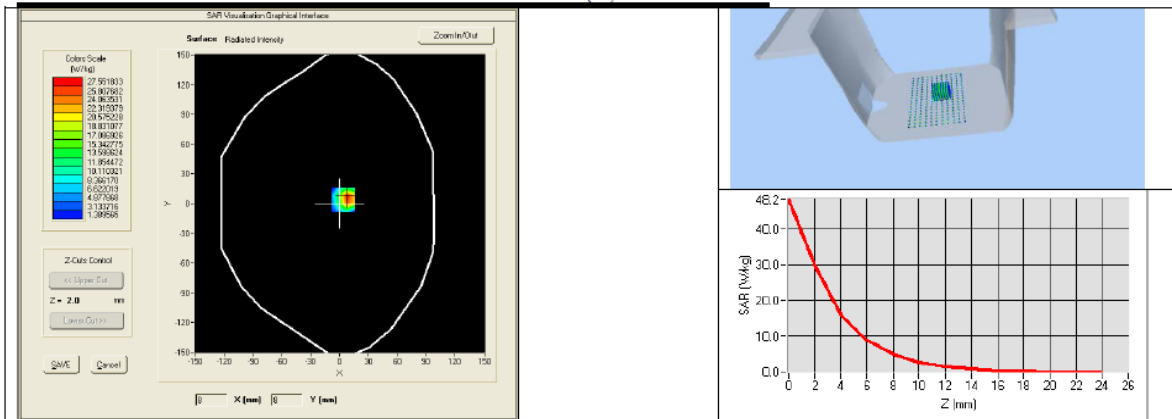

BODY SAR MEASUREMENT PLOTS @ 5600 MHz

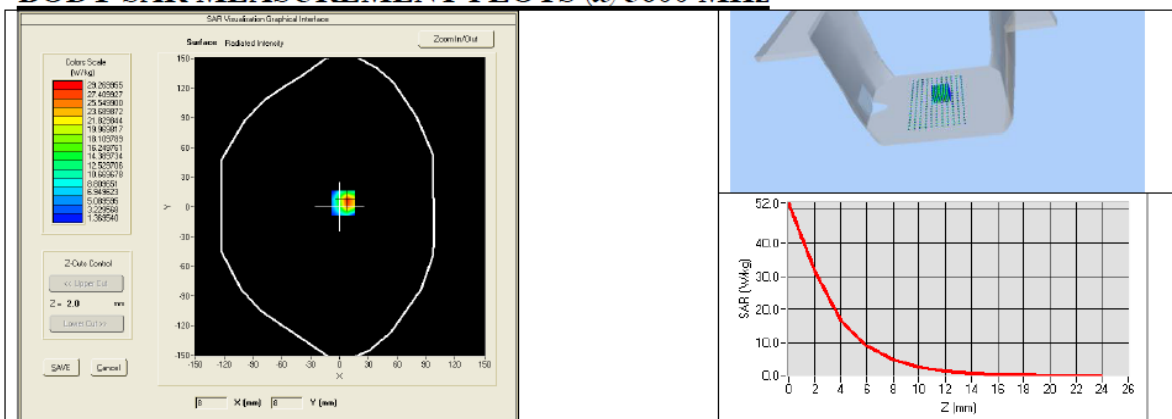



BODY SAR MEASUREMENT PLOTS @ 5800 MHz

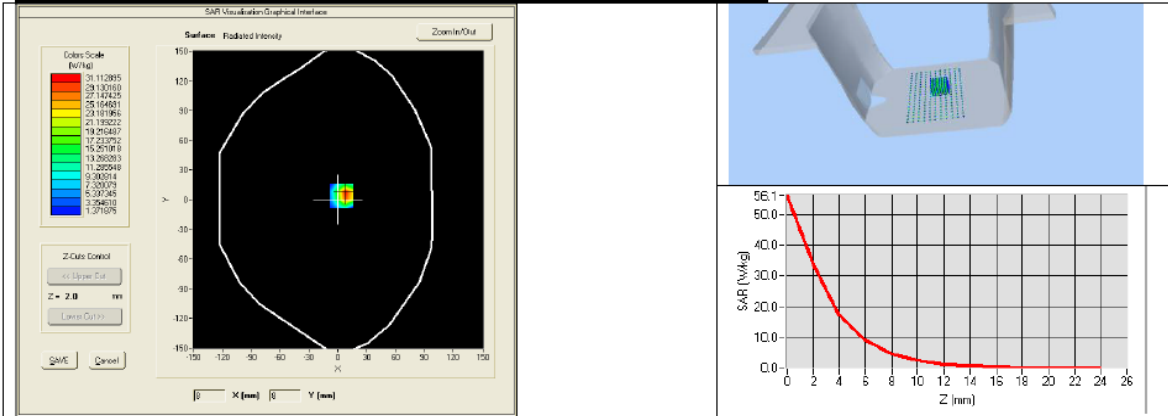



8 LIST OF EQUIPMENT

Equipment Summary Sheet				
Equipment Description	Manufacturer / Model	Identification No.	Current Calibration Date	Next Calibration Date
Flat Phantom	MVG	SN-20/09-SAM71	Validated. No cal required.	Validated. No cal required.
COMOSAR Test Bench	Version 3	NA	Validated. No cal required.	Validated. No cal required.
Network Analyzer	Rhode & Schwarz ZVA	SN100132	02/2019	02/2022
Calipers	Carrera	CALIPER-01	01/2020	01/2023
Reference Probe	MVG	EPG122 SN 18/11	10/2021	10/2022
Multimeter	Keithley 2000	1188656	01/2020	01/2023
Signal Generator	Agilent E4438C	MY49070581	01/2020	01/2023
Amplifier	Aethercomm	SN 046	Characterized prior to test. No cal required.	Characterized prior to test. No cal required.
Power Meter	HP E4418A	US38261498	01/2020	01/2023
Power Sensor	HP ECP-E26A	US37181460	01/2020	01/2023
Directional Coupler	Narda 4216-20	01386	Characterized prior to test. No cal required.	Characterized prior to test. No cal required.
Temperature and Humidity Sensor	Control Company	150798832	10/2021	10/2022

Appendix E: SAR SYSTEM VALIDATION

Per FCC KDB 865664 D02v01, SAR system validation status should be documented to confirm measurement accuracy. The SAR systems (including SAR probes, system components and software versions) used for this device were validated against its performance specifications prior to the SAR measurements. Reference dipoles were used with the required tissue- equivalent media for system validation, according to the procedures outlined in FCC KDB 865664 D01 v01 and IEEE 1528-2013. Since SAR probe calibrations are frequency dependent, each probe calibration point was validated at a frequency within the valid frequency range of the probe calibration point, using the system that normally operates with the probe for routine SAR measurements and according to the required tissue-equivalent media.

A tabulated summary of the system validation status including the validation date(s), measurement frequencies, SAR probes and tissue dielectric parameters has been included.

SAR System Validation Summary

Date	Freq. [MHz]	Probe S/N	Tissue type	COND. PERM.	COND. PERM.	CW Validation			Mod. Validation		
				(σ)	(ϵ_r)	sensitivity	Probe linearity	Probe isotropy	Mod. type	Duty factor	Peak to average power ratio
10/08/2021	835	SN 36/20 EPGO 346	Head	42.3	0.89	PASS	PASS	PASS	GMSK	PASS	N/A
10/08/2021	1800	SN 36/20 EPGO 346	Head	40.57	1.36	PASS	PASS	PASS	GMSK	PASS	N/A
10/08/2021	1900	SN 36/20 EPGO 346	Head	40.31	1.38	PASS	PASS	PASS	GMSK	PASS	N/A
10/08/2021	2450	SN 36/20 EPGO 346	Head	38.99	1.88	PASS	PASS	PASS	OFDM	PASS	N/A
10/08/2021	2600	SN 36/20 EPGO 346	Head	39.00	1.96	PASS	PASS	PASS	OFDM	PASS	N/A
10/08/2021	5G	SN 41/18 EPGO 331	Head	36.68	4.45 ~ 5.08	PASS	PASS	PASS	OFDM	PASS	N/A

10/09/2021	835	SN 36/20 EPGO3 46	Body	55.13	0.95	PASS	PASS	PASS	GMSK	PASS	N/A
10/09/2021	1800	SN 36/20 EPGO3 46	Body	53.60	1.50	PASS	PASS	PASS	GMSK	PASS	N/A
10/09/2021	1900	SN 36/20 EPGO3 46	Body	53.11	1.56	PASS	PASS	PASS	GMSK	PASS	N/A
10/09/2021	2450	SN 36/20 EPGO3 46	Body	52.10	2.01	PASS	PASS	PASS	OFDM	PASS	N/A
10/09/2021	2600	SN 36/20 EPGO3 46	Body	52.50	2.16	PASS	PASS	PASS	OFDM	PASS	N/A
10/09/2021	5G	SN 36/20 EPGO3 46	Body	48.94	1.92~ 5.95	PASS	PASS	PASS	OFDM	PASS	N/A

NOTE: While the probes have been calibrated for both a CW and modulated signals, all measurements were performed using communication systems calibrated for CW signals only. Modulations in the table above represent test configurations for which the measurement system has been validated per FCC KDB Publication 865664 D01v01 for scenarios when CW probe calibrations are used with other signal types. SAR systems were validated for modulated signals with a periodic duty cycle, such as OFDM according to KDB 865664.

Appendix F: The Check Data of Impedance and Return Loss

The information are included in the SAR report to qualify for the three-year extended calibration interval;

Impedance in head liquid							Date: 10/08/2021
Freq. (MHz)	Temp (°C)	Dipole Impedance Re(z)			Dipole Impedance Im(z)		
		measured	Target	$\Delta (\pm 5\Omega)$	measured	Target	$\Delta (\pm 5\Omega)$
835	22	52.30	51.60	0.7	2.30	1.70	0.6
1800	22	46.50	48.60	-2.1	0.60	-0.50	1.1
1900	22	50.30	51.70	-1.4	4.20	4.90	-0.7
2450	22	45.90	46.50	-0.6	-0.36	-0.20	-0.1
2600	22	54.70	55.10	-0.4	5.00	5.10	-0.1
5G	22	36.06	35.30	0.76	4.44	5.27	-0.83

Impedance in body liquid							Date: 10/09/2021
Freq. (MHz)	Temp (°C)	Dipole Impedance Re(z)			Dipole Impedance Im(z)		
		measured	Target	$\Delta (\pm 5\Omega)$	measured	Target	$\Delta (\pm 5\Omega)$
835	22	49.3	47.1	2.2	6.3	5.60	0.7
1800	22	46.5	47.2	-0.7	-6.1	-5.10	-1.0
1900	22	50.3	48.1	2.2	5.3	6.40	-1.1
2450	22	45.9	48.7	-2.8	0.6	-1.90	2.5
2600	22	52.3	51.8	0.5	5.7	5.5	0.2
5G	22	49.02	50.01	-0.99	5.52	5.70	-0.18

Return loss in head liquid				Date: 10/08/2021
Freq. (MHz)	Temp (°C)	Return loss(dB)		
		measured	Target	$\Delta (\pm 20\%)$
835	22	-30.35	-32.78	-7.41
1800	22	-37.89	-36.92	2.63
1900	22	-24.33	-25.64	-5.11
2450	22	-30.95	-29.05	6.54
2600	22	-22.01	-22.81	-3.51
5G	22	-21.87	-22.80	0.93

Return loss in body liquid				Date: 10/09/2021
Freq. (MHz)	Temp (°C)	Return loss(dB)		
		measured	Target	Δ ($\pm 20\%$)
835	22	-25.99	-23.99	8.34
1800	22	-23.66	-24.67	-4.09
1900	22	-21.65	-23.50	-7.87
2450	22	-34.65	-32.86	5.45
2600	22	-23.56	-24.71	-4.65
5G	22	-32.66	-34.56	1.90

liquid	Freq. (MHz)	Temp (°C)	ϵ_r / relative permittivity			σ (s/m) / conductivity			ρ (kg/m ³)
			measured	Target	Δ ($\pm 5\%$)	measured	Target	Δ ($\pm 5\%$)	
Head	835	22	42.30	41.50	1.93	0.89	0.90	-1.11	1000
	1800	22	40.50	40.00	1.25	1.36	1.40	-2.86	1000
	1900	22	40.31	40.00	0.78	1.38	1.40	-1.43	1000
	2450	22	38.99	39.20	-0.54	1.88	1.80	4.44	1000
	2600	22	38.85	39.00	-0.38	1.93	1.96	-1.53	1000
	5G	22	36.06	35.30	0.76	4.44	5.27	-0.83	1000
Body	835	22	55.13	55.20	-0.13	0.95	0.97	-2.06	1000
	1800	22	53.60	53.30	0.56	1.50	1.52	-1.32	1000
	1900	22	53.11	53.30	-0.36	1.56	1.52	2.63	1000
	2450	22	52.10	52.70	-1.14	2.01	1.95	4.00	1000
	2600	22	52.31	52.50	-0.36	2.12	2.16	-1.85	1000
	5G	22	49.02	50.01	-0.99	5.52	5.70	-0.18	1000

Test Equipment	Manufacturer	Model	Serial Number	Calibration	
				Calibration Date (D.M.Y)	Calibration Due (D.M.Y)
Signal Generator	Agilent	N5182A	MY47070282	Jul. 08, 2021	Jul. 07, 2022
Multimeter	Keithley	Multimeter 2000	4078275	Jul. 08, 2021	Jul. 07, 2022
Network Analyzer	Agilent	8753E	US38432457	Jul. 08, 2021	Jul. 07, 2022
Power Meter	Agilent	E4418B	GB43312526	Jul. 08, 2021	Jul. 07, 2022
Power Sensor	Agilent	E9301A	MY41497725	Jul. 08, 2021	Jul. 07, 2022
Power Amplifier	PE	PE15A4019	112342	N/A	N/A
Temperature / Humidity Sensor	Control company	TH101B	152470214	Jul. 08, 2021	Jul. 07, 2022

*******END OF REPORT*******