

# SAR EVALUATION REPORT

For

## Shanghai Huace Navigation Technology LTD.

Building C, 599 Gaojing Road, Qingpu District, Shanghai, China

**FCC ID: SY4-B01008**

<b>Report Type:</b> Original Report	<b>Product Type:</b> Data Collector
<b>Report Number:</b>	RSH170303051-20B
<b>Report Date:</b>	2017-07-25
<b>Reviewed By:</b>	Oscar Ye RF Leader 
<b>Prepared By:</b>	Bay Area Compliance Laboratories Corp. (Kunshan) No.248 Chenghu Road, Kunshan, Jiangsu province, China. Tel: +86-0512-86175000 Fax: +86-0512-88934268 <a href="http://www.baclcorp.com.cn">www.baclcorp.com.cn</a>

Attestation of Test Results			
<b>EUT Information</b>	<b>Company Name</b>	Shanghai Huace Navigation Technology LTD.	
	<b>EUT Description</b>	Data Collector	
	<b>Model Number</b>	LT600	
	<b>Multiple Number</b>	LT600 WXYZ(WXYZ=0-9, a-z)	
	<b>FCC ID</b>	SY4-B01008	
	<b>Test Date</b>	2017-06-08 and 2017-06-09	
<b>MODE</b>		<b>Max. SAR Level(s) Reported(W/Kg)</b>	<b>Limit (W/Kg)</b>
<b>GSM 850</b>	1g Body SAR	1.15	<b>1.6</b>
<b>LTE Band 7</b>	1g Body SAR	1.08	
<b>Simultaneous</b>	1g Body SAR	1.55	
	1g Body SAR	1.55 (Hotspot)	

<b>Applicable Standards</b>	<b>FCC 47 CFR part 2.1093</b> Radiofrequency radiation exposure evaluation: portable devices
	<b>IEEE1528:2013</b> IEEE Recommended Practice for Determining the Peak Spatial-Average Specific Absorption Rate (SAR) in the Human Head from Wireless Communications Devices: Measurement Techniques
	<b>IEC 62209-2:2010</b> Human exposure to radio frequency fields from hand-held and body-mounted wireless communication devices-Human models, instrumentation, and procedures-Part 2: Procedure to determine the specific absorption rate (SAR) for wireless communication devices used in close proximity to the human body (frequency range of 30 MHz to 6 GHz)
	<b>KDB procedures</b> KDB 447498 D01 General RF Exposure Guidance v06. KDB 865664 D01 SAR measurement 100 MHz to 6 GHz v01r04 KDB 865664 D02 RF Exposure Reporting v01r02 KDB 616217 D04 SAR for laptop and tablets v01r02 KDB 941225 D01 3G SAR Procedures v03r01 KDB 941225 D05 SAR for LTE Devices v02r05 KDB 941225 D06 Hotspot Mode v02r01
<p><b>Note:</b> This wireless device has been shown to be capable of compliance for localized specific absorption rate (SAR) for General Population/Uncontrolled Exposure limits specified in ANSI/IEEE Standards and has been tested in accordance with the measurement procedures specified in IEEE 1528-2013 and RF exposure KDB procedures.</p> <p><b>The results and statements contained in this report pertain only to the device(s) evaluated.</b></p>	

## TABLE OF CONTENTS

**DOCUMENT REVISION HISTORY .....4**

**EUT DESCRIPTION .....5**

TECHNICAL SPECIFICATION .....5

**REFERENCE, STANDARDS, AND GUIDELINES .....6**

SAR LIMITS .....7

**FACILITIES .....8**

POWER REFERENCE MEASUREMENT .....9

AREA SCAN .....9

ZOOM SCAN .....10

POWER DRIFT MEASUREMENT .....10

Z-SCAN .....10

**DESCRIPTION OF TEST SYSTEM .....11**

**EQUIPMENT LIST AND CALIBRATION .....16**

EQUIPMENTS LIST & CALIBRATION INFORMATION .....16

**SAR MEASUREMENT SYSTEM VERIFICATION .....17**

LIQUID VERIFICATION .....17

**EUT TEST STRATEGY AND METHODOLOGY .....21**

SAR EVALUATION PROCEDURE .....23

**CONDUCTED OUTPUT POWER MEASUREMENT .....24**

PROVISION APPLICABLE .....24

TEST PROCEDURE .....24

**SAR MEASUREMENT RESULTS .....33**

**MEASUREMENT UNCERTAINTY .....40**

**DOCUMENT REVISION HISTORY**

---

<b>Revision Number</b>	<b>Report Number</b>	<b>Description of Revision</b>	<b>Date of Revision</b>
0	RSH170303051-20B	Original Report	2017-07-25

## EUT DESCRIPTION

This report has been prepared on behalf of Shanghai Huace Navigation Technology LTD. and their product, FCC ID: SY4-B01008, Model: LT600 or the EUT (Equipment under Test) as referred to in the rest of this report.

### Note:

1. The device is capable of personal Body mode. WLAN Body mode permits the device to share its cellular data connection with other 2.4 GHz WLAN enabled devices.
2. All measurement and test data in this report was gathered from production sample serial number: 17030305107 (Assigned by BAACL, Kunshan). The EUT supplied by the applicant was received on 2017-03-27.
3. This series products model: LT600 and LT600 WXYZ(WXYZ=0-9, a-z), we select model: LT600 to test, there is no electrical change has been made to the equipment, please refer to the product similarity letter.

## Technical Specification

<b>Product Type</b>	Portable
<b>Exposure Category:</b>	Population / Uncontrolled
<b>Antenna Type(s):</b>	Internal Antenna
<b>Body-Worn Accessories:</b>	Headset
<b>Face-Head Accessories:</b>	None
<b>Multi-slot Class:</b>	Class12
<b>Operation Mode :</b>	GSM Voice, GPRS/EGPRS Data, LTE WLAN Bluetooth
<b>Frequency Band:</b>	GSM 850 : 824-849 MHz(TX) ; 869-894 MHz(RX) LTE Band 7: 2500-2570 MHz(TX) ; 2620-2690 MHz(RX) WLAN: 2412MHz-2462 MHz/2422-2452 MHz Bluetooth:2402-2480MHz
<b>Dimensions (L*W*H):</b>	235 mm (L) × 140 mm (W) × 22 mm (H)
<b>Power Source:</b>	3.8V <sub>DC</sub> Rechargeable Battery
<b>Normal Operation:</b>	Body-Supported

---

## REFERENCE, STANDARDS, AND GUIDELINES

---

### **FCC:**

The Report and Order requires routine SAR evaluation prior to equipment authorization of portable transmitter devices, including portable telephones. For portable devices, the RF radiation exposure evaluation requirement was provided in part 2.1093. According to KDB447498 D01 “General RF Exposure Guidance”, the device should be evaluated at maximum output power (radiated from the antenna) under “worst-case” conditions for normal or intended use, incorporating normal antenna operating positions, device peak performance frequencies and positions for maximum RF energy coupling.

This report describes the methodology and results of experiments performed on wireless data terminal. The objective was to determine if there is RF radiation and if radiation is found, what is the extent of radiation with respect to safety limits. SAR (Specific Absorption Rate) is the measure of RF exposure determined by the amount of RF energy absorbed by human body (or its parts) – to determine how the RF energy couples to the body or head which is a primary health concern for body worn devices.

### **CE:**

The order requires routine SAR evaluation prior to equipment authorization of portable transmitter devices, including portable telephones. For portable devices, the limitation of exposure of the general public to electromagnetic fields was recommended on Council Recommendation 1999/519/EC. According to the Standard IEC62209-1/2, the device should be evaluated at maximum output power (radiated from the antenna) under “worst-case” conditions for normal or intended use, incorporating normal antenna operating positions, device peak performance frequencies and positions for maximum RF energy coupling.

This report describes the methodology and results of experiments performed on wireless data terminal. The objective was to determine if there is RF radiation and if radiation is found, what is the extent of radiation with respect to safety limits. SAR (Specific Absorption Rate) is the measure of RF exposure determined by the amount of RF energy absorbed by human body (or its parts) – to determine how the RF energy couples to the body or head which is a primary health concern for body portable devices.

The test configurations were laid out on a specially designed test fixture to ensure the reproducibility of measurements. Each configuration was scanned for SAR. Analysis of each scan was carried out to characterize the above effects in the device.

**SAR Limits**

FCC Limit (1g Tissue)

EXPOSURE LIMITS	SAR (W/kg)	
	(General Population / Uncontrolled Exposure Environment)	(Occupational / Controlled Exposure Environment)
Spatial Average (averaged over the whole body)	0.08	0.4
Spatial Peak (averaged over any 1 g of tissue)	1.60	8.0
Spatial Peak (hands/wrists/feet/ankles averaged over 10 g)	4.0	20.0

CE Limit (10g Tissue)

EXPOSURE LIMITS	SAR (W/kg)	
	(General Population / Uncontrolled Exposure Environment)	(Occupational / Controlled Exposure Environment)
Spatial Average (averaged over the whole body)	0.08	0.4
Spatial Peak (averaged over any 10 g of tissue)	2.0	10
Spatial Peak (hands/wrists/feet/ankles averaged over 10 g)	4.0	20.0

Population/Uncontrolled Environments are defined as locations where there is the exposure of individual who have no knowledge or control of their exposure.

Occupational/Controlled Environments are defined as locations where there is exposure that may be incurred by people who are aware of the potential for exposure (i.e. as a result of employment or occupation).

## **FACILITIES**

---

The test site used by Bay Area Compliance Laboratories Corp. (Kunshan) to collect test data is located on No.248 Chenghu Road, Kunshan, Jiangsu province, China.



## DASY4 SAR Evaluation Procedure

### Power Reference Measurement

The Power Reference Measurement and Power Drift Measurement jobs are useful jobs for monitoring the power drift of the device under test in the batch process. Both jobs measure the field at a specified reference position, at a selectable distance from the phantom surface. The reference position can be either the selected section's grid reference point or a user point in this section. The reference job projects the selected point onto the phantom surface, orients the probe perpendicularly to the surface, and approaches the surface using the selected detection method. The Minimum distance of probe sensors to surface determines the closest measurement point to phantom surface. By default, the Minimum distance of probe sensors to surface is 4mm. This distance can be modified by the user, but cannot be smaller than the Distance of sensor calibration points to probe tip as defined in the probe properties.

### Area Scan

The Area Scan is used as a fast scan in two dimensions to find the area of high field values, before doing a finer measurement around the hot spot. The sophisticated interpolation routines implemented in DASY4 software can find the maximum locations even in relatively coarse grids.

The scanning area is defined by an editable grid. This grid is anchored at the grid reference point of the selected section in the phantom. When the Area Scan's property sheet is brought-up, grid settings can be edited by a user.

When an Area Scan has measured all reachable points, it computes the field maxima found in the scanned area, within a range of the global maximum. The range (in dB) is specified in the standards for compliance testing. For example, a 2 dB range is required in IEEE 1528-2013, IEC 62209-1:2006 and IEC 62209-2:2010 standards, whereby 3 dB is a requirement when compliance is assessed in accordance with the ARIB standard (Japan). If only one Zoom Scan follows the Area Scan, then only the absolute maximum will be taken as reference. For cases where multiple maximums are detected, the number of Zoom Scans has to be increased accordingly.

After measurement is completed, all maxima and their coordinates are listed in the Results property page. The maximum selected in the list is highlighted in the 3-D view. For the secondary maxima returned from an Area Scan, the user can specify a lower limit (peak SAR value), in addition to the Find secondary maxima within x dB condition. Only the primary maximum and any secondary maxima within x dB from the primary maximum and above this limit will be measured.

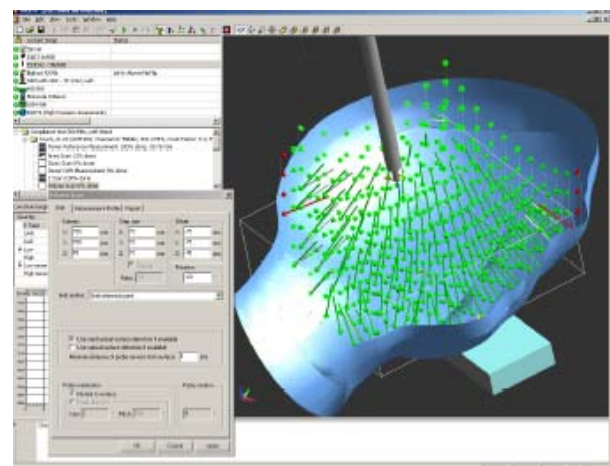
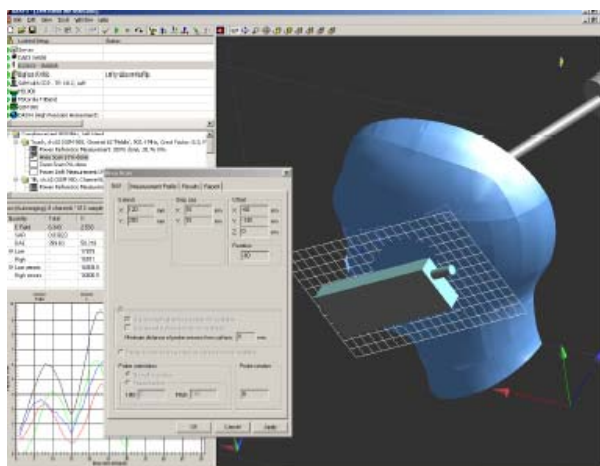

## Zoom Scan

Zoom Scans are used to assess the peak spatial SAR values within a cubic averaging volume containing 1 g and 10 g of simulated tissue. The default Zoom Scan measures 5 x 5 x 7 points within a cube whose base faces are centered around the maxima found in a preceding area scan job within the same procedure. When the measurement is done, the Zoom Scan evaluates the averaged SAR for 1 g and 10 g and displays these values next to the job's label.

## Power drift measurement

The Power Drift Measurement job measures the field at the same location as the most recent power reference measurement job within the same procedure, and with the same settings. The Power Drift Measurement gives the field difference in dB from the reading conducted within the last Power Reference Measurement. Several drift measurements are possible for one reference measurement. This allows a user to monitor the power drift of the device under test within a batch process. The measurement procedure is the same as Step 1.

## Z-Scan

The Z Scan job measures points along a vertical straight line. The line runs along the Z axis of a one-dimensional grid. A user can anchor the grid to the section reference point, to any defined user point or to the current probe location. As with any other grids, the local Z axis of the anchor location establishes the Z axis of the grid.

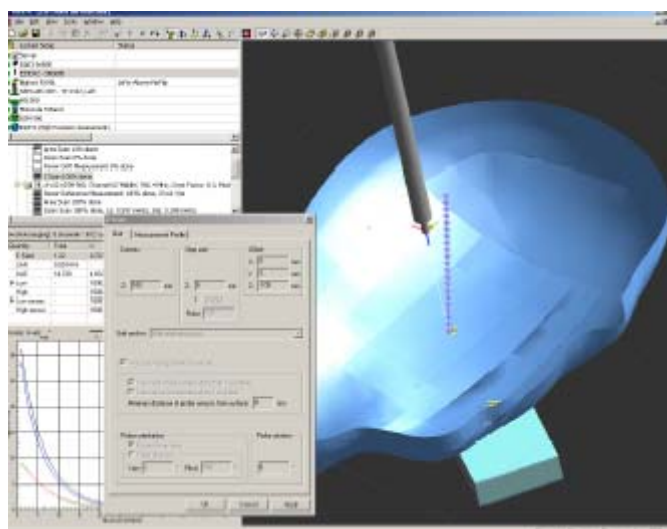

## DESCRIPTION OF TEST SYSTEM

These measurements were performed with the automated near-field scanning system DASY4 from Schmid & Partner Engineering AG (SPEAG) which is the Fifth generation of the system shown in the figure hereinafter:



### DASY4 System Description

The DASY4 system for performing compliance tests consists of the following items:

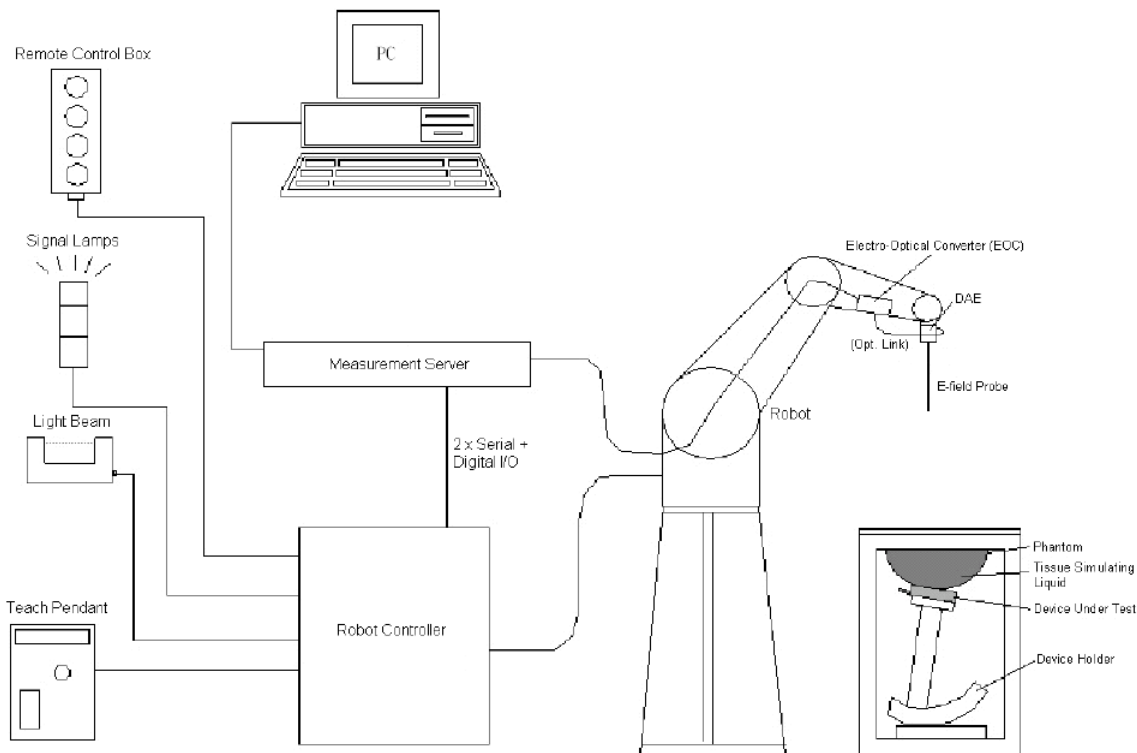

- A standard high precision 6-axis robot (Staubli TX=RX family) with controller, teach pendant and software. An arm extension for accommodating the data acquisition electronics (DAE).
- An isotropic field probe optimized and calibrated for the targeted measurement.
- A data acquisition electronics (DAE) which performs the signal amplification, signal multiplexing, AD-conversion, offset measurements, mechanical surface detection, collision detection, etc. The unit is battery powered with standard or rechargeable batteries. The signal is optically transmitted to the EOC.
- The Electro-optical converter (EOC) performs the conversion from optical to electrical signals for the digital communication to the DAE. To use optical surface detection, a special version of the EOC is required. The EOC signal is transmitted to the measurement server.
- The function of the measurement server is to perform the time critical tasks such as signal filtering, control of the robot operation and fast movement interrupts.
- The Light Beam used is for probe alignment. This improves the (absolute) accuracy of the probe positioning.
- A computer running Win7 professional operating system and the DASY42 software.
- Remote control and teach pendant as well as additional circuitry for robot safety such as warning lamps, etc.
- The phantom, the device holder and other accessories according to the targeted measurement.

### DASY4 Measurement Server

The DASY4 measurement server is based on a PC/104 CPU board with a 400MHz intel ULV Celeron, 128MB chip-disk and 128MB RAM. The necessary circuits for communication with the DAE4 (or DAE3) electronics box, as well as the 16 bit AD converter system for optical detection and digital I/O interface are contained on the DASY4 I/O board, which is directly connected to the PC/104 bus of the CPU board.



The measurement server performs all real-time data evaluation of field measurements and surface detection, controls robot movements and handles safety operation. The PC operating system cannot interfere with these time critical processes. All connections are supervised by a watchdog, and disconnection of any of the cables to the measurement server will automatically disarm the robot and disable all program-controlled robot movements. Furthermore, the measurement server is equipped with an expansion port which is reserved for future applications. Please note that this expansion port does not have a standardized point out, and therefore only devices provided by SPEAG can be connected. Devices from any other supplier could seriously damage the measurement server.

### Data Acquisition Electronics

The data acquisition electronics (DAE4) consist of a highly sensitive electrometer-grade preamplifier with auto-zeroing, a channel and gain-switching multiplexer, a fast 16 bit AD-converter and a command decoder with a control logic unit. Transmission to the measurement server is accomplished through an optical downlink for data and status information, as well as an optical uplink for commands and the clock.

The mechanical probe mounting device includes two different sensor systems for frontal and sideways probe contacts. They are used for mechanical surface detection and probe collision detection.

The input impedance of both the DAE4 as well as of the DAE3 box is 200M $\Omega$ ; the inputs are symmetrical and floating. Common mode rejection is above 80 dB.

**EX3DV4 E-Field Probes**

<b>Frequency</b>	10 MHz to > 6 GHz Linearity: ± 0.2 dB (30 MHz to 6 GHz)
<b>Directivity</b>	± 0.3 dB in TSL (rotation around probe axis) ± 0.5 dB in TSL (rotation normal to probe axis)
<b>Dynamic Range</b>	10 µW/g to > 100 mW/g Linearity: ± 0.2 dB (noise: typically < 1 µW/g)
<b>Dimensions</b>	Overall length: 337 mm (Tip: 20 mm) Tip diameter: 2.5 mm (Body: 12 mm) Typical distance from probe tip to dipole centers: 1 mm
<b>Application</b>	High precision dosimetric measurements in any exposure scenario (e.g., very strong gradient fields); the only probe that enables compliance testing for frequencies up to 6 GHz with precision of better 30%.
<b>Compatibility</b>	DASY3, DASY4, DASY42 SAR and higher, EASY4/MRI

**SAM Twin Phantom**

The SAM twin phantom is a fiberglass shell phantom with 2mm shell thickness (except the ear region, where shell thickness increases to 6 mm). The phantom has three measurement areas:

- \_ Left hand
- \_ Right hand
- \_ Flat phantom

The phantom table for the DASY systems based on the TX90XL and RX60L robots have the size of 100 x 50 x 85 cm (L xWx H). The phantom table for the compact DASY systems based on the RX60L robot have the size of 100 x 75 x 91 cm (L xWx H); these tables are reinforced for mounting of the robot onto the table.



For easy dislocation these tables have fork lift cut outs at the bottom.

The bottom plate contains three pairs of bolts for locking the device holder. The device holder positions are adjusted to the standard measurement positions in the three sections. Only one device holder is necessary if two phantoms are used (e.g., for different liquids)

A white cover is provided to cover the phantom during o\_-periods to prevent water evaporation and changes in the liquid parameters. Free space scans of devices on top of this phantom cover are possible.

Three reference marks are provided on the phantom counter. These reference marks are used to teach the absolute phantom position relative to the robot.

## Robots

The DASY4 system uses the high precision industrial robots RX90XL from Staubli SA (France). The TX robot family is the successor of the well known RX robot family and offers the same features important for our application:

- High precision (repeatability 0.02mm)
- High reliability (industrial design)
- Low maintenance costs (virtually maintenance free due to direct drive gears; no belt drives)
- Jerk-free straight movements (brushless synchron motors; no stepper motors)
- Low ELF interference (motor control fields shielded via the closed metallic construction shields)

The above mentioned robots are controlled by the Staubli CS8c robot controllers. All information regarding the use and maintenance of the robot arm and the robot controller is contained on the CDs delivered along with the robot. Paper manuals are available upon request direct from Staubli.

## Area Scans

Area scans are defined prior to the measurement process being executed with a user defined variable spacing between each measurement point (integral) allowing low uncertainty measurements to be conducted. Scans defined for FCC applications utilize a 10mm<sup>2</sup> step integral, with 1mm interpolation used to locate the peak SAR area used for zoom scan assessments.

Where the system identifies multiple SAR peaks (which are within 25% of peak value) the system will provide the user with the option of assessing each peak location individually for zoom scan averaging.

## Zoom Scan (Cube Scan Averaging)

The averaging zoom scan volume utilized in the DASY4 software is in the shape of a cube and the side dimension of a 1 g or 10 g mass is dependent on the density of the liquid representing the simulated tissue. A density of 1000 kg/m<sup>3</sup> is used to represent the head and body tissue density and not the phantom liquid density, in order to be consistent with the definition of the liquid dielectric properties, i.e. the side length of the 1 g cube is 10mm, with the side length of the 10 g cube 21,5mm.

When the cube intersects with the surface of the phantom, it is oriented so that 3 vertices touch the surface of the shell or the center of a face is tangent to the surface. The face of the cube closest to the surface is modified in order to conform to the tangent surface.

The zoom scan integer steps can be user defined so as to reduce uncertainty, but normal practice for typical test applications (including FCC) utilize a physical step of 5x5x8 (8mmx8mmx5mm) providing a volume of 32mm<sup>3</sup> in the X & Y axis, and 35mm in the Z axis.



### Tissue Dielectric Parameters for Head and Body Phantoms

The head tissue dielectric parameters recommended by the IEEE SCC-34/SC-2 in P1528 have been incorporated in the following table. These head parameters are derived from planar layer models simulating the highest expected SAR for the dielectric properties and tissue thickness variations in a human head. Other head and body tissue parameters that have not been specified in P1528 are derived from the tissue dielectric parameters computed from the 4-Cole-Cole equations described in Reference [12] and extrapolated according to the head parameters specified in P1528.

#### Recommended Tissue Dielectric Parameters for Head and Body

Frequency (MHz)	Head Tissue		Body Tissue	
	$\epsilon_r$	$\sigma$ (S/m)	$\epsilon_r$	$\sigma$ (S/m)
150	52.3	0.76	61.9	0.80
300	45.3	0.87	58.2	0.92
450	43.5	0.87	56.7	0.94
835	41.5	0.90	55.2	0.97
900	41.5	0.97	55.0	1.05
915	41.5	0.98	55.0	1.06
1450	40.5	1.20	54.0	1.30
1610	40.3	1.29	53.8	1.40
1800-2000	40.0	1.40	53.3	1.52
2450	39.2	1.80	52.7	1.95
3000	38.5	2.40	52.0	2.73
5800	35.3	5.27	48.2	6.00

## EQUIPMENT LIST AND CALIBRATION

### Equipments List & Calibration Information

Equipment	Model	S/N	Calibration Date	Calibration Due Date
DASY4 Test Software	DASY4.5	N/A	N/A	N/A
DASY4 Measurement Server	DASY 4.5.12	1180	N/A	N/A
Data Acquisition Electronics	DAE4	772	2016/10/25	2017/10/24
E-Field Probe	EX3DV4	7382	2016/10/26	2017/10/25
Dipole, 835 MHz	D835V2	453	2015/08/17	2018/08/16
Dipole, 2600 MHz	D2600V2	1132	2016/11/10	2019/11/09
Mounting Device	SD 000 H01 KA	N/A	N/A	N/A
Twin SAM	Twin SAM V5.0	1909	N/A	N/A
Simulated Tissue 835 MHz Body	TS-835-B	N/A	Each Time	/
Simulated Tissue 2600 MHz Body	TS-2600-B	N/A	Each Time	/
Network Analyzer	8753B	3625A00809	2017/01/23	2018/01/22
S-Parameter Test Set	85047A	3033A02428	2016/10/06	2017/10/05
Dielectric probe kit	85070B	US33020324	N/A	N/A
Signal Generator	SMBV100A	261558	2016/07/04	2017/07/03
Wideband Radio Communication Test	CMU200	103113	2016/11/11	2017/11/10
Wideband Radio Communication Tester	CMW500	1201.002K50-116218-UY	2016/09/08	2017/09/07
Power Meter	N1912A	MY5000492	2016/11/17	2017/11/16
Power Sensor	N1921A	MY54210024	2016/11/17	2017/11/16
Power Amplifier	10S1G4M1	18060	N/A	N/A
Directional Coupler	488Z	N/A	N/A	N/A
Attenuator	20dB, 100W	N/A	N/A	N/A
Attenuator	3dB, 150W	N/A	N/A	N/A



# SAR MEASUREMENT SYSTEM VERIFICATION

## Liquid Verification

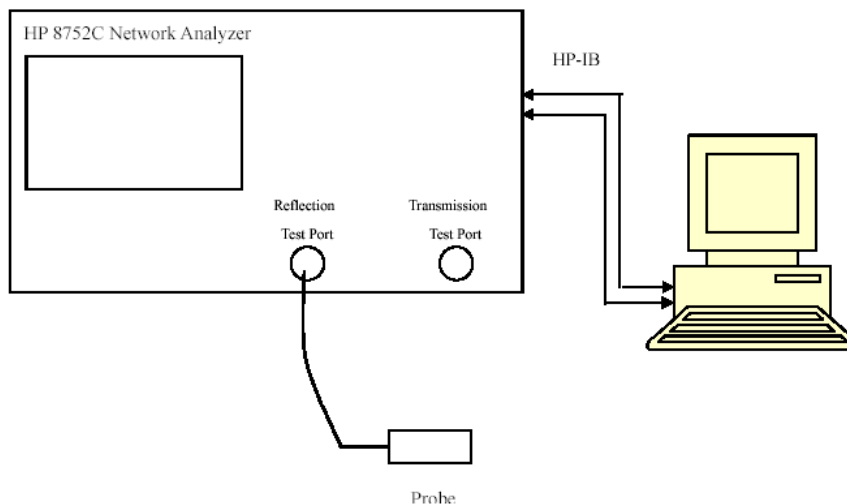

Liquid Verification Setup Block Diagram

## Liquid Verification Results

Frequency (MHz)	Liquid Type	Liquid Parameter		Target Value		Delta (%)		Tolerance (%)
		$\epsilon_r$	$\sigma$ (S/m)	$\epsilon_r$	$\sigma$ (S/m)	$\Delta\epsilon_r$	$\Delta\sigma$ (S/m)	
824.2	Simulated Tissue 835MHz Body	54.87	0.98	55.20	0.97	-0.598	1.031	±5
835	Simulated Tissue 835MHz Body	54.95	0.99	55.20	0.97	-0.453	2.062	±5
836.6	Simulated Tissue 835MHz Body	55.02	0.99	55.20	0.97	-0.326	2.062	±5
848.8	Simulated Tissue 835MHz Body	55.13	1.00	55.20	0.98	-0.127	2.041	±5

\*Liquid Verification was performed on 2017-06-08.

Frequency (MHz)	Liquid Type	Liquid Parameter		Target Value		Delta (%)		Tolerance (%)
		$\epsilon_r$	$\sigma$ (S/m)	$\epsilon_r$	$\sigma$ (S/m)	$\Delta\epsilon_r$	$\Delta\sigma$ (S/m)	
2510	Simulated Tissue 2600MHz Body	52.33	2.09	52.62	2.04	-0.551	2.451	±5
2535	Simulated Tissue 2600MHz Body	52.68	2.12	52.59	2.07	0.171	2.415	±5
2560	Simulated Tissue 2600MHz Body	51.86	2.17	52.56	2.11	-1.332	2.844	±5
2600	Simulated Tissue 2600MHz Body	51.37	2.20	52.51	2.16	-2.171	1.852	±5

\*Liquid Verification was performed on 2017-06-09.

### System Accuracy Verification

Prior to the assessment, the system validation kit was used to test whether the system was operating within its specifications of  $\pm 10\%$ . The validation results are tabulated below. And also the corresponding SAR plot is attached as well in the SAR plots files.

### System Verification Setup Block Diagram

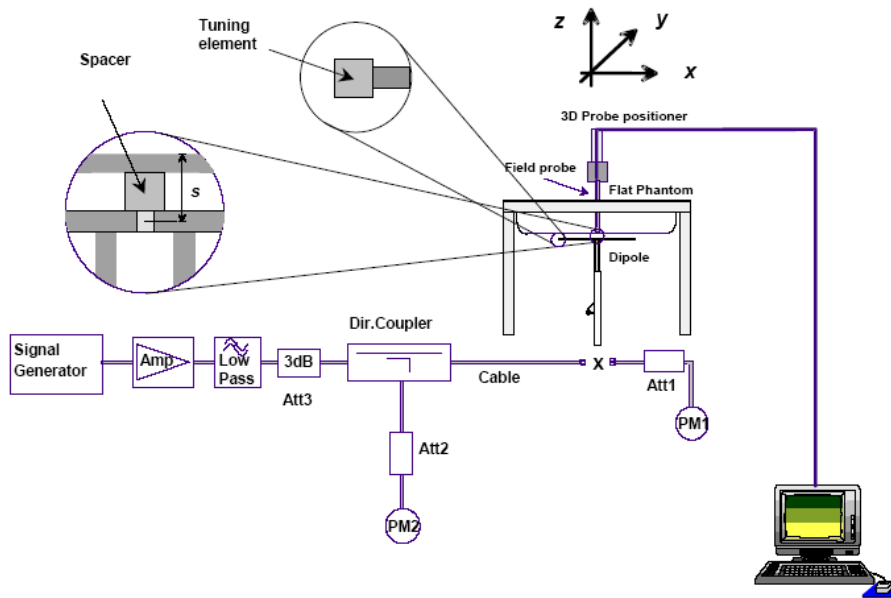

### System Accuracy Check Results

Date	Frequency Band	Liquid Type	Measured SAR (W/Kg)		Target Value (W/Kg)	Delta (%)	Tolerance (%)
2017-06-08	835	Body	1g	9.67	9.55	1.257	$\pm 10$
2017-06-09	2600	Body	1g	55.9	53.9	3.711	$\pm 10$

**Note:**

The power inputted to dipole is 0.1 Watt; the SAR values are normalized to 1 Watt forward power by multiplying 10 times.

**SAR SYSTEM VALIDATION DATA**

**DUT: Dipole 835 MHz; Type: D835V2; S/N: 453**

Communication System: CW; Frequency: 835 MHz; Duty Cycle: 1:1

Medium parameters used:  $f = 835 \text{ MHz}$ ;  $\sigma = 0.99$ ;  $\epsilon_r = 54.95$ ;  $\rho = 1000 \text{ kg/m}^3$

Phantom section: Flat Section

DASY4 Configuration:

- Probe: EX3DV4 – SN7382; ConvF(10.54, 10.54, 10.54); Calibrated: 26/10/2016
- Sensor-Surface: 4mm (Mechanical Surface Detection)
- Electronics: DAE – SN772; Calibrated: 25/10/2016
- Phantom: TWIN SAM; Type: Twin SAM V5.0; Serial: 1909
- Measurement SW: DASY4, V4.5 Build 19; Postprocessing SW: SEMCAD, V1.8 Build 145

**835 Body system check /Area Scan (91x121x1):** Measurement grid:  $dx=10\text{mm}$ ,  $dy=10\text{mm}$

Maximum value of SAR (interpolated) = 1.19 mW/g

**835 Body system check /Zoom Scan (7x7x7)/Cube 0:** Measurement grid:  $dx=5\text{mm}$ ,  $dy=5\text{mm}$ ,  $dz=5\text{mm}$

Reference Value = 34.7 V/m; Power Drift = 0.113 dB

Peak SAR (extrapolated) = 1.72 W/kg

**SAR(1 g) = 0.967 mW/g; SAR(10 g) = 0.651 mW/g**

Maximum value of SAR (measured) = 1.08 mW/g

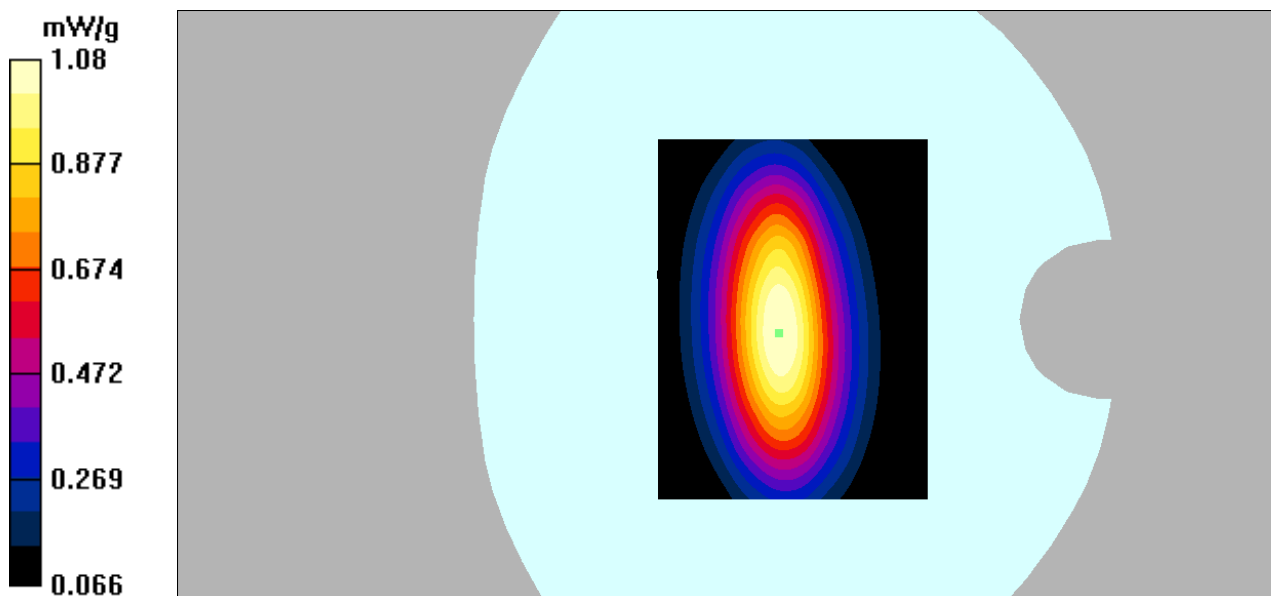

**DUT: Dipole 2600 MHz; Type: D2600V2; S/N: 1132**

Communication System: CW; Frequency: 2600 MHz; Duty Cycle: 1:1

Medium parameters used:  $f = 2600$  MHz;  $\sigma = 2.2$  S/m;  $\epsilon_r = 51.37$ ;  $\rho = 1000$  kg/m<sup>3</sup>

Phantom section: Flat Section

## DASY4 Configuration:

- Probe: EX3DV4 – SN7382; ConvF(7.59, 7.59, 7.59); Calibrated: 26/10/2016
- Sensor-Surface: 4mm (Mechanical Surface Detection)
- Electronics: DAE – SN772; Calibrated: 25/10/2016
- Phantom: TWIN SAM; Type: Twin SAM V5.0; Serial: 1909
- Measurement SW: DASY4, V4.5 Build 19; Postprocessing SW: SEMCAD, V1.8 Build 145

**2600 body system check/Area Scan (71x91x1):** Measurement grid: dx=10mm, dy=10mm

Maximum value of SAR (interpolated) = 6.41 mW/g

**2600 body system check/Zoom Scan (7x7x7)/Cube 0:** Measurement grid: dx=5mm, dy=5mm, dz=5mm

Reference Value = 57.9 V/m; Power Drift = -0.121 dB

Peak SAR (extrapolated) = 11.3 W/kg

**SAR(1 g) = 5.59 mW/g; SAR(10 g) = 2.60 mW/g**

Maximum value of SAR (measured) = 6.46 mW/g

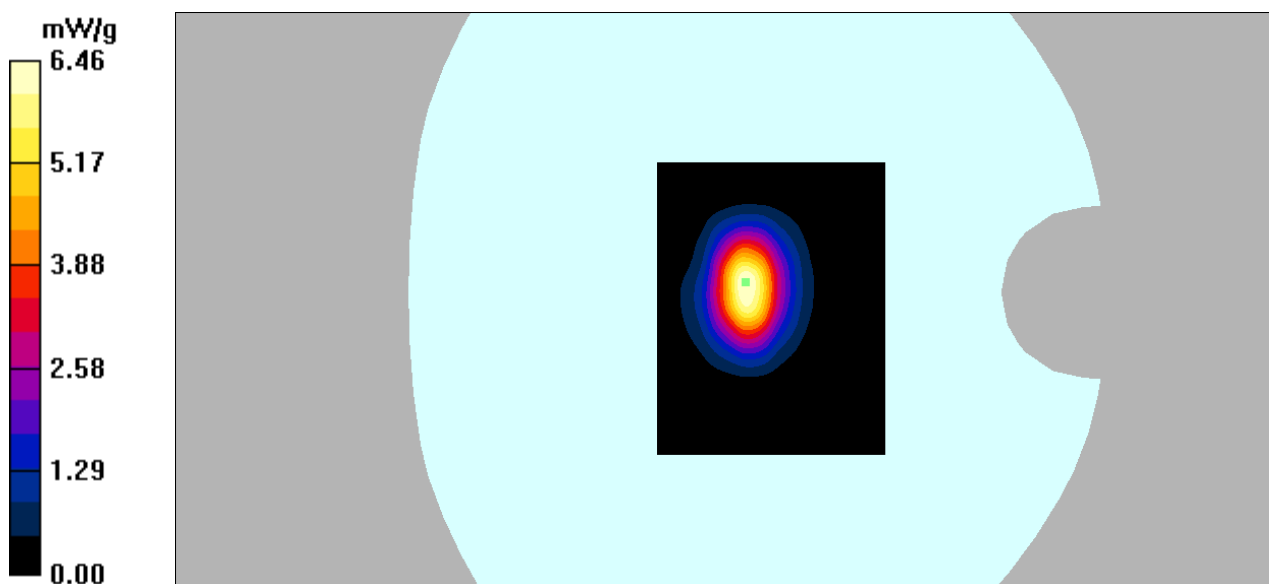

## EUT TEST STRATEGY AND METHODOLOGY

### Body-supported device

A typical example of a body supported device is a wireless enabled laptop device that among other orientations may be supported on the thighs of a sitting user. To represent this orientation, the device shall be positioned with its base against the flat phantom.

Other orientations may be specified by the manufacturer in the user instructions. If the intended use is not specified, the device shall be tested directly against the flat phantom in all usable orientations. The screen portion of the device shall be in an open position at a 90° angle as seen in Figure a (left side), or at an operating angle specified for intended use by the manufacturer in the operating instructions. Where a body supported device has an integral screen required for normal operation, then the screen-side will not need to be tested if it ordinarily remains 200 mm from the body. Where a screen mounted antenna is present, this position shall be repeated with the screen against the flat phantom as shown in Figure 7a) (right side), if this is consistent with the intended use.

Other devices that fall into this category include tablet type portable computers and credit card transaction authorisation terminals, point-of-sale and/or inventory terminals. Where these devices may be torso or limb-supported, the same principles for body-supported devices are applied. The example in Figure b) shows a tablet form factor portable computer for which SAR should be separately assessed with d) each surface and e) the separation distances positioned against the flat phantom that correspond to the intended use as specified by the manufacturer. If the intended use is not specified in the user instructions, the device shall be tested directly against the flat phantom in all usable orientations. Some body-supported devices may allow testing with an external power supply (e.g. a.c. adapter) supplemental to the battery, but it shall be verified and documented in the measurement report that SAR is still conservative.

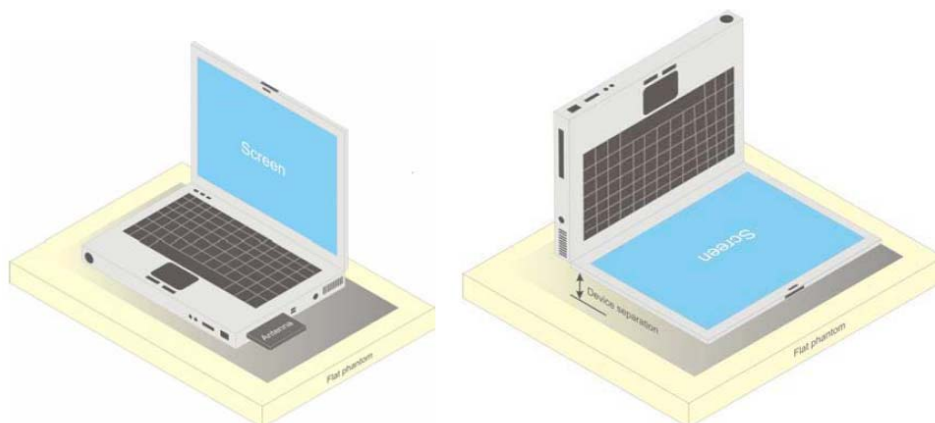

a) Portable computer with external antenna plug-in-radio-card (left side) or with internal antenna located in screen section (right side)

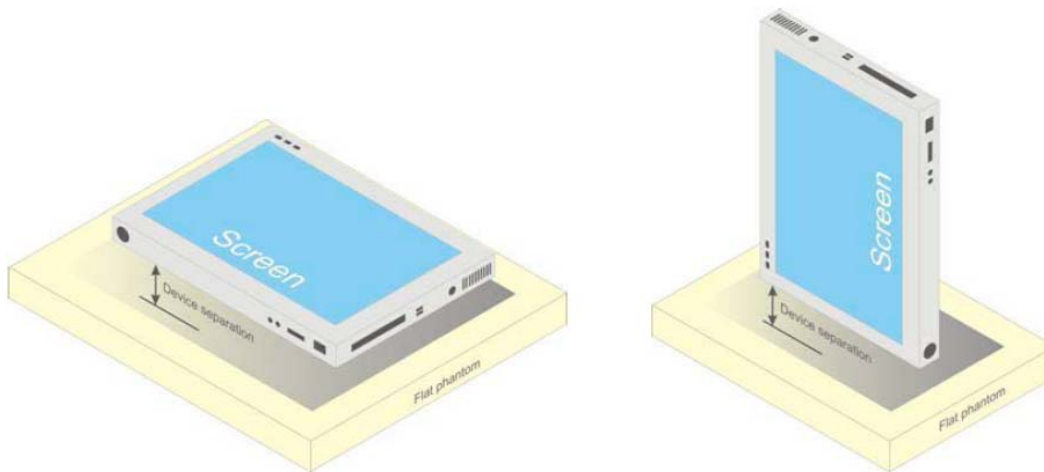

**b) Tablet form factor portable computer**

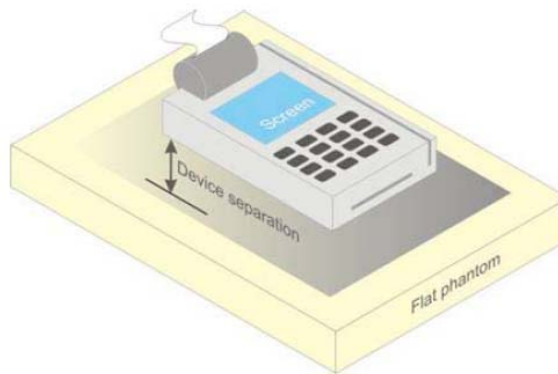

**c) Wireless credit card transaction authorisation terminal**

**Figure 7 – Test positions for body supported devices**

## SAR Evaluation Procedure

The evaluation was performed with the following procedure:

Step 1: Measurement of the SAR value at a fixed location above the ear point or central position was used as a reference value for assessing the power drop. The SAR at this point is measured at the start of the test and then again at the end of the testing.

Step 2: The SAR distribution at the exposed side of the head was measured at a distance of 4 mm from the inner surface of the shell. The area covered the entire dimension of the head or EUT and the horizontal grid spacing was 10 mm x 10 mm. Based on these data, the area of the maximum absorption was determined by spline interpolation. The first Area Scan covers the entire dimension of the EUT to ensure that the Body was correctly identified.

Step 3: Around this point, a volume of 35 mm x 35 mm x 35 mm was assessed by measuring 7x 7 x 7 points. On the basis of this data set, the spatial peak SAR value was evaluated under the following procedure:

- 1) The data at the surface were extrapolated, since the center of the dipoles is 1.2 mm away from the tip of the probe and the distance between the surface and the lowest measuring point is 1.3 mm. The extrapolation was based on a least square algorithm. A polynomial of the fourth order was calculated through the points in z-axes. This polynomial was then used to evaluate the points between the surface and the probe tip.
- 2) The maximum interpolated value was searched with a straightforward algorithm. Around this maximum the SAR values averaged over the spatial volumes (1 g or 10 g) were computed by the 3D-Spline interpolation algorithm. The 3D-Spline is composed of three one dimensional splines with the "Not a knot"-condition (in x, y and z-directions). The volume was integrated with the trapezoidal-algorithm. One thousand points (10 x 10 x 10) were interpolated to calculate the averages.

All neighboring volumes were evaluated until no neighboring volume with a higher average value was found.

Step 4: Re-measurement of the SAR value at the same location as in Step 1. If the value changed by more than 5%, the evaluation was repeated.

## CONDUCTED OUTPUT POWER MEASUREMENT

### Provision Applicable

The measured peak output power should be greater and within 5% than EMI measurement.

### Test Procedure

The RF output of the transmitter was connected to the input of the EMI Test Receiver through sufficient attenuation.

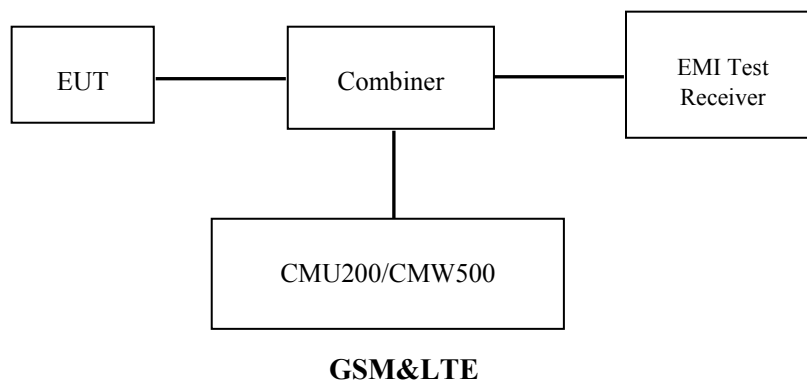

### Radio Configuration

The power measurement was configured by the Wireless Communication Test Set.

#### GSM/GPRS/EGPRS

Function: Menu select > GSM Mobile Station > GSM 850/1900

Press Connection control to choose the different menus

Press RESET > choose all the reset all settings

Connection Press Signal Off to turn off the signal and change settings

Network Support > GSM + GPRS or GSM + EGSM

Main Service > Packet Data

Service selection > Test Mode A – Auto Slot Config. off

MS Signal Press Slot Config Bottom on the right twice to select and change the number of time slots and power setting

- > Slot configuration > Uplink/Gamma

- > 33 dBm for GPRS 850

- > 30 dBm for GPRS 1900

- > 27 dBm for EGPRS 850

- > 26 dBm for EGPRS 1900

BS Signal Enter the same channel number for TCH channel (test channel) and BCCH channel

Frequency Offset > + 0 Hz

Mode > BCCH and TCH

BCCH Level > -85 dBm (May need to adjust if link is not stable)

BCCH Channel > choose desired test channel [Enter the same channel number for TCH channel (test channel) and BCCH channel]

Channel Type > Off

P0 > 4 dB

Slot Config > Unchanged (if already set under MS signal)

TCH > choose desired test channel

Hopping > Off

Main Timeslot > 3

Network Coding Scheme > CS4 (GPRS) and MCS5 (EGPRS)

Bit Stream > 2E9-1 PSR Bit Stream

AF/RF Enter appropriate offsets for Ext. Att. Output and Ext. Att. Input

Connection Press Signal on to turn on the signal and change settings



**LTE**

For UE Power Class 1 and 3, the allowed Maximum Power Reduction (MPR) for the maximum output power in Table 6.2.2-1 due to higher order modulation and transmit bandwidth configuration (resource blocks) is specified in Table 6.2.3-1.

**Table 6.2.3-1: Maximum Power Reduction (MPR) for Power Class 1 and 3**

Modulation	Channel bandwidth / Transmission bandwidth ( $N_{RB}$ )						MPR (dB)
	1.4 MHz	3.0 MHz	5 MHz	10 MHz	15 MHz	20 MHz	
QPSK	> 5	> 4	> 8	> 12	> 16	> 18	≤ 1
16 QAM	≤ 5	≤ 4	≤ 8	≤ 12	≤ 16	≤ 18	≤ 1
16 QAM	> 5	> 4	> 8	> 12	> 16	> 18	≤ 2

For UE Power Class 1 and 3 the specific requirements and identified subclauses are specified in Table 6.2.4-1 along with the allowed A-MPR values that may be used to meet these requirements. The allowed A-MPR values specified below in Table 6.2.4.-1 to 6.2.4-15 are in addition to the allowed MPR requirements specified in subclause 6.2.3.

**Table 6.2.4-1: Additional Maximum Power Reduction (A-MPR)**

Network Signalling value	Requirements (subclause)	E-UTRA Band	Channel bandwidth (MHz)	Resources Blocks ( $N_{RB}$ )	A-MPR (dB)
NS_01	6.6.2.1.1	Table 5.5-1	1.4, 3, 5, 10, 15, 20	Table 5.6-1	N/A
NS_03	6.6.2.2.1	2, 4, 10, 23, 25, 35, 36	3	>5	≤ 1
			5	>6	≤ 1
			10	>6	≤ 1
			15	>8	≤ 1
NS_04	6.6.2.2.2	41	20	>10	≤ 1
			5	>6	≤ 1
NS_05	6.6.3.3.1	1	10, 15, 20	≥ 50	≤ 1
NS_06	6.6.2.2.3	12, 13, 14, 17	1.4, 3, 5, 10	Table 5.6-1	N/A
NS_07	6.6.2.2.3 6.6.3.3.2	13	10	Table 6.2.4-2	
NS_08	6.6.3.3.3	19	10, 15	> 44	≤ 3
NS_09	6.6.3.3.4	21	10, 15	> 40	≤ 1
				> 55	≤ 2
NS_10		20	15, 20	Table 6.2.4-3	
NS_11	6.6.2.2.1	23	1.4, 3, 5, 10, 15, 20	Table 6.2.4-5	
NS_12	6.6.3.3.5	26	1.4, 3, 5	Table 6.2.4-6	
NS_13	6.6.3.3.6	26	5	Table 6.2.4-7	
NS_14	6.6.3.3.7	26	10, 15	Table 6.2.4-8	
NS_15	6.6.3.3.8	26	1.4, 3, 5, 10, 15	Table 6.2.4-9 Table 6.2.4-10	
NS_16	6.6.3.3.9	27	3, 5, 10	Table 6.2.4-11, Table 6.2.4-12, Table 6.2.4-13	
NS_17	6.6.3.3.10	28	5, 10	Table 5.6-1	N/A
NS_18	6.6.3.3.11	28	5	≥ 2	≤ 1
			10, 15, 20	≥ 1	≤ 4
NS_19	6.6.3.3.12	44	10, 15, 20	Table 6.2.4-14	
NS_20	6.2.2 6.6.2.2.1 6.6.3.2	23	5, 10, 15, 20	Table 6.2.4-15	
...					
NS_32	-	-	-	-	-

**WLAN**

For 802.11b, 802.11g and 802.11n-HT20 mode, 11 channels are provided to testing:

Channel	Frequency (MHz)	Channel	Frequency (MHz)
1	2412	8	2447
2	2417	9	2452
3	2422	10	2457
4	2427	11	2462
5	2432	/	/
6	2437	/	/
7	2442	/	/

For 802.11b, 802.11g, 802.11n-HT20 mode, EUT was tested with Channel 1, 6 and 11

For 802.11n-HT40 mode, 7 channels are provided to testing:

Channel	Frequency (MHz)	Channel	Frequency (MHz)
3	2422	8	2447
4	2427	9	2452
5	2432	/	/
6	2437	/	/
7	2442	/	/

EUT was tested with Channel 3, 6 and 9.

**Maximum Output Power among production units**

<b>Max Target Power for Production Unit (dBm)</b>			
<b>Mode/Band</b>	<b>Channel</b>		
	<b>Low</b>	<b>Middle</b>	<b>High</b>
GSM 850	30.40	30.40	30.40
GPRS 1 TX Slot	30.40	30.40	30.40
GPRS 2 TX Slot	29.70	29.70	29.70
GPRS 3 TX Slot	28.10	28.10	28.10
GPRS 4 TX Slot	27.10	27.10	27.10
EGPRS 1 TX Slot	23.80	23.80	23.80
EGPRS 2 TX Slot	22.90	22.90	22.90
EGPRS 3 TX Slot	20.70	20.70	20.70
EGPRS 4 TX Slot	19.60	19.60	19.60
LTE Band 7	22.20	22.20	22.20
WLAN	9.80	9.80	9.80
Bluetooth(GFSK)	0.50	3.00	1.50
Bluetooth( $\pi/4$ -DQPSK))	-0.50	2.00	0.50
Bluetooth((8DPSK))	-0.50	2.00	0.50
BLE	-7.00	-6.00	-6.00

**Test Results:**

**GSM:**

Band	Frequency (MHz)	Conducted Output Power (dBm)
GSM 850	824.2	<b>30.31</b>
	836.6	30.29
	848.8	30.28

**GPRS:**

Band	Channel No.	Frequency (MHz)	RF Output Power (dBm)			
			1 slot	2 slots	3 slots	4 slots
GSM 850	128	824.2	30.30	29.69	28.08	27.08
	190	836.6	30.29	29.62	27.96	26.87
	251	848.8	30.28	29.57	27.81	26.76

**EGPRS:**

Band	Channel No.	Frequency (MHz)	RF Output Power (dBm)			
			1 slot	2 slots	3 slots	4 slots
GSM 850	128	824.2	23.77	22.81	20.68	19.54
	190	836.6	23.67	22.67	20.58	19.42
	251	848.8	23.46	22.45	20.29	19.15

For SAR, the time based average power is relevant, the difference in between depends on the duty cycle of the TDMA signal.

Number of Time slot	1	2	3	4
Duty Cycle	1:8	1:4	1:2.66	1:2
Time based Ave. power compared to slotted Ave. power	-9 dB	-6 dB	-4.25 dB	-3 dB
Crest Factor	8	4	2.66	2

**The time based average power for GPRS**

Band	Channel No.	Frequency (MHz)	Time based average Power (dBm)			
			1 slot	2 slot	3 slots	4 slots
GSM 850	128	824.2	21.30	23.69	23.83	<b>24.08</b>
	190	836.6	21.29	23.62	23.71	23.87
	251	848.8	21.28	23.57	23.56	23.76

**The time based average power for EGPRS**

Band	Channel No.	Frequency (MHz)	Time based average Power (dBm)			
			1 slot	2 slot	3 slots	4 slots
GSM 850	128	824.2	14.77	<b>16.81</b>	16.43	16.54
	190	836.6	14.67	16.67	16.33	16.42
	251	848.8	14.46	16.45	16.04	16.15

**Note:**

1. Rohde & Schwarz Radio Communication Tester (CMU200) was used for the measurement of GSM peak and average output power for active timeslots.
2. For GSM voice, 1 timeslot has been activated with power level 5 (850 MHz band).
3. For GPRS, 1, 2, 3 and 4 timeslots has been activated separately with power level 3(850 MHz band).
4. For EGPRS, 1, 2, 3 and 4 timeslots has been activated separately with power level 6(850 MHz band).

**LTE Band 7:**

BW	Modulation	Resource Block Size & Resource Block Offset	Target MPR	Meas MPR	Ave Tx Power (dBm)		
					Low Channel	Mid Channel	High Channel
					2502.5MHz	2535MHz	2567.5MHz
5M	QPSK	RB Size=1, RB Offset=0	0	0	21.65	21.90	21.54
		RB Size=1, RB Offset=12	0	0	21.56	21.78	21.42
		RB Size=1, RB Offset=24	0	0	21.74	<b>22.02</b>	21.63
		RB Size=12, RB Offset=0	1	1	21.05	21.28	20.86
		RB Size=12, RB Offset=6	1	1	20.96	21.24	20.80
		RB Size=12, RB Offset=11	1	1	21.15	21.39	20.93
		RB Size=25, RB Offset=0	1	1	20.77	21.17	20.71
	16QAM	RB Size=1, RB Offset=0	1	1	21.43	21.73	21.37
		RB Size=1, RB Offset=12	1	1	21.36	21.67	21.33
		RB Size=1, RB Offset=24	1	1	21.55	21.78	21.45
		RB Size=12, RB Offset=0	2	2	21.03	21.19	20.72
		RB Size=12, RB Offset=6	2	2	20.95	21.11	20.62
		RB Size=12, RB Offset=11	2	2	21.13	21.23	20.81
		RB Size=25, RB Offset=0	2	2	20.74	21.15	20.72
BW	Modulation	Resource Block Size & Resource Block Offset	Target MPR	Meas MPR	Ave Tx Power (dBm)		
					Low Channel	Mid Channel	High Channel
					2505MHz	2535MHz	2565MHz
10M	QPSK	RB Size=1, RB Offset=0	0	0	21.25	21.46	21.18
		RB Size=1, RB Offset=24	0	0	21.16	21.35	21.12
		RB Size=1, RB Offset=49	0	0	21.29	<b>21.57</b>	21.22
		RB Size=25, RB Offset=0	1	1	20.57	20.96	20.67
		RB Size=25, RB Offset=12	1	1	20.45	20.85	20.57
		RB Size=25, RB Offset=24	1	1	20.65	21.00	20.78
		RB Size=50, RB Offset=0	1	1	20.67	20.96	20.63
	16QAM	RB Size=1, RB Offset=0	1	1	21.12	21.38	21.05
		RB Size=1, RB Offset=24	1	1	21.03	21.31	20.94
		RB Size=1, RB Offset=49	1	1	21.17	21.49	21.14
		RB Size=25, RB Offset=0	2	2	20.73	21.03	20.79
		RB Size=25, RB Offset=12	2	2	20.62	20.97	20.67
		RB Size=25, RB Offset=24	2	2	20.82	21.09	20.83
		RB Size=50, RB Offset=0	2	2	20.75	21.17	20.84

BW	Modulation	Resource Block Size & Resource Block Offset	Target MPR	Meas MPR	Ave Tx Power (dBm)		
					Low Channel	Mid Channel	High Channel
					2507.5MHz	2535MHz	2562.5MHz
15M	QPSK	RB Size=1, RB Offset=0	0	0	21.43	21.78	21.37
		RB Size=1, RB Offset=37	0	0	21.40	21.74	21.28
		RB Size=1, RB Offset=74	0	0	21.54	21.91	21.48
		RB Size=36, RB Offset=0	1	1	21.24	21.52	21.31
		RB Size=36, RB Offset=18	1	1	21.12	21.40	21.26
		RB Size=36, RB Offset=37	1	1	21.36	21.60	21.39
		RB Size=75, RB Offset=0	1	1	21.54	21.88	21.64
	16QAM	RB Size=1, RB Offset=0	1	1	21.72	21.95	21.43
		RB Size=1, RB Offset=37	1	1	21.65	21.84	21.39
		RB Size=1, RB Offset=74	1	1	21.76	<b>22.03</b>	21.51
		RB Size=36, RB Offset=0	2	2	21.27	21.64	21.34
		RB Size=36, RB Offset=18	2	2	21.19	21.53	21.28
		RB Size=36, RB Offset=37	2	2	21.34	21.72	21.40
		RB Size=75, RB Offset=0	2	2	21.04	21.37	21.15
BW	Modulation	Resource Block Size & Resource Block Offset	Target MPR	Meas MPR	Ave Tx Power (dBm)		
					Low Channel	Mid Channel	High Channel
					2510MHz	2535MHz	2560MHz
20M	QPSK	RB Size=1, RB Offset=0	0	0	21.86	22.09	21.76
		RB Size=1, RB Offset=49	0	0	21.83	21.97	21.66
		RB Size=1, RB Offset=99	0	0	21.99	<b>22.17</b>	21.83
		RB Size=50, RB Offset=0	1	1	21.42	21.87	21.35
		RB Size=50, RB Offset=24	1	1	21.35	21.74	21.31
		RB Size=50, RB Offset=49	1	1	21.55	21.92	21.44
		RB Size=100, RB Offset=0	1	1	21.24	21.54	21.36
	16QAM	RB Size=1, RB Offset=0	1	1	21.76	22.04	21.85
		RB Size=1, RB Offset=49	1	1	21.73	22.00	21.77
		RB Size=1, RB Offset=99	1	1	21.84	22.10	21.89
		RB Size=50, RB Offset=0	2	2	21.42	21.64	21.32
		RB Size=50, RB Offset=24	2	2	21.31	21.56	21.24
		RB Size=50, RB Offset=49	2	2	21.49	21.75	21.39
		RB Size=100, RB Offset=0	2	2	21.13	21.36	21.17

**Note:**

1. SAR for LTE band exposure configurations is measured according to the procedures of KDB 941225 D05 SAR for LTE Devices v02.
2. The CMW500 Wideband Radio Communication tester is used for LTE output power measurements and SAR testing. Closed loop power control is used to keep the radio transmitters the max output power during the test.
3. KDB941225D05v02- SAR for higher order modulation is required only when the highest maximum output power for the configuration in the higher order modulation is > 1/2 dB higher than the same configuration in QPSK or when the reported SAR for the QPSK configuration is > 1.45 W/kg

**Bluetooth**

Mode	Channel	Channel frequency (MHz)	Conducted Output Power (dBm)
BDR (GFSK)	Low	2402	0.13
	Middle	2441	<b>2.82</b>
	High	2480	1.23
EDR ( $\pi/4$ -DQPSK)	Low	2402	-0.86
	Middle	2441	1.92
	High	2480	0.18
EDR (8DPSK)	Low	2402	-0.87
	Middle	2441	1.86
	High	2480	0.11
BLE	Low	2402	-7.31
	Middle	2440	-6.24
	High	2480	-6.46

**WLAN**

Mode	Channel No.	Channel frequency (MHz)	Conducted Output Power (dBm)
802.11b	1	2412	9.21
	6	2437	9.67
	11	2462	9.50
802.11g	1	2412	8.57
	6	2437	<b>9.73</b>
	11	2462	9.69
802.11n HT20	1	2412	8.64
	6	2437	9.65
	11	2462	9.37
802.11n HT40	3	2422	9.35
	6	2437	9.64
	9	2452	9.36



## SAR MEASUREMENT RESULTS

This page summarizes the results of the performed dosimetric evaluation.

### SAR Test Data

#### Environmental Conditions

<b>Temperature:</b>	21.5-23.7 °C	21.5-23.2 °C
<b>Relative Humidity:</b>	61 %	52 %
<b>ATM Pressure:</b>	1008 mbar	1006 mbar
<b>Test Date:</b>	2017-06-08	2017-06-09

Testing was performed by Jack Xu, Apple Wu, Judy Huang.

**KDB 616217:** The hotspot mode SAR procedures (KDB Publication 941225 D06) for handsets and UMPC mini-tablet procedures generally do not apply to the full-size tablet devices. The standalone and simultaneous transmission SAR tests required for tablets are more conservative than the hotspot mode use configurations; therefore, additional testing for hotspot SAR is not required when the procedures in this document are applied.

#### GSM 850:

EUT Position	Frequency (MHz)	Test Mode	Max. Meas. Power (dBm)	Max. Rated Power (dBm)	1g SAR (W/Kg)			
					Scaled Factor	Meas. SAR	Scaled SAR	Plot
Body Voice Back (0mm)	824.2	GSM	30.31	30.40	1.021	0.808	0.825	1#
	836.6	GSM	30.29	30.40	1.026	0.808	0.829	2#
	848.8	GSM	30.28	30.40	1.028	0.769	0.791	3#
Body Back (0mm)	824.2	GPRS	27.08	27.10	1.005	1.14	<b>1.145</b>	4#
	836.6	GPRS	26.87	27.10	1.054	1.04	1.097	5#
	848.8	GPRS	26.76	27.10	1.081	0.980	1.060	6#
Body Left (0mm)	824.2	GPRS	/	/	/	/	/	/
	836.6	GPRS	26.87	27.10	1.054	0.389	0.410	7#
	848.8	GPRS	/	/	/	/	/	/
Body Bottom (0mm)	824.2	GPRS	/	/	/	/	/	/
	836.6	GPRS	26.87	27.10	1.054	0.605	0.638	8#
	848.8	GPRS	/	/	/	/	/	/

#### Note:

1. When the 1-g SAR is  $\leq 0.8$ W/Kg, testing for other channels are optional.
2. The EUT transmit and receive through the same GSM antenna while testing SAR.
3. When SAR or MPE is not measured at the maximum power level allowed for production units, the results must be scaled to the maximum tune-up tolerance limit according to the power applied to the individual channels tested to determine compliance.
4. When the maximum output power variation across the required test channels is  $> \frac{1}{2}$  dB, instead of the middle channel, the highest output power channel must be used.
5. The Multi-slot Classes of EUT is Class 12 which has maximum 4 Downlink slots and 4 Uplink slots, the maximum active slots is 5, when perform the multiple slots scan, 1DL+4UL is the worst case.

**LTE Band 7:**

EUT Position	Frequency (MHz)	Bandwidth (MHz)	Test Mode	Max. Meas. Power (dBm)	Max. Rated Power (dBm)	1g SAR (W/Kg)			
						Scaled Factor	Meas. SAR	Scaled SAR	Plot
Body Voice Back & Body Back (0mm)	2510	20	1RB, Offset=99	21.99	22.20	1.050	0.967	1.015	9#
	2535	20	1RB, Offset=99	22.17	22.20	1.007	1.07	<b>1.077</b>	10#
	2560	20	1RB, Offset=99	21.83	22.20	1.089	0.843	0.918	11#
	2535	20	50%RB, Offset=49	21.92	22.20	1.067	0.707	0.754	12#
	2535	20	100%RB, Offset=0	21.54	22.20	1.164	0.673	0.783	13#
Body Left (0mm)	2510	20	1RB, Offset=99	/	/	/	/	/	/
	2535	20	1RB, Offset=99	22.17	22.20	1.007	0.223	0.225	14#
	2560	20	1RB, Offset=99	/	/	/	/	/	/
	2535	20	50%RB, Offset=49	21.92	22.20	1.067	0.219	0.234	15#
Body Bottom (0mm)	2510	20	1RB, Offset=99	/	/	/	/	/	/
	2535	20	1RB, Offset=99	22.17	22.20	1.007	0.743	0.748	16#
	2560	20	1RB, Offset=99	/	/	/	/	/	/
	2535	20	50%RB, Offset=49	21.92	22.20	1.067	0.664	0.708	17#

**Note:**

1. When the 1-g SAR is  $\leq 0.8W/Kg$ , testing for other channels are optional.
2. SAR for LTE band exposure configurations is measured according to the procedures of KDB 941225 D05 SAR for LTE Devices v02.
3. KDB941225D05- Start with the largest channel bandwidth and measure SAR for QPSK with 1 RB allocation, using the RB offset and required test channel combination with the highest maximum output power among RB offset the upper edge, middle and lower edge of each required test channel.
4. The procedures required for 1 RB allocation are applied to measure the SAR for QPSK with 50% RB allocation
5. KDB941225D05- For QPSK with 100% RB allocation, SAR is not required when the highest maximum output power for 100 % RB allocation is less than the highest maximum output power in 50% and 1 RB allocations and the highest reported SAR for 1 RB and 50% RB allocation are  $\leq 0.8 W/kg$ .
6. KDB941225D05- For QPSK with 100% RB allocation, when the reported SAR measured for the Highest output power channel is  $< 1.45 W/kg$ , tests for the remaining required test channels are optional.
7. KDB941225D05- SAR for higher order modulation is required only when the highest maximum output power for the configuration in the higher order modulation is  $> \frac{1}{2}$  dB higher than the same configuration in QPSK or when the reported SAR for the QPSK configuration is  $> 1.45 W/kg$ .

## SAR Measurement Variability

In accordance with published RF Exposure KDB procedure 865664 D01 SAR measurement 100 MHz to 6 GHz v01. These additional measurements are repeated after the completion of all measurements requiring the same head or body tissue-equivalent medium in a frequency band. The test device should be returned to ambient conditions (normal room temperature) with the battery fully charged before it is re-mounted on the device holder for the repeated measurement(s) to minimize any unexpected variations in the repeated results

- 1) Repeated measurement is not required when the original highest measured SAR is  $< 0.80$  W/kg.
- 2) When the original highest measured SAR is  $\geq 0.80$  W/kg, repeat that measurement once.
- 3) Perform a second repeated measurement only if the ratio of largest to smallest SAR for the original and first repeated measurements is  $> 1.20$  or when the original or repeated measurement is  $\geq 1.45$  W/kg (~ 10% from the 1-g SAR limit).
- 4) Perform a third repeated measurement only if the original, first or second repeated measurement is  $\geq 1.5$  W/kg and the ratio of largest to smallest SAR for the original, first and second repeated measurements is  $> 1.20$ .

### The Highest Measured SAR Configuration in Each Frequency Band

#### Head

Frequency Band	Freq.(MHz)	EUT Position	Meas. SAR (W/kg)		Largest to Smallest SAR Ratio
			Original	Repeated	
/	/	/	/	/	/

#### Body

Frequency Band	Freq.(MHz)	EUT Position	Meas. SAR (W/kg)		Largest to Smallest SAR Ratio
			Original	Repeated	
GSM 850	824.2	Body Back (0mm)	1.14	1.17	1.03
LTE Band 7	2535	Body Back (0mm)	1.07	1.05	1.02

#### Note:

Second Repeated Measurement is not required since the ratio of the largest to smallest SAR for the original and first repeated measurement is not  $> 1.20$ .

### SAR SIMULTANEOUS TRANSMISSION DESCRIPTION

#### Bluetooth & WLAN and GSM&LTE Antennas Location:

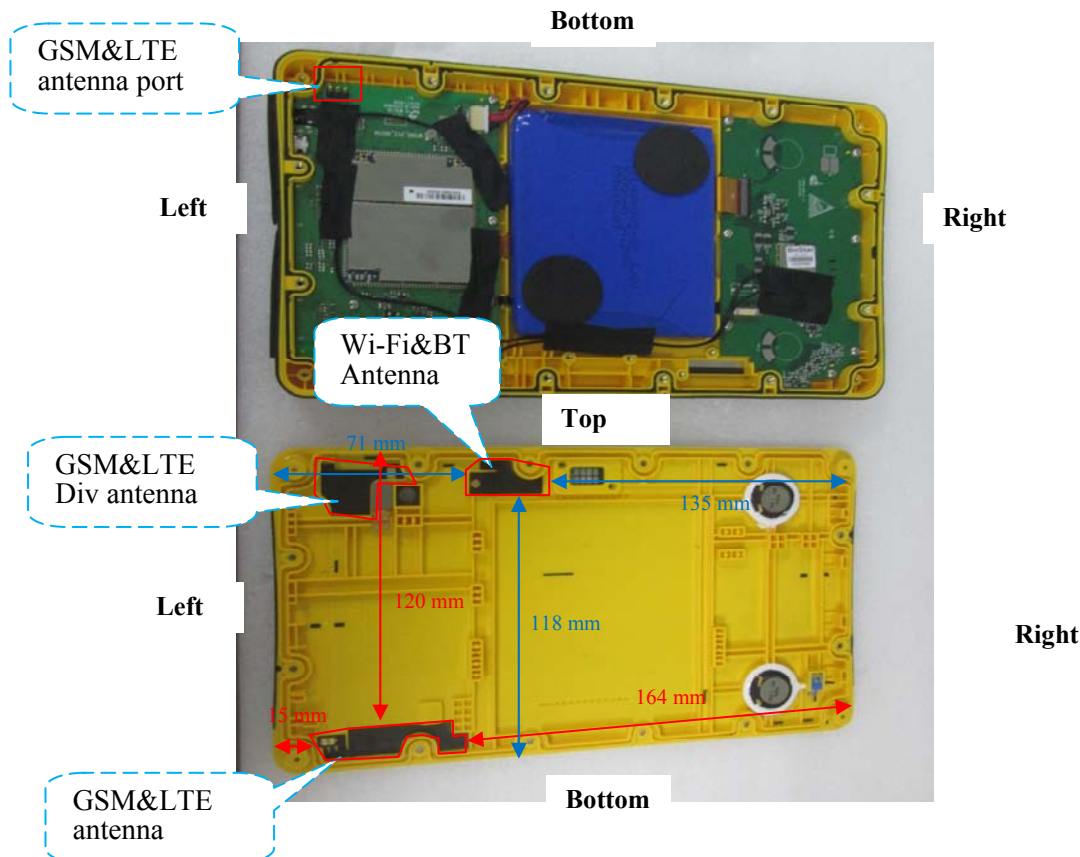

#### Antenna Distance To Edge :

Antenna Distance To Edge(mm)					
Mode	Left	Right	Back	Top	Bottom
GSM/LTE Antenna	15	164	< 5	120	< 5
WLAN/BT Antenna	110	135	< 5	< 5	118

#### Simultaneous Transmission:

Description of Simultaneous Transmit Capabilities			Antennas Distance (mm)
Transmitter Combination	Simultaneous?	Hotspot?	
GSM + LTE	×	×	0
GSM + Bluetooth	√	×	99
GSM + WLAN	√	√	99
LTE + Bluetooth	√	×	99
LTE + WLAN	√	√	99

**Standalone SAR test exclusion considerations**

Mode	Position	Max tune-up power		Distance (mm)	Calculated value	Threshold (1-g)	SAR Test Exclusion
		(dBm)	(mW)				
Bluetooth	Body	3.00	2.00	0	0.6	3.0	Yes
WLAN	Body	9.80	9.55	0	3.0	3.0	Yes

The 1-g and 10-g SAR test exclusion thresholds for 100 MHz to 6 GHz at *test separation distances* ≤ 50 mm are determined by:

$$[(\text{max. power of channel, including tune-up tolerance, mW}) / (\text{min. test separation distance, mm})] \cdot [\sqrt{f(\text{GHz})}] \leq 3.0 \text{ for 1-g SAR and } \leq 7.5 \text{ for 10-g extremity SAR, where}$$

1. f(GHz) is the RF channel transmit frequency in GHz.
2. Power and distance are rounded to the nearest mW and mm before calculation.
3. The result is rounded to one decimal place for comparison.
4. When the minimum test separation distance is < 5 mm, a distance of 5 mm is applied to determine SAR test Exclusion.

**SAR test exclusion for the EUT edge considerations Result**

SAR Test Exclusion for the EUT Edges Considerations						
Mode	Left	Right	Front	Back	Top	Bottom
GSM/LTE Antenna	Required	Exemption	Exclusion	Required	Exemption	Required
WLAN/BT Antenna	Exemption	Exemption	Exclusion	Exclusion*	Exclusion*	Exemption

**Note:**

**Required:** The distance is less than 25mm, the SAR test is required as Standalone SAR test exclusion considerations table.

**Exemption:** The distance is more than 25mm, according to KDB 941225 D06, the Standalone SAR test is not required.

**Exclusion:** In normal operation mode, the Edge(s) will not be touched by the users directly, so SAR test is not consideration.

**Exclusion\*:** SAR test exclusion evaluation has been done above.

**Standalone SAR estimation:**

Mode	Position	Max tune-up power		Distance (mm)	Estimated <sub>1-g</sub> (W/kg)
		(dBm)	(mW)		
Bluetooth	Body	3.00	2.00	0	0.084
WLAN	Body	9.80	9.55	0	0.400

When standalone SAR test exclusion applies to an antenna that transmits simultaneously with other antennas, the standalone SAR must be estimated according to following to determine simultaneous transmission SAR test exclusion:

$[(\text{max. power of channel, including tune-up tolerance, mW}) / (\text{min. test separation distance, mm})] \cdot [\sqrt{f(\text{GHz})/x}] \text{ W/kg}$  for test separation distances  $\leq 50 \text{ mm}$ ;

where  $x = 7.5$  for 1-g SAR.

When the minimum test separation distance is  $< 5 \text{ mm}$ , a distance of  $5 \text{ mm}$  is applied to determine SAR test Exclusion

**Simultaneous SAR test exclusion considerations:**

Mode(SAR1+SAR2)	Position	Reported SAR(W/kg)		ΣSAR < 1.6W/kg
		SAR1	SAR2	
GSM 850+ Bluetooth	Body Worn Back	0.829	0.084	0.913
GPRS 850 + Bluetooth (Body)	Body Back	1.145	0.084	1.229
	Body Left	0.410	0.084	0.494
	Body Bottom	0.638	0.084	0.722
LTE Band 7+ Bluetooth (Body)	Body Back	1.077	0.084	1.161
	Body Left	0.234	0.084	0.318
	Body Bottom	0.748	0.084	0.832

Mode(SAR1+SAR2)	Position	Reported SAR(W/kg)		ΣSAR < 1.6W/kg
		SAR1	SAR2	
GSM 850+ WLAN	Body Worn Back	0.829	0.400	1.229
GPRS 850 + WLAN (Body)	Body Back	1.145	0.400	<b>1.545</b>
	Body Left	0.410	0.400	0.810
	Body Bottom	0.638	0.400	1.038
LTE Band 7+ WLAN (Body)	Body Back	1.077	0.400	1.477
	Body Left	0.234	0.400	0.634
	Body Bottom	0.748	0.400	1.148

**Conclusion:**

Sum of SAR: ΣSAR < 1.6 W/kg therefore simultaneous transmission SAR with Volume Scans is **not required**.

## MEASUREMENT UNCERTAINTY

The uncertainty budget has been determined for the measurement system and is given in the following Table.

Measurement uncertainty evaluation for IEEE1528-2013 SAR test

Source of uncertainty	Tolerance/uncertainty ± %	Probability distribution	Divisor	ci (1 g)	ci (10 g)	Standard uncertainty ± %, (1 g)	Standard uncertainty ± %, (10 g)
<b>Measurement system</b>							
Probe calibration	6.55	N	1	1	1	6.6	6.6
Axial Isotropy	4.7	R	√3	1	1	2.7	2.7
Hemispherical Isotropy	9.6	R	√3	0	0	0.0	0.0
Boundary effect	1.0	R	√3	1	1	0.6	0.6
Linearity	4.7	R	√3	1	1	2.7	2.7
Detection limits	1.0	R	√3	1	1	0.6	0.6
Readout electronics	0.3	N	1	1	1	0.3	0.3
Response time	0.0	R	√3	1	1	0.0	0.0
Integration time	0.0	R	√3	1	1	0.0	0.0
RF ambient conditions – noise	1.0	R	√3	1	1	0.6	0.6
RF ambient conditions–reflections	1.0	R	√3	1	1	0.6	0.6
Probe positioner mech. Restrictions	0.8	R	√3	1	1	0.5	0.5
Probe positioning with respect to phantom shell	6.7	R	√3	1	1	3.9	3.9
Post-processing	2.0	R	√3	1	1	1.2	1.2
<b>Test sample related</b>							
Test sample positioning	2.8	N	1	1	1	2.8	2.8
Device holder uncertainty	6.3	N	1	1	1	6.3	6.3
Drift of output power	5.0	R	√3	1	1	2.9	2.9
<b>Phantom and set-up</b>							
Phantom uncertainty (shape and thickness tolerances)	4.0	R	√3	1	1	2.3	2.3
Liquid conductivity target)	5.0	R	√3	0.64	0.43	1.8	1.2
Liquid conductivity meas.)	2.5	N	1	0.64	0.43	1.6	1.1
Liquid permittivity target)	5.0	R	√3	0.6	0.49	1.7	1.4
Liquid permittivity meas.)	2.5	N	1	0.6	0.49	1.5	1.2
Combined standard uncertainty		RSS				12.2	12.0
Expanded uncertainty 95 % confidence interval)						24.3	23.9



Measurement uncertainty evaluation for IEC62209-2 SAR test

Source of uncertainty	Tolerance/uncertainty ± %	Probability distribution	Divisor	ci (1 g)	ci (10 g)	Standard uncertainty ± %, (1 g)	Standard uncertainty ± %, (10 g)
<b>Measurement system</b>							
Probe calibration	6.55	N	1	1	1	6.6	6.6
Axial Isotropy	4.7	R	√3	1	1	2.7	2.7
Hemispherical Isotropy	9.6	R	√3	0	0	0.0	0.0
Linearity	4.7	R	√3	1	1	2.7	2.7
Modulation Response	0.0	R	√3	1	1	0.0	0.0
Detection limits	1.0	R	√3	1	1	0.6	0.6
Boundary effect	1.0	R	√3	1	1	0.6	0.6
Readout electronics	0.3	N	1	1	1	0.3	0.3
Response time	0.0	R	√3	1	1	0.0	0.0
Integration time	0.0	R	√3	1	1	0.0	0.0
RF ambient conditions – noise	1.0	R	√3	1	1	0.6	0.6
RF ambient conditions–reflections	1.0	R	√3	1	1	0.6	0.6
Probe positioner mech. Restrictions	0.8	R	√3	1	1	0.5	0.5
Probe positioning with respect to phantom shell	6.7	R	√3	1	1	3.9	3.9
Post-processing	2.0	R	√3	1	1	1.2	1.2
<b>Test sample related</b>							
Device holder Uncertainty	6.3	N	1	1	1	6.3	6.3
Test sample positioning	2.8	N	1	1	1	2.8	2.8
Power scaling	4.5	R	√3	1	1	2.6	2.6
Drift of output power	5.0	R	√3	1	1	2.9	2.9
<b>Phantom and set-up</b>							
Phantom uncertainty (shape and thickness tolerances)	4.0	R	√3	1	1	2.3	2.3
Algorithm for correcting SAR for deviations in permittivity and conductivity	1.9	N	1	1	0.84	1.1	0.9
Liquid conductivity (meas.)	2.5	N	1	0.64	0.43	1.6	1.1
Liquid permittivity (meas.)	2.5	N	1	0.6	0.49	1.5	1.2
Temp. unc. - Conductivity	1.7	R	√3	0.78	0.71	0.8	0.7
Temp. unc. - Permittivity	0.3	R	√3	0.23	0.26	0.0	0.0
Combined standard uncertainty		RSS				12.2	12.1
Expanded uncertainty 95 % confidence interval)						24.5	24.2

## **Appendixes**

Refer to separated files for the following appendixes.

**APPENDIX A SAR plots.**

**APPENDIX B PROBE & DIPOLES CALIBRATION CERTIFICATES.**

**APPENDIX C TEST POSITION PHOTOS.**

**\*\*\*\*\* END OF REPORT \*\*\*\*\***