

FCC ID: SY4-A02043

Model No.: PA-3 Plus

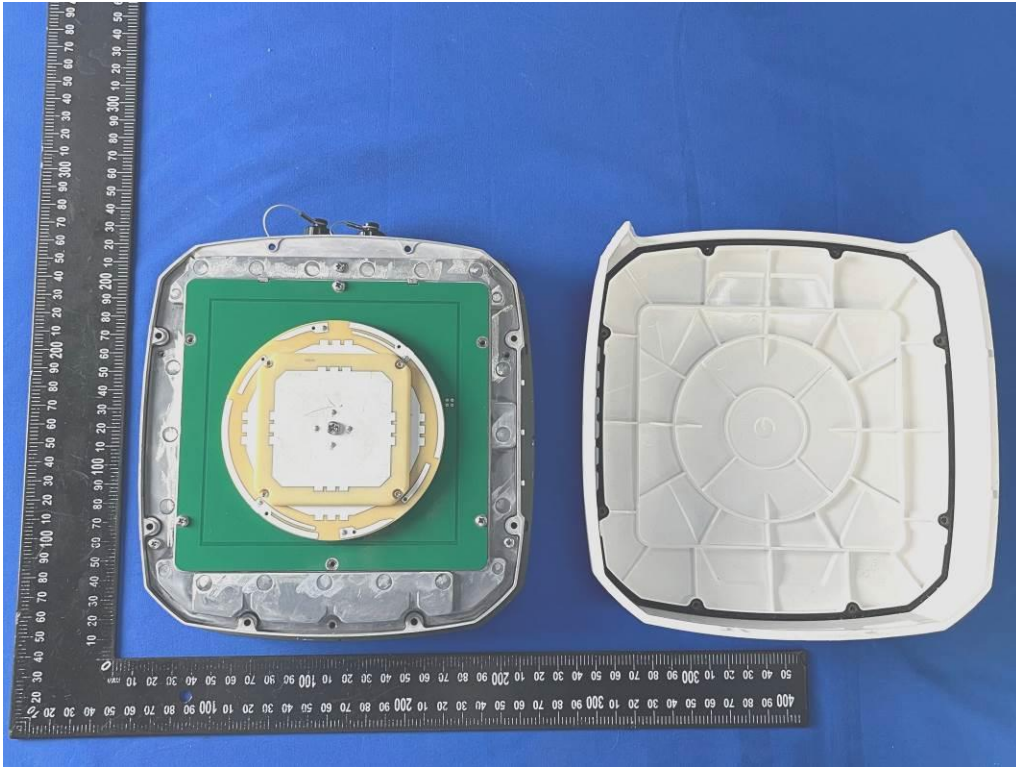

Internal view(PA-3 Plus)

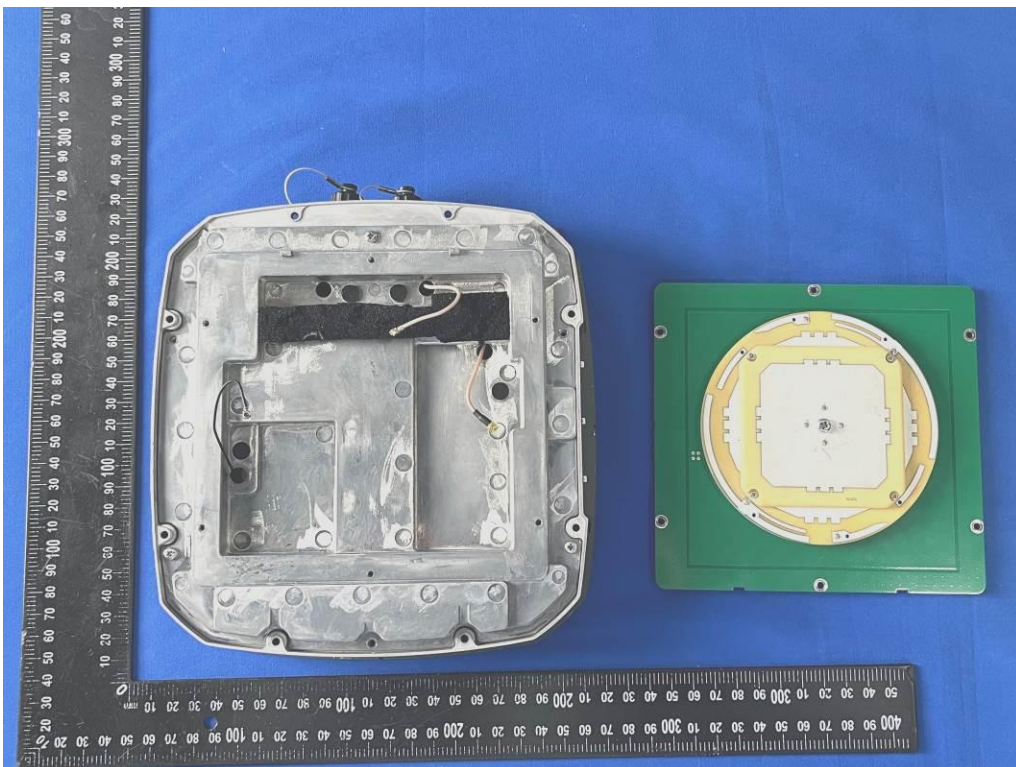

Internal view(PA-3 Plus)

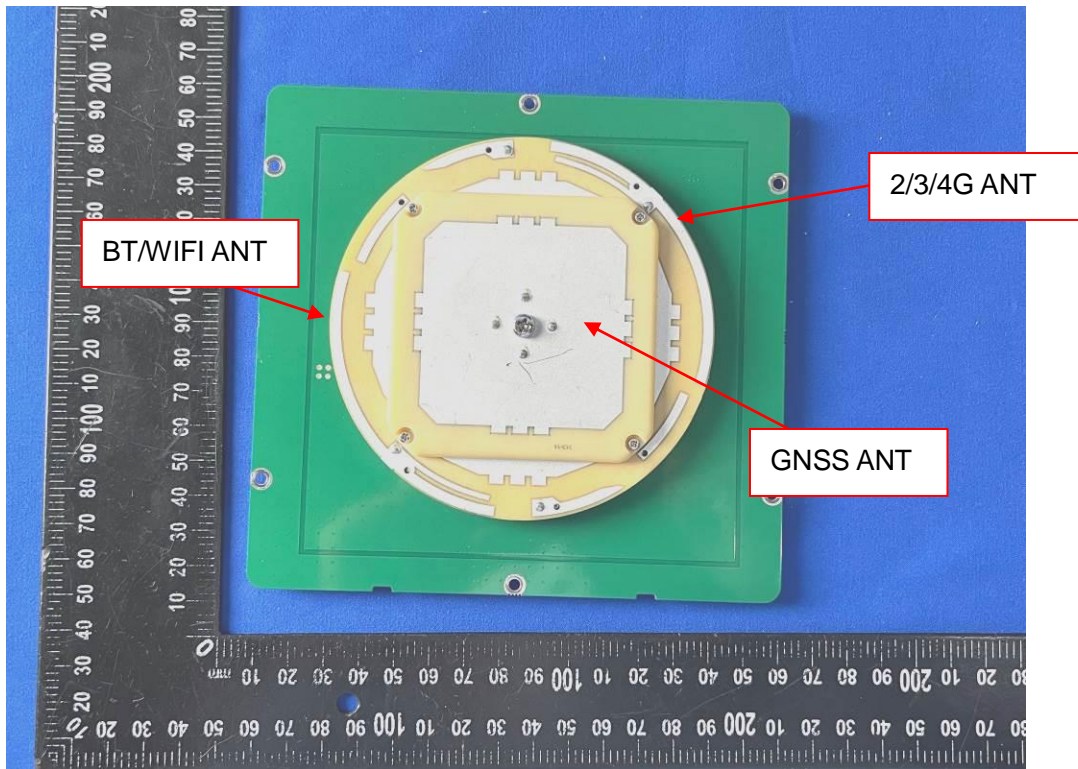

Internal view(PA-3 Plus)

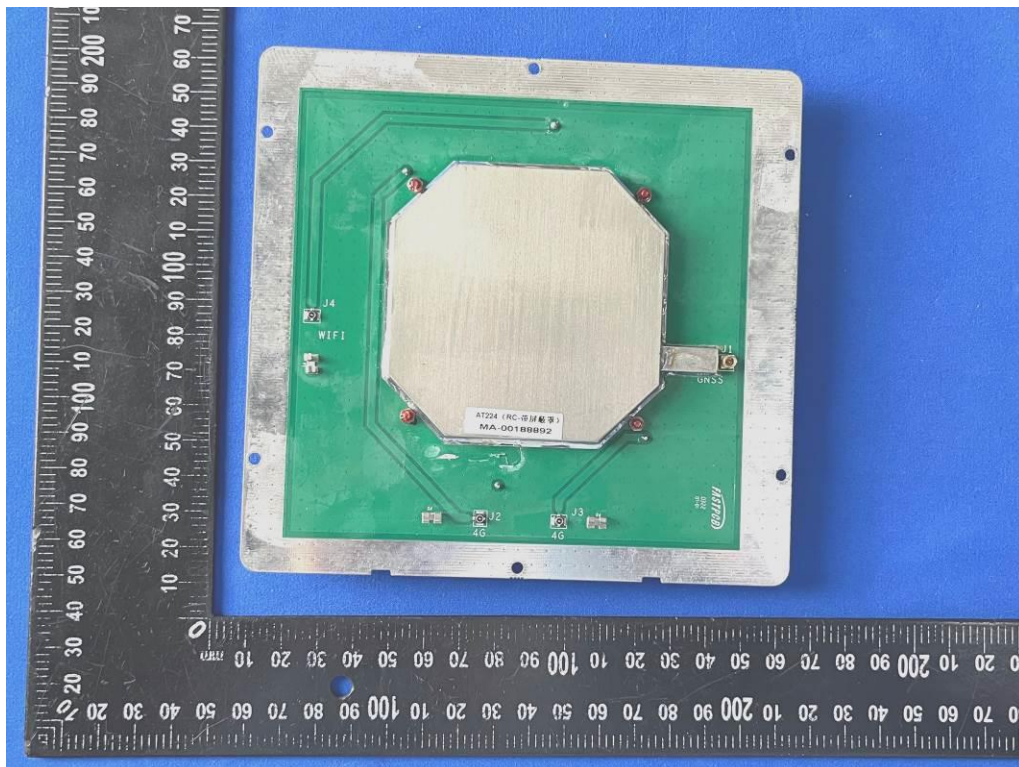

Internal view(PA-3 Plus)





Internal view(PA-3 Plus)

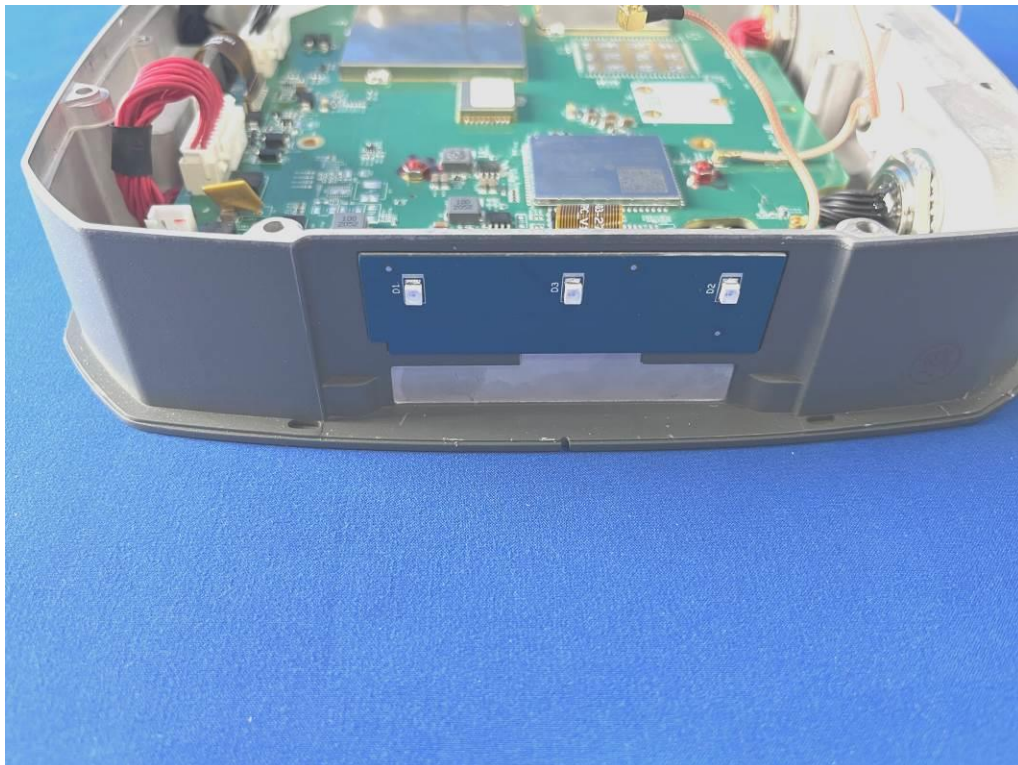

Internal view(PA-3 Plus)

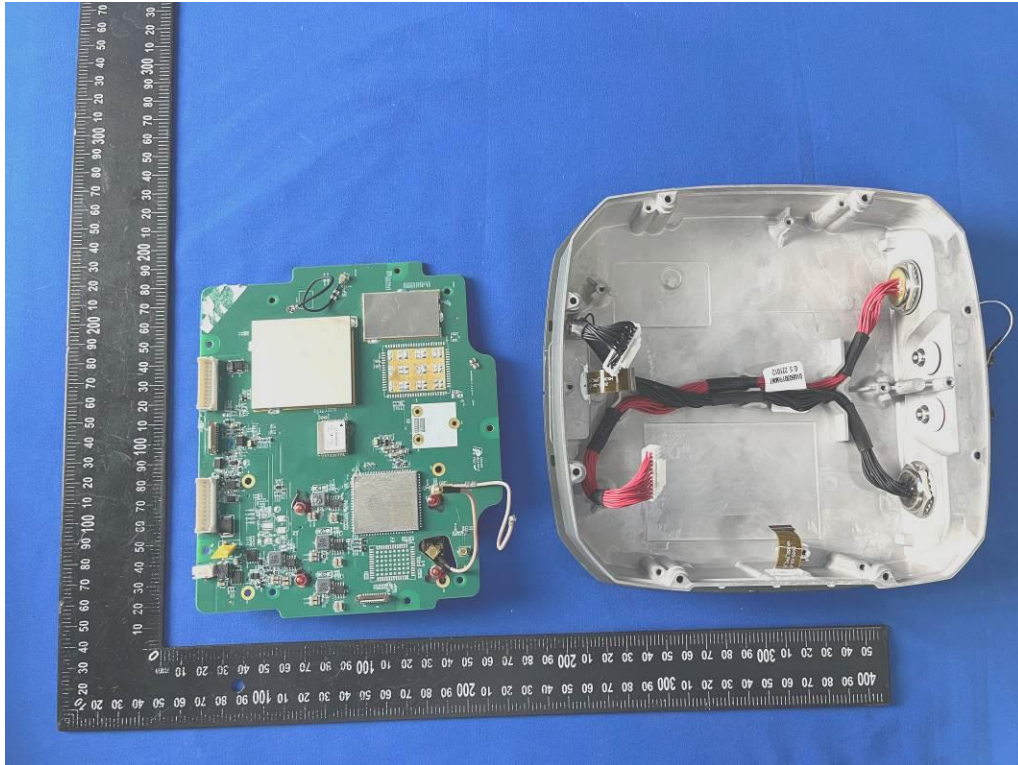

Internal view(PA-3 Plus)

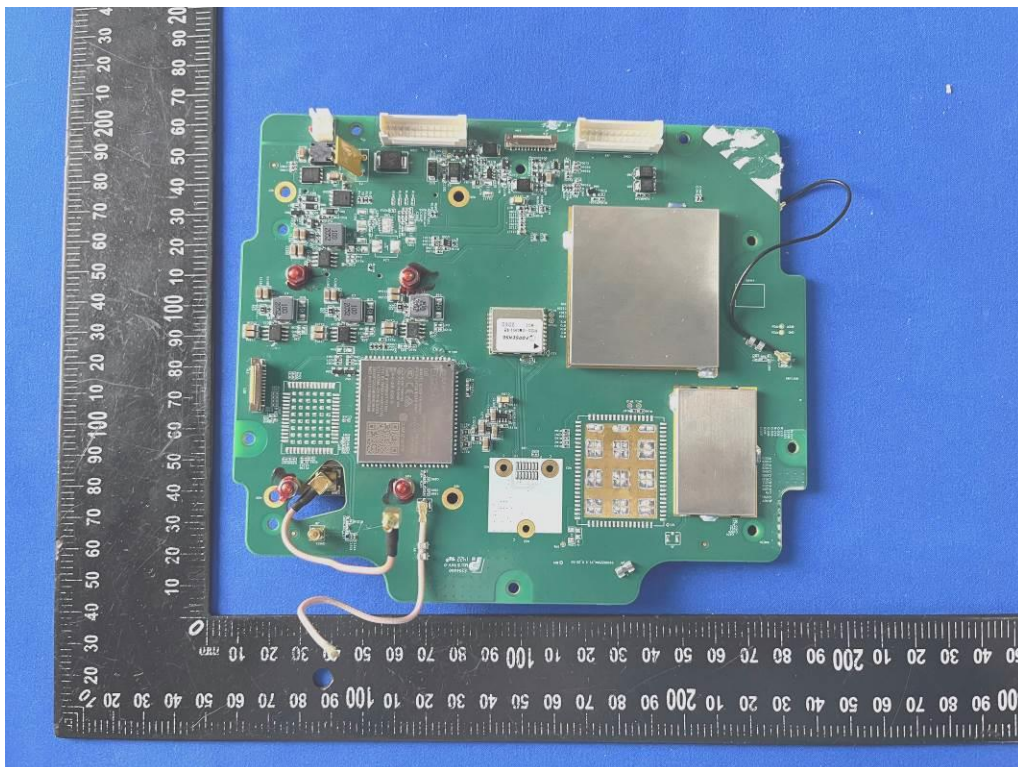

Internal view(PA-3 Plus)



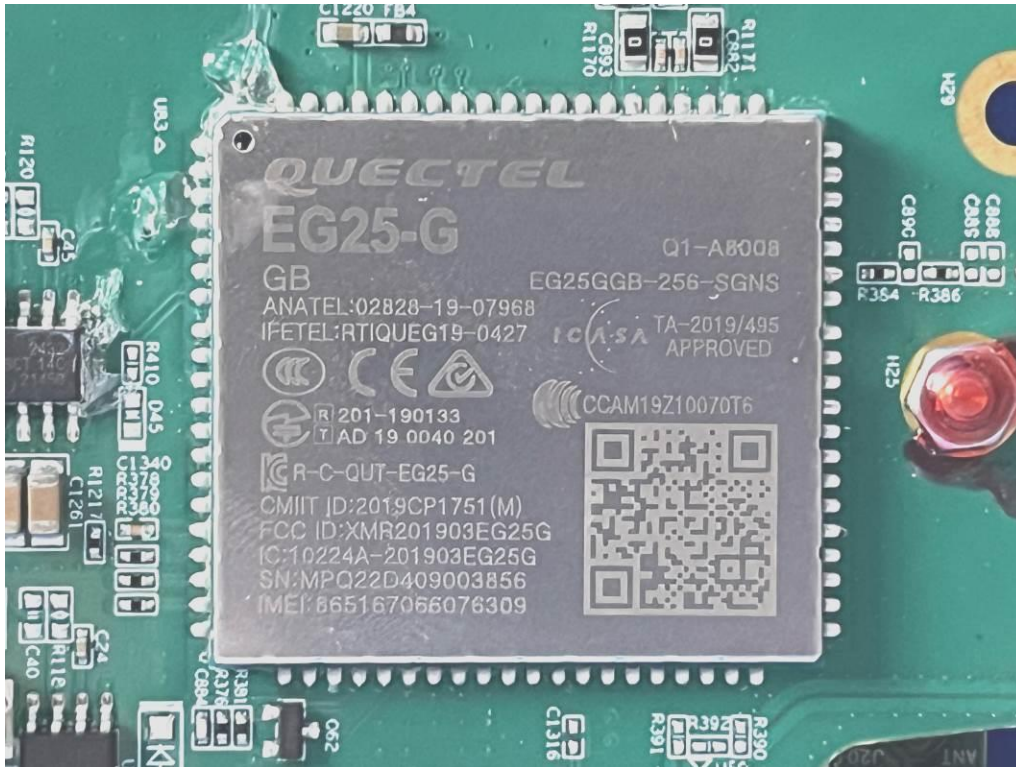

Internal view(PA-3 Plus)

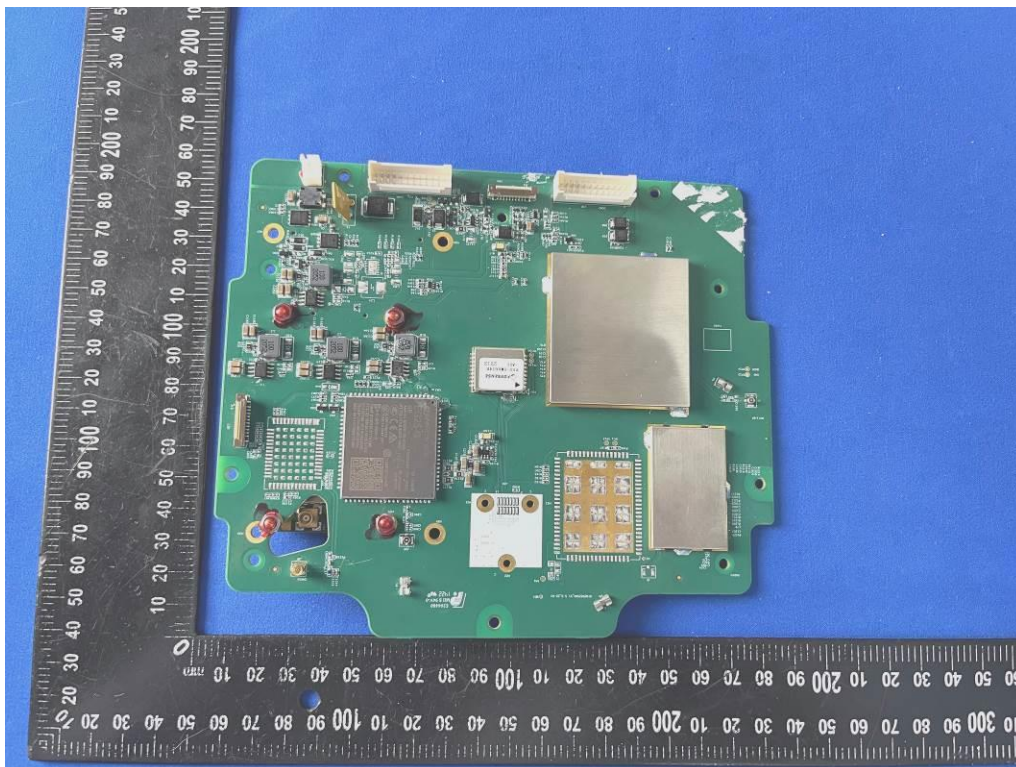

Internal view(PA-3 Plus)

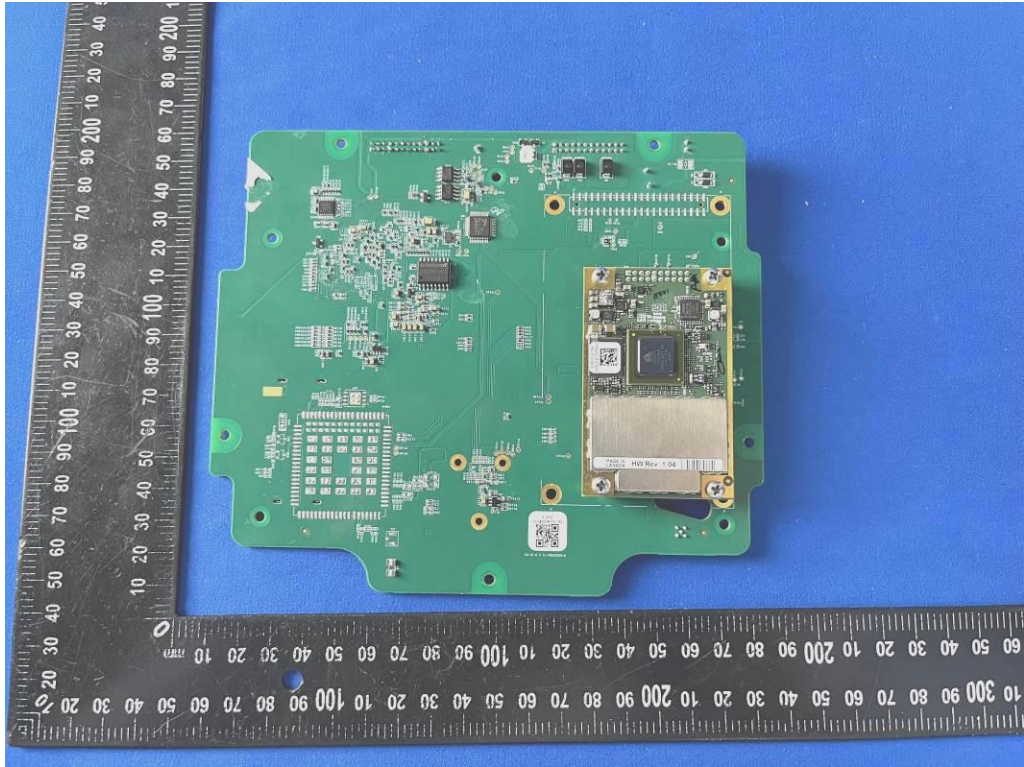

Internal view(PA-3 Plus)

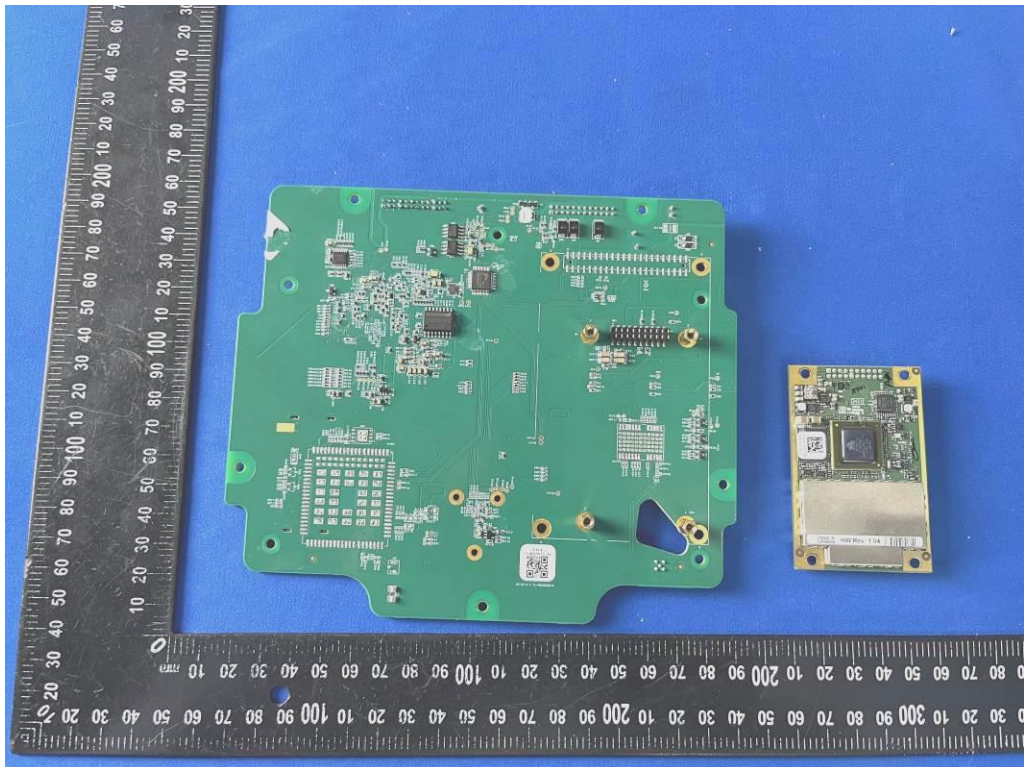

Internal view(PA-3 Plus)



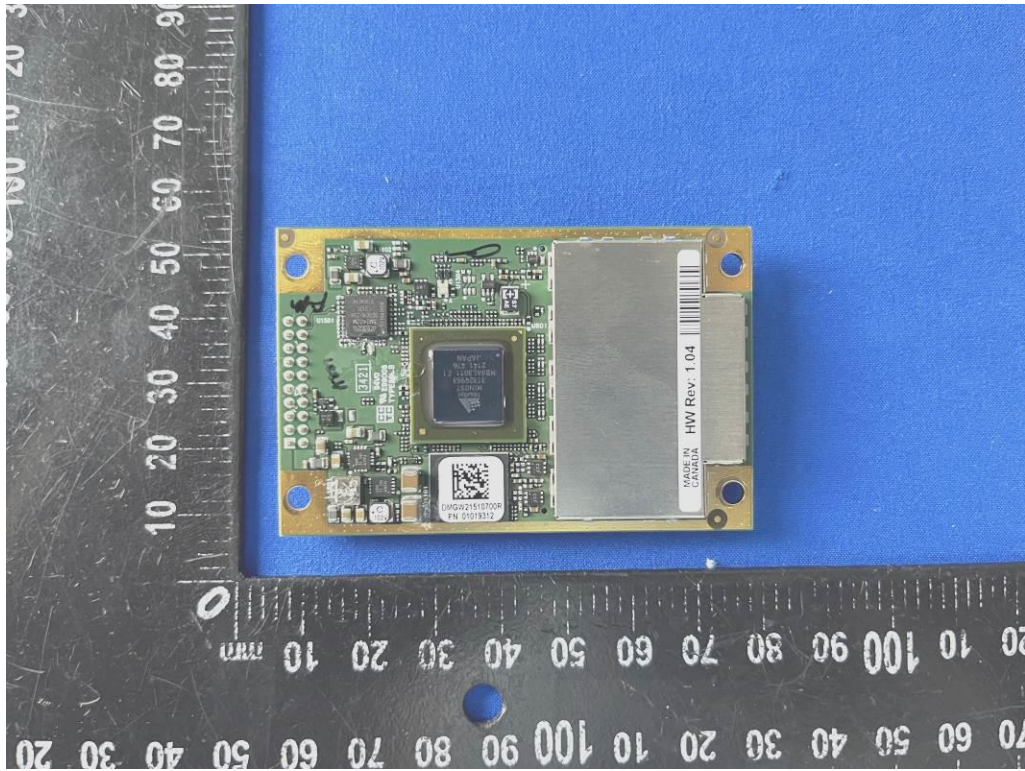

Internal view(PA-3 Plus)

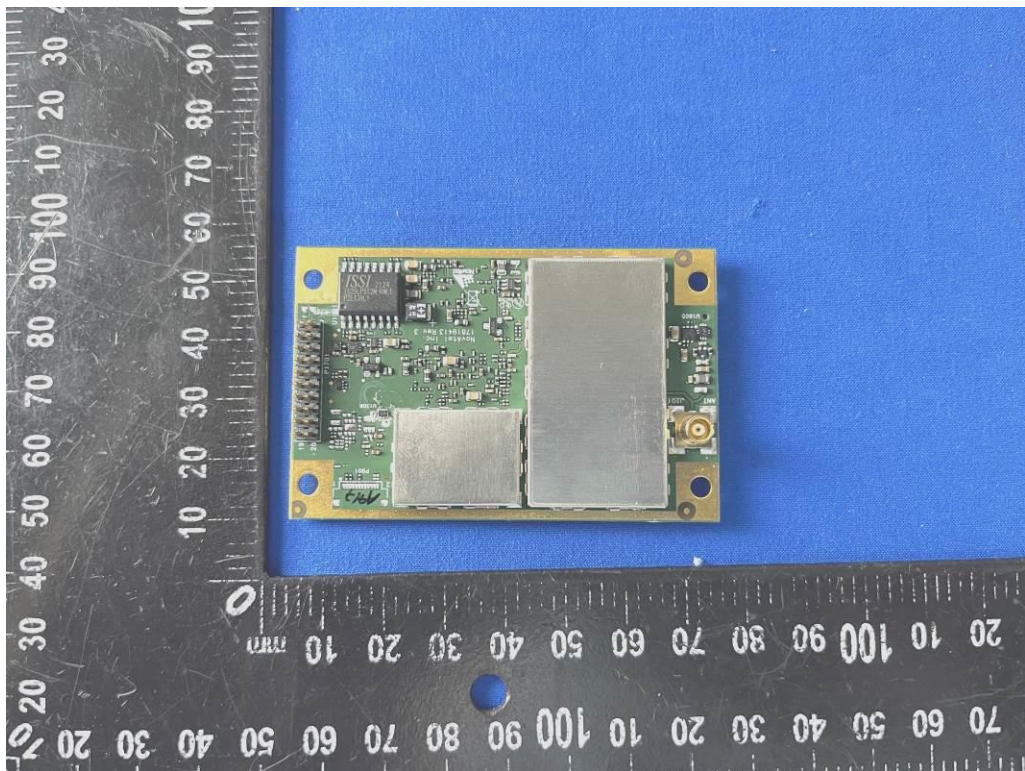

Internal view(PA-3 Plus)



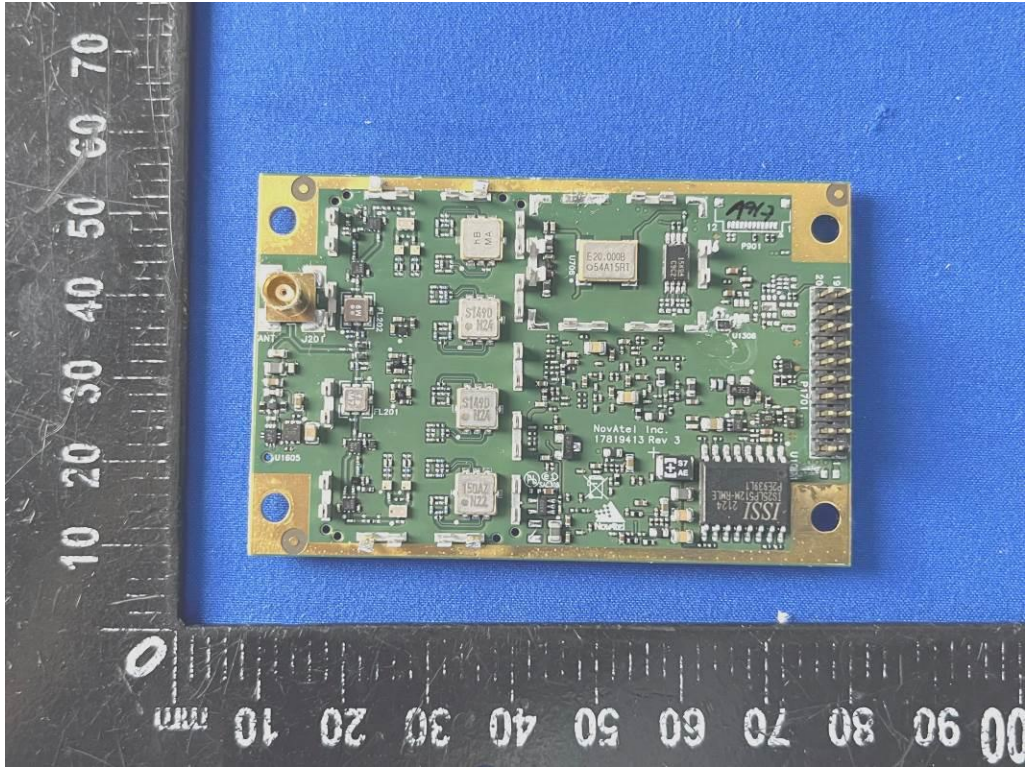

Internal view(PA-3 Plus)

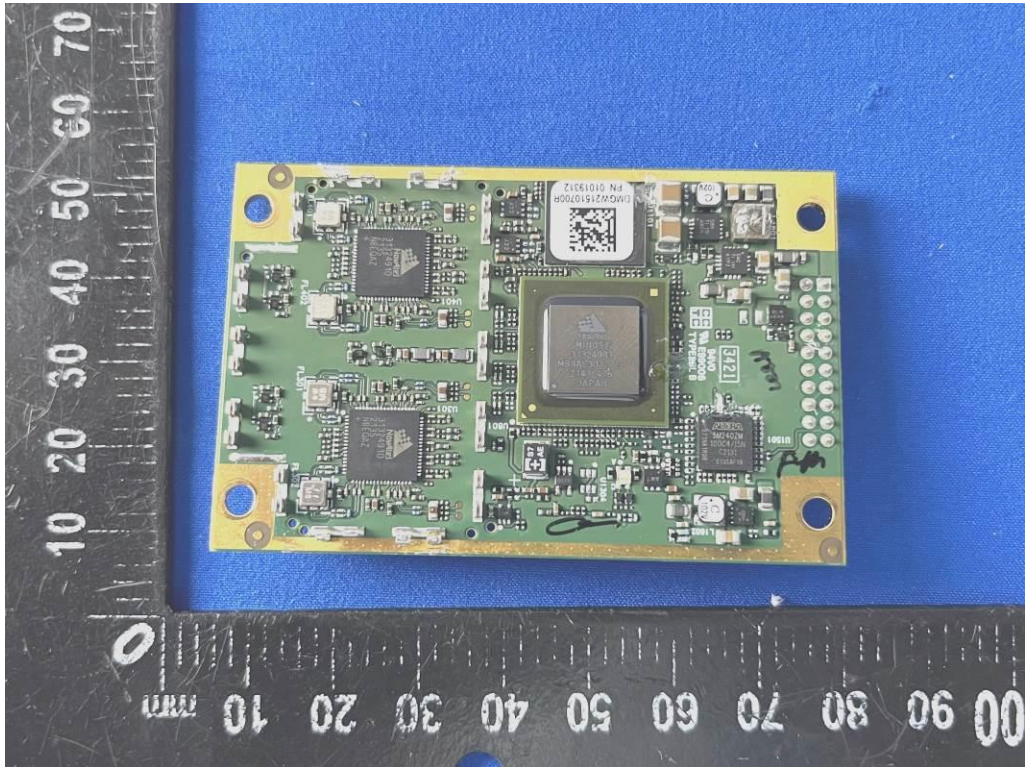

Internal view(PA-3 Plus)



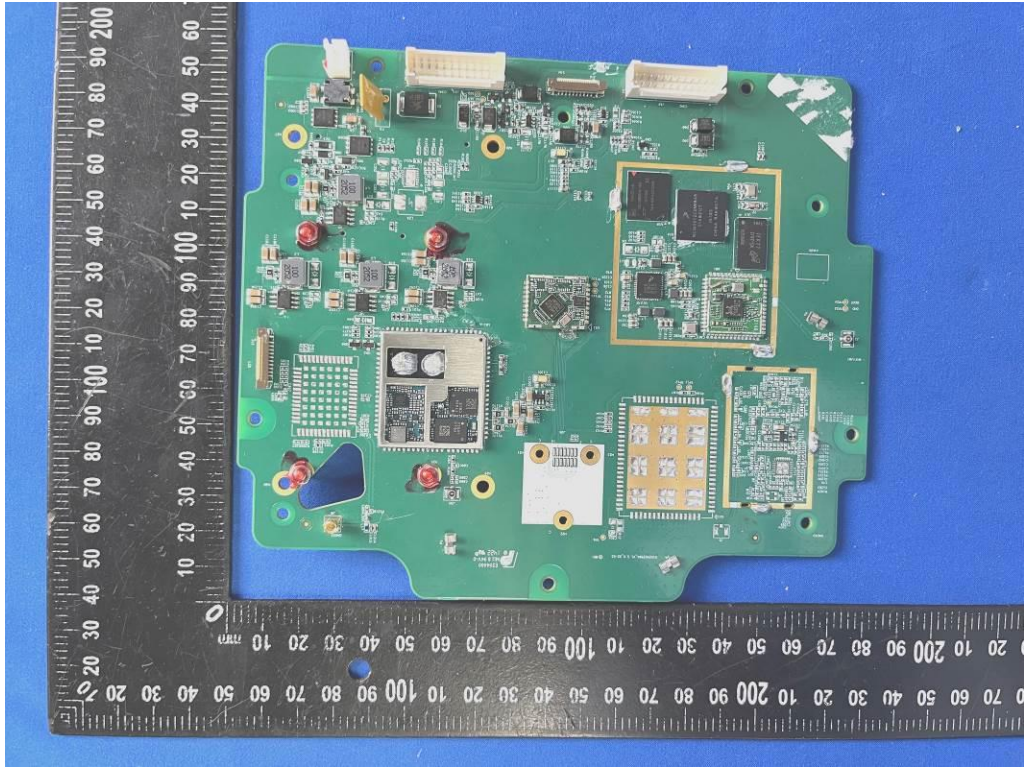

Internal view(PA-3 Plus)

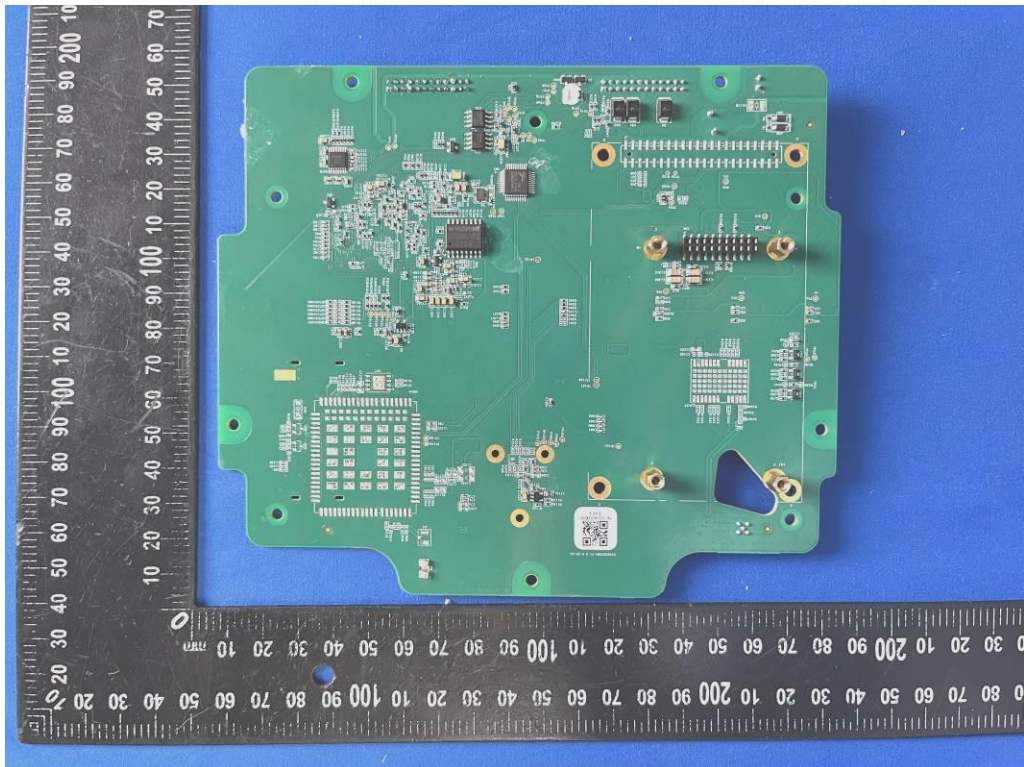

Internal view(PA-3 Plus)







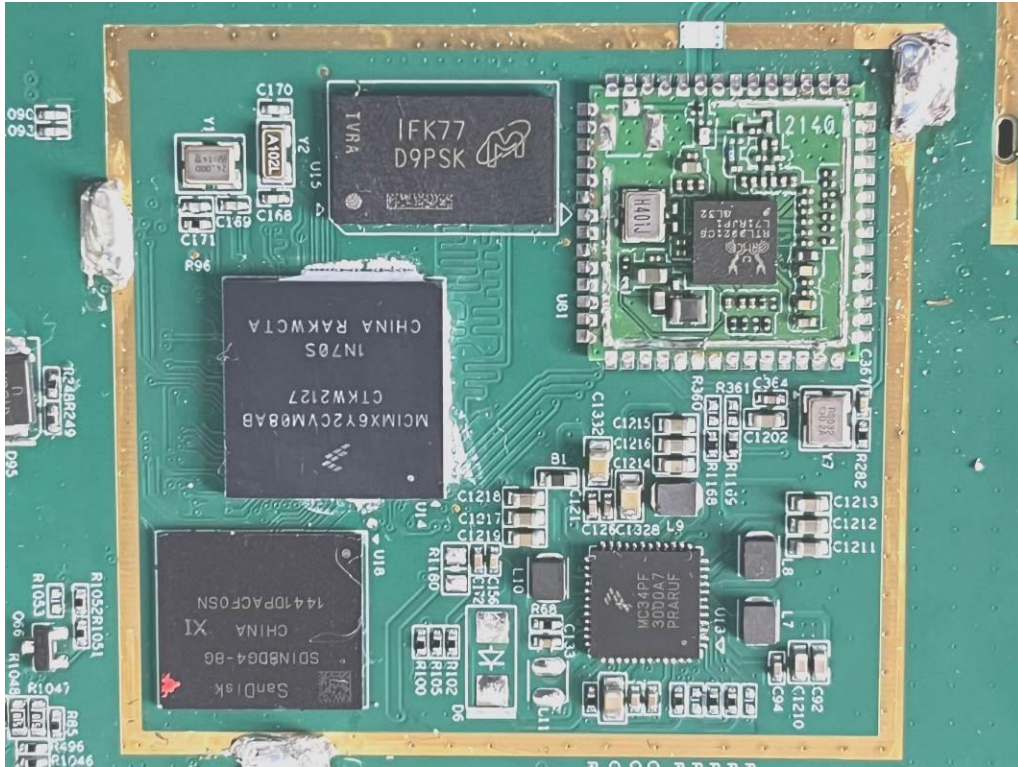

Internal view(PA-3 Plus)

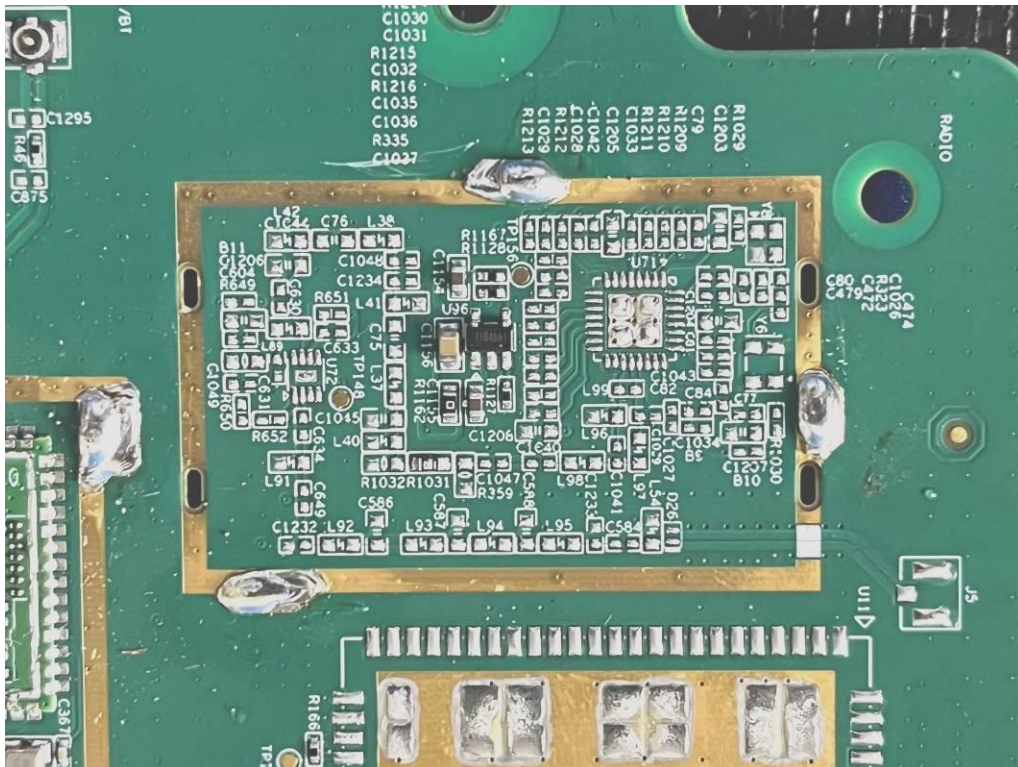

Internal view(PA-3 Plus)



Model No.: PA-3 SE

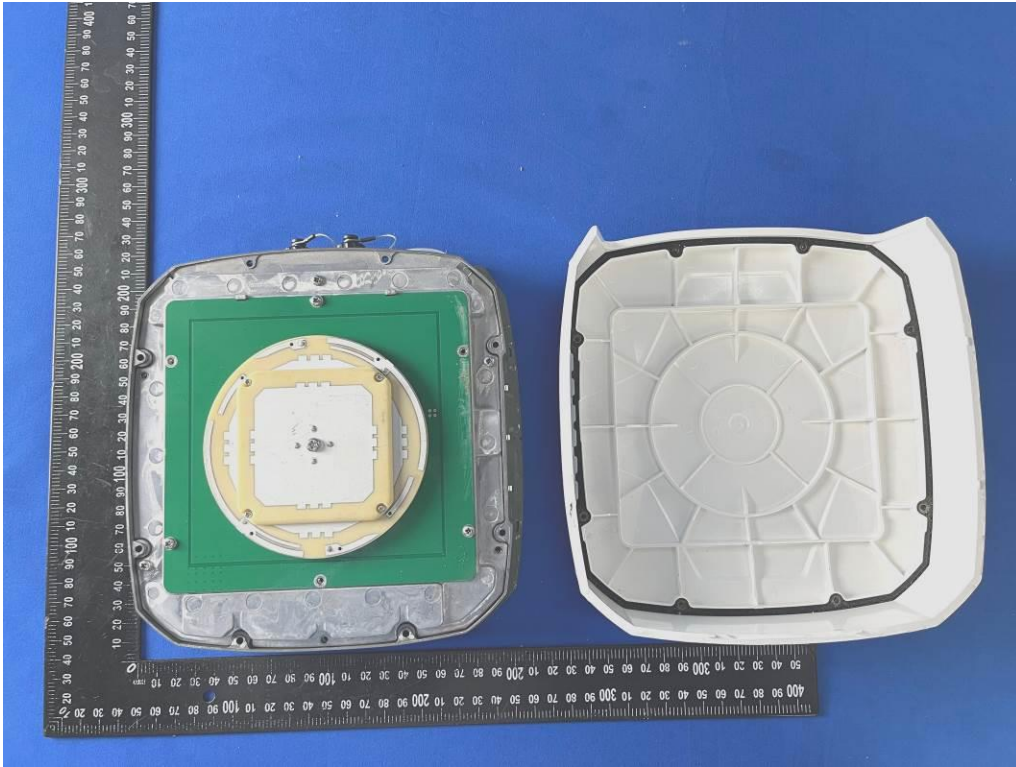

Internal view(PA-3 SE)

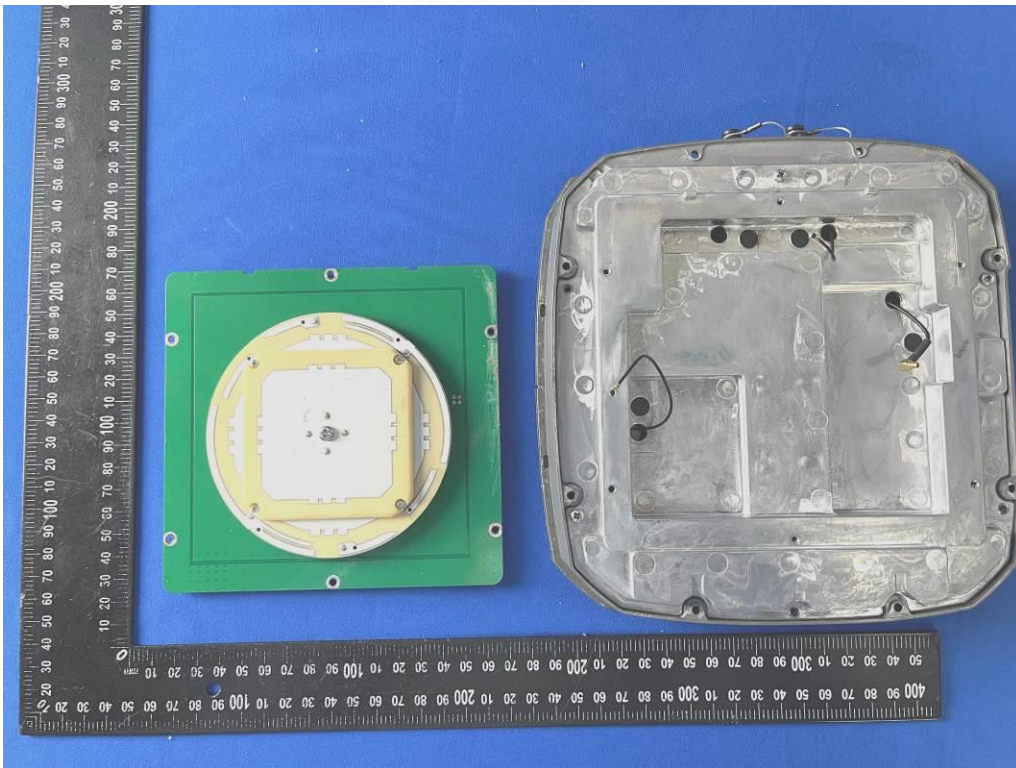

Internal view(PA-3 SE)



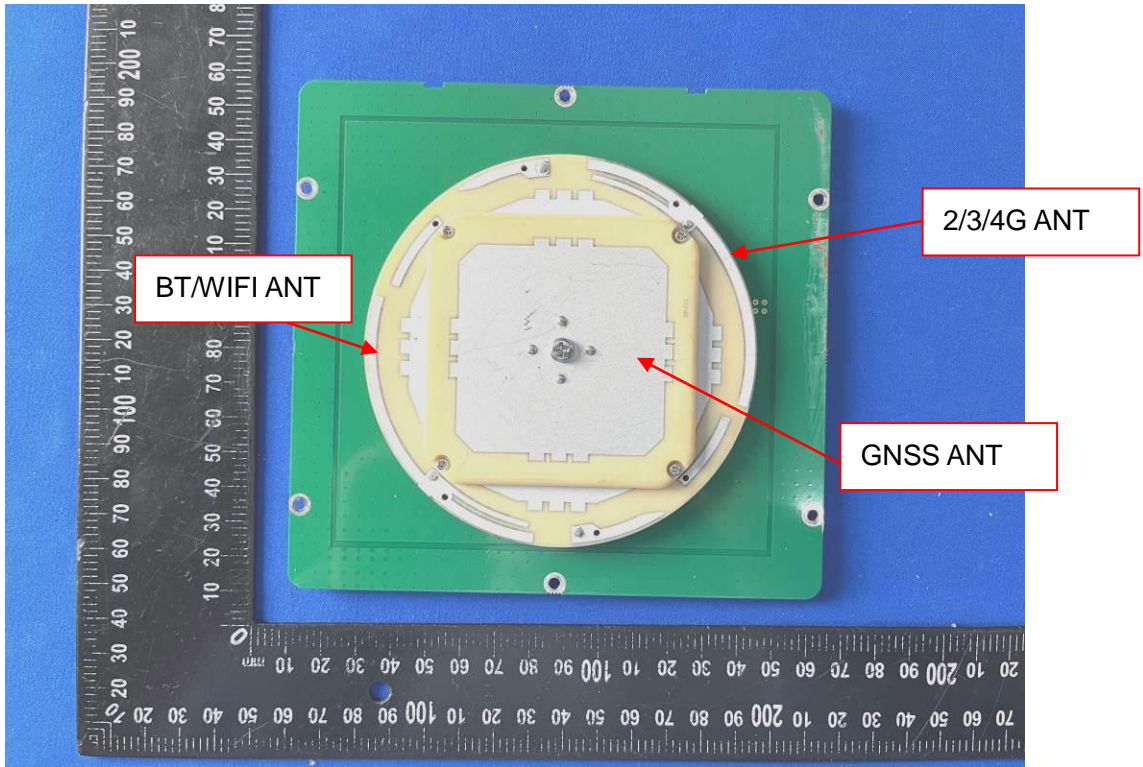

Internal view(PA-3 SE)

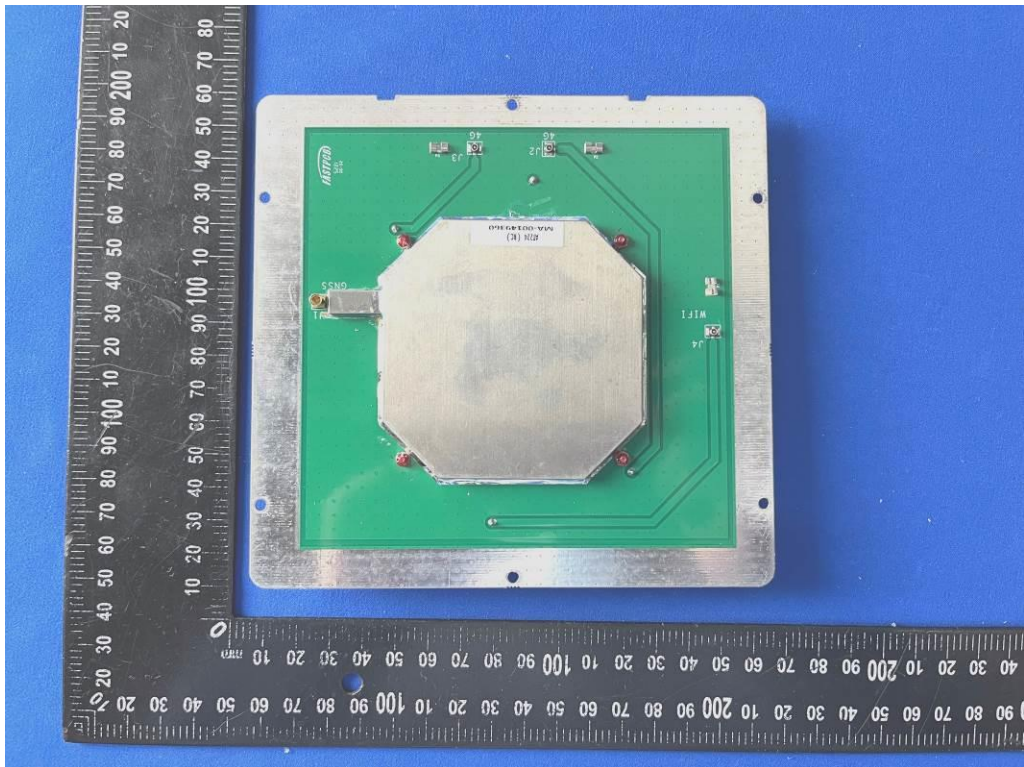

Internal view(PA-3 SE)





Internal view(PA-3 SE)

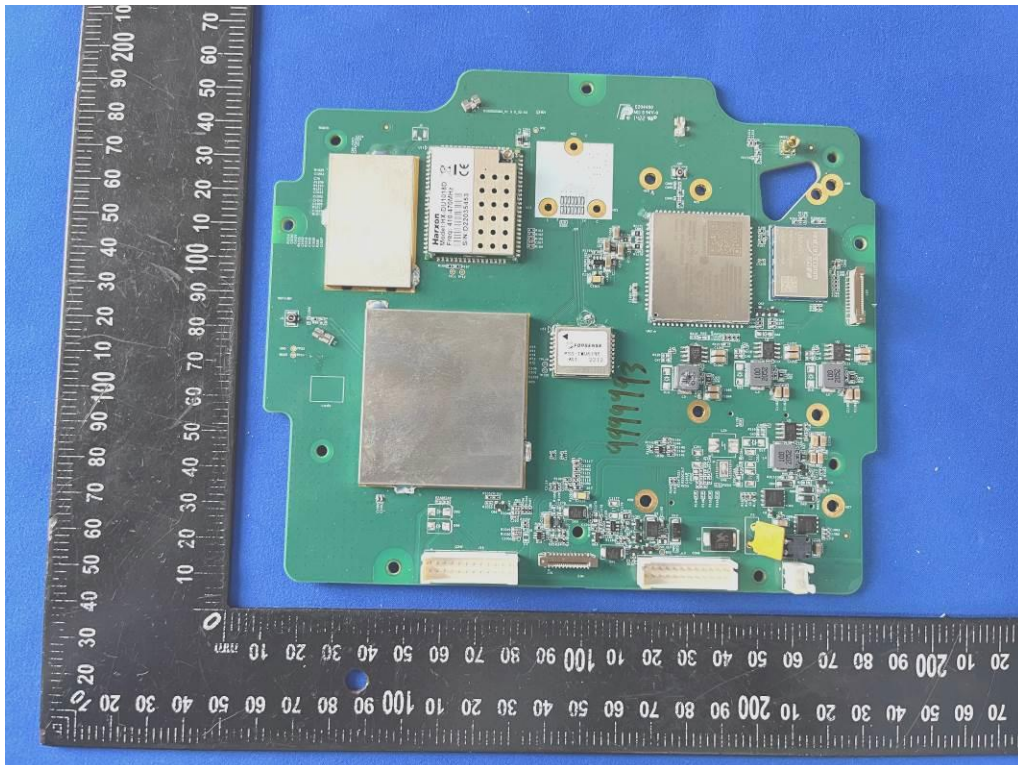

Internal view(PA-3 SE)



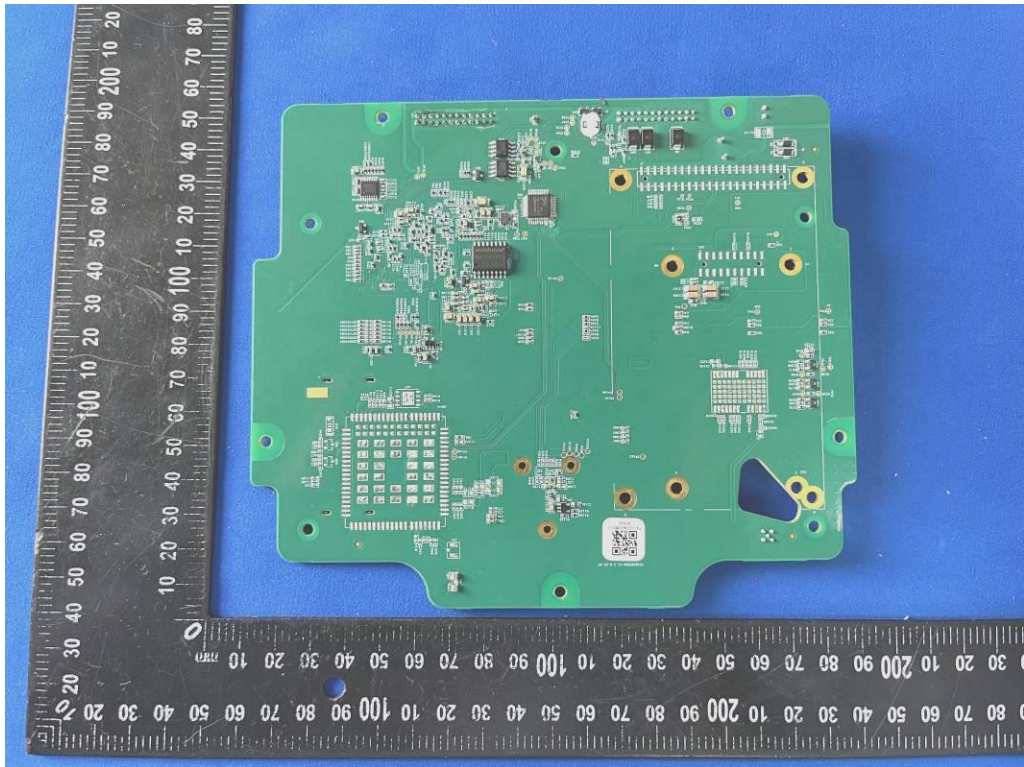

Internal view(PA-3 SE)



Internal view(PA-3 SE)











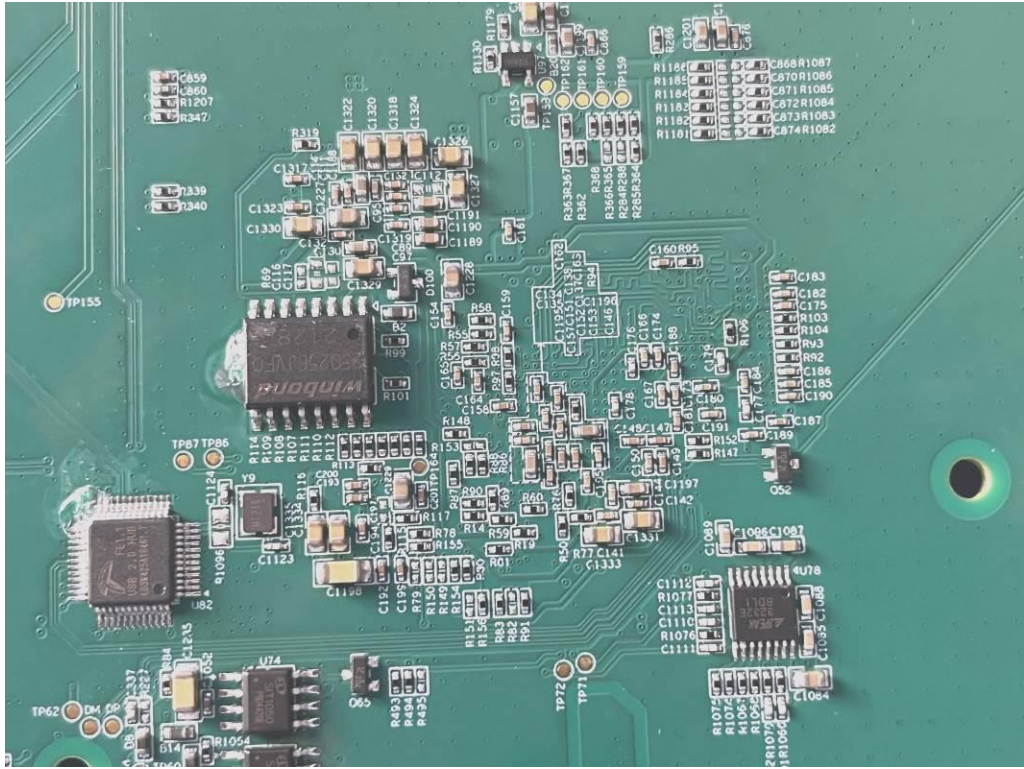

Internal view(PA-3 SE)

Model No.: PA-3 Pro

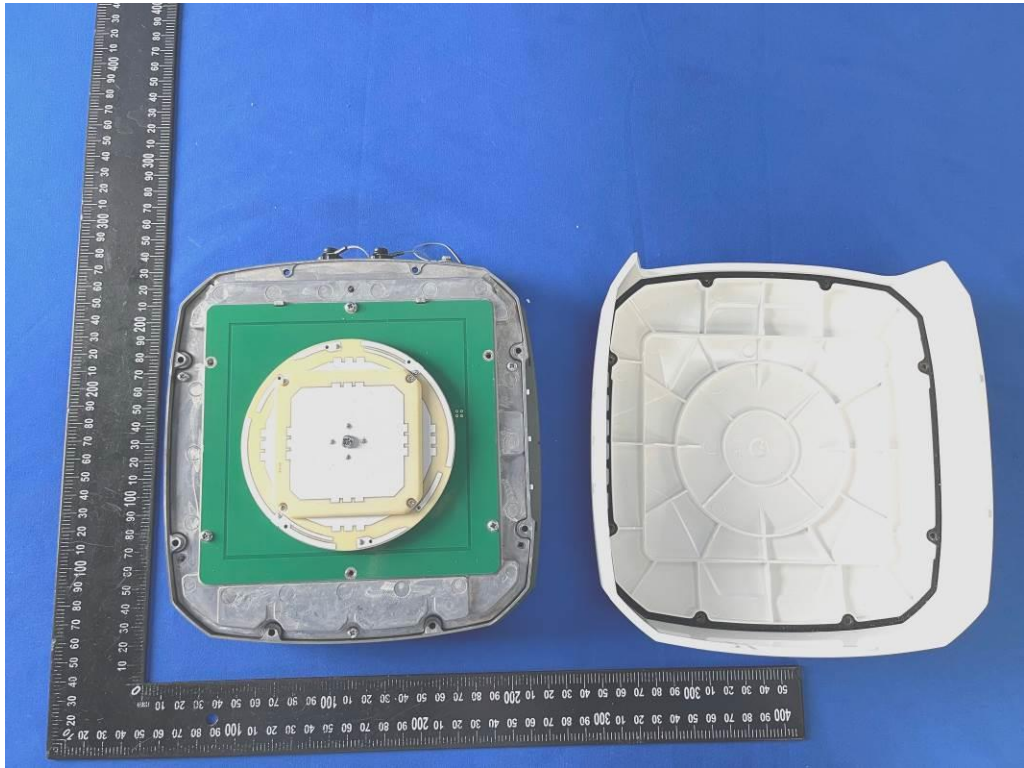

Internal view(PA-3 Pro)