



CHCNAV i93 GNSS User Guide



Make your work more efficient

Table of Content

Table of Content	2
Preface	5
Copyright.....	5
Safety Warnings.....	5
FCC Interference Statement	5
CE Interference Statement	6
1 Introduction.....	7
1.1 Safety Information.....	7
1.1.1 Warnings and Cautions.....	7
1.2 Regulations and Safety	7
1.2.1 Use and Care.....	8
1.3 Technical Support.....	8
1.4 Disclaimer	8
1.5 Your Comments	8
2 Getting Started with i93	9
2.1 About the Receiver	9
2.2 Parts of the Receiver	9
2.2.1 Front Panel	9
2.2.2 Lower Housing.....	11
2.2.3 Receiver Ports.....	11
2.3 Batteries and Power	13
2.3.1 Batteries	13
2.3.2 The Internal Battery.....	13
2.3.3 Battery Safe	14
2.3.4 External Power Supply	15
2.4 Inserting SIM Card	16
2.5 Product Basic Supply Accessories.....	17
2.5.1 Base Kit Basic Supply	17
2.5.2 Rover Kit Basic Supply	18
2.6 Connecting to an Office Computer.....	19
2.7 Connecting to a Controller	20
2.7.1 Connecting via Wi-Fi with LandStar 7 Software	20
2.7.2 Connecting via Bluetooth with LandStar 7 Software.....	22
2.8 Downloading Logged Data.....	24
2.8.1 FTP Download.....	24
2.8.2 Web Server Download.....	25

2.8.3	USB Download	26
3	Front Panel Operation	28
3.1	Main Operation Menus	28
3.2	Configure the Working Mode.....	31
4	Equipment Setup and Operation.....	36
4.1	Post-processing Base Station Setup	36
4.2	Real-Time Base Station Setup.....	38
4.2.1	Internal Cellular or UHF	38
4.2.2	External UHF	39
4.3	Real-Time Rover Station Setup.....	42
4.4	Working with the Tilt Compensation	44
4.4.1	Operation Steps.....	44
4.4.2	Notes of using tilt measurement.....	46
5	Configuring Through a Web Browser.....	52
5.1	Status Menu	54
5.1.1	Position Submenu.....	54
5.1.2	Activity Submenu.....	54
5.1.3	Google Map Submenu	55
5.2	Satellites Menu.....	56
5.2.1	Tracking Table Submenu	56
5.2.2	Tracking Info. Table Submenu	57
5.2.3	Tracking Skyplot Submenu.....	57
5.2.4	Satellite Activation Submenu	58
5.3	Receiver Configuration Menu	59
5.3.1	Description	59
5.3.2	Antenna Configuration Submenu.....	60
5.3.3	Reference Station Settings Submenu	60
5.3.4	Receiver Reset Submenu	63
5.3.5	Languages Submenu.....	63
5.3.6	User Management Submenu.....	64
5.3.7	HCPPP Settings	64
5.4	Data Recording Menu.....	65
5.4.1	Log Settings Submenu	65
5.4.2	FTP Push Settings Submenu	67
5.4.3	FTP Push Log Submenu.....	68
5.4.4	Data Download Submenu.....	69
5.5	IO Settings Menu	71
5.5.1	IO Settings Submenu	71
5.6	Network Setting Menu	78
5.6.1	Description Submenu	78
5.6.2	Mobile Network Setting Submenu	79

5.6.3	Email Alarm Submenu	79
5.6.4	HTTP Submenu	80
5.6.5	HTTPS Submenu	81
5.6.6	FTP Service Submenu	81
5.7	Module Setting Menu.....	82
5.7.1	Description Submenu	82
5.7.2	WiFi Submenu	82
5.7.3	Bluetooth Settings Submenu.....	83
5.7.4	Radio Settings Submenu.....	84
5.8	Firmware Menu	85
5.8.1	Firmware Info Submenu	85
5.8.2	Hardware Version Submenu	85
5.8.3	Config File Submenu.....	86
5.8.4	System Log Download Submenu	86
5.8.5	User Log Submenu.....	86
5.8.6	Firmware Update Submenu.....	87
5.8.7	GNSS Board Upgrade Submenu.....	88
5.8.8	Radio Upgrade Submenu.....	88
5.8.9	Upgrade Online Submenu	88
5.8.10	GNSS Registration Submenu.....	89
5.9	Cloud Service Setting Menu	90
5.9.1	Cloud Service Setting Submenu.....	90
A Communication Ports Definition		91
AI CHC i93 Receiver IO Port (7-pin Lemo Port) Definition		91

Preface

Copyright

Copyright 2016-2017

CHC | Shanghai Huace Navigation Technology Ltd. All rights reserved. The CHC are trademark of Shanghai Huace Navigation Technology Limited. All other trademarks are the property of their respective owners.

Trademarks

All product and brand names mentioned in this publication are trademarks of their respective holders.

Safety Warnings

The Global Positioning System (GPS) is operated by the U.S. Government, which is solely responsible for the accuracy and maintenance of the GPS network. Accuracy can also be affected by poor satellite geometry and obstructions, like buildings and heavy canopy.

FCC Interference Statement

This equipment has been designed to comply with the limits for a Class B digital device, pursuant to part 15 of the FCC Rules in the Portable Mode. These limits are designed to provide reasonable protection against harmful interference in a residential installation.

Operation is subject to the following two conditions: (1) this device may not cause harmful interference and (2) this device must accept any interference received, including interference that may cause undesired operation.

CE Interference Statement

Declaration of Conformity: Hereby, Shanghai Huace Navigation Technology Ltd. declares that this i93 is in compliance with the essential requirements and other relevant provisions of Directive 2014/53/EU. A copy of the Declaration of conformity can be found at Shanghai Huace Navigation Technology Ltd.

Conformity to Japanese regulations

Japanese Radio Law and Japanese Telecommunications Business Law Compliance.

- This device is granted pursuant to the Japanese Radio Law and the Japanese Telecommunications Business Law .
- This device should not be modified (otherwise the granted designation number will become invalid).

1 Introduction

The i93 GNSS Receiver User Guide describes how to set up and use the CHC® i93 GNSS receiver. In this manual, “the receiver” refers to the i93 GNSS receiver unless otherwise stated. Even if you have used other Global Navigation Satellite Systems (GNSS) products before, CHC recommends that you spend some time reading this manual to learn about the special features of this product. If you are not familiar with GNSS, go to www.chcnav.com for an interactive look at CHC and GNSS.

1.1 Safety Information

1.1.1 Warnings and Cautions

An absence of specific alerts does not mean that there are no safety risks involved.

A Warning or Caution information is intended to minimize the risk of personal injury and/or damage to the equipment.



WARNING - A Warning alerts you to a potential misused or wrong setting of the equipment.



CAUTION - A Caution alerts you to a possible risk of serious injury to your person and/or damage to the equipment.

1.2 Regulations and Safety

The receivers contain a built-in wireless modem for signal communication through Bluetooth® wireless technology or through external communication data link. Regulations regarding the use of the wireless modem vary greatly from country to country. In some countries, the unit can be used without obtaining an end-user license. However, in some countries, the administrative permissions are required. For license information, consult your local dealer. Bluetooth® operates in license-free bands.

Before operating a i93 GNSS receiver, determine if authorization or a license to operate the unit is required in your country. It is the responsibility of the end-user to obtain an operator's permit or license for the receiver for the location or country of use.

1.2.1 Use and Care

This receiver is designed to withstand the rough environment that typically occurs in the field. However, the receiver is high-precision electronic equipment and should be treated with reasonable care.



CAUTION - Operating or storing the receiver outside the specified temperature range will cause irreversible damage.

1.3 Technical Support

If you have a problem and cannot find the information you need in this manual or CHC website (www.chcnav.com), contact your local CHC dealer from which you purchased the receiver(s).

If you need to contact CHC technical support, please contact us by email (support@chcnav.com) or Skype (chc_support).

1.4 Disclaimer

Before using the receiver, please make sure that you have read and understood this User Guide, as well as the safety information. CHC holds no responsibility for the wrong operation by users and for the losses incurred by the wrong understanding about this User Guide. However, CHC reserves the rights to update and optimize the contents in this guide regularly. Please contact your local CHC dealer for new information.

1.5 Your Comments

Your feedback about this user guide will help us to improve it in future revision. Please email your comments to support@chcnav.com.

2 Getting Started with i93

2.1 About the Receiver

The new CHCNAV i93 GNSS receiver offers integrated IMU-RTK technology to provide a robust and accurate GNSS positioning in any circumstances. Unlike the standard MEMS based GNSS receivers, the i93 GNSS IMU-RTK combines state-of-the-art GNSS RTK engine, calibration-free professional IMU sensor and advanced GNSS tracking capabilities. Survey projects are achieved with high productivity and reliability pushing the boundaries of conventional GNSS RTK survey.

The LCD panel enables user to check satellite-tracking status, internal battery status, Wi-Fi status, working mode, data logging status and basic receiver information. Bluetooth and Wi-Fi technology provides cable-free communication between the receiver and controller.

The receiver can be used as the part of an RTK GNSS system with CHC LansStar7 software. Moreover, user can download the GNSS data that recorded in the internal memory of receiver to a computer.

The receiver can be used as the part of an RTK GNSS system with CHC LandStar 7 software. And you can download the GNSS data that recorded in the internal memory of receiver to a computer.

To configure the receiver for performing a wide variety of functions, you can use the web interface by connecting the receiver with PC or smartphone through Wi-Fi.

2.2 Parts of the Receiver

The operating controls are all located on the front panel. SIM card slot is on the backside. Serial ports and connectors are located on the bottom of the unit.

2.2.1 Front Panel

The following figure shows a front view of the receiver.



The front panel contains two indicator LEDs and two buttons.



Name	Description
Correction LED (Yellow/Green)	<ul style="list-style-type: none"> Indicates whether the receiver is transmitting/receiving differential data. As a Base station: successfully transmitting differential data, flash yellow light. As a Rover station: successfully receiving differential data from Base station will flash yellow light when it is single or float, flash green light when it is fixed.
Satellite LED (Blue)	<ul style="list-style-type: none"> Shows the number of satellites that the receiver has tracked. When the receiver is searching satellites, the blue LED flashes once every 5 seconds. When the receiver has tracked N satellites, the blue LED will flash N times every 5 seconds.
Fn button (White)	<ul style="list-style-type: none"> Move to next line of the menus or options. Move to next character of the value that you want to make change. Cancel the change you make on a function.

<p>Power button (White)</p>	<ul style="list-style-type: none"> • Works as a Power button: • Press and hold this button for 3 seconds to turn on or turn off the receiver. • Works as a Confirm button • Hold Fn button and press this button for 5 times continuously to reset the mainboard.
---------------------------------	---

2.2.2 Lower Housing

The lower housing contains one SIM card slot, one TNC radio antenna connector, one communication and power port and one USB type C communication and power port.

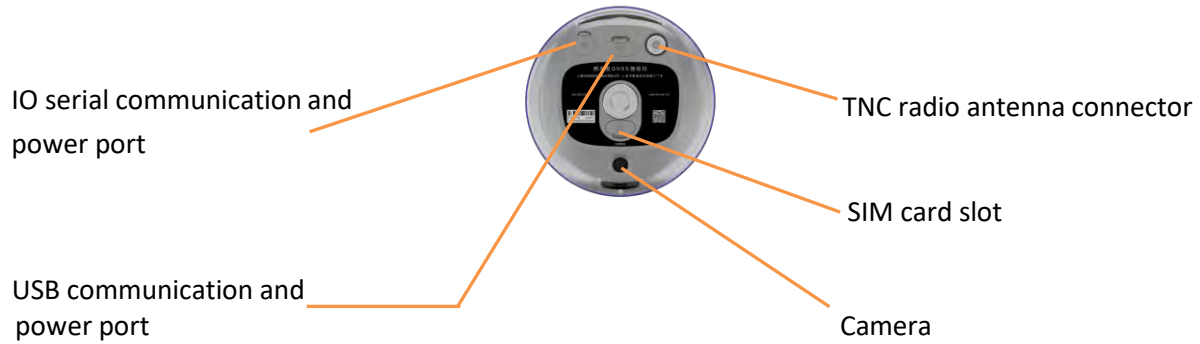

2.2.3 Receiver Ports

Port	Name	Description
	IO port	<ul style="list-style-type: none"> • This port is a 7-pin LEMO connector that supports RS-232 communications and external power input. • Users can use HCE600 Type-c Cable supplied with the system to realize RS-232 communications between the receiver and computer or controller. Also, users can use a 7-pin cable to transmit differential data to an external radio.
	USB port	<ul style="list-style-type: none"> • This port is a type-C USB connector that supports USB communications. • Users can use USB Cable supplied with the system to download the logged data to a computer.
	Radio antenna connector	<ul style="list-style-type: none"> • Connect a radio antenna to internal radio of the receiver. And this connector is not used if you are using an external radio.

2.3 Batteries and Power

2.3.1 Batteries

The receiver has an built-in non-removable Lithium-ion battery.

2.3.2 The Internal Battery

The rechargeable Lithium-ion battery is supplied partially charged.



WARNING – Charge and use the rechargeable Lithium-ion battery only in strict accordance with the instructions. Charging or using the battery in unauthorized equipment can cause an explosion or fire and can result in personal injury and/or equipment damage.

To prevent injury or damage:

- Do not charge or use the battery if it appears to be damaged or leaking.
- Charge the Lithium-ion battery only in a CHC product that is specified to charge it. Be sure to follow all instructions that are provided with the battery charger.
- Discontinue charging a battery that gives off extreme heat or a burning odor.
- Use the battery only in CHC equipment that is specified to use it.
- Use the battery only for its intended use and according to the instructions in the product documentation.

2.3.3 Battery Safe

 **WARNING** – Do not damage the rechargeable Lithium-ion battery. A damaged battery can cause an explosion or fire and can result in personal injury and/or property damage.

To prevent injury or damage:

- Do not use or charge the battery if it appears to be damaged. Signs of damage include, but are not limited to discoloration, warping, and leaking battery fluid.
- Do not expose the battery to fire, high temperature, or direct sunlight.
- Do not immerse the battery in water.
- Do not use or store the battery inside a vehicle under hot weather condition.
- Do not drop or puncture the battery.
- Do not open the battery or short-circuit its contacts.

 **WARNING** – Avoid contact with the rechargeable Lithium-ion battery if it appears to be leaking. Battery fluid is corrosive and contact with it can result in personal injury and/or property damage.

To prevent injury or damage:

- If the battery leaks, avoid with the battery fluid.
- If battery fluid gets into your eyes, immediately rinses your eyes with clean water and seek medical attention. Please do not rub your eyes!
- If battery fluid gets onto your skin or clothing, immediately use clean water to wash off the battery fluid.

2.3.4 External Power Supply

Two methods are available for providing the external power to the receiver by the GPS to PC Data Cable+ Power Adapter, or GPS to PC Data Cable + external power cable (option purchase) + vehicle battery. In

the office:

The Power Adapter is connecting with AC power of 100-240V, the output port of the Power Adapter connects with the Power Port of the GPS to PC Data Cable.

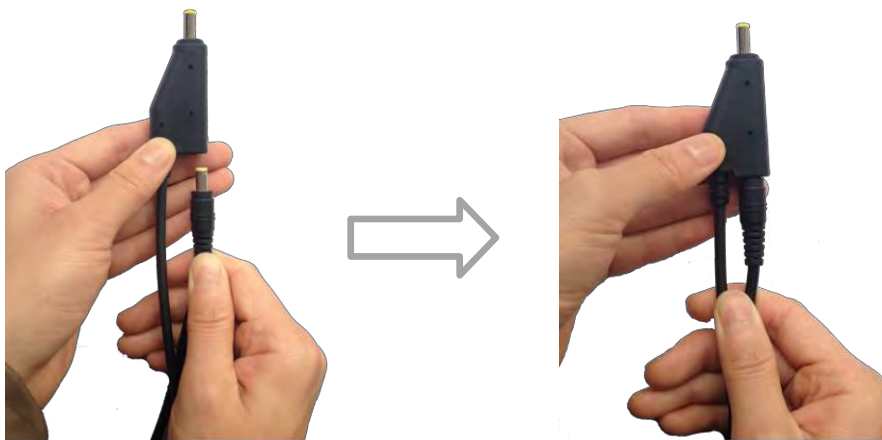

In the field:

The external power cable is connecting with a vehicle battery, the output port of the external power cable connects with the Power Port of the GPS to PC Data Cable.



WARNING – Use caution when connecting external power cable's clip leads to a vehicle battery. Do not allow any metal object to connect (short) the battery's positive (+) terminal to either the negative (-) terminal or the metal part of the vehicle battery. This could result in high current, arcing, and high temperatures, exposing the user to possible injury.

2.4 Inserting SIM Card

- (a) Open the SIM card slot cover.
- (b) Insert the SIM card with the contacts facing upward, as indicated by the SIM card icon next to the SIM card slot.
- (c) Close the cover to prevent water immersion.
- (d) To eject the SIM card, slightly push it in to trigger the spring-loaded release mechanism











Insert the SIM card with the contacts facing upward, as indicated by the SIM card icon next to the SIM card slot.

To eject the SIM card, slightly push it in to trigger the spring-loaded release mechanism.

Tip – The SIM card is provided by your cellular network service provider.

2.5 Product Basic Supply Accessories

2.5.1 Base Kit Basic Supply

Item	Picture
i93 GNSS Receiver	
UHF Whip Antenna (410-470 MHz)	
Power Adapter	
USB Type-C	
H.I. Tape	
Extension pole	
Tribrach with optical plummet	
Auxiliary H.I. Tool	
Transport Hard Case	

2.5.2 Rover Kit Basic Supply

Item	Picture
i93 GNSS Receiver	
UHF Whip Antenna (410-470 MHz)	
Power Adapter	
USB Type-C	
2M Range Pole w/bag	
Auxiliary H.I. Tool	
Transport Hard Case	

2.6 Connecting to an Office Computer

The receiver can be connected to an office computer for serial data transfer or settings via a HCE600 USB Type-C. Before you connect to the office computer, ensure that the receiver is powered on by internal battery or external power.

The following figure shows how to connect to the computer for serial data transfer or settings:

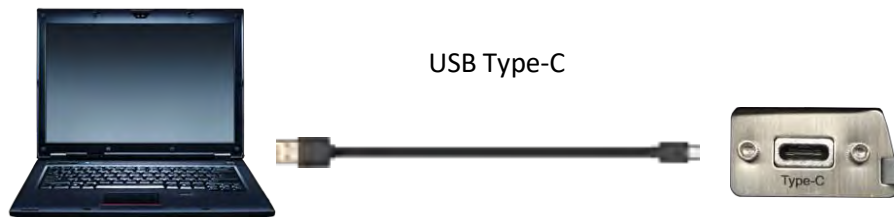

2.7 Connecting to a Controller

2.7.1 Connecting via Wi-Fi with LandStar 7 Software

Turn on the controller → run LandStar 7 → go to **Config** main menu → tap **Connect**.

In the *Connect* screen, select **CHC** for the *Manufacture* field, **i93** for *Device Type* field, **WIFI** for *Connection Type* field.

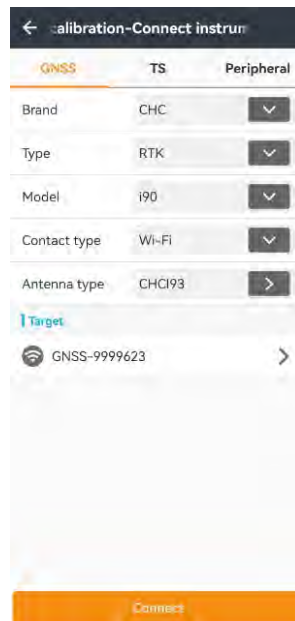

Tap the Wireless Lan icon on the right side to select the hot spot → Switch on the WiFi module by the top switch → select the target device in the list.



Tap **Connect** to link to the hot spot. If the first-time connection to this hot spot, user may type

in the password.



Tip – The Wi-Fi key of the receiver is 12345678 by default.

Tap the **Connect** button to build the connection.

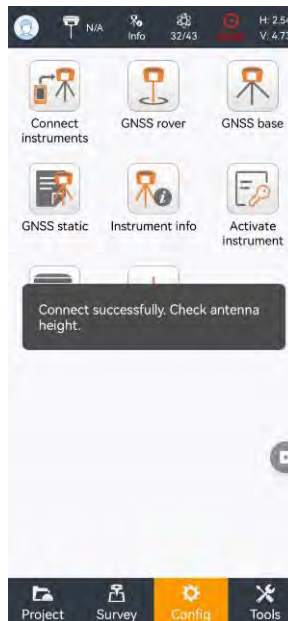

2.7.2 Connecting via Bluetooth with LandStar 7 Software

Turn on the controller → run LandStar 7 → go to **Config** main menu → tap **Connect**.

In the *Connect* screen, select **CHC** for the *Manufacture* field, **i93** for *Device Type* field, **Bluetooth** for *Connection Type* field.

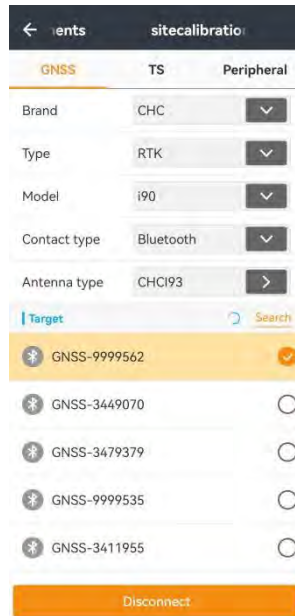

Tap the **Bluetooth Manager** and turn on the **Bluetooth** function to search Bluetooth device around → select the target device in the list → Tap back button → select the target device in the Bluetooth manager list.

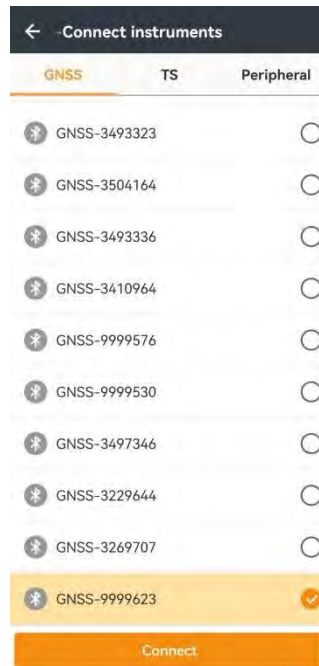

Tap the **Connect** button to build the connection.

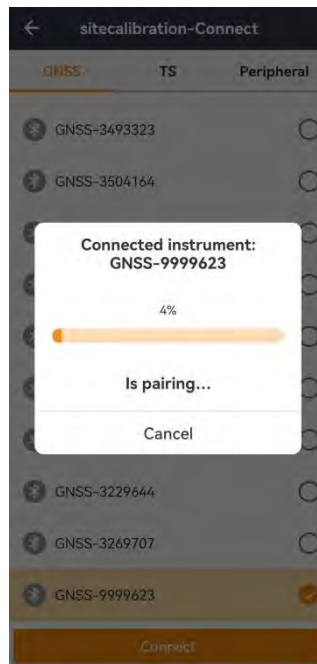

2.8 Downloading Logged Data

Data logging involves the collection of GNSS measurement data over a period at a static point or points, and subsequent post-processing of the information to accurately compute baseline information. Data logging using receivers requires access to suitable GNSS post-processing software such as the CHC Geomatics Office (CGO) Software.

2.8.1 FTP Download

The procedures of downloading logged data through FTP are as follows:

- (1) Switch on the receiver, search its Wi-Fi in the computer and connect.
- (2) After the successful connection, open the file manager in the computer and input “ftp:\\192.168.1.1” in the address box.

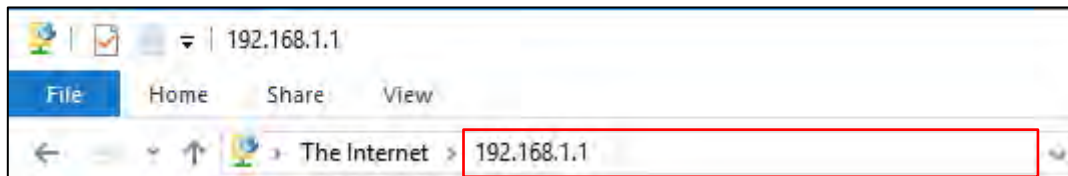

- (3) Input user name and password, the default user name and password are “ftp”.

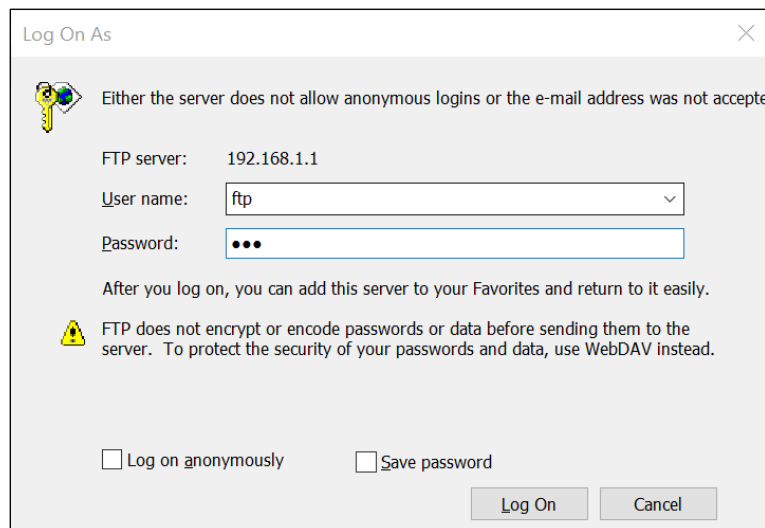

- (4) Double click the folder “repo_receiver SN” (take 3411955 as example), you will see 9 folders. The “push_log” folder is used to save the log files, and the other 8 folders represent different logging sessions and are used for store static data.

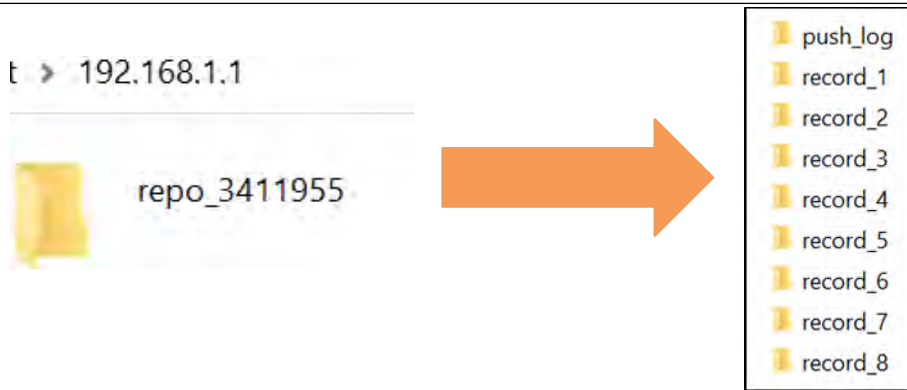

(5) Double click the folder that you have configured to store the static data, you will see the folder(s) created by the i93 system automatically and named by the date which is decided by GPS time when you start to log data.

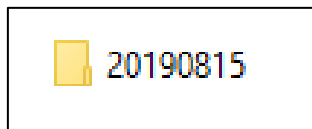

(6) Select the destination folder and double click it, two folders named as different data format (hcn and rinex) will be displayed.

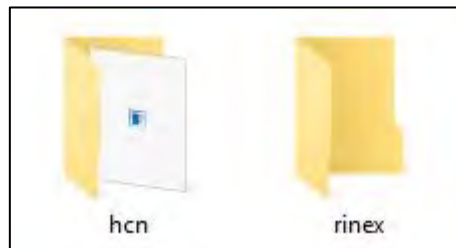

(7) Select the data format that you configured to save the static data, you will find the static raw data.

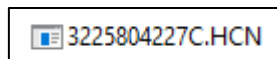

Notes: For hcn files, the name of the file is represented as XXXXXXDDDNN, where XXXXXX is the SN of the receiver, DDD is day of year, and NN is the recording session.

 **WARNING** – The static data will be saved in the first logging session, the “record_1” folder, by default. Old files will be deleted if the storage space is full. If you configure not to auto delete old files when the memory is low, the receiver will stop data logging.

2.8.2 Web Server Download

The procedures of downloading logged data through web server refer to [5.4.4 Data Download Submenu](#).

2.8.3 USB Download

The procedures of downloading logged data in the receiver are as follows:

(1) Switch on the receiver and connect it with a computer by HCE600 Type-C. After the successful connection, a removable disk named as the Serial Number (SN) of the receiver will appear on the computer.

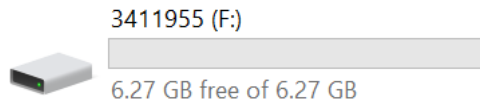

(2) Double click the removable disk and you will see the folder named as “repo”.

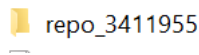

(3) Double click this folder, you will see 9 folders. The “push_log” folder is used to save the log files, and the other 8 folders represent different logging session and are used for store static data.

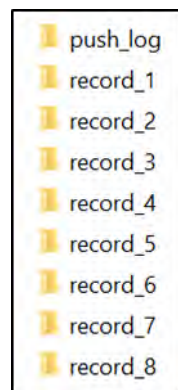

(4) Double click the folder that you have configured to store the static data, you will see the folder(s) created by the i93 system automatically and named by the date which is decide by GPS time when you start to log data.

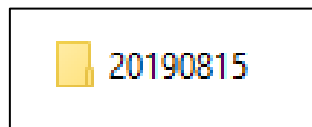

(5) Select the destination folder and double click it, and then two folders named as different data format (hcn and rinex) will be displayed.

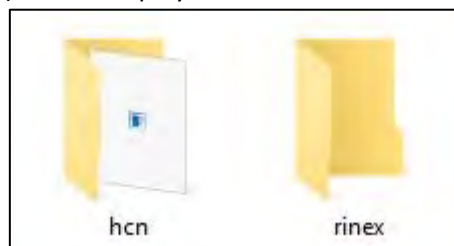

(6) Select the data format that you have configured to save the static data, you will find the static raw data.

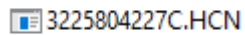
A screenshot of a file name displayed in a text box. The file name is "3225804227C.HCN". To the left of the text is a small icon representing a document or file.

Tip – For hcn files, the name of the file is represented as XXXXXDDDNN, where XXXXXX is the SN of the receiver, DDD is day of year, and NN is the recording session.



WARNING – The static data will be saved in the first logging session, the “record_1” folder, by default. Old files will be deleted if the storage space is full. If you configure not to auto delete old files when the memory is low, the receiver will stop data logging.

3 Front Panel Operation

The front panel contains one LCD screen, two indicator LEDs, and two buttons. The operating controls are all located on the front panel.

3.1 Main Operation Menus

The top-level menu of the front panel includes 6 parts: Info, SV, Mode, Power, Data and Set. Info is the basic information of firmware such as SN, PN and etc. SV is the display of satellite situation. Mode is the important part which illustrate the work mode and users can select the mode according to their needs. Power shows the electric quantity of two batteries. Data is used to set static mode and Set is to set the device according to personal habits including language, brightness, etc.

The details of main operation are as follows and they are concluded two tables. The first table includes 5 parts: Info, SV, Power, Data and Set and the second table displays details of Data.

Top-level Menu	Second-level Menu	Description
Info	SN 3411956 PN A11611980901070507 -015701 -020104 Version 2.0.7 Register 2030/12/31 Static off Sample 5S Format HCN Diff Age 0.0S Network No Sim Card IMEI 861529049455435	Describe the main information of this machine. SN displays the Serial Number of the receiver. PN displays the Part Number of the receiver. Version displays the firmware version. Register displays the expiry date of registration code. Static displays if the static is on or not. Format displays the data type. Network displays the if a sim card inserts the RTK. IMEI is International Mobile Equipment Identity which is used to identify the RTK.
SV	Total: 30/30 GPS: 10/10 BDS: 10/10 GLO: 4/6 GAL: 4/4	Indicate the total number of satellites that have been tracked and the number of satellites tracked of each constellation, where BDS represents BeiDou, GLO represents GLONASS, and GAL represents Galileo.

Power	Power 95%	Indicates the remaining power of the battery
Set	Brightness High	Press Enter to select the brightness including High, Medium and low.
	Standby Time 10s	Press Enter to select standby time including 5s, 10s, 30s, 1min, 30min
	Sleep Time 1min	Press Enter to select sleep time including 5s, 10s, 30s, 1min, 30min
	WIFI ON	Press Enter to turn on or turn off WIFI.
	WIFI Mode AP	Press Enter to change the WIFI Mode including AP or STA. (The function is unavailable when WIFI is off)
	4G SIM	Press Enter to change the 4G status including eSIM or SIM.
	Channel Detection	Only work on rover mode.
	OEM Board Reset	Press Enter to reset board.
	Language English	Press Enter to change languages (English or Chinese).
	Voice Off	Press Enter to turn on or turn off voice.
	Back	Press Enter to back to last page.
Mode	Base External UHF Base Internal UHF Base APIS Base External UHF & APIS Rover APIS Rover UHF Rover NTRIP Back	<ul style="list-style-type: none"> • Press Enter button to enter the configuration screen of the selected working mode. • More operation information, see 3.2 Configure the Working Mode.

The details of Data operations are as follows:

Top-level Menu	Second-level Menu	Description
Data	Set on/off	Press Enter button to switch static measurement on or off.
	Recording 00:00	Display the time of recording
	Advanced	Sample

	Elev Mask 10 degree	Press Enter button to change the mask degree from 0 degree to 90 degrees.
	Duration 1440min	<ul style="list-style-type: none"> • Press Enter button to enter Duration Time Setting screen. • In the Duration Time Setting screen, press Fn button to move to the character of the duration time value user want to make change, and then press Enter button to change from 0 to 9. After the change has been done, user can press Fn button to move to OK field, and then Press Enter button to save the change and back to the second-level menu; or press Fn button to move to Cancel field and press Enter button to cancel the change and back to the second-level menu.
	Measurement phase Center	Press Enter button and switch height between oblique, vertical, phase center.
	Antenna Height 0.0000m	Press Enter button and input the measured antenna height.
	Format HCN	Press Enter button and switch data format between HCN, HRC, Rinex2.11 and Rinex3.02.
	Ok	Press Enter to complete settings.
	Cancel	Press Enter button to back to the last menu.
	OK	Press Enter to complete settings.
	Cancel	Press Enter button to back to the top-level menu.

3.2 Configure the Working Mode

7 working modes are provided for quickly setting up an RTK base station or rover station. Users can configure each working mode through the front panel as follows:

Top-level Menu	Second-level Menu	Description
Base External UHF	Mode Base External UHF	The title of this configuration screen.
	Format CMR	Press Enter to select correction format (RTD, CMR, RTCMv2.3, RTCMv3 and RTCMv3.2).
	OK	Press Enter button to save the settings and back to the top-level menu, and then this working mode can take effect.
	Cancel	Press Enter button to cancel the settings and back to the second-level menu.
Base Internal UHF	Mode Base External UHF	The title of this configuration screen.
	Protocol CHC	Press Enter to select current protocol (CHC, Transparent, TT450s)
	Channel 1 456.0500	Press Enter to change the channel from 0 to 9
	Baud 9600	Press Enter to select Baud (4800, 9600 and 19200)
	Power 1w	Press Enter button to change the transmitting power (0.5w,1w,2w).
	Format CMR	Press Enter to select correction format (RTD, CMR, RTCMv2.3, RTCMv3 and RTCMv3.2).
	OK	Press Enter button to save the settings and back to the top-level menu, and then this working mode can take effect.
	Cancel	Press Enter button to cancel the settings and back to the second-level menu.
Base APIS	Mode Base APIS	The title of this configuration screen.

	Format CMR	Press Enter to select correction format (RTD, CMR, RTCMv2.3, RTCMv3 and RTCMv3.2).
	IP 111.111.111.1	Press Enter to enter third-level menu to select IP (APIS1.huace.cn, APIS2.huace.cn, 211.144.120.97, 101.251.112.206) or press Customized IP to customize your own IP
	Port 9901	Press Enter button to change the port from 9901 to 9920.
	OK	Press Enter button to save the settings and back to the top-level menu, and then this working mode can take effect.
	Cancel	Press Enter button to cancel the settings and back to the second-level menu.
Base External UHF & APIS	Mode Base External UHF & APIS	The title of this configuration screen.
	Way External UHF+APIS	Display the way of base station combination.
	Format CMR	Press Enter to select correction format (RTD, CMR, RTCMv2.3, RTCMv3 and RTCMv3.2).
	IP 111.111.111.1	Press Enter to enter third-level menu to select IP (APIS1.huace.cn, APIS2.huace.cn, 211.144.120.97, 101.251.112.206) or press Customized IP to customize your own IP
	Port 9901	Press Enter button to change the port from 9901 to 9920.
	OK	Press Enter button to save the settings and back to the top-level menu, and then this working mode can take effect.
	Cancel	Press Enter button to cancel the settings and back to the second-level menu.

Rover APIS	Mode Rover APIS	The title of this configuration screen.
	Base ID 1234567	Press Enter to enter third-level menu to change Base ID
	IP 210.14.66.58	Press Enter to enter third-level menu to select IP (APIS1.huace.cn, APIS2.huace.cn, 211.144.120.97, 101.251.112.206) or press Customized IP to customize your own IP
	Port 9902	Press Enter button to change the port from 9901 to 9920.
	OK	Press Enter button to save the settings and back to the top-level menu, and then this working mode can take effect.
	Cancel	Press Enter button to cancel the settings and back to the second-level menu.
Rover UHF	Mode Rover UHF	The title of this configuration screen.
	Protocol CHC	Press Enter to select current protocol (CHC, Transparent, TT450s)
	Channel 1 456.0500	Press Enter to change the channel from 0 to 9
	Baud 9600	Press Enter to select Baud (4800, 9600 and 19200)
	OK	Press Enter button to save the settings and back to the top-level menu, and then this working mode can take effect.
	Cancel	Press Enter button to cancel the settings and back to the second-level menu.
Rover NTRIP	Mode Rover NTRIP	The title of this configuration screen.
	Status Not Login in in	Indicates the login status.

	OK	Press Enter button to save the settings and back to the top-level menu, and then this working mode can take effect.
	Cancel	Press Enter button to cancel the settings and back to the second-level menu.
Back		Press Enter button to back to the top-level menu.

4 Equipment Setup and Operation

4.1 Post-processing Base Station Setup

For good performance, the following base station setup guidelines are recommended:

Components:

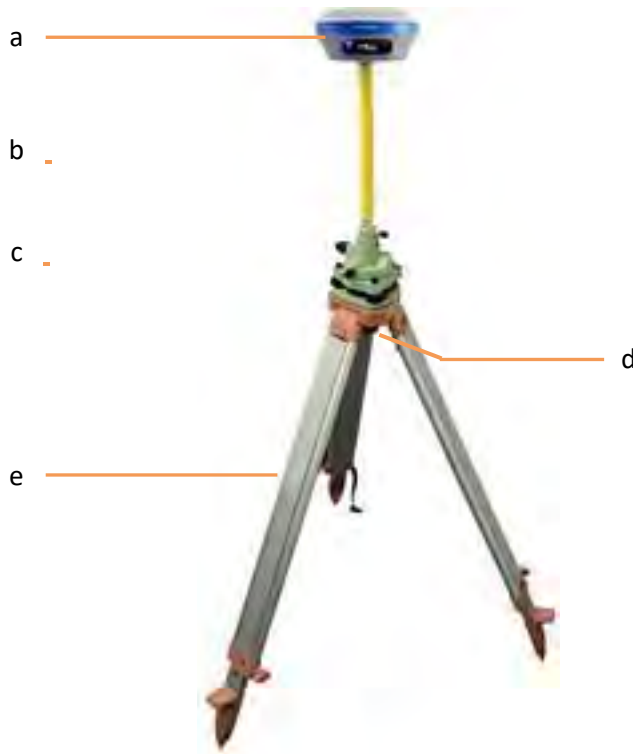

No.	Name
a	i93 GNSS receiver
b	Extension pole (30 cm)
c	Tribrach adaptor
d	Tribrach w/ Opti
e	Aluminum tripod

Steps:

- (1) Put tripod in the target position, center and level it roughly.
- (2) Place and lock the tribrach in the tripod.

- (3) Screw the receiver onto the tribrach.
- (4) Center and level the receiver more precisely.
- (5) Connect the receiver to external battery by using external power cable if necessary.
- (6) Connect the receiver to external storage disk by using USB cable if necessary.
- (7) Turn on the receiver by pressing the power button for 3 s.
- (8) Measure the antenna height by using H.I. tape and auxiliary H.I. tool.
- (9) Press the function button to select Data to start recording static raw.

If work with a data controller:

- (10) Switch on the data controller and connect it to the receiver.
- (11) Use software to configure the receiver as static mode.

4.2 Real-Time Base Station Setup

4.2.1 Internal Cellular or UHF

For good rover operation, the following base station setup guidelines are recommended:

Components:

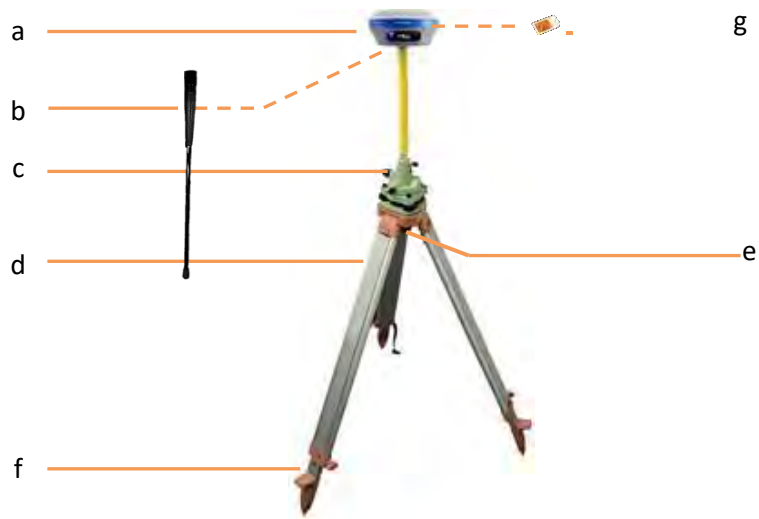

No.	Name
a	i93 GNSS receiver
b	UHF whip antenna
c	Extension pole (30 cm)
d	Tribrach adaptor
e	Tribrach w/ Opti
f	Aluminum tripod
g	Micro SIM card (12 mm x 15 mm)

Steps:

- (1) Put tripod in the target position, center and level it roughly.
- (2) Place and lock the tribrach in the tripod.

If work as a cellular base station, the SIM card need to be inserted

- (3) Screw the receiver onto the tribrach.
- (4) Center and level the receiver more precisely.

If work as a UHF base station, the UHF whip antenna need to be connected to the receiver.

- (5) Connect the receiver to external battery by using external power cable if necessary.
- (6) Connect the receiver to external storage disk by using USB cable if necessary.
- (7) Turn on the receiver by pressing the power button for 3 s.
- (8) Measure the antenna height by using H.I. tape and auxiliary H.I. tool.
- (9) Switch on the data controller and connect it to the receiver.
- (10) Use software to configure the receiver as cellular base or UHF base mode.

4.2.2 External UHF

For good performance, the following base station setup guidelines are recommended:

Components:

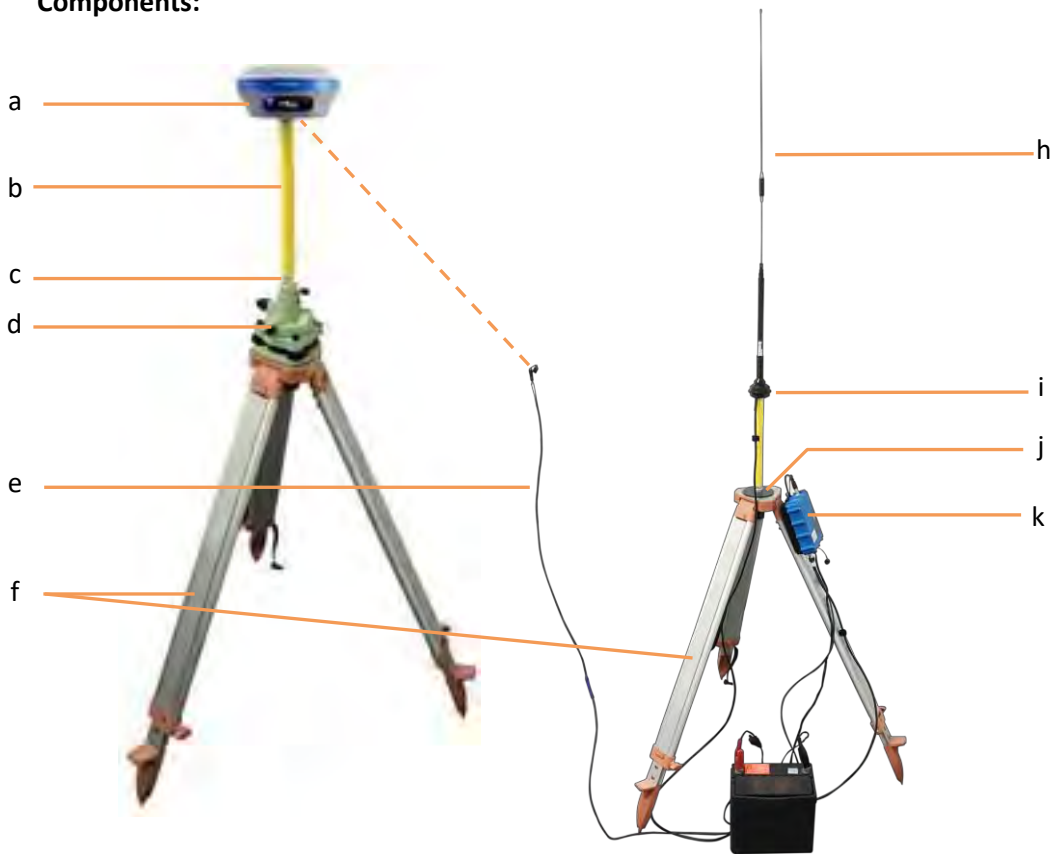

No.	Name
a	i93 GNSS receiver
b	Extension pole (30 cm)
c	Tribrach adaptor
d	Tribrach w/ Opti
e	GPS to datalink cable (power cable)
f	Aluminum tripod
h	Whip antenna
i	3 m cable for datalink antenna 3m
j	Pole mounting
k	External 410-470 datalink

Steps:

- (1) Put tripod in the target position, center and level it roughly.
- (2) Place and lock the tribrach in the tripod.
- (3) Screw the receiver onto the tribrach.
- (4) Center and level the receiver more precisely.
- (5) Connect the receiver to external datalink by using GPS to datalink cable.
- (6) Hang the external datalink on the tripod leg.
- (7) Connect the receiver to external battery by using external power cable if necessary.
- (8) Connect the receiver to external storage disk by using USB cable if necessary.
- (9) Turn on the receiver by pressing the power button for 3 s.
- (10) Measure the antenna height by using H.I. tape and auxiliary H.I. tool.
- (11) Turn on the external datalink and configure it as need.

If work with a data controller:

- (12) Switch on the data controller and connect it to the receiver.
- (13) Use software to configure the receiver as cellular base or UHF base mode.

4.3 Real-Time Rover Station Setup

For good performance, the following rover station setup guidelines are recommended:

Components:



No.	Name
a	i93 GNSS receiver
b	whip antenna
c	2M range pole w/bag
d	Micro SIM card (12 mm x 15 mm)

Steps:

(1) Keep the receiver fully charged.

If work as a cellular rover station, the SIM card need to be inserted before the batteries.

(2) Screw the receiver onto the pole.

If work as a UHF rover station, the UHF whip antenna need to be connected to the receiver.

(3) Turn on the receiver by pressing the power button for 3 s.

(4) Switch on the data controller and connect it to the receiver.

(5) Use software to configure the receiver as cellular rover or UHF rover mode.

(6) Center and level the receiver more precisely.

(7) Use software to start survey.

4.4 Working with the Tilt Compensation

4.4.1 Operation Steps

(1) Open Landstar8-> Tap PT Survey-> Tap  to activate tilt measurement.



(2) Hold the pole vertical for a while and shake according to the procedures in the interface to do initialization.

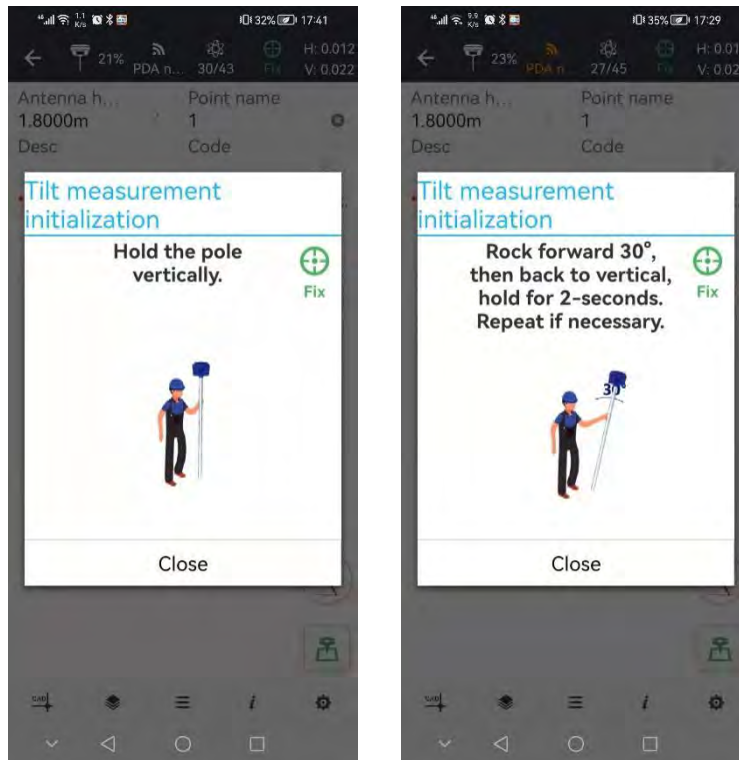

(3) This icon  will appear when the initialization is successful.

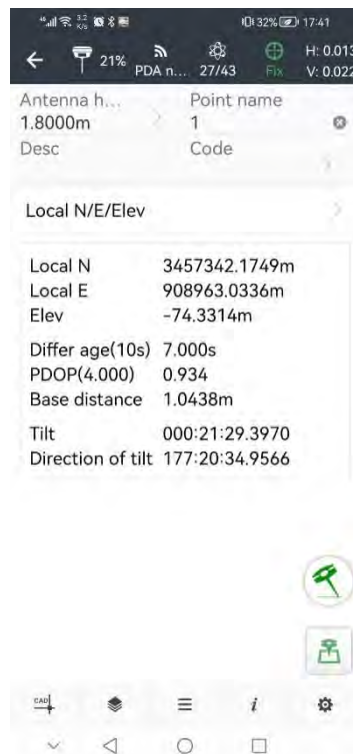

(4) Enter the Name and Antenna, then tap  , point will be collected and store to Points automatically.

(5) When this icon  appears, the text will show “Tilt is not available, please measure in alignment” at the bottom of interface.



(6) Tap  to close tilt compensation.

4.4.2 Notes of using tilt measurement

1. At the beginning of initialization, the pole height of the instrument should be the same as that antenna height in the software.
2. In the process of tilt measurement, if the controller shows that “Tilt is not available, please measure in alignment” (red), please shake RTK slightly from left to right or back to front until the reminder disappears.
3. The controller will prompt “Tilt is not available, please measure in alignment” when the receiver is stationary over 30 seconds or the pole hit the ground toughly.
4. The pole cannot be shaken when point is collected.

5. Initialization is required:

- when the RTK is turned on every time;
- when IMU module is turned on every time;
- when receiver drops at working;
- when the pole is tilted more than 65 degree;
- when the receiver is stationary more than 10 minutes;
- when the RTK rotates too fast on the matching pole (2 rounds per second);
- when the pole hit the ground toughly.

4.5 Visual Survey

4.5.1 Survey point mode

The survey point mode means that by taking video survey of the target to be surveyed and solving the survey result in real time, and selecting the point to be surveyed on the photo than you can get the coordinate value of the point.

(1) Finish the IMU initialization, enter the visual survey, do as it prompts;

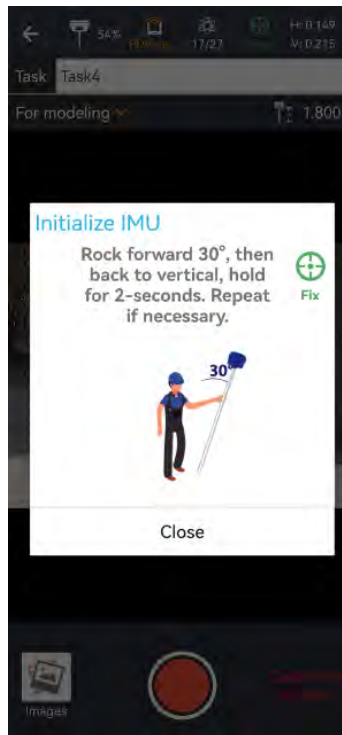

(2) Choose the For measurement mode;



(3) Create a new task, and aim at which point you want to survey, click the button to record the video;



Note: Keeping constant speed when shooting, the length of the video must not be less than 5 seconds, the route of walking can refer to the following picture, walking in a straight line or around the shooting.

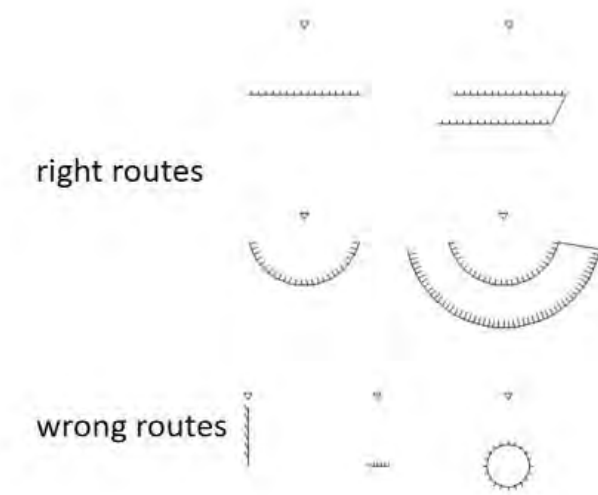

(4) Click the icon of End Recording to finish recording and confirm the solved data, and the software will automatically perform data solving;

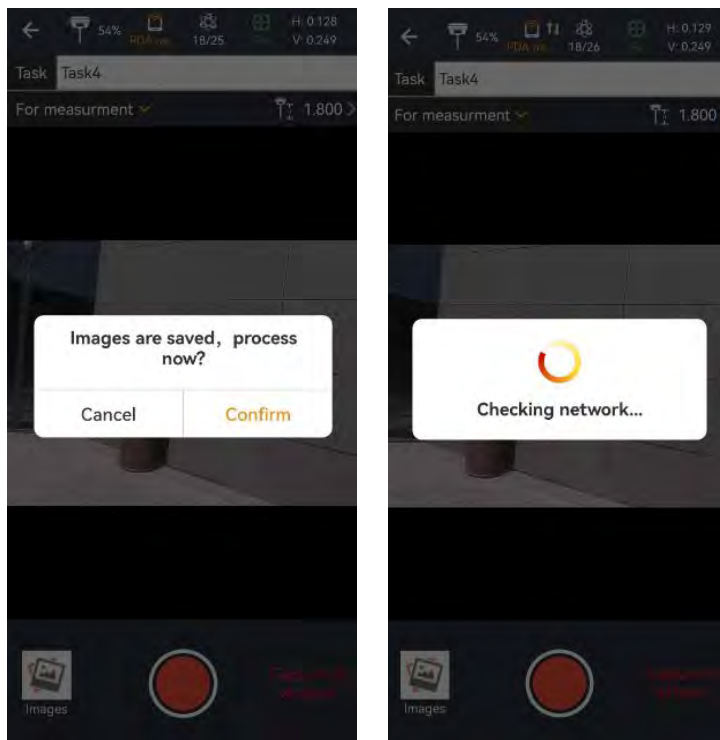

(5) Select the photo which the point to be surveyed is located, capture the corresponding point location, click [Select], and the latitude, longitude and plane coordinates of the point will be displayed below.

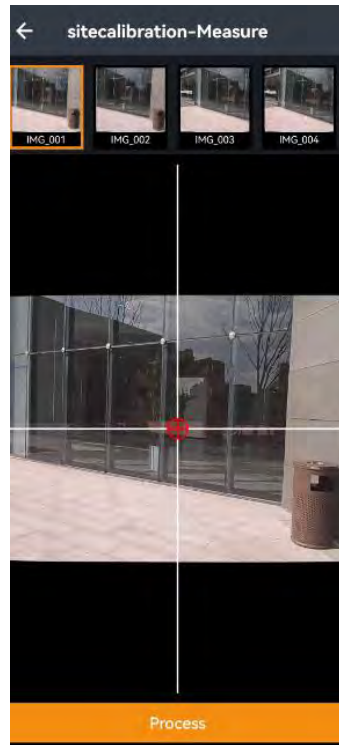

Note: The 2D quality represents the resolution accuracy of the surveyed point. Capturing the same point position on multiple photos will improve the accuracy of the surveyed point, and the 2D value of the point decreases gradually.

(6) Click [Save] and enter the point name to save the surveyed points in the point management. After saving successfully, you can click on the point library and go to the point management to view the coordinates you just saved. If additional points are needed, you can continue to select points for solving and saving data.

4.5.2 Modeling mode

Modeling mode means that video surveys can be taken from multiple angles, distances and heights of the target to be surveyed, and then the observed image data can be exported and later imported into the modeling software for modeling.

- (1) The same operation with the point mode, finish the IMU initialization;
- (2) Choose the Modeling mode;

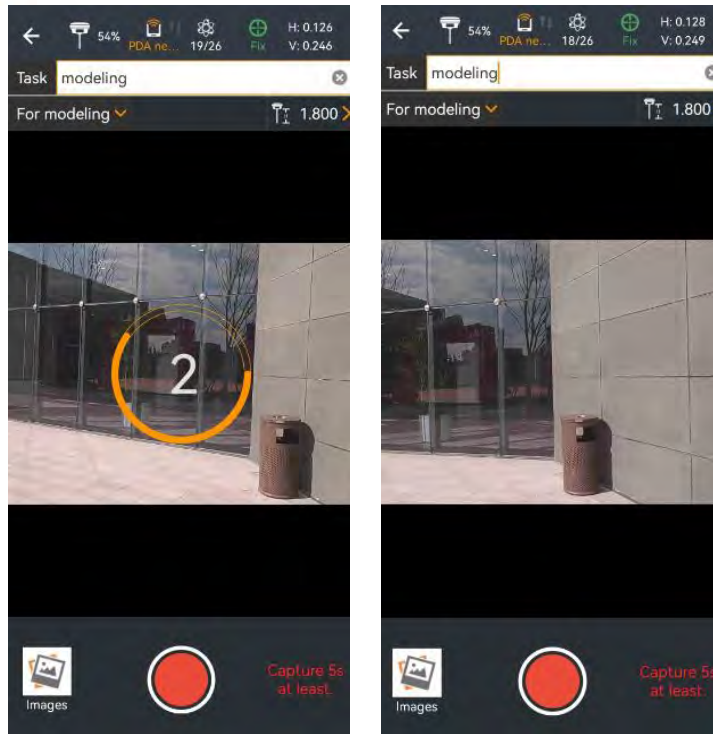

(3) Create a new task, and aim at which building you want to model, click the button to record the video;

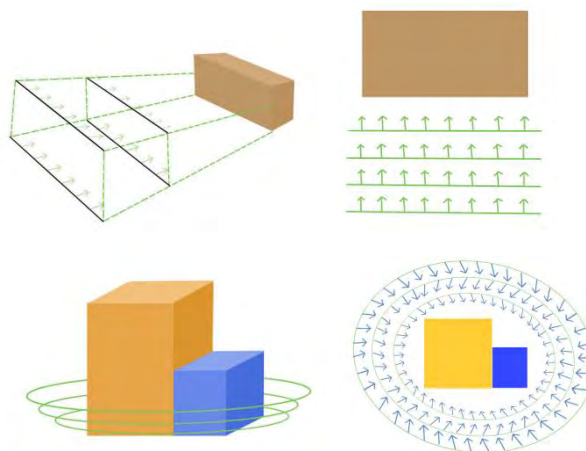

Note: When filming, keep a constant speed, the length of the video should not be less than 5 seconds, the route of travel can refer to the example, it is recommended that from different heights, different angles, different distances to survey the target for multi-sided shooting. If the target to be surveyed is single-sided, it is recommended to use straight shooting; if the target to be surveyed is a panorama of building, it is recommended to shoot around, and the camera is recommended to have a certain angle (30°-45°) with the target to be surveyed when shooting. The schematic diagram is as follows.

(4) Click the end icon to finish recording and make sure that the data has been saved to exit

5 Configuring Through a Web Browser

Supported browsers:

- Google Chrome
- Microsoft Internet Explorer® version 10, or higher

To connect to the receiver through a web browser:

1. Turn on the Wi-Fi of the receiver.
2. Search the wireless network named as GNSS-XXXXXXX (the SN of your receiver) on your computer, and then establish the connection.
3. After the successful connection between your computer and the receiver, enter the IP address (192.168.1.1) of the receiver into the address bar of the web browser on your computer:

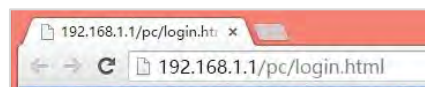

4. The web browser prompts you to enter a login account and password:



The default login account for the receiver is:

- Login Account: admin
- Password: password

Note – Tick **remember me** option, and then the browser will remember the Login Account and Password you entered.

5. Once you log in, the web page appears as follows:

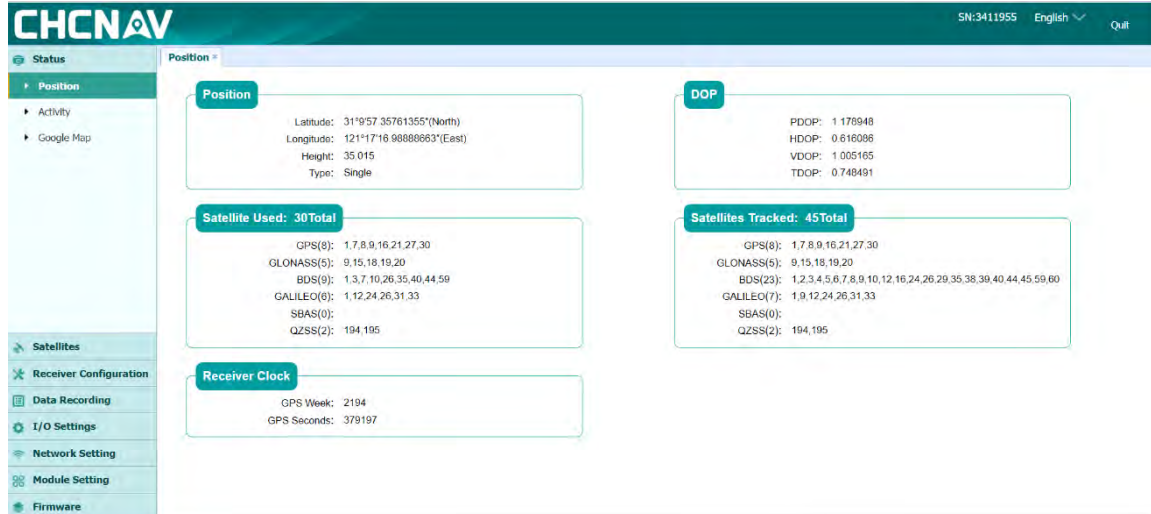

This web page shows the configuration menus on the left of the browser window, and the setting on the right. Each configuration menu contains the related submenus to configure the receiver and monitor receiver performance.

This chapter describes each configuration menu.

To view the web page in another language, select the corresponding language name from the dropdown list on the upper right corner of the web page.

Currently, two languages are available:

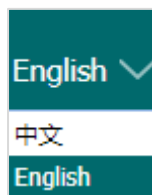

5.1 Status Menu

This menu provides a quick link to review the receiver's position information, satellites tracked, runtime, current data log status, current outputs, available memory, and more.

5.1.1 Position Submenu

This page shows the relevant position information about the receiver's position solution which including the position, DOP values, satellites used and tracked, and the receiver clock information.

Position

Latitude: 31°9'57.36875055"(North)
 Longitude: 121°17'16.97717278"(East)
 Height: 35.999
 Type: Single

DOP

PDOP: 1.172767
 HDOP: 0.616858
 VDOP: 0.997431
 TDOP: 0.744274

Satellite Used: 30Total

GPS(7): 1,7,8,9,21,27,30
 GLONASS(5): 9,15,18,19,20
 BDS(10): 1,3,7,9,10,26,35,40,44,59
 GALILEO(6): 1,12,24,26,31,33
 SBAS(0):
 QZSS(2): 194,195

Satellites Tracked: 45Total

GPS(8): 1,7,8,9,16,21,27,30
 GLONASS(5): 9,15,18,19,20
 BDS(23): 1,2,3,4,5,6,7,8,9,10,12,16,24,26,29,35,38,39,40,44,45,59,60
 GALILEO(7): 1,9,12,24,26,31,33
 SBAS(0):
 QZSS(2): 194,195

Receiver Clock

GPS Week: 2194
 GPS Seconds: 379271

5.1.2 Activity Submenu

Lists several important items to help you understand how the receiver is being used and its current operating condition. Items include the identities of currently tracked satellites, internal and external storage usage rate, how long the receiver has been operational, state of the internal battery, power source state, files being logged, and data streams being output. With this information, it is easy to tell exactly what functions the receiver is performing

Status

- Position
- Activity**
- Google Map

Activity

Satellites Track: 46Total

GPS(8): 1,7,8,9,16,21,27,30
 GLONASS(5): 9,15,18,19,20
 BDS(23): 1,2,3,4,5,6,7,8,9,10,12,16,24,26,29,35,38,39,40,44,45,59,60
 GALILEO(7): 1,9,12,24,26,31,33
 SBAS(0):
 QZSS(3): 193,194,195

Activity Status

Current Time: 2022-01-27 09:21:39 (UTC)
 Operation Duration: 00-00-00 01:20:50
 Internal Storage: 4.85% 368MB/7595MB
 External Storage: 0% Disconnected
 External Power: Disconnected
 Battery: 46%

Recording Number	File Name	Activated	Log Status
1	record1	Yes	Recording
2	record2	No	Not Recording
3	record3	No	Not Recording
4	record4	No	Not Recording
5	record5	No	Not Recording
6	record6	No	Not Recording
7	record7	No	Not Recording
8	record8	No	Not Recording

	Type	Description	Output
1	RTX Client	211.144.118.5 2102	—
2	TCP/UDP_Client1NTRIP Server1	192.168.3.18 9900	—
3	TCP/UDP_Client2NTRIP Server2	192.168.3.18 9901	—
4	TCP/UDP_Client3NTRIP Server3	192.168.3.18 9902	—
5	TCP/UDP_Client4NTRIP Server4	192.168.3.18 9903	—
6	TCP/UDP_Client5NTRIP Server5	192.168.3.18 9904	—
7	TCP/UDP_Client5NTRIP Server6	192.168.3.18 9905	—
8	TCP ServerNTRIP Caster1	9901	—
9	TCP ServerNTRIP Caster2	9902	—
10	TCP ServerNTRIP Caster3	9903	—
11	TCP ServerNTRIP Caster4	9904	—
12	Serial Port	9600	—
13	Bluetooth	GNSS-3200193	—
14	Radio	400.0500MHz	—

5.1.3 Google Map Submenu

Tap this submenu to show the location of the receiver on Google map.

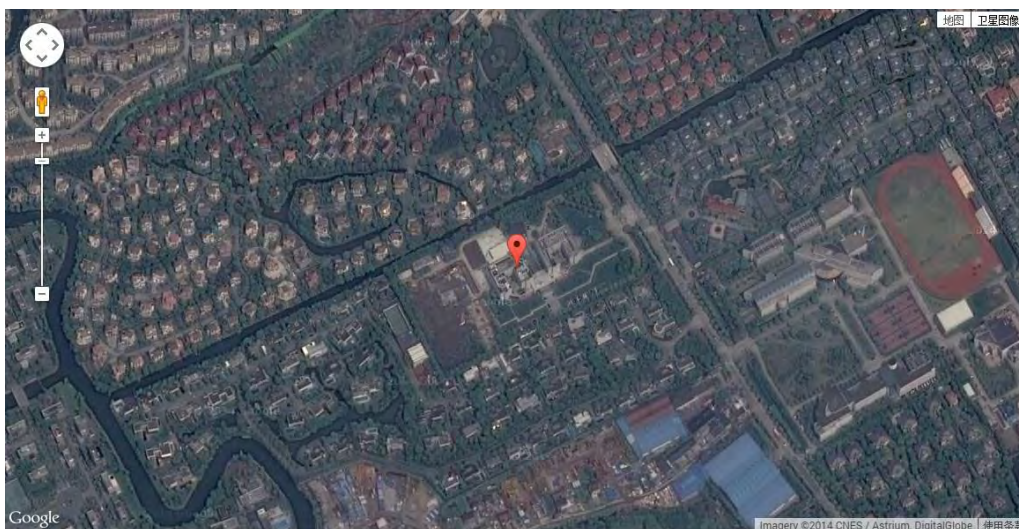

5.2 Satellites Menu

Use the Satellites menu to view satellite tracking details and enable/disable GPS, GLONASS, BDS and Galileo constellations. These menus include tabular and graphical displays to provide all required information on satellite tracking status.

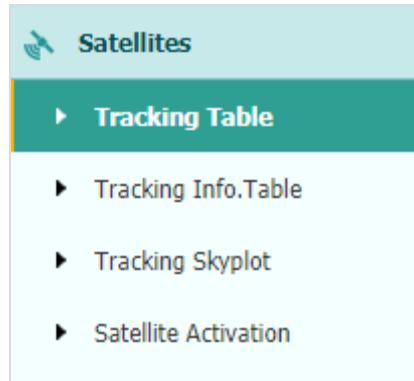

5.2.1 Tracking Table Submenu

Provides the status of satellites tracked in general, such as the satellite ID, satellite type, attitude angle, azimuth angle, L1 SNR, L2 SNR, L5 SNR and enable/disable status of each one.

SV	Type	Elevation Angle	Azimuth Angle	L1 SNR	L2 SNR	L5 SNR	B1C SNR	B2A SNR	Enabled
3	GPS	21	282	40.000	40.850	30.880	0.000	0.000	Yes
4	GPS	15	318	40.030	36.800	27.800	0.000	0.000	Yes
16	GPS	45	242	44.820	39.450	0.000	0.000	0.000	Yes
26	GPS	74	318	48.720	43.430	36.160	0.000	0.000	Yes
27	GPS	12	188	34.690	35.890	26.250	0.000	0.000	Yes
29	GPS	23	50	41.370	36.580	0.000	0.000	0.000	Yes
31	GPS	55	44	45.450	41.970	0.000	0.000	0.000	Yes
32	GPS	35	149	42.840	38.490	30.140	0.000	0.000	Yes
1	GLONASS	52	211	41.760	46.170	0.000	0.000	0.000	Yes
2	GLONASS	40	313	47.100	46.320	0.000	0.000	0.000	Yes
8	GLONASS	14	174	36.530	43.730	0.000	0.000	0.000	Yes
12	GLONASS	41	300	45.760	49.200	0.000	0.000	0.000	Yes
21	GLONASS	22	94	37.800	44.160	0.000	0.000	0.000	Yes
1	BDS	45	140	39.830	42.710	44.970	0.000	0.000	No
2	BDS	35	235	35.420	43.410	42.250	0.000	0.000	No
3	BDS	50	199	40.270	44.410	43.470	0.000	0.000	Yes

5.2.2 Tracking Info. Table Submenu

The following figure is an example of satellite track diagram page. Users can determine the satellite types and the corresponding SNR of L-band carriers to be displayed in any combination.

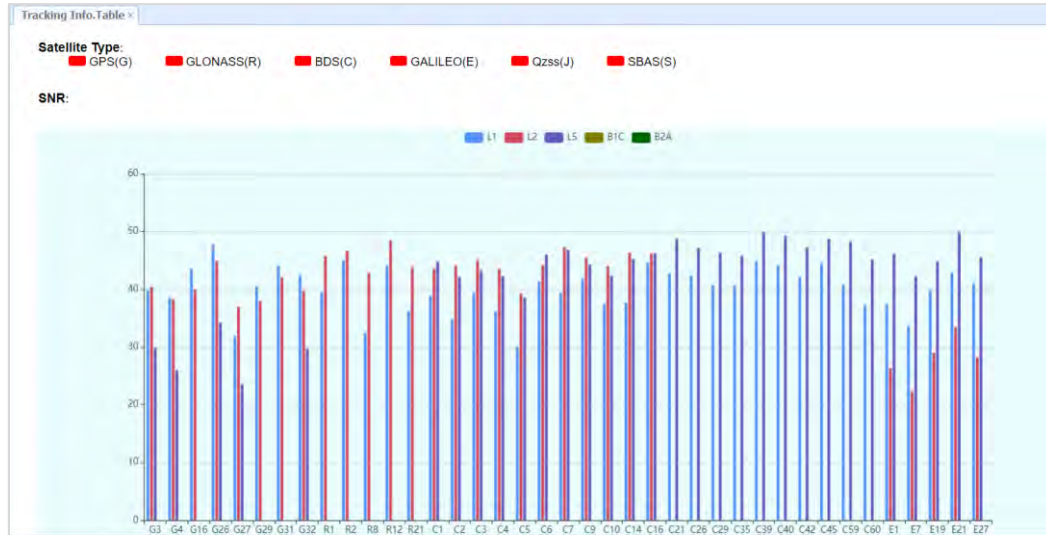

5.2.3 Tracking Skyplot Submenu

The following figure is an example of Skyplot page.

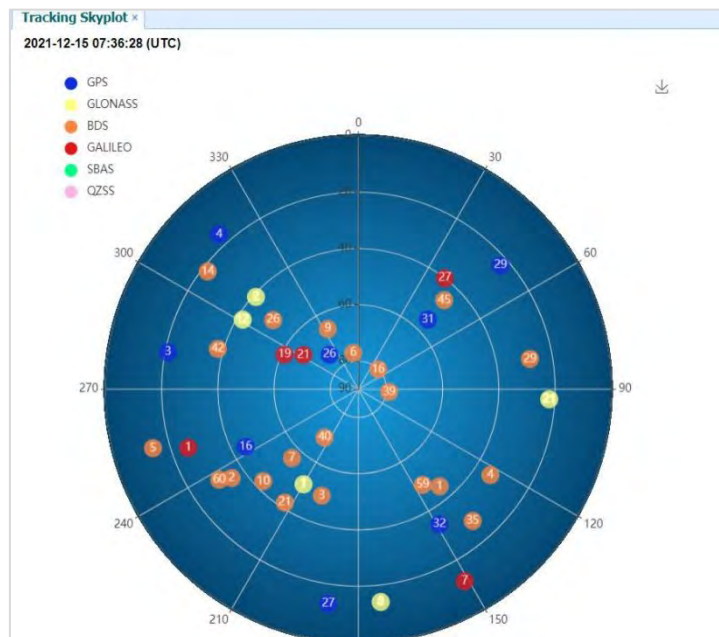

5.2.4 Satellite Activation Submenu

Use this menu to enable or disable satellites.



5.3 Receiver Configuration Menu

Use this menu to configure settings such as the antenna type and height, elevation mask and PDOP setting, the reference station coordinates, receiver resetting and web interface language:

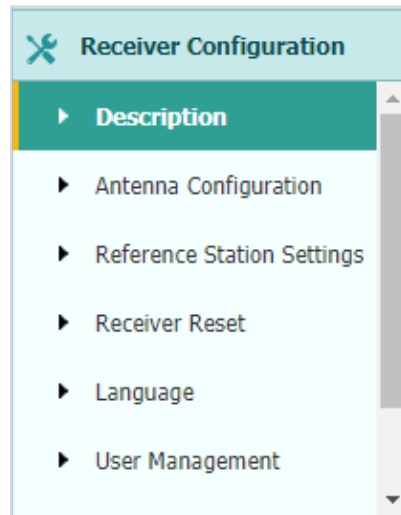

5.3.1 Description

This submenu shows the receiver information and reference station information, including antenna related information, elevation mask angle, reference station work mode and position, etc.

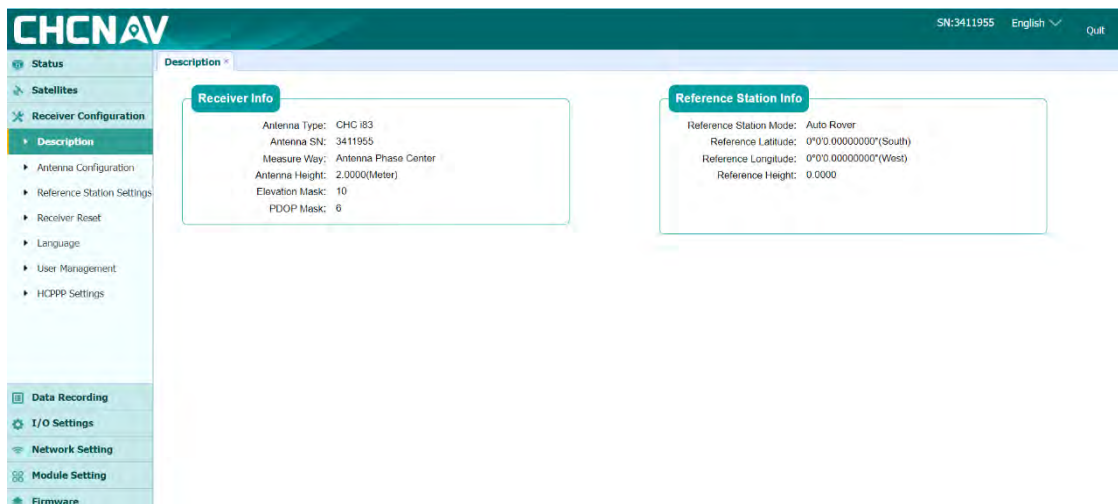

5.3.2 Antenna Configuration Submenu

Use this screen to configure all the items related to the GNSS antenna. You must enter the correct values for all antenna-related fields, because the choices you make affect the accuracy for logged data and broadcast correction data significantly:

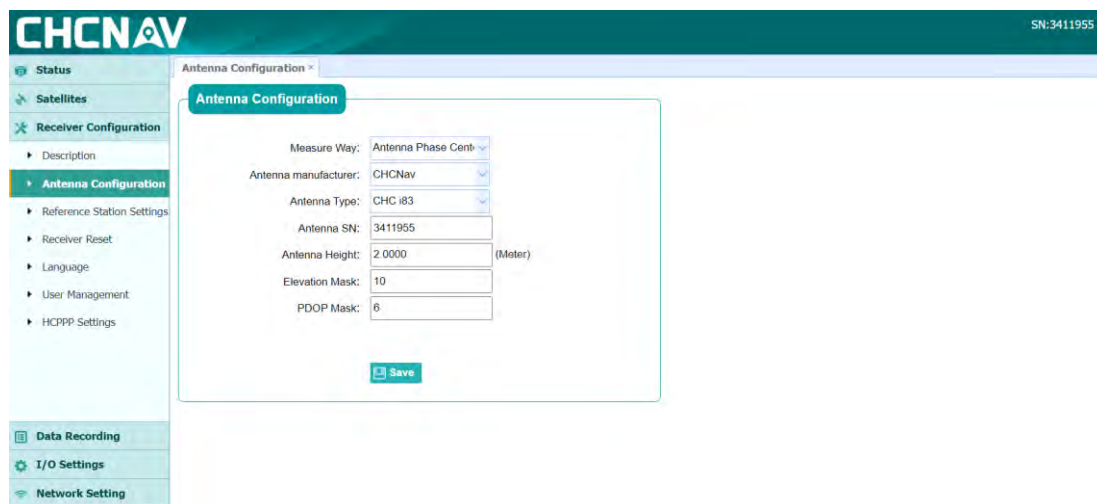

5.3.3 Reference Station Settings Submenu

Use this screen to configure settings such as the station coordinates and the broadcast station identifiers. You must enter accurate information in these fields, as this data affects the accuracy of logged data files and broadcast correction data significantly:

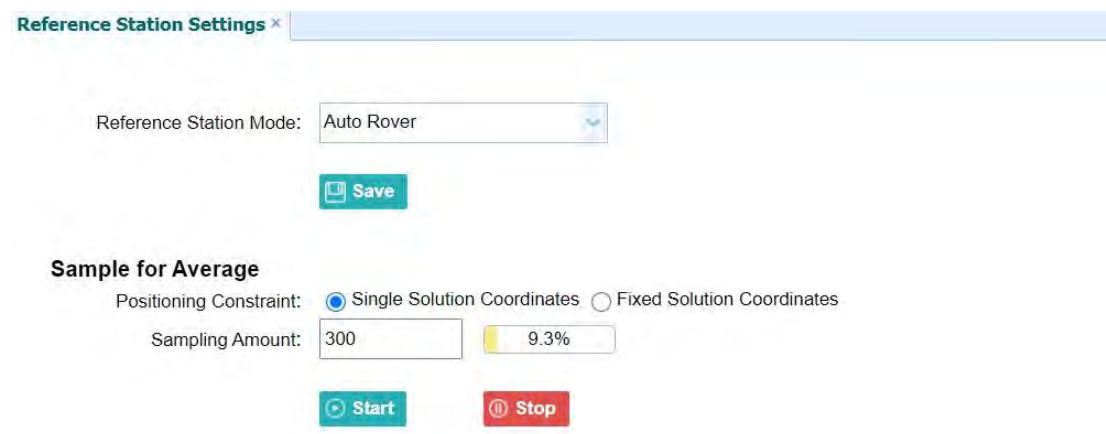

For Reference Station Mode, there are three modes available:

- a) **Auto Rover:** The receiver will serve as a rover after this mode is enabled, and then receive correction data through the working mode set last time.
- b) **Auto Base:** The receiver will serve as a base after this mode is enabled, and then broadcast correction data based on coordinate inputted by user or obtained through autonomous positioning automatically.

Reference Station Settings

Reference Station Mode: Auto Base

Base Station Name: 9999885

Base Station ID: 9999885

Reference Latitude: 0 0 0.00000000 N S

Reference Longitude: 0 0 0.00000000 E W

Reference Height: 0.0000

Save

Sample for Average

Positioning Constraint: Single Solution Coordinates Fixed Solution Coordinates

Sampling Amount: 300 0%

Start
Stop

Coordinates transfer threshold value(Meter): 0

Save

Base list

+ Add S Save X Delete ✓ Modify

ID	Height	Latitude			Longitude				
1	15.8174	31	9	58.23544755	<input type="radio"/> S <input checked="" type="radio"/> N	121	17	15.28542026	<input checked="" type="radio"/> E <input type="radio"/> W
2	8.9960	31	9	58.18017579	<input type="radio"/> S <input checked="" type="radio"/> N	121	17	15.40953509	<input checked="" type="radio"/> E <input type="radio"/> W
3	54.3043	31	9	57.63710849	<input type="radio"/> S <input checked="" type="radio"/> N	121	17	16.96040091	<input checked="" type="radio"/> E <input type="radio"/> W
4	54.7207	31	9	57.64332088	<input type="radio"/> S <input checked="" type="radio"/> N	121	17	16.79712004	<input checked="" type="radio"/> E <input type="radio"/> W
5	44.5090	31	9	57.38446236	<input type="radio"/> S <input checked="" type="radio"/> N	121	17	16.91309424	<input checked="" type="radio"/> E <input type="radio"/> W
6	57.2322	31	9	57.33298549	<input type="radio"/> S <input checked="" type="radio"/> N	121	17	16.99217382	<input checked="" type="radio"/> E <input type="radio"/> W
7	54.6052	31	9	57.34069924	<input type="radio"/> S <input checked="" type="radio"/> N	121	17	16.44724736	<input checked="" type="radio"/> E <input type="radio"/> W
8	8.6995	31	9	58.92883736	<input type="radio"/> S <input checked="" type="radio"/> N	121	17	17.62076462	<input checked="" type="radio"/> E <input type="radio"/> W
9	7.5335	31	9	57.82584863	<input type="radio"/> S <input checked="" type="radio"/> N	121	17	17.67097178	<input checked="" type="radio"/> E <input type="radio"/> W
10	17.2042	31	9	59.25888326	<input type="radio"/> S <input checked="" type="radio"/> N	121	17	17.57073058	<input checked="" type="radio"/> E <input type="radio"/> W

- c) **Manual Base:** The receiver will serve neither as a base nor a rover after this mode is enabled. Users need to configure the receiver manually

For **Reference Latitude** and **Reference Longitude**:

There are mainly three methods to enter the reference coordinates and shown as follows:

- a) **Acquire Current Position:** Click this button to acquire current position obtained through autonomous positioning automatically.
- b) **Manual Input:** Manually input the coordinate of a control point.
- c) **From CORS:** After the receiver logging in CORS, the software can record the coordinate of current position based on fix solution.

For **Sample for Average**:

Users can determine the positioning limit and sampling amount. The positioning limit falls into two types:

- a) **Single Solution Coordinates:** Collect the coordinates of receiver obtained through autonomous positioning.
- b) **Fixed Solution Coordinates:** Only collect coordinates of receiver with a fixed solution.

After the configuration of positioning limit and sampling amount, click **Start** to carry out sampling and averaging → the progress bar will show the progress → the result will be served as the coordinate of current position.

If users need to save the changes, please tap **Save** button.

5.3.4 Receiver Reset Submenu

Use this screen to completely or partially reset the receiver:

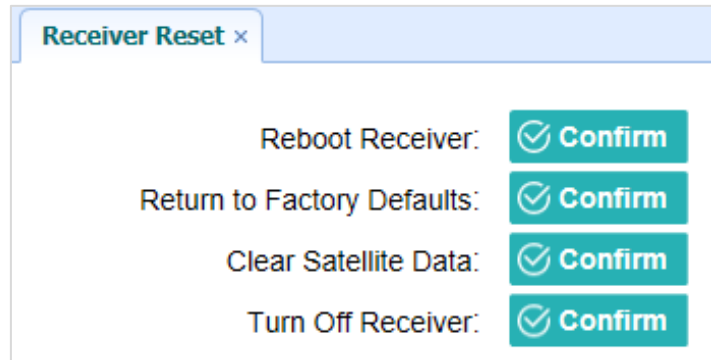

5.3.5 Languages Submenu



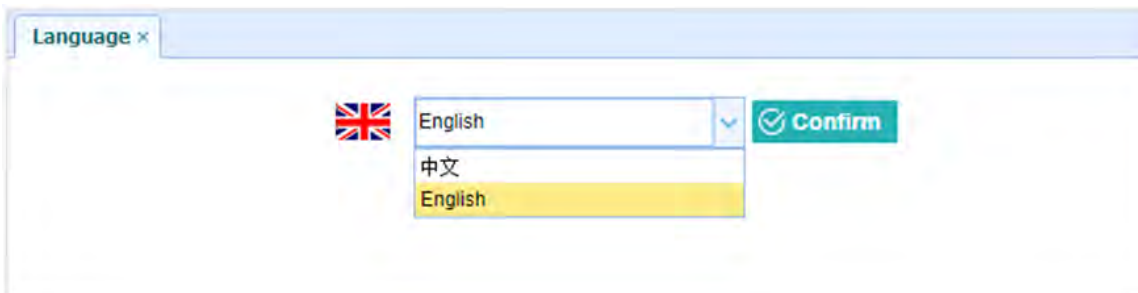

Use this screen to select the web interface language:



5.3.6 User Management Submenu

User Management ×

User Management

 Add
  Save
  Delete
  Modify Anti-theft password

ID	User Name	Password
1	<input type="text" value="admin"/>	<input type="password" value="....."/>
2	<input type="text" value="admin1"/>	<input type="password" value="....."/>
3	<input type="text" value="admin2"/>	<input type="password" value="....."/>

5.3.7 HCPPP Settings

HCPPP Settings ×

HCPPP Range:  Save

5.4 Data Recording Menu

Use the Data Logging menu to set up the receiver to log static GNSS data and to view the logging settings. You can configure settings such as observable rate, recording rate, continuous logging limit, and whether to auto delete old files when memory is low. This menu also provides the controls for the FTP push feature:

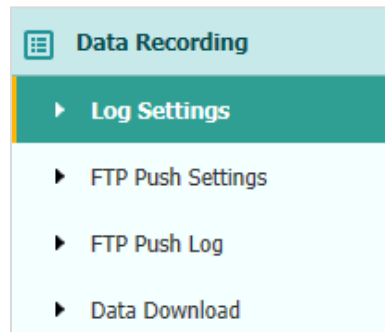

5.4.1 Log Settings Submenu

Here shows the data logging status, including internal and external storage usage and data logging status of each session. Also, users can configure the data logging settings for each session, including recording name, store location, storage limit, store formats, start time, etc

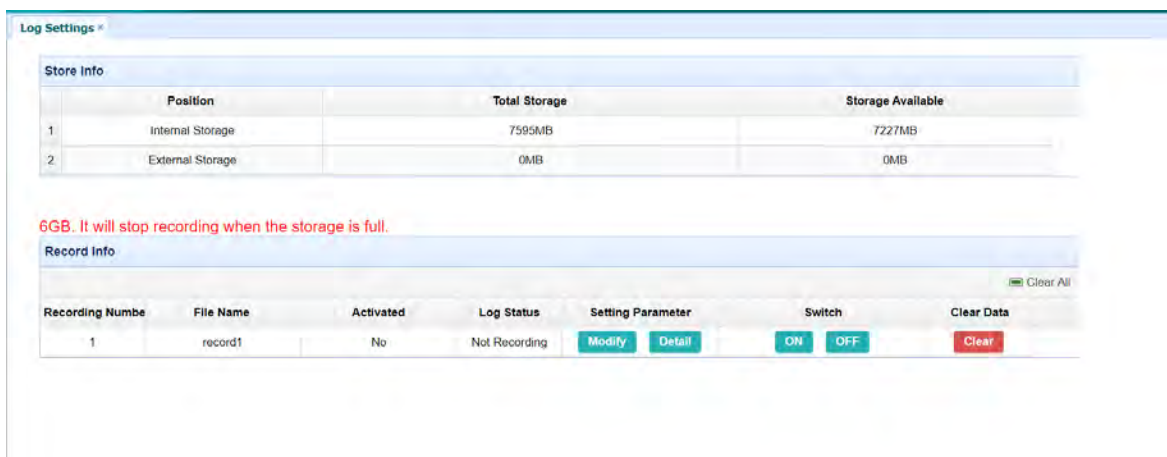

To edit the settings of each session, click the **Modify** button to the right of the required session, and then the *Recording Edit* screen appears:

Recording Edit

Auto Record: Yes No

Sample Interval: 5s

Elevation Mask: 10 (°)

Duration Time: 1440 (Minute)

Site Name: 3411955

Antenna Height: 0.0000

Measure Way: Antenna Phase

Storage Format: HCN

RINEX Version: OFF

Advanced

Save Back

Click advanced to see more settings.

Recording Edit

Auto Record: Yes No

Sample Interval: 5s

Elevation Mask: 10 (°)

Duration Time: 1440 (Minute)

Site Name: 3411955

Antenna Height: 0.0000

Measure Way: Antenna Phase

Storage Format: HCN

RINEX Version: OFF

Advanced

Start Date: Yes No

Apply Time: Yes No

Integral Point Store: Yes No

Circulating Memory: Yes No

the data overwritten first file after storage space is full

Repeat Observations: Yes No

Turn on to record a single observation. Turn off to record repeated observations.

Store Location: Internal Storage

Assigned Storage: 6000 (MB)

Observer: CHC

Observe Agency: CHC



FTP Push: Close 1:ftp server 1 2:ftp server 2 3:ftp server 3

Save Back

In this screen, you can configure all the data logging parameters, and determine whether the recording files will be affected by the FTP Push. The parameters are mainly as follows:

- **Auto Record:** on or off.

- **Sample Interval:** Select the observable rate from the dropdown list.
- **Elevation Mask:** Enter the elevation mask.
- **Duration Time:** Set the duration of data logging.
- **Site Name:** Enter the name of the site.
- **Antenna Height:** the measured height value.
- **Measure way:** Antenna Phase Center, Vertical Height, Slant Height
- **Storage Format:** Select the format of the data store.
- **RINEX Version:** OFF, 3.02, 2.11
- **Start Date:** Select **Yes** or **No** option to determine whether to auto record start date.
- **Apply Time:** Select **Yes** or **No** option to determine whether to auto record apply time.
- **Integral Point Store:** Select **Yes** or **No** option to determine whether to allow receiver to save data every hour.
- **Circulating Memory:** Select **Yes** or **No** option to determine whether to auto delete old files if the storage space is full.
- **Repeat Observations:** Select **Yes** or **No** option to determine whether to turn on to record a single observation.
- **Store Location:** Internal Storage, External Storage.
- **Assigned Storage:** The assigned memory size of current thread(for example, Record 1) is 10000MB
- **Observer:** Enter the name of observer.
- **Observer Agency:** Enter the name of observer agency.
- **FTP Push:** Decide whether to push the stored files to the FTP server of your choice.

Tap  button to save the settings and back to the *Log Settings* screen. Also, users can click  to abandon the changed settings and back to *Log Settings* screen.

Note – To modify data logging parameters, make sure the data logging session is switched off.

To switch on or off **ANY** data logging session, tap the **ON** or **OFF** button on the right of the required session.

To delete the recorded files of **ANY** data logging session, tap the **Clear** button on the right of the required session.

To delete the recorded files of **ALL** data logging sessions, tap the **Clear ALL Accounts** button.

5.4.2 FTP Push Settings Submenu

Use this screen to configure the receiver to push stored files to the FTP server of your choice. Only files that are configured to use FTP push are transmitted.

Record Info				
Server ID	Server IP	Remote Directory	Server Description	Modify
1	192.168.3.72	/repo/first	ftp server 1	Modify
2	192.168.3.72	/repo/second	ftp server 2	Modify
3	192.168.3.72	/repo/third	ftp server 3	Modify

Tap **Modify** button on the right of the required FTP server and the *FTP Push Settings* screen appears:

FTP Push Settings ✕

Server IP:

Port:

Remote Directory:

Local directory:

Server Description:

User Name:

Password:

✔ Save
✕ Back

5.4.3 FTP Push Log Submenu

Shows the related information about the recorded files that will be pushed. And users can tap **Clear Ftp Send Log** button in the upper right corner to clear the log of FTP Push operations.

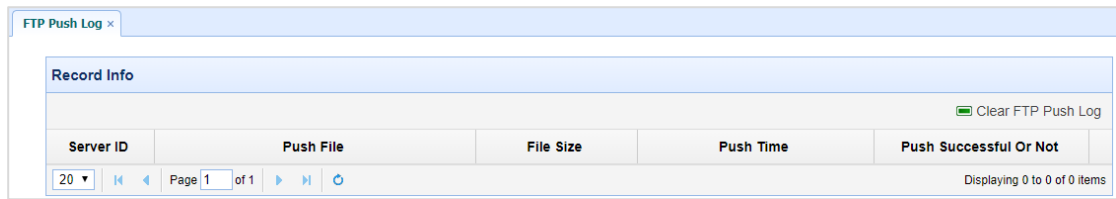

5.4.4 Data Download Submenu

In this submenu, users can download the data files that recorded in the internal storage through the internal FTP site.

1. Click this submenu, and then the log on dialogue box will prompt you to enter a user name and password:

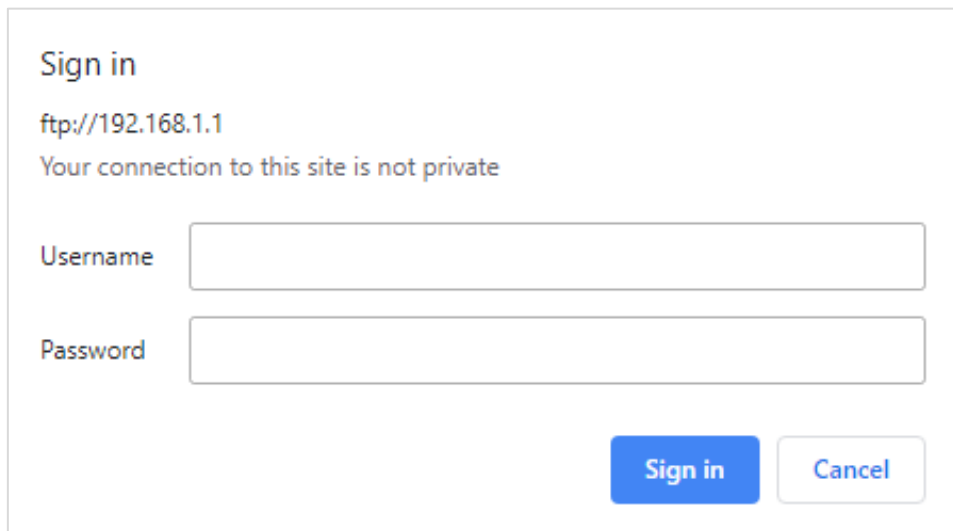





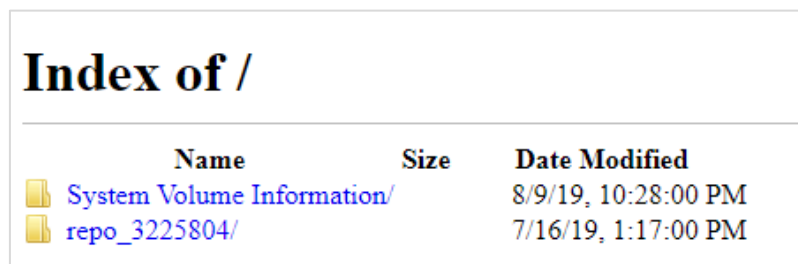





The default logon account for the internal FTP site is:

- User name: ftp
 - Password: ftp
2. Click the directory named as “repo” to view and download the files currently stored on the receiver:



3. To find the file need to be downloaded, click the name of data logging session → the date of file that be recorded → the format of the file → the name of the target file.

Index of /repo_3225804/

 [parent directory]		
Name	Size	Date Modified
 push_log/		7/16/19, 1:17:00 PM
 record_1/		8/15/19, 10:22:00 AM
 record_2/		7/16/19, 1:17:00 PM
 record_3/		7/16/19, 1:17:00 PM
 record_4/		7/16/19, 1:17:00 PM
 record_5/		7/16/19, 1:17:00 PM
 record_6/		7/16/19, 1:17:00 PM
 record_7/		7/16/19, 1:17:00 PM
 record_8/		7/16/19, 1:17:00 PM

- To download a file, left click the name of the target file → download the file according to the prompts.

5.5 IO Settings Menu

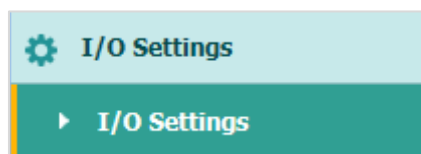

Use the IO Settings menu to set up all receiver outputs and inputs. The receiver can output CMR, RTCM, Raw data, Ephemeris data, GPGLGA, GPGSV, on TCP/IP, UDP, serial port, or Bluetooth ports.

5.5.1 IO Settings Submenu

The following figure shows an example of the screen that appears when you select this submenu.

I/O Settings					
Type	Description	Output	Connection Status	Modify	
1	RTK Client	211.144.118.5:2102	---	Unconnected	Connect Disconnecting De
2	TCP/UDP_Client1/NTRIP Serv	192.168.3.18:9900	---	Unconnected	Connect Disconnecting De
3	TCP/UDP_Client2/NTRIP Serv	192.168.3.18:9901	---	Unconnected	Connect Disconnecting De
4	TCP/UDP_Client3/NTRIP Serv	192.168.3.18:9902	---	Unconnected	Connect Disconnecting De
5	TCP/UDP_Client4/NTRIP Serv	192.168.3.18:9903	---	Unconnected	Connect Disconnecting De
6	TCP/UDP_Client5/NTRIP Serv	192.168.3.18:9904	---	Unconnected	Connect Disconnecting De
7	TCP/UDP_Client6/NTRIP Serv	192.168.3.18:9905	---	Unconnected	Connect Disconnecting De
8	TCP Server/NTRIP Caster1	9901	---	Closed	Connect Disconnecting De
9	TCP Server/NTRIP Caster2	9902	---	Closed	Connect Disconnecting De
10	TCP Server/NTRIP Caster3	9903	---	Closed	Connect Disconnecting De
11	TCP Server/NTRIP Caster4	9904	---	Closed	Connect Disconnecting De
12	Serial Port	115200	---	---	Settings
13	Bluetooth	GNSS-3411955	GPGLGA:5s,	---	Settings
14	Radio	462.5500MHz	---	---	Settings

In this submenu, users can configure 6 types of input and output settings.

1. RTK Client

After configuring the settings of RTK client, users can log on CORS or APIS. Tap the **Connect** button to the right → the *IO Settings* screen will appear → choose one of the connection protocols among the NTRIP, APIS_BASE and APIS_ROVER → configure the related parameters → click **Confirm** to log on CORS or APIS.

- Connection Protocol: NTRIP

The screenshot shows the 'RTK Client' configuration window with the following fields:

- Connection Protocol: NTRIP (dropdown menu)
- Server IP: 211.144.118.5 (text input)
- Port: 2102 (text input)
- Mount Point: asd (dropdown menu) with a green checkmark and 'Get' text next to it.
- User Name: zc (text input)
- Password: zc (text input)

At the bottom, there are two buttons: a green 'Confirm' button with a checkmark icon and a red 'Back' button with an 'X' icon.

- Connection Protocol: APIS_BASE

The screenshot shows the 'RTK Client' configuration window with the following fields:

- Connection Protocol: APIS_BASE (dropdown menu)
- Server IP: 111.111.111.1 (text input)
- Port: 9901 (text input)
- Differential Data: OFF (dropdown menu)

At the bottom, there are two buttons: a green 'Confirm' button with a checkmark icon and a red 'Back' button with an 'X' icon.

- Connection Protocol: APIS_ROVER

The screenshot shows the 'RTK Client' configuration window with the following fields:

- Connection Protocol: APIS_ROVER (dropdown menu)
- Server IP: 210.14.66.58 (text input)
- Port: 9902 (text input)
- Base ID: 1019923 (dropdown menu)

At the bottom, there are two buttons: a green 'Confirm' button with a checkmark icon and a red 'Back' button with an 'X' icon.

- Connection Protocol: TCP

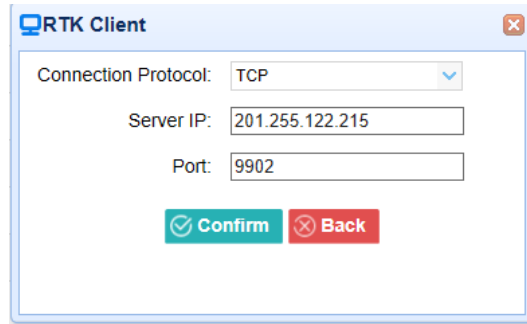

2. TCP/UDP_Client/NTRIP Server

Tap the **Connect** button on the right of required TCP/UDP Client → the *IO Settings* screen will appear → select the connection protocol from TCP, UDP, NTRIP1.0 and NTRIP2.0 → enter the IP and Port of the target server → configure messages that you want to output to the target server → click **Confirm** to save and complete the connection.

- Connection Protocol: TCP

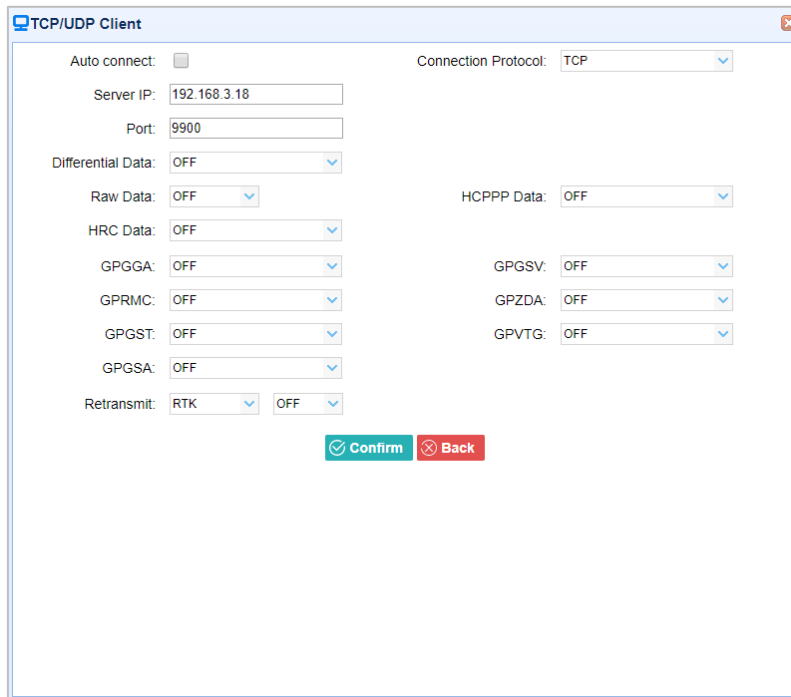

- Connection Protocol: UDP

TCP/UDP Client

Auto connect: Connection Protocol: UDP

Server IP: 192.168.3.18

Port: 9900

Differential Data: OFF

Raw Data: OFF

HRC Data: OFF

GPGGA: OFF

GPRMC: OFF

GPGST: OFF

GPGSA: OFF

Retransmit: RTK OFF

HCPPP Data: OFF

GPGSV: OFF

GPZDA: OFF

GPVTG: OFF

Confirm Back

➤ Connection Protocol: NTRIP1.0

TCP/UDP Client

Auto connect: Connection Protocol: NTRIP1.0

Server IP: 192.168.3.18

Password:

Mount Point:

Port: 9900

Differential Data: OFF

Raw Data: OFF

HRC Data: OFF

GPGGA: OFF

GPRMC: OFF

GPGST: OFF

GPGSA: OFF

Retransmit: RTK OFF

HCPPP Data: OFF

GPGSV: OFF

GPZDA: OFF

GPVTG: OFF

Confirm Back

➤ Connection Protocol: NTRIP2.0

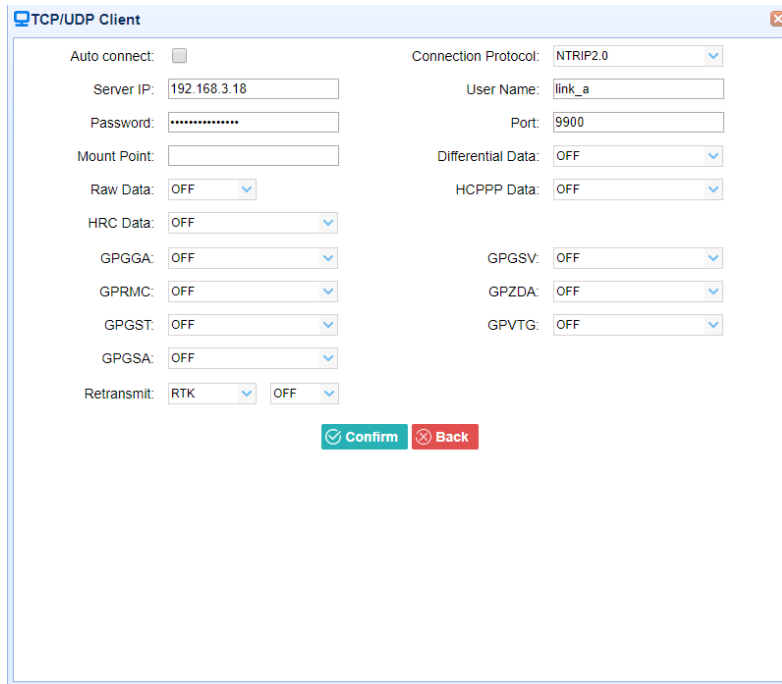

3. TCP Server/NTRIP Caster

Tap the **Connect** button to the right of required TCP Server/NTRIP Caster → the **IO Settings** screen will appear → select one of the connection protocols between NTRIP and TCP → configure the other related parameters → click **Confirm** to save the settings and open the server.

- Connection Protocol: TCP

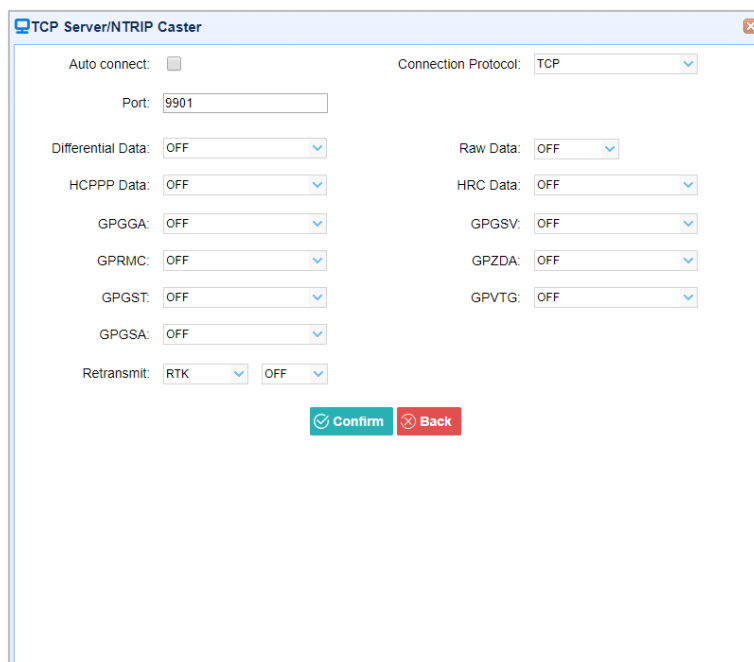

➤ Connection Protocol: NTRIP

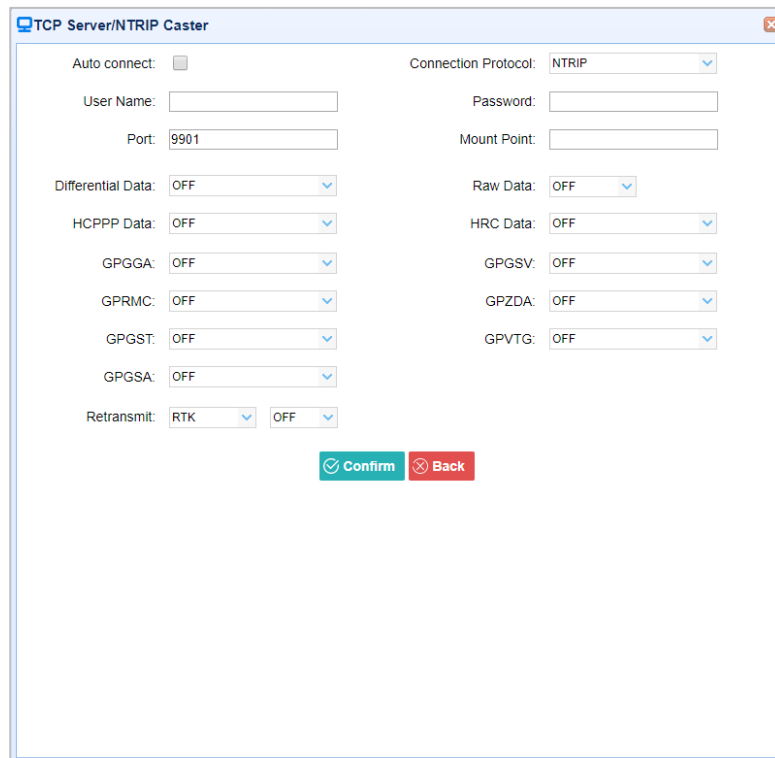

4. Serial Port

Tap the **Settings** button on the right of Serial Port → the *Serial Port Setup* screen will appear → select Baud Rate used to transmit data → configure the messages that you want to output through the serial port → click **Confirm** to save the settings and start to transmit.

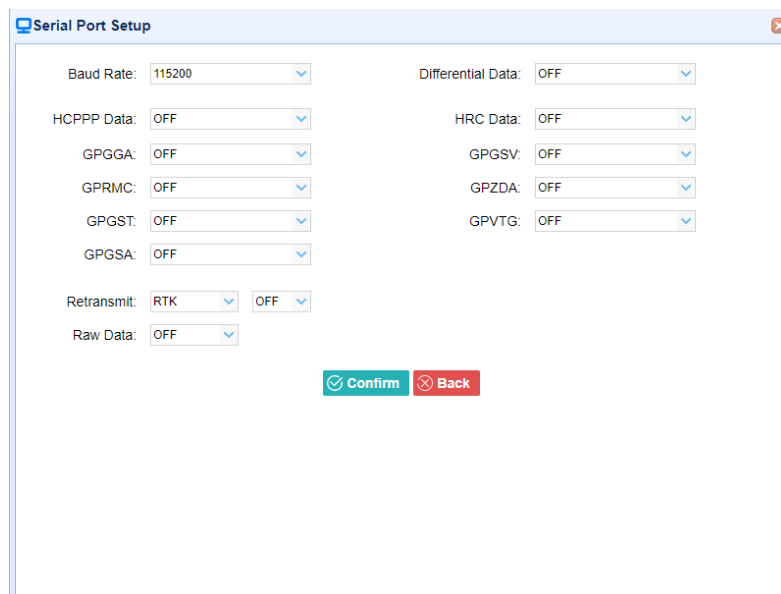

5. Bluetooth

Tap the **Settings** button to the right of Bluetooth → the *Bluetooth Set* screen will appear → configure the messages that you want to transmit through Bluetooth → click  to save the settings and start to transmit.

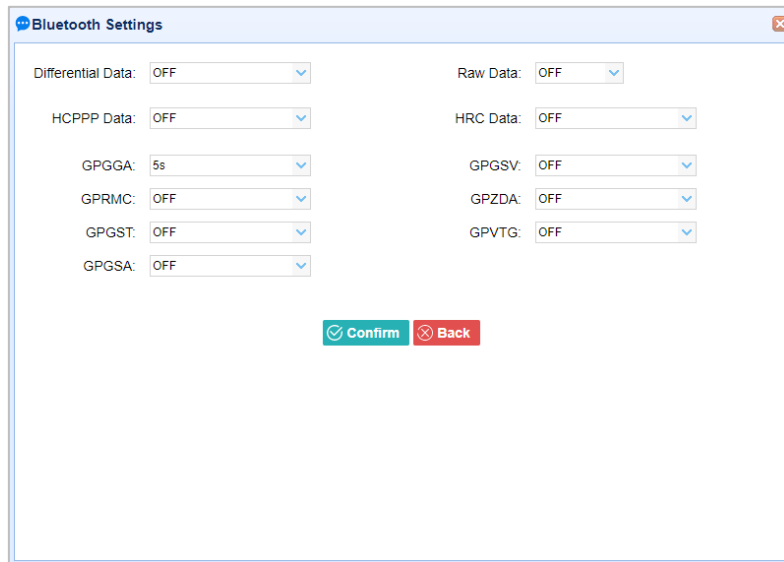

6. Radio

Tap the **Settings** button to the right of Radio → the *Radio Settings* screen will appear → select the format of differential data that you want to transmit through radio from the dropdown list → click  to save the settings and start to transmit.

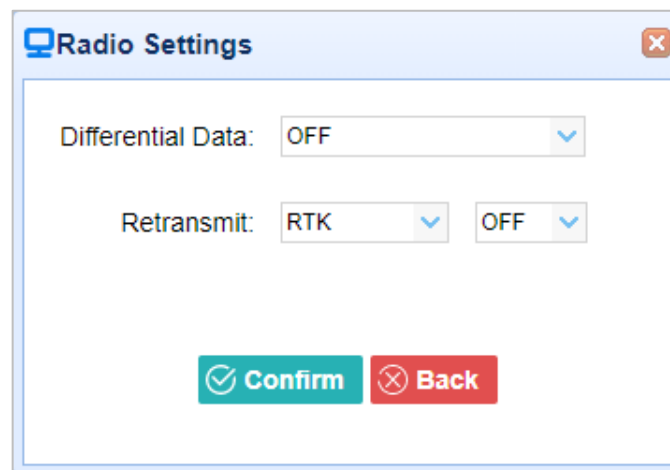

5.6 Network Setting Menu

Use this menu to view network information, configure the receiver’s mobile network, set email alert for specific situation, configure HTTP or HTTPS port, and the username and password of internal FTP site:

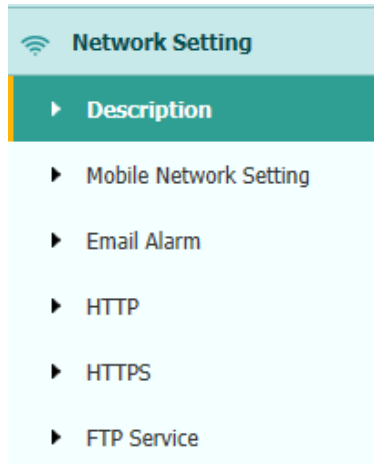

5.6.1 Description Submenu

Use this submenu to check the information of network setting.



5.6.2 Mobile Network Setting Submenu

Use this submenu to configure GPRS model, network module and modify dialing status.

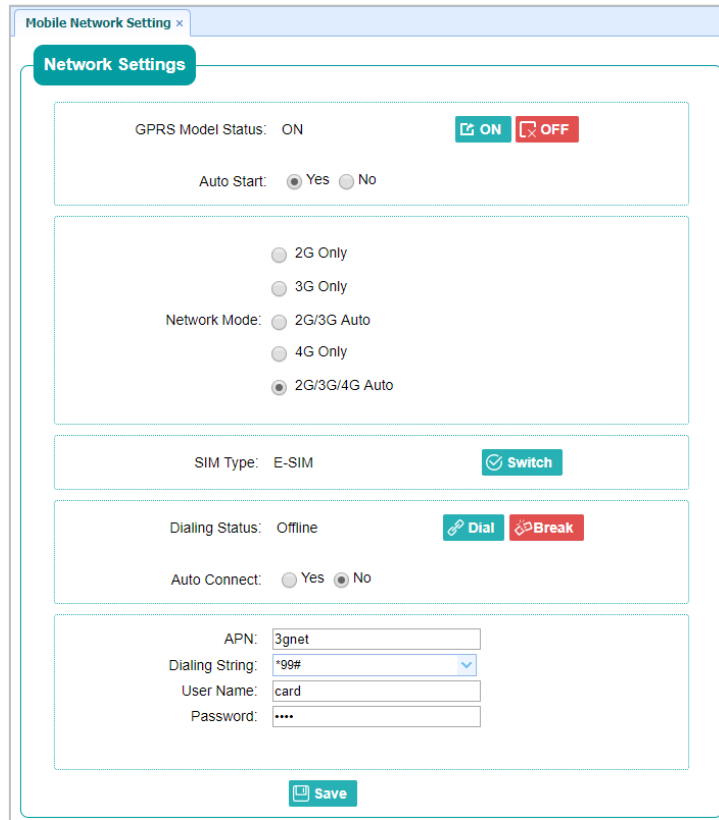

5.6.3 Email Alarm Submenu

Use this submenu to choose which situation of receiver will be alerted and input the email address.

Email Alarm ×

TO

Email Address 1:

Email Address 2:

Email Address 3:

Save

From

Account:

Password:

Server Address:

Save

Email Alert

- Receiver is powered on
- External power is off
- Battery level is low
- Ftp push is failed
- Reciever(license) will be expired in 7 days.

Save

5.6.4 HTTP Submenu

Use this submenu to configure HTTP port.

HTTP ×

HTTP Port: Save

5.6.5 HTTPS Submenu

Use this submenu to configure HTTPS port.

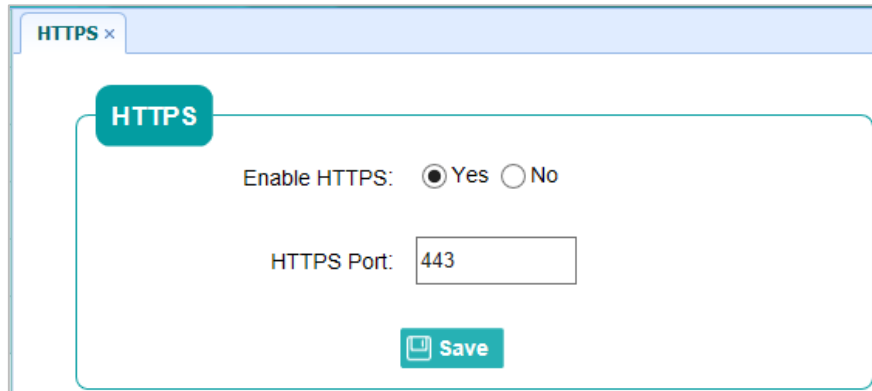

The screenshot shows a web interface for configuring the HTTPS service. At the top, there is a tab labeled "HTTPS x". Below the tab is a teal header with the text "HTTPS". The main configuration area contains the following elements:

- "Enable HTTPS:" followed by two radio buttons: "Yes" (which is selected) and "No".
- "HTTPS Port:" followed by a text input field containing the number "443".
- A teal "Save" button with a floppy disk icon.

5.6.6 FTP Service Submenu

Use this submenu to configure the user name and password of internal FTP site.

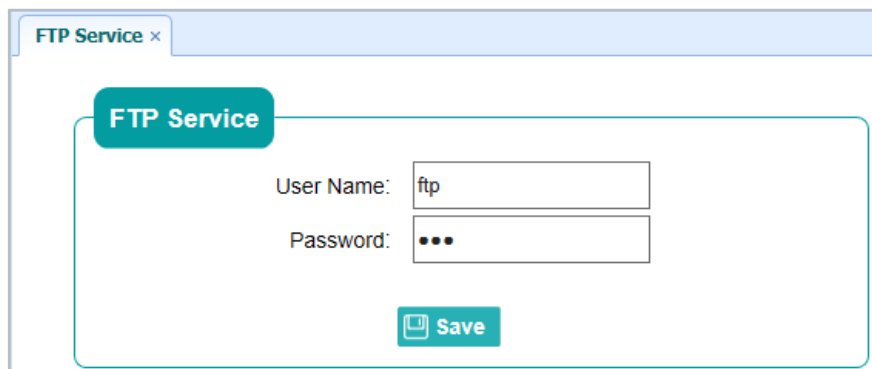

The screenshot shows a web interface for configuring the FTP service. At the top, there is a tab labeled "FTP Service x". Below the tab is a teal header with the text "FTP Service". The main configuration area contains the following elements:

- "User Name:" followed by a text input field containing the text "ftp".
- "Password:" followed by a text input field containing three black dots, indicating a masked password.
- A teal "Save" button with a floppy disk icon.

5.7 Module Setting Menu

Use this menu to check module information, configure WiFi, bluetooth, radio related settings, and turn on/off static voice of buzzer:

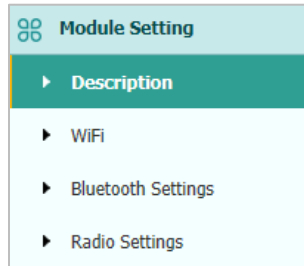

5.7.1 Description Submenu

Use this submenu to check the information of WiFi module, bluetooth module and radio module.

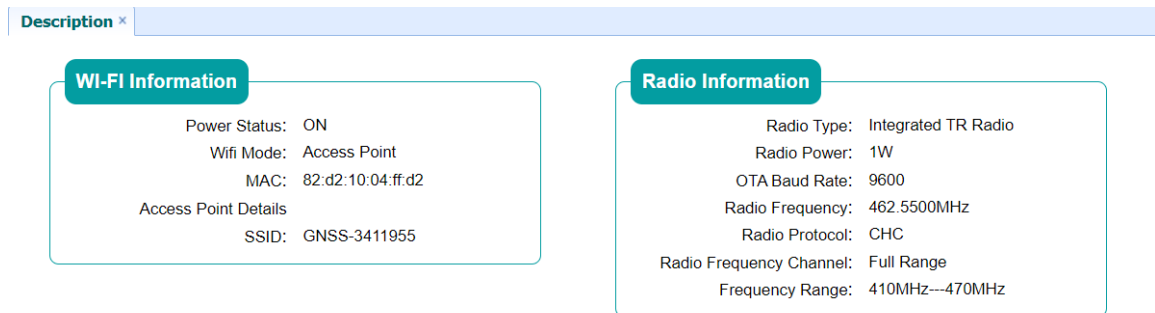

5.7.2 WiFi Submenu

Use this submenu to turn on/off WiFi function and modify password.

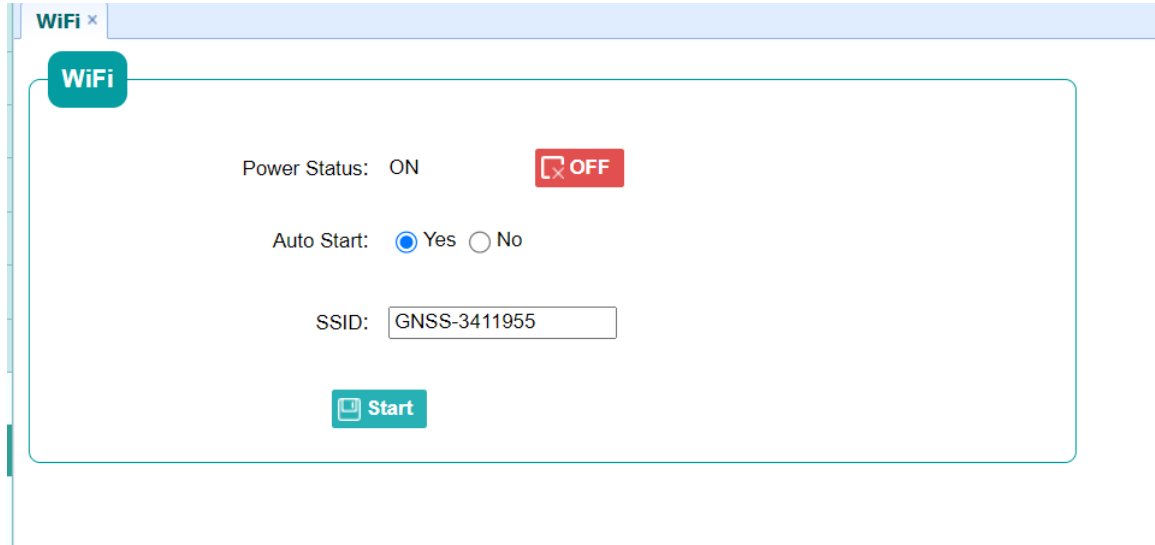

5.7.3 Bluetooth Settings Submenu

Use this submenu to turn on/off bluetooth function and modify PIN number.

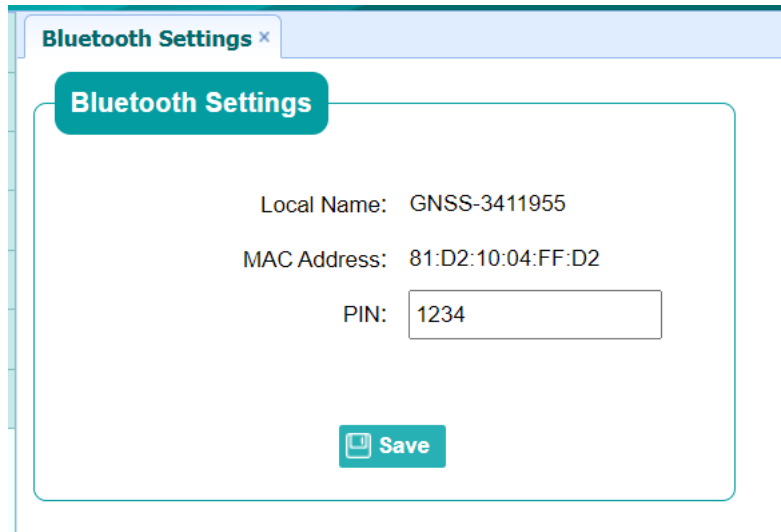

5.7.4 Radio Settings Submenu

Use this submenu to turn on/off radio function and configure radio parameters.

Radio Settings ×

Radio Settings

Radio Status: OFF

Auto Start: Yes No

Radio Protocol: CHC

Channel Bandwidth : 25 (kHz)

OTA Baud Rate: 9600

Radio Power: 1W

Radio Frequency: 9 462.5500 (410MHz--
-470MHz)

5.8 Firmware Menu

Use this menu to check the current firmware information, download the system log, update the receiver firmware, download or update the configuration file and register the receiver, and more:

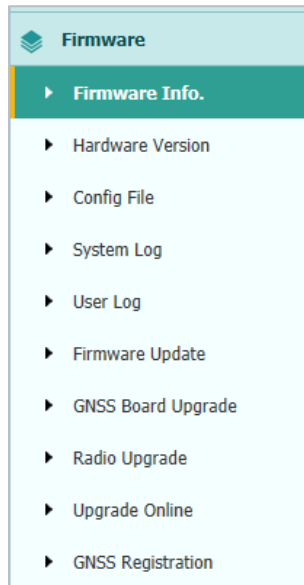

5.8.1 Firmware Info Submenu

Use this submenu to check the current firmware information. The following figure shows an example of the firmware information.

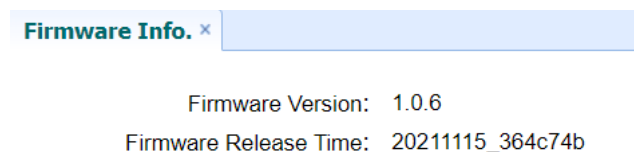

5.8.2 Hardware Version Submenu

Use this submenu to check the hardware information, including main board version and core board version:

Hardware Version ×

Main Board: 1.0.1
 Core Board: 1.0.1
 PN: A19318430901060002
 Board Firmware Version Number: 21893

5.8.3 Config File Submenu

Use this submenu to update Configuration File.

Config File ×

Download Configuration File : [Download](#)

Update Configuration File: [Browse](#)

[Confirm](#)

5.8.4 System Log Download Submenu

Use this submenu to download the system log of the receiver.

System Log ×

System Log Type:

[Download](#)

5.8.5 User Log Submenu

Use this submenu to download the user log. Tap **Download** to download current user log; Tick items that you want to see on the user log and tap confirm button to confirm selected user log.

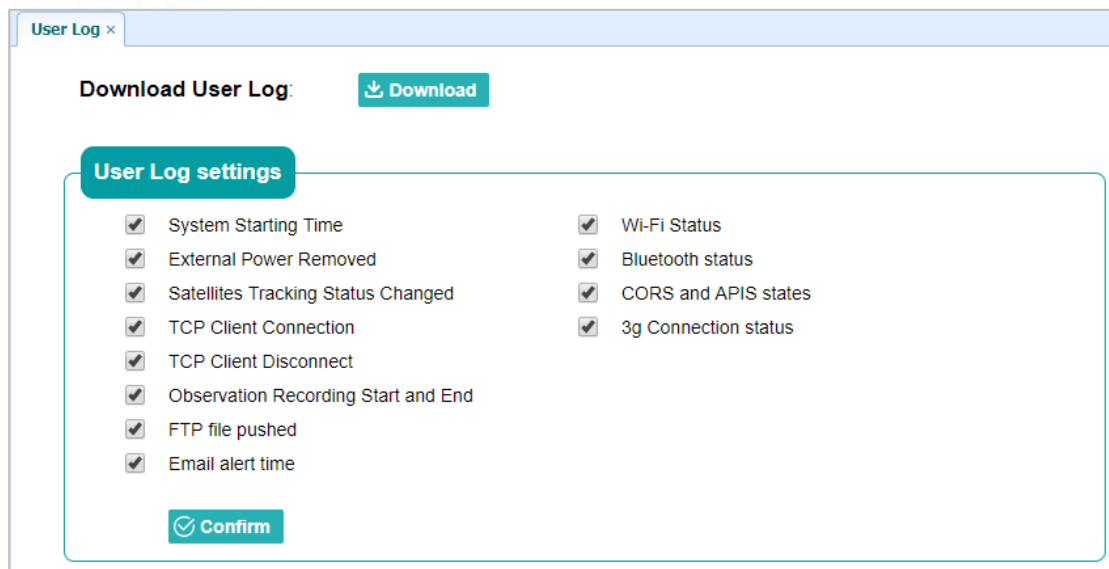

5.8.6 Firmware Update Submenu

Use this submenu to load new firmware to the receiver across the network. Tap the **Browse** button to locate the upgrade file → tap **Confirm** button to confirm the selected upgrading file and start upgrading.

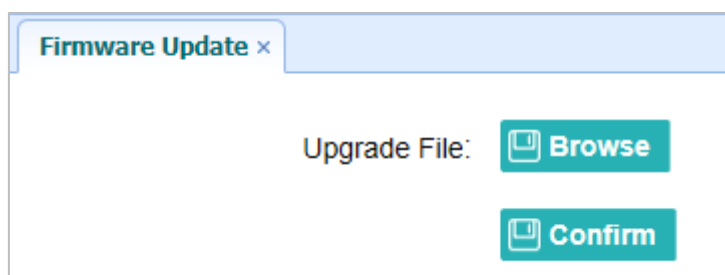

Notes

- It may take about 3 or 4 minutes to complete the firmware upgrading. Do not touch the power button or unplug the power until the upgrading process finishes, or damage will be caused to the receiver.
- The receiver will restart after the firmware upgrading is done, so users need to reconnect the receiver with your computer via Wi-Fi, and then log-in the receiver through a web browser to continue the configuration.

5.8.7 GNSS Board Upgrade Submenu

Use this submenu to upgrade GNSS Board. Use this submenu to load new board to the receiver across the network. Tap the **Browse** button to locate the upgrade file → tap **Confirm** button to confirm the selected upgrading file and start upgrading.

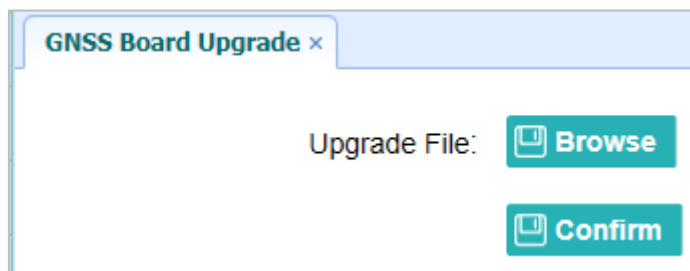

5.8.8 Radio Upgrade Submenu

Use this submenu to browse upgrade file and upgrade radio. Use this submenu to load new radio to the receiver across the network. Tap the **Browse** button to locate the upgrade file → tap **Confirm** button to confirm the selected upgrading file and start upgrading.

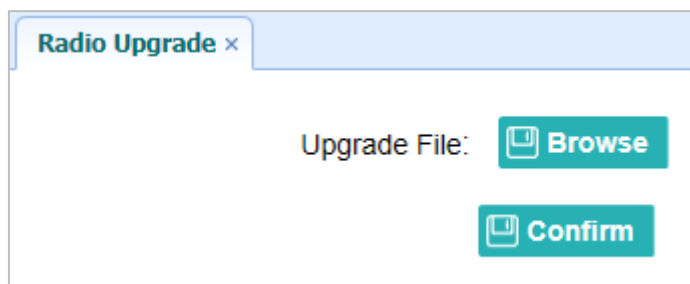

5.8.9 Upgrade Online Submenu

Use this submenu to input Server Address and upgrade online.

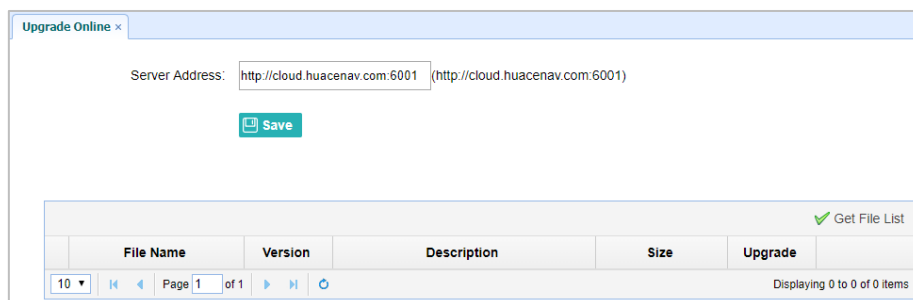

5.8.10 GNSS Registration Submenu

Use this submenu to register the receiver. Paste or enter the registration code to the *Registration Code* field → tap **Registration** button to complete the registration.

GNSS Registration ×

Serial Number:	3411955
Registration Limit:	2022-4-24
Registration Code:	XpHTmdQ4mSo

Registration

5.9 Cloud Service Setting Menu

5.9.1 Cloud Service Setting Submenu

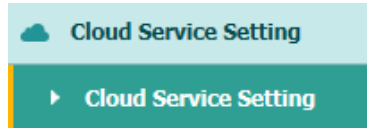

Use this submenu to turn on or turn off Cloud Service, Auto Start, Remote Control and configure other settings.

A Communication Ports Definition

AI CHC i93 Receiver IO Port (7-pin Lemo Port) Definition



PIN	FUNCTION
1	Ground (-)
2	Ground (-)
3	RS232-TX (Output)
4	PPS
5	Not Used
6	VIN
7	RS232-RX (Input)



当該機器には電波法に基づく、技術基準適合証明等を受けた特定無線設備を装着している。

電波法により 5.2 GHz 帯は屋内使用に限ります。

Warning: 5.2 GHz band is restricted to indoor use due to the Radio Law

CHC Navigation

577 Songying Road,
Qingpu District, 201702 Shanghai, China

Tel: +86 21 542 60 273 | Fax: +86 21 649 50 963
Email: sales@chcnav.com | support@chcnav.com
Skype: chcnav_support
Website: www.chcnav.com

This document is intended for general information purposes only. It does not consider the reader's specific circumstances and environmental constraints of use of GNSS

This equipment has been tested and found to comply with the limits for a Class B digital device, pursuant to part 15 of the FCC Rules. These limits are designed to provide reasonable protection against harmful interference in a residential installation. This equipment generates, uses and can radiate radio frequency energy and, if not installed and used in accordance with the instructions, may cause harmful interference to radio communications. However, there is no guarantee that interference will not occur in a particular installation. If this equipment does cause harmful interference to radio or television reception, which can be determined by turning the equipment off and on, the user is encouraged to try to correct the interference by one or more of the following measures:

- Reorient or relocate the receiving antenna.
- Increase the separation between the equipment and receiver.
- Connect the equipment into an outlet on a circuit different from that to which the receiver is connected.
- Consult the dealer or an experienced radio/TV technician for help.

Caution: Any changes or modifications to this device not explicitly approved by manufacturer could void your authority to operate this equipment.

This device complies with part 15 of the FCC Rules. Operation is subject to the following two conditions: (1) This device may not cause harmful interference, and (2) this device must accept any interference received, including interference that may cause undesired operation.

The device has been evaluated to meet general RF exposure requirement. This equipment complies with FCC radiation exposure limits set forth for an uncontrolled environment. This equipment should be installed and operated with minimum distance 50cm between the radiator & your body.