



FCC TEST REPORT

FCC ID: SY4-A02031

On Behalf of

Shanghai Huace Navigation Technology LTD.

Mobile Mapping System

Model No.: Alpha 3D

Prepared for : Shanghai Huace Navigation Technology LTD.
Address : 599 Gaojing Road, Building D, Shanghai 201702, China

Prepared By : Shenzhen Alpha Product Testing Co., Ltd.
Address : Building i, No.2, Lixin Road, Fuyong Street, Bao'an District, 518103,
Shenzhen, Guangdong, China

Report Number : A2103202-C02-R01
Date of Receipt : March 25, 2021
Date of Test : March 25, 2021- April 20, 2021
Date of Report : April 21, 2021
Version Number : V0

TABLE OF CONTENTS

Description	Page
1. Summary of Standards And Results -----	6
1.1. Description of Standards and Results -----	6
2. General Information -----	7
2.1. Description of Device (EUT)-----	7
2.2. Accessories of Device (EUT) -----	8
2.3. Tested Supporting System Details-----	8
2.4. Block Diagram of connection between EUT and simulators -----	8
2.5. Test Mode Description -----	9
2.6. Test Conditions -----	10
2.7. Test Facility -----	10
2.8. Measurement Uncertainty -----	10
2.9. Test Equipment List -----	11
3. Spurious Emission -----	12
3.1. Test Limits -----	12
3.2. Test Procedure -----	15
3.3. Test Setup -----	15
3.4. Test Results -----	16
4. Power line Conducted Emission -----	29
4.1. Test Limits -----	29
4.2. Test Procedure -----	29
4.3. Test Setup -----	29
4.4. Test Results -----	29
5. Conducted Maximum Output Power -----	30
5.1. Test limits -----	30
5.2. Test Procedure -----	30
5.3. Test Setup -----	30
5.4. Test Results -----	30
6. Peak Power Spectral Density -----	32
6.1. Test limits -----	32
6.2. Test Procedure -----	32
6.3. Test Setup -----	32
6.4. Test Results -----	33
7. Bandwidth -----	40
7.1. Test limits -----	40
7.2. Test Procedure -----	40
7.3. Test Setup -----	40
7.4. Test Results -----	40
8. Band Edge Check -----	54
8.1. Test limits -----	54
8.2. Test Procedure -----	54
8.3. Test Setup -----	54
8.4. Test Results -----	54
9. Frequency stability -----	59
9.1. Test limit -----	59
9.2. Test Procedure -----	59
9.3. Test Setup -----	59
9.4. Test Results -----	59

10. Antenna Requirement	60
10.1. Standard Requirement	60
10.2. Antenna Connected Construction	60
10.3. Results	60
11. Test setup photo	61
12. Photos of EUT	62

TEST REPORT DECLARATION

Applicant : Shanghai Huace Navigation Technology LTD.
 Address : 599 Gaojing Road, Building D, Shanghai 201702, China
 Manufacturer : Shanghai Huace Navigation Technology LTD.
 Address : 599 Gaojing Road, Building D, Shanghai 201702, China
 EUT Description : Mobile Mapping System
 (A) Model No. : Alpha 3D
 (B) Trademark : 

Measurement Standard Used:

FCC Rules and Regulations Part 15 Subpart C Section 15.247
RSS-247 Issue 2, RSS-Gen Issue 5, ANSI C63.10, CISPR 16-1-4

The device described above is tested by Shenzhen Alpha Product Testing Co., Ltd. to determine the maximum emission levels emanating from the device. The maximum emission levels are compared to the FCC Part 15 Subpart C limits both conducted and radiated emissions. The test results are contained in this test report and Shenzhen Alpha Product Testing Co., Ltd. is assumed of full responsibility for the accuracy and completeness of these tests.

After the test, our opinion is that EUT compliance with the requirement of the above standards.

This report applies to above tested sample only. This report shall not be reproduced in parts without written approval of Shenzhen Alpha Product Testing Co., Ltd.

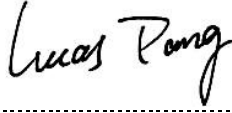
Tested by (name + signature).....: Lucas Pang
 Project Engineer 

Approved by (name + signature).....: Simple Guan
 Project Manager 

Date of issue..... : April 21, 2021

Revision History

Revision	Issue Date	Revisions	Revised By
V0	April 21, 2021	Initial released Issue	Lucas Pang

1. SUMMARY OF STANDARDS AND RESULTS

1.1. Description of Standards and Results

The EUT have been tested according to the applicable standards as referenced below:

Test Item	Standards Paragraph	Result
Conducted Emission	FCC Part 15: 15.207 RSS-GEN(8.8) ANSI C63.10	P
6dB Bandwidth	FCC PART 15:15.247(a)(2) RSS-247(5.2 a) ANSI C63.10	P
Output Power	FCC Part 15: 15.247(b)(3) RSS-247(5.4 d) ANSI C63.10	P
Radiated Spurious Emission	FCC Part 15: 15.209 FCC Part 15: 15.247(d) RSS-Gen(8.9), RSS-247(5.5) ANSI C63.10	P
Conducted Spurious & Band Edge Emission	FCC Part 15: 15.247(d) RSS-Gen(8.9), RSS-247(5.5) ANSI C63.10	P
Power Spectral Density	FCC PART 15:15.247(e) RSS-247(5.2 b) ANSI C63.10	P
Radiated Band Edge Emission	FCC Part 15: 15.247(d) RSS-GEN(6.13) ANSI C63.10	P
Frequency stability	RSS-GEN(6.11)	N/A
Antenna Requirement	FCC Part 15: 15.203 RSS-GEN(6.8)	P
Note:	1. P is an abbreviation for Pass. 2. F is an abbreviation for Fail. 3. N/A is an abbreviation for Not Applicable.	

2. GENERAL INFORMATION

2.1. Description of Device (EUT)

EUT Name : Mobile Mapping System

Trademark : 

Model No. : Alpha 3D

DIFF. : /

Power supply : DC 9-32V

Test voltage : DC 24V from battery

2.4G WiFi :

Operation frequency : 2412MHz-2462MHz for IEEE 802.11b,g,n/HT20
2422MHz-2452MHz for IEEE 802.11n/HT40

Channel No. : 802.11b/802.11g/802.11n(HT20):11CH
802.11n(HT40):7CH

Modulation type : IEEE802.11b:DSSS(CCK,DQPSK,DBPSK)
IEEE802.11g:OFDM(64QAM,16QAM,QPSK,BPSK)
IEEE802.11n:OFDM(64QAM,16QAM,QPSK,BPSK)

Antenna Type : ANT1: Internal Antenna, max gain 3dBi.
ANT2: Internal Antenna, max gain 3dBi.

Software version : V1.0

Hardware version : V1.0

Intend use environment : Residential, commercial and light industrial environment

Note : /

2.2. Accessories of Device (EUT)

Accessories 1	:	/
Manufacturer	:	/
Model	:	/
Input	:	/
Output	:	/

2.3. Tested Supporting System Details

No.	Description	Manufacturer	Model	Serial Number	Certification or SDOC
1	Battery	N/A	N/A	N/A	N/A
2	Monitor	Lenovo	N/A	N/A	N/A
3	Keyboard	Lenovo	N/A	N/A	N/A
4.	Mouse	Lenovo	N/A	N/A	N/A

2.4. Block Diagram of connection between EUT and simulators

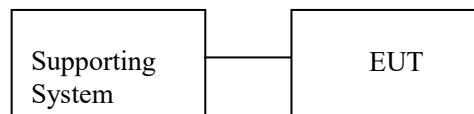

2.5. Test Mode Description

Duty cycle :100% Keeping TX			
Mode	data rate (Mbps)(see Note)	Channel	Frequency (MHz)
IEEE 802.11b	1	Low :CH1	2412
	1	Middle: CH6	2437
	1	High: CH11	2462
IEEE 802.11g	6	Low :CH1	2412
	6	Middle: CH6	2437
	6	High: CH11	2462
IEEE 802.11 n/HT20 with 2.4G	6.5	Low :CH1	2412
	6.5	Middle: CH6	2437
	6.5	High: CH11	2462
IEEE 802.11 n/HT40 with 2.4G	13	Low :CH3	2422
	13	Middle: CH6	2437
	13	High: CH9	2452

Note: According exploratory test, EUT will have maximum output power in those data rate. so those data rate were used for all test.

Channel list:					
For IEEE 802.11b, g, n/HT20					
Channel	Frequency (MHz)	Channel	Frequency (MHz)	Channel	Frequency (MHz)
CH1	2412	CH5	2432	CH9	2452
CH2	2417	CH6	2437	CH10	2457
CH3	2422	CH7	2442	CH11	2462
CH4	2427	CH8	2447		
For IEEE 802.11 n/HT40					
Channel	Frequency (MHz)	Channel	Frequency (MHz)	Channel	Frequency (MHz)
CH1	/	CH5	2432	CH9	2452
CH2	/	CH6	2437		
CH3	2422	CH7	2442		
CH4	2427	CH8	2447		

Setting output power (Max)			
802.11b	802.11g	802.11n(HT20)	802.11n(HT40)
15 ± 2dBm	15 ± 2dBm	15 ± 2dBm	15 ± 2dBm

2.6. Test Conditions

Items	Required	Actual
Temperature range:	15-35°C	24°C
Humidity range:	25-75%	56%
Pressure range:	86-106kPa	98kPa

2.7. Test Facility

Shenzhen Alpha Product Testing Co., Ltd
 Building i, No.2, Lixin Road, Fuyong Street, Bao'an District, 518103,
 Shenzhen, Guangdong, China

June 21, 2018 File on Federal Communication Commission
 Registration Number: 293961
 Designation Number: CN1236

July 15, 2019 Certificated by IC
 Registration Number: 12135A

2.8. Measurement Uncertainty

(95% confidence levels, k=2)

Item	Uncertainty
Uncertainty for Power point Conducted Emissions Test	2.74dB
Uncertainty for Radiation Emission test in 3m chamber (below 30MHz)	2.13 dB(Polarize: V)
	2.57dB(Polarize: H)
Uncertainty for Radiation Emission test in 3m chamber (30MHz to 1GHz)	3.77dB(Polarize: V)
	3.80dB(Polarize: H)
Uncertainty for Radiation Emission test in 3m chamber (1GHz to 25GHz)	4.13dB(Polarize: H)
	4.16dB(Polarize: V)
Uncertainty for radio frequency	5.4×10^{-8}
Uncertainty for conducted RF Power	0.37dB
Uncertainty for temperature	0.2°C
Uncertainty for humidity	1%
Uncertainty for DC and low frequency voltages	0.06%

2.9. Test Equipment List

Equipment	Manufacture	Model No.	Serial No.	Last cal.	Cal Interval
9*6*6 anechoic chamber	CHENYU	9*6*6	N/A	2019.09.06	3Year
Spectrum analyzer	ROHDE&SCHWARZ	FSV40-N	102137	2020.09.02	1Year
Spectrum analyzer	Agilent	N9020A	MY499100060	2020.09.02	1Year
Receiver	ROHDE&SCHWARZ	ESR	1316.3003K03-10208 2-Wa	2020.09.02	1Year
Receiver	R&S	ESCI	101165	2020.09.02	1Year
Bilog Antenna	Schwarzbeck	VULB 9168	VULB9168-438	2020.04.12	2Year
Horn Antenna	SCHWARZBECK	BBHA 9120 D	BBHA 9120 D(1201)	2020.04.12	2Year
Active Loop Antenna	SCHWARZBECK	FMZB 1519B	00059	2019.09.07	2Year
Cable	Resenberger	N/A	No.1	2020.09.02	1Year
Cable	Resenberger	N/A	No.2	2020.09.02	1Year
Cable	Resenberger	N/A	No.3	2020.09.02	1Year
Pre-amplifier	HP	HP8347A	2834A00455	2020.09.02	1Year
Pre-amplifier	Agilent	8449B	3008A02664	2020.09.02	1Year
L.I.S.N.#1	Schwarzbeck	NSLK8126	8126466	2020.09.02	1Year
L.I.S.N.#2	ROHDE&SCHWARZ	ENV216	101043	2020.09.02	1Year
20db Attenuator	ICPROBING	IATS1	82347	2020.09.02	1Year
Horn Antenna	SCHWARZBECK	BBHA9170	00946	2019.09.07	2Year
Preamplifier	SKET	LNPA_1840-50	SK2018101801	2020.09.02	1Year
Power Meter	Agilent	E9300A	MY41496625	2020.09.02	1Year
Temp. & Humid. Chamber	Weihuang	WHTH-1000-40-8 80	100631	2020.09.02	1Year
Switching Mode Power Supply	JUNKE	JK12010S	20140927-6	2020.09.02	1Year

3. SPURIOUS EMISSION

3.1. Test Limits

All the emissions appearing within 15.205 restricted frequency bands shall not exceed the limits shown in 15.209, all the other emissions shall be at least 20dB below the fundamental emissions, or comply with 15.209 limits.

15.205 Restricted frequency band

MHz	MHz	MHz	GHz
0.090 - 0.110	16.42 - 16.423	399.9 - 410	4.5 - 5.15
¹ 0.495 - 0.505	16.69475 - 16.69525	608 - 614	5.35 - 5.46
2.1735 - 2.1905	16.80425 - 16.80475	960 - 1240	7.25 - 7.75
4.125 - 4.128	25.5 - 25.67	1300 - 1427	8.025 - 8.5
4.17725 - 4.17775	37.5 - 38.25	1435 - 1626.5	9.0 - 9.2
4.20725 - 4.20775	73 - 74.6	1645.5 - 1646.5	9.3 - 9.5
6.215 - 6.218	74.8 - 75.2	1660 - 1710	10.6 - 12.7
6.26775 - 6.26825	108 - 121.94	1718.8 - 1722.2	13.25 - 13.4
6.31175 - 6.31225	123 - 138	2200 - 2300	14.47 - 14.5
8.291 - 8.294	149.9 - 150.05	2310 - 2390	15.35 - 16.2
8.362 - 8.366	156.52475 - 156.52525	2483.5 - 2500	17.7 - 21.4
8.37625 - 8.38675	156.7 - 156.9	2690 - 2900	22.01 - 23.12
8.41425 - 8.41475	162.0125 - 167.17	3260 - 3267	23.6 - 24.0
12.29 - 12.293	167.72 - 173.2	3332 - 3339	31.2 - 31.8
12.51975 - 12.52025	240 - 285	3345.8 - 3358	36.43 - 36.5
12.57675 - 12.57725	322 - 335.4	3600 - 4400	(²)

RSS-GEN Restricted frequency band

Table 7 – Restricted frequency bandsNote 1

MHz	MHz	GHz
0.090 - 0.110	149.9 - 150.05	9.0 - 9.2
0.495 - 0.505	156.52475 - 156.52525	9.3 - 9.5
2.1735 - 2.1905	156.7 - 156.9	10.6 - 12.7
3.020 - 3.026	162.0125 - 167.17	13.25 - 13.4
4.125 - 4.128	167.72 - 173.2	14.47 - 14.5
4.17725 - 4.17775	240 – 285	15.35 - 16.2
4.20725 - 4.20775	322 - 335.4	17.7 - 21.4
5.677 - 5.683	399.9 - 410	22.01 - 23.12

6.215 - 6.218	608 - 614	23.6 - 24.0
6.26775 - 6.26825	960 - 1427	31.2 - 31.8
6.31175 - 6.31225	1435 - 1626.5	36.43 - 36.5
8.291 - 8.294	1645.5 - 1646.5	Above 38.6
8.362 - 8.366	1660 - 1710	
8.37625 - 8.38675	1718.8 - 1722.2	
8.41425 - 8.41475	2200 - 2300	
12.29 - 12.293	2310 - 2390	
12.51975 - 12.52025	2483.5 - 2500	
12.57675 - 12.57725	2655 - 2900	
13.36 - 13.41	3260 – 3267	
16.42 - 16.423	3332 - 3339	
16.69475 - 16.69525	3345.8 - 3358	
16.80425 - 16.80475	3500 - 4400	
25.5 - 25.67	4500 - 5150	
37.5 - 38.25	5350 - 5460	
73 - 74.6	7250 - 7750	
74.8 - 75.2	8025 – 8500	
108 – 138		

Note 1: Certain frequency bands listed in table 7 and in bands above 38.6 GHz are designated for licence-exempt applications. These frequency bands and the requirements that apply to related devices are set out in the 200 and 300 series of RSSs.

15.209 Limit

FREQUENCY MHz	DISTANCE Meters	FIELD STRENGTHS LIMIT	
		$\mu\text{V}/\text{m}$	$\text{dB}(\mu\text{V})/\text{m}$
0.009-0.490	300	2400/F(KHz)	/
0.490-1.705	30	24000/F(KHz)	/
1.705-30	30	30	29.5
30 ~ 88	3	100	40.0
88 ~ 216	3	150	43.5
216 ~ 960	3	200	46.0
960 ~ 1000	3	500	54.0
Above 1000	3	74.0 $\text{dB}(\mu\text{V})/\text{m}$ (Peak) 54.0 $\text{dB}(\mu\text{V})/\text{m}$ (Average)	
Note 1: The peak limit is 20 dB higher than the average limit			
Note 2: Peak limit applies (AVG limit + 20 dB) as well as RSS-247 Section 5.5			

Harmonic emissions limits comply with below 54 dBuV/m at 3m. Other emissions radiated outside of the specified frequency bands, except for harmonics, shall be attenuated by at least 50 dB below the level of the fundamental or comply with the radiated emissions limits specified in section 15.209(a) limit in the table below has to be followed.

Table 5 – General field strength limits at frequencies above 30 MHz

Frequency (MHz)	Field strength ($\mu\text{V}/\text{m}$ at 3 m)
30 – 88	100
88 – 216	150
216 – 960	200
Above 960	500

Table 6 – General field strength limits at frequencies below 30 MHz

Frequency	Magnetic field strength (H-Field) ($\mu\text{A}/\text{m}$)	Measurement distance (m)
9 - 490 kHz ^{Note 1}	6.37/F (F in kHz)	300
490 - 1705 kHz	63.7/F (F in kHz)	30
1.705 - 30 MHz	0.08	30

Note 1: The emission limits for the ranges 9-90 kHz and 110-490 kHz are based on measurements employing a linear average detector.

3.2. Test Procedure

The measuring distance of 3m shall be used for measurements at frequency up to 1GHz and above 1GHz. The EUT was placed on a rotating 0.8 m high above ground for below 1GHz and 1.5m high for above 1GHz testing, the table was rotated 360 degrees to determine the position of the highest radiation

The Test antenna shall vary between 1m and 4m, both Horizontal and Vertical antenna are set to make measurement.

The initial step in collecting radiated emission data is a spectrum analyzer Peak detector mode pre-scanning the measurement frequency range. Significant Peaks are then marked. and then Quasi Peak Detector mode premeasured

If Peak value comply with QP limit below 1GHz, the EUT deemed to comply with QP limit.

But the Peak value and average value both need to comply with applicable limit above 1GHz.

For the actual test configuration, please see the test setup photo.

3.3. Test Setup

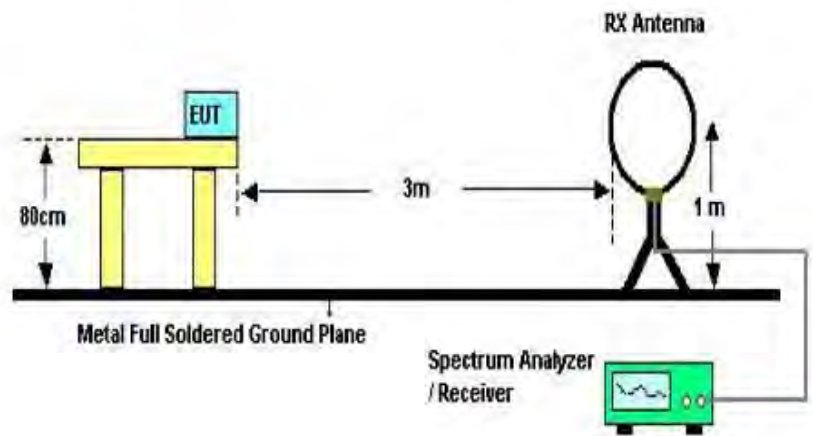

Below 30MHz Test Setup

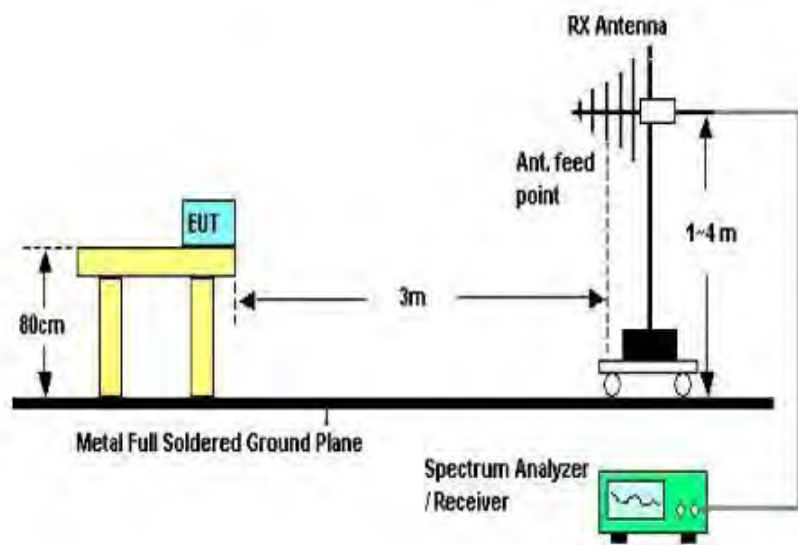

Above 30MHz Test Setup

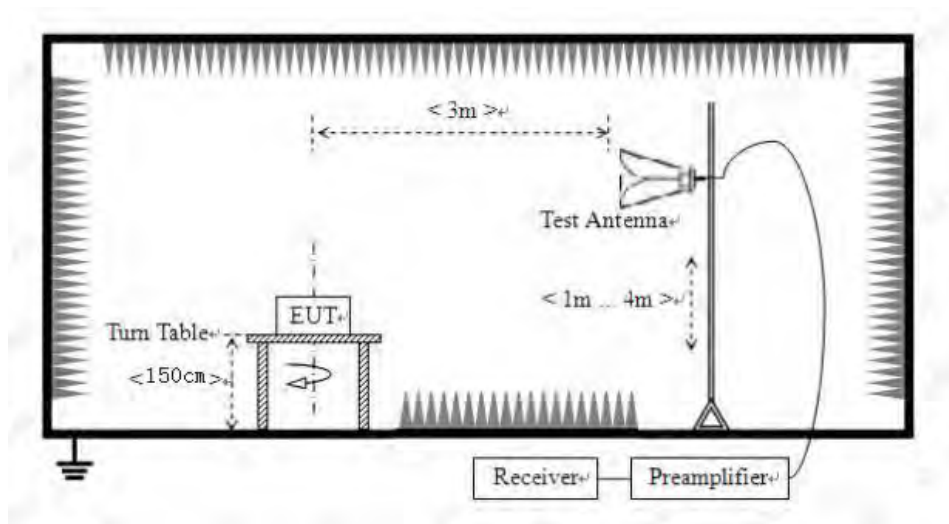

Above 1GHz Test Setup

3.4. Test Results

Test Condition

Continual Transmitting in maximum power.

9KHz~150KHz	RBW200Hz	VBW1KHz
150KHz~30MHz	RBW9KHz	VBW 30KHz
30MHz~1GHz	RBW120KHz	VBW 300KHz
Above1GHz	RBW1MHz	VBW 3MHz

We have scanned the EUT from 9kHz up to the 10th harmonic of the fundamental.

Detailed information please see the following page.

From 9KHz to 30MHz: Conclusion: PASS

Note: 1.The amplitude of spurious emissions which are attenuated by more than 20dB below the permissible value has no need to be reported.

2.Only show the test data of the worst Channel in this report.

From 30MHz to 1000MHz: Conclusion: PASS			
EUT Description	Mobile Mapping System	Temperature	24°C
Model No.	Alpha 3D	Humidity	56%
Pol	Vertical	Test mode	802.11b 2412MHz
Test Voltage	DC 24V		

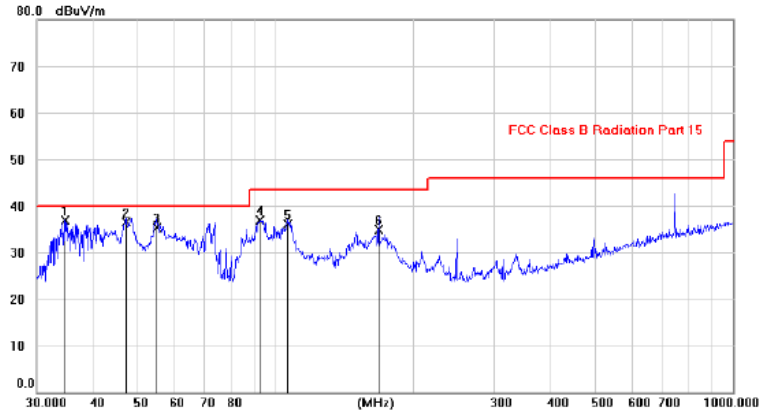

No. Mk.	Freq.	Reading Level	Correct Factor	Measurement	Limit	Margin	Antenna Height	Table Degree	Comment
	MHz	dBuV	dB	dBuV/m	dBuV/m	dB	cm	degree	
1 *	34.5213	23.10	13.71	36.81	40.00	-3.19			peak
2	47.1543	22.43	14.07	36.50	40.00	-3.50			QP
3	54.9438	21.82	13.58	35.40	40.00	-4.60			QP
4	92.6355	26.67	10.30	36.97	43.50	-6.53			peak
5	106.6714	24.60	11.50	36.10	43.50	-7.40			QP
6	168.0008	20.59	14.27	34.86	43.50	-8.64			QP

Pol	Horizontal
------------	------------

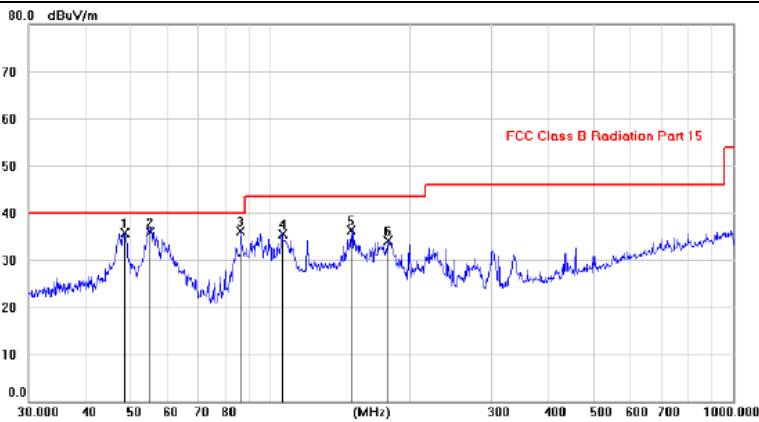

No. Mk.	Freq.	Reading Level	Correct Factor	Measurement	Limit	Margin	Antenna Height	Table Degree	Comment
	MHz	dBuV	dB	dBuV/m	dBuV/m	dB	cm	degree	
1	48.4788	21.64	14.05	35.69	40.00	-4.31			peak
2	54.9182	22.29	13.58	35.87	40.00	-4.13			QP
3 *	86.4725	26.11	9.99	36.10	40.00	-3.90			peak
4	106.1118	24.03	11.45	35.48	43.50	-8.02			peak
5	149.9582	21.31	15.06	36.37	43.50	-7.13			peak
6	179.7011	21.44	12.72	34.16	43.50	-9.34			peak

*:Maximum data x:Over limit !:over margin

Note: Measurement=Reading Level+Correc Factor. Factor=(LISN or ISN or PLC or Current Probe)Factor+Cable

Remark: All modes have been tested, and only worst data was listed in this report.

From 1G-25GHz

Test Mode: IEEE 802.11b TX Low									
Freq (MHz)	Read Level (dBuV/m)	Polar (H/V)	Antenna Factor (dB/m)	Cable loss(dB)	Amp Factor (dB)	Result (dBuV/m)	Limit (dBuV/m)	Margin (dB)	Remark
4824	46.27	V	33.98	10.22	34.25	56.22	74	17.78	PK
4824	35.57	V	33.98	10.22	34.25	45.52	54	8.48	AV
7236	/	/	/	/	/	/	/	/	/
9648	/	/	/	/	/	/	/	/	/
4824	46.06	H	33.98	10.22	34.25	56.01	74	17.99	PK
4824	35.17	H	33.98	10.22	34.25	45.12	54	8.88	AV
7236	/	/	/	/	/	/	/	/	/
9648	/	/	/	/	/	/	/	/	/
Test Mode: IEEE 802.11b TX Mid									
4874	46.06	V	33.98	10.22	34.25	56.01	74	17.99	PK
4874	35.45	V	33.98	10.22	34.25	45.40	54	8.60	AV
7311	/	/	/	/	/	/	/	/	/
9748	/	/	/	/	/	/	/	/	/
4874	46.30	H	33.98	10.22	34.25	56.25	74	17.75	PK
4874	35.14	H	33.98	10.22	34.25	45.09	54	8.91	AV
7311	/	/	/	/	/	/	/	/	/
9748	/	/	/	/	/	/	/	/	/
Test Mode: IEEE 802.11b TX High									
4924	46.35	V	33.98	10.22	34.25	56.30	74	17.70	PK
4924	36.12	V	33.98	10.22	34.25	46.07	54	7.93	AV
7386	/	/	/	/	/	/	/	/	/
9848	/	/	/	/	/	/	/	/	/
4924	46.49	H	33.98	10.22	34.25	56.44	74	17.56	PK
4924	34.38	H	33.98	10.22	34.25	44.33	54	9.67	AV
7386	/	/	/	/	/	/	/	/	/
9848	/	/	/	/	/	/	/	/	/

Note:

- 1, Result = Read level + Antenna factor + cable loss-Amp factor
- 2, All the other emissions not reported were too low to read and deemed to comply with FCC limit.

Test Mode: IEEE 802.11g TX Low									
Freq (MHz)	Read Level (dBuV/m)	Polar (H/V)	Antenna Factor (dB/m)	Cable loss(dB)	Amp Factor (dB)	Result (dBuV/m)	Limit (dBuV/m)	Margin (dB)	Remark
4824	45.91	V	33.98	10.22	34.25	55.86	74	18.14	PK
4824	36.00	V	33.98	10.22	34.25	45.95	54	8.05	AV
7236	/	/	/	/	/	/	/	/	/
9648	/	/	/	/	/	/	/	/	/
4824	46.64	H	33.98	10.22	34.25	56.59	74	17.41	PK
4824	35.17	H	33.98	10.22	34.25	45.12	54	8.88	AV
7236	/	/	/	/	/	/	/	/	/
9648	/	/	/	/	/	/	/	/	/
Test Mode: IEEE 802.11g TX Mid									
4874	46.29	V	33.98	10.22	34.25	56.24	74	17.76	PK
4874	35.41	V	33.98	10.22	34.25	45.36	54	8.64	AV
7311	/	/	/	/	/	/	/	/	/
9748	/	/	/	/	/	/	/	/	/
4874	46.29	H	33.98	10.22	34.25	56.24	74	17.76	PK
4874	34.31	H	33.98	10.22	34.25	44.26	54	9.74	AV
7311	/	/	/	/	/	/	/	/	/
9748	/	/	/	/	/	/	/	/	/
Test Mode: IEEE 802.11g TX High									
4924	45.72	V	33.98	10.22	34.25	55.67	74	18.33	PK
4924	36.18	V	33.98	10.22	34.25	46.13	54	7.87	AV
7386	/	/	/	/	/	/	/	/	/
9848	/	/	/	/	/	/	/	/	/
4924	46.75	H	33.98	10.22	34.25	56.70	74	17.30	PK
4924	34.46	H	33.98	10.22	34.25	44.41	54	9.59	AV
7386	/	/	/	/	/	/	/	/	/
9848	/	/	/	/	/	/	/	/	/
Note:									
1, Result = Read level + Antenna factor + cable loss-Amp factor									
2, All the other emissions not reported were too low to read and deemed to comply with FCC limit.									

Test Mode:IEEE 802.11n HT20 TX Low									
Freq (MHz)	Read Level (dBuV/m)	Polar (H/V)	Antenna Factor (dB/m)	Cable loss(dB)	Amp Factor (dB)	Result (dBuV/m)	Limit (dBuV/m)	Margin (dB)	Remark
4824	45.77	V	33.98	10.22	34.25	55.72	74	18.28	PK
4824	35.87	V	33.98	10.22	34.25	45.82	54	8.18	AV
7236	/	/	/	/	/	/	/	/	/
9648	/	/	/	/	/	/	/	/	/
4824	46.63	H	33.98	10.22	34.25	56.58	74	17.42	PK
4824	34.72	H	33.98	10.22	34.25	44.67	54	9.33	AV
7236	/	/	/	/	/	/	/	/	/
9648	/	/	/	/	/	/	/	/	/
Test Mode:IEEE 802.11n HT20 TX Mid									
4874	46.12	V	33.98	10.22	34.25	56.07	74	17.93	PK
4874	35.81	V	33.98	10.22	34.25	45.76	54	8.24	AV
7311	/	/	/	/	/	/	/	/	/
9748	/	/	/	/	/	/	/	/	/
4874	46.59	H	33.98	10.22	34.25	56.54	74	17.46	PK
4874	34.36	H	33.98	10.22	34.25	44.31	54	9.69	AV
7311	/	/	/	/	/	/	/	/	/
9748	/	/	/	/	/	/	/	/	/
Test Mode:IEEE 802.11n HT20 TX High									
4924	46.17	V	33.98	10.22	34.25	56.12	74	17.88	PK
4924	35.85	V	33.98	10.22	34.25	45.80	54	8.20	AV
7386	/	/	/	/	/	/	/	/	/
9848	/	/	/	/	/	/	/	/	/
4924	46.02	H	33.98	10.22	34.25	55.97	74	18.03	PK
4924	35.20	H	33.98	10.22	34.25	45.15	54	8.85	AV
7386	/	/	/	/	/	/	/	/	/
9848	/	/	/	/	/	/	/	/	/
Note:									
1, Result = Read level + Antenna factor + cable loss-Amp factor									
2, All the other emissions not reported were too low to read and deemed to comply with FCC limit.									

Test Mode:IEEE 802.11n HT40 TX Low									
Freq (MHz)	Read Level (dBuV/m)	Polar (H/V)	Antenna Factor (dB/m)	Cable loss(dB)	Amp Factor (dB)	Result (dBuV/m)	Limit (dBuV/m)	Margin (dB)	Remark
4844	45.64	V	33.98	10.22	34.25	55.59	74	18.41	PK
4844	35.69	V	33.98	10.22	34.25	45.64	54	8.36	AV
7266	/	/	/	/	/	/	/	/	/
9688	/	/	/	/	/	/	/	/	/
4844	46.27	H	33.98	10.22	34.25	56.22	74	17.78	PK
4844	34.51	H	33.98	10.22	34.25	44.46	54	9.54	AV
7266	/	/	/	/	/	/	/	/	/
9688	/	/	/	/	/	/	/	/	/
Test Mode:IEEE 802.11n HT40 TX Mid									
4874	46.35	V	33.98	10.22	34.25	56.30	74	17.70	PK
4874	36.09	V	33.98	10.22	34.25	46.04	54	7.96	AV
7311	/	/	/	/	/	/	/	/	/
9748	/	/	/	/	/	/	/	/	/
4874	46.49	H	33.98	10.22	34.25	56.44	74	17.56	PK
4874	35.14	H	33.98	10.22	34.25	45.09	54	8.91	AV
7311	/	/	/	/	/	/	/	/	/
9748	/	/	/	/	/	/	/	/	/
Test Mode:IEEE 802.11n HT40 TX High									
4904	46.30	V	33.98	10.22	34.25	56.25	74	17.75	PK
4904	35.47	V	33.98	10.22	34.25	45.42	54	8.58	AV
7356	/	/	/	/	/	/	/	/	/
9808	/	/	/	/	/	/	/	/	/
4904	46.20	H	33.98	10.22	34.25	56.15	74	17.85	PK
4904	35.20	H	33.98	10.22	34.25	45.15	54	8.85	AV
7356	/	/	/	/	/	/	/	/	/
9808	/	/	/	/	/	/	/	/	/

Note:

1, Result = Read level + Antenna factor + cable loss-Amp factor

2, All the other emissions not reported were too low to read and deemed to comply with FCC limit.

Note: All modes have been tested, and only SISO Ant1 and MIMO mode data are recorded.

Conducted RF Spurious Emission

Condition	Mode	Frequency (MHz)	Antenna	Max Value (dBc)	Limit (dBc)	Verdict
NVNT	b	2412	Ant1	-49.47	-30	Pass
NVNT	b	2437	Ant1	-50.02	-30	Pass
NVNT	b	2462	Ant1	-49.28	-30	Pass
NVNT	g	2412	Ant1	-49.42	-30	Pass
NVNT	g	2437	Ant1	-49.79	-30	Pass
NVNT	g	2462	Ant1	-47.68	-30	Pass
NVNT	n20	2412	MIMO	-49.29	-30	Pass
NVNT	n20	2437	MIMO	-46.7	-30	Pass
NVNT	n20	2462	MIMO	-44.94	-30	Pass
NVNT	n40	2422	MIMO	-44.16	-30	Pass
NVNT	n40	2437	MIMO	-46.71	-30	Pass
NVNT	n40	2452	MIMO	-47.79	-30	Pass

Tx. Spurious NVNT b 2412MHz Ant1 Emission

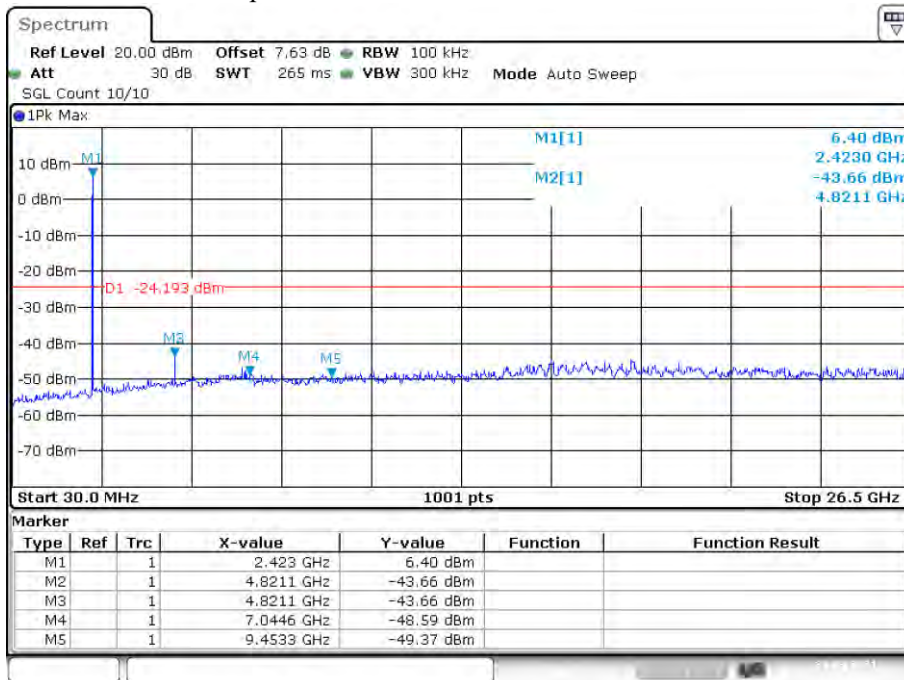

Date: 30.MAR.2021 13:17:32

Tx. Spurious NVNT b 2437MHz Ant1 Emission

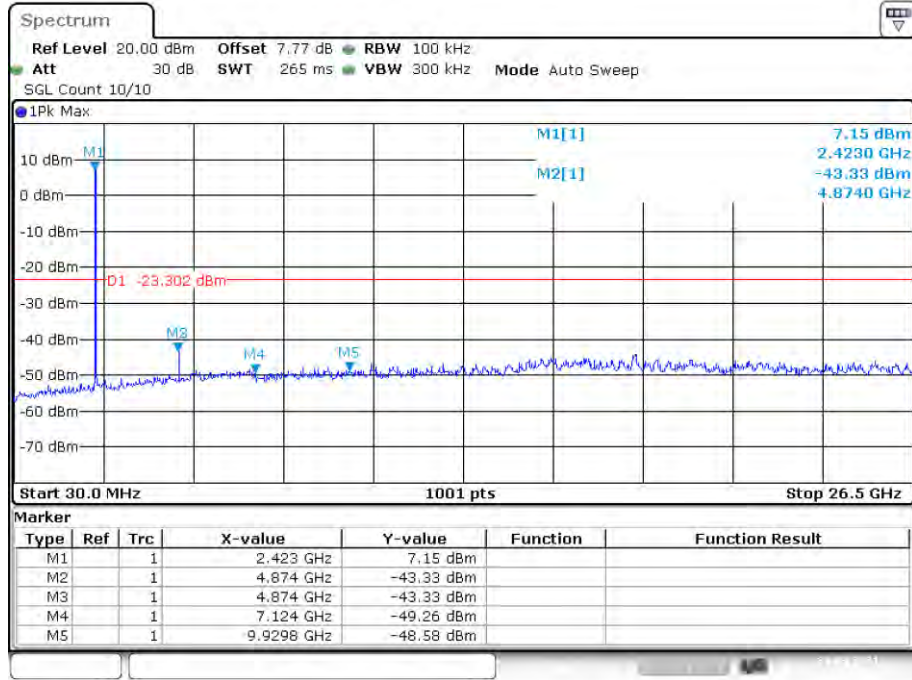

Date: 30.MAR.2021 14:09:36

Tx. Spurious NVNT b 2462MHz Ant1 Emission

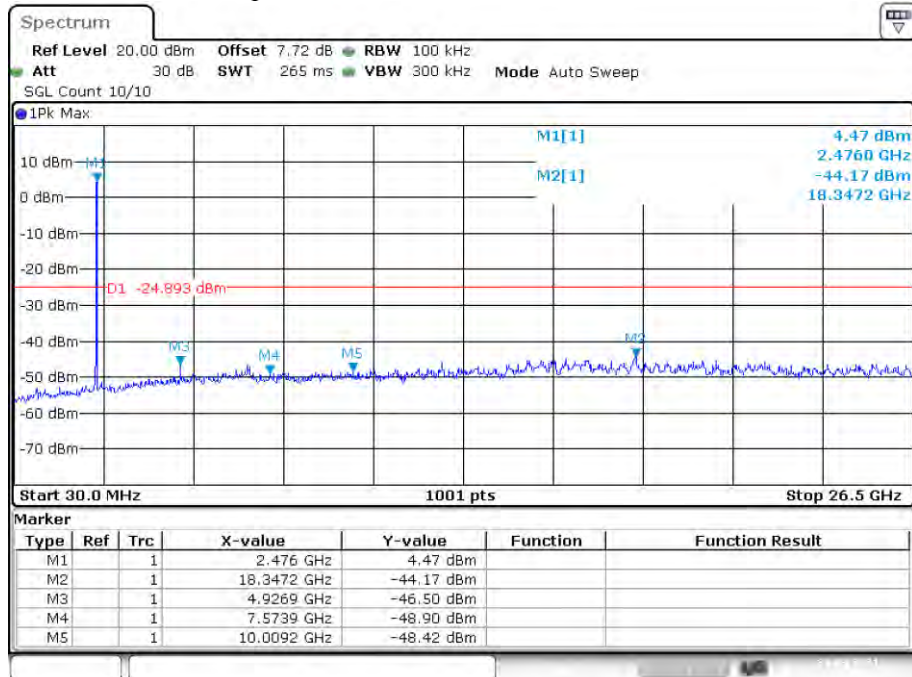

Date: 30.MAR.2021 14:49:04

Tx. Spurious NVNT g 2412MHz Ant1 Emission

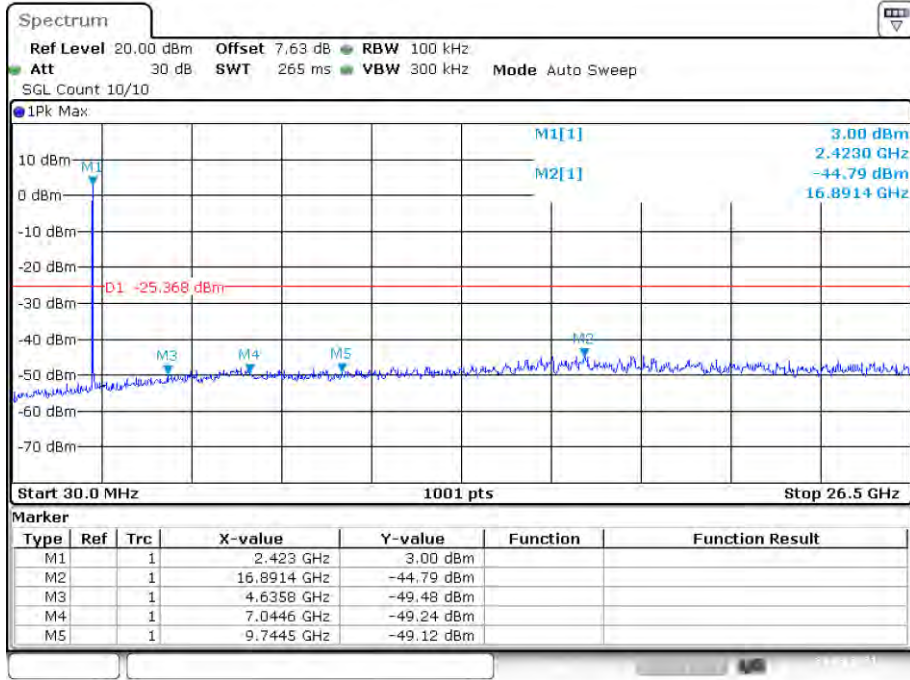

Date: 30.MAR.2021 14:53:47

Tx. Spurious NVNT g 2437MHz Ant1 Emission

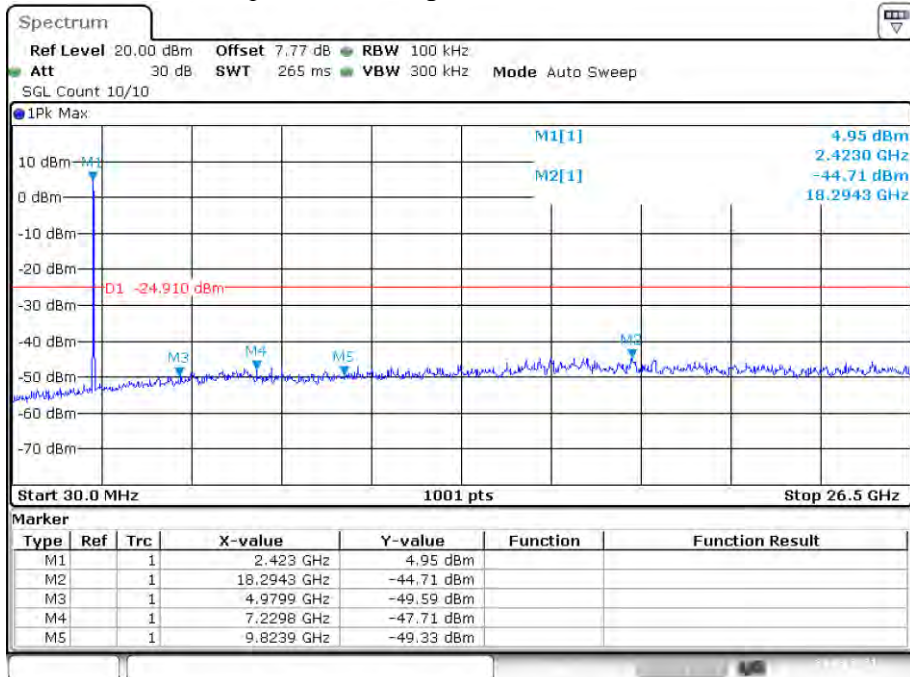

Date: 30.MAR.2021 14:57:17

Tx. Spurious NVNT g 2462MHz Ant1 Emission

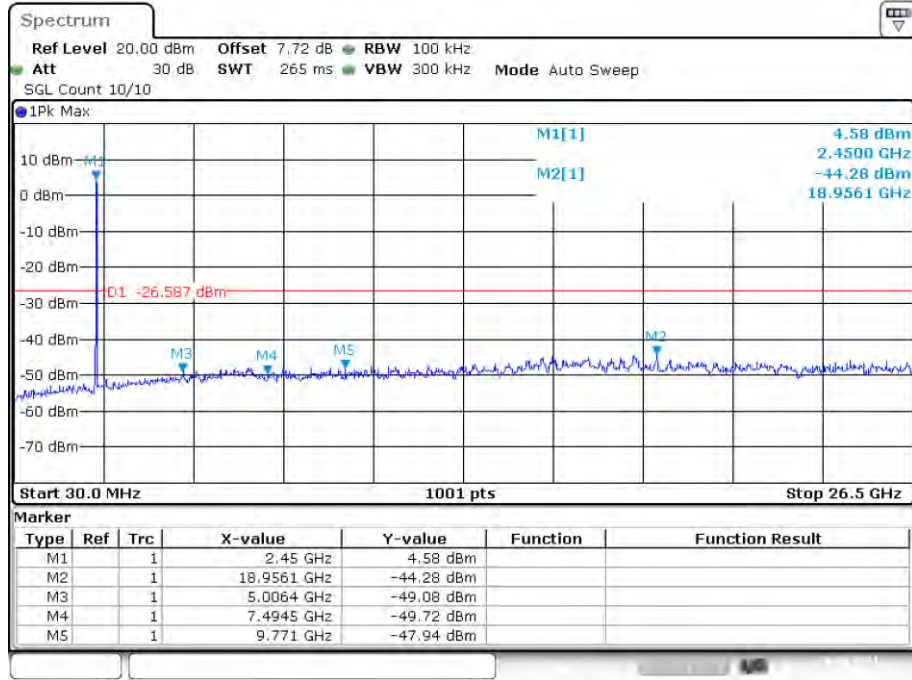

Date: 30.MAR.2021 15:07:52

Tx. Spurious NVNT n20 2412MHz MIMO Emission

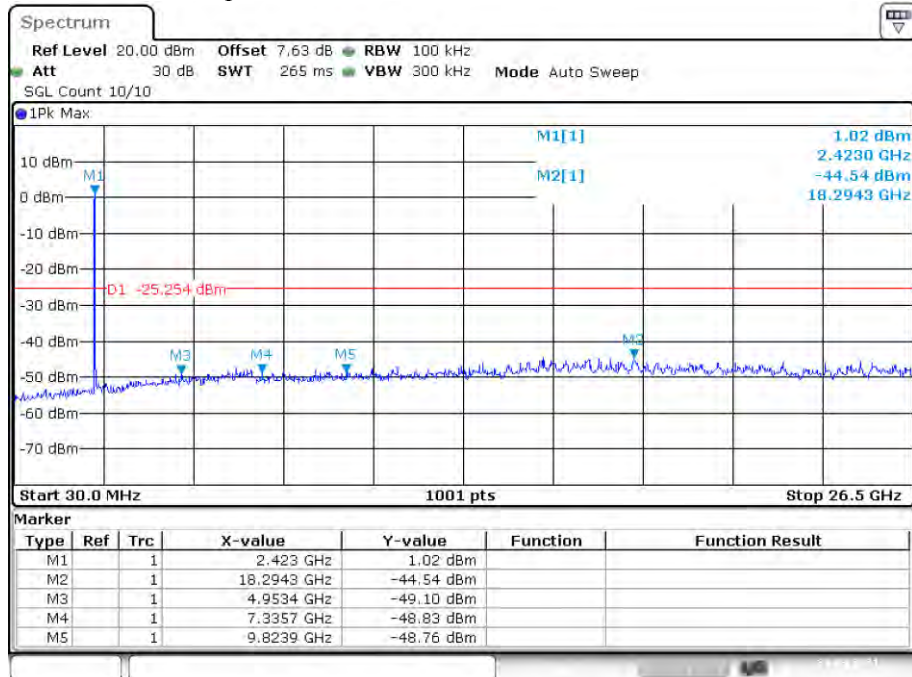

Date: 30.MAR.2021 15:24:51

Tx. Spurious NVNT n20 2437MHz MIMO Emission

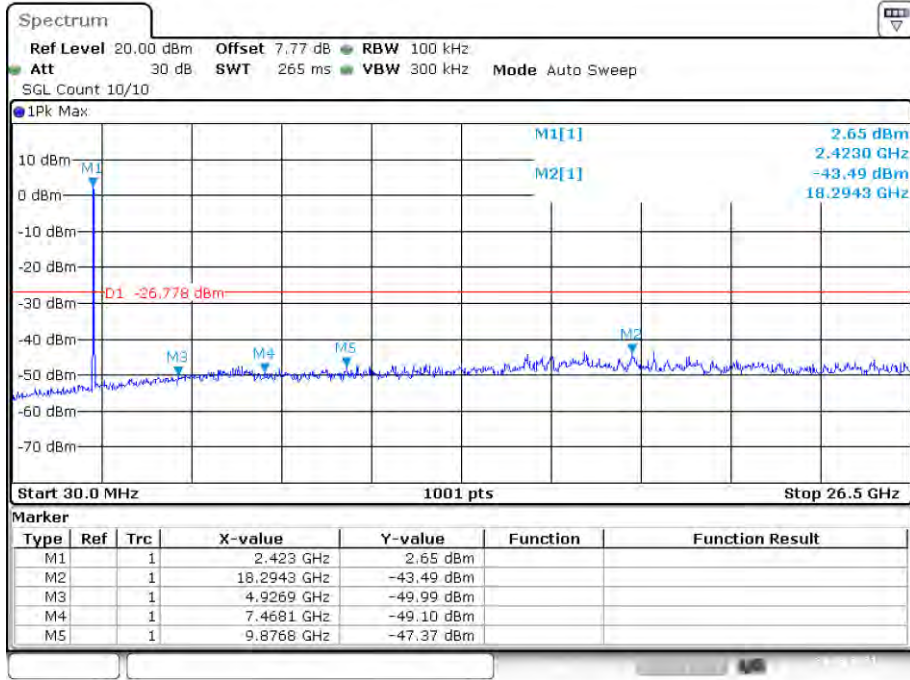

Date: 30.MAR.2021 15:27:43

Tx. Spurious NVNT n20 2462MHz MIMO Emission

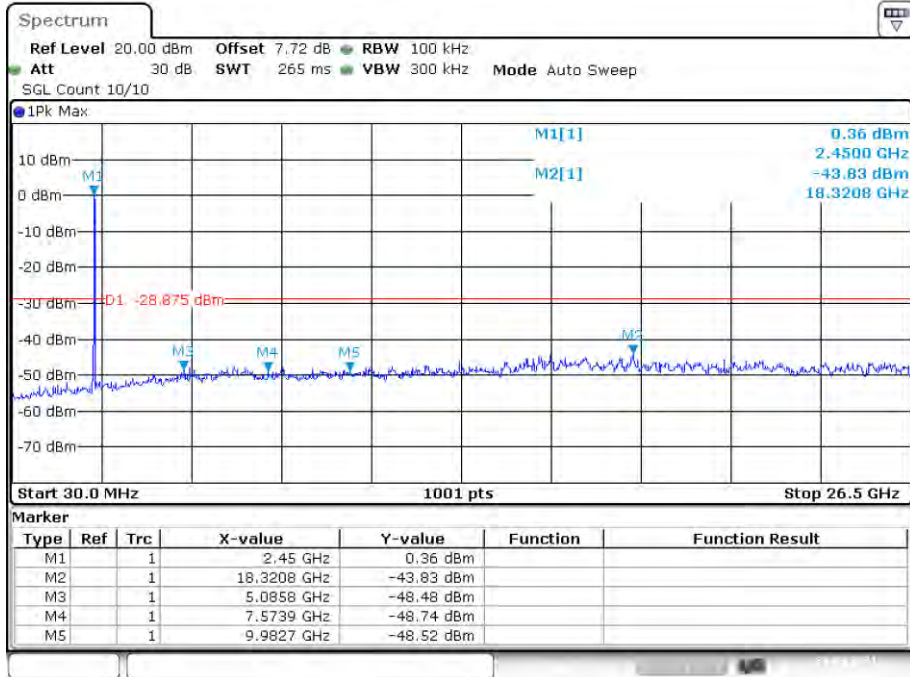

Date: 30.MAR.2021 15:33:32

Tx. Spurious NVNT n40 2422MHz MIMO Emission

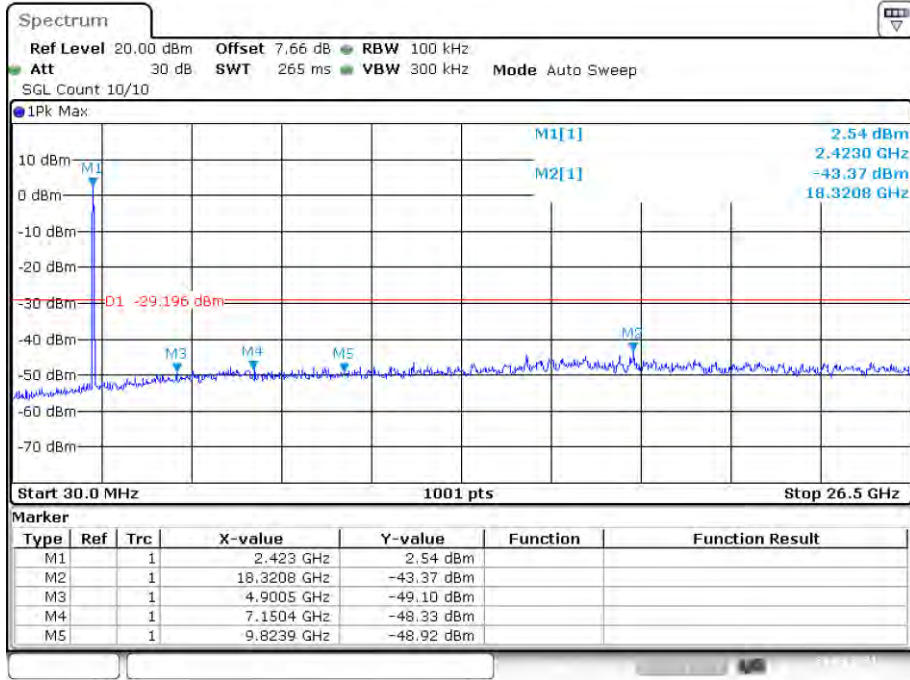

Date: 30.MAR.2021 15:39:28

Tx. Spurious NVNT n40 2437MHz MIMO Emission

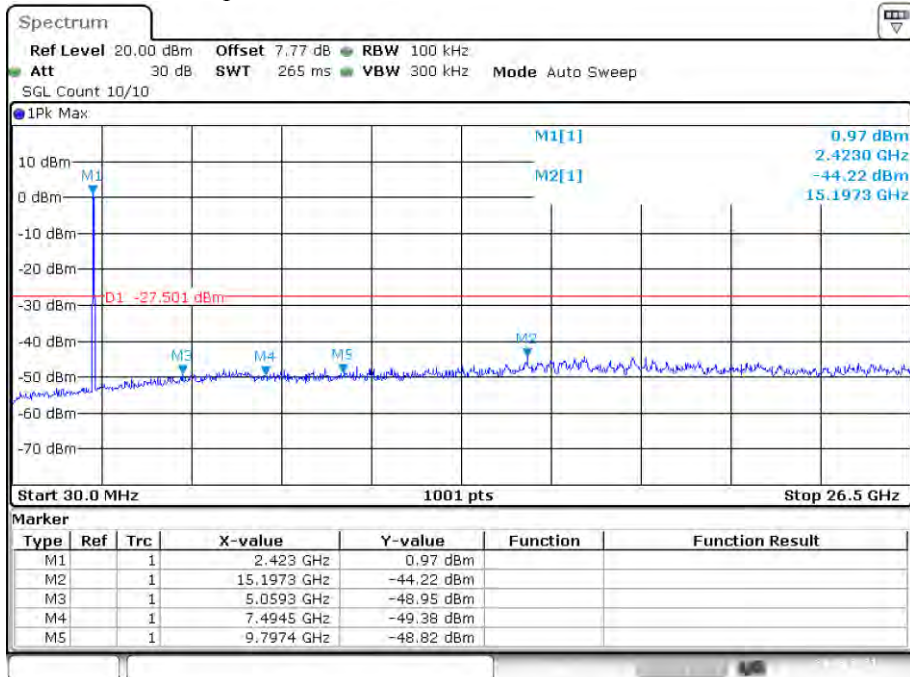

Date: 30.MAR.2021 15:45:16

Tx. Spurious NVNT n40 2452MHz MIMO Emission

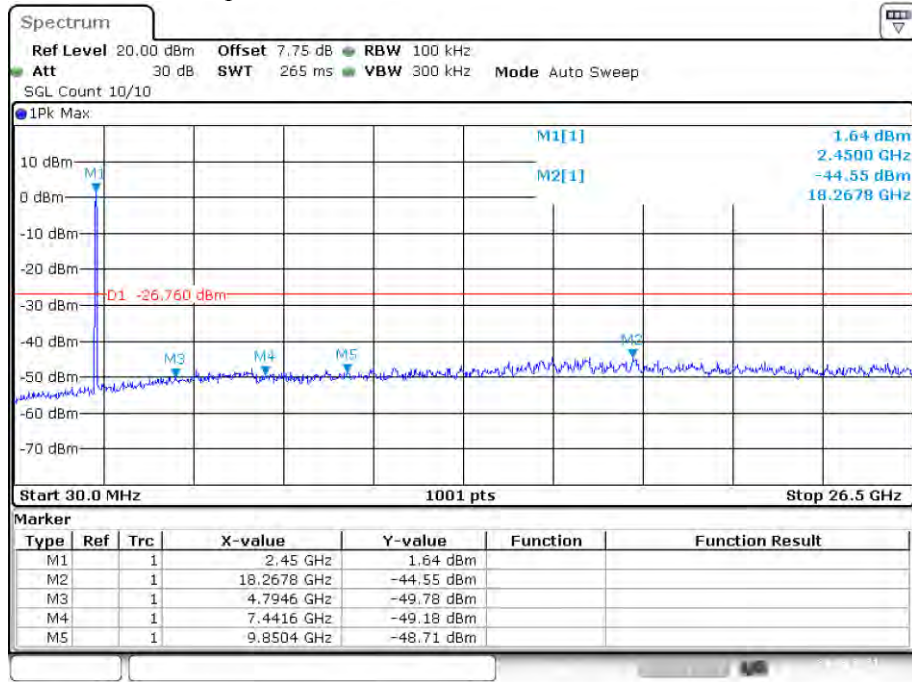

Date: 30.MAR.2021 15:48:44

Note: Note: All modes have been tested, and only the data graphs of Ant1 SISO and MIMO modes are reflected

4. POWER LINE CONDUCTED EMISSION

4.1. Test Limits

Frequency MHz	Limits dB(μ V)	
	Quasi-peak Level	Average Level
0.15 -0.50	66 -56*	56 - 46*
0.50 -5.00	56	46
5.00 -30.00	60	50

- Notes: 1. *Decreasing linearly with logarithm of frequency.
 2. The lower limit shall apply at the transition frequencies.
 3. The limit decreases in line with the logarithm of the frequency in the rang of 0.15 to 0.50 MHz.

4.2. Test Procedure

The EUT is put on the plane 0.8m high above the ground by insulating support and is connected to the power mains through a line impedance stabilization network (L.I.S.N.). This provides a 50ohm coupling impedance for the EUT system. Please refer the block diagram of the test setup and photographs. Both sides of AC lines are checked to find out the maximum conducted emission. In order to find the maximum emission levels, the relative positions of equipment and all of the interface cables shall be changed according to ANSI C63.10:2013 on Conducted Emission Measurement.

The bandwidth of test receiver is set at 9 kHz.

4.3. Test Setup

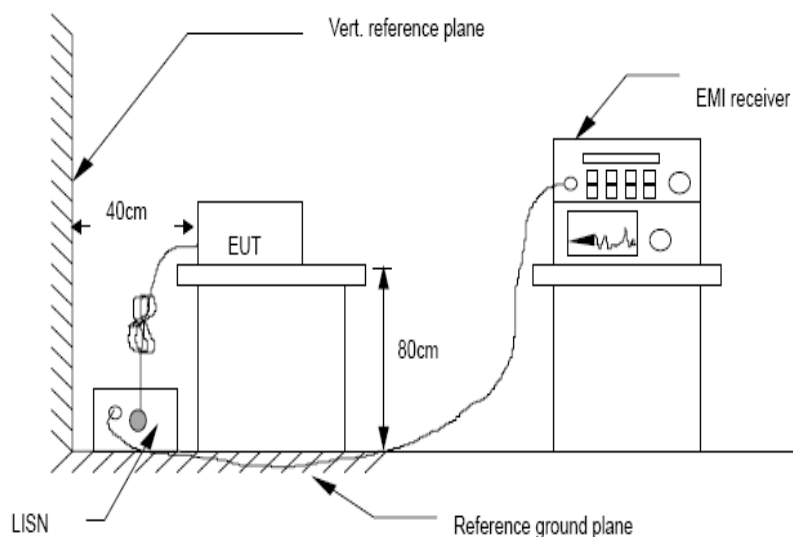

4.4. Test Results

Not applicable for equipment operated with battery power supply.

5. CONDUCTED MAXIMUM OUTPUT POWER

5.1. Test limits

Please refer RSS-247 & FCC PART 15: 15.247.

Regulation 15.247(b) The limit of Maximum Peak Output Power Measurement is 1W(30dBm)

5.2. Test Procedure

Details see the KDB558074 D01 Meas Guidance v05r02

5.2.1 Place the EUT on the table and set it in transmitting mode.

5.2.2 Connected the EUT's antenna port to peak power meter by 20dB attenuator.

5.2.3 Measure out each mode and each bands peak output power of EUT.

Note: The cable loss and attenuator loss were offset into measure device as amplitude offset.

5.3. Test Setup

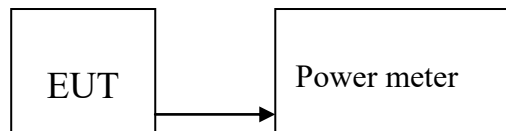

5.4. Test Results

PASS

Detailed information please see the following page.

Mode	Frequency (MHz)	PK Output power(dBm)			Limit (dBm)	Result
		ANT1	ANT2	MIMO		
IEEE 802.11 b	CH1: 2412	14.88	14.94	/	30	Pass
	CH6: 2437	16.51	16.50	/	30	Pass
	CH11: 2462	15.29	15.24	/	30	Pass
IEEE 802.11 g	CH1: 2412	15.00	14.99	/	30	Pass
	CH6: 2437	16.38	16.36	/	30	Pass
	CH11: 2462	15.35	15.41	/	30	Pass
IEEE 802.11 n/HT20	CH1: 2412	14.87	14.83	17.90	30	Pass
	CH6: 2437	16.29	16.24	19.25	30	Pass
	CH11: 2462	15.44	15.46	18.52	30	Pass
IEEE 802.11 n/HT40	CH3: 2422	15.75	15.78	18.71	30	Pass
	CH6: 2437	16.53	16.49	19.49	30	Pass
	CH9: 2452	16.62	16.71	19.59	30	Pass

6. PEAK POWER SPECTRAL DENSITY

6.1. Test limits

6.1.1 Please refer RSS-247 & FCC PART 15:15.247.

6.1.2 For direct sequence systems, the peak power spectral density conducted from the intentional radiator to the antenna shall not be greater than 8dBm in any 3kHz band during any time interval of continuous transmission.

6.1.3 The direct sequence operating of the hybrid system, with the frequency hopping operation turned off, shall comply with the power density requirements of paragraph (d) of this section.

6.2. Test Procedure

Details see the KDB558074 D01 Meas Guidance v05r02

6.2.1 Place the EUT on the table and set it in transmitting mode.

6.2.2 Remove the antenna from the EUT and then connect a low loss RF cable from the antenna port to the spectrum analyzer.

6.2.3 Set the spectrum analyzer as $RBW = 3\text{kHz}$ (Set the RBW to: $3\text{ kHz} \leq RBW \leq 100\text{ kHz}$.), $VBW = 10\text{kHz}$ (Set the $VBW \geq 3 \times RBW$), $span \geq 1.5 \times DTS$ bandwidth., detail see the test plot.

6.2.4 Record the max reading.

6.2.5 Repeat the above procedure until the measurements for all frequencies are completed.

6.3. Test Setup

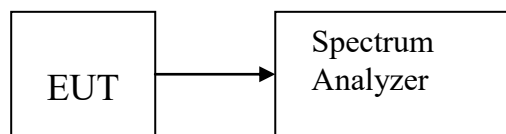

6.4. Test Results

Mode	Frequency (MHz)	Max PSD (dBm/3kHz)			Limit (dBm/3kHz)	Verdict
		Ant 1	Ant 2	MIMO		
802.11b	2412	2.294	2.27	/	8	Pass
802.11b	2437	2.348	2.42	/	8	Pass
802.11b	2462	0.625	0.67	/	8	Pass
802.11g	2412	-1.633	-1.59	/	8	Pass
802.11g	2437	-0.894	-0.90	/	8	Pass
802.11g	2462	-2.196	-2.15	/	8	Pass
802.11 n20	2412	-1.554	-1.48	1.52	8	Pass
802.11 n20	2437	-0.883	-0.81	2.19	8	Pass
802.11 n20	2462	-2.551	-2.51	0.49	8	Pass
802.11 n40	2422	-4.039	-3.96	-0.96	8	Pass
802.11 n40	2437	-4.34	-4.35	-1.35	8	Pass
802.11 n40	2452	-1.461	-1.40	1.60	8	Pass

PSD NVNT b 2412MHz Ant1

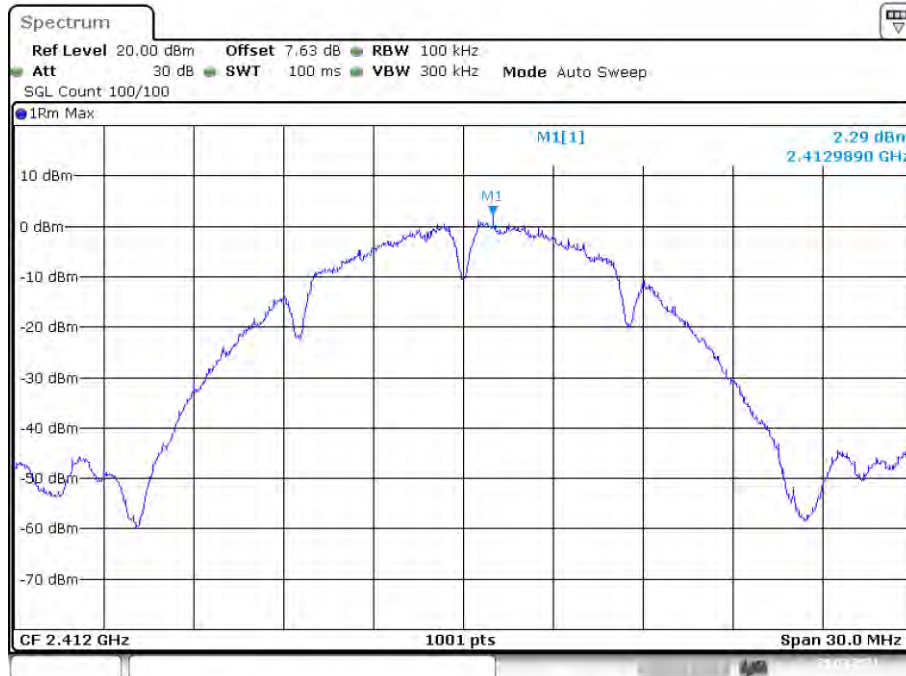

Date: 30-MAR-2021 13:16:53

PSD NVNT b 2437MHz Ant1



Date: 30.MAR.2021 14:09:09

PSD NVNT b 2462MHz Ant1

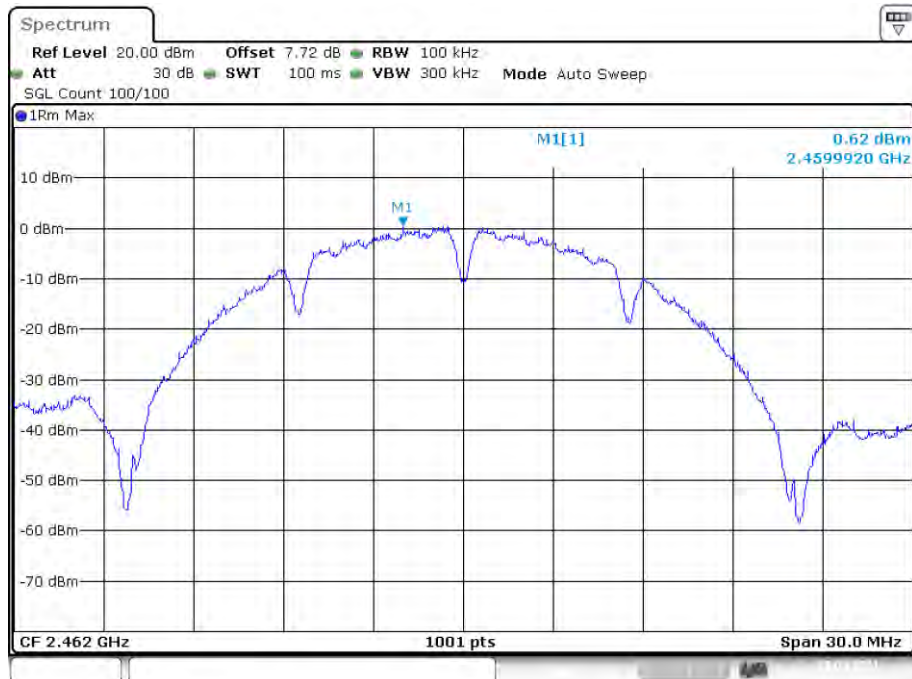

Date: 30.MAR.2021 14:48:22

PSD NVNT g 2412MHz Ant1

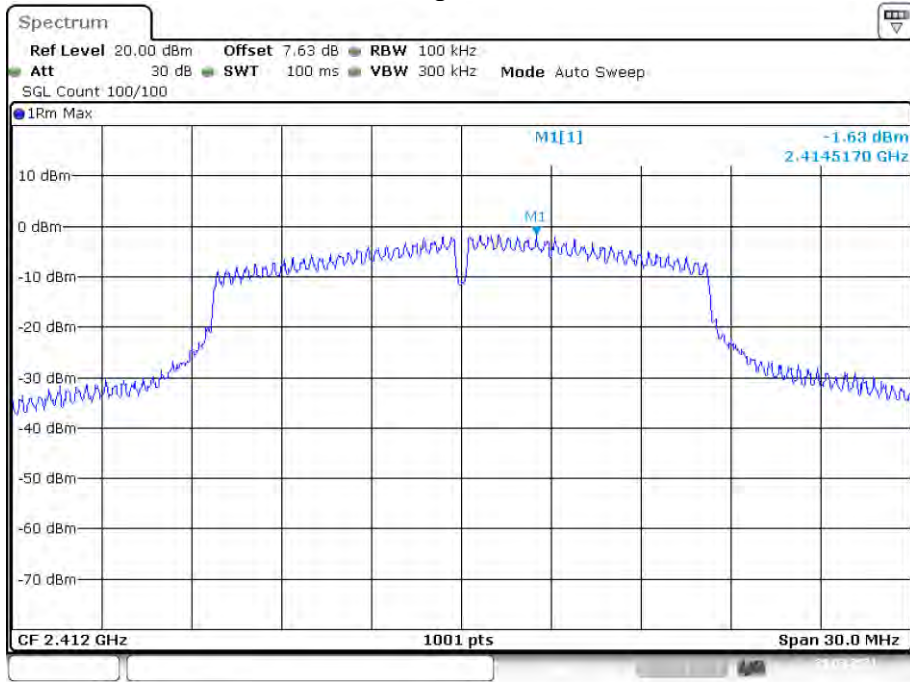

Date: 30.MAR.2021 14:53:04

PSD NVNT g 2437MHz Ant1

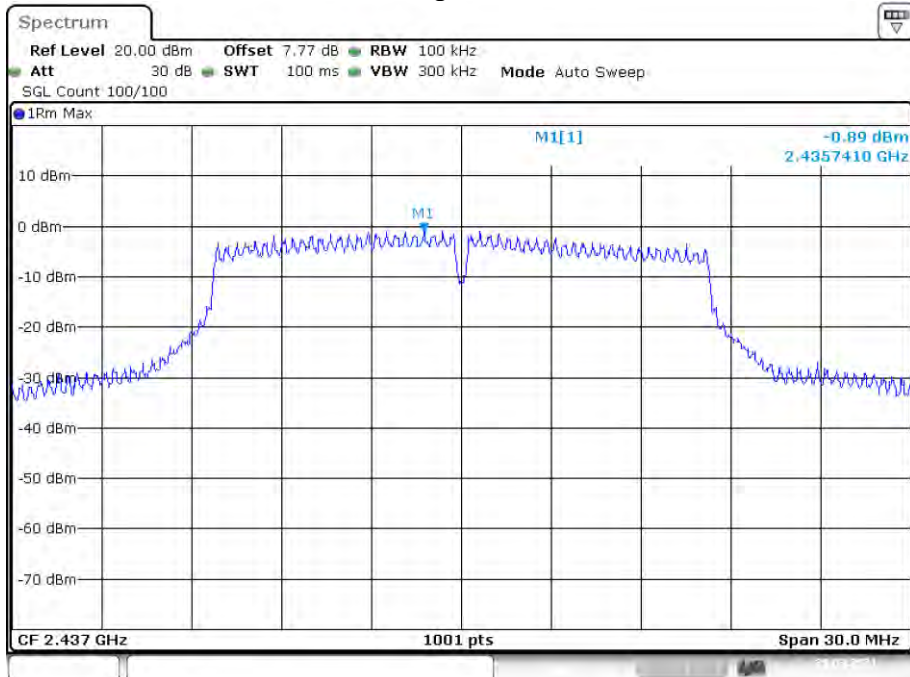

Date: 30.MAR.2021 14:56:48

PSD NVNT g 2462MHz Ant1

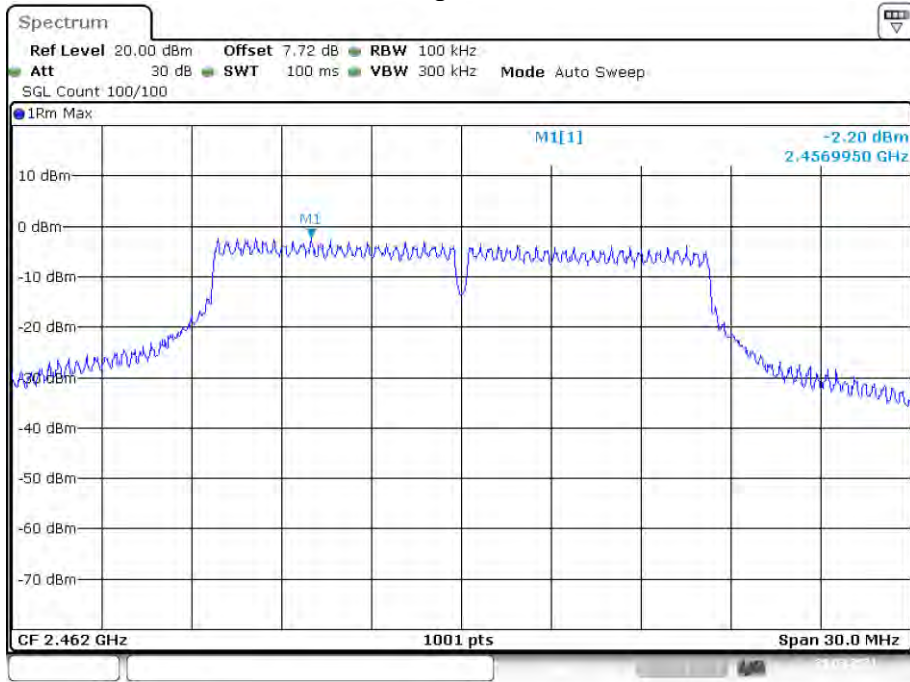

Date: 30.MAR.2021 15:07:05

PSD NVNT n20 2412MHz Ant1

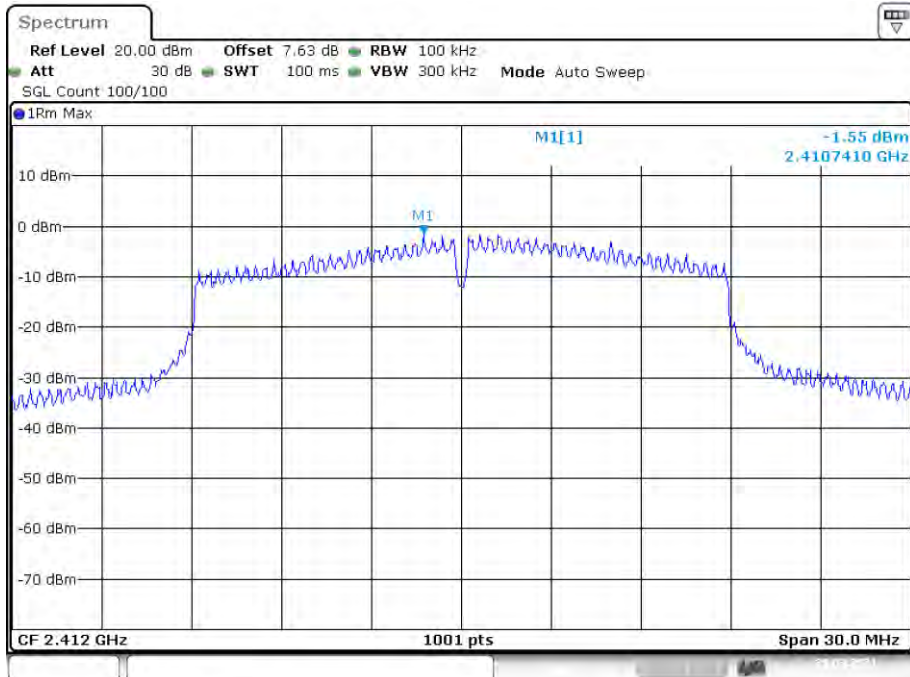

Date: 30.MAR.2021 15:24:03

PSD NVNT n20 2437MHz Ant1

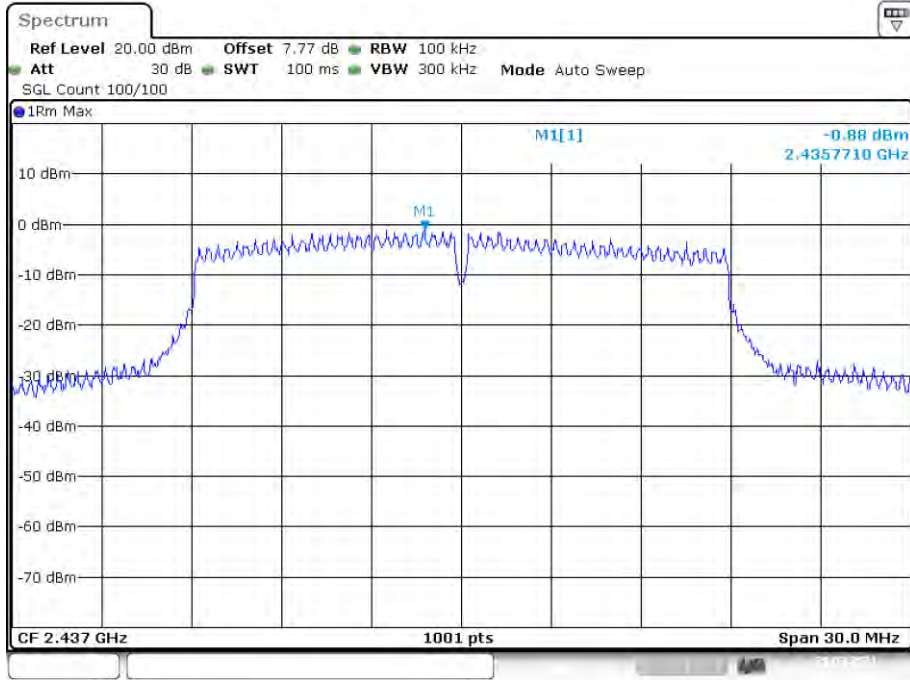

Date: 30.MAR.2021 15:27:12

PSD NVNT n20 2462MHz Ant1

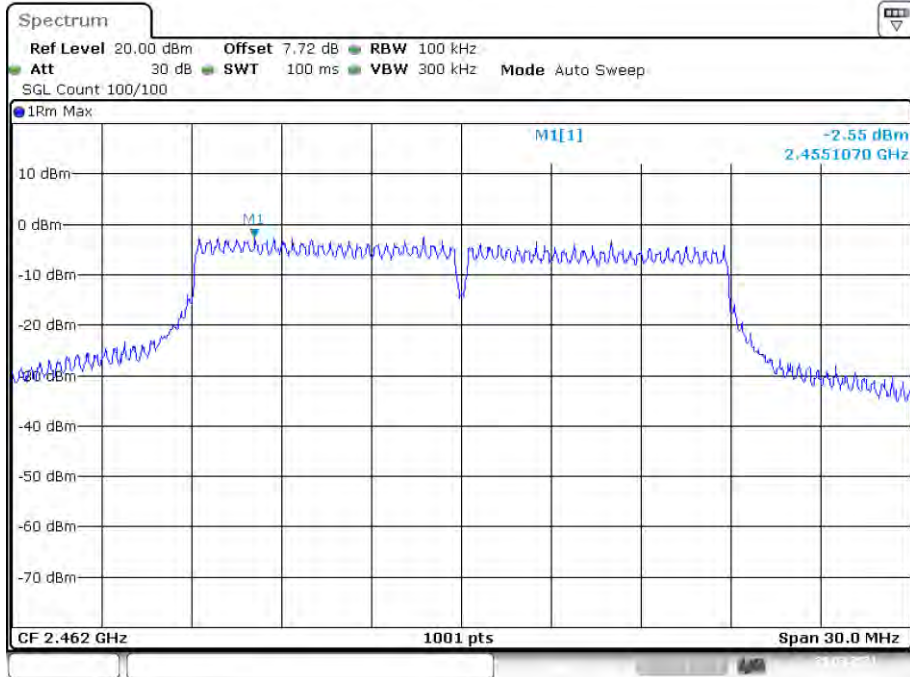

Date: 30.MAR.2021 15:32:40

PSD NVNT n40 2422MHz Ant1

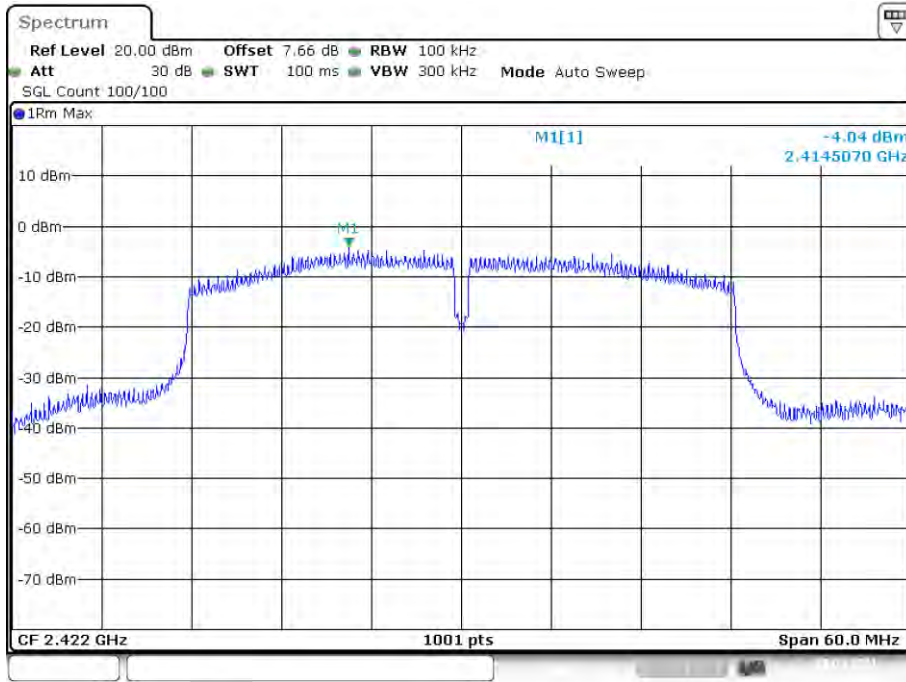

Date: 30.MAR.2021 15:38:34

PSD NVNT n40 2437MHz Ant1

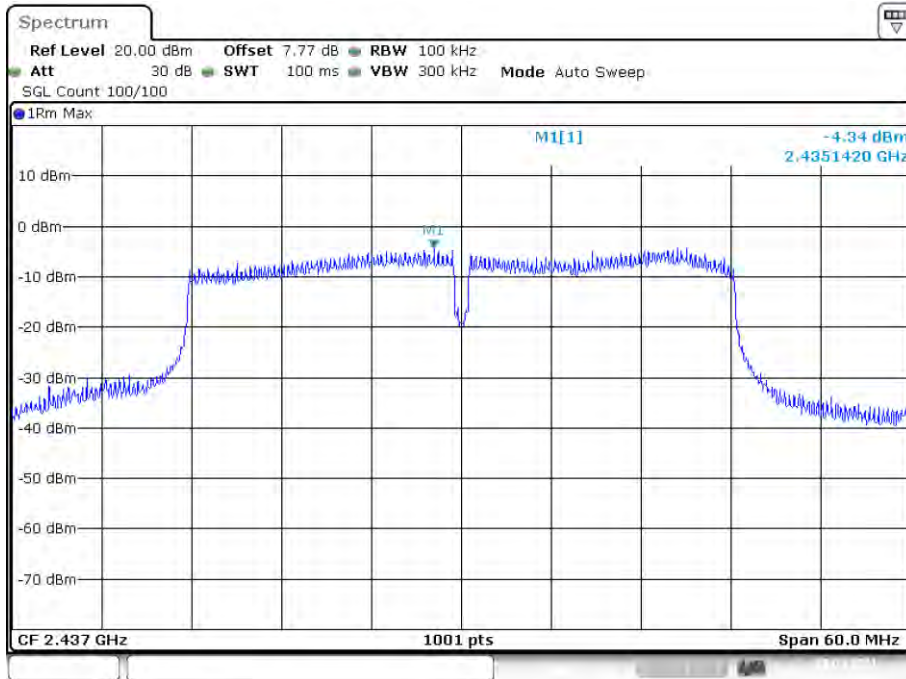

Date: 30.MAR.2021 15:44:39

PSD NVNT n40 2452MHz Ant1

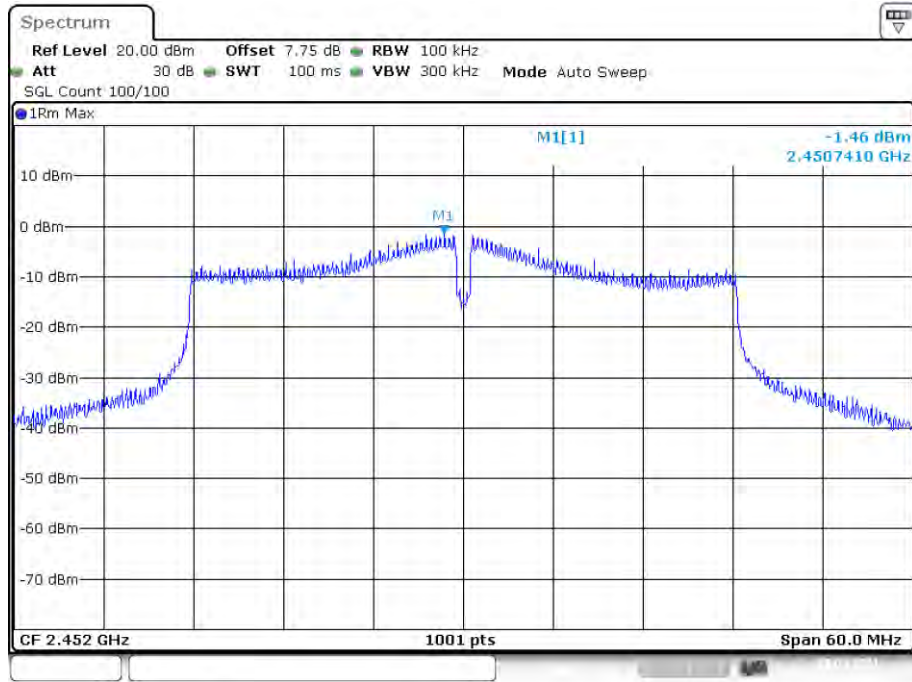

Date: 30.MAR.2021 15:47:46

Note: All modes have been tested, and only the data graphs of Ant1 SISO and MIMO modes are reflected

7. BANDWIDTH

7.1. Test limits

Please refer RSS-247 & FCC PART 15: 15.247

For direct sequence systems, the minimum 6dB bandwidth shall be at least 500 kHz.

7.2. Test Procedure

Details see the KDB558074 D01 Meas Guidance v05r02

- a) The bandwidth is measured at an amplitude level reduced 6dB from the reference level. The reference level is the level of the highest amplitude signal observed from the transmitter at the fundamental frequency. Once the reference level is established, the equipment is conditioned with typical modulating signal to produce the worst-case (i.e. the widest) bandwidth.
- b) The test receiver set RBW = 100kHz, VBW $\geq 3 * RBW = 300kHz$., Peak Detector, Sweep time set auto, detail see the test plot.

7.3. Test Setup

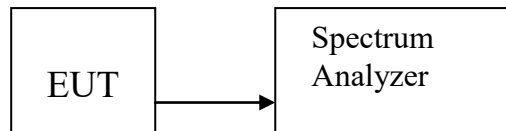

7.4. Test Results

-6dB Bandwidth

Condition	Mode	Frequency (MHz)	Antenna	-6 dB Bandwidth (MHz)	Limit -6 dB Bandwidth (MHz)	Verdict
NVNT	b	2412	Ant1	8.07	0.5	Pass
NVNT	b	2437	Ant1	8.07	0.5	Pass
NVNT	b	2462	Ant1	9.09	0.5	Pass
NVNT	g	2412	Ant1	14.46	0.5	Pass
NVNT	g	2437	Ant1	16.41	0.5	Pass
NVNT	g	2462	Ant1	16.47	0.5	Pass
NVNT	n20	2412	Ant1	12.57	0.5	Pass
NVNT	n20	2437	Ant1	15.45	0.5	Pass
NVNT	n20	2462	Ant1	17.79	0.5	Pass
NVNT	n40	2422	Ant1	24.72	0.5	Pass
NVNT	n40	2437	Ant1	35.04	0.5	Pass
NVNT	n40	2452	Ant1	18.18	0.5	Pass

-6dB Bandwidth NVNT b 2412MHz Ant1

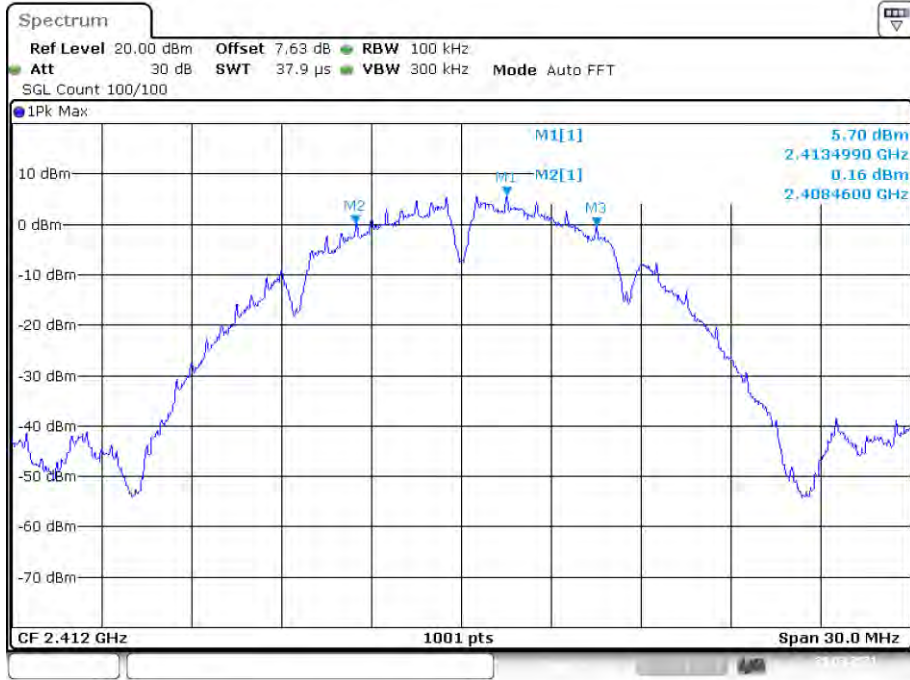

Date: 30.MAR.2021 13:16:33

-6dB Bandwidth NVNT b 2437MHz Ant1

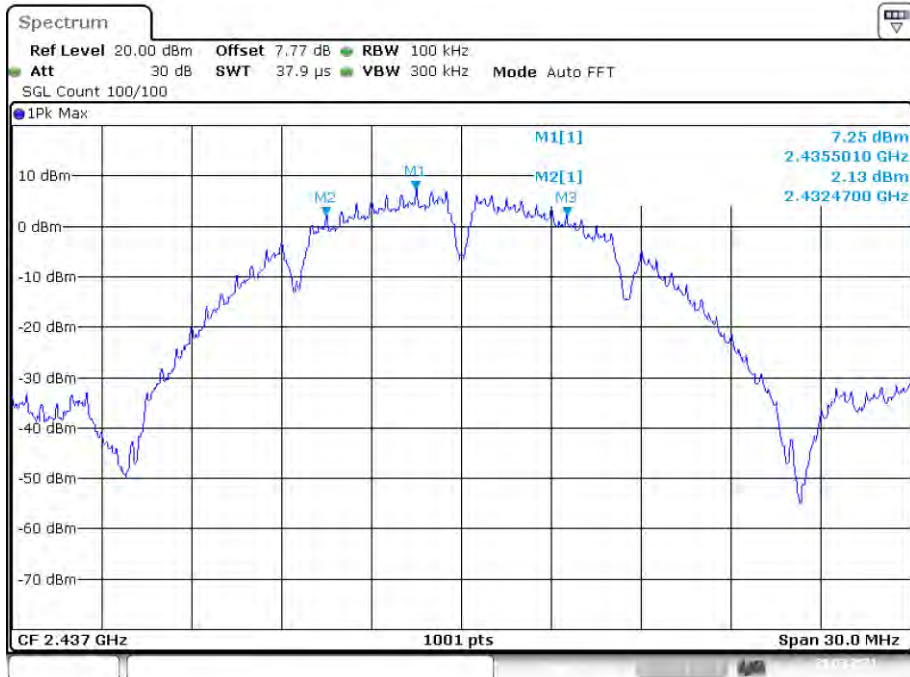

Date: 30.MAR.2021 14:08:47

-6dB Bandwidth NVNT b 2462MHz Ant1

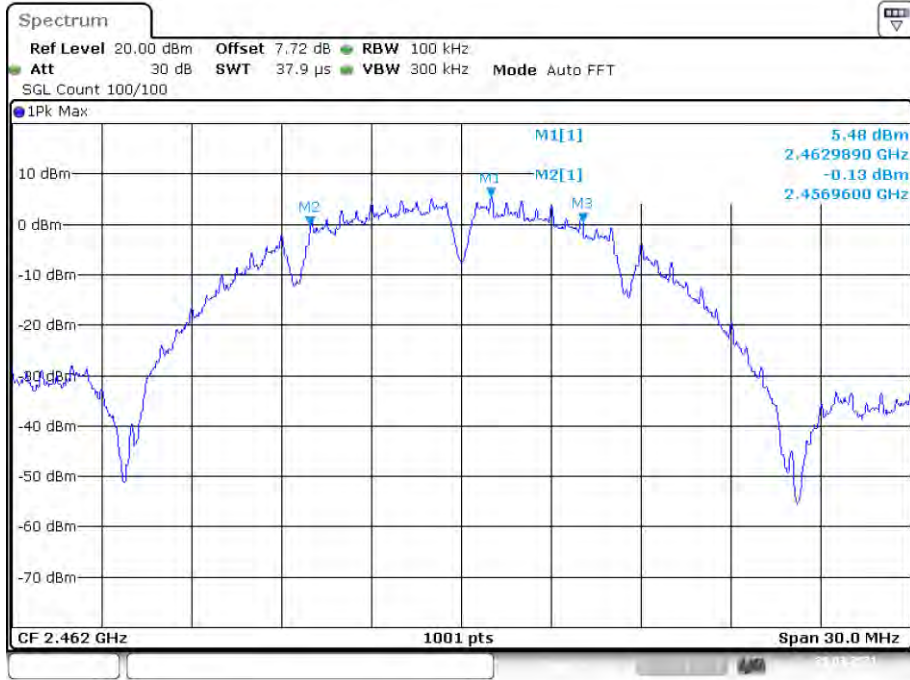

Date: 30.MAR.2021 14:48:01

-6dB Bandwidth NVNT g 2412MHz Ant1

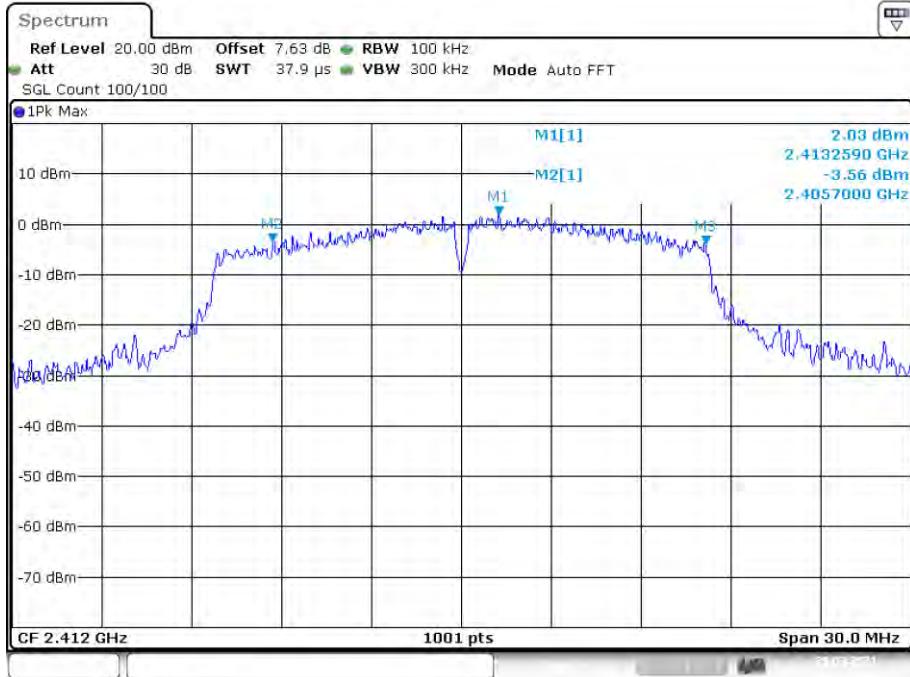

Date: 30.MAR.2021 14:52:40

-6dB Bandwidth NVNT g 2437MHz Ant1

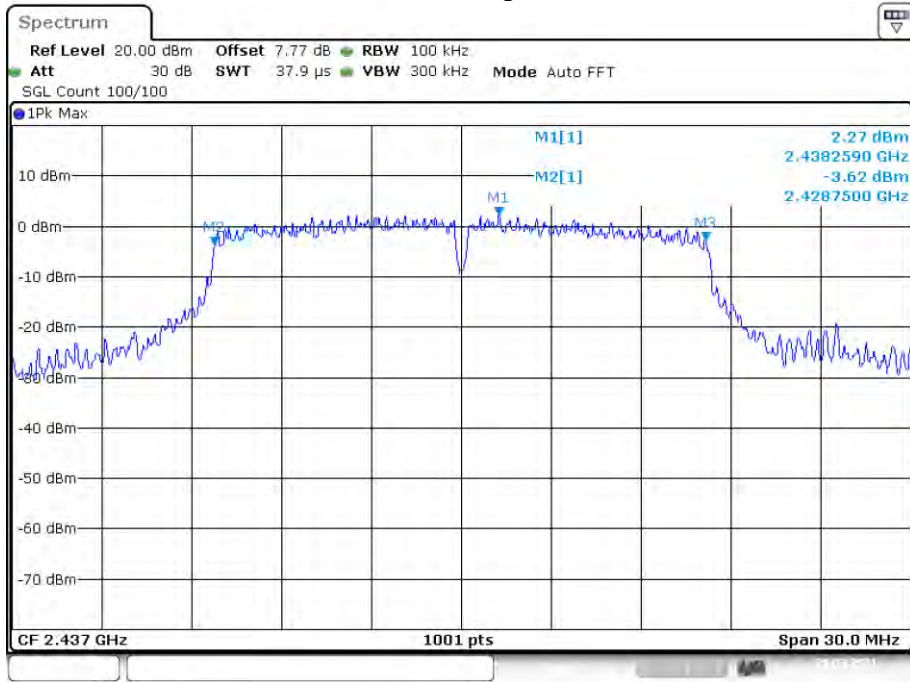

Date: 30.MAR.2021 14:56:23

-6dB Bandwidth NVNT g 2462MHz Ant1

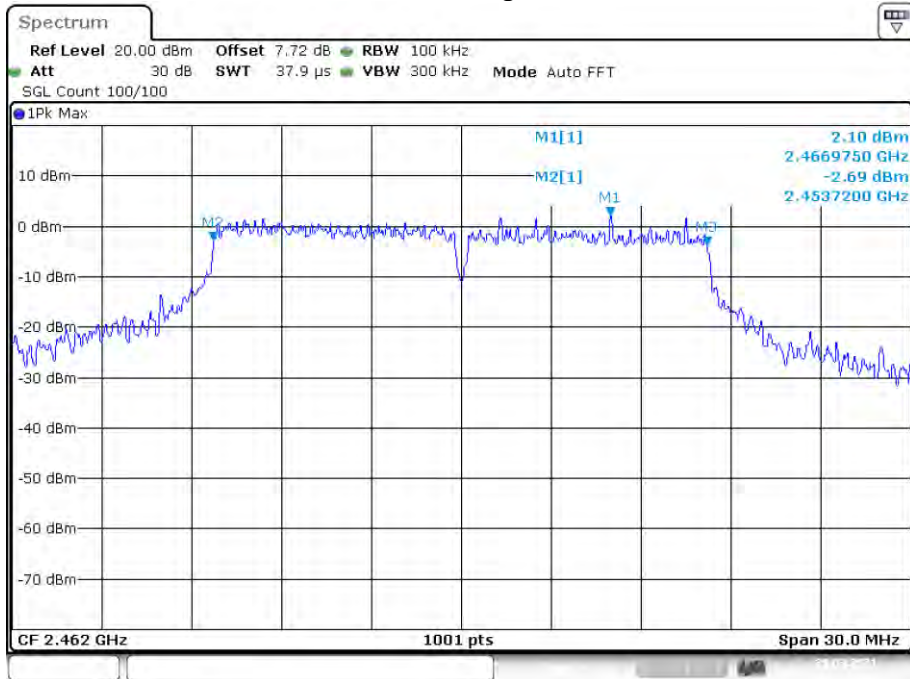

Date: 30.MAR.2021 15:06:41

-6dB Bandwidth NVNT n20 2412MHz Ant1

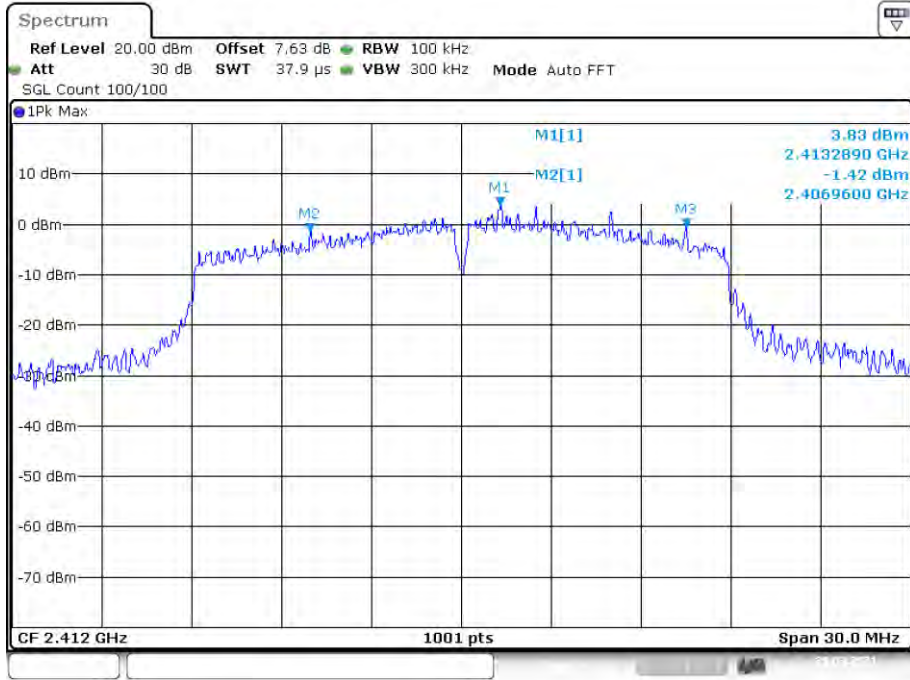

Date: 30.MAR.2021 15:23:37

-6dB Bandwidth NVNT n20 2437MHz Ant1

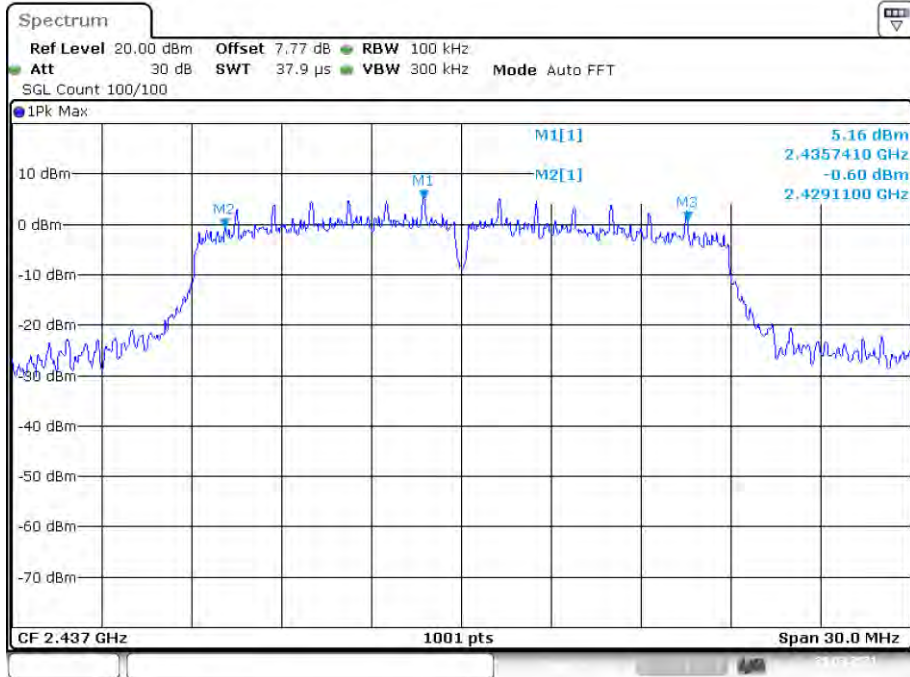

Date: 30.MAR.2021 15:26:45

-6dB Bandwidth NVNT n20 2462MHz Ant1

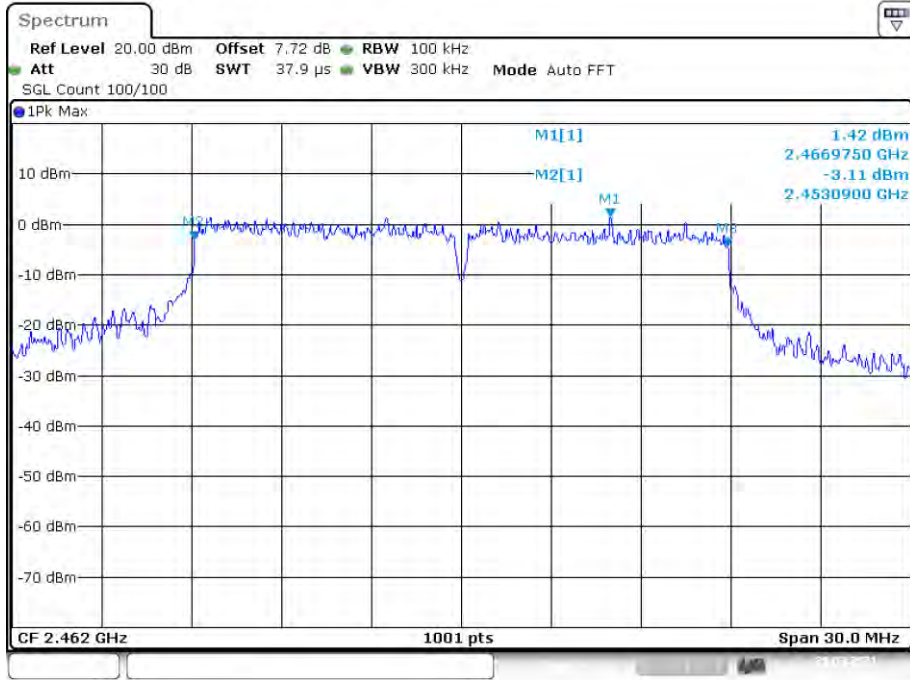

-6dB Bandwidth NVNT n40 2422MHz Ant1

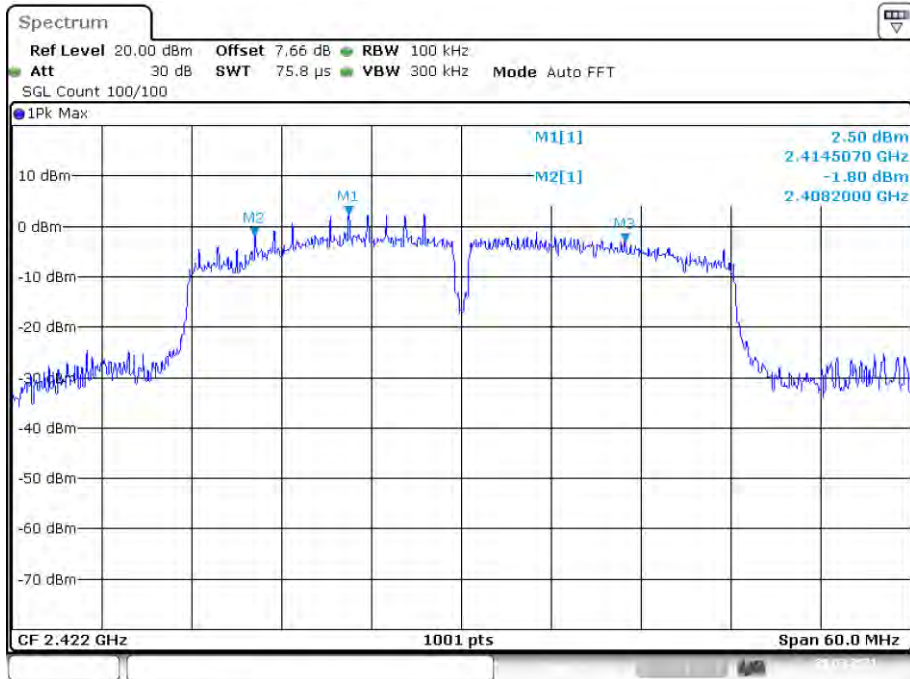

-6dB Bandwidth NVNT n40 2437MHz Ant1

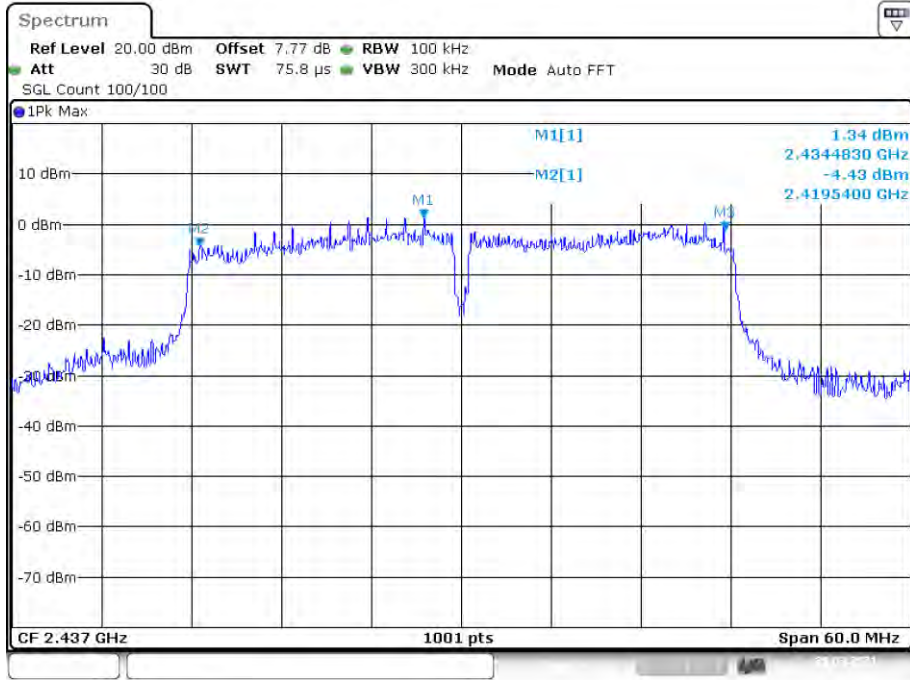

Date: 30.MAR.2021 15:44:10

-6dB Bandwidth NVNT n40 2452MHz Ant1

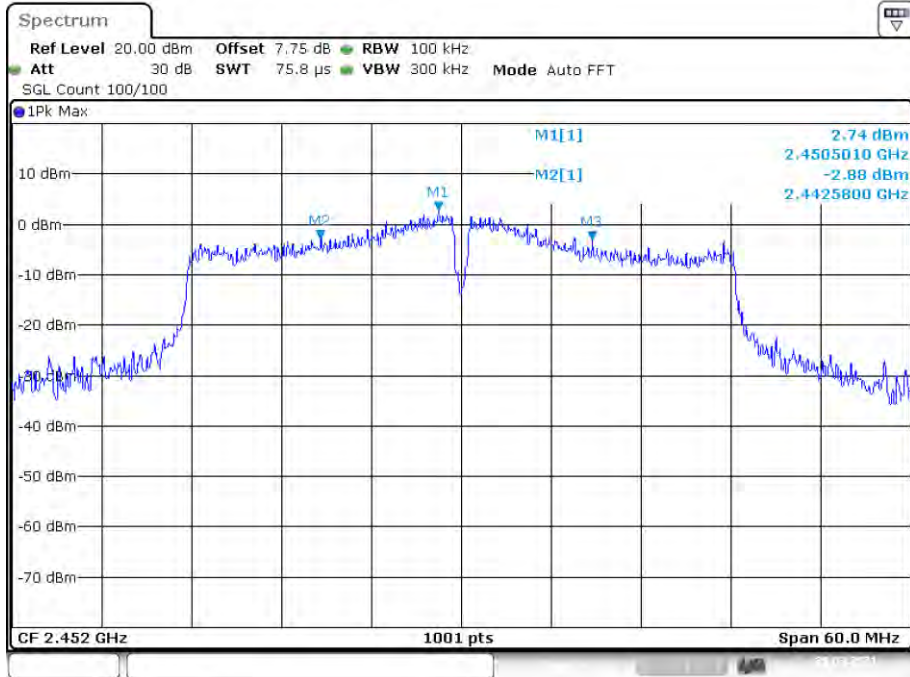

Date: 30.MAR.2021 15:47:19

Occupied Channel Bandwidth

Condition	Mode	Frequency (MHz)	Antenna	99% OBW (MHz)
NVNT	b	2412	Ant1	12.587
NVNT	b	2437	Ant1	13.516
NVNT	b	2462	Ant1	14.565
NVNT	g	2412	Ant1	16.484
NVNT	g	2437	Ant1	16.633
NVNT	g	2462	Ant1	17.353
NVNT	n20	2412	Ant1	17.532
NVNT	n20	2437	Ant1	17.682
NVNT	n20	2462	Ant1	18.342
NVNT	n40	2422	Ant1	35.784
NVNT	n40	2437	Ant1	36.204
NVNT	n40	2452	Ant1	36.144

OBW NVNT b 2412MHz Ant1

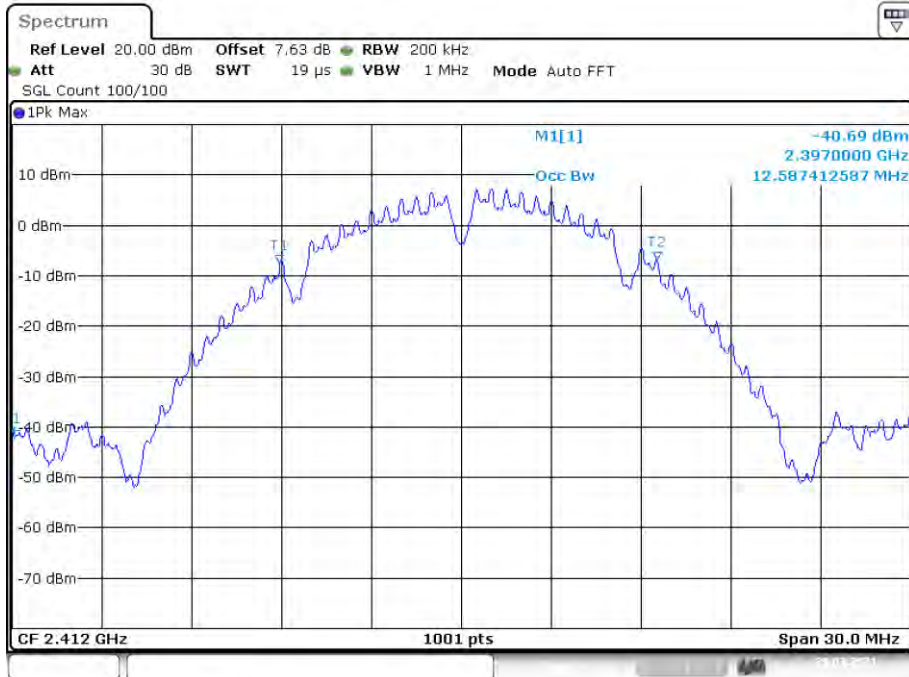

Date: 30.MAR.2021 13:16:25

OBW NVNT b 2437MHz Ant1

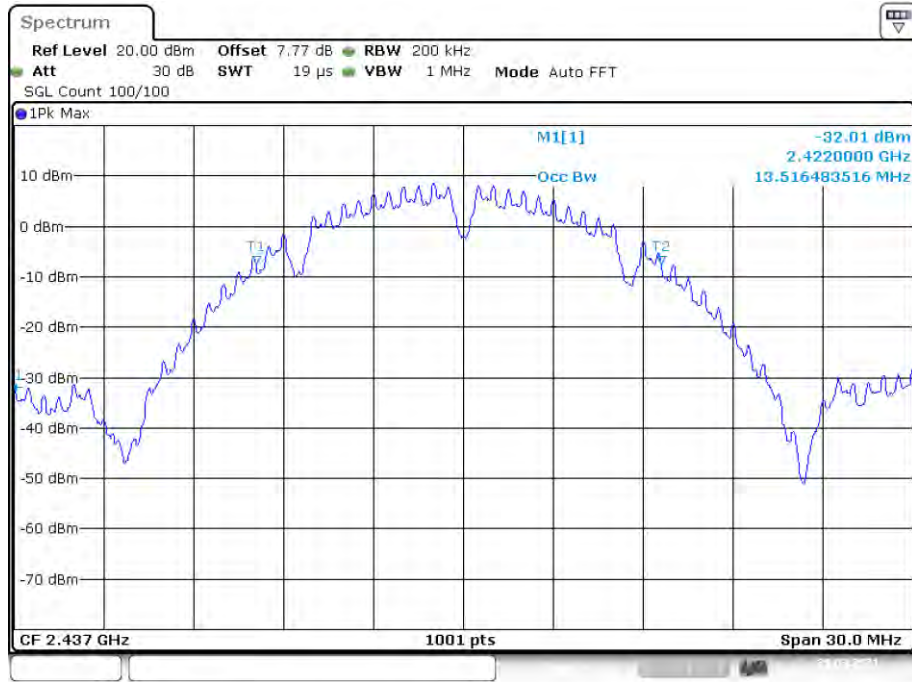

Date: 30.MAR.2021 14:08:38

OBW NVNT b 2462MHz Ant1



Date: 30.MAR.2021 14:47:51

OBW NVNT g 2412MHz Ant1

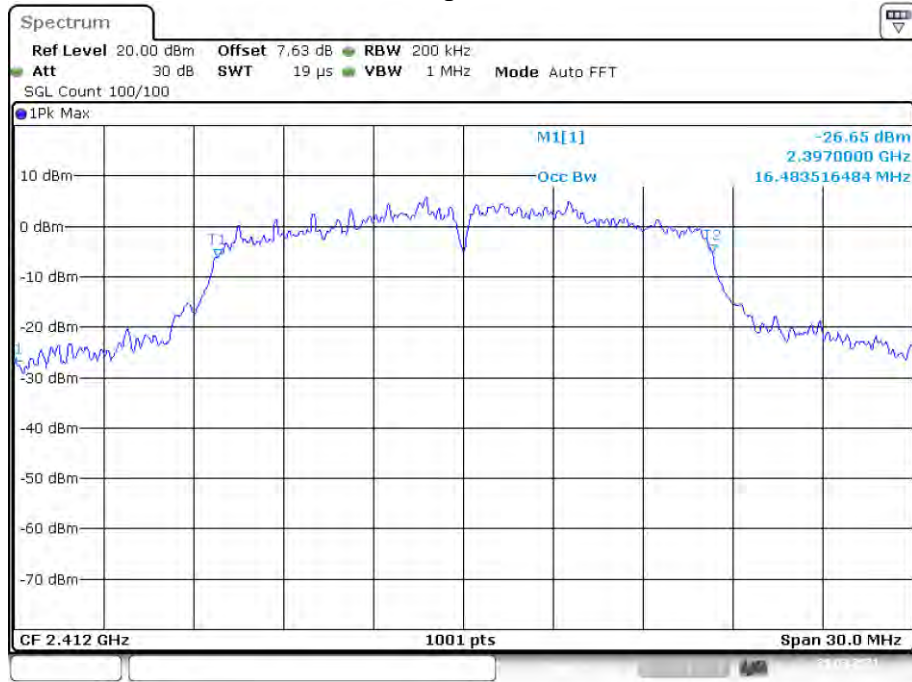

Date: 30.MAR.2021 14:52:29

OBW NVNT g 2437MHz Ant1



Date: 30.MAR.2021 14:56:12

OBW NVNT g 2462MHz Ant1



Date: 30.MAR.2021 15:06:29

OBW NVNT n20 2412MHz Ant1

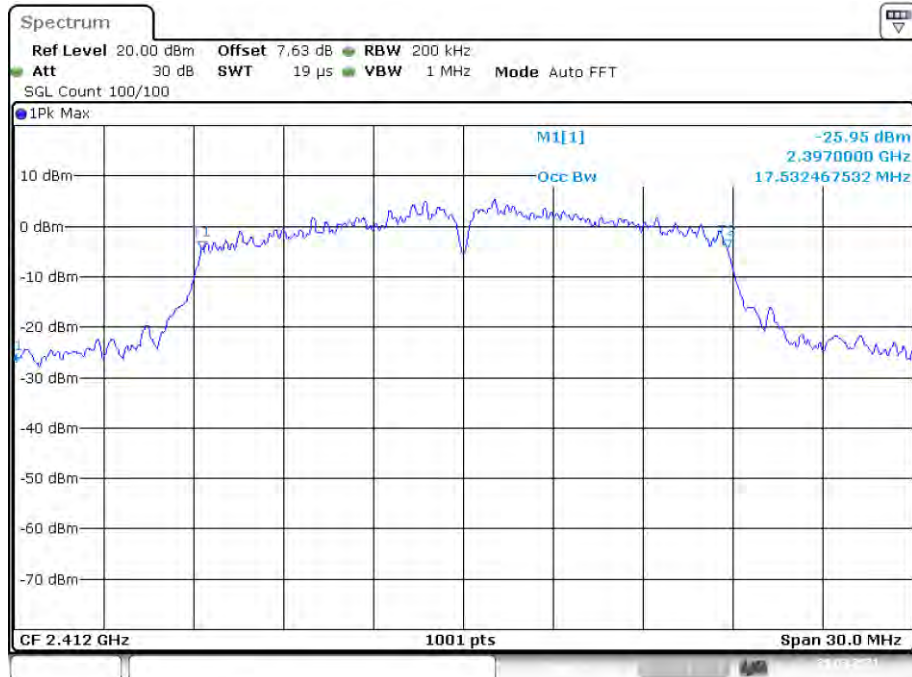

Date: 30.MAR.2021 15:23:24

OBW NVNT n20 2437MHz Ant1

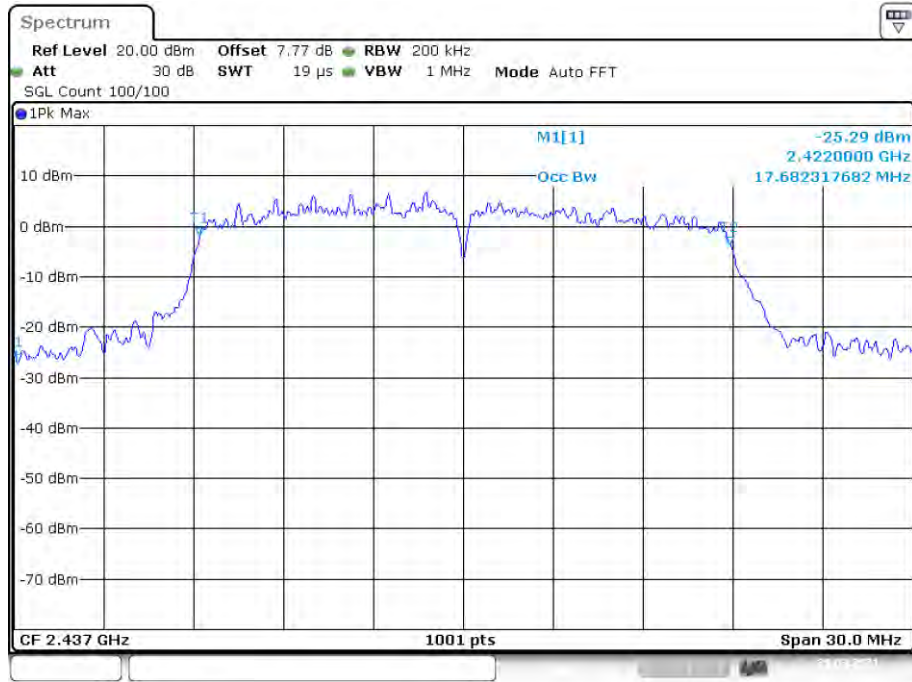

Date: 30.MAR.2021 15:26:31

OBW NVNT n20 2462MHz Ant1

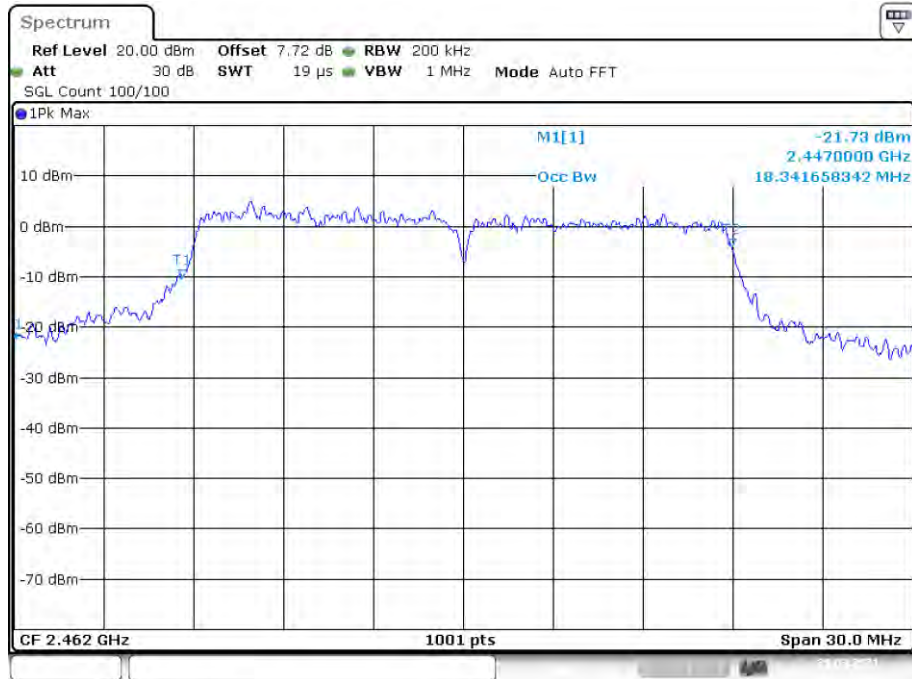

Date: 30.MAR.2021 15:32:00

OBW NVNT n40 2422MHz Ant1

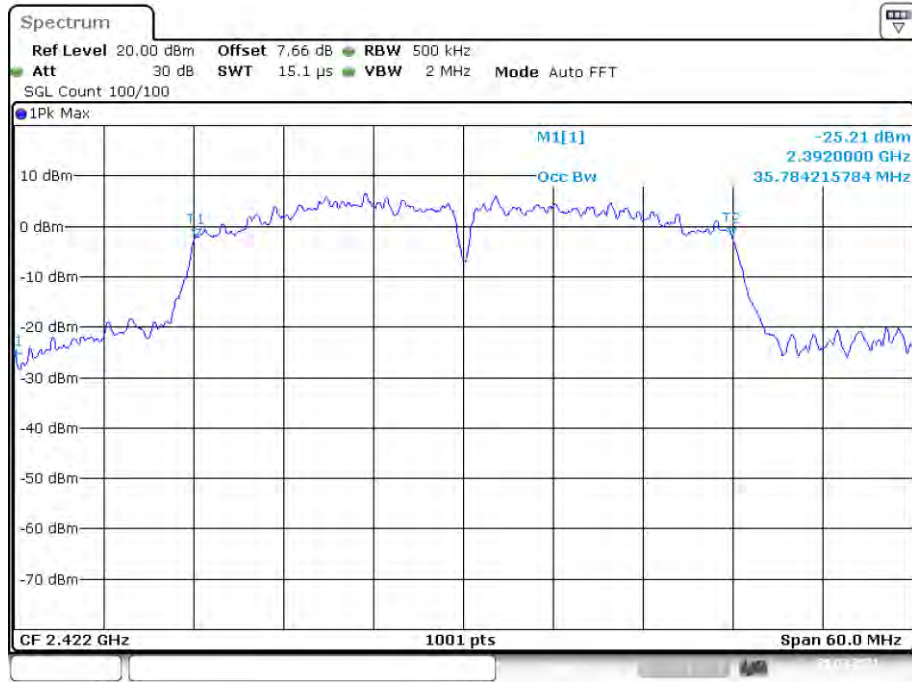

Date: 30.MAR.2021 15:37:53

OBW NVNT n40 2437MHz Ant1

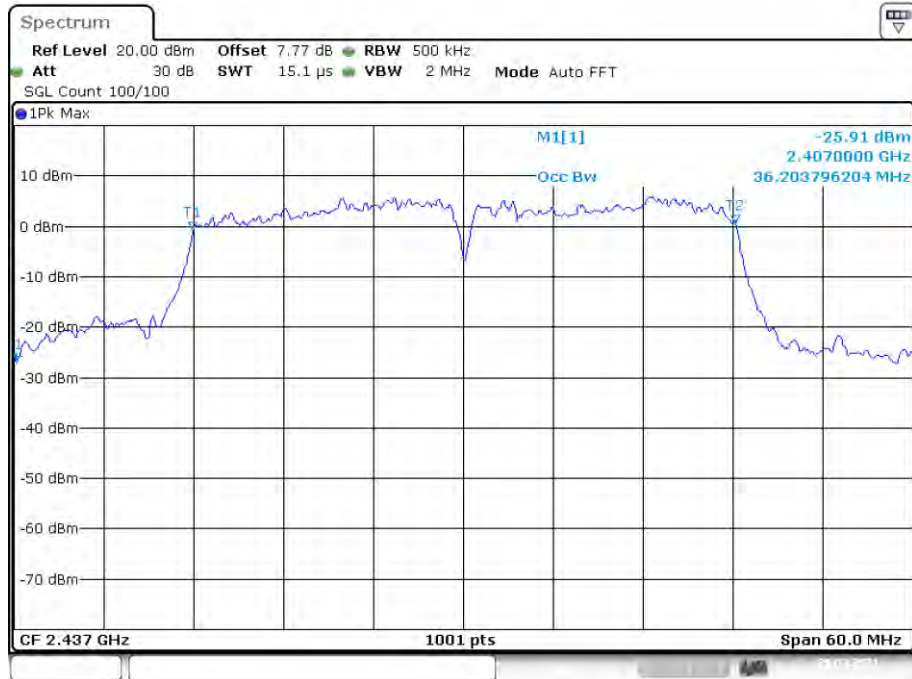

Date: 30.MAR.2021 15:43:50

OBW NVNT n40 2452MHz Ant1

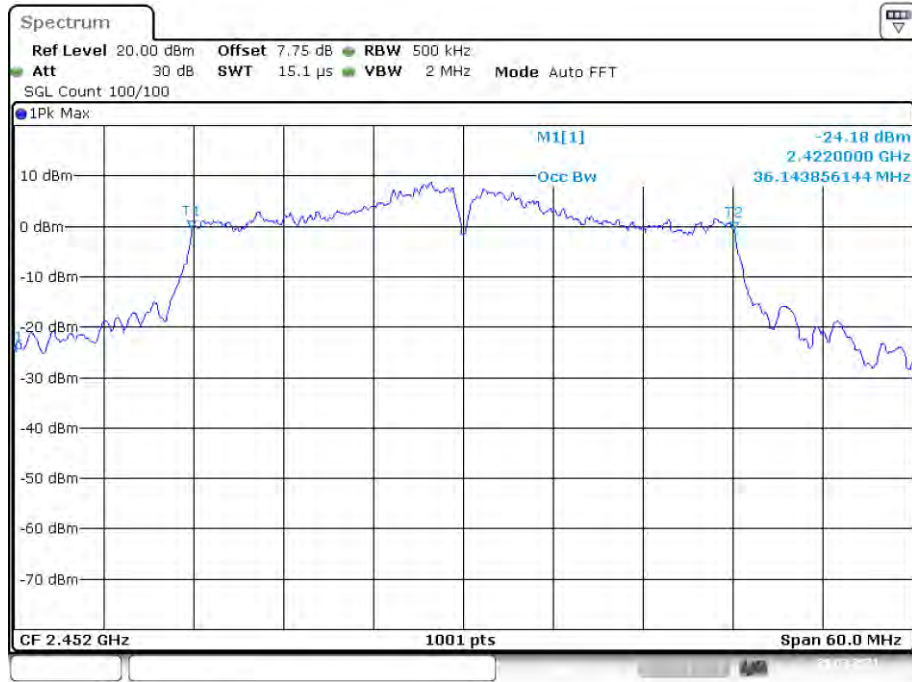

Date: 30.MAR.2021 15:47:01

Note: All modes have been tested, and only Ant1 data are recorded.

8. BAND EDGE CHECK

8.1. Test limits

Please refer RSS-GEN & FCC PART 15: 15.247

All the lower and upper band-edges emissions appearing within 2310MHz to 2390MHz and 2483.5MHz to 2500MHz restricted frequency bands shall not exceed the limits shown in 15.209, all the other emissions outside operation frequency band 2400MHz to 2483.5MHz shall be at least 20dB below the fundamental emissions, or comply with 15.209 limits and RSS-GEN limits.

8.2. Test Procedure

Details see the KDB558074 D01 Meas Guidance v05r02

8.2.1 Put the EUT on a 1.5m high table, power on the EUT. Emissions were scanned and measured rotating the EUT to 360 degrees, Find the maximum Emission

8.2.2 Check the spurious emissions out of band.

8.2.3 RBW 1MHz, VBW 3MHz, peak detector for peak value , RBW 1MHz ,VBW 10Hz , RMS detector for AV value.

8.3. Test Setup

Same as 5.2.2.

8.4. Test Results

PASS.

Detailed information please see the following page.

Test Mode: IEEE 802.11b-Low

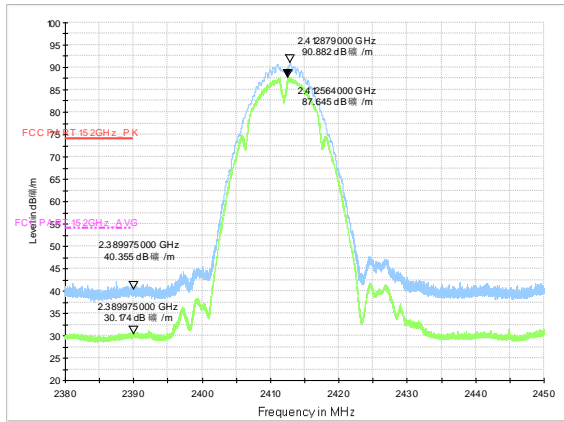

Test Mode: IEEE 802.11g-Low

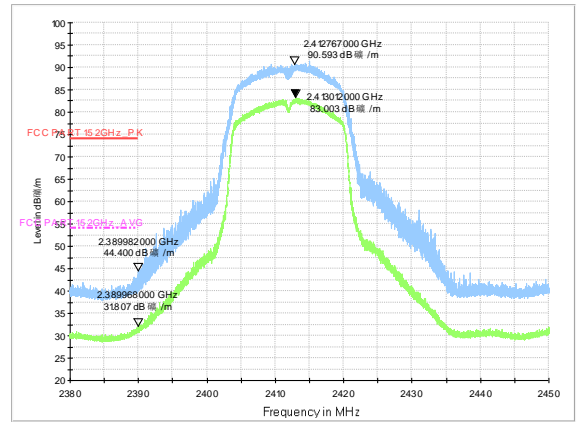

Test Mode: IEEE 802.11b-High

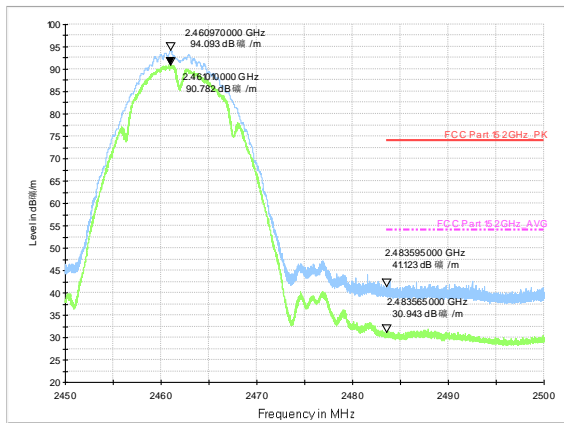

Test Mode: IEEE 802.11g-High

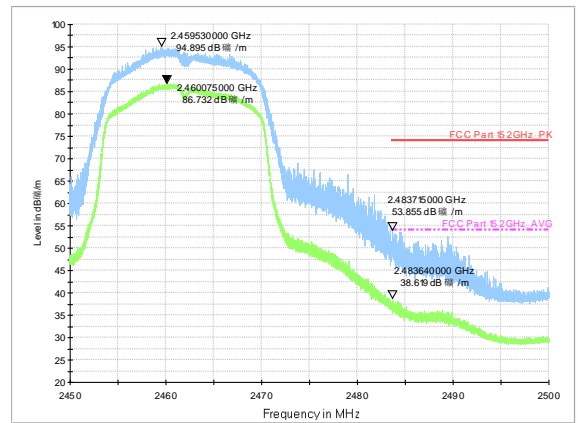

Test Mode: IEEE 802.11n20-Low MIMO

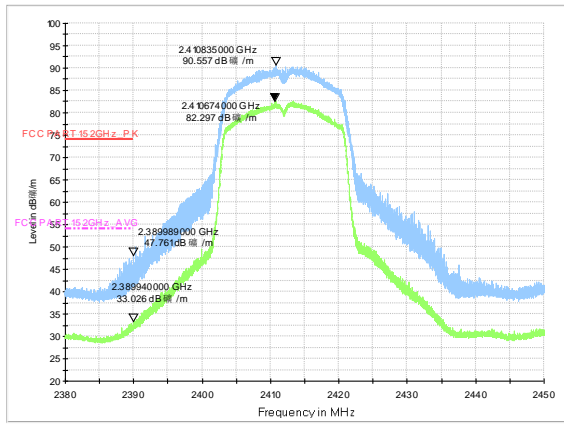

Test Mode: IEEE 802.11n40-Low MIMO

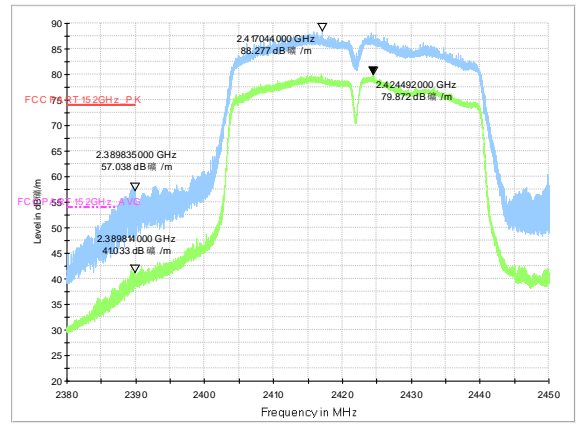

Test Mode: IEEE 802.11n20-High MIMO

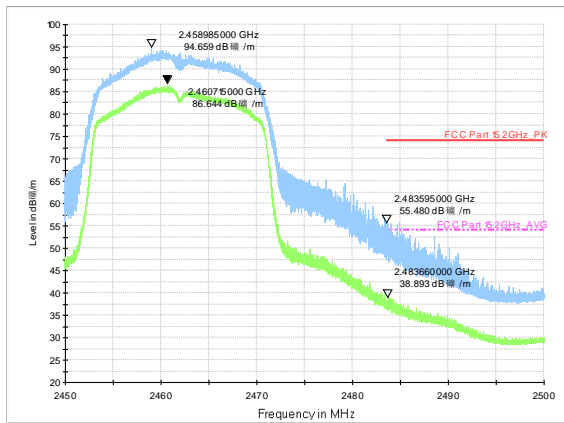

Test Mode: IEEE 802.11n40-High MIMO

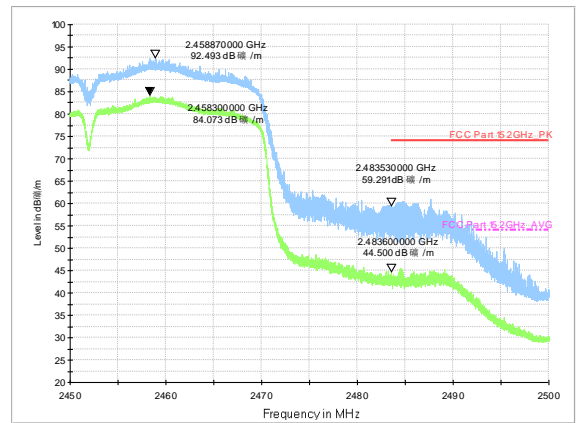

Note: 1. *:Maximum data; x:Over limit; !:over margin.

2. Measurement=Reading Level + Correct Factor; Correct Factor=Antenna Factor + Cable Loss.

Test mode: 802.11b

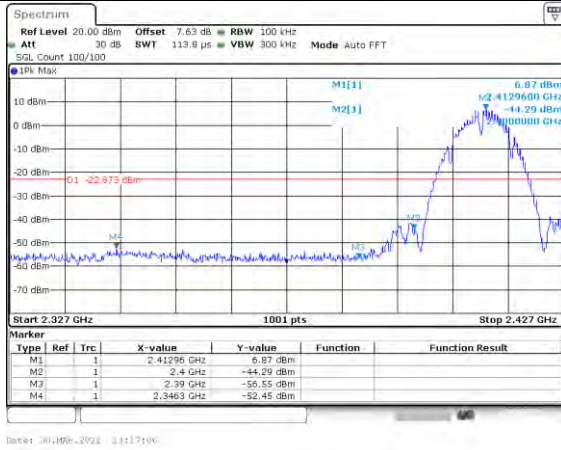

Lowest channel

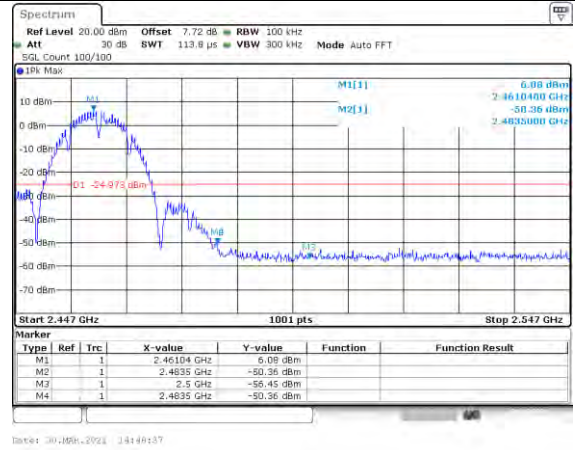

Highest channel

Test mode: 802.11g

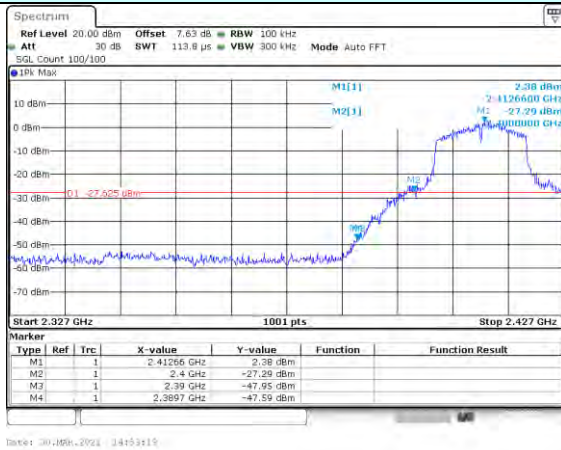

Lowest channel

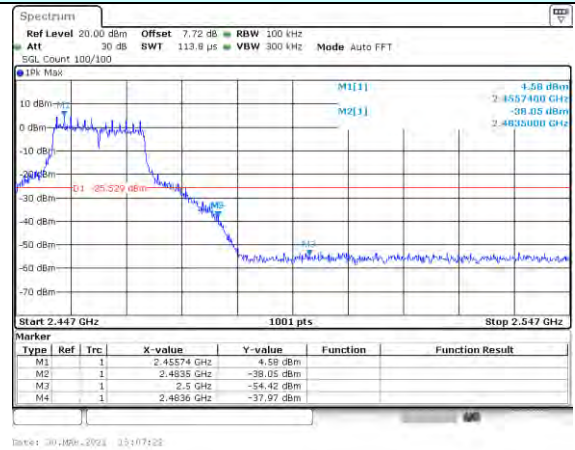

Highest channel

Test mode: 802.11n(HT20) MIMO

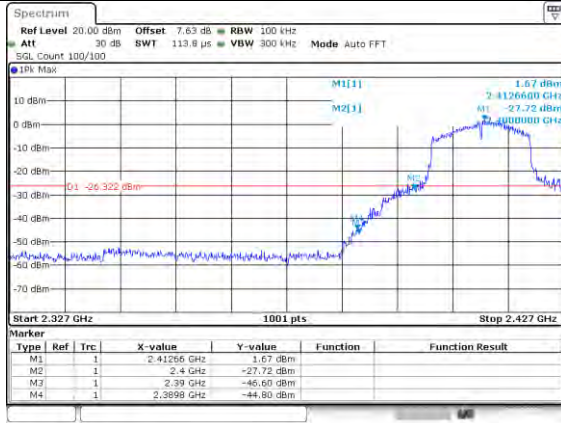

Lowest channel



Highest channel

Test mode: 802.11n(HT40) MIMO

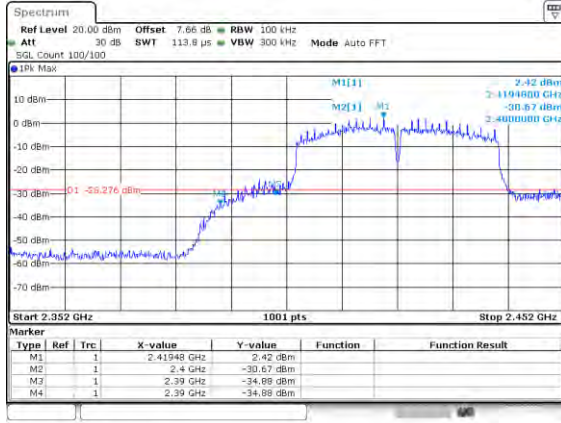

Lowest channel

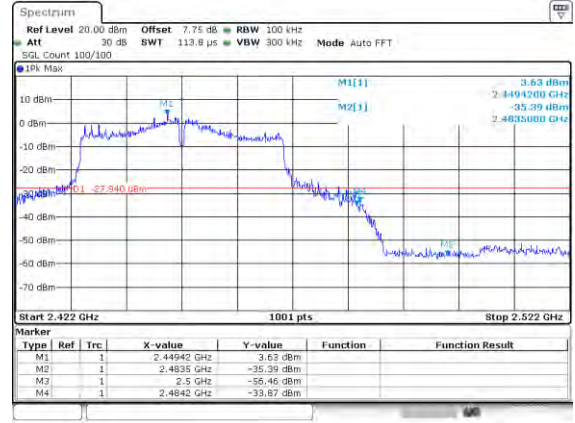

Highest channel

9. FREQUENCY STABILITY

9.1. Test limit

Please refer section RSS-Gen.

Regulation RSS-Gen If the frequency stability of the licence-exempt radio apparatus is not specified in the applicable RSS, the fundamental emissions of the radio apparatus should be kept within at least the central 80% of its permitted operating frequency band in order to minimize the possibility of out-of-band operation. In addition, its occupied bandwidth shall be entirely outside the restricted bands and the prohibited TV bands of 54-72 MHz, 76-88 MHz, 174-216 MHz, and 470-602 MHz, unless otherwise indicated.

9.2. Test Procedure

The following equipment are installed on the emission measurement to meet the commission requirements and operating regulations in a manner which tends to maximize its emission characteristics in normal application.

9.3. Test Setup

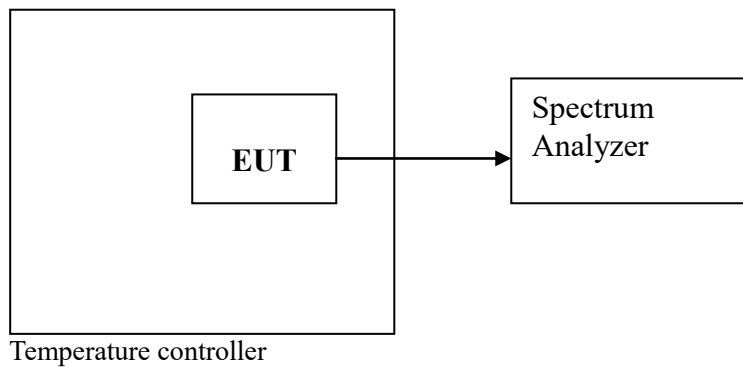

9.4. Test Results

Not applicable.

10. ANTENNA REQUIREMENT

10.1. Standard Requirement

An intentional radiator shall be designed to ensure that no antenna other than that furnished by the responsible party shall be used with the device. The use of a permanently attached antenna or of an antenna that uses a unique coupling to the intentional radiator shall be considered sufficient to comply with the provisions of this Section. The manufacturer may design the unit so that a broken antenna can be replaced by the user, but the use of a standard antenna jack or electrical connector is prohibited.

10.2. Antenna Connected Construction

The antenna connector is unique antenna and no consideration of replacement. Please see EUT photo for details.

10.3. Results

The EUT antenna is external antenna and the interface is RP-SMA. It complies with the standard requirement.

11. TEST SETUP PHOTO

Photos of Radiated emission



12.PHOTOS OF EUT

Please refer to: External Photographs and Internal Photographs.

-----THE END OF REPORT-----