

# CHCNAV BB4 UAV

User Manual

V1.0



Mobile Mapping | March 2020

# Table of Content

<b>Table of Content</b> .....	<b>2</b>
<b>1 Product Description</b> .....	<b>4</b>
1.1 Introduction.....	4
1.2 Function Highlights .....	4
<b>2 Installation</b> .....	<b>5</b>
<b>3 LI-HV Battery</b> .....	<b>6</b>
3.1 Battery Description.....	6
3.2 Battery Function .....	6
3.3 Battery Usage .....	7
3.3.1 Battery Installation.....	7
3.3.2 Battery Connect/Disconnect.....	7
3.3.3 General Attention.....	8
3.3.4 Low Temperature Use Attention .....	8
3.3.5 Battery Level Check .....	8
3.3.6 Battery Charging Requirements .....	9
3.3.7 Battery Transport & Storage Requirements.....	9
3.3.8 Battery Charger Definition.....	10
3.3.9 Battery Charging Steps .....	10
3.3.10 Battery Maintenance.....	14
3.3.11 Charger Use Attention .....	14
<b>4 Remote Controller</b> .....	<b>15</b>
4.1 Profile.....	15
4.2 Preparing Remote Controller .....	15
4.3 Overview .....	16
4.4 Operations.....	17
4.4.1 Power On & Off.....	17
4.4.2 Charging.....	18
4.4.3 Controlling the Aircraft.....	18
4.4.4 Switch Flight Mode.....	19
4.4.5 Return-To-Home Button .....	20
4.4.6 Connection.....	20
4.4.7 Optimal Transmission Range.....	21
4.5 Remote Controller LEDs.....	21
<b>5 Return-to-Home (RTH)</b> .....	<b>22</b>
5.1 Profile.....	22
5.2 Smart RTH .....	22
5.3 Low Battery RTH .....	23

---

5.4	Failsafe RTH .....	23
5.5	RTH Safety Notices.....	24
5.6	Updating the Home Point .....	24
<b>6</b>	<b>Flight.....</b>	<b>25</b>
6.1	Flight Environment .....	25
6.2	Flight Limits and No Fly Zones.....	25
6.2.1	Maximum Height and Radius Limits.....	26
6.2.2	No Fly Zones.....	27
6.3	Flight Safety Attentions.....	29
6.3.1	No Flying Conditions .....	29
6.3.2	Aircraft Calibrate .....	29
6.3.3	Trajectory Planning.....	29
6.3.4	Check Before Flight.....	30
6.3.5	During Flight.....	30
6.3.6	After Landing .....	31
6.4	Maintenance Attention.....	31
6.4.1	Aircraft Body Maintenance.....	31
6.4.2	Electric Motor Maintenance.....	31
6.4.3	Airscrew Maintenance.....	32
6.4.4	Remote Controller Maintenance .....	32
6.5	Special Attentions.....	32

# 1 Product Description

## 1.1 Introduction

CHCNAV BB4 UAV consists three parts: an aircraft, a remote controller and the supporting DJI GO APP. It is a four-rotor drone flight platform which built for LiDAR measurement system carried and multiple professional surveying & mapping applications. BB4 equipped with a customized DJI A3 dual-redundancy flight control system, which has industry-leading multiple safety guarantees and advanced intelligent flight functions. The snap-on foldable arms and foldable airscrew blades design are convenient for storage and transportation, also can effectively shorten the preparation time before take-off. The maximum take-off weight of BB4 is 28kg and it can be equipped with a variety of different types of sensors to meet the needs of various complex terrain environments.

## 1.2 Function Highlights

- Equip DJI A3 dual-redundancy flight control system which can greatly improve the anti-risk performance of the system. Rich communication and SDK ports can meet the needs of multiple professional customization and provide unique flight solutions.
- Powered by two high-capacity and high-density LI-HV batteries which can effectively improve endurance time. Equipped with a battery management system to ensure power supply safety and reliability. BB4 also equipped with two SKYRC 1080 dual-channel parallel chargers, which can charge two LI-HV batteries at same time.
- Adapt for multiple CHCNAV LiDAR systems such AS300, AS900HL and AS1300HL, which can meet the needs of multiple professional surveying & mapping applications.
- The remote controller integrates a built-in Lightbridge-2 high-definition image transmission ground station, which can match with the aircraft built-in Lightbridge-2 sky station, and user can view real time HD images via the DJI GO App on any mobile devices.

## 2 Installation

Put BB4 on a flat ground:

- Expand four drone arms from the inside to outside direction, then tighten the buckle to ensure it is tightly fixed with the aircraft body. If user need to withdraw drone arms, just use body to hold it against the other side of the buckle, and then loosen the buckle by hand easily.
- Expand all airscrews.
- Expand GPS-Compass and check that all airscrews point to the aircraft hand direction.

**Tip:** If user need to store the aircraft, please loosen the buckle first and then withdraw two aircraft hand drone arms, finally withdraw other two drone arms. Otherwise the drone arms may be damaged.

## 3 LI-HV Battery

### 3.1 Battery Description

BB4 equipped with two LI-HV batteries and two battery compartments, which can effectively improve endurance time. LI-HV lithium poly battery is a professional drone battery with 44000mah capacity, 52.2V voltage and a charge & discharge management function. This battery uses a new generation high-energy cell to provide sufficient power for the aircraft. The LI-HV battery must be charged by the standard special charger.

### 3.2 Battery Function

LI-HV lithium poly battery has below functions:

- **Balanced charging protection:** Automatically balance the battery cell voltage to protect the battery.
- **Overcharge protection:** Overcharging will seriously damage the battery. When the battery is fully charged, it will automatically stop charging.
- **Overcurrent charging protection:** High current charging will seriously damage the battery. The charger has a maximum 20A limits to avoid overcurrent charging.
- **Over-discharge protection:** Over-discharge will seriously damage the battery. If the battery is discharged to 42.8V, the battery will cut off the output.
- **Communication:** The aircraft can obtain battery information in real time, such as voltage and power.

## 3.3 Battery Usage

### 3.3.1 Battery Installation

Put both two LI-HV lithium batteries into separate battery compartments:

- BB4 is equipped with two battery compartments, which means must use two LI-HV batteries to power the aircraft.
- Make sure all batteries are fully charged and using them at the same time.
- Before connecting the battery to the power supply interface of the aircraft, the remote controller needs to open first, otherwise the airscrew may rotate unexpectedly which may cause personal injury.
- When using multiple sets of LI-HV batteries, user can use the battery sticker equipped with the BB4 drone to mark and record the number of times the battery has been used.

### 3.3.2 Battery Connect/Disconnect

- **Battery connect:** Before connect battery, make sure to turn on the remote controller first, to ensure that BB4 can continually receive signal from controller. When connect battery, only need to connect two XT90 male ports of battery with two XT90 female ports of aircraft. During the connection, pay attention to the positive direction of the interface to ensure that the red and black wires correspond to each other ("+" pole pair to "+" Pole, "-" pole pair to "-" pole), and the interface is designed for anti-plug and anti-ignition which mainly to prevent short circuit between positive and negative poles, also designed for frequent ignition which may caused poor contact on the interface surface.
- **Battery disconnect:** Before disconnect battery, make sure the remote controller is turn on. Do not turn off the remote controller in advance. When disconnecting battery, please only unplug the battery port separately. Do not pull & drag cable.

**Tip:** Make sure all batteries are in proper condition before taking off. If the DJI GO App shows abnormal battery voltage, please follow the prompts to operate. If the battery is abnormal during the flight, the DJI GO App will alarm and prompt to land. At this time, please immediately land BB4 and to troubleshoot.

### 3.3.3 General Attention

- a) Battery must be powered by equipped charger and do not change charger by user in case of any accident.
- b) External short-circuit, destroy and crush are strictly forbidden for battery, in order to avoid battery leakage and fire.
- c) Do not bump, drop, or hurt the battery.
- d) Do not disassemble the battery.
- e) Do not immerse the battery in water.
- f) Do not use or place battery near heat sources (such as fire sources, heaters etc).
- g) Do not hold the battery power cord when using the battery.
- h) Stop using the battery if it is found damaged or bulging.

### 3.3.4 Low Temperature Use Attention

- a) If battery temperature is lower than  $-10^{\circ}\text{C}$ , forbids using battery; If battery temperature is in the range of  $-10^{\circ}\text{C}$  to  $5^{\circ}\text{C}$ , the battery needs to be nearly full charge state (cell voltage  $> 4.2\text{V}$ ), then can take off, and a thermal insulation sticker must be used.
- b) If environment temperature is lower than  $5^{\circ}\text{C}$ , the battery internal resistance increases and the voltage drops sharply, which reduce the amount of power and thus reduces the endurance time. The battery needs to be nearly full charge state which means the cell voltage reaches  $4.35\text{V}$ .
- c) Under extremely cold conditions (such as air temperature  $-20^{\circ}\text{C}$ , battery temperature  $5^{\circ}\text{C}$ ), even with pre-heating measures, the battery temperature can not rise and it will gradually decrease, which may leading a sharp drop in battery power and a sharp decrease in endurance time.
- d) If all above conditions are met, when the DJI GO App prompts "Severe Low Battery Alarm, Landing", it is recommended to stop the flight immediately and choose a suitable place to land. During the automatic landing process, user can continue control the flight direction (such as pushing the throttle to raise the aircraft) through the remote controller.
- e) In order to exert the best performance of the battery, it is important to keep the battery temperature above  $20^{\circ}\text{C}$  before flight.

### 3.3.5 Battery Level Check

User can use the equipped measuring tool to check battery level. Connect with battery balance head and pay attention to positive and negative poles to ensure that they are correspond to each other, then user can check the current battery level.



### 3.3.6 Battery Charging Requirements

Item	Requirement	Comment
Environment Requirement	10~45°C	
Site Requirement	Indoor, need people attention	
Charging Voltage	Use equipped charger	Do not use other brand charger for battery charging
Charging Current	Maximum 15A	

### 3.3.7 Battery Transport & Storage Requirements

Item	Requirement	Comment
Environment Requirement	-10~35°C; Relative humidity: 45~75%	For long time storage (more than 3 months): 18~25°C; Humidity 45~85
Site Requirement	Indoor	For long time storage need to put it into metal trunk
Storage Capacity	If more than 3 days no use battery, please charging battery by storage mode of charger	For long time storage, check capacity per month; If lower than 10%, need to recharge battery by storage mode
Transport Requirement	Do not shake or crash battery	

### 3.3.8 Battery Charger Definition



### 3.3.9 Battery Charging Steps

#### 3.3.9.1 Connect charger power

Connect AC power and turn on the charger switch. It will beep one time and fan starts self-test turn. The LCD screen will display following:



### 3.3.9.2 Battery connects with charger

Refer to below figure to connect the lithium poly battery to the charger (Note: 6 lithium batteries are also called 6S lithium batteries). The charger supports charging two batteries at the same time. Connection steps: 1. Connect the balanced charging cable first; 2. Connect lithium battery.

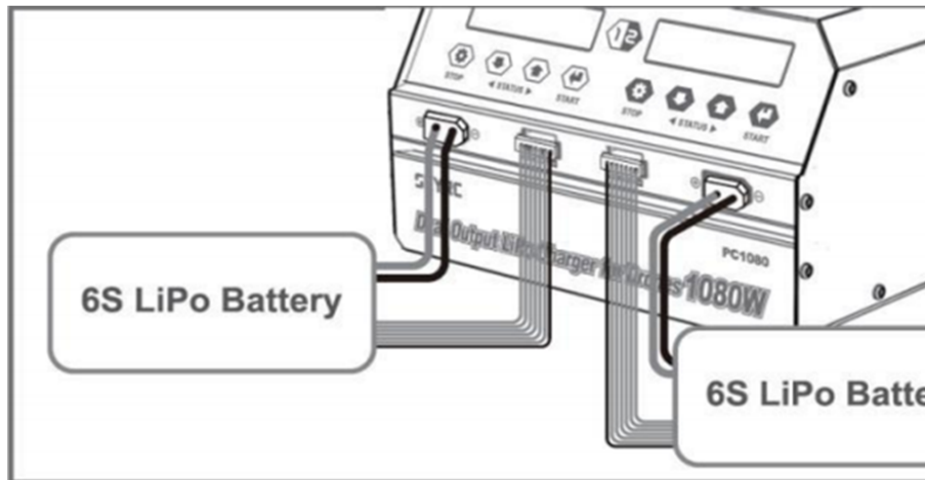

### 3.3.9.3 Charger settings

- There are two types of batteries: Ordinary lithium battery and high-voltage lithium battery. The switching method is to press and hold the "↑" and "↓" keys at the same time to switch.
- The battery charger supports three modes: Precise balanced charging mode, which is generally used and this mode can extend battery life; Quick charging mode, which is only used emergency and this mode can greatly speed up charging efficiency, but will reduce battery life; Storage mode, which is suitable when battery is not used for a long time. It can discharge the fully charged battery to 50% ~ 60% of power for storage, ensuring that the battery does not bulge and extend battery life.
- For 22000mah lithium-polymer battery, it is recommended to choose 15A precise balanced charging mode to charge battery.

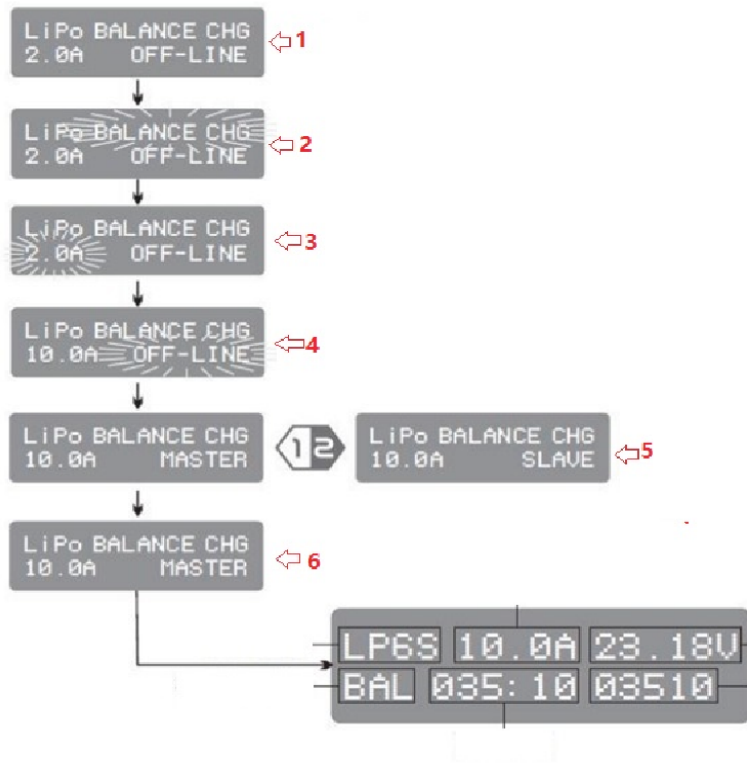

- 1—Press “

**3.3.9.4 One-button charging**

Long press “

CHCNAV BB4 USER MANUAL | 2020-03

current, charging time and already charged capacity.

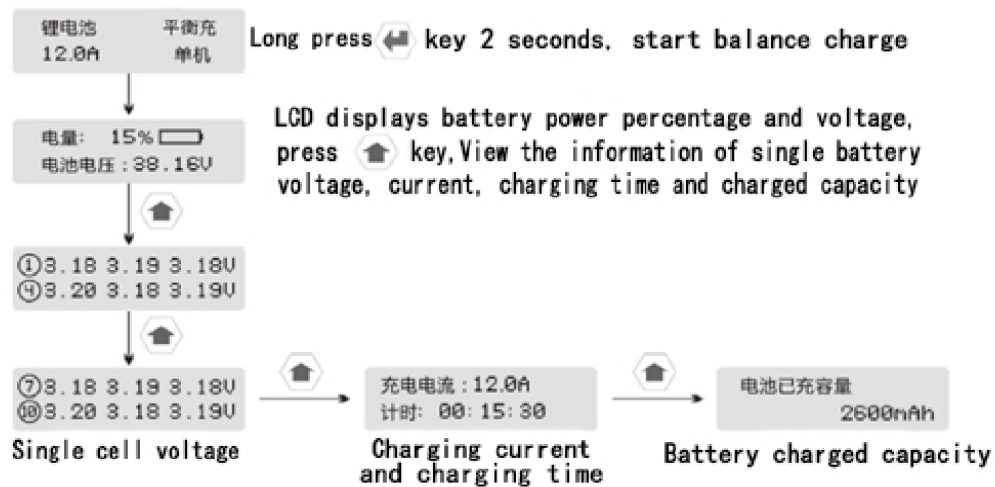

### 3.3.9.5 Stop charging

During the work time of charger, if user need to stop charging, please press "STOP" button. In master-slave mode, it can only be operated through the master channel.

### 3.3.9.6 Finish charging

In the charging mode, the LCD screen will display following interface:



#### Tips:

- If the aircraft uses a 12S lithium poly battery. the voltage is displayed as 52.2V when finish charging.
- The battery must use the equipped special charger to charge. CHC will not be responsible for all the consequences of charging with non-standard chargers.

### 3.3.9.7 Storage mode

- If the battery is long time no use, its performance will be affected. Make sure to do 2-3 times charge and discharge cycles to ensure the maximum battery life.
- It is recommended to use the battery storage mode. The current is set to 10A under storage mode, and the lithium battery voltage is storage as 3.85V. The best performance of storage mode is 46.2V.
- When the battery voltage is higher than 3.85V / CELL, the charger will discharge under

storage mode; When the battery voltage is lower than 3.85V / CELL, the charger will be charged in storage mode.

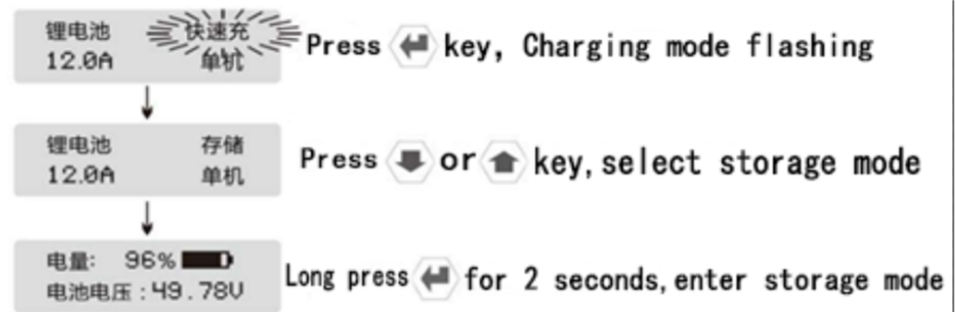

#### Tips:

Quickly discharge: Install the battery in aircraft and when voltage display 46V which means discharge is finished.

### 3.3.10 Battery Maintenance

- First check whether the battery can be used and check whether the battery has bumps. It is not recommended to continue using the bumps battery.
- Pay attention to the influence of temperature to battery. The ideal storage temperature is 22 ~ 28 °C. Do not store the battery in a place below -10 °C or above 45 °C.
- Store the battery in a cool and dry place if long time not used. The battery needs to be completely charged and discharged once every 3 months or after about 30 times charging and discharging.
- Please discharge battery if long time not used.
- Please use special metal trunk for transportation and storage.
- Pay attention to the electrical current during charging and it cannot exceed the specified limit.
- User need to check regularly during the charging and the charger should be disconnected within 1 hour after fully charged. Unattended charging is strictly prohibited.

### 3.3.11 Charger Use Attention

- Do not charge broken battery in case of any danger.
- Do not charge a full-charged battery or a newly discharged battery.
- Do not use the charger unattended. If there is any abnormal function, please interrupt charging immediately and check the issue.
- Keep the charger away from dust, humidity, rain and high temperature; Avoid direct

sunlight and strong vibration to charger.

- The charger supports AC input voltage between 100-240V.
- Place the charger in a well-ventilated space. Please keep flammable and explosive items away from the use area of the charger.
- Please fully understand the battery specifications for charging & discharging and keep the same settings in the charger. If the settings are incorrectly, the charger and battery may be damaged. Overcharging may cause fire even explosion.

## 4 Remote Controller

### 4.1 Profile

The remote controller works with 2.4Ghz frequency band and the maximum communication distance is 7 kilometers. It integrates the new generation Lightbridge-2 HD image transmission system, which can directly output HD aerial images to mobile devices.

- Stick Mode: Control can be set to Mode 1, Mode 2 (by default), or a custom mode in the DJI GO app. Recommend use Mode 2 for new user.
- Mode 1: The right stick serves as the throttle.
- Mode 2: The left stick serves as the throttle.
- Do not operate more than 3 aircrafts within the same area (size equivalent to a soccer field) to prevent transmission interference.

### 4.2 Preparing Remote Controller

Tile the Mobile Device Holder to the desired position then adjust the antenna as shown.

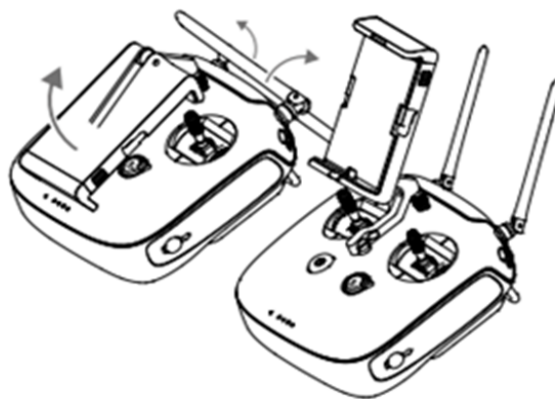

### 4.3 Overview

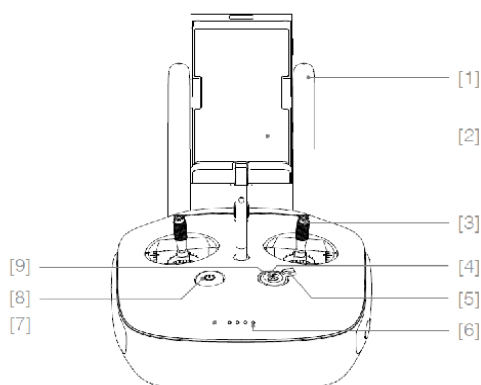

- [1] Antennas  
Relays aircraft control and video signal.
- [2] Mobile Device Holder  
Mounting place for your mobile device.
- [3] Control Stick  
Controls aircraft orientation.
- [4] Return-to-Home (RTH) Button  
Press and hold the button to initiate Return-to-Home (RTH).

- [5] Landing Gear Control Switch  
Toggle the switch up or down to raise or lower the landing gear.
- [6] Battery Level LEDs  
Displays the current battery level.
- [7] Status LED  
Displays the power status.

- [8] Power Button  
Used to power on or power off the remote controller.
- [9] RTH Status LED  
Circular LED around the RTH button displays RTH status.

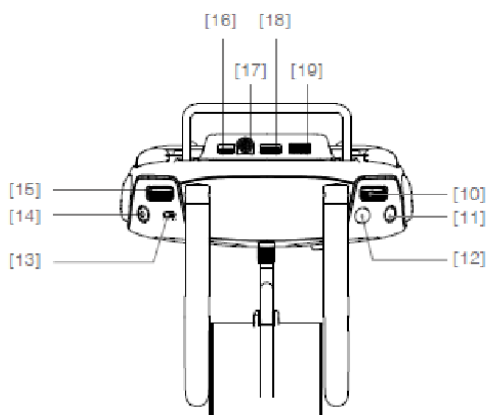

- [10] Camera Settings Dial  
Turn the dial to adjust camera settings. Only functions when the remote controller is connected to a mobile device running the DJI GO app.
- [11] Playback Button  
Playback the captured images or videos.
- [12] Shutter Button  
Press to take a photo. If in burst mode, the

- set number of photos will be taken with one press.
- [13] Flight Mode Switch  
Used to switch between P, A and F mode.
- [14] Video Recording Button  
Press to start recording video. Press again to stop recording.
- [15] Gimbal Dial  
Use this dial to control the tilt or pan of the gimbal.
- [16] Micro USB Port  
Reserved.
- [17] SDI Port  
Connect an SDI display device.
- [18] HDMI™ OUT Port  
Connect an HD compatible monitor.
- [19] USB Port  
Connect to mobile device to access all of the DJI GO app controls and features.



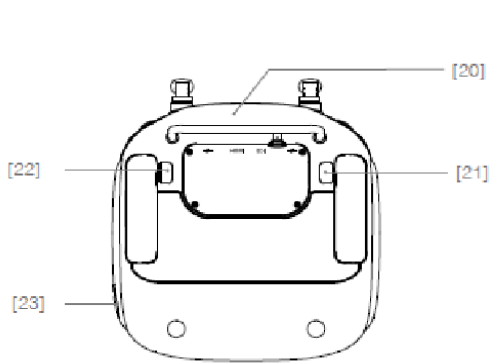

- [20] GPS Module  
Used to pinpoint the location of the remote controller.
- [21] Back Left Button  
Customizable button in the DJI GO app.
- [22] Back Right Button  
Customizable button in the DJI GO app.
- [23] Power Port  
Connect to a power source to charge the remote controller's internal battery.

## 4.4 Operations

### 4.4.1 Power On & Off

The remote controller is powered by a 2S rechargeable battery with a capacity of 6000mAh. User can check the battery level via the front panel LEDs. Please follow below steps to power on controller:

- Short press Power Button once to show current battery level.
- Short press Power Button once and then long press button for 2 seconds to power on the remote controller.
- The remote controller will beep when it powers on. The LED red blink rapidly means the controller is linking to the aircraft; The LED shows green light means the linking is completed.
- Repeat step 2 to power off controller.

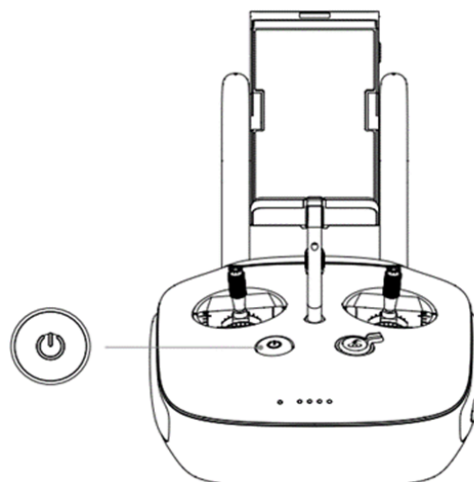







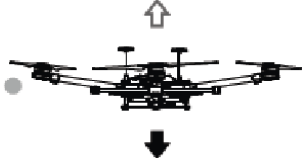

### 4.4.2 Charging

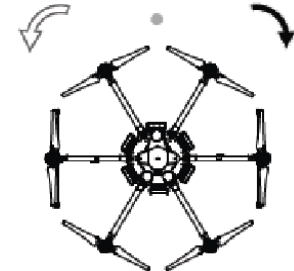
User can use equipped standard charger to charge the remote controller.

### 4.4.3 Controlling the Aircraft

The default control mode of the remote controller is Mode 2 so this manual will choose Mode 2 as an example to describe the detailed steps.

Remote Controller	Aircraft (● indicates nose direction)	Function
		<p>Moving the Left Stick up/down changes the aircraft's elevation. Push it up to ascend and down to descend.</p> <p>Use this stick to take off when the motors are spinning at idle speed. The aircraft will hover in place if the Left Stick is released.</p>
		<p>Moving the Left Stick left/right changes the heading of the aircraft. Push it left to rotate the aircraft counter clock-wise, and right to rotate the aircraft clockwise.</p>
		<p>Moving the Right Stick up/down changes the aircraft's forward and backward pitch. Push it up to fly forwards and down to fly backwards.</p> <p>Push the Right Stick further for a larger pitch angle and faster flight.</p>
		<p>Moving the Right Stick left/right changes the aircraft's left and right pitch. Push it left to fly left and right to fly right.</p> <p>Push the Right Stick further for a larger pitch angle and faster flight.</p>
		<p>Turn the Gimbal Dial to control the pitch or pan movement of the gimbal. The Gimbal Dial controls the pitch by default. You can set the back left or back right button to allow the Gimbal Dial to control the pan movement by using the DJI GO app.</p>

**Tips: Always push the control sticks gently to prevent sudden and unexpected movement of the aircraft.**

### 4.4.4 Switch Flight Mode

1. Toggle the switch to select the desired flight mode: P-mode, A-mode and F-mode.

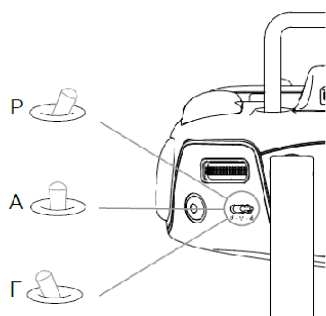





Figure	Flight Mode
P 	P-mode
A 	A-mode
F 	F-mode

- P-mode (Positioning): P-mode works best when GPS signal is strong. P-mode will be automatically switched depends on GPS signal strength:
    - P-GPS: GPS is available. The aircraft uses GPS for positioning.
    - P-ATTI: GPS signal is not good. The aircraft uses attitude for stable.
  - A-mode (Altitude): GPS module is not used for positioning. The aircraft only use attitude for stable. If GPS signal is available, the Return-To-Home function can be activated.
  - F-mode (Function): Auxiliary function mode, which supports Intelligent Flight Mode and SDK function.
2. The flight mode is locked in P-mode by default. To enable other flight modes, go to the DJI GO app-Camera View and click “” to enable Multiple Flight Mode.
  3. The aircraft will enter A-mode in the following two instances:
    - Passive: GPS signal is bad or the compass experiences interference.
    - Active: User toggle the flight mode switch to A-mode.

In A-mode, the aircraft can be easily affected by surroundings which may result in horizontal shifting. Meanwhile, some advanced features are disabled and the aircraft cannot position by itself, which means user need to position the aircraft by controller manually.

Operate the aircraft in A-mode can be much difficult than usual. If need to choose A-mode, user need to fully understand how to operate the aircraft. Do not fly the aircraft too far away in avoid any risk as long distance. If the aircraft switch to A-mode passively, please land it in a safe place ASAP. Also, try to avoid fly the aircraft in bad GPS signal or confined space, which may also lead to potential flight hazards.

### 4.4.5 Return-To-Home Button

Long press button until the remote controller beep to activate intelligent Return-To-Home mode. The LED light show white which indicates the aircraft is entering the Return-To-Home mode, and the aircraft will return to the recently recorded home point. During the return flight, user can still control the aircraft through the remote controller: Short press this button to end this mode and regain control.

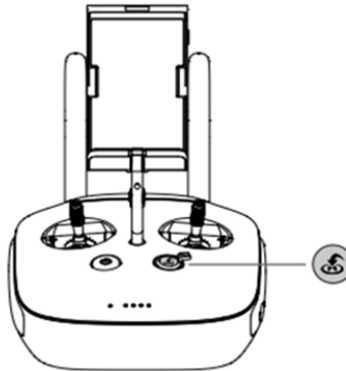

### 4.4.6 Connection

The remote controller needs to connect with any mobile device with the DJI GO App installed via the USB port.

- Press the button on the side of the mobile device stand to extend the stand.
- Adjust the mobile device stand to ensure that the mobile device is in stable.
- Use data cable to connect the device and remote controller via USB port.

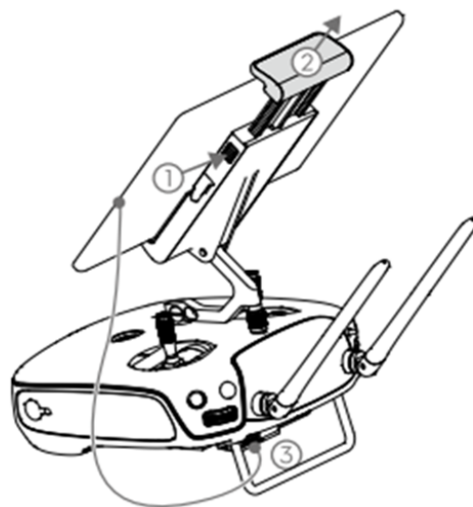

### 4.4.7 Optimal Transmission Range



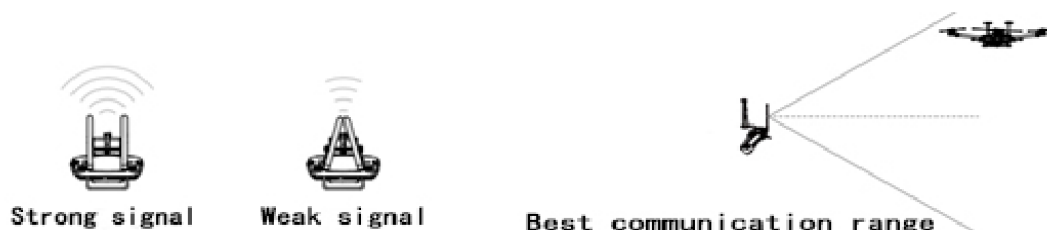



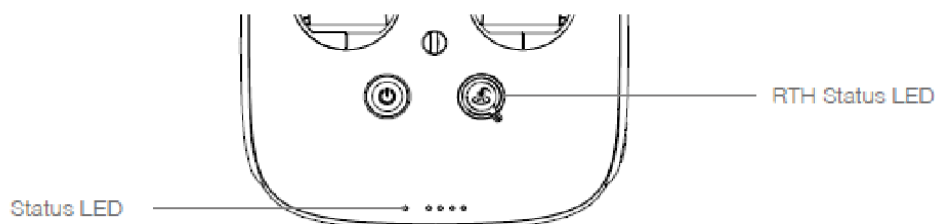

The signal transmission between the aircraft and the remote controller performs best when the aircraft is within the optimal transmission range. Open up the antennas on the controller to optimize transmission range. Ideally, the flat surface of the antenna should be facing the aircraft.



### 4.5 Remote Controller LEDs

The Status LED reflects connection status between the remote controller and the aircraft. The RTH Status LED indicates the Return-To-Home status of the aircraft. Details are shown in below:





Status LED	Alarm	Remote Controller Status
 — Solid Red	♪ chime	The remote controller is set as Master but is not connected to the aircraft.
 — Solid Green	♪ chime	The remote controller is set as Master and connected to the aircraft.
 — Solid Purple	2 beeps	The remote controller is set as Slave but is not connected to the aircraft.
 — Solid Cyan	2 beeps and chime	The remote controller is set as Slave and connected to the aircraft.
 ..... Blinking Red	1 slow beep repeating	Remote controller error. Refer to the DJI GO app for details.
RTH Status LED	Sound	Aircraft Status
 — Solid White	♪ chime	RTH procedure begins.
 ..... Blinking White	1 beep repeating	Sending RTH command to the aircraft.
 ..... Blinking White	2 beeps repeating	Aircraft RTH in progress.

## 5 Return-to-Home (RTH)

### 5.1 Profile

The Return-to-Home (RTH) function brings the aircraft back to the last recorded Home Point. There are three types of RTH modes: Smart RTH, Low Battery RTH and Failsafe RTH.

	GPS	Description
Home Point		The default Home Point is the first location where your aircraft received strong GPS signals (i.e. the white GPS icon is followed by at least four white bars  ). You can update the Home Point via the DJI GO app. Refer to <a href="#">Updating Home Point (p. 28)</a> for details.

### 5.2 Smart RTH

User can click the RTH button on the remote controller or in DJI GO App when GPS signal is good to enable Smart RTH. User can manually control the aircraft’s orientation to avoid collision when it is returning to the Home Point. Press and hold the Smart RTH button to start

the RTH procedure, then press the Smart RTH button again to exit Smart RTH and regain control of the aircraft.

### 5.3 Low Battery RTH

When the battery power is too low, the aircraft may not be able to get sufficient power. User are advised to fly back or land the aircraft immediately when these warnings are shown, otherwise the aircraft may fall directly which can cause damage to the aircraft or other dangers. To prevent unnecessary danger due to insufficient battery power, the controller will intelligently determine whether the current power is sufficient based on the aircraft position. If the current power is only enough to complete the return procedure, the DJI GO App will directly start the RTH.





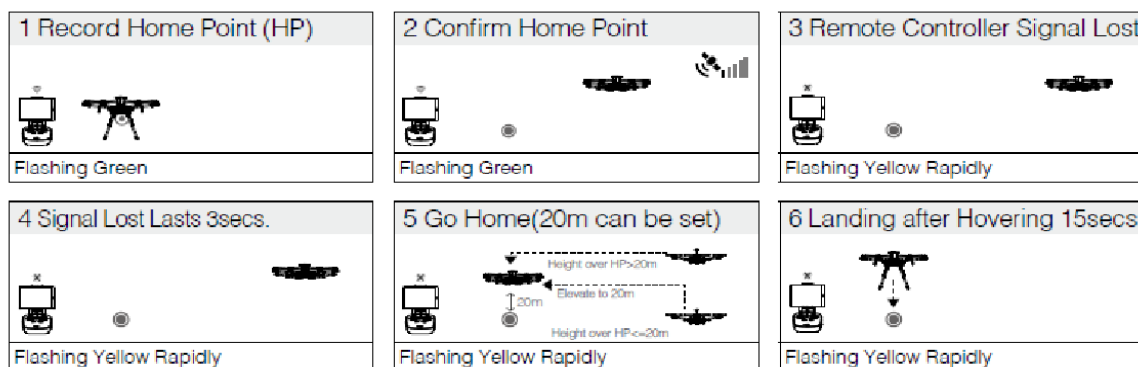

### 5.4 Failsafe RTH

Failsafe RTH is activated automatically if the remote controller signal (including video relay signal) is lost for more than 3 second provided that the Home Point has been successfully recorded and the compass is working normally. User can interrupt the Return-to-Home procedure and regain control over the aircraft if the remote controller signal is recovered.

Failsafe Illustration

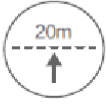

## 5.5 RTH Safety Notices

	<p>The aircraft cannot avoid obstruction during RTH, therefore it is important to set a reasonable RTH altitude before each flight. Go to the DJI GO app &gt; Camera View &gt;  &gt; Set Return-to-Home Altitude.</p>
	<p>If the aircraft is flying under 20 meters (65 feet) and RTH (including Smart RTH, Low Battery RTH and Failsafe RTH) is triggered, the aircraft will first automatically ascend to 20 meters (65 feet) from the current altitude and you cannot control the aircraft during ascending. In Smart RTH, you can exit RTH to cancel the ascending by pressing the RTH button once.</p>
	<p>The aircraft automatically descends and lands if RTH is triggered when the aircraft flies within a 65 feet (20 meter) radius of the Home Point.</p>
	<p>Aircraft cannot return to the Home Point when GPS signal is weak (  displays red) or unavailable.</p>
	<p>The aircraft will stop ascending and immediately return to the Home Point if you move the throttle stick during Failsafe RTH.</p>

## 5.6 Updating the Home Point

User can update the Home Point in the DJI GO App during flight. There are two options for setting the Home Point:



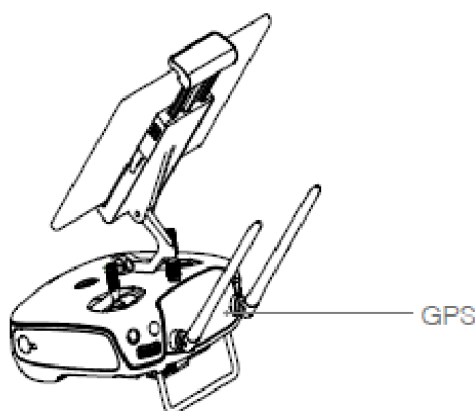

- Set the aircraft’s current coordinate as the Home Point.
- Set the remote controller’s current coordinates as the Home Point.





**Tips:** Ensure the space above the GPS module (shown in the figure) is not obstructed when updating the Home Point.

Please follow below instructions to update the Home Point:

- Connect mobile device to the remote controller and go to the DJI GO App – Camera.
- Click “” and choose “” to set the aircraft current position as Home Point.
- Click “” and choose “” to set the remote controller current position as Home Point.
- After Home Point set successfully, the aircraft status indicator will blink green.

## 6 Flight

Once pre-flight preparation is complete, it is recommended to use the flight simulator to learn how to fly safely. Ensure that all flights are carried out in an open area.

### 6.1 Flight Environment

- Do not fly the aircraft in bad weather conditions including wind (speed exceeding 10m/s), snow, rain and fog.
- Choose open areas to fly the aircraft. Tall buildings and steel structures may affect the accuracy of the compass and GPS signal.
- During flight, keep the aircraft inside the range of visibility. Avoid flying near obstacles, crowds, high voltage power lines, trees and bodies of water.
- Avoid flying in areas with high levels of electromagnetism, including mobile phone base stations and radio transmission towers.
- If flying over 3000 meters, the aircraft and battery performance may be influenced by environmental factors, please be very careful.
- The aircraft can not operate in P-mode within North & South polar regions, user can switch to A-mode for operate.

### 6.2 Flight Limits and No Fly Zones

Unmanned aerial vehicle (UAV) operators should abide by the regulations from self-regulatory organizations such as the ICAO (International Civil Aviation Organization), the FAA and their local aviation authorities. For safety reasons, flight limits are enabled by default to help users use this product safely and legally.

In P-mode, the height limit, distance limit and No Fly Zones work together to monitor flight. In A-mode, only the height limit prevents the aircraft from going above 50 meters. If GPS signal is strong when powered on, the height limit will change to 120 meters.

### 6.2.1 Maximum Height and Radius Limits

Users can change the maximum height and radius limits in the DJI GO App.

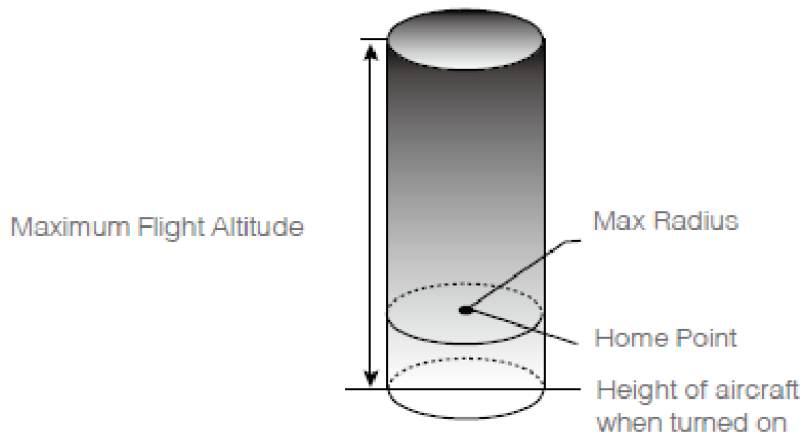

Safe to Fly (GPS)  .....Blinking Green Slowly		
	Flight Limits	DJI GO App
Max Height	Flight altitude must be below the preset height.	Warning: Height limit reached.
Max Radius	Flight distance must be within the max radius.	Warning: Distance limit reached.

Safe to Fly (No GPS)  .....Blinking Yellow Slowly		
	Flight Limits	DJI GO App
Max Height	If the Max Flight Altitude set in the DJI GO app is $\leq 50m^*$ , the flight altitude will not exceed the preset value. If the Flight Altitude set in the DJI GO app is $> 50m^*$ , the flight altitude will not exceed $50m^*$ .	Warning: Height limit reached.
Max Radius	No limit.	

\* The value is set to 120 if the aircraft has ever received a strong GPS signal (i.e. at least three white bars are displayed after the GPS icon) when powered on.

If the aircraft fly out of bounds, user can still control it via the remote controller but cannot fly it further. If the aircraft loses GPS signal and fly out of the max radius but regain GPS signal afterwards, it will fly back within range automatically.

## 6.2.2 No Fly Zones

No Fly Zones includes Airports and Restricted areas, details can check below link:  
<http://www.dji.com/cn/flysafe/no-fly>

### 6.2.2.1 Airports (GPS signal available)

- Airport No Fly Zones include two types: “No-Fly Zone” and “Altitude-restricted Zone”. “No-Fly Zone” limits the aircraft flying area and “Altitude-restricted Zone” limits the aircraft flying height.
- Set the spatial place as circle center. Within the R2 radius range is the “restricted flying area” and within the R1 radius range is the “No-Fly Zone”. The R1 detailed value can be checked by relative airport’s rules.
- When the aircraft is inside R2 but outside R1 range, the flight height has limit and it will be linearly decreasing with the distance to R1 range shorten. User can set the flight height in DJI GO App and the maximum is 500m.
- When the aircraft is within 100m of R1 range, a warning message will appear in the DJI GO App.

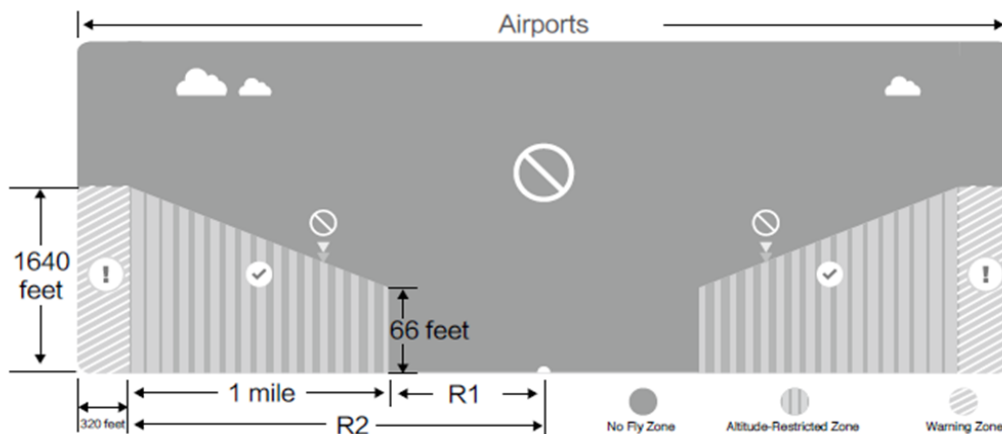

6.2.2.2 Spatial Restricted Areas (requires GPS)

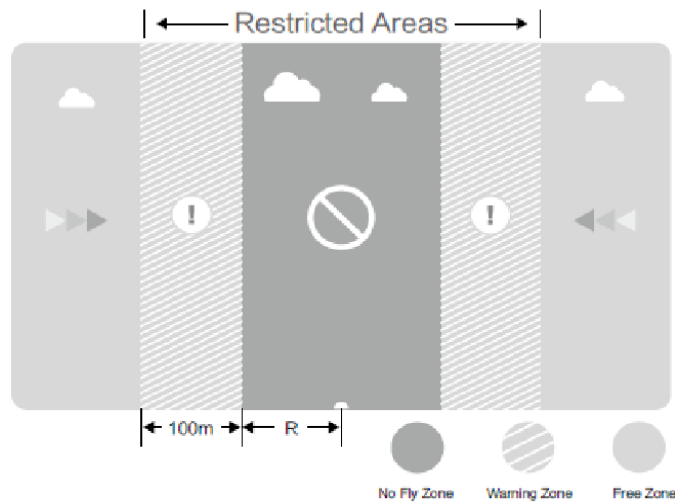

- Spatial restricted areas mean city or district has spatial flight limitation such as Beijing and Xinjiang. The spatial restricted areas include “No-Fly Zone” and “Warning Zone”.
- Set the spatial place as circle center. Within the R radius range is the “No-Fly Zone”. The R detailed value can be checked by relative area’s rules.
- A “Warning Zone” is set on the perimeter of the spatial restricted areas. When the aircraft is within 100m of the “No-fly zone”, a warning message will appear in the DJI GO App.

Safe to Fly (GPS)  ..... Blinking Green Slowly			
Zone	Restrictions	DJI GO App Warning	Aircraft Status Indicator
No Fly Zone 	Motors will not start.	Warning: You are in a no fly zone. Takeoff prohibited.	..... Blinking Red
	If the aircraft loses GPS signal and enters the restricted area but regains GPS signal afterwards, the aircraft will enter Semi-Automatic Descent and land itself.	Warning: You are in a no fly zone. Automatic landing has begun. (If the aircraft is within R1)	
Altitude-Restricted Zone 	If the aircraft loses GPS signal and enters the restricted area but regains GPS signal afterwards, it will descend to a safe altitude and hover 15 feet below the safe altitude.	Warning: You are in a restricted zone. Descending to a safe altitude. (If the aircraft is within R2 but outside R1)	
		Warning: You are in a restricted zone. Max flight height restricted between 20 and 500 m. Fly Cautiously.	
Warning Zone 	No flight restrictions.	Warning: You are approaching a Restricted Area. Fly cautiously.	
Free Zone 	No flight restrictions.	None.	None.

#### Tips:

- Semi-Automatic Descent: All stick commands are available except the throttle stick command during the descent and landing process. Motors will stop automatically after landing.
- When the aircraft in restricted areas, the aircraft status indicator will blink red slowly for 5 seconds, then switch to indicate the current flying status and continue for 7 seconds. Repeat above process.
- For safety reasons, please avoid airport, highway, railway station, subway station and city center area. Try to ensure the aircraft is visible at all times.

## 6.3 Flight Safety Attentions

### 6.3.1 No Flying Conditions

It is forbidden to operate the aircraft if larger than level 3 wind. It is forbidden if under rain, fog, snow and other bad weather. Also forbidden to work at night, to work in summer when the temperature above 37 °C, and to work in winter when the temperature below -10 °C.

### 6.3.2 Aircraft Calibrate

If the aircraft exceed 200km geographical span, it needs calibrate before flight. Please follow below steps:

- Do not equipped LiDAR during aircraft calibration for safety.
- Before the calibration, it is necessary to find an open sky area and keep it away from interference sources for example high-voltage lines, residential areas, and underground magnetic fields.
- For compass calibration, the aircraft need to be lifted by two people first and rotate 360° horizontally; Then, keep the aircraft hand downwards and make sure it's 90° vertical. Finally, lift the aircraft by two people and rotate 360° horizontally again.
- During IMU calibration, all people need to keep 3 meters away from the aircraft except the pilots.
- Within 200km geographical span, the calibration is not necessary. But the home point test needs to be performed with no load, the flight distance is not less than 30 meters and the home point error is not more than 1 meter.

### 6.3.3 Trajectory Planning

Before the real flight, the pilot must familiar the objective area first. For uncertain areas (such

as high-voltage tower, signal tower, high building, high mountains, etc.), the pilot must use a micro drone to test flight to determine flight safety first. Planning trajectory based on the site conditions and test flight conditions. For some high points beyond the line-of-sight, the pilot must increase the altitude by 5-20 meters on the basis of safe test flight to ensure that the plan trajectory has experienced strict test and review.

### 6.3.4 Check Before Flight

- After the aircraft and accessories are installed and before take-off, user must check the aircraft based on the "Drone Flight Safety Inspection Record Form" (see the appendix for details)
- Content inspection: external structure check, circuit and control unit check, power-on status check and software mission check.
- The recording should be done by the pilot or other depends on the actual site situation.
- For each new across-regions project, an unloaded flight test must be done before the real flight. The test distance is not less than 200m and the time is not less than 10 minutes.
- Surrounded client and people need to keep more than 10m with the aircraft during take off and landing process.
- Before taking off, a flight notification must be made when prepared ready and inform the supervisor about the preparations.

### 6.3.5 During Flight

- During flight, the pilot must check the aircraft attitude, altitude, speed, battery voltage, and satellite number.
- After taking off, user need to pay consistent attention to the aircraft status, make sure all parameters are consistent with settings and flight status is normal
- If the worksite condition is special and the aircraft need to flight beyond visual range, user need to observe the aircraft at long distance and feedback to pilot.
- If the remote controller signal is unstable in special area, user need to understand the potential risk then start work.
- If the environment of worksite is complex and GPS signal is not good, user can choose manually to control but make sure the distance is within 200m.
- If the GPS signal is losing during flight, the aircraft need to be returned immediately for safety. If the aircraft is broken and result a crash, first make sure people safety.
- Make sure the aircraft has sufficient power to return back safely.
- When the aircraft lands at a height of 20m above the ground, if people or a vehicle passes, the aircraft must be stopped immediately, otherwise it need hovering.

## 6.3.6 After Landing

- After landing, make sure the remote controller is locked. Check the battery level and turn off the aircraft power.
- If LiDAR needs to record static data, then surrounded people need to keep more than 3m away from the aircraft.
- After LiDAR's work is completed, it needs turn off first then cut off all power finally.
- Check the aircraft's body, relative sensors and battery status.
- Remove the airborne equipment first, then the aircraft and put them into the instrument box together.
- If the next flight is to be continued, the aircraft and relative equipment can be placed in the trunk of a car with sufficient space and protected to ensure that no broken during transportation.

## 6.4 Maintenance Attention

### 6.4.1 Aircraft Body Maintenance

- Check whether the aircraft screws are loose, and whether the aircraft wings are crack.
- Check whether the damper ball is aging (the outer layer is hardened or cracked).
- Check whether there is an object (such as a sticker with conductive medium) that affects the signal above the GPS and the antenna position of each undercart.

### 6.4.2 Electric Motor Maintenance

- Clean the outside dust and mud of motor timely if environment is dusty; It is recommended to clean it after each flight.
- Check whether the connection screws of terminal box are loose or burned.
- Check the screws of each fixing part and tighten them.
- Rotate the axle by hand to check whether it is flexible and whether has abnormal friction, jamming, shaft shifting and sound. Meanwhile, check whether the parts on the electric motor are complete
- If a motor does not rotate or rotate speed is very low or there is abnormal sound after power on, the power shall be cut off immediately. If the power on time is too long, the motor may burn even broken

### 6.4.3 Airscrew Maintenance

- Pay attention to whether the blades have cracks or gaps which can directly affect flight stability. If the damage is severe, need to replace a new airscrew.
- In addition, pay special attention to whether the airscrews are fixed in sequence before take-off; Check and clean the motor wiring, and check whether the screws of terminal box are loose or burned.

### 6.4.4 Remote Controller Maintenance

- Do not put the remote controller in a humid or hot environment.
- Avoid any crash or broken of controller, in case of internal accuracy is influenced.
- Check whether the controller antenna has damage, whether the strap of the remote control is firm, and whether it is properly connected.

## 6.5 Special Attentions

- Forbid any other people operate the remote controller by themselves to avoid accidents. When placing the remote controller on the ground, be sure to choose flat ground.
- Generally, the aircraft is carried separately, and it is not recommended to choose shipping method; For some special cases, the pilot need to check and pack all parts before shipment and make a record table.
- It is strictly forbidden to touch the landing aircraft by hand.
- It is strictly forbidden to suddenly push the throttle to take off from ground, in case of any potential dangers for surrounded people.
- Do not pick up the aircraft after landing but the blades still rotate or not self-locking.
- As the first person responsible for the UAV, the pilot must treat each flight with a conservative and cautious attitude. The decision of flight cannot be influenced by external conditions such as customers.





## FCC Statement

### 1) FCC 15.19

This device complies with part 15 of the FCC Rules. Operation is subject to the following two conditions:

(1) This device may not cause harmful interference, and (2) this device must accept any interference received, including interference that may cause undesired operation.

### 2) FCC 15.21

Warning: Changes or modifications to this unit not expressly approved by the part responsible for compliance could void the user's authority to operate the equipment.

### 3) FCC 15.105

For a Class B digital device or peripheral, the instructions furnished the user shall include the following or similar statement, placed in a prominent location in the text of the manual:

Note: This equipment has been tested and found to comply with the limits for a Class B digital device, pursuant to part 15 of the FCC Rules. These limits are designed to provide reasonable protection against harmful interference in a residential installation. This equipment generates, uses and can radiate radio frequency energy and, if not installed and used in accordance with the instructions, may cause harmful interference to radio communications. However, there is no guarantee that interference will not occur in a particular installation. If this equipment does cause harmful interference to radio or television reception, which can be determined by turning the equipment off and on, the user is encouraged to try to correct the interference by one or more of the following measures:

- Reorient or relocate the receiving antenna.
- Increase the separation between the equipment and receiver.
- Connect the equipment into an outlet on a circuit different from that to which the receiver is connected.
- Consult the dealer or an experienced radio/TV technician for help.

### 4) FCC RF Exposure- portable

This equipment complies with FCC radiation exposure limits set forth for an uncontrolled environment.

This equipment should be installed and operated with minimum distance 20cm between the radiator & your body.



## CHC Navigation

Building D, NO. 599 Gaojing Road,  
Qingpu District, 201702 Shanghai, China

Tel: +86 21 542 60 273 | Fax: +86 21 649 50 963  
Email: [sales@chcnav.com](mailto:sales@chcnav.com) | [support@chcnav.com](mailto:support@chcnav.com)  
Skype: chcnav\_support  
Website: [www.chcnav.com](http://www.chcnav.com)

Make your work more efficient