



# **FCC TEST REPORT**

**FCC ID: SY4-A01013**

On Behalf of

**Shanghai Huace Navigation Technology LTD.**

**Geodetic GNSS Receiver (E91)**

**Model No.: 1150082231145**

Prepared for : Shanghai Huace Navigation Technology LTD.  
Address : Building D, 599 Gaojing Road, Qingpu District, Shanghai, China

Prepared By : Shenzhen Alpha Product Testing Co., Ltd.  
Address : Building i, No.2, Lixin Road, Fuyong Street, Bao'an District,  
518103, Shenzhen, Guangdong, China

Report Number : T1881590 06  
Date of Receipt : October 12, 2018  
Date of Test : October 12, 2018- November 15, 2018  
Date of Report : November 20, 2018  
Version Number : REV0

## TABLE OF CONTENTS

Description	Page
<b>1. Summary of Standards And Results-----</b>	<b>5</b>
1.1. Description of Standards and Results -----	5
<b>2. General Information -----</b>	<b>6</b>
2.1. Description of Device (EUT)-----	6
2.2. Accessories of Device (EUT) -----	7
2.3. Tested Supporting System Details -----	7
2.4. Block Diagram of connection between EUT and simulators -----	7
2.5. Test Mode -----	8
2.6. Test Conditions -----	9
2.7. Test Facility -----	9
2.8. Measurement Uncertainty -----	10
2.9. Test Equipment List -----	11
<b>3. Test Results and Measurement Data -----</b>	<b>12</b>
3.1. Transmitter Power (Conducted)-----	12
3.2. Occupied Bandwidth and Emission Mask-----	13
3.3. Spurious Emissions(conducted) -----	19
3.4. Radiated Spurious Emission-----	22
3.5. Transient Frequency Behavior -----	27
3.6. Behavior Frequency Stability -----	30
3.7. Adjacent channel power-----	33
3.8. Modulation Characteristic -----	34
<b>4. Test setup photo-----</b>	<b>35</b>
4.1. Photos of Radiated emission -----	35
<b>5. Test setup photo-----</b>	<b>36</b>

### TEST REPORT DECLARATION

Applicant : Shanghai Huace Navigation Technology LTD.  
 Address : Building D, 599 Gaojing Road, Qingpu District, Shanghai, China  
 Manufacturer : Shanghai Huace Navigation Technology LTD.  
 Address : Building D, 599 Gaojing Road, Qingpu District, Shanghai, China  
 EUT Description : Geodetic GNSS Receiver (E91)  
 (A) Model No. : 1150082231145  
 (B) Trademark : 

Measurement Standard Used:

**FCC CFR Title 47 Part 90:2017, FCC CFR Title 47 Part 2:2017**

**ANSI C63.26: 2015**

The device described above is tested by Shenzhen Alpha Product Testing Co., Ltd. to determine the maximum emission levels emanating from the device. The maximum emission levels are compared to the FCC Part 2, Part 90 limits both conducted and radiated emissions. The test results are contained in this test report and Shenzhen Alpha Product Testing Co., Ltd. is assumed of full responsibility for the accuracy and completeness of these tests.

After the test, our opinion is that EUT compliance with the requirement of the above standards.

This report applies to above tested sample only. This report shall not be reproduced in parts without written approval of Shenzhen Alpha Product Testing Co., Ltd.

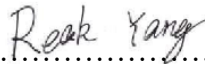
Tested by (name + signature).....: Reak Yang   
 Project Engineer

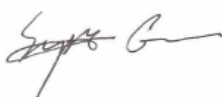
Approved by (name + signature).....: Simple Guan   
 Project Manager

Date of issue..... : November 20, 2018

**Revision History**

Revision	Issue Date	Revisions	Revised By
00	November 20, 2018	Initial released Issue	Simple Guan

## 1. SUMMARY OF STANDARDS AND RESULTS

### 1.1. Description of Standards and Results

The EUT have been tested according to the applicable standards as referenced below:

Test Item	Test Requirement	Standards Paragraph	Result
Transmitter Power(Conducted)	FCC PART 90:2017	§ 90.205	P
Occupied Bandwidth & Emission Mask	FCC PART 90:2017	§ 90.209, § 90.210	P
Spurious Emissions(conducted)	FCC PART 90:2017	§ 90.210	P
Spurious Emissions(Radiated)	FCC PART 90:2017	§ 90.210	P
Transient Frequency Behavior	FCC PART 90:2017	§ 90.213	P
Frequency Stability	FCC PART 90:2017	§ 90.214	P
Modulation Characteristics - Audio Frequency Response	FCC PART 2:2017 FCC PART 90:2017	§ 2.1047(a); § 90.207	N/A
Modulation Characteristics - Modulation Limiting	FCC PART 2:2017 FCC PART 90:2017	§ 2.1047(b); § 90.207	N/A
Note:	1. P is an abbreviation for Pass. 2. F is an abbreviation for Fail. 3. N/A is an abbreviation for Not Applicable.		

## 2. GENERAL INFORMATION

### 2.1. Description of Device (EUT)

Description : Geodetic GNSS Receiver ( E91 )

Model Number : 1150082231145

Note : 1. The model name“1150082231145”information not listed on marking plate at testing & certification stage, but will be listed in white rectangular frame of marking plate at MP stage.  
2. The model name“1150082231145”corresponding client's internal model is“Geodetic GNSS Receiver (E91) E91E-WSAC”.

Trademark : 

Test Voltage : DC 7.2V from battery or 9-36VDC, DC 12V From adapter

Operation frequency : 410MHz-470MHz

Bandwidth : 12.5KHz, 25KHz

Modulation type : GMSK

Antenna Type : External Antenna, Maximum Gain is 4dBi for UHF.

Software version : V1.0.29

Hardware version : V2.2

## 2.2. Accessories of Device (EUT)

Accessories1 : AC/DC SWITTHING ADAPTOR  
 Trademark : MW  
 Model : GST60A12  
 Ratings : Input:100-240V~, 50/60Hz, 1.4A;  
           Output: 12VDC, 5A, 60W MAX

## 2.3. Tested Supporting System Details

No.	Description	Manufacturer	Model	Serial Number	Certification or DOC
1	Notebook	ACER	ZQT	N/A	DOC

## 2.4. Block Diagram of connection between EUT and simulators

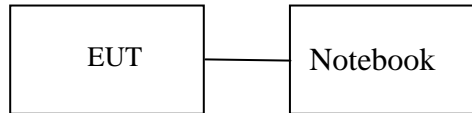

The sample was placed 0.8m & 1.5m for the measurement below & above 1GHz above the ground plane of 3m chamber. Measurements in both horizontal and vertical polarities were performed. During the test, each emission was maximized by: having the EUT continuously working, investigated all operating modes, rotated about all 3 axis (X, Y & Z) and considered typical configuration to obtain worst position, manipulating interconnecting cables, rotating the turntable, varying antenna height from 1m to 4m in both horizontal and vertical polarizations. The emissions worst-case are shown in Test Results of the following pages.

## 2.5. Test Mode

All modes and data rates and positions were investigated.

Test modes are chosen to be reported as the worst case configuration below:

Test Mode		
Item	Description of operation mode	Note
1	GMSK+BW12.5KHz+TX	at maximum rated power for transmitter
2	GMSK+BW12.5KHz+TX	at minimum rated power for transmitter
3	GMSK+BW25KHz+TX	at maximum rated power for transmitter
4	GMSK+BW25KHz+TX	at minimum rated power for transmitter

Note: The worst case modes for all test are the item 1 and item 3.

### Description Operation Frequency

QMSK			
Test Channel	BW(MHz)	Channel	Frequency(MHz)
Low	12.5	1	410.125
	25	2	410.250
Mid	12.5	3	456.125
	25	4	456.250
High	12.5	5	469.975
	25	6	469.850



## 2.6. Test Conditions

Items	Required	Actual
Temperature range:	15-35°C	27°C
Humidity range:	25-75%	56%
Pressure range:	86-106kPa	98kPa

## 2.7. Test Facility

Shenzhen Alpha Product Testing Co., Ltd  
Building i, No.2, Lixin Road, Fuyong Street, Bao'an District,  
518103, Shenzhen, Guangdong, China

June 21, 2018 File on Federal Communication Commission  
Registration Number: 293631

July 25, 2017 Certificated by IC  
Registration Number: 12135A

## 2.8.Measurement Uncertainty

(95% confidence levels, k=2)

Item	Uncertainty
Uncertainty for Power point Conducted Emissions Test	2.74dB
Uncertainty for Radiation Emission test in 3m chamber (below 30MHz)	2.13 dB(Polarize: V)
	2.57dB(Polarize: H)
Uncertainty for Radiation Emission test in 3m chamber (30MHz to 1GHz)	3.77dB(Polarize: V)
	3.80dB(Polarize: H)
Uncertainty for Radiation Emission test in 3m chamber (1GHz to 25GHz)	4.16dB(Polarize: H)
	4.13dB(Polarize: V)
Uncertainty for radio frequency	$5.4 \times 10^{-8}$
Uncertainty for conducted RF Power	0.37dB
Uncertainty for temperature	0.2°C
Uncertainty for humidity	1%
Uncertainty for DC and low frequency voltages	0.06%

## 2.9. Test Equipment List

Equipment	Manufacturer	Model No.	Serial No.	Last cal.	Cal Interval
Test Receiver	ROHDE&SCHWARZ	ESCI	101165	2018.09.21	1 Year
Spectrum analyzer	ROHDE&SCHWARZ	FSU	1166.1660.26	2018.09.21	1 Year
Horn Antenna	SCHWARZBECK	BBHA 9120 D	BBHA 9120 D(1201)	2018.09.21	1 Year
Filter	KANGMAI	ZLPP-LDC-1000- 1959	1209002075	2018.09.21	1 Year
RF Cable	Resenberger	Cable 4	N/A	2018.09.21	1 Year
Signal Analyzer	Agilent	N9020A	MY499100060	2018.09.11	1 Year
vector Signal Generator	Agilent	N5182A	MY49060042	2018.09.11	1 Year
vector Signal Generator	Agilent	E4438C	US44271917	2018.09.11	1 Year
Amplifier	Agilent	8449B	3008A02664	2018.09.21	1 Year
Test Receiver	ROHDE&SCHWARZ	ESR	1316.3003K03-102082-Wa	2018.09.21	1 Year
Bilog Antenna	SCHWARZBECK	VULB 9168	9168-438	2018.04.13	1 Year
9*6*6 anechoic chamber	CHENYU	9*6*6	N/A	/	/
RF Cable	Resenberger	Cable 1	N/A	2018.09.21	1 Year
RF Cable	Resenberger	Cable 2	N/A	2018.09.21	1 Year
RF Cable	Resenberger	Cable 3	N/A	2018.09.21	1 Year
Loop Antenna	SCHWARZBECK	FMZB 1519B	00059	2018.09.26	2 Year
Temperature& Humidity test chamber	GZGONGWEN	GDS-250	080821	2018.10.21	1 Year
Power Meter	Agilent	E9300A	MY41496625	2018.09.21	1 Year
Oscilloscope	Agilent	54833A	165521	2018.09.21	1 Year
20dB Attenuator	ICPROBING	IATS1	82347	2018.09.21	1 Year
L.I.S.N.#1	Schwarzbeck	NSLK8126	8126466	2018.09.21	1 Year
L.I.S.N.#2	ROHDE&SCHWARZ	ENV216	101043	2018.09.21	1 Year

The actual height is 1.5m less than reference HAAT

### 3. Test Results and Measurement Data

#### 3.1. Transmitter Power (Conducted)

##### 3.1.1. Test Specification

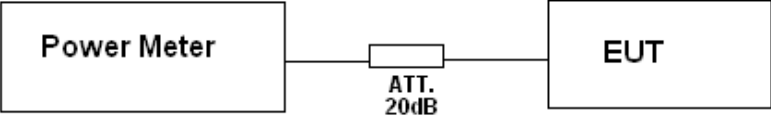
<b>Test Requirement:</b>	Part 90.205:
<b>Test Method:</b>	FCC part 2.1046
<b>Limits:</b>	Please refer section FCC Part 90.205
<b>Test Setup:</b>	 <pre> graph LR     PM[Power Meter] --- ATT[ATT. 20dB]     ATT --- EUT[EUT]           </pre>
<b>Test Procedure:</b>	a) Connect the equipment as illustrated. b) Turn on the power meter c) Record value
<b>Test Result:</b>	PASS

##### 3.1.2. Test Results

GMSK mode						
Test channel	Maximum Conducted Output Power(AVG) (dBm)	Maximum Conducted Output Power(Peak) (dBm)	Maximum ERP(dBm)	Stated ERP Power (dBm)	Limit (dBm)	Result
1	27.29	30.89	32.74	33	33	PASS
2	27.25	30.81	32.66	33	33	PASS
3	27.27	30.88	32.73	33	33	PASS
4	27.26	30.83	32.68	33	33	PASS
5	27.21	30.86	32.71	33	33	PASS
6	27.23	30.88	32.73	33	33	PASS

ERP= Maximum Conducted Output Power(Peak) + Antenna Gain – 2.15dB

### 3.2. Occupied Bandwidth and Emission Mask

#### 3.2.1. Test Specification

<b>Test Requirement:</b>	FCC Part 90.209, FCC Part 90.210
<b>Test Setup:</b>	 <p>The diagram shows a green Spectrum Analyzer on the left connected by a cable to a yellow EUT (Equipment Under Test) on the right. A small white box is positioned between the two devices on the cable.</p> <p><b>Spectrum Analyzer</b> <span style="margin-left: 200px;"><b>EUT</b></span></p>
<b>Test Procedure:</b>	The resolution bandwidth of the spectrum analyzer was set at 300 Hz and the spectrum was recorded in the Frequency band $\pm 50\text{KHz}$ from the carrier frequency.
<b>Test Result:</b>	PASS

## 3.2.2. Test data

**Occupied Bandwidth:**

Channel	Frequency (MHz)	26dB Bandwidth (KHz)	99% Occupied Bandwidth (KHz)	Result
GMSK 12.5KHz Channel Spacing:				
1	410.125	9.78	7.00	PASS
2	456.125	9.25	7.05	PASS
3	469.975	9.65	7.10	PASS

Channel	Frequency (MHz)	26dB Bandwidth (KHz)	99% Occupied Bandwidth (KHz)	Result
GMSK 25KHz Channel Spacing:				
4	410.250	18.00	15.46	PASS
5	456.250	19.90	15.90	PASS
6	469.850	19.80	15.80	PASS

**Emission Mask:**

Channel	Frequency (MHz)	Applicable Mask	RBW	Result
GMSK 12.5KHz Channel Spacing:				
1	410.125	D	300	PASS
2	456.125	D	300	PASS
3	469.975	D	300	PASS

Channel	Frequency (MHz)	Applicable Mask	RBW	Result
GMSK 25KHz Channel Spacing:				
4	410.250	B	300	PASS
5	456.250	B	300	PASS
6	469.850	B	300	PASS

Test plots as follows:

**GMSK mode: Occupied Bandwidth**

Channel 1

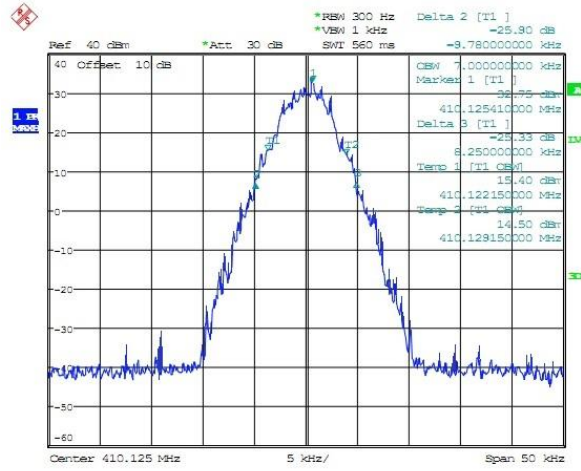

Channel 2

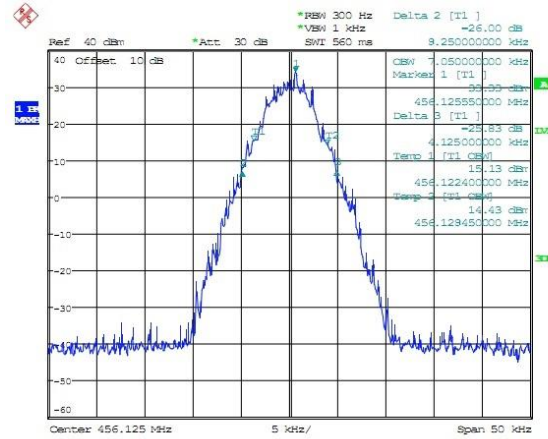

Channel 3

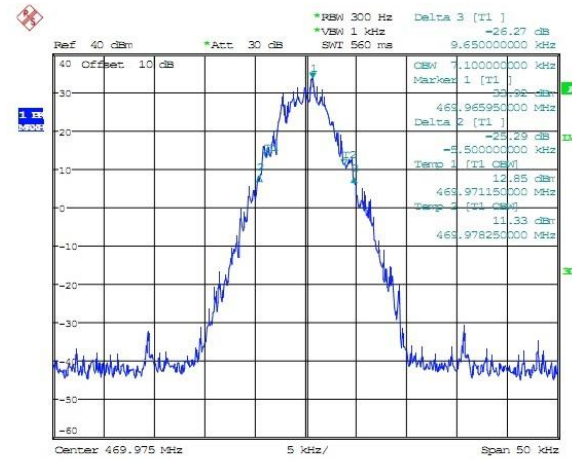

### Channel 4

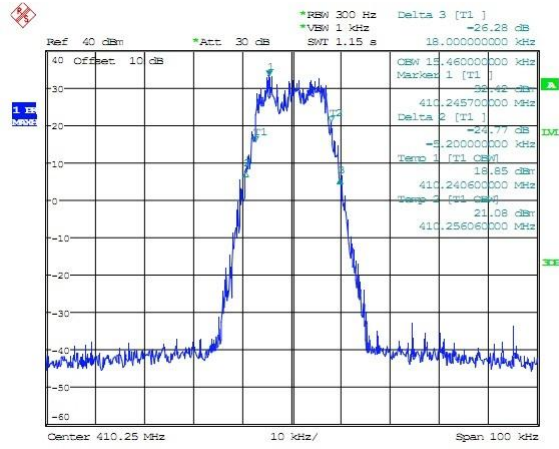

### Channel 5

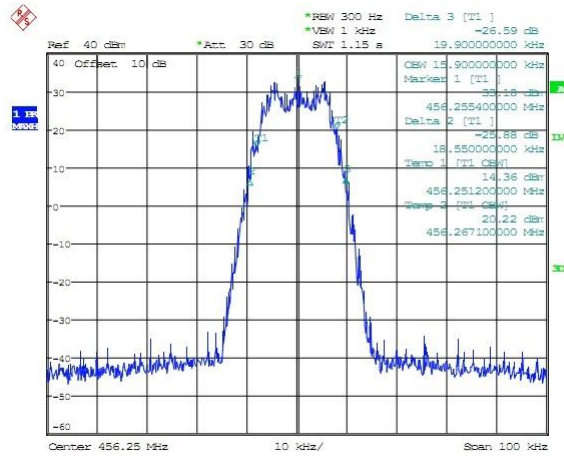

### Channel 6

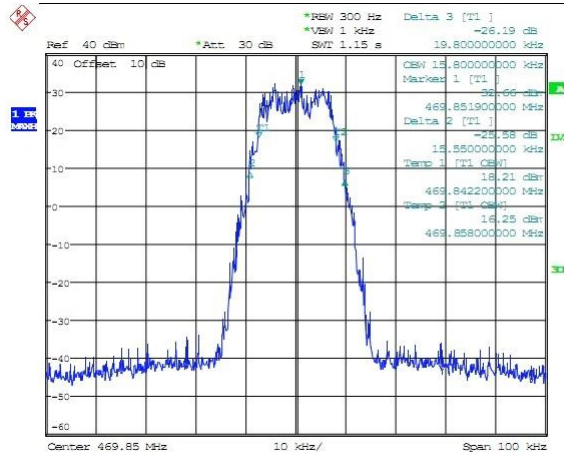



GMSK mode: Emission Mask

Channel 1

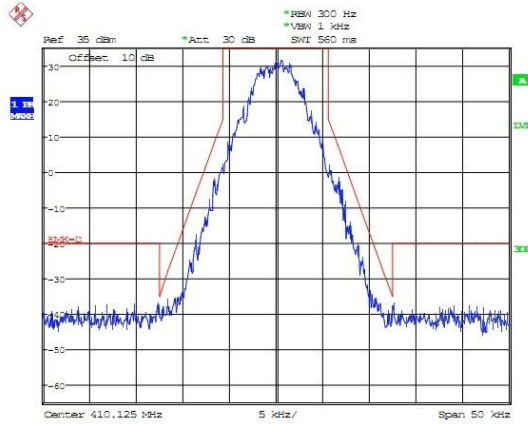

Channel 2

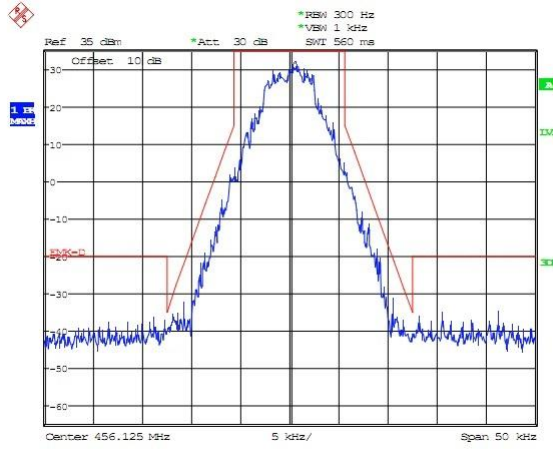

Channel 3

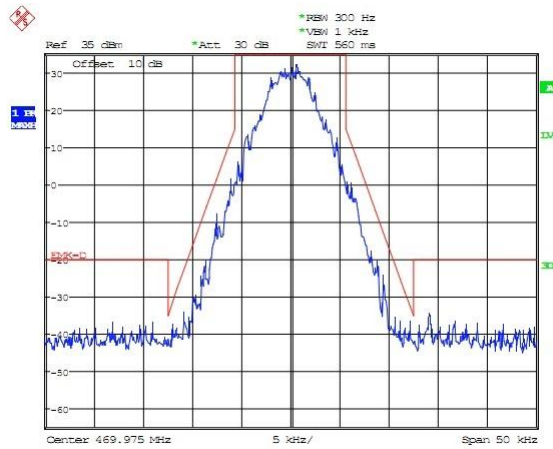

### Channel 4

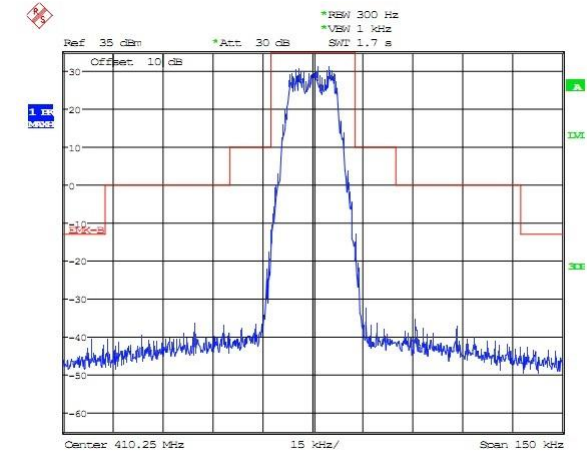

### Channel 5

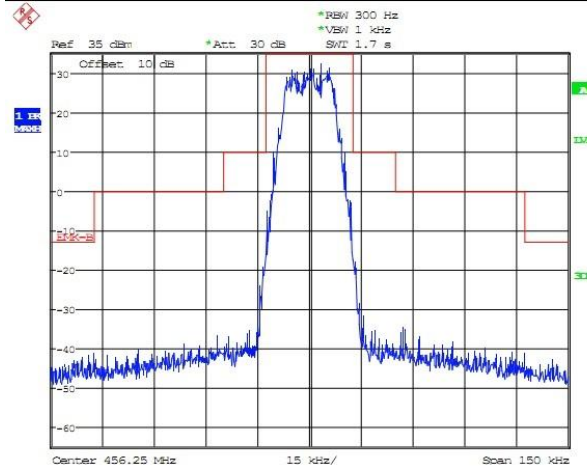

### Channel 6

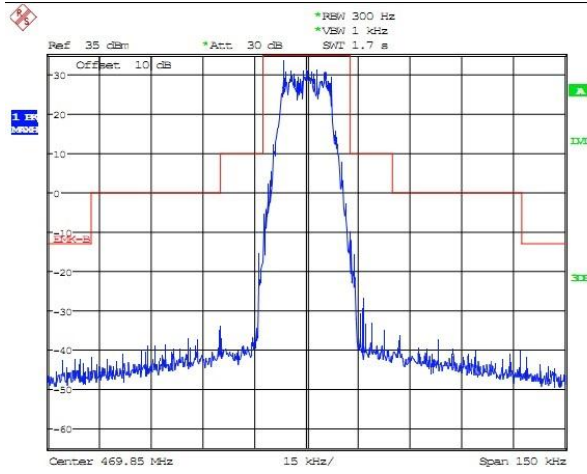

### 3.3. Spurious Emissions(conducted)

#### 3.3.1.Test Specification

<b>Test Requirement:</b>	FCC Part 90.210
<b>Test Setup:</b>	 <p style="text-align: center;"><b>Spectrum Analyzer</b>                      <b>EUT</b></p>
<b>Test Limit:</b>	<p>Modulation Type: GMSK  FCC Part 22.359, 74.462, 80.211 and 90.210 and RSS Gen, RSS 119 Issue 12:  For 12.5KHz, 25kHz bandwidth:  On any frequency removed from the center of the authorized bandwidth by a displacement frequency (<math>f_d</math> in kHz) of more than 12.5 kHz at least:  High: <math>50 + 10 \log(P_{\text{watts}}) = 50 + 10 \log(3.0) = 54.77 \text{ dB}</math>  Low: <math>50 + 10 \log(P_{\text{watts}}) = 50 + 10 \log(1.0) = 50.00 \text{ dB}</math>  Note: In general, the worst case attenuation requirement shown above was applied.  Calculation: Limit (dBm) = EL - 50 - 10log<sub>10</sub>(TP)  Notes: EL is the emission level of the Output Power expressed in dBm,  In this application, the EL is 34.77 dBm for High rated power and 30.00 for lower rated power.  High: Limit (dBm) = <math>34.77 - 50 - 10 \log(3.0) = -20 \text{ dBm}</math>  Low: Limit (dBm) = <math>30.00 - 50 - 10 \log(1.0) = -20 \text{ dBm}</math>  Note: 1. In general, the worst case attenuation requirement shown above was applied.  2. The measurement frequency range from 9 KHz to 5 GHz.  3. *** means that the emission level is too low to be measured or at least 20 dB down than the limit.  4. ERP for below 1GHz and EIRP above 1GHz.</p>
<b>Test Result:</b>	PASS

#### 3.3.2.Test data

Test plots as follows:  
GMSK mode

Channel 1

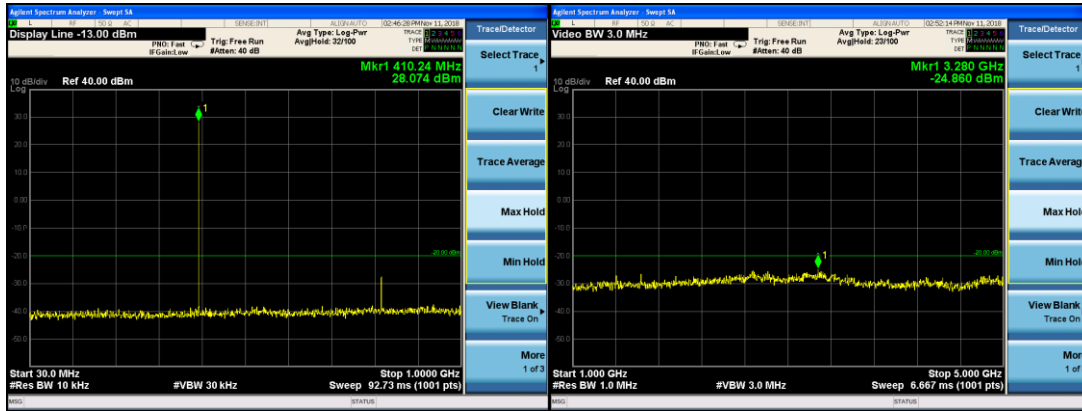

Channel 2

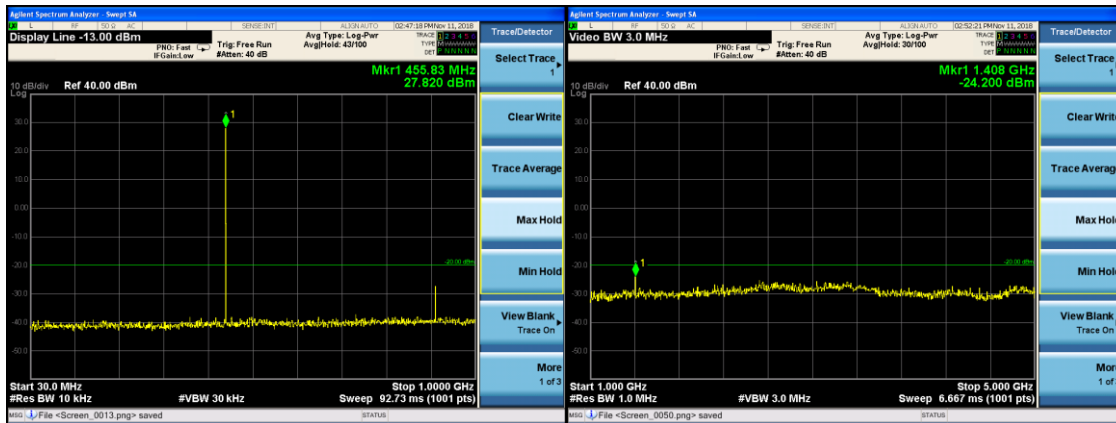

Channel 3

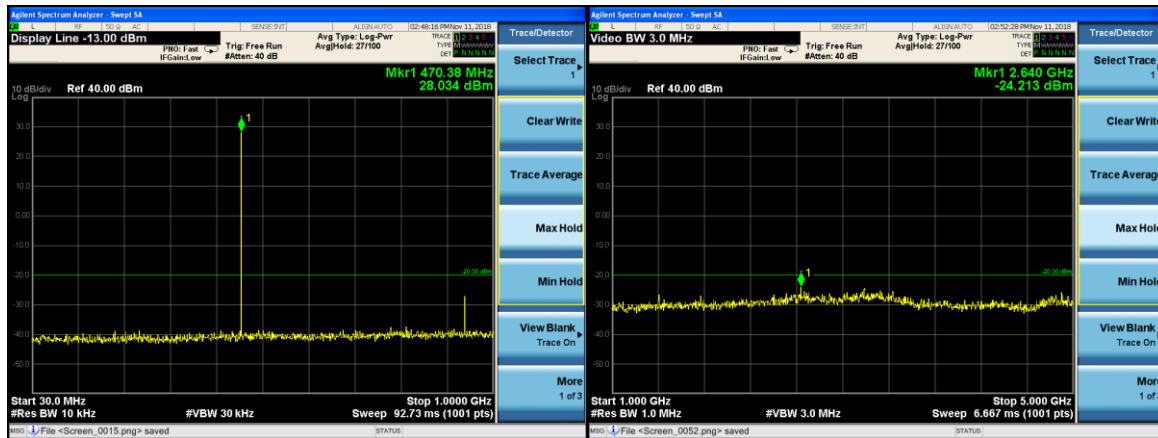

### Channel 4

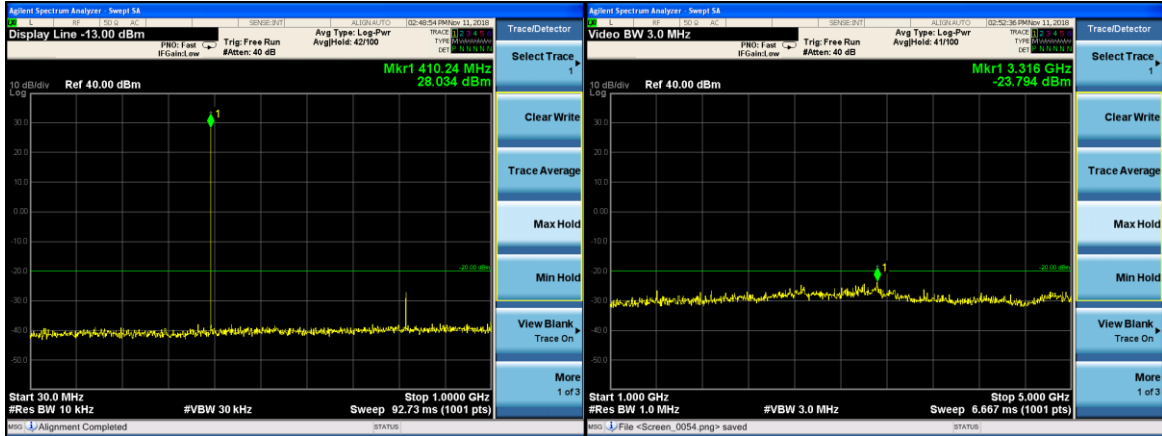

### Channel 5

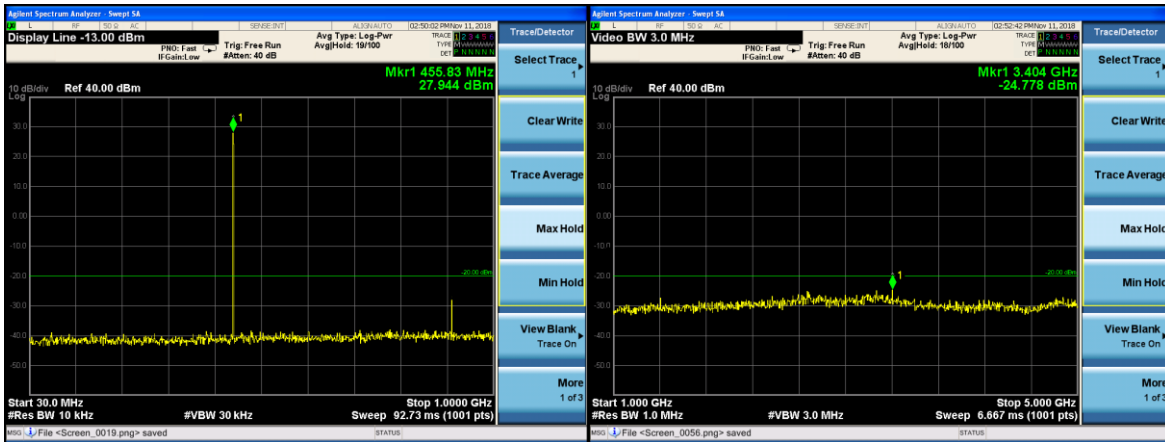

### Channel 6

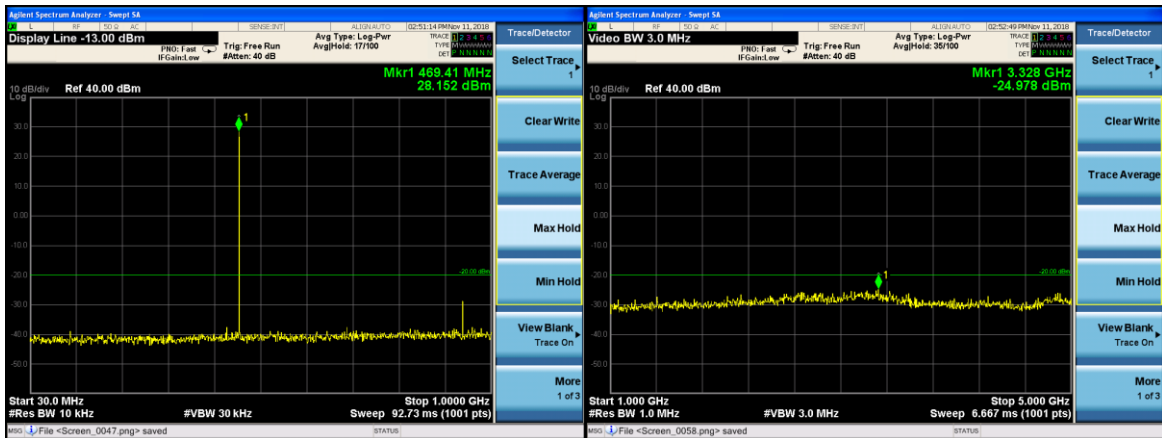

### 3.4. Radiated Spurious Emission

#### 3.4.1. Test Specification

<b>Test Requirement:</b>	FCC Part 90.210															
<b>Test Method:</b>	ANSI C63.26															
<b>Measurement Distance:</b>	3 m															
<b>Antenna Polarization:</b>	Horizontal & Vertical															
<b>Operation mode:</b>	Refer to item 4.1															
<b>Receiver Setup:</b>	<table border="1"> <thead> <tr> <th>Frequency</th> <th>RBW</th> <th>VBW</th> </tr> </thead> <tbody> <tr> <td>9kHz- 150kHz</td> <td>200Hz</td> <td>1kHz</td> </tr> <tr> <td>150kHz- 30MHz</td> <td>9kHz</td> <td>30kHz</td> </tr> <tr> <td>30MHz-1GHz</td> <td>100kHz</td> <td>300kHz</td> </tr> <tr> <td>Above 1GHz</td> <td>1MHz</td> <td>3MHz</td> </tr> </tbody> </table>	Frequency	RBW	VBW	9kHz- 150kHz	200Hz	1kHz	150kHz- 30MHz	9kHz	30kHz	30MHz-1GHz	100kHz	300kHz	Above 1GHz	1MHz	3MHz
Frequency	RBW	VBW														
9kHz- 150kHz	200Hz	1kHz														
150kHz- 30MHz	9kHz	30kHz														
30MHz-1GHz	100kHz	300kHz														
Above 1GHz	1MHz	3MHz														
<b>Limit:</b>	<p>For equipment using 25 kHz channel spacing, on any frequency removed from the center of the authorized bandwidth by more than 250 percent of the authorized bandwidth: At least <math>43 + 10 \log(P)</math> dB.</p> <p>For equipment using 12.5 kHz channel spacing, on any frequency removed from the center of the authorized bandwidth by a displacement frequency (<math>f_d</math> in kHz) of more than 12.5 kHz: At least <math>50 + 10 \log(P)</math> dB or 70 dB, whichever is the lesser attenuation.</p>															
<b>Test setup:</b>	<p>The diagram shows a 'RECEIVER UNDER TEST' on a 'TURNTABLE' within a 'STANDARD TEST SITE'. A 'Receiver Antenna' is connected to the receiver, and a 'Test Antenna' is connected to a 'SPECTRUM ANALYZER'.</p>															
<b>Test Procedure:</b>	<p>The transmitter was placed on a wooden turntable, and it was transmitting into a non-radiating load, which was also placed on the turntable.</p> <p>The measurement antenna was placed at a distance of 3 meters from the EUT. During the tests, the antenna height and polarization as well as EUT azimuth were varied in order to identify the maximum level of emissions from the EUT. The test was performed by placing the EUT on 3-orthogonal axis.</p> <p>The frequency range up to teeth harmonic of the fundamental frequency was investigated.</p> <p>Remove the EUT and replace it with substitution antenna. A signal</p>															

	<p>generator was connected to the substitution antenna by a non-radiating cable. The absolute levels of the spurious emissions were measured by the substitution.</p> <p>Spurious emissions in dB =10, 1g (TXpwr in Watts/0.001)-the absolute level</p> <p>Spurious attenuation limit in dB =50+10 Log<sub>10</sub> (power out in Watts) for EUT with a 12.5, 25 kHz channel bandwidth.</p>
<b>Test results:</b>	PASS

## 3.4.2.Test Data

Test Mode: Channel 1, Channel Spacing 12.5KHz

Frequency (MHz)	Reading level (dBm)	Antenna Polarization	Cable loss (dB)	Ant.Gain (dBi)	Emission level (dBm)	Limit (dBm)	Margin (dB)
155.625	-93.37	V	0.24	31.35	-62.26	-20	-42.26
367.934	-92.56	V	0.26	31.34	-61.48	-20	-41.48
680.987	-93.96	V	0.42	31.24	-63.14	-20	-43.14
872.655	-92.66	V	0.58	30.71	-62.53	-20	-42.53
1268.728	-82.04	V	1.23	26.38	-56.89	-20	-36.89
3867.003	-80.84	V	1.68	25.47	-57.05	-20	-37.05
287.796	-94.48	H	0.43	31.24	-63.67	-20	-43.67
404.697	-95.22	H	0.45	30.68	-64.99	-20	-44.99
483.858	-93.87	H	0.64	30.85	-63.66	-20	-43.66
680.795	-95.89	H	0.79	31.12	-65.56	-20	-45.56
1373.138	-81.64	H	1.29	26.12	-56.81	-20	-36.81
3259.416	-80.62	H	1.62	25.41	-56.83	-20	-36.83

Test Mode: Channel 2, Channel Spacing 12.5KHz

Frequency (MHz)	Reading level (dBm)	Antenna Polarization	Cable loss (dB)	Ant.Gain (dBi)	Emission level (dBm)	Limit (dBm)	Margin (dB)
155.510	-92.62	V	0.24	31.35	-61.51	-20	-41.51
368.909	-92.12	V	0.26	31.34	-61.04	-20	-41.04
674.206	-93.34	V	0.42	31.24	-62.52	-20	-42.52
866.578	-92.98	V	0.58	30.71	-62.85	-20	-42.85
1269.367	-81.74	V	1.23	26.38	-56.59	-20	-36.59
3867.595	-79.33	V	1.68	25.47	-55.54	-20	-35.54
297.180	-93.18	H	0.43	31.24	-62.37	-20	-42.37
404.750	-94.55	H	0.45	30.68	-64.32	-20	-44.32
485.384	-93.78	H	0.64	30.85	-63.57	-20	-43.57
689.651	-95.12	H	0.79	31.12	-64.79	-20	-44.79
1377.819	-80.81	H	1.29	26.12	-55.98	-20	-35.98
3263.467	-79.94	H	1.62	25.41	-56.15	-20	-36.15



Test Mode: Channel 3, Channel Spacing 12.5KHz

Frequency (MHz)	Reading level (dBm)	Antenna Polarization	Cable loss (dB)	Ant.Gain (dBi)	Emission level (dBm)	Limit (dBm)	Margin (dB)
155.374	-92.42	V	0.24	31.35	-61.31	-20	-41.31
368.783	-91.84	V	0.26	31.34	-60.76	-20	-40.76
675.570	-94.33	V	0.42	31.24	-63.51	-20	-43.51
872.668	-92.36	V	0.58	30.71	-62.23	-20	-42.23
1267.582	-81.71	V	1.23	26.38	-56.56	-20	-36.56
3861.697	-80.56	V	1.68	25.47	-56.77	-20	-36.77
293.358	-93.96	H	0.43	31.24	-63.15	-20	-43.15
406.280	-95.37	H	0.45	30.68	-65.14	-20	-45.14
476.554	-93.88	H	0.64	30.85	-63.67	-20	-43.67
679.697	-95.22	H	0.79	31.12	-64.89	-20	-44.89
1381.119	-80.62	H	1.29	26.12	-55.79	-20	-35.79
3268.070	-79.35	H	1.62	25.41	-55.56	-20	-35.56

Test Mode: Channel 4, Channel Spacing 25KHz

Frequency (MHz)	Reading level (dBm)	Antenna Polarization	Cable loss (dB)	Ant.Gain (dBi)	Emission level (dBm)	Limit (dBm)	Margin (dB)
158.633	-92.20	V	0.24	31.35	-61.09	-13	-48.09
366.772	-91.26	V	0.26	31.34	-60.18	-13	-47.18
678.052	-93.64	V	0.42	31.24	-62.82	-13	-49.82
871.526	-92.72	V	0.58	30.71	-62.59	-13	-49.59
1261.935	-82.25	V	1.23	26.38	-57.10	-13	-44.1
3861.985	-79.80	V	1.68	25.47	-56.01	-13	-43.01
293.318	-94.13	H	0.43	31.24	-63.32	-13	-50.32
406.202	-94.85	H	0.45	30.68	-64.62	-13	-51.62
483.612	-93.85	H	0.64	30.85	-63.64	-13	-50.64
684.790	-95.23	H	0.79	31.12	-64.90	-13	-51.9
1373.242	-81.60	H	1.29	26.12	-56.77	-13	-43.77
3267.779	-79.68	H	1.62	25.41	-55.89	-13	-42.89

Test Mode: Channel 5, Channel Spacing 25KHz

Frequency (MHz)	Reading level (dBm)	Antenna Polarization	Cable loss (dB)	Ant.Gain (dBi)	Emission level (dBm)	Limit (dBm)	Margin (dB)
166.629	-91.80	V	0.24	31.35	-60.69	-13	-47.69
366.437	-91.56	V	0.26	31.34	-60.48	-13	-47.48
671.019	-93.65	V	0.42	31.24	-62.83	-13	-49.83
865.092	-92.43	V	0.58	30.71	-62.30	-13	-49.3
1268.186	-82.16	V	1.23	26.38	-57.01	-13	-44.01
3866.795	-80.27	V	1.68	25.47	-56.48	-13	-43.48
289.197	-93.02	H	0.43	31.24	-62.21	-13	-49.21
412.992	-94.12	H	0.45	30.68	-63.89	-13	-50.89
473.334	-94.65	H	0.64	30.85	-64.44	-13	-51.44
684.429	-95.59	H	0.79	31.12	-65.26	-13	-52.26
1370.828	-81.56	H	1.29	26.12	-56.73	-13	-43.73
3261.481	-80.37	H	1.62	25.41	-56.58	-13	-43.58

Test Mode: Channel 6, Channel Spacing 25KHz

Frequency (MHz)	Reading level (dBm)	Antenna Polarization	Cable loss (dB)	Ant.Gain (dBi)	Emission level (dBm)	Limit (dBm)	Margin (dB)
159.246	-92.15	V	0.24	31.35	-61.04	-13	-48.04
364.232	-92.33	V	0.26	31.34	-61.25	-13	-48.25
676.511	-93.91	V	0.42	31.24	-63.09	-13	-50.09
867.775	-93.05	V	0.58	30.71	-62.92	-13	-49.92
1266.821	-80.60	V	1.23	26.38	-55.45	-13	-42.45
3866.753	-79.90	V	1.68	25.47	-56.11	-13	-43.11
295.937	-94.22	H	0.43	31.24	-63.41	-13	-50.41
407.000	-94.79	H	0.45	30.68	-64.56	-13	-51.56
482.067	-94.34	H	0.64	30.85	-64.13	-13	-51.13
685.198	-95.83	H	0.79	31.12	-65.50	-13	-52.50
1375.470	-81.78	H	1.29	26.12	-56.95	-13	-43.95
3266.395	-79.29	H	1.62	25.41	-55.50	-13	-42.50

### 3.5. Transient Frequency Behavior

#### 3.5.1. Test Specification

<b>Test Requirement:</b>	FCC Part 90.214																																				
<b>Test Setup:</b>	 <p style="text-align: center;">Oscilloscope                      EUT</p>																																				
<b>Test Limit</b>	<table border="1"> <thead> <tr> <th rowspan="3">Frequency Range</th> <th rowspan="3">Channel Bandwidth</th> <th colspan="3">Frequency Tolerance (ppm)</th> </tr> <tr> <th rowspan="2">Fixed and Base Station</th> <th colspan="2">Mobile Stations</th> </tr> <tr> <th>&gt; 2W</th> <th>≤ 2W</th> </tr> </thead> <tbody> <tr> <td rowspan="3">150-174MHz</td> <td>6.25</td> <td>1.0</td> <td>2.0</td> <td>2.0</td> </tr> <tr> <td>12.5</td> <td>2.5</td> <td>5.0</td> <td>5.0</td> </tr> <tr> <td>25</td> <td>5.0</td> <td>5.0</td> <td>50.0*</td> </tr> <tr> <td rowspan="3">421-512MHz</td> <td>6.25</td> <td>0.5</td> <td>1.0</td> <td>1.0</td> </tr> <tr> <td>12.5</td> <td>1.5</td> <td>2.5</td> <td>2.5</td> </tr> <tr> <td>25</td> <td>2.5</td> <td>5.0</td> <td>5.0</td> </tr> </tbody> </table> <p>* Stations operating in the 154.45 MHz or the 173.2 to 173.4 MHz bands must have a frequency stability of 5 ppm.  * Paging transmitters operating on paging-only frequencies must operate with frequency stability of 5 ppm in the 150-174 MHz band and 2.5 ppm in the 421-512 MHz band.</p>	Frequency Range	Channel Bandwidth	Frequency Tolerance (ppm)			Fixed and Base Station	Mobile Stations		> 2W	≤ 2W	150-174MHz	6.25	1.0	2.0	2.0	12.5	2.5	5.0	5.0	25	5.0	5.0	50.0*	421-512MHz	6.25	0.5	1.0	1.0	12.5	1.5	2.5	2.5	25	2.5	5.0	5.0
Frequency Range	Channel Bandwidth			Frequency Tolerance (ppm)																																	
				Fixed and Base Station	Mobile Stations																																
		> 2W	≤ 2W																																		
150-174MHz	6.25	1.0	2.0	2.0																																	
	12.5	2.5	5.0	5.0																																	
	25	5.0	5.0	50.0*																																	
421-512MHz	6.25	0.5	1.0	1.0																																	
	12.5	1.5	2.5	2.5																																	
	25	2.5	5.0	5.0																																	
<b>Test Procedure:</b>	<p>The EUT was set in the climate chamber and connected to an external DC power supply and AC power supply. The RF output was directly connected to oscilloscope. The coupling loss of the additional cables was recorded and taken in account for all the measurements. After temperature stabilization (approx. 20 min for each stage), the frequency for the lower, the middle and the highest frequency range was recorded. For Frequency stability Vs. Voltage the EUT was connected to a DC power supply or AC power supply and the voltage was adjusted in the required ranges. The result was recorded.</p>																																				
<b>Test Result:</b>	PASS																																				

### 3.5.2. Test data

Test Plots for channel spacing 25KHz, EUT power setting: Maximum.

Power On

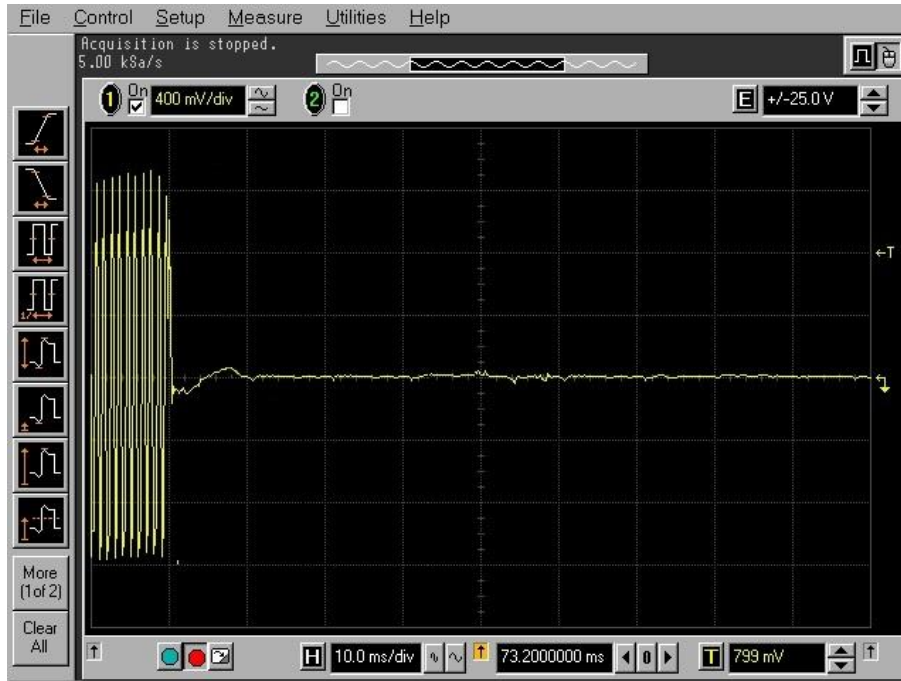

Power Off

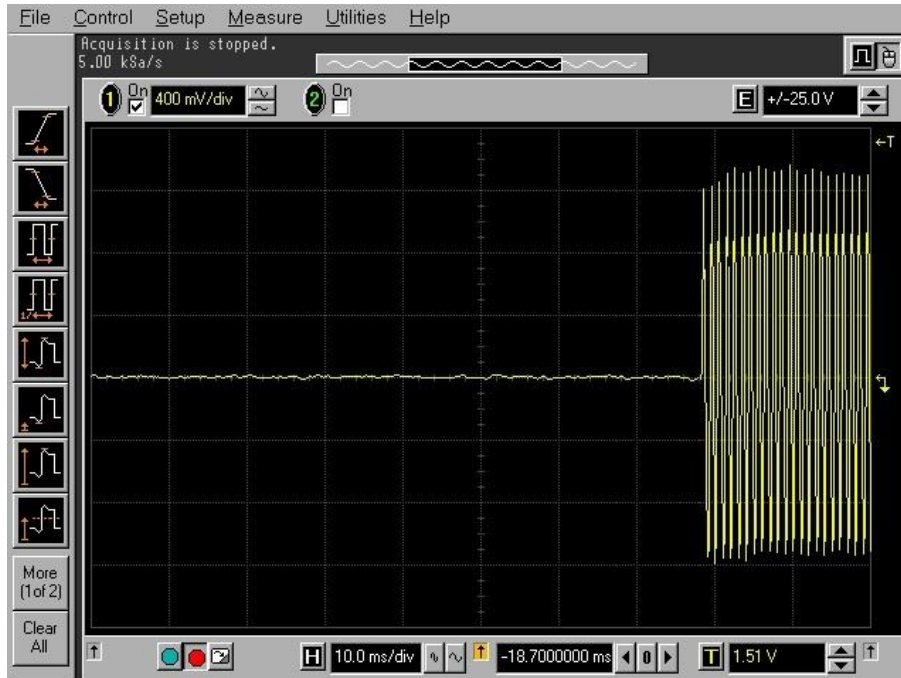

Test Plots for channel spacing 12.5KHz. EUT power setting: Maximum  
Power On

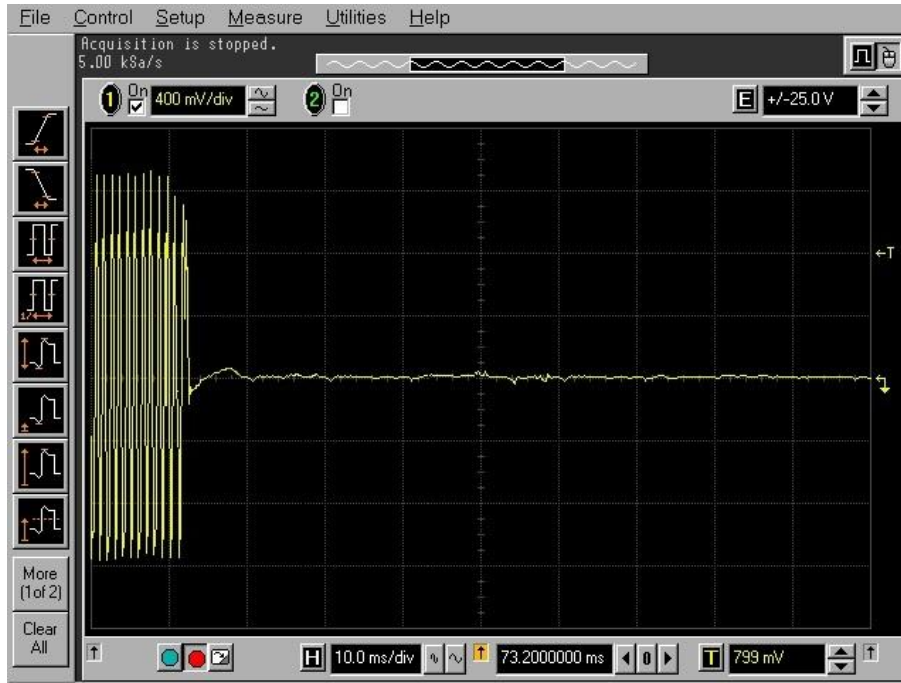

Power Off

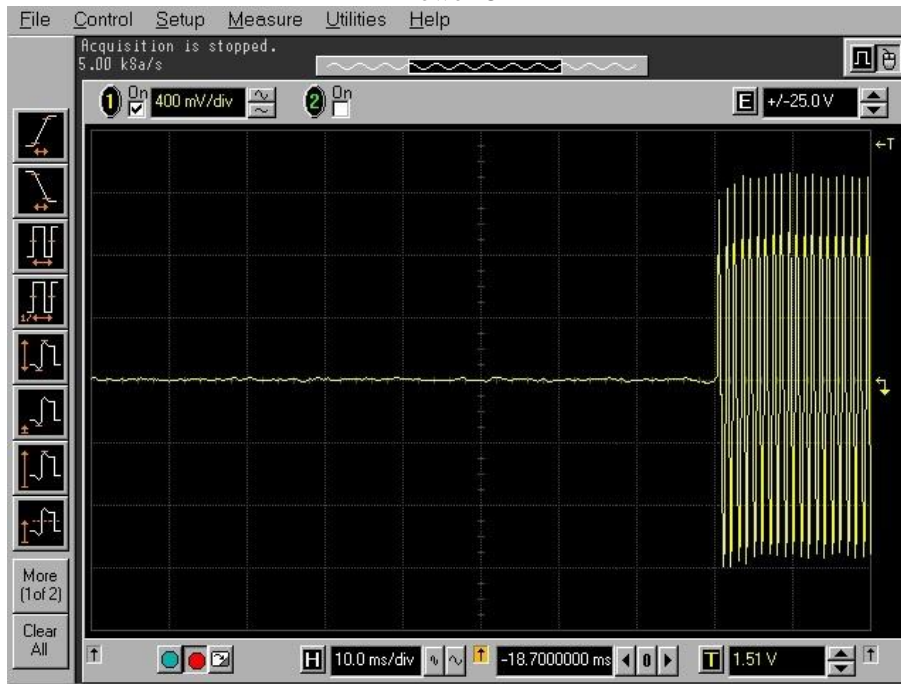

### 3.6. Behavior Frequency Stability

#### 3.6.1. Test Specification

<b>Test Requirement:</b>	FCC Part 90.213
<b>Test Method:</b>	ANSI C63.26
<b>Test Setup:</b>	<pre> graph TD     Laptop[Laptop] --- EUT[Equipment Under Test]     EUT --- ACDC[AC/DC Adapter]     EUT --- Att[Attenuator(s)]     Att --- MC[Mini-Circuit Combiner]     RFCT[RF Communication Test Set] --- MC     MC --- RF[RF Detector]     MC --- MA[Modulation Analyzer]     RF --- HPO[Hewlett Packard Infinium Digitizing Oscilloscope]   </pre>
<b>Test Procedure:</b>	<p>Method of Measurement (using a Modulation Domain Analyzer).  The output of the EUT was connected to a power meter in order to get a reference power measurement. And the reference level is -20dBm. Once the reference power measurement was determined, an external signal source was connected to the Modulation Domain Analyzer in order to set the trigger level.</p> <p>The EUT was connected to the Modulation Domain Analyzer. In order to capture a single-shot turn-on of the transmitter signal, the modulation domain analyzer was set to trigger on the rising edge of the waveform. Plots were taken.</p> <p>The modulation domain analyzer was then adjusted to trigger on the falling edge of the transmitter waveform in order to capture a single-shot turn-off transient of the transmitter signal. Plots were taken.</p>
<b>Test Result:</b>	PASS

## 3.6.2. Test data

Conclusion: PASS			
Mode	Voltage (V)	Frequency error (Hz)	frequency error (ppm)
Middle Channel 12.5KHz Channel Spacing	7.2V	-40	-0.098
	7.0V	-40	-0.098
	6.8V	-40	-0.098
	6.6V	-40	-0.098
Limit	<b>2.5ppm</b>		
Middle Channel 25KHz Channel Spacing	7.2V	-45	-0.110
	7.0V	-45	-0.110
	6.8V	-45	-0.110
	6.6V	-45	-0.110
Limit	<b>5ppm</b>		
Mode	Temperature (°C)	Frequency error (Hz)	frequency error (ppm)
Middle Channel 12.5KHz Channel Spacing	-30	-28	-0.0685
	-20	-26	-0.0637
	-10	-49	-0.1200
	0	-16	-0.0382
	10	-27	-0.0652
	20	-43	-0.1052
	30	-21	-0.0517
	40	-18	-0.0439
	50	-25	-0.0601
Limit	<b>2.5ppm</b>		
Middle Channel 25KHz Channel Spacing	-30	-27	-0.0663
	-20	-24	-0.0583
	-10	-53	-0.1303
	0	-21	-0.0516
	10	-25	-0.0598
	20	-43	-0.1042
	30	-25	-0.0616
	40	-20	-0.0491
	50	-19	-0.0469
Limit	<b>5ppm</b>		





### 3.7. Adjacent channel power

#### 3.7.1. Test Specification

<b>Test Requirement:</b>	FCC Part 90.221		
<b>Test Setup:</b>	 <p style="text-align: center;"> <span style="margin-right: 100px;"><b>Spectrum Analyzer</b></span> <span><b>EUT</b></span> </p>		
<b>Test Limit:</b>	Frequency offset	Maximum ACP (dBc) for devices 1 watt and less	Maximum ACP (dBc) for devices above 1 watt
	25 kHz	-55 dBc	-60 dBc
	50 kHz	-70 dBc	-70 dBc
	75 kHz	-70 dBc	-70 dBc
<b>Test Result:</b>	PASS		

#### 3.7.2. Test Data

Channel	Channel Separation (kHz)	Adjacent Channel (kHz)	Adjacent Channel Ratio(dBm/dB)	Limit (dBc)
CH Low	25	-25	-72.5	-60
		+25	-72.4	-60
CH Middle	25	-25	-73.1	-60
		+25	-73	-60
CH High	25	-25	-71.9	-60
		+25	-71.7	-60

### 3.8. Modulation Characteristic

<b>Test Requirement:</b>	FCC Part 90.207
<b>Test Result:</b>	According to FCC § 2.1047(d), Part 22, 74, 90 there is no specific requirement for digital modulation, therefore modulation characteristic is not presented.

## 4. TEST SETUP PHOTO

### 4.1.Photos of Radiated emission



## **5. TEST SETUP PHOTO**

Please refer to report T1881590 01.

**-----THE END OF REPORT-----**