

# CHC<sup>®</sup> M6 GNSS Receiver

Revision 1.0  
May 2016



**Copyright**

Copyright 2014-2015 CHC | Shanghai HuaCe Navigation Technology Ltd. All rights reserved. The CHC are trademark of Shanghai HuaCe Navigation Technology Limited. All other trademarks are the property of their respective owners.

**Trademarks**

All product and brand names mentioned in this publication are trademarks of their respective holders.

**Safety Warnings**

The Global Positioning System (GPS) is operated by the U.S. Government, which is solely responsible for the accuracy and maintenance of the GPS network. Accuracy can also be affected by poor satellite geometry and obstructions, like buildings and heavy canopy.

**FCC interference statement**

This equipment has been tested and found to comply with the limits for a Class B digital device, pursuant to part 15 of the FCC Rules. These limits are designed to provide reasonable protection against harmful interference in a residential installation. This equipment generates, uses and can radiate radio frequency energy and, if not installed and used in accordance with the instructions, may cause harmful interference to radio communications. However, there is no guarantee that interference will not occur in a particular installation. If this equipment does cause harmful interference to radio or television reception, which can be determined by turning the equipment off and on, the user is encouraged to try to correct the interference by one or more of the following measures:

- Reorient or relocate the receiving antenna.
- Increase the separation between the equipment and receiver.
- Connect the equipment into an outlet on a circuit different from that to which the receiver is connected.
- Consult the dealer or an experienced radio/TV technician for help.

Any Changes or modifications not expressly approved by the party responsible for compliance could void the user's authority to operate the equipment.

This device complies with part 15 of the FCC Rules, Operation is subject to the following two conditions: (1) this device may not cause harmful interference and (2) this device must accept any interference received, including interference that may cause undesired operation.

**FCC Radiation Exposure Statement:**

This equipment complies with FCC radiation exposure limits set forth for an uncontrolled environment .This equipment should be installed and operated with minimum distance 20cm between the radiator& your body.



# CONTENTS

1. Introduction.....	4
1.1. Safety information.....	4
1.1.1. Warnings and cautions.....	4
1.1.2. Regulations and safety.....	4
1.1.3. Use and Care.....	5
1.2. Technical support.....	5
1.3. Disclaimer.....	5
1.4. Your comments.....	5
2. Getting started with M6.....	6
2.1. About the receiver.....	6
2.2. Parts of the receiver.....	6
2.2.1. Front panel.....	6
2.2.2. Lower housing.....	7
2.2.3. Receiver ports.....	8
2.3. Batteries and power.....	8
2.3.1. Internal batteries.....	8
2.3.1.1. Charging the battery.....	8
2.3.1.2. Battery safe.....	9
2.3.2. External power supply.....	10
2.4. Inserting battery and SIM card.....	10
2.5. Product basic supply accessories.....	11
2.5.1. Base kit basic supply.....	11
2.5.2. Rover kit basic supply.....	12
2.6. Connecting to an office computer.....	13
2.7. Connecting to a controller.....	14
2.7.1. Connecting via Wi-Fi with Hconfig software.....	14
2.7.2. Connecting via Bluetooth with Hconfig software.....	16
2.7.2.1. Via system Bluetooth.....	16
2.7.2.2. Via CHC Bluetooth.....	18
2.7.3. Connecting via Wi-Fi with LandStar 6 software.....	19
2.7.4. Connecting via Bluetooth with LandStar 6 software.....	21
2.8. Connecting to a USB drive.....	22
2.8.1. For data logging.....	23
2.8.2. For firmware upgrade.....	24
2.9. Downloading logged data.....	24
3. Front panel operation.....	26
3.1. Main operation menus.....	26
3.2. Configure the working mode.....	28
4. Base station setup and operation.....	33
4.1. Base station setup guidelines.....	33
4.2. Outputting corrections using internal radio modem.....	34
4.2.1. Base station setup.....	34

4.2.2. Configuring the base station.....	34
4.2.2.1. Configuring via Hcconfig software.....	34
4.2.2.2. Configuring via LandStar 6 software.....	35
4.3. Outputting corrections using external radio.....	36
4.3.1. Base station setup.....	36
4.3.2. Configuring the base station.....	38
4.3.2.1. Configuring via Hcconfig software.....	38
4.3.2.2. Configuring via LandStar 6 software.....	39
5. Rover station setup and operation.....	41
5.1. Rover station setup guidelines.....	41
5.2. Rover station setup.....	42
5.3. Configuring the rover station via LandStar 6 software.....	42
5.3.1. Receiving corrections using internal radio modem.....	42
5.3.2. Receiving corrections using internal cellular modem.....	44
5.3.3. Receiving corrections using cellular modem in the controller.....	47
6. Survey with LandStar 6 software.....	50
6.1. New project.....	50
6.2. Key in points.....	53
6.3. Measure points.....	54
6.3.1. Measure points in conventional mode.....	54
6.3.2. Survey with tilt sensor.....	57
6.3.2.1. Calibrating the tilt sensor.....	58
6.3.2.2. Measure points in compensated mode.....	60
6.4. Point adjust (Site calibration).....	63
6.5. Base shift.....	68
6.6. Data export.....	70
6.7. Receiver registration.....	71
7. Configuring through a web browser.....	73
7.1. Status menu.....	74
7.1.1. Position submenu.....	75
7.1.2. Operation submenu.....	75
7.1.3. Google Map submenu.....	76
7.2. Satellites menu.....	77
7.2.1. Satellite Track Table submenu.....	77
7.2.2. Satellite Track Diagram submenu.....	77
7.2.3. SkyPlot submenu.....	78
7.3. Receiver Settings menu.....	78
7.3.1. Introduction submenu.....	79
7.3.2. Antenna Param Settings submenu.....	79
7.3.3. Reference Station Settings submenu.....	80
7.3.4. Receiver Reset submenu.....	81
7.3.5. Languages submenu.....	82
7.4. Data Recording menu.....	82
7.4.1. Log Settings submenu.....	82

7.4.2. FTP Push Settings submenu.....	84
7.4.3. FTP Push Recording submenu.....	85
7.4.4. Data Download submenu.....	85
7.5. IO Settings menu.....	86
7.5.1. IO Settings submenu.....	86
7.6. GPRS menu.....	91
7.6.1. Network Info submenu.....	91
7.6.2. Network Set submenu.....	91
7.7. Wifi menu.....	92
7.7.1. Wifi Info submenu.....	92
7.7.2. Wifi Settings submenu.....	93
7.8. Bluetooth Set menu.....	93
7.8.1. Bluetooth Set submenu.....	93
7.9. Radio Settings menu.....	93
7.9.1. Radio Info submenu.....	94
7.9.2. Radio Settings submenu.....	94
7.10. Network Service menu.....	94
7.10.1. HTTP submenu.....	95
7.10.2. FTP Service submenu.....	95
7.11. Firmware menu.....	95
7.11.1. Firmware Info submenu.....	96
7.11.2. System Log submenu.....	96
7.11.3. Firmware Update submenu.....	96
7.11.4. Config File submenu.....	97
7.11.5. GNSS Registration submenu.....	97
7.11.6. The Hardware Version submenu.....	97
A. Communication ports definition.....	98
A.I. CHC M6 receiver IO port (7-pin Lemo port) definition.....	98
A.II. CHC M6 receiver USB port (7-pin Lemo port) definition.....	98

# 1. INTRODUCTION

The M6 GNSS Receiver User Guide describes how to set up and use the CHC® M6 GNSS receiver.

In this manual, “the receiver” refers to the M6 GNSS receiver unless otherwise stated.

Even if you have used other Global Navigation Satellite Systems (GNSS) products before, CHC recommends that you spend some time reading this manual to learn about the special features of this product. If you are not familiar with GNSS, go to [www.chcnv.com](http://www.chcnv.com) for an interactive look at CHC and GNSS.

## 1.1. SAFETY INFORMATION

### 1.1.1. WARNINGS AND CAUTIONS

An absence of specific alerts does not mean that there are no safety risks involved.

A Warning or Caution information is intended to minimize the risk of personal injury and/or damage to the equipment.



**WARNING** - A Warning alerts you to a potential misused or wrong setting of the equipment.



**CAUTION** - A Caution alerts you to a possible risk of serious injury to your person and/or damage to the equipment.

### 1.1.2. REGULATIONS AND SAFETY

The receivers contain a built-in wireless modem for signal communication through Bluetooth® wireless technology or through external communication datalink. Regulations regarding the use of the wireless modem vary greatly from country to country. In some countries, the unit can be used without obtaining an end-user license. However, in some countries, the administrative permissions are required. For license information, consult your local dealer. Bluetooth® operates in license-free bands.

Before operating a M6 GNSS receiver, determine if authorization or a license to operate the unit is required in your country. It is the responsibility of the end-user to obtain an operator's permit or license for the receiver for the location or country of use.

### 1.1.3. USE AND CARE

This receiver is designed to withstand the rough environment that typically occurs in the field. However, the receiver is high-precision electronic equipment and should be treated with reasonable care.



CAUTION - Operating or storing the receiver outside the specified temperature range will cause irreversible damage.

## 1.2. TECHNICAL SUPPORT

If you have a problem and cannot find the information you need in this manual or CHC website ([www.chcnv.com](http://www.chcnv.com)), contact your local CHC dealer from which you purchased the receiver(s).

If you need to contact CHC technical support, please contact us by email ([support@chcnv.com](mailto:support@chcnv.com)) or Skype ([chc\\_support](https://www.skype.com/people/chc_support)).

## 1.3. DISCLAIMER

Before using the receiver, please make sure that you have read and understood this User Guide, as well as the safety information. CHC holds no responsibility for the wrong operation by users and for the losses incurred by the wrong understanding about this User Guide. However, CHC reserves the rights to update and optimize the contents in this guide regularly. Please contact your local CHC dealer for new information.

## 1.4. YOUR COMMENTS

Your feedback about this user guide will help us to improve it in future revision. Please email your comments to [support@chcnv.com](mailto:support@chcnv.com).

## 2. GETTING STARTED WITH M6

### 2.1. ABOUT THE RECEIVER

The M6 GNSS receiver incorporates a GNSS engine, GNSS antenna, internal radio, optional 4G cellular modem, Bluetooth, Wi-Fi, and dual-battery in a ruggedized and miniature unit that is easy for you to set up an all-in-one RTK rover or mobile base station.

The LED indicators enables you to check satellite-tracking status, internal battery status, Wi-Fi status, data transmission status and data logging status. Bluetooth and Wi-Fi technology provide cable-free communication between the receiver and controller.

The receiver can be used as the part of a RTK GNSS system with CHC LansStar6 software. And you can download the GNSS data that recorded in the internal memory of receiver to a computer.

To configure the receiver for performing a wide variety of functions, you can use the web interface by connecting the receiver with PC or smartphone through Wi-Fi.

### 2.2. PARTS OF THE RECEIVER

The operating controls are all located on the front panel. Battery compartment, SIM card slot, serial ports and connectors are located on the bottom of the unit.

#### 2.2.1. FRONT PANEL

The following figure shows a front view of the receiver.



Front View

The front panel contains one five indicator LEDs, and two buttons.



Name	Description
Power LED (Red)	Shows the number of satellites that the receiver has tracked. <ul style="list-style-type: none"> <li>• When the receiver is searching satellites, the blue LED flashes once every 5 seconds.</li> <li>• When the receiver has tracked N satellites, the blue LED will flash N times every 5 seconds.</li> </ul>
Satellite LED (Green)	Shows the status of Power. <ul style="list-style-type: none"> <li>• When battery level is low, it will start to blink .</li> </ul>
Correction LED (Green)	Indicates whether the receiver is transmitting/receiving differential data. The green LED flashes once per second when <ul style="list-style-type: none"> <li>• As a Base station: successfully transmitting differential data.</li> <li>• As a Rover station: successfully receiving differential data from Base station.</li> </ul>
Switch button	<ul style="list-style-type: none"> <li>• Switch on/off Static Mode</li> <li>• Select to update the firmware</li> </ul>
Power & Enter button	Works as a Power button: <ul style="list-style-type: none"> <li>• Press and hold this button for 3 seconds to turn on or turn off the receiver.</li> </ul> Works as a Reset button: <ul style="list-style-type: none"> <li>• Hold Fn button, and press this button for 5 times continuously to reset the mainboard.</li> </ul>



For more information about the front panel and relevant operations, see [3. Front panel operation](#).

### 2.2.2. LOWER HOUSING

The lower housing contains one SIM card slot, battery compartment, one TNC radio antenna connector, two communication and power ports, one 5/8-11 threaded insert, and two nameplates.

### 2.2.3. RECEIVER PORTS



Port	Name	Description
	IO port	<ul style="list-style-type: none"> <li>This port is a 7-pin Lemo connector that supports RS-232 communications and external power input.</li> <li>Users can use GPS to PC Data Cable supplied with the system to realize RS-232 communications between the receiver and computer or controller. Also, users can use a 7-pin cable to transmit differential data to an external radio.</li> </ul>
	USB port	<ul style="list-style-type: none"> <li>This port is a 7-pin Lemo connector that supports USB communications and external power input.</li> <li>Users can USB Cable supplied with the system to download the logged data to a computer.</li> <li>The OTG Cable supplied with the system can be used to upgrade the receiver firmware by connecting the receiver to a USB flash disk, or directly log the static data to a USB flash disk.</li> </ul>
	Radio antenna connector	Connect a radio antenna to internal radio of the receiver. And this connector is not used if you are using an external radio.

## 2.3. BATTERIES AND POWER

### 2.3.1. INTERNAL BATTERIES

The receiver has two rechargeable Lithium-ion batteries, which can be removed for charging.

#### 2.3.1.1. Charging the battery

The rechargeable Lithium-ion battery is supplied partially charged. Charge

the battery completely before using it for the first time. To charge the battery, first remove the battery from the receiver, and then place it in the battery charger, which is connected to AC power.



WARNING - Charge and use the rechargeable Lithium-ion battery only in strict accordance with the instructions. Charging or using the battery in unauthorized equipment can cause an explosion or fire, and can result in personal injury and/or equipment damage.

To prevent injury or damage:

- Do not charge or use the battery if it appears to be damaged or leaking.
- Charge the Lithium-ion battery only in a CHC product that is specified to charge it. Be sure to follow all instructions that are provided with the battery charger.
- Discontinue charging a battery that gives off extreme heat or a burning odor.
- Use the battery only in CHC equipment that is specified to use it.
- Use the battery only for its intended use and according to the instructions in the product documentation.

#### 2.3.1.2. Battery safe



WARNING - Do not damage the rechargeable Lithium-ion battery. A damaged battery can cause an explosion or fire, and can result in personal injury and/or property damage.

To prevent injury or damage:

- Do not use or charge the battery if it appears to be damaged. Signs of damage include, but are not limited to, discoloration, warping, and leaking battery fluid.
- Do not expose the battery to fire, high temperature, or direct sunlight.
- Do not immerse the battery in water.
- Do not use or store the battery inside a vehicle under hot weather condition.
- Do not drop or puncture the battery.
- Do not open the battery or short-circuit its contacts.



WARNING - Avoid contact with the rechargeable Lithium-ion battery if it appears to be leaking. Battery fluid is corrosive, and contact with it can result in personal injury and/or property damage.

To prevent injury or damage:

- If the battery leaks, avoid with the battery fluid.

- If battery fluid gets into your eyes, immediately rinses your eyes with clean water and seek medical attention. Please do not rub your eyes!
- If battery fluid gets onto your skin or clothing, immediately use clean water to wash off the battery fluid.

### 2.3.2. EXTERNAL POWER SUPPLY

Two methods are available for providing the external power to the receiver by the GPS to PC Data Cable/USB Cable+ Power Adapter, or GPS to PC Data Cable/USB Cable + external power cable (option purchase)+ vehicle battery.

In the office:

The Power Adapter is connecting with AC power of 100-240V, the output port of the Power Adapter connects with the Power Port of the GPS to PC Data Cable/USB Cable.

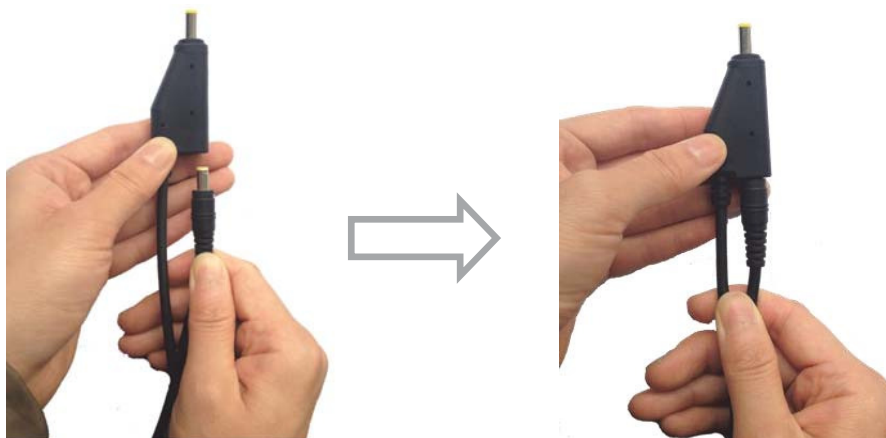

In the field:

The external power cable is connecting with a vehicle battery, the output port of the external power cable connects with the Power Port of the GPS to PC Data Cable/USB Cable.



**WARNING** - Use caution when connecting external power cable's clip leads to a vehicle battery. Do not allow any metal object to connect (short) the battery's positive (+) terminal to either the negative (-) terminal or the metal part of the vehicle battery. This could result in high current, arcing, and high temperatures, exposing the user to possible injury.

## 2.4. INSERTING BATTERY AND SIM CARD

Push down the spring-loaded button on the battery cover to open the cover.

Make electrode sheets of battery turn toward the receiver, align the socket of the battery and the lug of the battery compartment, and then insert the battery into the battery compartment until it is locked by the battery bail.



Insert the SIM card with the contacts facing upward, as indicated by the SIM card icon next to the SIM card slot.

To eject the SIM card, slightly push it in to trigger the spring-loaded release mechanism.

*Tip – The SIM card is provided by your cellular network service provider.*

## 2.5. PRODUCT BASIC SUPPLY ACCESSORIES

### 2.5.1. BASE KIT BASIC SUPPLY

Item	Picture
M6 GNSS Receiver	
UHF Bar Antenna (403-473 MHz)	
OTG Cable	

USB Cable



GPS to PC Data Cable



Lithium Battery



H.I. Tape



Extension pole



Tribrach with optical plummet



Auxiliary H.I. Tool



Tribrach adaptor



Transport Hard Case



### 2.5.2. ROVER KIT BASIC SUPPLY

Item	Picture
M6 GNSS Receiver	

---

UHF Bar Antenna (403-473 MHz)	
OTG Cable	
USB Cable	
GPS to PC Data Cable	
Battery Charger	
Power Adapter with Cord	
Lithium Battery	
2M Range Pole w/bag	
Auxiliary H.I. Tool	
Transport Hard Case	

---

## 2.6. CONNECTING TO AN OFFICE COMPUTER

The receiver can be connected to an office computer for serial data transfer or settings via a GPS to PC Data Cable. Before you connect to the office computer, ensure that the receiver is powered on by internal battery or external power.

The following figure shows how to connect to the computer for serial data

transfer or settings:

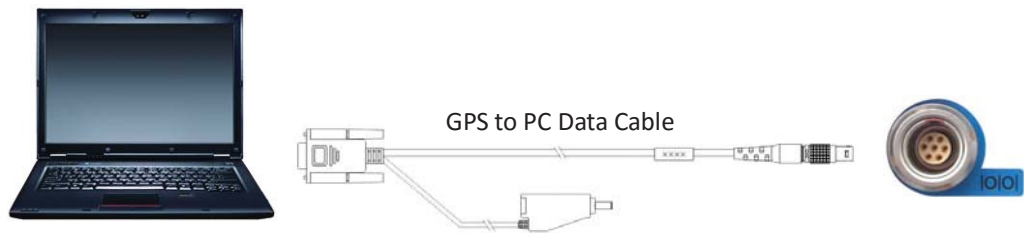

## 2.7. CONNECTING TO A CONTROLLER

### 2.7.1. CONNECTING VIA WI-FI WITH HCONFIG SOFTWARE

1. Turn on the controller → run Hconfig → tap **Connection** in the main menu.
2. In the *Connection* screen, select **CHC** for the *Manufacture* field, **Smart GNSS** for *Device Type* field, **WIFI** for *Mode* field.

**Connection**

Manufacture: CHC

Device Type: Smart GNSS

Mode: WIFI setting

3. Tap the **setting** button next to *Mode* field → turn on the **Wi-Fi** function → tap **Menu** button → tap **Wi-Fi Settings**.



4. In the *Configure Wireless Network Settings* screen, tap the wireless network named as the SN of your receiver.

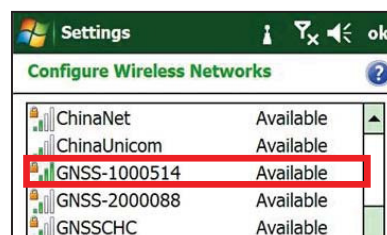



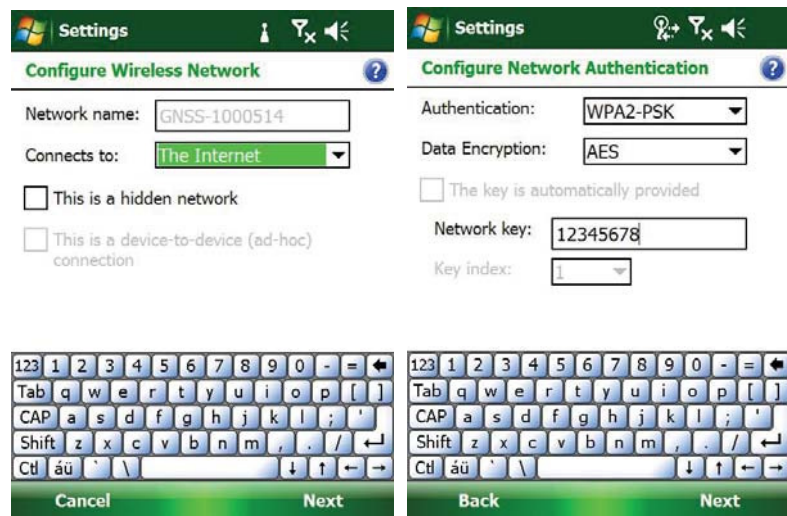

5. In the pop-up screen, tap **Next** button to enter *Configure Network Authentication* screen → enter the **Network Key** → tap **Next** button.

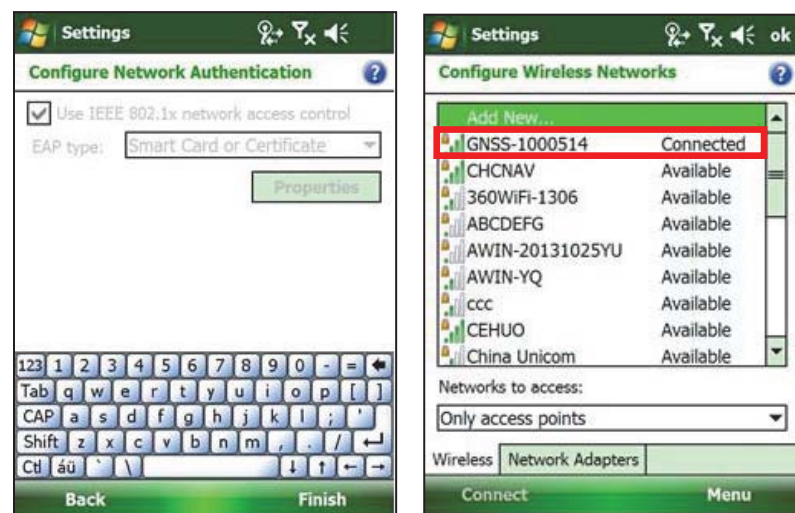

*Tip – The Wi-Fi key of the receiver is 12345678 by default.*

6. Tap **Finish** button in the pop-up screen, and then you can check that the controller system has connected to the Wi-Fi of the receiver. Tap **ok** button in the top right corner.



7. Tap  button in the pop-up screen to go back to the Hconfig screen → tap **Connect** button to connect the software with the receiver via Wi-Fi.

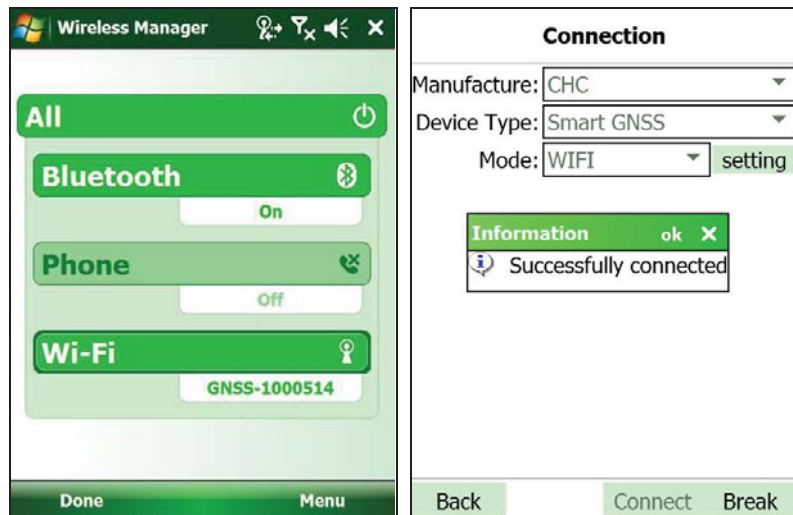

## 2.7.2. CONNECTING VIA BLUETOOTH WITH HCONFIG SOFTWARE

### 2.7.2.1. Via system Bluetooth

1. Turn on the controller → run Hconfig → tap **Connection** in the main menu.
2. In the *Connection* screen, select **CHC** for the *Manufacture* field, **Smart GNSS** for *Device Type* field, **Sys. BT** for *Mode* field.

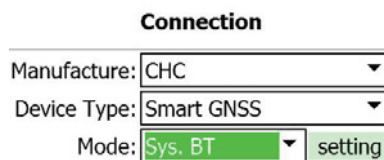

3. Tap the **setting** button next to *Mode* field → turn on the **Bluetooth** function → tap **Menu** button → tap **Bluetooth Settings**.



4. In the *Bluetooth settings* screen, select **Devices** tab. Tap **Add new device...**, and then the system will search for Bluetooth devices.



In the *Select a Bluetooth* screen, tap the Bluetooth device named as the SN of your receiver → tap **Next** button.



- In the *Enter Passcode* screen, enter the **Passcode** → tap **Next** button.  
After the device is added, tap **Done** button.

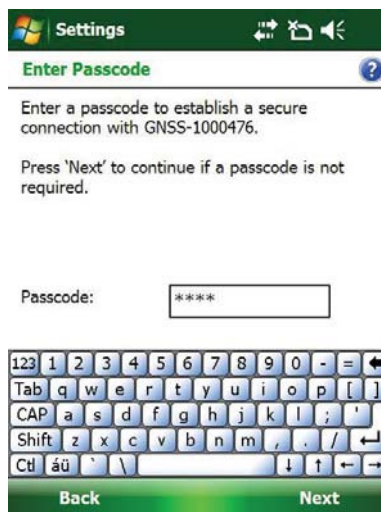

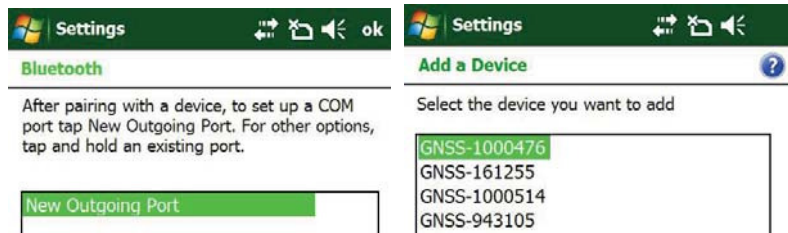

*Tip – The Bluetooth key of the receiver is 1234 by default.*

- In the Bluetooth settings screen, select **COM Ports** tab. Tap **New Outgoing Port** → select your receiver → tap **Next** button.

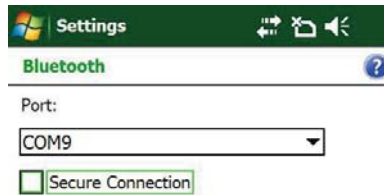

7. Select a COM port that has not be used from the dropdown list of the Port field → untick Secure Connection option → tap **Finish** button.



8. Tap **ok** button in the top right corner to back the *Wireless Manager* screen → tap  button to go back the Hconfig screen →select **COM Port** that you configured to connect the controller with the receiver for the *Port* field → tap **Connect** button to connect the software with the receiver via system Bluetooth.

Connection	
Manufacture:	CHC
Device Type:	Smart GNSS
Mode:	Sys. BT setting
Port:	COM9
Back	Connect Break

### 2.7.2.2. Via CHC Bluetooth

1. Turn on the controller → run Hconfig → tap **Connection** in the main menu.
2. In the *Connection* screen, select **CHC** for the *Manufacture* field, **Smart GNSS** for *Device Type* field, **CHC BT** for *Mode* field, **COM Port** that you want to be used to connect the controller with the receiver for the *Port* field.

Connection	
Manufacture:	CHC
Device Type:	Smart GNSS
Mode:	CHC BT
Port:	COM9

3. Tap **Search Device** to search the Bluetooth devices → tap the Bluetooth device named as the SN of your receiver → tap **Connect** button to connect the software with the receiver via CHC Bluetooth.

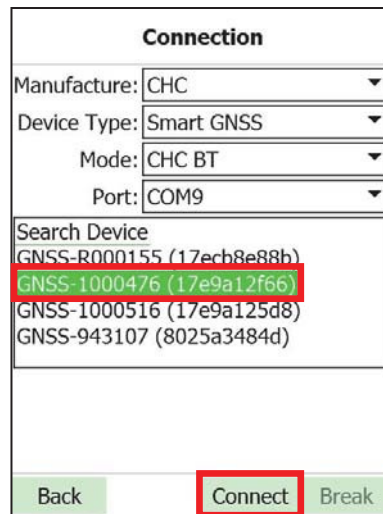

### 2.7.3. CONNECTING VIA WI-FI WITH LANDSTAR 6 SOFTWARE

1. Turn on the controller → tap **Start** button → tap **Settings** → select **Connection** tab → tap **Wireless Manager** → turn on the **Wi-Fi** function → tap **Menu** button → tap **Wi-Fi Settings**.



2. In the *Configure Wireless Network Settings* screen, tap the wireless network named as the SN of your receiver.



3. In the pop-up screen, tap **Next** button to enter *Configure Network Authentication* screen → enter the **Network Key** → tap **Next** button.

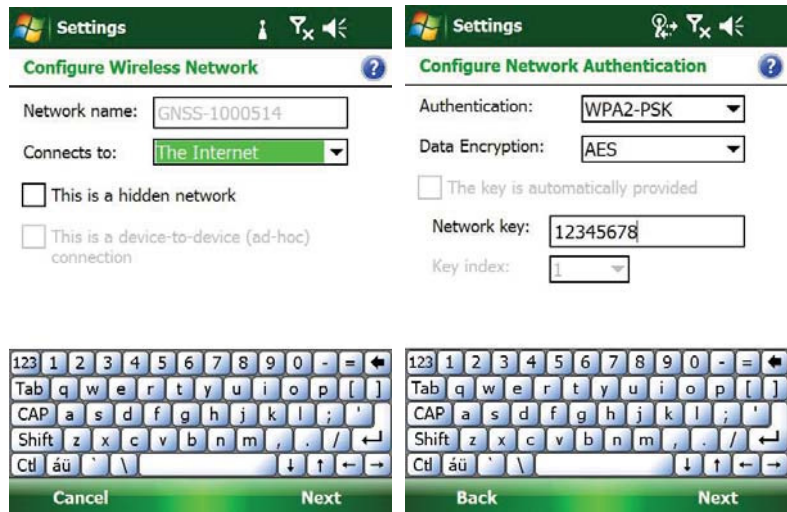

Tip – The Wi-Fi key of the receiver is 12345678 by default.

4. Tap **Finish** button in the pop-up screen, and then you can check that the controller system has connected to the Wi-Fi of the receiver.

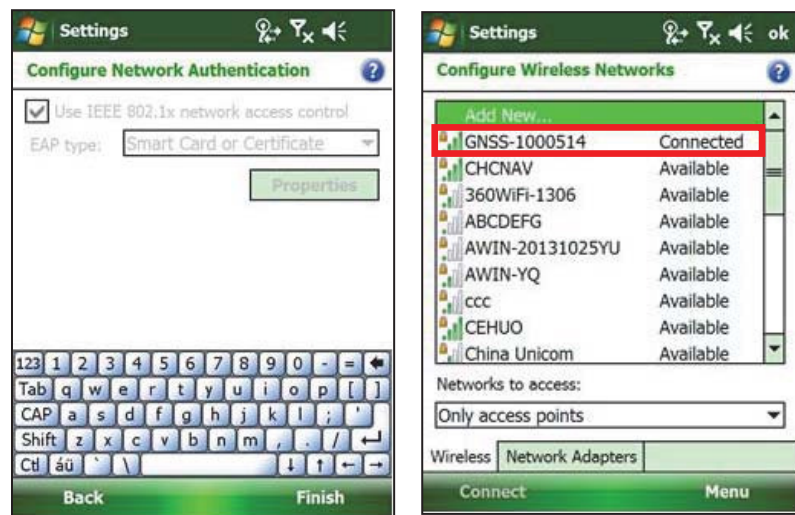

5. Go back to the main screen → run LandStar 6 → create a new project or open an existing project.
6. In the *Main Menu*, tap **Device** → tap **Connection**.



7. Select **CHC** for the *Manufacture* field, **Smart GNSS** for *Device Type* field, **WIFI** for *Connect* field, **CHCM6** for *Antenna Type* field → select **Base** or

**Rover** as *Connection Type* according to the your needs → tap  in the lower right corner to connect the software with the receiver via Wi-Fi.





#### 2.7.4. CONNECTING VIA BLUETOOTH WITH LANDSTAR 6 SOFTWARE

1. Turn on the controller →run LandStar 6 → create a new project or open an existing project.
2. In the *Main Menu*, tap **Device** → tap **Connection**.



3. Select **CHC** for the *Manufacture* field, **Smart GNSS** for *Device Type* field, **Bluetooth** for *Connection* field.



4. Tap  icon next to *Connection* field → tap **Search Device** in the pup-up *Bluetooth Binding* screen → select the Bluetooth device named as the SN of your receiver → tap  in the lower right corner to go

back to *Connection* screen.

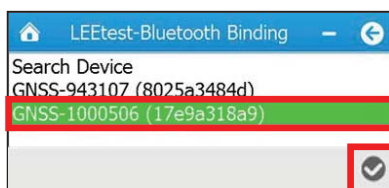

5. Select **COM Port** that you want to be used to connect the controller with the receiver for the *Port* field → **CHCM6** for *Antenna Type* field → select **Base** or **Rover** as *Connection Type* according to the your needs → tap  in the lower right corner to connect the software with the receiver via Bluetooth.



## 2.8. CONNECTING TO A USB DRIVE

The receiver can log data directly to a USB drive using the supplied OTG cable. Also, users can use USB drive to upgrade the firmware for your receiver using the OTG cable.

The following figure shows how to connect to a USB drive:

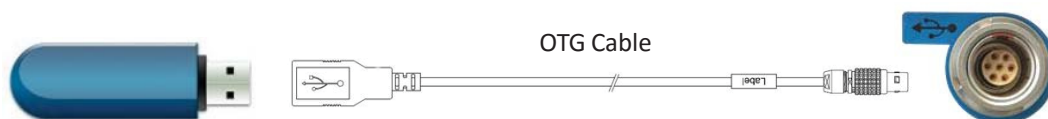



### 2.8.1. FOR DATA LOGGING

The receiver can log data directly to a USB drive; however, the logged (existing) data cannot be downloaded directly from the receiver memory to a USB drive.

To log data directly to a USB drive:

1. Connect the USB device (or other external storage device, such as portable hard drive) with receiver through USB port using the OTG cable.
2. Configure the data logging settings through a web browser (see [7.4.1. Log Settings submenu](#) for instruction).

#### Notes

- Select a data logging session, and then select “External Storage” as the store location.

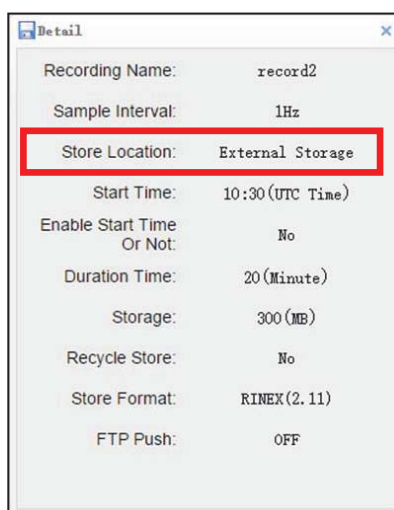

- Make sure the data logging session selected is switched on after the configuration. Also, user need to verify the Log Status is “Recording” before leave the web browser.

Recording Number	Recording Name	On Or Off	Log Status
1	record1	Yes	Recording
2	record2	Yes	Recording

3. The receiver will log static data to the USB drive.

*Note – To download the data logged in the USB driver, connect the USB driver to the computer, find a folder named as “repo” in the USB drive, and then locate the logged static data according to procedure illustrated as follows:*

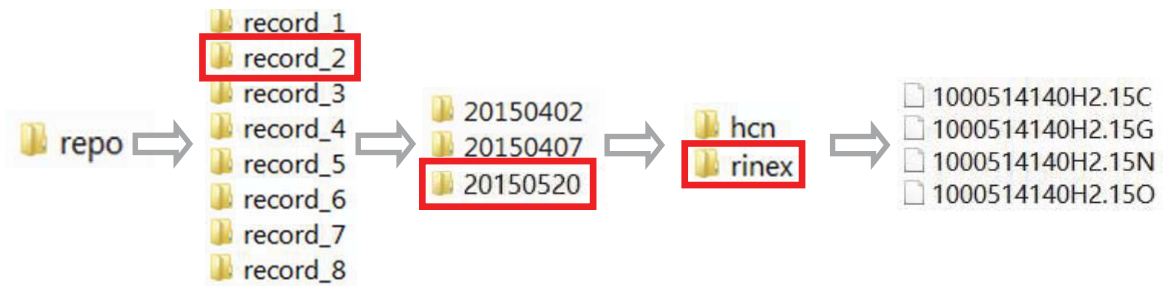

### 2.8.2. FOR FIRMWARE UPGRADE

1. Copy the firmware file (xxx.bin file) to the root directory of external storage device such as USB drive, portable hard drive.
2. Connect the external storage device with receiver through USB port using the OTG cable.
3. Restart the receiver
4. Press Switch button to upgrade the firmware.
5. When the upgrading is completed, the receiver will be restarted.

*Note – You can also use Wi-Fi to upgrade the firmware for your receiver using the web browser (see 7.11.3. Firmware update submenu for instruction).*

### 2.9. DOWNLOADING LOGGED DATA

Data logging involves the collection of GNSS measurement data over a period of time at a static point or points, and subsequent postprocessing of the information to accurately compute baseline information. Data logging using receivers requires access to suitable GNSS postprocessing software such as the CHC Geomatics Office (CGO) Software.

The following figure shows how to connect to the computer for downloading logged data:

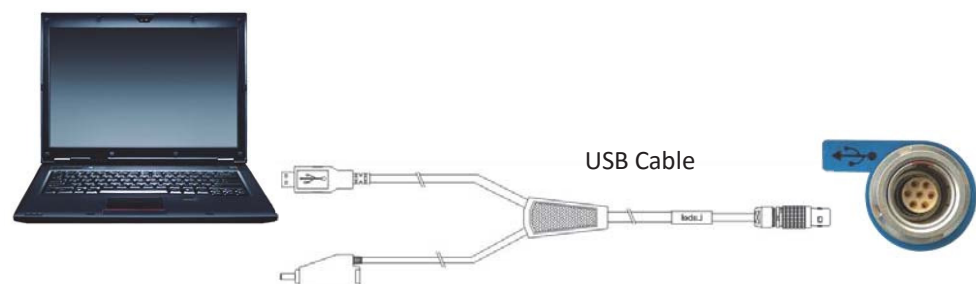

The procedures of downloading logged data in the receiver are as follows:

1. Switch on the receiver and connect it with a computer by USB Cable. After the successful connection, a removable disk named as the Serial Number (SN) of the receiver will appear on the computer.
2. Double click the removable disk and you will see the folder named as “repo”. Double click this folder, you will see 9 folders. The “push\_log” folder is used to save the log files, and the other 8 folders represent different logging session and are used for store static data.
3. Double click the folder that you has configured to store the static data, you will see the folder(s) created by the M6 system automatically and named by the date which is decide by GPS time when you start to log data.
4. Select the destination folder and double click it, and then two folders named as different data format (hcn and rinex) will be displayed.
5. Select the data format that you has configured to save the static data, you will find the static raw data.

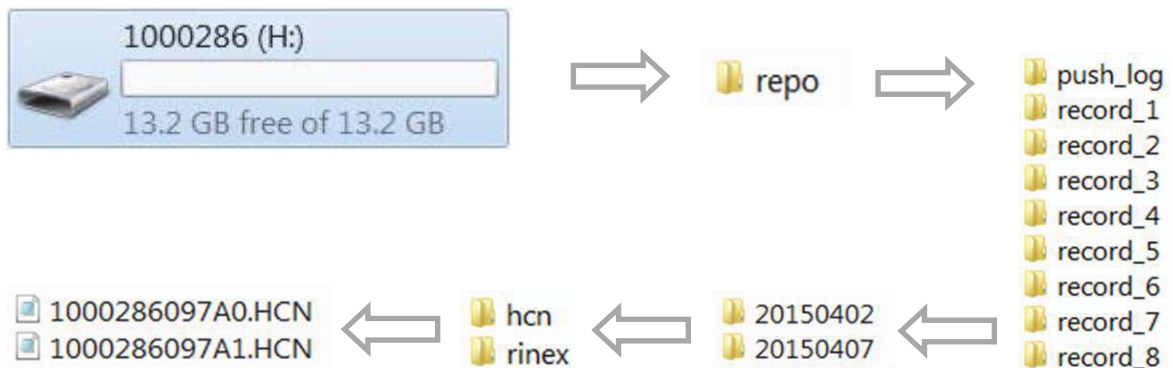

*Tip – For hcn files, the name of the file is represented as XXXXXXDDDNN, where XXXXXX is the SN of the receiver, DDD is day of year, and NN is the recording session.*



**WARNING** – The static data will be saved in the first logging session, the “record\_1” folder, by default. Old files will be deleted if the storage space is full. If you configure not to auto delete old files when the memory is low, the receiver will stop data logging.

### 3. FRONT PANEL OPERATION

The front panel contains five indicator LEDs, and two buttons. The operating controls are all located on the front panel.

#### 3.1. MAIN OPERATION MENUS

The main operation menus are as follows:

Top-level Menu	Second-level Menu	Description
SV: 22 Battery: 97%		<ul style="list-style-type: none"><li>Click <b>Enter</b> button to enter the second-level menus.</li><li>Indicates the number of the satellites tracked and the internal batteries power remaining.</li><li>If the receiver is searching for satellites and the batteries are not be inserted, this menu will be displayed as “SV: Getting Battery: N/A”.</li></ul>
	22 = G09 R05 C07 S00 E0	Indicates the total number of satellites that have been tracked and the number of satellites tracked of each constellation, where G represents GPS, R represents GLONASS, C represents BeiDou, S represents SBAS and E represents Galileo.
	Pwr: A 97% B 97%	Indicates the remaining power of the battery inserted in the left (B) and right (A) battery compartment.
	Wlan Status On Wlan Mode HotSpot	<ul style="list-style-type: none"><li>Indicates the Wi-Fi status.</li><li>Click <b>Enter</b> button to change the status, and then click <b>Fn</b> button to cancel the change, or click <b>Enter</b> button to confirm the change.</li></ul>
	Dial Status Offline	<ul style="list-style-type: none"><li>Indicates whether the receiver has been connected to cellular network.</li><li>Generally, when the SIM card has been inserted before the receiver is turned on, this menu will be displayed as “Dial Status Online”.</li></ul>
	Cancel	Click <b>Enter</b> button to back to the top-level menu.
Mode Rover UHF		<ul style="list-style-type: none"><li>Click <b>Enter</b> button to enter the</li></ul>

Top-level Menu	Second-level Menu	Description
		second-level menus.
		<ul style="list-style-type: none"> <li>Indicates the current working mode.</li> </ul>
	Base Cable	
	Base Int. UHF	
	Base APIS	
	Base APIS & Cable	<ul style="list-style-type: none"> <li>Click <b>Enter</b> button to enter the configuration screen of the selected working mode.</li> </ul>
	Rover APIS	
	Rover Ntrip/IP	<ul style="list-style-type: none"> <li>More operation information, see <a href="#">3.2. Configure the working mode.</a></li> </ul>
	Rover UHF	
	Cancel	Click <b>Enter</b> button to back to the top-level menu.
Static Off		<ul style="list-style-type: none"> <li>Click <b>Enter</b> button to enter the second-level menus.</li> <li>Indicates the current data logging status: Static Off or Static On.</li> </ul>
	Set Off	Click <b>Enter</b> button to change the data logging status.
	Recorded 00:02	Indicates the duration of data logging.
	Epoch Intv 1s	<ul style="list-style-type: none"> <li>Click <b>Enter</b> button to change the measurement interval.</li> <li>The available options are: 0.2s, 0.5s, 1s, 2s, 5s, 10s, 15s, 30s, and 60s.</li> </ul>
	Mask Angle 13 Degree	Click <b>Enter</b> button to change the mask degree from 0 degree to 15 degrees.
	Duration time 1440 min	<ul style="list-style-type: none"> <li>Click <b>Enter</b> button to enter <i>Duration Time Setting</i> screen.</li> <li>In the <i>Duration Time Setting</i> screen, click <b>Fn</b> button to move to the character of the duration time value you want to make change, and then click <b>Enter</b> button to change from 0 to 9. After the change has been done, you can click <b>Fn</b> button to move to <b>OK</b> field, and then click <b>Enter</b> button to save the change and back to the second-level menu; or click <b>Fn</b> button to move to <b>Cancel</b> field and click <b>Enter</b> button to cancel the change and back to the second-level menu.</li> </ul>
	OK	Click <b>Enter</b> button to save the settings of the data logging and back to the top-level menu, and then the settings will take effect.

Top-level Menu	Second-level Menu	Description
Receiver Info.	Cancel	Click <b>Enter</b> button to cancel the settings of the data logging and back to the top-level menu.
		Click <b>Enter</b> button to enter the second-level menus and check the basic information about the receiver.
	SN 1000514	Displays the Serial Number (SN) of the receiver.
	PN 1180020032231	Displays the Part Number (PN) of the receiver.
	Reg. 20301231	Displays the expiry date of registration code.
	Ver. 1.1.16	Displays the firmware version.
	Language English	Click <b>Enter</b> button to change the display language between Chinese, English and Russian.
	Cancel	Click <b>Enter</b> button to back to the top-level menu.

### 3.2. CONFIGURE THE WORKING MODE

7 working modes are provided for quickly setting up a RTK base station or rover station. Users can configure each working mode through front panel as follows:

Working Mode	Menus in Configuration Screen	Description
Base Cable		<ul style="list-style-type: none"> <li>Set up the receiver as a base station using external UHF.</li> <li>Click <b>Enter</b> button to enter the configuration screen.</li> </ul>
	Mode Base Cable	The title of this configuration screen.
	Format CMR	<ul style="list-style-type: none"> <li>Click <b>Enter</b> button to change the correction format.</li> <li>The available correction formats are: CMR, CMR+, SCMR, RTCM v2.3, RTCM v3, and RTCM v3.2.</li> </ul>
	OK	Click <b>Enter</b> button to save the settings and back to the top-level menu, and then this working mode will take effect.
	Cancel	Click <b>Enter</b> button to cancel the settings and back to the second-level menu.
Base Int. UHF		<ul style="list-style-type: none"> <li>Set up the receiver as a base station using internal UHF.</li> <li>Click <b>Enter</b> button to enter the configuration screen.</li> </ul>

Working Mode	Menus in Configuration Screen	Description
Base APIS	Mode Base Int. UHF	The title of this configuration screen.
	Channel 1	Click <b>Enter</b> button to change the channel from 1 to 9.
	Format CMR	<ul style="list-style-type: none"> <li>Click <b>Enter</b> button to change the correction format.</li> <li>The available correction formats are: CMR, CMR+, SCMR, RTCM v2.3, RTCM v3, and RTCM v3.2.</li> </ul>
	Power	<ul style="list-style-type: none"> <li>Click <b>Enter</b> button to change the transmitting power.</li> <li>The available transmitting power options are: 0.125w, 01w .</li> </ul>
	Protocol CHC	Indicates the current protocol.
	OK	Click <b>Enter</b> button to save the settings and back to the top-level menu, and then this working mode will take effect.
	Cancel	Click <b>Enter</b> button to cancel the settings and back to the second-level menu.
		<ul style="list-style-type: none"> <li>Set up the receiver as a base station using APIS service.</li> <li>Click <b>Enter</b> button to enter the configuration screen.</li> </ul>
	Mode Base APIS	The title of this configuration screen.
	Format CMR	<ul style="list-style-type: none"> <li>Click <b>Enter</b> button to change the correction format.</li> <li>The available correction formats are: CMR, CMR+, SCMR, RTCM v2.3, RTCM v3, and RTCM v3.2.</li> </ul>
	<ul style="list-style-type: none"> <li>Click <b>Enter</b> button to enter <i>Common IP</i> screen.</li> <li>In <i>Common IP</i> screen, click <b>Fn</b> button to move to the line of IP address, and then click <b>Enter</b> button to change to other predefined IP address. After the IP address has been changed, you can click <b>Fn</b> button to move to <b>OK</b> field, and then click <b>Enter</b> button to save the change and back to the second-level menu; or click <b>Fn</b> button to move to <b>Cancel</b> field and click <b>Enter</b> button to cancel the change and back to the</li> </ul>	

Working Mode	Menus in Configuration Screen	Description
		second-level menu.
Base APIS & Cable	Port 9901	Click <b>Enter</b> button to change the port from 9901 to 9920.
	OK	Click <b>Enter</b> button to save the settings and back to the top-level menu, and then this working mode will take effect.
	Cancel	Click <b>Enter</b> button to cancel the settings and back to the second-level menu.
	Mode Base APIS & Cable Way Cable & APIS	<ul style="list-style-type: none"> <li>Set up the receiver as a base station using both APIS service and external UHF.</li> <li>Click <b>Enter</b> button to enter the configuration screen.</li> </ul> <p>The title of this configuration screen. Indicates that the receiver is set up as a base station using not only external UHF, but also APIS service</p>
	Format CMR	<ul style="list-style-type: none"> <li>Click <b>Enter</b> button to change the correction format.</li> <li>The available correction formats are: CMR, CMR+, SCMR, RTCM v2.3, RTCM v3, and RTCM v3.2.</li> </ul>
	IP 211.144.118.5	<ul style="list-style-type: none"> <li>Click <b>Enter</b> button to enter <i>Common IP</i> screen.</li> <li>In <i>Common IP</i> screen, click <b>Fn</b> button to move to the line of IP address, and then click <b>Enter</b> button to change to other predefined IP address. After the IP address has been changed, you can click <b>Fn</b> button to move to <b>OK</b> field, and then click <b>Enter</b> button to save the change and back to the second-level menu; or click <b>Fn</b> button to move to <b>Cancel</b> field and click <b>Enter</b> button to cancel the change and back to the second-level menu.</li> </ul>
	Port 9901	Click <b>Enter</b> button to change the port from 9901 to 9920.
	OK	Click <b>Enter</b> button to save the settings and back to the top-level menu, and then this combination working mode will take effect.
	Cancel	Click <b>Enter</b> button to cancel the settings and back to the second-level menu.



Working Mode	Menus in Configuration Screen	Description
Rover APIS		<ul style="list-style-type: none"> <li>Set up the receiver as a rover station using APIS service.</li> <li>Click <b>Enter</b> button to enter the configuration screen.</li> </ul>
	Mode Rover APIS	The title of this configuration screen.
	Current Base SN 1000456	<ul style="list-style-type: none"> <li>Display the SN of corresponding base station.</li> <li>Click <b>Enter</b> button to enter <i>Base SN setting</i> screen. In the <i>Base SN setting</i> screen, click <b>Fn</b> button to move to the character of the value you want to make change, and then click <b>Enter</b> button to change from digital 0 to 9 (in addition, the initial character can be changed to letter R). After the change has been done, you can click <b>Fn</b> button to move to <b>OK</b> field, and then click <b>Enter</b> button to save the change and back to the second-level menu; or click <b>Fn</b> button to move to <b>Cancel</b> field and click <b>Enter</b> button to cancel the change and back to the second-level menu.</li> </ul>
	IP 211.144.118.5	<ul style="list-style-type: none"> <li>Click <b>Enter</b> button to enter <i>Common IP</i> screen.</li> <li>In <i>Common IP</i> screen, click <b>Fn</b> button to move to the line of IP address, and then click <b>Enter</b> button to change to other predefined IP address. After the IP address has been changed, you can click <b>Fn</b> button to move to <b>OK</b> field, and then click <b>Enter</b> button to save the change and back to the second-level menu; or click <b>Fn</b> button to move to <b>Cancel</b> field and click <b>Enter</b> button to cancel the change and back to the second-level menu.</li> </ul>
	Port 9901	Click <b>Enter</b> button to change the port from 9901 to 9920.
	OK	Click <b>Enter</b> button to save the settings and back to the top-level menu, and then this working mode will take effect.
	Cancel	Click <b>Enter</b> button to cancel the settings and back to the second-level menu.
Rover Ntrip/IP		<ul style="list-style-type: none"> <li>Set up the receiver as a rover station using</li> </ul>

Working Mode	Menus in Configuration Screen	Description
		<p>Ntrip.</p> <ul style="list-style-type: none"> <li>Click <b>Enter</b> button to enter the configuration screen.</li> </ul>
	Mode Rover Ntrip/IP Status Logged	<p>The title of this configuration screen.</p> <ul style="list-style-type: none"> <li>Indicates current status of Ntrip: Status Not Logged or Status Logged.</li> <li>Users need to use the web interface to configure the settings to log on Ntrip (see <a href="#">7.5.1. IO Settings submenu</a> → RTK Client for instruction) before.</li> </ul> <p><i>Note – Make sure a valid SIM card has been inserted in the receiver.</i></p>
	OK	Click <b>Enter</b> button to save the settings and back to the top-level menu, and then this working mode will take effect.
	Cancel	Click <b>Enter</b> button to cancel the settings and back to the second-level menu.
Rover UHF		<ul style="list-style-type: none"> <li>Set up the receiver as a rover station using internal UHF.</li> <li>Click <b>Enter</b> button to enter the configuration screen.</li> </ul>
	Mode Rover UHF Channel 1	<p>The title of this configuration screen.</p> <p>Click <b>Enter</b> button to change the channel from 1 to 9.</p>
	Protocol CHC	Indicates the current protocol.
	OK	Click <b>Enter</b> button to save the settings and back to the top-level menu, and then this working mode will take effect.
	Cancel	Click <b>Enter</b> button to cancel the settings and back to the second-level menu.

*Note – The operation menus of front panel may vary from different firmware versions of your receiver. The menus described in this chapter are based on firmware version 1.1.16.*

## 4. BASE STATION SETUP AND OPERATION

Real-Time Kinematic (RTK) operation provides centimeter-level precision by eliminating errors that are present in the GNSS system. For all RTK operations, you require both a rover receiver and a source of corrections from a base station or network of base stations.

A base station consists of a receiver that is placed at a known point. The receiver tracks the same satellites that are being tracked by the rover receiver simultaneously. Errors in the GNSS system are monitored at the base station, and a series of position corrections are computed. The messages are sent through a radio link to the rover receiver, where they are used to correct the real time positions of the rover.

This chapter provides the information to help you identify good setup locations, outlines basic precautions that you need to take to protect the equipment, and describes the conventional process to set up the base station and the configuring procedure that required for transmitting correction data.

### 4.1. BASE STATION SETUP GUIDELINES

For good performance, the following base station setup guidelines are recommended:

- Place the GNSS receiver in a location on the worksite where equal range in all directions provides full coverage of the site.
- Place the GNSS antenna in a location that has a clear line of sight to the sky in all directions. Do not place the antenna near vertical obstructions such as buildings, deep cuttings, site vehicles, towers, or tree canopy.
- The GNSS antenna must have a clear line of sight to the sky at all times during operation.
- Place the GNSS and radio antennas as high as practical. This minimizes multipath from the surrounding area, and enables the radio to broadcast to the maximum distance.
- Choose the most appropriate radio antenna for the size of the worksite. The higher the gain on the antenna, the longer the range.
- Make sure that the GNSS receiver does not lose power. To operate continuously for more than a few hours without loss of power at the base station, provide external power. When you use an external power supply, the integrated battery provides a backup power supply, enabling you to maintain continuous operation through a mains power failure.
- Do not locate a GNSS receiver, GNSS antenna, or radio antenna within 400 meters (about 1,300 feet) of transmitters, such as a power radar or

cellular communications tower.

- Do not set up the base station close to the sources of electromagnetic interference, include alternators and generators, electric motors, equipment with DC-to-AC converters, etc.
- Do not operate the receiver outside the specified operating temperature range -40°C to +60°C (-40°F to +140°F).
- Take reasonable care to keep the GNSS receiver equipment dry, which could prolong their life and reduce the effects of corrosion on ports and connectors.

## 4.2. OUTPUTTING CORRECTIONS USING INTERNAL RADIO

### MODEM

#### 4.2.1. BASE STATION SETUP

1. Connect the radio antenna onto M6 receiver. Screw the receiver onto extension pole.
2. Screw the extension pole with auxiliary H.I. tool onto tribrach adaptor.
3. Mount the tribrach onto the tripod.
4. Insert the tribrach adaptor into the tribrach.
5. Level and plumb the receiver over the known (control) point.
6. Measure the height of the base station GNSS antenna by measuring the slant height from the known (control) point to the auxiliary H.I. tool.

*Note – Select “Bottom” as the measurement method, select “CHCM6” as antenna type, and then enter the vertical height from the known (control) point to the bottom of receiver that you calculated by adding the height of the extension pole to the height from the known (control) point to the auxiliary H.I. tool, the CHC LandStar 6 will calculate the height to the Antenna Phase Center (APC) automatically.*

7. If required, connect the receiver to an external 12 V power supply.

#### 4.2.2. CONFIGURING THE BASE STATION

##### 4.2.2.1. Configuring via Hconfig software

1. Power on the receiver.
2. Turn on the controller, run Hconfig and establish the connection with receiver via Bluetooth or Wi-Fi (see 2.7. Connecting to a controller for the operations).
3. After successful connection, tap **RTK** in the main menu.
4. In *RTK* screen, select **Mode** from the dropdown list.



When select **Auto Base** for *Mode* field:

5. Configure the related parameters: **Format, Baud, Elevation** and **PDOP**.
6. Tick **Radio** option for *Enable IO*.
7. Tap **Set** button to save the settings, and then tap **Back** button to go back to main menu.
8. Tap **GPRS And Internal UHF** in the main menu, select **Internal UHF** for *Work Mode*.
9. Configure the internal radio parameters according to your need: **Frequency and Power**.
10. Tick **Auto Power** and **Power on** to turn on the internal UHF modem.
11. Tap **Set** button to save the settings → tap **Back** button to go back to main menu → tap **Exit** → select **Exit Software Only** option to exit Hcconfig.

When select **Manual Base** for *Mode* field:

5. Configure the related parameters: **Format, Baud, Elevation** and **PDOP**.
6. Tap **Here** button to obtain the current position or manually enter the coordinates of the known point in **B, L** and **H**.
7. Tick **Radio** option for *Enable IO*.
8. Tap **Set** button to save the settings, and then tap **Back** button to go back to main menu.
9. Tap **GPRS And Internal UHF** in the main menu, select **Internal UHF** for *Work Mode*.
10. Configure the internal radio parameters according to your need: **Frequency and Power**.
11. Tick **Auto Power** and **Power on** to turn on the internal UHF modem.
12. Tap **Set** button to save the settings → tap **Back** button to go back to main menu → tap **Exit** → select **Exit Software Only** option to exit Hcconfig.

#### 4.2.2.2. Configuring via LandStar 6 software

1. Power on the receiver.
2. Turn on the controller → run LandStar 6 → create a new project or open an existing project → establish the connection with receiver via Bluetooth or Wi-Fi (see 2.7. [Connecting to a controller](#) for the operations).
3. After successful connection, tap **Communication Mode** in the *Device* screen.
4. In *Communication Mode* screen, select **Radio** for *Mode* field.
5. Configure the related parameters from the dropdown list: **Protocol, Freq, Baud** and **Power**.
6. Tap  **Set** to confirm and save the settings → tap  in the lower right corner to back to *Device* screen.
7. Tap **Base Config** → select **Start Base Station** tab.

8. Configure the GNSS antenna related parameters as follows:



*Type* field: tap  next to *Type* field to select **CHCM6** as antenna type.

*Measure To* field: select **Bottom** from the dropdown list.

*Height* field: enter the vertical height (in meters) you calculated from the known (control) point to the bottom of receiver for *Height* field.

9. Configure the coordinates of base station.

There are three methods available to configure the base station coordinates:

- a) Tap  next to *Name* field to select an existing point.
  - b) Manually enter the coordinates of the known point in **B**, **L** and **H**.
  - c) Tap **Get Current Position** button to obtain the current position of the base receiver.
10. Go to **Base Parameters** tab → select **Inner Radio** for *Transmit COM* field → configure the *Data Format* field, *Baud Rate* field and *Elevation Mask* field according to your need.
11. Tap  in the lower right corner to save the settings, and then the LandStar 6 will disconnect with the receiver automatically.

### 4.3. OUTPUTTING CORRECTIONS USING EXTERNAL RADIO

#### 4.3.1. BASE STATION SETUP

**For base receiver part:**

1. Screw the M6 receiver onto extension pole.
2. Screw the extension pole with auxiliary H.I. tool onto tribrach adaptor.
3. Mount the tribrach onto the tripod.
4. Insert the tribrach adaptor into the tribrach.
5. Level and plumb the receiver over the known (control) point.
6. Measure the height of the base station GNSS antenna by measuring the slant height from the known (control) point to the auxiliary H.I. tool.

*Note – Select “Bottom” as the measurement method, select “CHCM6” as antenna type, and then enter the vertical height from the known (control) point to the bottom of receiver that you calculated by adding the height of the extension pole to the height from the known (control) point to the auxiliary H.I. tool, the CHC LandStar 6 will calculate the height to the Antenna Phase Center (APC) automatically.*

7. If required, connect the receiver to an external 12 V power supply.

**For external radio part (take the CHC DL5-C Datalink for example):**

8. Connect the Datalink Antenna to the 3 meter Cable for Datalink Antenna.
9. Connect 3 meter Cable for Datalink Antenna to Datalink Antenna Mounting Pole.
10. Screw the Datalink Antenna Mounting Pole onto the tribrach adapter.
11. Mount the tribrach onto the tripod.
12. Insert the tribrach adaptor into the tribrach.
13. Set up the Datalink Antenna nearby the base receiver.
14. Fix the DL5-C Datalink onto the tripod.
15. Place the car battery at an appropriate location.

**For connection between the receiver part and external radio part:**

16. Connect Datalink Antenna to the Datalink Antenna Slot of DL5-C Datalink via 3 meter Cable for Datalink Antenna.
17. Connect the base receiver with DL5-C Datalink via GPS to Datalink Cable.
18. Connect the car battery with DL5-C Datalink via Datalink External Power Cable.



CAUTION – The Datalink Antenna must be connected to the Datalink before the Datalink is powered on; otherwise, the Datalink can be damaged.



#### 4.3.2. CONFIGURING THE BASE STATION

##### 4.3.2.1. Configuring via Hcconfig software

1. Power on the receiver.
2. Turn on the controller, run Hcconfig and establish the connection with receiver via Bluetooth or Wi-Fi (see 2.7. [Connecting to a controller](#) for the operations).
3. After successful connection, tap **RTK** in the main menu.
4. In *RTK* screen, select **Mode** from the dropdown list.

When select **Auto Base** for *Mode* field:

5. Configure the related parameters: Format, Baud, Elevation and PDOP.
6. Tick **Port** option for *Enable IO*.
7. Tap **Set** button to save the settings → tap **Back** button to go back to main menu → tap **Exit** → select **Exit Software Only** option to exit Hcconfig.
8. After the receiver is successfully transmitting correction data (with the green LED flashing once per second), power on the external radio, and then configure the external radio from its panel.

When select **Manual Base** for *Mode* field:

5. Configure the related parameters: Format, Baud, Elevation and PDOP.



6. Tap **Here** button to obtain the current position or manually enter the coordination of the known point in **B, L** and **H**.
7. Tick **Port** option for *Enable IO*.
8. Tap **Set** button to save the settings → tap **Back** button to go back to main menu → tap **Exit** → select **Exit Software Only** option to exit Hcconfig.
9. After the receiver is successfully transmitting correction data (with the green LED flashing once per second), power on the external radio, and then configure the external radio from its panel.

#### 4.3.2.2. Configuring via LandStar 6 software

1. Power on the receiver.
2. Turn on the controller → run LandStar 6 → create a new project or open an existing project → establish the connection with receiver via Bluetooth or Wi-Fi (see 2.7. [Connecting to a controller](#) for the operations).
3. After successful connection, tap **Communication Mode** in the *Device* screen.
4. In *Communication Mode* screen, select **External Radio** for Mode → tap  in the lower right corner to back to *Device* screen.
5. Tap **Base Config** → select **Start Base Station** tab.
6. Configure the GNSS antenna related parameters as follows:

*Type* field: tap  next to *Type* field to select **CHCM6** as antenna type.

*Measure To* field: select **Bottom** from the dropdown list.

*Height* field: enter the vertical height (in meters) you calculated from the known (control) point to the bottom of receiver for *Height* field.

7. Configure the coordinates of base station.

There are three methods available to configure the base station coordinates:

- a) Tap  next to *Name* field to select an existing point.
  - b) Manually enter the coordinates of the known point in **B, L** and **H**.
  - c) Tap **Get Current Position** button to obtain the current position of the base station.
8. Go to **Base Parameters** tab → select **Outer Radio** for *Transmit COM* field → configure the *Data Format* field, *Baud Rate* field and *Elevation Mask* field according to your need.

9. Tap  in the lower right corner to save the settings, and then the LandStar 6 will disconnect with the receiver automatically.
10. After the receiver is successfully transmitting correction data (with the green LED flashing once per second), power on the external radio, and then configure the external radio from its panel.

## 5. ROVER STATION SETUP AND OPERATION

Real-Time Kinematic (RTK) operation provides centimeter-level precision by eliminating errors that are present in the GNSS system. For all RTK operations, you require both a rover receiver and a source of corrections from a base station or network of base stations.

The second part of the RTK GNSS system is the rover receiver. The rover receiver is moved between the points that require measurement or stakeout. The rover receiver is connected to a base station or to a source of RTK corrections such as a CORS (Continuous Operational Reference System) or the CHC APIS service. The connection is provided by:

- an integrated radio
- an integrated cellular modem
- a cellular modem in the controller

This chapter provides the information to help you identify good setup locations, describes the conventional process to set up the rover station and the configuring procedure that required for receiving correction data.

### 5.1. ROVER STATION SETUP GUIDELINES

For good rover operation, observe the following setup guidelines:

- Place the GNSS antenna in a location that has a clear line of sight to the sky in all directions. Do not place the antenna near vertical obstructions such as buildings, deep cuttings, site vehicles, towers, or tree canopy. GNSS rovers and the base station receive the same satellite signals from the same satellites. The system needs five common satellites to provide RTK positioning.



**WARNING** – Take care not to touch overhead power lines with the CHC M6 GNSS receiver or the range pole when moving the equipment into position. Touching overhead power lines may cause electrocution, leading to serious injury.

- GNSS satellites are constantly moving. Because you cannot measure at a specific location now does not mean that you will not be able to measure there later, when satellite coverage at the location improves.
- To get a fixed position solution with centimeter precision, initialize the RTK rover receiver. For initialization to take place, the receiver must track at least five satellites that the base station is also tracking. In a dual-satellite constellation operation, for example, GPS and GLONASS, the receiver must track at least six satellites.

- To continue to survey at centimeter precisions, the rover must continuously track at least four satellites that the base station is also tracking. The radio link between the base and rover receivers must also be maintained.
- Loss of the satellite signals will result in a loss of centimeter position precision.

## 5.2. ROVER STATION SETUP

1. If required, connect the radio antenna onto M6 receiver.
2. Screw the receiver on top of the range pole.
3. Fix the controller bracket on the range pole.
4. Fit the controller in the controller bracket.
5. Level and plumb the receiver over the target measuring point.



## 5.3. CONFIGURING THE ROVER STATION VIA LANDSTAR 6

### SOFTWARE

#### 5.3.1. RECEIVING CORRECTIONS USING INTERNAL RADIO MODEM

1. Power on the receiver.
2. Turn on the controller → run LandStar 6 → create a new project or open an existing project → establish the connection with receiver via Bluetooth or Wi-Fi (see [2.7. Connecting to a controller](#) for the

operations).

3. After successful connection, tap **Rover Config** in the *Device* screen.
4. In *Rover Config* screen, configure the related parameters from the dropdown list or enter the value with the soft keyboard: **Data Format**, **Elevation Mask**, **PDOP Limit**, **Safe Mode** and **Iono Condition**.

*Note* – Select the **Data Format** the same as that of base receiver.

5. Configure the antenna parameters as follows:

*Type* field: tap  next to *Type* field to select **CHCM6** as antenna type.

*Measure To* field: select **Bottom** from the dropdown list.

*Height* field: enter the height (in meters) of the range pole you are using.

6. If required, tick **Warning when base changed** option → tap  in the lower right corner to save the settings and go back to *Device* screen.

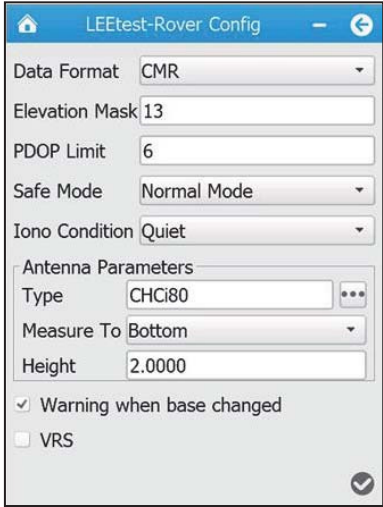

7. Tap **Communication Mode** → select **Radio** for *Mode* field.
8. Configure the radio parameters as follows:

*Protocol* field: select the protocol the same as that of base station.

*Freq* field: select the frequency the same as that of base station.

*Tip* – Users can select a radio channel from the dropdown list. The frequency of channel 1 to 9 is predefined; however, the frequency of channel 0 is editable.

*Baud* field: select the baud rate the same as that of base station.

*Power* field: select the power from the dropdown list according to your

need.

9. Tap  Set to confirm and save the settings of the radio.



10. After the radio parameters are successfully configured, tap  in the lower right corner to back to *Device* screen.
11. Users can conduct surveying work after the rover receiver receives correction data (with correction LED flashes once per second) and gets fixed solution.

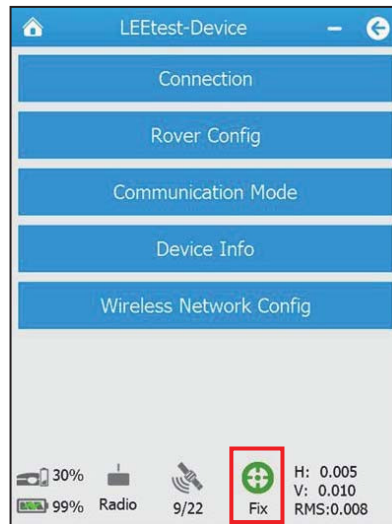

### 5.3.2. RECEIVING CORRECTIONS USING INTERNAL CELLULAR MODEM

1. Insert a SIM card into SIM card slot of the receiver (please see [2.4. Inserting battery and SIM card](#) for instruction) and the power on the receiver.
2. Turn on the controller → run LandStar 6 → create a new project or open

an existing project → establish the connection with receiver via Bluetooth or Wi-Fi (see 2.7. [Connecting to a controller](#) for the operations).

3. After successful connection, tap **Rover Config** in the *Device* screen.
4. In *Rover Config* screen, configure the related parameters from the dropdown list or enter the value with the soft keyboard: **Data Format**, **Elevation Mask**, **PDOP Limit**, **Safe Mode** and **Iono Condition**.

*Note* – Select the **Data Format** the same as that of base receiver.

5. Configure the antenna parameters as follows:

*Type* field: tap  next to *Type* field to select **CHCM6** as antenna type.

*Measure To* field: select **Bottom** from the dropdown list.

*Height* field: enter the height (in meters) of the range pole you are using.

6. If required, tick **Warning when base changed** option → tap  in the lower right corner to save the settings and go back to *Device* screen.

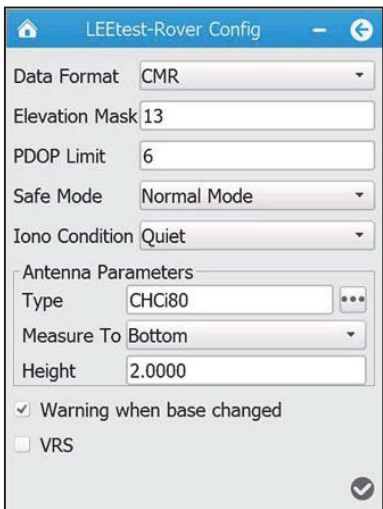



7. Tap **Communication Mode** → select **Network** for *Mode* field.
8. Configure the network parameters as follows:

*Protocol* field: select the protocol according to your need.

*IP Addr* field: enter the IP address and the Port with the soft keyboard,

or tap  next to this field to select the predefined service.

*Source* field: tap  next to this field to get the source table list, and

then tap  to select the suitable source table.

*User Name* field: enter the user name of the network (such as NTRIP network), if required.

*Password* field: enter the user name of the network (such as NTRIP network), if required.

9. Tap  Set to confirm and save the settings.



10. After the service is successfully logged on, tap  in the lower right corner to back to *Device* screen.

11. Users can conduct surveying work after the rover receiver receives correction data (with correction LED flashes once per second) and gets fixed solution.

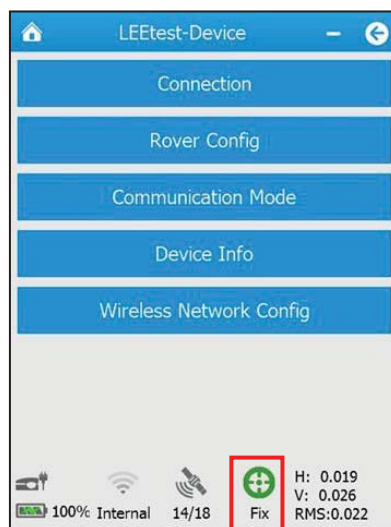



*Note* – Before switch to other communication mode, please tap  in *Communication Mode* screen to break the connection to the network.

### 5.3.3. RECEIVING CORRECTIONS USING CELLULAR MODEM IN THE CONTROLLER

1. Power on the receiver.
2. Insert a SIM card into SIM card slot of your controller, and then turn on the controller to establish network connection (please refer to corresponding user guide of the controller that you are using for instruction).
3. Run LandStar 6 on the controller → create a new project or open an existing project → establish the connection with receiver via Bluetooth or Wi-Fi (see 2.7. [Connecting to a controller](#) for the operations).
4. After successful connection, tap **Rover Config** in the *Device* screen.
5. In *Rover Config* screen, configure the related parameters from the dropdown list or enter the value with the soft keyboard: **Data Format**, **Elevation Mask**, **PDOP Limit**, **Safe Mode** and **Iono Condition**.

*Note* – Select the **Data Format** the same as that of base receiver.

6. Configure the antenna parameters as follows:

*Type* field: tap  next to *Type* field to select **CHCM6** as antenna type.

*Measure To* field: select **Bottom** from the dropdown list.

*Height* field: enter the height (in meters) of the range pole you are using.

7. If required, tick **Warning when base changed** option → tap  in the lower right corner to save the settings and go back to *Device* screen.

8. Tap **Communication Mode** → select **PDA Network** for *Mode* field.
9. Configure the network parameters as follows:

*Protocol* field: select the protocol according to your need.

*IP Addr* field: enter the IP address and the Port with the soft keyboard,

or tap  next to this field to select the predefined service.

*Source* field: tap  next to this field to get the source table list, and

then tap  to select the suitable source table.

*User Name* field: enter the user name of the network (such as NTRIP network), if required.

*Password* field: enter the user name of the network (such as NTRIP network), if required.

10. Tap  to log-in the network service.



11. After the successful login, tap  in the lower right corner to back to *Device* screen.
12. Users can conduct surveying work after the rover receiver receives correction data (with correction LED flashes once per second) and gets fixed solution.

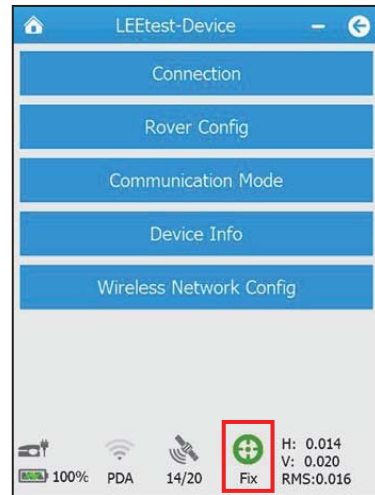

*Note – Before switch to other communication mode, please tap  Break in Communication Mode screen to break the connection to the network.*

## 6. SURVEY WITH LANDSTAR 6 SOFTWARE

The CHC Landstar 6 Software (“LandStar 6”) is a field survey software which developed based on more than ten years of development experience of CHC and feedback of surveyors from different fields of application. LandStar 6 provides with a complete set of features for any survey projects, including data collection, stakeout, COGO (Coordinate Geometry) function, and more, which makes this software an ideal option for everyday field work.

This chapter briefly introduces the basic survey workflows of LandStar 6, combining with M6 GNSS receiver.

### 6.1. NEW PROJECT

Turn on the controller, run LandStar 6 software and establish the connection with receiver via Bluetooth or Wi-Fi (see [2.7. Connecting to a controller](#) for the operations), and then create a new project or open an existing project before measuring any points, or making any calculations.

To create a new project:

1. Tap  button on the lower left corner of the initial interface that the LandStar 6 starts with.

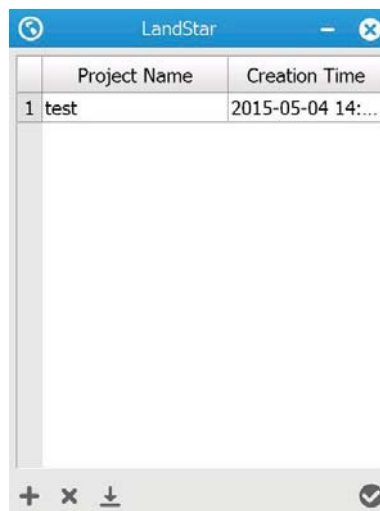

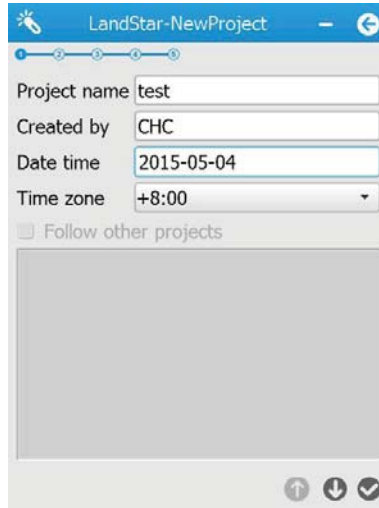

2. Enter the **Project name** and **Create by** (operator), select **Time zone** from the dropdown list, and then tap  button.

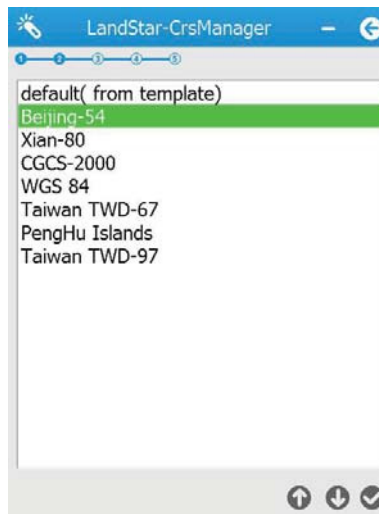

*Note – Also, users can configure other parameters, such as Create By (operator) and time zone, according to your need.*

3. Select one coordinate system from the template list, or tap **default (from template)** if there is no suitable template, and then tap  button.



4. Confirm the ellipsoid information or select one ellipsoid from the dropdown list for *Name* field, and then tap  button.



5. In *DatumWidget* screen, select one **Model** from the dropdown list.

There are three model options available:

- a) **NONE**: No transformation parameters are needed to be entered.
- b) **Bursa 7 Parameter**: Users need to enter seven parameters for local transformation, including translation, rotation and scale.
- c) **Molodensky 3 Parameter**: Users need to enter three translation parameters for local transformation.

*Note – To configure the parameters for Bursa 7 Parameter option and*

*Molodensky 3 Parameter option, users need to tap  button to unlock the editing function.*

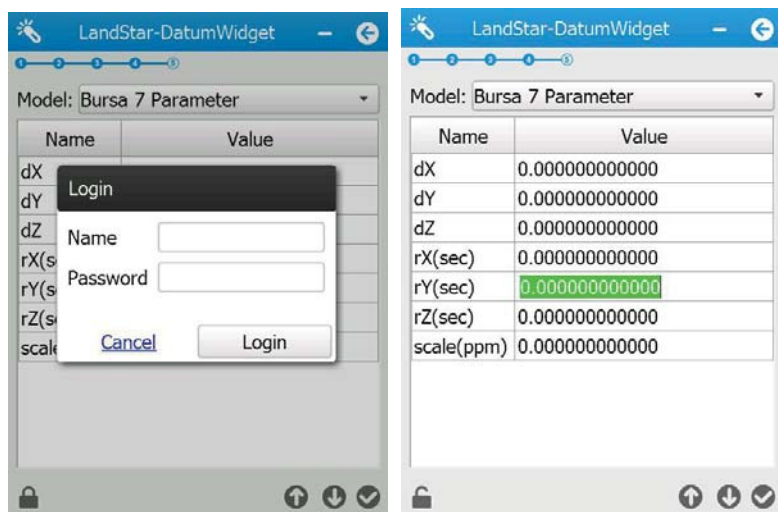

*Tip – The default login values of editing function are “admin” for Name and*

“123456” for Password.

6. Select one projection from the dropdown list, configure the projection related parameters, and then tap  button to save the new project.

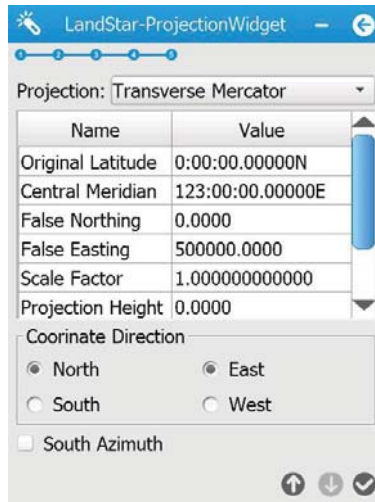

7. The project name appears in the title area of the main menu.



## 6.2. KEY IN POINTS

1. In the main menu, tap **Data** → tap **Point Management**.
2. Tap  button in the lower left corner of *Point Data Management* screen, and then configure the related parameters of the new point as follows:

*Name* field: enter the point name.

*Code* field: enter the code of the point, if required.

*CRS* field: select the coordination system from the dropdown list. The available options are: **Local** and **WGS84**.

*Role* field: select the role of the point from the dropdown list. The available options are: **Null**, **To Stake Out** and **Control**.

*X, Y, H* field: enter the local grid coordinate of the point.

3. Tap  button in the lower right corner of *New point* screen to save the point.

### 6.3. MEASURE POINTS

*Note – To ensure the accuracy of the coordinates measured, please perform measurements after the rover receiver receives correction data (with correction LED flashes once per second) and gets fixed solution.*

#### 6.3.1. MEASURE POINTS IN CONVENTIONAL MODE

1. In the main menu, tap **Survey** → tap **Point Survey**.
2. Enter the point name in the input frame on the top left corner.

*Notes*

- *The system will automatically increment the numeric component of the measured point name.*
  - *The measured points will be automatically incremented from “P1”, by default.*
3. If necessary, enter the feature code in the input frame on the top right corner.
  4. Tap  button to select a measurement mode in the pop-up window.

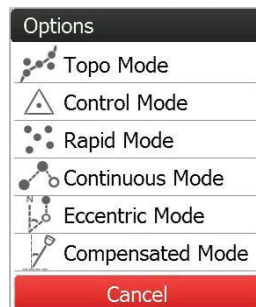

*Notes*

- Users can tap  button to configure the settings of each





measurement method in the pop-up Survey Option screen.

- The auto measure function is available for three measurement modes: Topo Mode, Rapid Mode and Compensated Mode (require the calibration of tilt sensor beforehand, see 6.3.2. Survey with tilt sensor for reference).

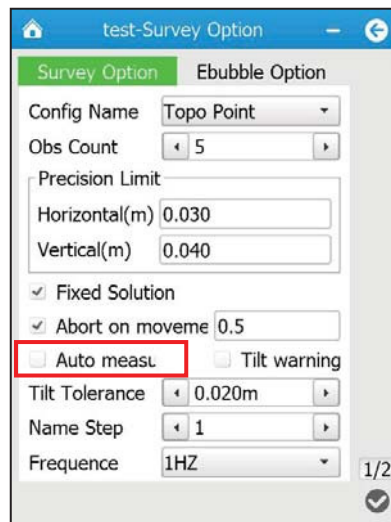
When untick **Auto measure** in the Survey Option screen:



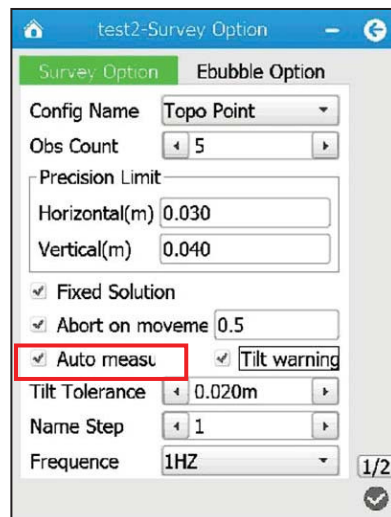

5. If the settings of the selected measurement method have been changed, tap  button in the lower right corner of the Survey Option screen to save the change and go back to the Point Survey screen.
6. Tap  button, hold the range pole until the countdown timer disappears, and then move to next point to continue.

When tick **Auto measure** in the Survey Option screen:



*Note – Users can configure the Tilt Tolerance option to define the maximum radius that the receiver can tilt and be considered in tolerance. The allowable range is 0.001m to 1.000m. And the maximum tilt angle is calculated by  $\arctan(\text{Tilt Tolerance}/\text{antenna height})$ .*

5. If the settings of the selected measurement method have been changed, tap  button in the lower right corner of the *Survey Option* screen to save the change and go back to the *Point Survey* screen.
6. Tap  button in the tool bar to display the eBubble.
7. Tap  button → a “Waiting to move” message appears over the eBubble → tilt the range pole (exceeding the specified tilt tolerance).

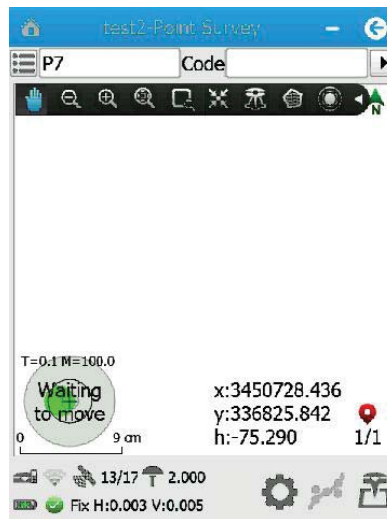

8. A “Waiting for level” message appears over the eBubble → move the receiver to the target measuring point → level the range pole.



9. When the range pole is within the tilt tolerance, a “Waiting for stable” message appears.



10. Hold the range pole for more than 2 seconds and the point will automatically begin measuring.

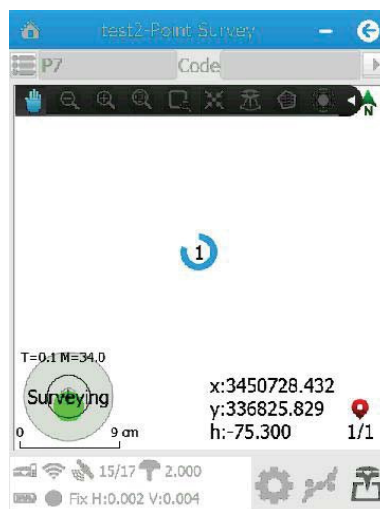

11. When the countdown timer disappears, tilt the range pole outside of the tilt tolerance, and then move to next point to continue.
12. To exit the **Auto Measure** mode, tap  button.

### 6.3.2. SURVEY WITH TILT SENSOR

The M6 receiver is integrated with tilt sensor, which allows the use of eBubble (electronic bubble) and tilt compensation. The tilt compensation allows the collection of points even when the receiver is tilted up to 30 degrees off plumb. When the terrain or structures around the point do not allow full plumbing of the receiver, the built-in tilt sensor will compensate

for the tilt of the range pole. The eBubble can be displayed in the lower left corner of any survey window within the CHC LandStar 6 software.

To bring the eBubble and tilt compensation into full play, it is very important to ensure the integrated tilt sensor is correctly calibrated. When calibrating the integrated tilt sensor, users need to make sure that a range pole or a tripod with tribrach have been well calibrated. The quality of the integrated tilt sensor calibration is directly related to the quality of the mechanic bubble and its calibration.

The integrated tilt sensor calibration is performed within the CHC LandStar 6 software. To calibrate the integrated tilt sensor, place the receiver on a stable range pole or tripod with tribrach. Level the receiver using the mechanical bubble on the range pole or tribrach.

### 6.3.2.1. Calibrating the tilt sensor

1. In the main menu, tap **Settings** → tap **Survey Options** → select **Ebubble Option** tab.
2. Configure the **Sensitivity**, **Response** and **Age Limit** from the dropdown lists.
3. Tap  button in the lower left corner → a message will pop up asking user to confirm that the device is level → tap **Yes** button.



4. A progress message will appear to indicate that the calibration is in progress.

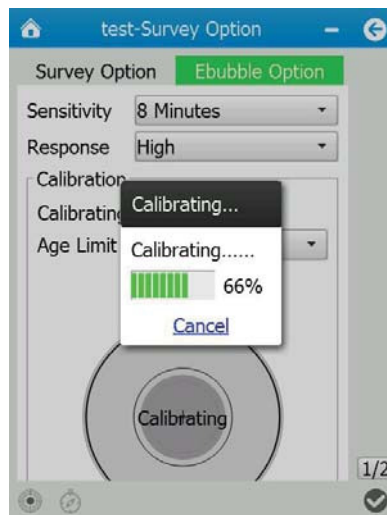

- Once the calibration is complete, the green electronic bubble will be centered in the inner circle.

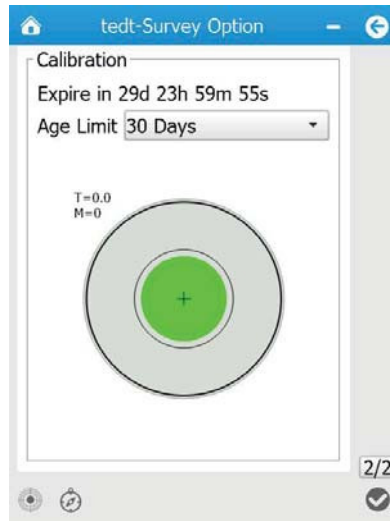

- Tap  button in the lower left corner → a pop-up message will prompt user rotate the device follow the illustration during the compass calibration → tap **Yes** button.

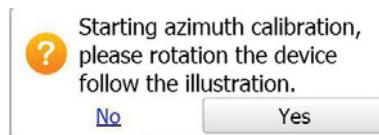

- Perform the calibration according to the graphic displayed on the screen.

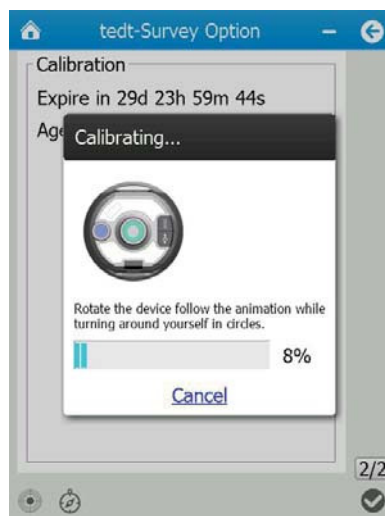

- Once the calibration is complete, tap  button in the lower right

corner.

### 6.3.2.2. Measure points in compensated mode

9. Go back to the main menu, tap **Survey** → tap **Point Survey**.
10. Enter the point name in the input frame on the top left corner.

#### Notes

- *The system will automatically increment the numeric component of the measured point name.*
  - *The measured points will be automatically incremented from "P1", by default.*
11. If necessary, enter the feature code in the input frame on the top right corner.
  12. Tap  button → select **Compensated Mode** in the pop-up window.

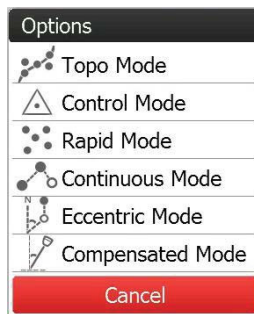



#### Notes

- *Users can tap  button to configure the settings of the Compensated Mode in the pop-up Survey Option screen.*
- *The auto measure function is available for the Compensated Mode.*

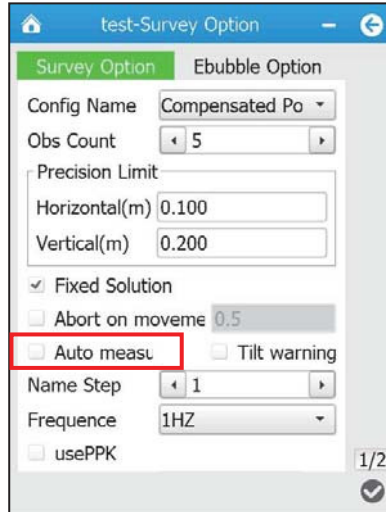
When untick **Auto measure** in the Survey Option screen:



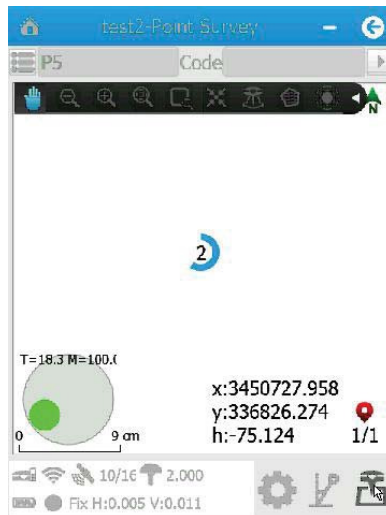

13. If the settings of the Compensated Mode have been changed, tap  button in the lower right corner of the *Survey Option* screen to save the change and go back to the *Point Survey* screen.
14. Tilt the range pole within 30 degrees off plumb → Tap  button, hold the range pole until the countdown timer disappears → move to next point to continue.

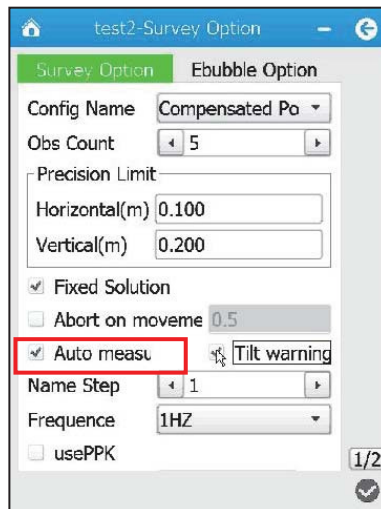

*Tip – The color of eBubble indicates different tilt status of the range pole. Red means the tilt of the range pole exceeds 30 degrees; however, yellow or green means the tilt is within 30 degrees or 24 degrees.*

When tick **Auto measure** in the *Survey Option* screen:



13. If the settings of the Compensated Mode have been changed, tap  button in the lower right corner of the *Survey Option* screen to save the change and go back to the *Point Survey* screen.
14. Tap  button → a “Waiting to move” message appears over the eBubble → tilt the range pole to more than 30 degrees.



15. A “Waiting for level” message appears over the eBubble → move the receiver to the target measuring point → tilt the range pole within 30 degrees.



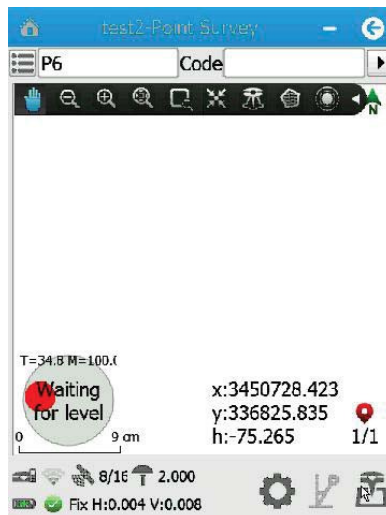

16. When the range pole is within 30 degrees, a “Waiting for stable” message appears → hold the range pole for more than 2 seconds and the point will automatically begin measuring.



17. When the countdown timer disappears, tilt the range pole by more than 30 degrees, and then move to next point to continue.
18. To exit the **Auto Measure** mode, tap  button.

## 6.4. POINT ADJUST (SITE CALIBRATION)

Point adjust, also known as “site calibration”, is used to transform WGS-84 coordinates into local grid coordinates.



### Notes

- *General speaking, if a three- or seven-parameter datum transformation has been configured for project, users can skip the*

site calibration and the coordinates measured will be transformed automatically into local grid coordinates.

- If a projection and datum transformation have already been specified, users can reduce any discrepancies between the WGS-84 coordinates and the local grid coordinates by performing a site calibration.
- To perform the site calibration, users need to measure the control points with GNSS receiver first.

To perform site calibration:

1. In the main menu, tap **Survey** → tap **Point Adjust**.
2. Tap  button in the lower left corner to add point pair(s).
3. In the pop-up screen, tap  button on the upper side of the screen to add the existing GNSS point or key in a GNSS point.
4. Tap  button on the lower side of the screen to add the existing known point or key in a known point.

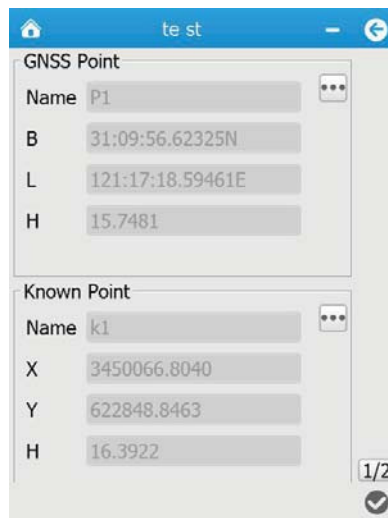

5. Tap  button to go down to the bottom of the page.
6. Select the adjustment method from the dropdown list next to *Method* field.

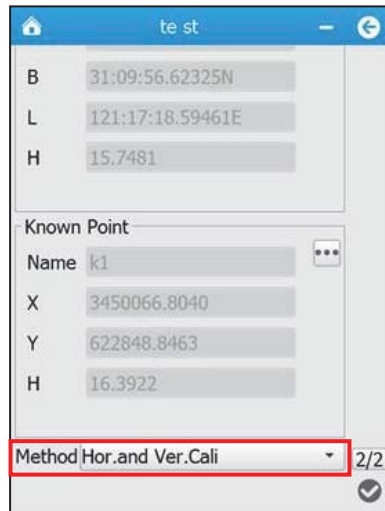

Note – Users can determine whether this point pair is involved in the computation of either horizontal or vertical adjustment, or both.

7. Tap  button in the lower right corner to save the point pair.
8. Continue the **Step 2** to **Step 7** to add all the point pairs.
9. If necessary, select the fit method for vertical adjustment from the dropdown list next to *Fit Method* field.

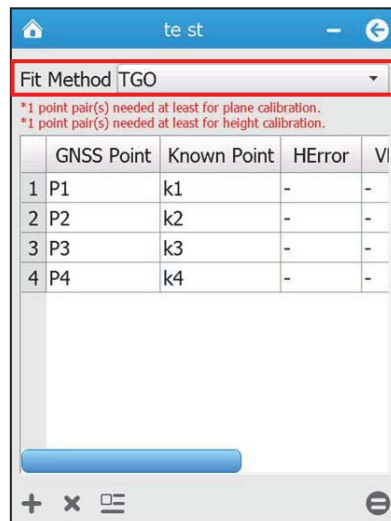

Notes

- The fit methods of horizontal and vertical adjustment are “TGO” and “Fixed difference” respectively, by default.
- There are four available fit methods for vertical adjustment: Fixed difference, Plane fitting, Curved surface fitting and TGO.

1. The “Fixed difference” fit method is used when the measuring surface is almost horizontal, and it requires at least 1 point pair with elevation information to be involved in the computation.

2. The “Plane fitting” fit method is used when the measuring surface is level, and it requires at least 3 point pair with elevation information to be involved in the computation.
3. The “Curved surface fitting” fit method is used when the measuring surface is uneven, and it requires at least 6 point pair with elevation information to be involved in the computation.
4. The “TGO” fit method is almost the same with “Fixed difference”, except that this method is more convenient for computation using computer.

10. Tap  button to perform the calibration, and then the “HError” and “VError” information related to each point pair will be displayed.

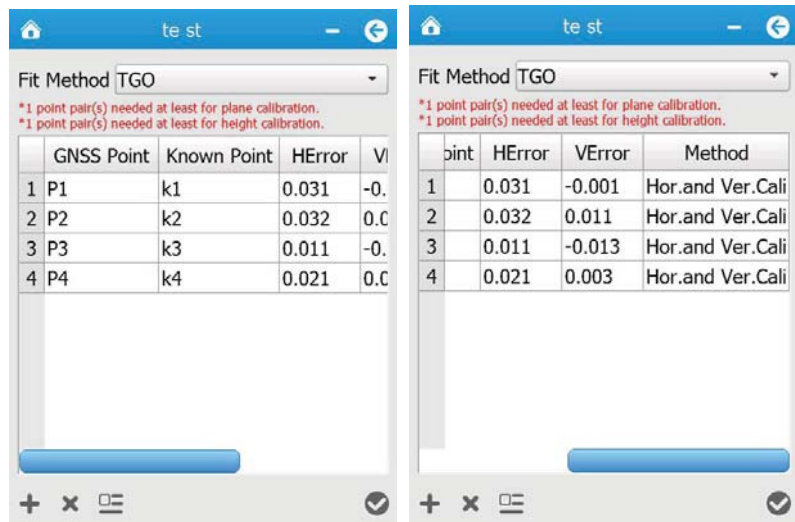

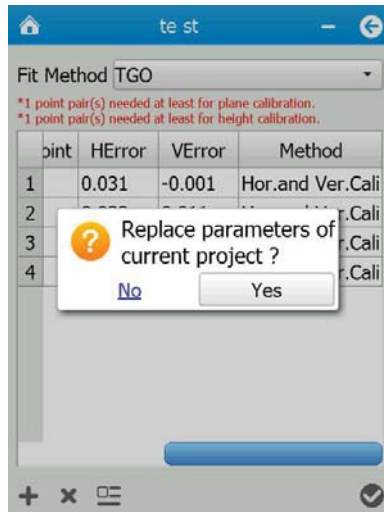

*Note – For best results, make sure that the control points are evenly distributed to the extent of the job area.*

11. Tap  button → a message will pop up asking user whether to replace parameters of current project.

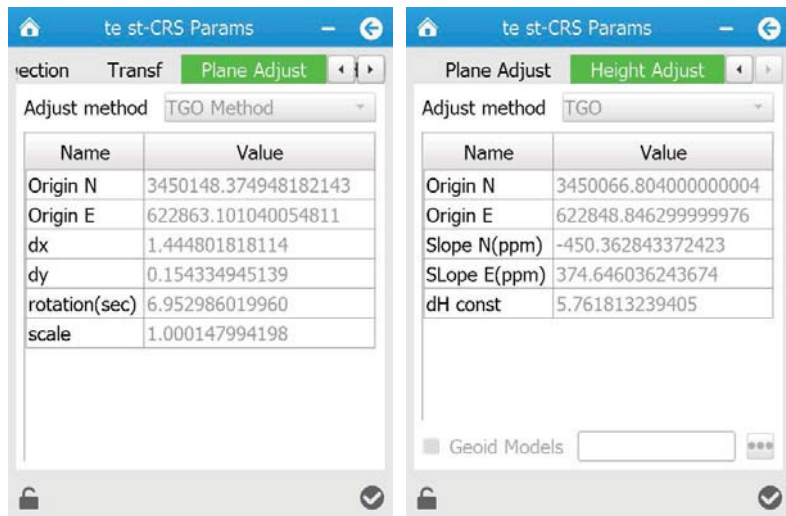

12. If tap **YES** button, the parameters calculated by this calibration will be applied to the coordinate system of the current project. Also, the *Point Adjust* screen will skip to the *CRS Params* screen to help user check the horizontal and vertical adjustments in **Plane Adjust** tab and **Height Adjust** tab.



*Note – To check the horizontal and vertical adjustments in **Plane Adjust** tab and **Height Adjust** tab, users need to tap  button to unlock the display function first.*

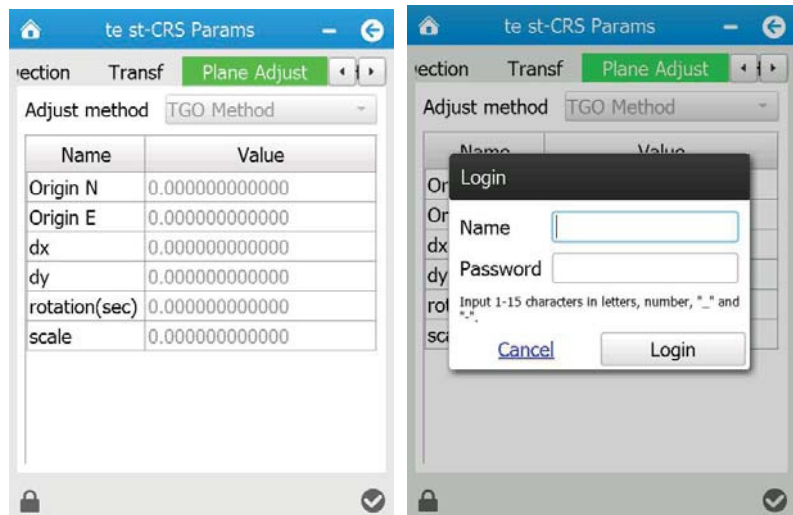

*Tip – The default login values of display function are “admin” for Name and “123456” for Password.*

## 6.5. BASE SHIFT

Typically, the Real-time kinematic (RTK) operation requires a data link to send observations or corrections from the base station to the rover, and then the rover will calculate its position in real time.

Within a project, when the base receiver is restarted or moved, the base coordinated system will shift each time the position of base station is changed. Normally, the coordinates determined by the base station that set up on a control point should be in the same coordinate system. However, coordinates determined by the base station that set up on an autonomous point should be carried out a base shift, which is provided by CHC LandStar 6 software, to keep their base station coordinate the same as the initial coordinate system.

*Notes – To perform the base shift, make sure that the two base stations have been linked together by at least one common point that shares with the same position, which means that the common point not only has the coordinate determined by the initial coordinate system, but also owns the coordinate surveyed from another base coordinate system that needs to be shifted.*

To perform a base shift:

1. In the main menu, tap **Survey** → tap **Base Shift**.
2. Tap  button next to the *GNSS Point* field to select the common point surveyed from the base coordinate system that needs to be

shifted.

3. Tap  button next to the *Known Point* field to select that common point *determined by the* initial coordinate system.
4. The offset information of base coordinate system that need to be shifted will be displayed automatically.

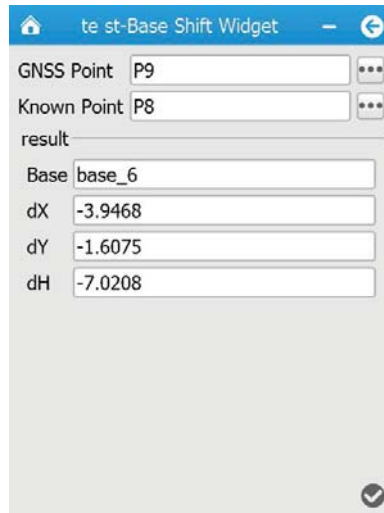

5. Tap  button → a message will pop up asking user whether to translate the coordinates determined by the current base coordinate system to the initial one.

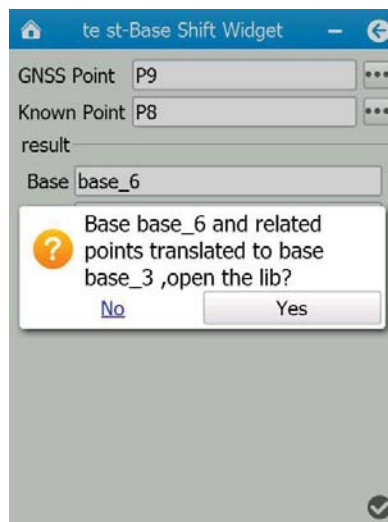

6. If tap **YES** button, all the coordinates determined by the current base coordinate system will be translated. Also, the *Point Data Management* screen will pop up to help user check whether the coordinates determined by the current base coordinate system have changed.

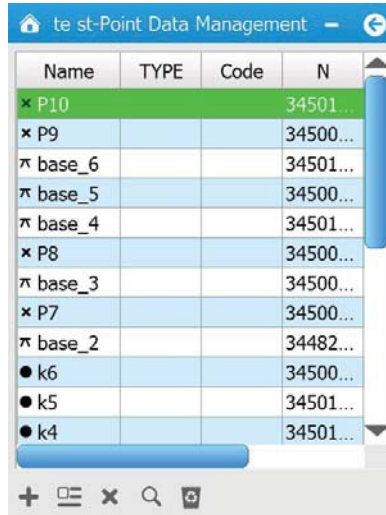

Name	TYPE	Code	N
× P10			34501...
× P9			34500...
π base_6			34501...
π base_5			34500...
π base_4			34501...
× P8			34500...
π base_3			34500...
× P7			34500...
π base_2			34482...
● k6			34500...
● k5			34501...
● k4			34501...

*Note – The coordinates translated are local grid coordinates rather than WGS-84 coordinates.*

## 6.6. DATA EXPORT

1. In the main menu, tap **Project** → tap **Export**.
2. Select one data format (for example, **Custom Format**) according to your requirement.
3. Tick the point type(s) → enter the **File Name** → select the **File Type** from the dropdown list → select the path that used to store the file.

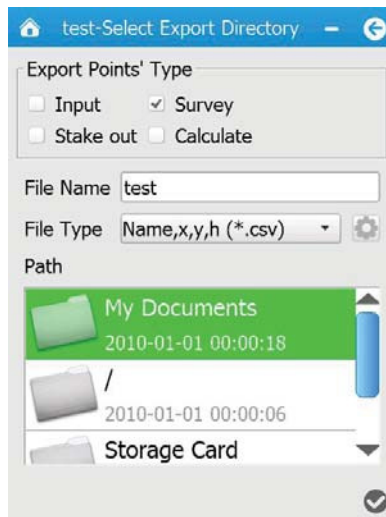

test-Select Export Directory

Export Points' Type

Input  Survey

Stake out  Calculate

File Name: test

File Type: Name,x,y,h (\*.csv)

Path

My Documents  
2010-01-01 00:00:18

/  
2010-01-01 00:00:06

Storage Card

✓

4. Tap ✓ button → the software will prompt whether the file has been successfully exported.



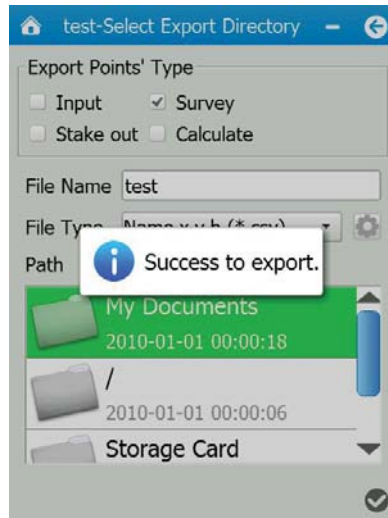

#### Notes

- When select custom format, users can tap  button next to File Type field to define the file format according to your requirement.
- After the file has been successfully exported in the controller, connect the controller to the office computer for file transfer (please refer to corresponding user guide of the controller that you are using for instruction) and postprocessing.

## 6.7. RECEIVER REGISTRATION

When the software prompt that the receiver is overdue, users need to contact your local CHC dealer to get the registration code.

To register the receiver:

1. In the main menu, tap **Device** → tap **Device Info**.
2. Tap  **Register** button in the lower left corner.
3. Enter the registration code in the pop up window.

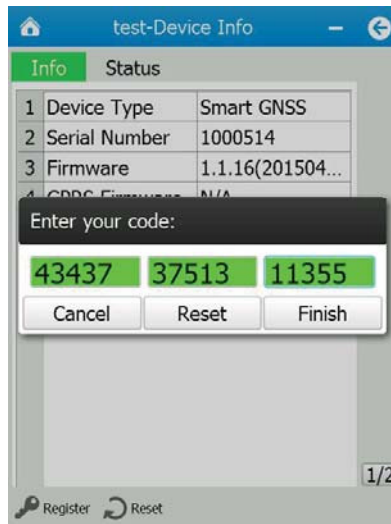

4. Tap **Finish** button to complete the registration, and then the software will show the expire date.

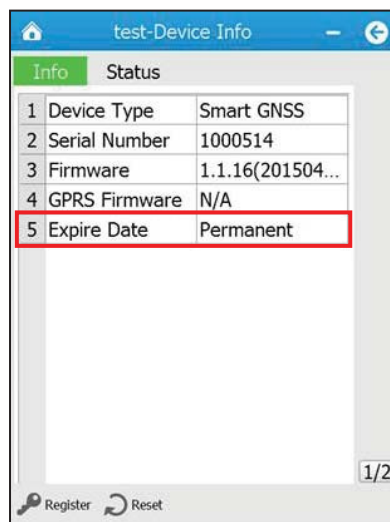

## 7. CONFIGURING THROUGH A WEB BROWSER

Supported browsers:

- Google Chrome
- Microsoft Internet Explorer® version 10, or higher

To connect to the receiver through a web browser:

1. Turn on the Wi-Fi of the receiver.
2. Search the wireless network named as GNSS-XXXXXXX (the SN of your receiver) on your computer, and then establish the connection.
3. After the successful connection between your computer and the receiver, enter the IP address of the receiver into the address bar of the web browser on your computer:

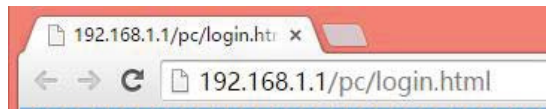

4. The web browser prompts you to enter a login account and password:

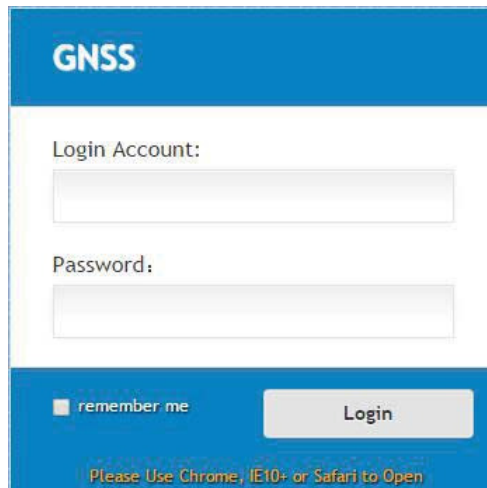
A screenshot of a web browser displaying a login page for a device labeled "GNSS". The page has a blue header with the text "GNSS" in white. Below the header, there are two input fields: "Login Account:" and "Password:". Below the "Password:" field, there is a checkbox labeled "remember me" and a "Login" button. At the bottom of the page, there is a small text message: "Please Use Chrome, IE10+ or Safari to Open".

The default login account for the receiver is:

- Login Account: admin
- Password: password

*Note – Tick **remember me** option, and then the browser will remember the Login Account and Password you entered for the next time you enter this login screen.*

5. Once you are logged in, the web page appears as follows:

The screenshot displays the web interface of a GNSS receiver. The top header includes the CHC logo with the slogan '振兴中华 测绘天下' (Revitalize China, Survey the World), the GNSS logo, and a language dropdown menu set to 'English'. The main content area is divided into two sections: a left sidebar with configuration menus and a right main panel showing status information.

**Configuration Menus (Left Sidebar):**

- Position
- Operation
- Google Map
- Satellites
- Receiver Settings
- Data Recording
- IO Settings
- GPRS
- Wifi
- Bluetooth Set
- Radio Settings
- Network Service
- Firmware

**Status Information (Right Panel):**

**Position**

Position	DOP
Longitude: 121°17'18.27854622"(East)	PDOP: 6.691169
Latitude: 31°9'57.83422286"(North)	HDOP: 4.909280
Height: 22.342	VDOP: 4.546506
Type: Float	TDOP: 5.665024

**Satellite Used**

Satellite Used	Tracked Satellites
Satellite Number: 19Piece	Satellite Number: 20Piece
GPS( 7): 22,26,3,16,32,23,27	GPS( 8): 22,31,26,3,16,32,23,27
SBAS( 0):	SBAS( 0):
GLON( 5): 16,15,4,3,5	GLON( 5): 16,15,4,3,5
BDS( 7): 5,8,10,9,3,6,2	BDS( 7): 5,8,10,9,3,6,2
GALILEO( 0):	GALILEO( 0):

**Receiver Clock**

GPS Week: 1844
GPS second: 445089

This web page shows the configuration menus on the left of the browser window, and the setting on the right. Each configuration menu contains the related submenus to configure the receiver and monitor receiver performance.

This chapter describes each configuration menu.

To view the web page in another language, select the corresponding language name from the dropdown list on the upper right corner of the web page.

Currently, three languages are available:

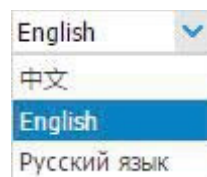

## 7.1. STATUS MENU

This menu provides a quick link to review the receiver's position information, satellites tracked, runtime, current data log status, current outputs, available memory, and more.



### 7.1.1. POSITION SUBMENU

This page shows the relevant position information about the receiver's position solution which including the position, DOP values, satellites used and tracked, and the receiver clock information.

Position	
<b>Position</b>	<b>DOP</b>
Longitude: 121°17'18.27854622"(East)	PDOP: 6.691169
Latitude: 31°9'57.83422286"(North)	HDOP: 4.909280
Height: 22.342	VDOP: 4.546506
Type: Float	TDOP: 5.665024
<b>Satellite Used</b>	<b>Tracked Satellites</b>
Satellite Number: 19Piece	Satellite Number: 20Piece
GPS( 7): 22,26,3,16,32,23,27	GPS( 8): 22,31,26,3,16,32,23,27
SBAS( 0):	SBAS( 0):
GLON( 5): 16,15,4,3,5	GLON( 5): 16,15,4,3,5
BDS( 7): 5,8,10,9,3,6,2	BDS( 7): 5,8,10,9,3,6,2
GALILEO( 0):	GALILEO( 0):
<b>Receiver Clock</b>	
GPS Week: 1844	
GPS second: 445089	

### 7.1.2. OPERATION SUBMENU

Lists several important items to help you understand how the receiver is being used and its current operating condition. Items include the identities of currently tracked satellites, internal and external storage usage rate, how long the receiver has been operational, state of the internal battery, power source state, files being logged, and data streams being output. With this information, it is easy to tell exactly what functions the receiver is performing:

**Receiver Activated**

**Satellites Track**

Tracked Satellites: 14Piece

GPS(6): 9,19,27,31,16,23

SBAS(0):

GLON(3): 5,6,16

BDS(5): 2,3,5,9,8

GALILEO(0):

**Activity Status**

Current Time: 2015-5-15 05:37:05 (UTC)

Operation Time: 0-0-0 00:08:45

Internal Storage:  145MB/14457MB

External Storage:  Not Connected

Outter Power: Connected

Battery1:

Battery2:

---

**Data Log()**

Recording Number	Recording Name	On Or Off	Log Status
1	recor01	No	Not Record
2	recor02	No	Not Record
3	recor03	No	Not Record
4	recor04	No	Not Record
5	recor05	No	Not Record
6	recor06	No	Not Record
7	recor07	Yes	Not Record
8	recor08	No	Not Record

---

**Data Export**

Port Type	Output Data
1	RTK Client
2	TCP/UDP_Client1
3	TCP/UDP_Client2
4	TCP/UDP_Client3
5	TCP/UDP_Client4
6	TCP/UDP_Client5
7	TCP/UDP_Client6
8	TCP Server/WIFI Client
9	TCP Server/WIFI Client
10	TCP Server/WIFI Client
11	TCP Server/WIFI Client
12	Com Port
13	Bluetooth
14	Radio

### 7.1.3. GOOGLE MAP SUBMENU

Tap this submenu to show the location of the receiver on Google map.

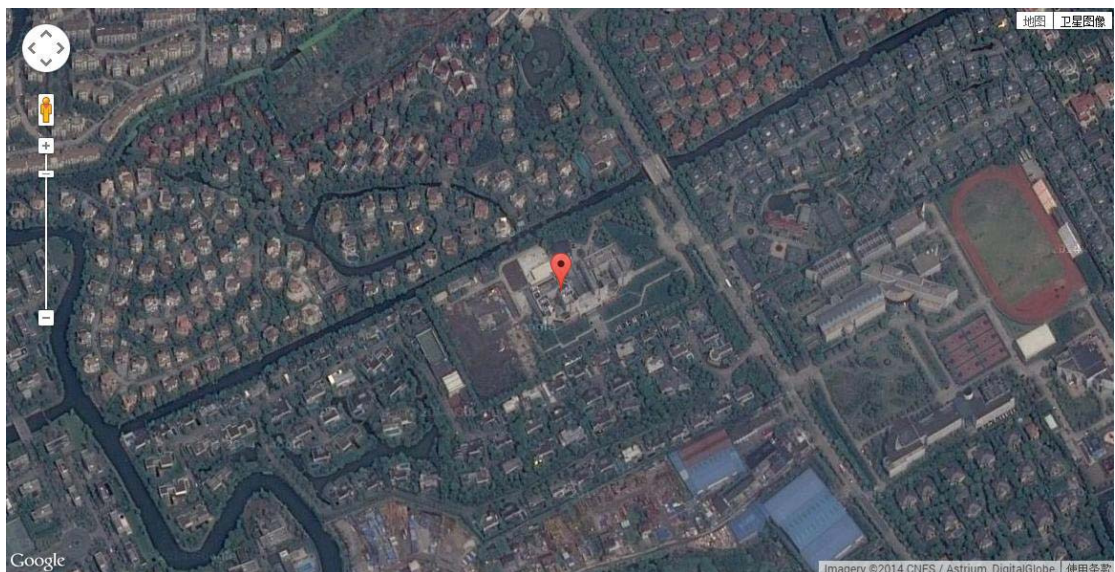

## 7.2. SATELLITES MENU

Use the Satellites menu to view satellite tracking details and enable/disable GPS, SBAS, GLONASS, BDS and Galileo constellations. These menus include tabular and graphical displays to provide all required information on satellite tracking status.



### 7.2.1. SATELLITE TRACK TABLE SUBMENU

Provides the status of satellites tracked in general, such as the satellite ID, satellite type, attitude angle, azimuth angle, L1 SNR, L2 SNR, L5 SNR and enable/disable status of each one.

Satellite Track Table

All GPS SBAS GLON BDS GALILEO

Satellite Id	Type	Altitude Angle	Azimuth Angle	L1 SNR	L2 SNR	L5 SNR	Enable/Disable
9	GPS	28	306	39.000	36.000	0.000	Yes
19	GPS	38	202	45.000	30.000	0.000	Yes
27	GPS	73	189	41.000	36.000	0.000	Yes
31	GPS	33	112	26.000	0.000	0.000	No
16	GPS	59	353	28.000	0.000	0.000	No
28	GPS	44	41	25.000	0.000	0.000	No
23	GPS	47	275	44.000	25.000	0.000	Yes
19	GLONASS	25	185	42.000	37.000	0.000	Yes
7	GLONASS	11	308	41.000	33.000	0.000	Yes
6	GLONASS	15	258	46.000	37.000	0.000	Yes
17	GLONASS	20	31	21.000	0.000	0.000	No
16	GLONASS	46	352	25.000	0.000	0.000	No
9	GLONASS	11	311	39.000	26.000	0.000	No
2	BDS	32	239	36.000	44.000	0.000	No
3	BDS	53	200	36.000	42.000	0.000	No
5	BDS	14	254	37.000	44.000	0.000	No
9	BDS	10	216	40.000	44.000	0.000	No
8	BDS	57	185	39.000	37.000	0.000	No

### 7.2.2. SATELLITE TRACK DIAGRAM SUBMENU

The following figure is an example of satellite track diagram page. Users can determine the satellite types and the corresponding SNR of L-band carriers to be displayed in any combination.

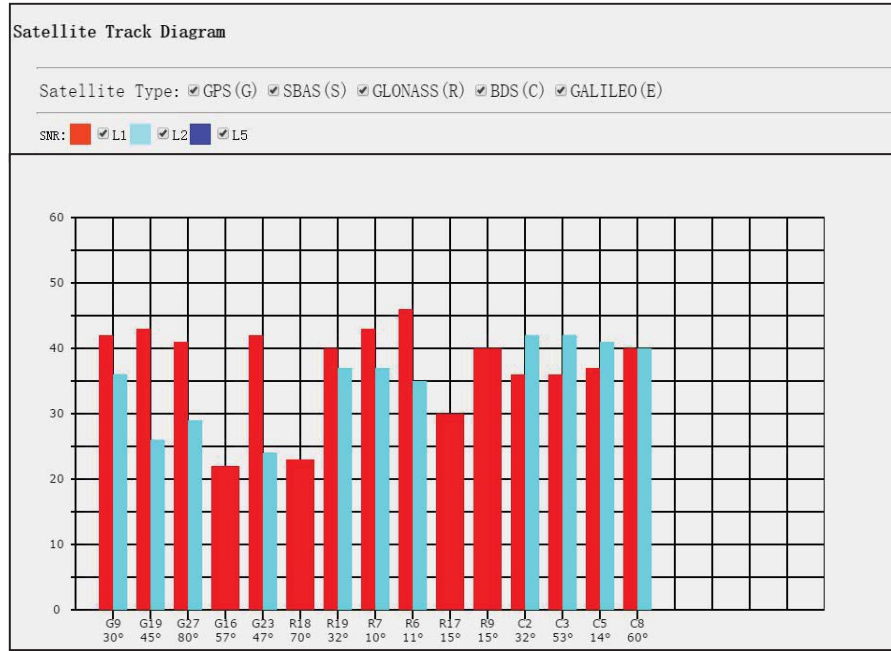

### 7.2.3. SKYPLot SUBMENU

The following figure is an example of Skyplot page.

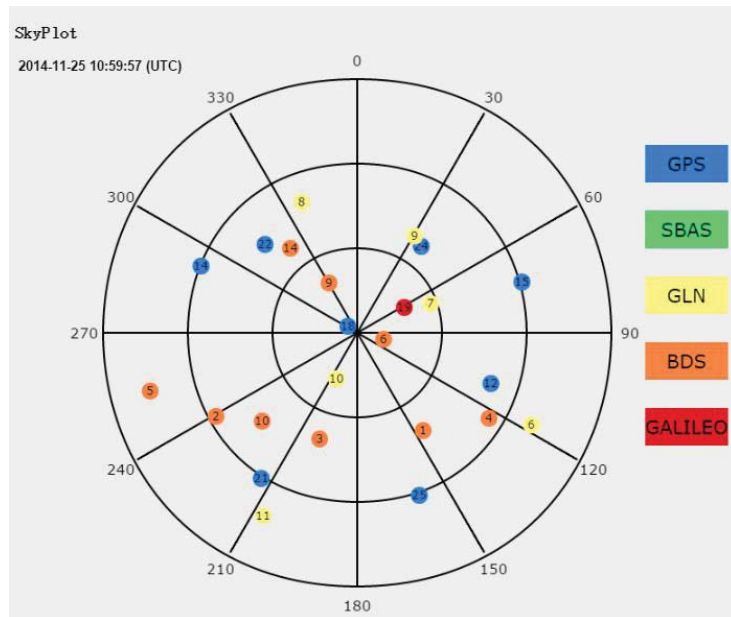

### 7.3. RECEIVER SETTINGS MENU

Use this menu to configure settings such as the antenna type and height, elevation mask and PDOP setting, the reference station coordinates, receiver resetting and web interface language:



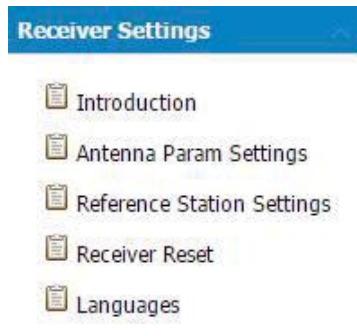

### 7.3.1. INTRODUCTION SUBMENU

This submenu shows the receiver information and reference station information, including antenna related information, elevation mask angle, reference station work mode and position, etc.

GNSS Info	
<b>Receiver Info:</b>	<b>Reference Station Info:</b>
Antenna Type: CHCI80	Reference Station Mode: Auto Rover
The Number Of Antenna: 1	Reference Latitude: 0°0'0.0000000"(South)
Measure Method: Antenna Phase Center	Reference Longitude: 0°0'0.0000000"(West)
Antenna Height: 2.0000(Meter)	Reference Height: 0.000
Mask Angle: 13	
PDOP Setting: 6	

### 7.3.2. ANTENNA PARAM SETTINGS SUBMENU

Use this screen to configure all of the items relating to the GNSS antenna. You must enter the correct values for all antenna-related fields, as the choices you make significantly affect the accuracy for logged data and broadcast correction data:

 A screenshot of the 'Antenna Param Settings' form. The form has a title 'Antenna Param Settings' and contains several input fields:
 

- Measure Method: A dropdown menu with 'Antenna Phase Center' selected.
- Antenna manufacturer: A dropdown menu with 'CHCNav' selected.
- Antenna Type: A dropdown menu with 'CHCI80' selected.
- The Number Of Antenna: A text input field containing '1'.
- Antenna Height: A text input field containing '2.0000' with '(Meter)' to its right.
- Mask Angle: A text input field containing '13'.
- PDOP Setting: A text input field containing '6'.

 At the bottom of the form, there is a 'Save' button with a floppy disk icon.

### 7.3.3. REFERENCE STATION SETTINGS SUBMENU

Use this screen to configure settings such as the station coordinates and the broadcast station identifiers. You must enter accurate information in these fields, as this data significantly affects the accuracy of logged data files and broadcast correction data:

#### Reference Station Settings

Reference Station Mode:

Base Station Name:

Base Station Number:

Reference Height:

Reference Latitude: ° ' ''  S  N

Reference Longitude: ° ' ''  E  W

Acquire Current Position

Sample for Average:

Positioning Limit:  Single Solution Coordinates  Fixed Solution Coordinates

Sampling Amount:   Start Stop

Save

#### Reference Station Settings

Reference Station Mode:

Reference Height:

Reference Latitude: ° ' ''  S  N

Reference Longitude: ° ' ''  E  W

Acquire Current Position

Sample for Average:

Positioning Limit:  Single Solution Coordinates  Fixed Solution Coordinates

Sampling Amount:   Start Stop

Save

#### For Reference Station Mode:

There are three modes available:

- a) **Auto Rover:** The receiver will serve as a rover after this mode is enabled, and then receive correction data through the working mode set last time.

- b) **Auto Base:** The receiver will serve as a base after this mode is enabled, and then broadcast correction data based on coordinate inputted by user, or obtained through autonomous positioning automatically.
- c) **Manual Base:** The receiver will serve neither as a base or a rover after this mode is enabled. Users need to configure the receiver manually.

#### For **Reference Latitude** and **Reference Longitude:**

There are mainly three methods to enter the reference coordinates and shown as follows:

- a) **Acquire Current Position:** Click this button to acquire current position obtained through autonomous positioning automatically.
- b) **Manual Input:** Manually input the coordinate of a control point.
- c) **From CORS:** After the receiver logging in CORS, the software can record the coordinate of current position based on fix solution.

#### For **Sample for Average:**

Users can determine the positioning limit and sampling amount. The positioning limit falls into two types:

- a) **Single Solution Coordinates:** Collect the coordinates of receiver obtained through autonomous positioning.
- b) **Fixed Solution Coordinates:** Only collect coordinates of receiver with a fixed solution.

After the configuration of positioning limit and sampling amount, click



to carry out sampling and averaging → the progress bar will show the progress → the result will be served as the coordinate of current position.

If users need to save the changes, please tap  button.

#### 7.3.4. RECEIVER RESET SUBMENU

Use this screen to completely or partially reset the receiver:



### 7.3.5. LANGUAGES SUBMENU

Use this screen to select the web interface language:

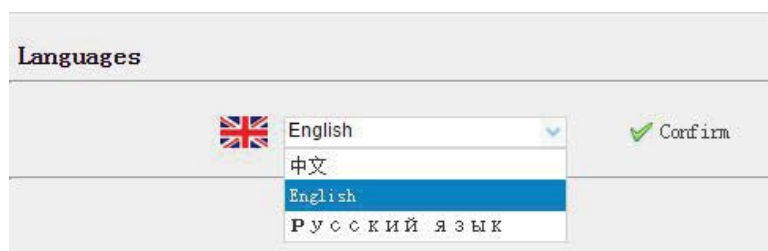

## 7.4. DATA RECORDING MENU

Use the Data Logging menu to set up the receiver to log static GNSS data and to view the logging settings. You can configure settings such as observable rate, recording rate, continuous logging limit, and whether to auto delete old files if memory is low. This menu also provides the controls for the FTP push feature:

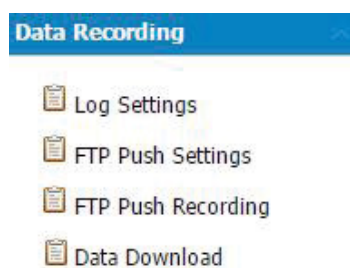

### 7.4.1. LOG SETTINGS SUBMENU

Shows the data logging status, internal and external storage usage and data logging status of each session. Also, users can configure the data logging settings for each session, including recording name, store location, storage limit, store formats, start time, etc.

### Log Settings

**Store Info**

	Position	Total Storage	Free Space
1	Internal Storage	14457MB	14319MB
2	External Storage	0MB	0MB

**Record Info**

Clear All Accounts

Recording Number	Recording Name	On Or Off	Log Status	Setting Parameter	Switch	Clear Data
1	record1	No	Not Record	<a href="#">Modify</a> / <a href="#">Detail</a>	ON/OFF	<a href="#">Clear</a>
2	record2	No	Not Record	<a href="#">Modify</a> / <a href="#">Detail</a>	ON/OFF	<a href="#">Clear</a>
3	record3	No	Not Record	<a href="#">Modify</a> / <a href="#">Detail</a>	ON/OFF	<a href="#">Clear</a>
4	record4	No	Not Record	<a href="#">Modify</a> / <a href="#">Detail</a>	ON/OFF	<a href="#">Clear</a>
5	record5	No	Not Record	<a href="#">Modify</a> / <a href="#">Detail</a>	ON/OFF	<a href="#">Clear</a>
6	record6	No	Not Record	<a href="#">Modify</a> / <a href="#">Detail</a>	ON/OFF	<a href="#">Clear</a>
7	record7	Yes	Not Record	<a href="#">Modify</a> / <a href="#">Detail</a>	ON/OFF	<a href="#">Clear</a>
8	record8	No	Not Record	<a href="#">Modify</a> / <a href="#">Detail</a>	ON/OFF	<a href="#">Clear</a>

To edit the settings of each session, click the **Modify** button to the right of the required session, and then the *Recording Edit* screen appears:

The **Recording Edit** dialog box contains the following fields and options:

- Recording Name:** record1
- Sample Interval:** 1Hz
- Store Location:** Internal Storage
- Start Time:** 10:30 (UTC Time)
- Enable Start Time Or Not:** Yes (radio), No (radio)
- Duration Time:** 1440 (Minute)
- Storage:** 10000 (MB)
- Recycle Store:** Yes (radio), No (radio)
- Store Format:**  HCN  RINEX 2.11
- FTP Push:**
  - Close
  - 1:ftp server 1
  - 2:ftp server 2
  - 3:ftp server 3

Buttons: Save, Back

In this screen, you can configure all the data logging parameters, and determine whether the recording files will be affected by the FTP Push. The parameters are mainly as follows:

- **Recording Name:** The name of this logging session.
- **Sample Interval:** Select the observable rate from the dropdown list.
- **Store Location:** Determine whether to store at internal storage or

external storage.

- **Start Time:** Set the start time of data logging in UTC. Select **Yes** or **No** option below to determine whether to start data logging from the start time defined, or immediately after this session is switched on.
- **Duration Time:** Set the duration of data logging.
- **Storage:** Set the storage space of this session.
- **Recycle Storage:** Select **Yes** or **No** option to determine whether to auto delete old files if the storage space is full.
- **Storage Format:** Set the data format of the logged data.
- **FTP Push:** Decide whether to push the stored files to the FTP server of your choice.

Tap  button to save the settings and back to the *Log Settings*

screen. Also, users can click  to abandon the changed settings and back to *Log Settings* screen.

*Note – To modify data logging parameters, make sure the data logging session is switched off.*

To switch on or off **ANY** data logging session, tap the **ON** or **OFF** button to the right of the required session.

To delete the recorded files of **ANY** data logging session, tap the **Clear** button to the right of the required session.

To delete the recorded files of **ALL** data logging sessions, tap the **Clear ALL Accounts** button.

#### 7.4.2. FTP PUSH SETTINGS SUBMENU

Use this screen to configure the receiver to push stored files to the FTP server of your choice. Only files that are configured to use FTP push are transmitted.

FTP Push Settings

Record Info				
Server ID	Server IP	Remote Directory	Server Description	Modify
1	192.168.3.72	/repo/first	ftp server 1	<a href="#">Modify</a>
2	192.168.3.72	/repo/second	ftp server 2	<a href="#">Modify</a>
3	192.168.3.72	/repo/third	ftp server 3	<a href="#">Modify</a>

Tap **Modify** button to the right of the required FTP server and the *FTP Push Settings* screen appears:

### 7.4.3. FTP PUSH RECORDING SUBMENU

Shows the related information about the recorded files that be pushed. And users can tap **Clear Ftp Send Log** button in the upper right corner to clear the log of FTP Push operations.

### 7.4.4. DATA DOWNLOAD SUBMENU

In this submenu, users can download the data files that recorded in the internal storage through the internal FTP site.

1. Click this submenu, and then the log on dialogue box will prompt you to enter a user name and password:

The default logon account for the internal FTP site is:













- User name: ftp
  - Password: ftp
2. Click the directory named as “repo” to view and download the files currently stored on the receiver:

## Index of /

Name	Size	Date Modified
 repo/		1/1/80 12:00:00 AM

- To find the file need to be downloaded, click the name of data logging session → the date of file that be recorded → the format of the file → the name of the target file.

## Index of /repo/record\_1/20150518/rinex/

Name	Size	Date Modified
 [parent directory]		
 1000514138D.15C	0 B	5/18/15 3:04:00 AM
 1000514138D.15G	0 B	5/18/15 3:04:00 AM
 1000514138D.15N	0 B	5/18/15 3:04:00 AM
 1000514138D.15O	8.0 kB	5/18/15 3:04:00 AM
 1000514138F.15C	0 B	5/18/15 5:56:00 AM
 1000514138F.15G	0 B	5/18/15 5:56:00 AM
 1000514138F.15N	0 B	5/18/15 5:56:00 AM
 1000514138F.15O	240 kB	5/18/15 5:59:00 AM
 1000514138I.15C	0 B	5/18/15 8:15:00 AM
 1000514138I.15G	0 B	5/18/15 8:15:00 AM
 1000514138I.15N	0 B	5/18/15 8:15:00 AM
 1000514138I.15O	64.0 kB	5/18/15 8:16:00 AM

- To download a file, left-click the name of the target file → download the file according to the prompts.

## 7.5. IO SETTINGS MENU

Use the IO Settings menu to set up all receiver outputs and inputs. The receiver can output CMR, RTCM, Raw data, Ephemeris data, GPGLGA, GPGLSV, on TCP/IP, UDP, serial port, or Bluetooth ports.

### 7.5.1. IO SETTINGS SUBMENU

The following figure shows an example of the screen that appears when you select this submenu.



IO Settings						
	Type	Introduction	Output	Connection Status	Modify	
1	RTK Client	211.144.118.5:2102	---	Logged In	<a href="#">Connect</a>	<a href="#">Disconnect</a>   <a href="#">Detail</a>
2	TCP/UDP_Client1	192.168.3.18:9900	---	Unconnected	<a href="#">Connect</a>	<a href="#">Disconnect</a>   <a href="#">Detail</a>
3	TCP/UDP_Client2	192.168.3.18:9901	---	Unconnected	<a href="#">Connect</a>	<a href="#">Disconnect</a>   <a href="#">Detail</a>
4	TCP/UDP_Client3	192.168.3.18:9902	---	Unconnected	<a href="#">Connect</a>	<a href="#">Disconnect</a>   <a href="#">Detail</a>
5	TCP/UDP_Client4	192.168.3.18:9903	---	Unconnected	<a href="#">Connect</a>	<a href="#">Disconnect</a>   <a href="#">Detail</a>
6	TCP/UDP_Client5	192.168.3.18:9904	---	Unconnected	<a href="#">Connect</a>	<a href="#">Disconnect</a>   <a href="#">Detail</a>
7	TCP/UDP_Client6	192.168.3.18:9905	---	Unconnected	<a href="#">Connect</a>	<a href="#">Disconnect</a>   <a href="#">Detail</a>
8	TCP Server/NTRIP Caster1	9901	GPQGA:1Hz, GPQSV:1Hz,	Opened	<a href="#">Connect</a>	<a href="#">Disconnect</a>   <a href="#">Detail</a>
9	TCP Server/NTRIP Caster2	9902	---	Closed	<a href="#">Connect</a>	<a href="#">Disconnect</a>   <a href="#">Detail</a>
10	TCP Server/NTRIP Caster3	9903	---	Closed	<a href="#">Connect</a>	<a href="#">Disconnect</a>   <a href="#">Detail</a>
11	TCP Server/NTRIP Caster4	9904	---	Closed	<a href="#">Connect</a>	<a href="#">Disconnect</a>   <a href="#">Detail</a>
12	Com Port	9600	---	---	<a href="#">Settings</a>	
13	Bluetooth	GNSS-1000514	---	---	<a href="#">Settings</a>	
14	Radio	460.0500MHz	Differential Data:SCMR	---	<a href="#">Settings</a>	

In this submenu, users can configure 6 types of input and output settings.

#### 1. RTK Client

After configuring the settings of RTK client, users can log on CORS or APIS. Tap the **Connect** button to the right → the *IO Settings* screen will appear → choose one of the connection protocols among the NTRIP, APIS\_BASE and

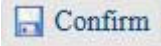
APIS\_ROVER → configure the related parameters → click  to log on CORS or APIS.

#### ➤ Connection Protocol: NTRIP

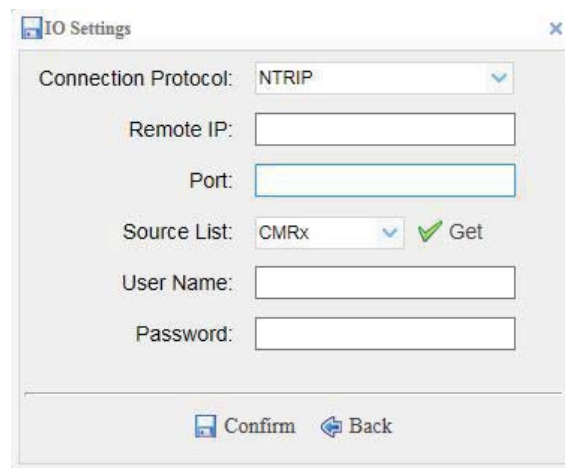

The screenshot shows a dialog box titled "IO Settings" with the following fields and options:

- Connection Protocol: NTRIP (dropdown menu)
- Remote IP: [text input field]
- Port: [text input field]
- Source List: CMRx (dropdown menu) with a green checkmark and "Get" text next to it.
- User Name: [text input field]
- Password: [text input field]

At the bottom of the dialog box, there are two buttons: "Confirm" and "Back".

#### ➤ Connection Protocol: APIS\_BASE

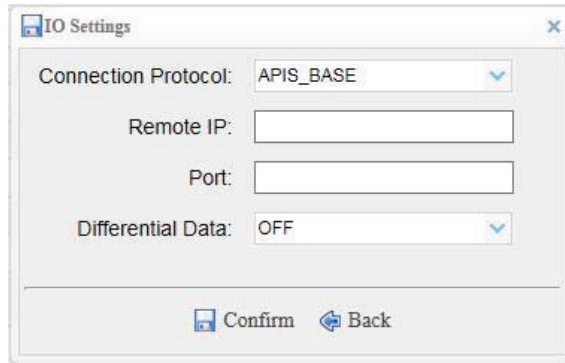

➤ Connection Protocol: APIS\_ROVER

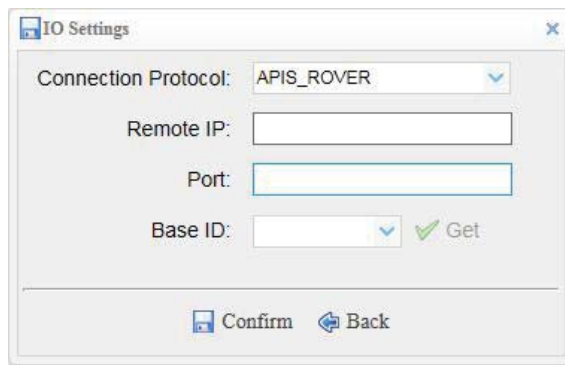

## 2. TCP/UDP Client

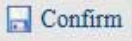
Tap the **Connect** button to the right of required TCP/UDP Client → the *IO Settings* screen will appear → select the connection protocol between TCP and UDP → enter the IP and Port of the target server → configure messages that you want to output to the target server → click  **Confirm** to save and complete the connection.

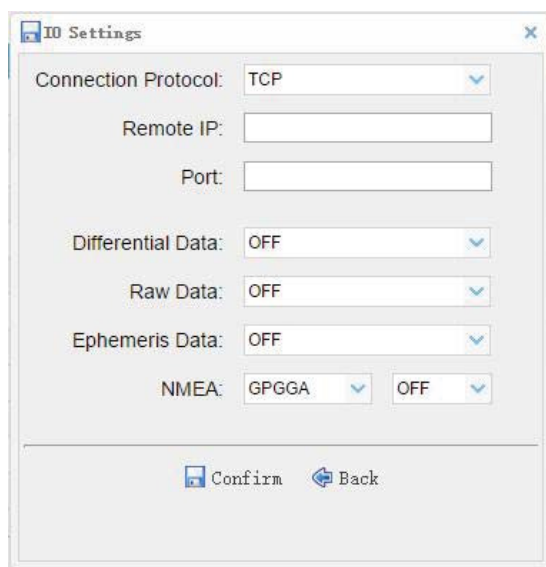

## 3. TCP Server/NTRIP Caster

Tap the **Connect** button to the right of required TCP Server/NTRIP Caster → the **IO Settings** screen will appear → select one of the connection protocols between NTRIP and TCP → configure the other related parameters → click

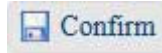

to save the settings and open the server.

## ➤ Connection Protocol: NTRIP

The screenshot shows the 'IO Settings' dialog box with the following configuration:

- Connection Protocol: NTRIP (dropdown menu)
- User Name: (empty text field)
- Password: (empty text field)
- Port: 9902 (text field)
- Source List: (empty text field)
- Differential Data: OFF (dropdown menu)
- Raw Data: OFF (dropdown menu)
- Ephemeris Data: OFF (dropdown menu)
- NMEA: GPGGA (dropdown menu) and OFF (checkbox)

At the bottom, there are two buttons: 'Confirm' and 'Back'.

## ➤ Connection Protocol: TCP

The screenshot shows the 'IO Settings' dialog box with the following configuration:

- Connection Protocol: TCP (dropdown menu)
- Port: 9902 (text field)
- Differential Data: OFF (dropdown menu)
- Raw Data: OFF (dropdown menu)
- Ephemeris Data: OFF (dropdown menu)
- NMEA: GPGGA (dropdown menu) and OFF (checkbox)

At the bottom, there are two buttons: 'Confirm' and 'Back'.

## 4. COM Port

Tap the **Settings** button to the right of COM Port → the *Serial Port Setup* screen will appear → select Baud Rate used to transmit data → configure the messages that you want to output through the serial port → click

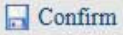
 **Confirm** to save the settings and start to transmit.

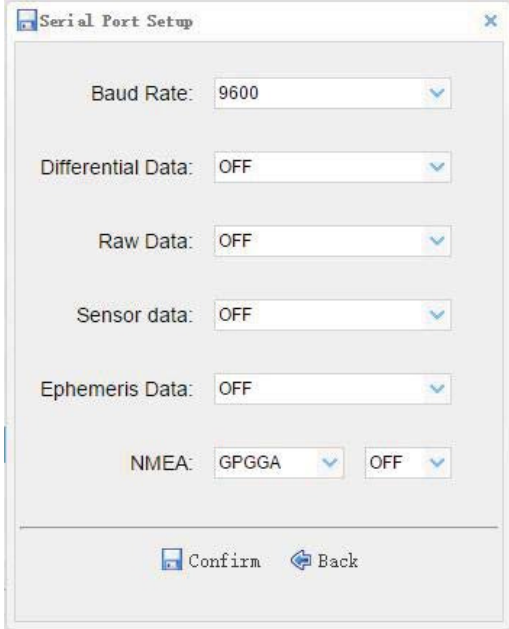

Serial Port Setup

Baud Rate: 9600

Differential Data: OFF

Raw Data: OFF

Sensor data: OFF

Ephemeris Data: OFF

NMEA: GPGGA OFF

Confirm Back

## 5. Bluetooth

Tap the **Settings** button to the right of Bluetooth → the *Bluetooth Set* screen will appear → configure the messages that you want to transmit through

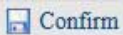
Bluetooth → click  **Confirm** to save the settings and start to transmit.

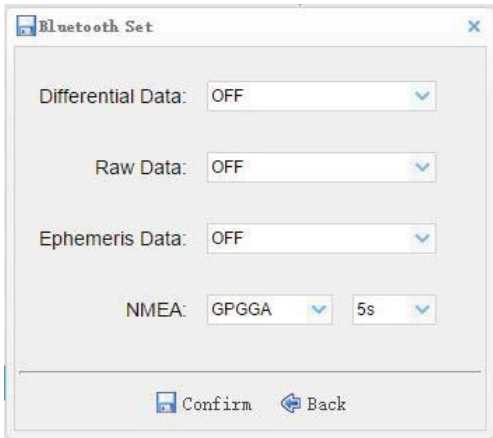

Bluetooth Set

Differential Data: OFF

Raw Data: OFF

Ephemeris Data: OFF

NMEA: GPGGA 5s

Confirm Back

## 6. Radio

Tap the **Settings** button to the right of Radio → the *Radio Settings* screen will appear → select the format of differential data that you want to transmit

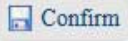
through radio from the dropdown list → click  to save the settings and start to transmit.

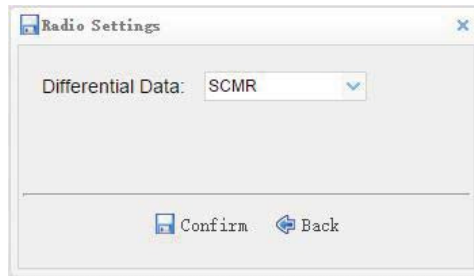

## 7.6. GPRS MENU

Use this menu to check and configure the network settings:



### 7.6.1. NETWORK INFO SUBMENU

The following figure shows an example of the screen that appears when you select this submenu:



### 7.6.2. NETWORK SET SUBMENU

Use this submenu to configure network settings, including GPRS model status, network mode, dialing status, APN, etc.

**Network Set**

GPRS Model Status: ON ON OFF

Auto Start:  Yes  No

---

Network Mode:  2G Only  3G Only  2G/3G Auto

---

Dialing Status: Dial On Connect Disconnect

Auto Connect:  Yes  No

---

APN:

Initializing String:

Dialing String:

User Name:

Password:

 Save

## 7.7. WIFI MENU

Use this menu to check and configure the Wifi settings:



### 7.7.1. WIFI INFO SUBMENU

The following figure shows an example of the screen that appears when you select this submenu:

**Wifi Info**

Power Status: ON

Wifi Mode: Access Point

Access Point Details

SSID: GNSS-1000514

Encrypt Type: WAP

Password: 12345678

### 7.7.2. WIFI SETTINGS SUBMENU

Use this submenu to configure the related parameters of the Wi-Fi settings, including power status, wifi mode, encrypt type, password, etc.

The screenshot shows the 'Wifi Settings' web interface. At the top, the title 'Wifi Settings' is displayed. Below the title, there are several configuration options:
 

- Power Status:** Set to 'ON', with a red 'OFF' button to its right.
- Auto Start:** Radio buttons for 'Yes' (selected) and 'No'.
- Wifi Mode:** A dropdown menu currently set to 'Access Point'.
- SSID:** A text input field containing 'GNSS-1000514'.
- Encrypt Type:** A dropdown menu currently set to 'WAP'.
- Password:** A text input field containing seven dots.

 At the bottom of the form, there is a 'Start' button with a small icon to its left.

## 7.8. BLUETOOTH SET MENU

Use this menu to configure Bluetooth settings.

### 7.8.1. BLUETOOTH SET SUBMENU

The following figure shows an example of the screen that appears when you select this submenu:

The screenshot shows the 'Bluetooth Set' web interface. At the top, the title 'Bluetooth Set' is displayed. Below the title, there are several configuration options:
 

- Local Name:** Displayed as 'GNSS-1000514'.
- MAC Address:** Displayed as '00:17:E9:A1:50:B3'.
- Visible:** Radio buttons for 'Yes' (selected) and 'No'.
- PIN:** A text input field containing '1234'.

 At the bottom of the form, there is a 'Save' button with a small icon to its left.

## 7.9. RADIO SETTINGS MENU

Use this menu to check and configure radio related settings, including protocol, OTA baud rate, frequency, etc.

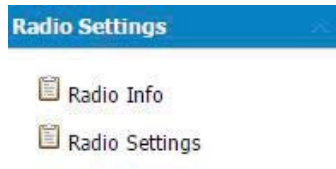

### 7.9.1. RADIO INFO SUBMENU

The following figure shows an example of the current configuration information about the internal radio:

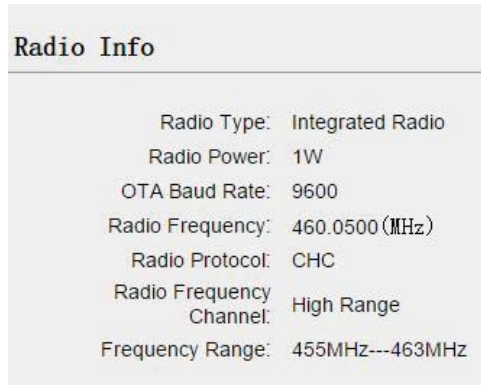

### 7.9.2. RADIO SETTINGS SUBMENU

Use this submenu to configure radio settings, including radio status, whether to switch on auto start or not, protocol, transmitting power, radio frequency, etc.

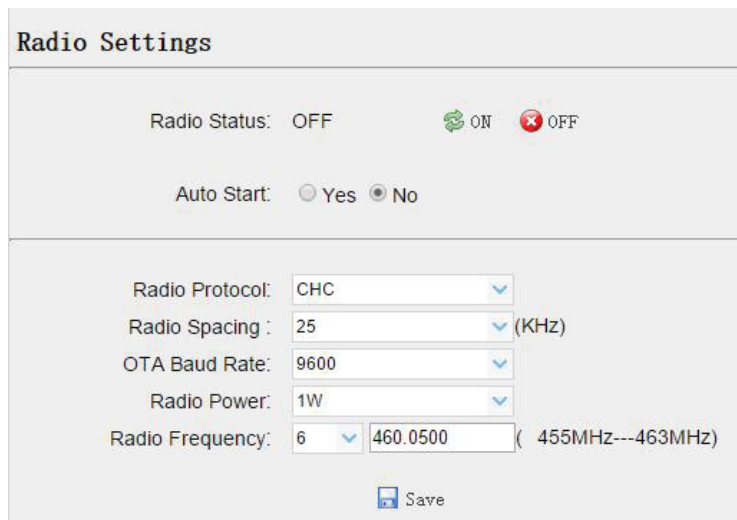

## 7.10. NETWORK SERVICE MENU

Use this menu to configure the receiver's HTTP port, and the username and password of internal FTP site:





### 7.10.1. HTTP SUBMENU

The following figure shows an example of the screen that appears when you select this submenu:

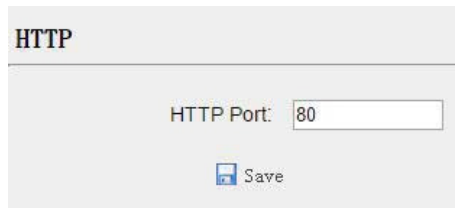

### 7.10.2. FTP SERVICE SUBMENU

The following figure shows an example of the screen that appears when you select this submenu:



## 7.11. FIRMWARE MENU

Use this menu to check the current firmware information, download the system log, update the receiver firmware, download or update the configuration file and register the receiver, and more:



### 7.11.1. FIRMWARE INFO SUBMENU

Use this submenu to check the current firmware information. The following figure shows an example of the firmware information.

**Firmware Info**

Firmware Type: 1.1.16  
Firmware Release Time: 20150423\_4795

### 7.11.2. SYSTEM LOG SUBMENU

Use this submenu to download the system log of the receiver.

**System Log Download**

System Log Type: Firmware Log

Download

### 7.11.3. FIRMWARE UPDATE SUBMENU

Use this submenu to load new firmware to the receiver across the network. Tap the **Browse** button to locate the upgrade file → tap **Confirm** button to confirm the selected upgrading file and start upgrading.

**Firmware Update**

Upgrade File: Browse

Confirm

#### Notes

- It may take about 3 or 4 minutes to complete the firmware upgrading. Do not touch the power button or unplug the power until the upgrading process is finished, or damage will be caused to the receiver.
- The receiver will restart after the firmware upgrading is done, so users need to reconnect the receiver with your computer via Wi-Fi, and then log-in the receiver through a web browser to continue the configuration.

#### 7.11.4. CONFIG FILE SUBMENU

In this submenu, users can download the configuration file by tapping



button and determine a saving path to download the

configuration file (.cfg file). Also, users can tap the **Browse** button to locate the existing configuration file → tap **Confirm** button to confirm the selected file and start updating.

### Config File

---

Download Configuration File : ✔ Download

---

Update Configuration File:

#### 7.11.5. GNSS REGISTRATION SUBMENU

Use this submenu to register the receiver. Paste or enter the registration code to the *Registration Code* field → tap **Registration** button to complete the registration.

### GNSS Registration

---

Receiver ID:

Registration Limit:

Registration Code:

#### 7.11.6. THE HARDWARE VERSION SUBMENU

Use this submenu to check the hardware information, including main board version and core board version:

### The Hardware Information

---

Main Board: 1.1

The Core Board: 1.1

## A. COMMUNICATION PORTS DEFINITION

### A.I. CHC M6 RECEIVER IO PORT (7-PIN LEMO PORT)

#### DEFINITION



PIN	FUNCTION
1	Ground ( - )
2	Ground ( - )
3	RS232-TX (Output)
4	Not Used
5	Not Used
6	VIN
7	RS232-RX (Input)

### A.II. CHC M6 RECEIVER USB PORT (7-PIN LEMO PORT)

#### DEFINITION



PIN	FUNCTION
1	Ground ( - )
2	Ground ( - )
3	VBUS
4	DM
5	DP
6	VIN
7	ID

CHC - Shanghai HuaCe Navigation Technology Ltd.

Building C, NO. 599 Gaojing Road,

Qingpu District, 201702 Shanghai, China

Tel: +86 21 542 60 273

Fax: +86 21 649 50 963

Email: [sales@chcnav.com](mailto:sales@chcnav.com) | [support@chcnav.com](mailto:support@chcnav.com)

Website: [www.chcnav.com](http://www.chcnav.com)