



FCC Test Report

Report No.: AGC03311150602FE03

FCC ID : SXS-BT171
APPLICATION PURPOSE : Original Equipment
PRODUCT DESIGNATION : Bluetooth Speaker
BRAND NAME : GSOU
MODEL NAME : U171
CLIENT : GSOU Technology(Shen Zhen)Co.,LTD
DATE OF ISSUE : July 28,2015
STANDARD(S) : FCC Part 15 Rules
TEST PROCEDURE(S) :
REPORT VERSION : V1.0

Attestation of Global Compliance (Shenzhen) Co., Ltd



CAUTION:

This report shall not be reproduced except in full without the written permission of the test laboratory and shall not be quoted out of context.



Report Revise Record

Report Version	Revise Time	Issued Date	Valid Version	Notes
V1.0	/	July 28,2015	Valid	Original Report

TABLE OF CONTENTS

1. VERIFICATION OF CONFORMITY	4
2. GENERAL INFORMATION	5
2.1. PRODUCT DESCRIPTION.....	5
2.2. TABLE OF CARRIER FREQUENCYS.....	5
3. MEASUREMENT UNCERTAINTY.....	6
4. DESCRIPTION OF TEST MODES.....	6
5. SYSTEM TEST CONFIGURATION	7
5.1. CONFIGURATION OF EUT SYSTEM	7
5.2. EQUIPMENT USED IN EUT SYSTEM	7
5.3. SUMMARY OF TEST RESULTS	7
6. TEST FACILITY	8
7 ALL TEST EQUIPMENT LIST	8
8. RADIATED EMISSION	9
8.1TEST LIMIT.....	9
8.2. MEASUREMENT PROCEDURE	10
8.3. TEST SETUP.....	12
8.4. TEST RESULT	14
9. BAND EDGE EMISSION	27
9.1. MEASUREMENT PROCEDURE	27
9.2 TEST SETUP	27
9.3 RADIATED TEST RESULT	28
10. 20DB BANDWIDTH.....	32
10.1. MEASUREMENT PROCEDURE	32
10.2. TEST SET-UP	32
10.3. LIMITS AND MEASUREMENT RESULTS.....	32
11. FCC LINE CONDUCTED EMISSION TEST	39
11.1. LIMITS OF LINE CONDUCTED EMISSION TEST	39
11.2. BLOCK DIAGRAM OF LINE CONDUCTED EMISSION TEST.....	39
11.3. PRELIMINARY PROCEDURE OF LINE CONDUCTED EMISSION TEST	40
11.4. FINAL PROCEDURE OF LINE CONDUCTED EMISSION TEST.....	40
11.5. TEST RESULT OF LINE CONDUCTED EMISSION TEST.....	41
APPENDIX A: PHOTOGRAPHS OF TEST SETUP	43
APPENDIX B: PHOTOGRAPHS OF EUT	45

1. VERIFICATION OF CONFORMITY

Applicant	GSOU Technology(Shen Zhen)Co.,LTD
Address	14C, Block A, First World Plaza, No.7002 West Hongli Road, Futian District, Shenzhen, Guangdong, China
Manufacturer	GSOU Technology(Shen Zhen)Co.,LTD
Address	14C, Block A, First World Plaza, No.7002 West Hongli Road, Futian District, Shenzhen, Guangdong, China
Product Designation	Bluetooth Speaker
Brand Name	GSOU
Test Model	U171
Date of test	July 08,2015 to July 10,2015
Deviation	None
Condition of Test Sample	Normal
Report Template	AGCRT-US-BR/RF

We hereby certify that:

The above equipment was tested by Compliance Certification Service(Shenzhen) Inc. The test data, data evaluation, test procedures, and equipment configurations shown in this report were made in accordance with the procedures given in ANSI C63.4 (2009) and the energy emitted by the sample EUT tested as described in this report is in compliance with radiated emission limits of FCC Rules Part 15.249.

Tested By 

Jerry Xiao(Xiao Wang) July 28,2015

Checked By 

Forrest Lei(Lei Yonggang) July 28,2015

Authorized By 

Solger Zhang(Zhang Hongyi) July 28,2015

2. GENERAL INFORMATION

2.1. PRODUCT DESCRIPTION

A major technical description of EUT is described as following

Operation Frequency	2.402 GHz to 2.480GHz
RF Output Power	-1.74dBm(Max)
Bluetooth Version	V2.1+EDR
Modulation	GFSK, $\pi/4$ -DQPSK, 8DPSK
Number of channels	79
Hardware Version	V1.1
Software Version	V1.0
Antenna Designation	PCB Antenna (Met 15.203 Antenna requirement)
Antenna Gain	3.77dBi
Power Supply	DC 3.7V by battery

Note: The USB port only used for charging and can't be used to transfer data with PC.

2.2. TABLE OF CARRIER FREQUENCIES

Frequency Band	Channel Number	Frequency
2400~2483.5MHZ	0	2402MHZ
	1	2403MHZ
	:	:
	38	2440 MHZ
	39	2441 MHZ
	40	2442 MHZ
	:	:
	77	2479 MHZ
	78	2480 MHZ

3. MEASUREMENT UNCERTAINTY

The reported uncertainty of measurement $y \pm U$, where expanded uncertainty U is based on a standard uncertainty multiplied by a coverage factor of $k=2$, providing a level of confidence of approximately 95 %.

No.	Item	Uncertainty
1	Conducted Emission Test	$\pm 3.18\text{dB}$
2	All emissions, radiated	$\pm 3.91\text{dB}$
3	Temperature	$\pm 0.5^\circ\text{C}$
4	Humidity	$\pm 2\%$

4. DESCRIPTION OF TEST MODES

NO.	TEST MODE DESCRIPTION
1	Low channel GFSK
2	Middle channel GFSK
3	High channel GFSK
4	Low channel $\pi/4$ -DQPSK
5	Middle channel $\pi/4$ -DQPSK
6	High channel $\pi/4$ -DQPSK
7	Low channel 8DPSK
8	Middle channel 8DPSK
9	High channel 8DPSK
10	Normal operation (BT)

Note:

1. Only the result of the worst case was recorded in the report, if no other cases.
2. For Radiated Emission, 3axis were chosen for testing for each applicable mode.
3. The EUT used fully-charged battery when tested.

5. SYSTEM TEST CONFIGURATION

5.1. CONFIGURATION OF EUT SYSTEM

Configure 1: (Normal hopping)

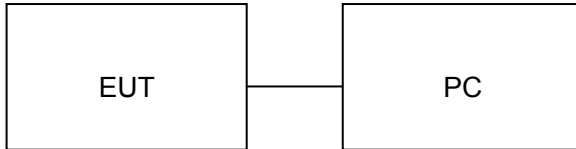

Configure 2: (Control continuous TX)

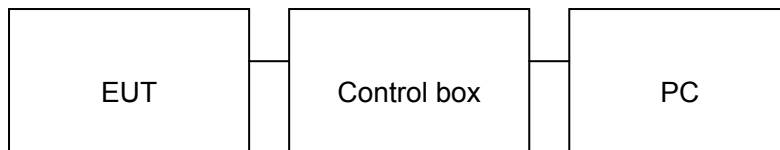

5.2. EQUIPMENT USED IN EUT SYSTEM

Item	Equipment	Model No.	ID or Specification	Remark
1	Bluetooth Speaker	GSOU	U171	EUT
2	Control box	N/A	N/A	A.E
3	PC	Dell	INSPIRON	A.E
4	USB Cable	N/A	0.5m, unshielded	A.E
5	Audio Cable	N/A	1.2m, unshielded	A.E
6	IPOD	Apple	A1367	A.E

5.3. SUMMARY OF TEST RESULTS

FCC RULES	DESCRIPTION OF TEST	RESULT
§15.249	Radiated Emission	Compliant
§15.249	Band Edges	Compliant
§15.207	Conduction Emission	Compliant
N/A	BANDWIDTH	Compliant

6. TEST FACILITY

Site	Compliance Certification Service(Shenzhen) Inc.
Location	No.10-1 Mingkeda Logistics Park, No.18 Huanguan South RD. Guan lan Town,Baoan Distr
FCC Registration No.	441872
Description	The test site is constructed and calibrated to meet the FCC requirements in documents ANSI C63.4:2009.

7 ALL TEST EQUIPMENT LIST

Radiated Emission Test Site 966(2)					
Name of Equipment	Manufacturer	Model Number	Serial Number	Last Calibration	Due Calibration
PSA Series Spectrum Analyzer	Agilent	E4446A	US44300399	03/01/2015	03/01/2016
EMI TEST RECEIVER	ROHDE&SCHWARZ	ESCI	100783	03/09/2015	03/08/2016
Amplifier	MITEQ	AM-1604-3000	1123808	03/18/2015	03/17/2016
High Noise Amplifier	Agilent	8449B	3008A01838	03/18/2015	03/17/2016
Board-Band Horn Antenna	Schwarzbeck	BBHA 9170	9170-497	07/11/2014	07/10/2015
Bilog Antenna	SCHAFFNER	CBL6143	5082	03/01/2015	03/01/2016
Horn Antenna	SCHWARZBECK	BBHA9120	D286	03/01/2015	03/01/2016
Loop Antenna	COM-POWER	AL-130	121044	09/27/2014	09/26/2015
Turn Table	N/A	N/A	N/A	N.C.R	N.C.R
Controller	Sunol Sciences	SC104V	022310-1	N.C.R	N.C.R
Controller	CT	N/A	N/A	N.C.R	N.C.R
Temp. / Humidity Meter	Anymetre	JR913	N/A	02/28/2015	02/27/2016
Antenna Tower	SUNOL	TLT2	N/A	N.C.R	N.C.R
Test S/W	FARAD	LZ-RF / CCS-SZ-3A2			

Conducted Emission Test Site					
Name of Equipment	Manufacturer	Model Number	Serial Number	Last Calibration	Due Calibration
EMI TEST RECEIVER	ROHDE&SCHWARZ	ESCI	100783	03/09/2015	03/08/2016
LISN(EUT)	ROHDE&SCHWARZ	ENV216	101543-WX	03/09/2015	03/08/2016
LISN	EMCO	3825/2	8901-1459	03/09/2015	03/08/2016
Temp. / Humidity Meter	VICTOR	HTC-1	N/A	03/04/2015	03/03/2016
Test S/W	FARAD	EZ-EMC/ CCS-3A1-CE			

8. RADIATED EMISSION

8.1 TEST LIMIT

Standard FCC15.249

Fundamental Frequency	Field Strength of Fundamental (millivolts/meter)	Field Strength of Harmonics (microvolts/meter)
900-928MHz	50	500
2400-2483.5MHz	50	500
5725-5875MHz	50	500
24.0-24.25GHz	250	2500

Standard FCC 15.209

Frequency (MHz)	Distance Meters	Field Strengths Limit	
		μ V/m	dB(μ V)/m
0.009 ~ 0.490	300	2400/F(kHz)	---
0.490 ~ 1.705	30	24000/F(kHz)	---
1.705 ~ 30	30	30	---
30 ~ 88	3	100	40.0
88 ~ 216	3	150	43.5
216 ~ 960	3	200	46.0
960 ~ 1000	3	500	54.0
Above 1000	3	Other:74.0 dB(μ V)/m (Peak) 54.0 dB(μ V)/m (Average)	

Remark: (1) Emission level dB μ V = 20 log Emission level μ V/m
(2) The smaller limit shall apply at the cross point between two frequency bands.
(3) Distance is the distance in meters between the measuring instrument, antenna and the closest point of any part of the device or system.

8.2. MEASUREMENT PROCEDURE

1. Configure the EUT according to ANSI C63.4. The EUT was placed on the top of the turntable 0.8 meter above ground. The phase center of the receiving antenna mounted on the top of a height-variable antenna tower was placed 3 meters far away from the turntable.
2. Power on the EUT and all the supporting units. The turntable was rotated by 360 degrees to determine the position of the highest radiation.
3. The height of the broadband receiving antenna was varied between one meter and four meters above ground to find the maximum emissions field strength of both horizontal and vertical polarization.
4. For each suspected emissions, the antenna tower was scan (from 1 M to 4 M) and then the turntable was rotated (from 0 degree to 360 degrees) to find the maximum reading.
5. Set the test-receiver system to Peak or CISPR quasi-peak Detect Function with specified bandwidth under Maximum Hold Mode.
6. For emissions above 1GHz, use 1.5MHz VBW and RBW for peak reading. Then 1.5MHz RBW and 10Hz VBW for average reading in spectrum analyzer.
7. When the radiated emissions limits are expressed in terms of the average value of the emissions, and pulsed operation is employed, the measurement field strength shall be determined by averaging over one complete pulse train, including blanking intervals, as long as the pulse train does not exceed 0.1 seconds. As an alternative (provided the transmitter operates for longer than 0.1 seconds) or in cases where the pulse train exceeds 0.1 seconds, the measured field strength shall be determined from the average absolute voltage during a 0.1 second interval during which the field strength is at its maximum values.
8. If the emissions level of the EUT in peak mode was 3 dB lower than the average limit specified, then testing will be stopped and peak values of EUT will be reported, otherwise, the emissions which do not have 3 dB margin will be repeated one by one using the quasi-peak method for below 1GHz.
9. For testing above 1GHz, the emissions level of the EUT in peak mode was lower than average limit (that means the emissions level in peak mode also complies with the limit in average mode), then testing will be stopped and peak values of EUT will be reported, otherwise, the emissions will be measured in average mode again and reported.
10. In case the emission is lower than 30MHz, loop antenna has to be used for measurement and the recorded data should be QP measured by receiver. High - Low scan is not required in this case.

The following table is the setting of spectrum analyzer and receiver.

Spectrum Parameter	Setting
Start ~Stop Frequency	9KHz~150KHz/RB 200Hz for QP
Start ~Stop Frequency	150KHz~30MHz/RB 9KHz for QP
Start ~Stop Frequency	30MHz~1000MHz/RB 120KHz for QP
Start ~Stop Frequency	1GHz~26.5GHz 1.5MHz/1.5MHz for Peak, 1.5MHz/10Hz for Average

Receiver Parameter	Setting
Start ~Stop Frequency	9KHz~150KHz/RB 200Hz for QP
Start ~Stop Frequency	150KHz~30MHz/RB 9KHz for QP
Start ~Stop Frequency	30MHz~1000MHz/RB 120KHz for QP

8.3. TEST SETUP

Radiated Emission Test-Setup Frequency Below 30MHz

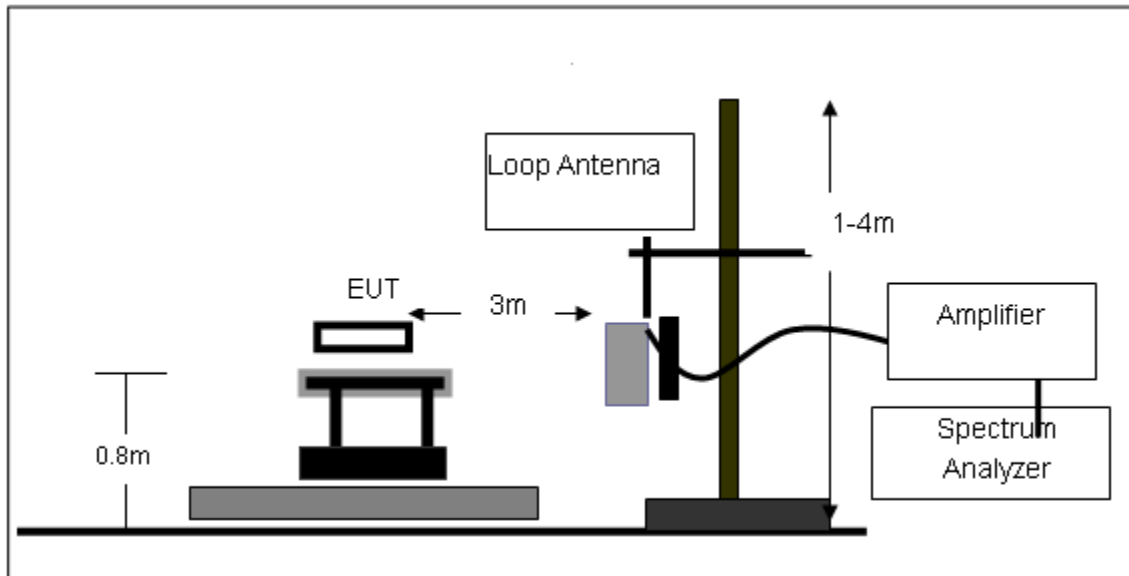

RADIATED EMISSION TEST SETUP 30MHz-1000MHz

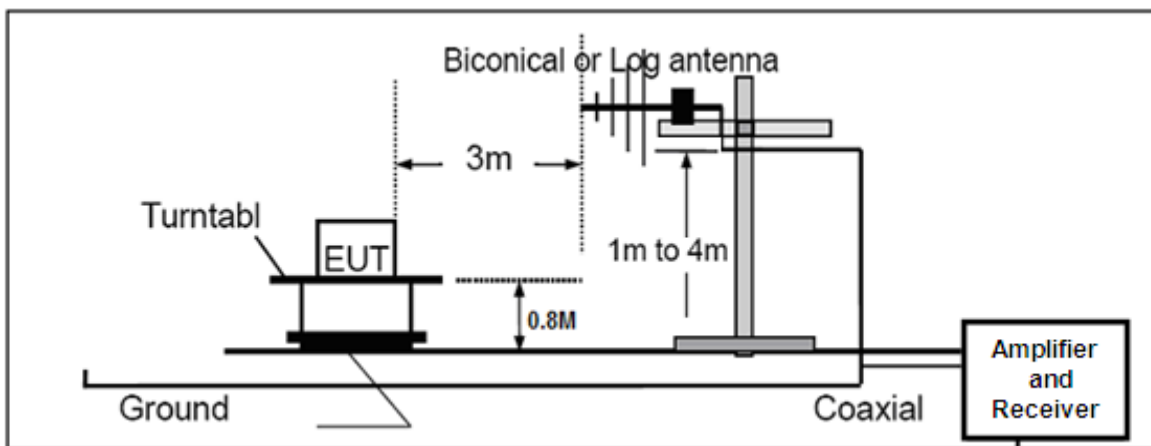

RADIATED EMISSION TEST SETUP ABOVE 1000MHz

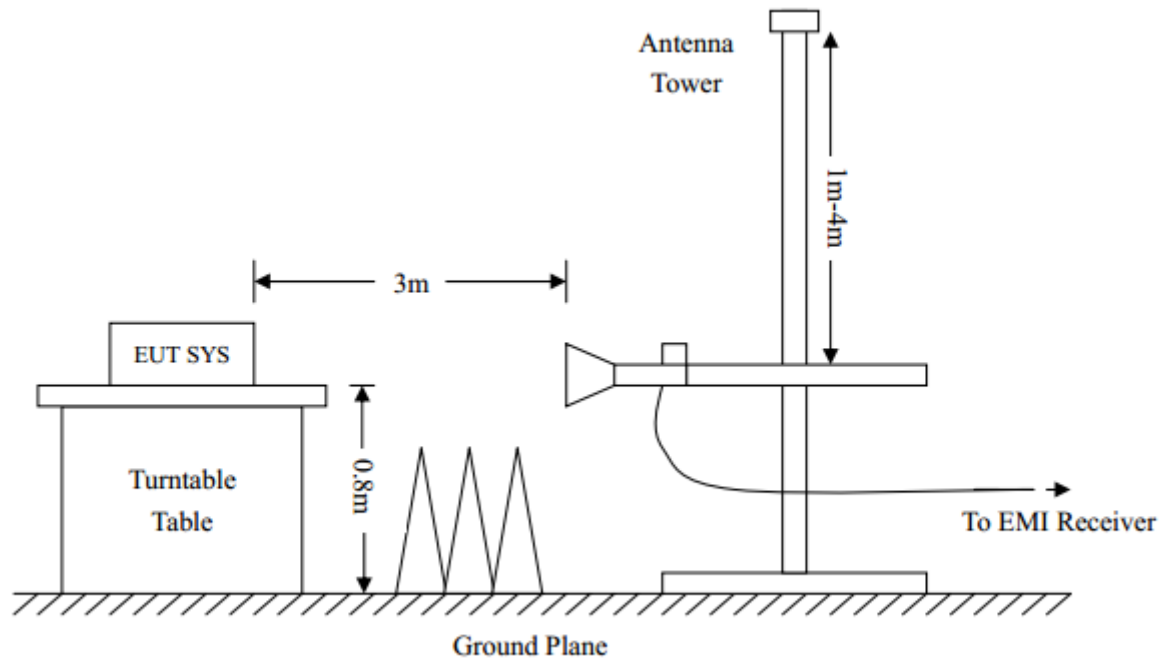

8.4. TEST RESULT

(Worst modulation:GFSK)

RADIATED EMISSION BELOW 30MHZ

No emission found between lowest internal used/generated frequencies to 30MHz.

RADIATED EMISSION BELOW 1GHZ

RADIATED EMISSION TEST- (30MHZ-1GHZ)-LOW CHANNEL-HORIZONTAL

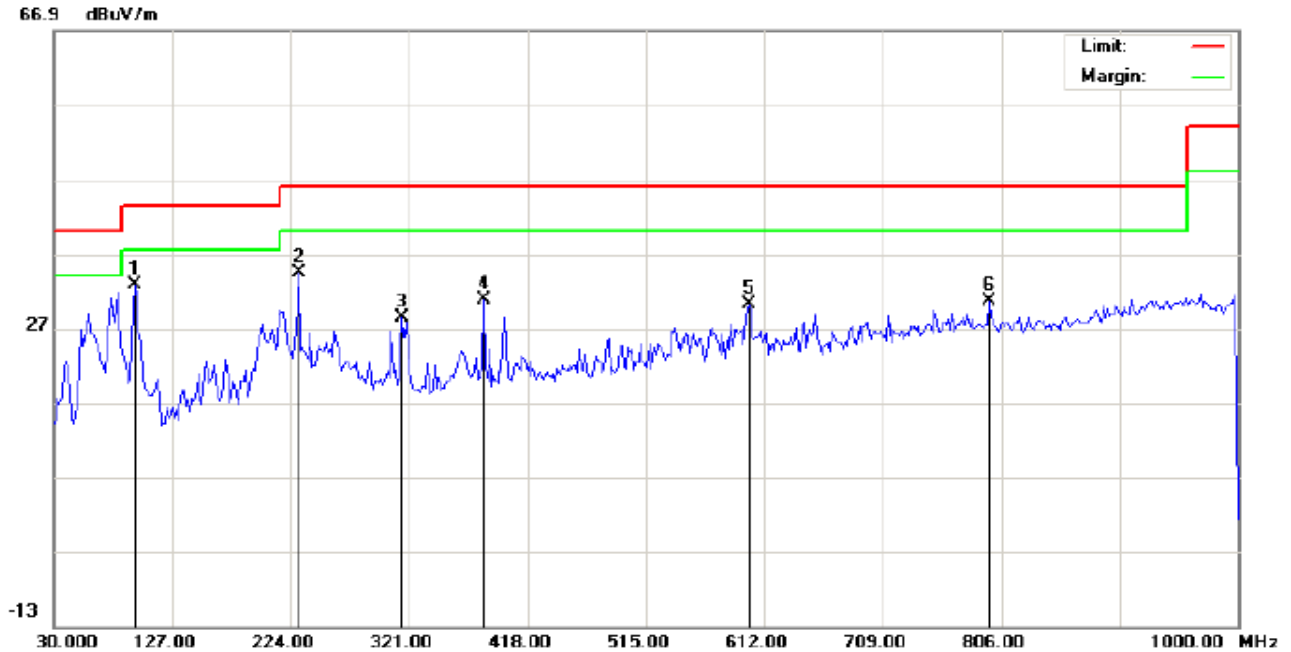

Site: site #1
Limit: FCC Class B 3M Radiation
EUT: Bluetooth Speaker
M/N: U171
Mode: Low Channel TX
Note:

Polarization: *Horizontal*
Power:
Distance: 3m

Temperature: 26.3
Humidity: 53.7 %

No.	Mk	Freq.	Reading	Factor	Measurement	Limit	Over	Detector	Antenna Height	Table Degree	Comment
		MHz	dBuV	dB/m	dBuV/m	dBuV/m	dB		cm	degree	
1	*	96.2833	22.67	10.07	32.74	43.50	-10.76	peak			
2		230.4667	21.19	13.16	34.35	46.00	-11.65	peak			
3		314.5333	12.11	16.38	28.49	46.00	-17.51	peak			
4		382.4333	11.91	18.95	30.86	46.00	-15.14	peak			
5		599.0667	6.44	23.71	30.15	46.00	-15.85	peak			
6		796.3000	3.28	27.27	30.55	46.00	-15.45	peak			

RESULT: PASS

RADIATED EMISSION TEST- (30MHZ-1GHZ)-LOW CHANNEL -VERTICAL

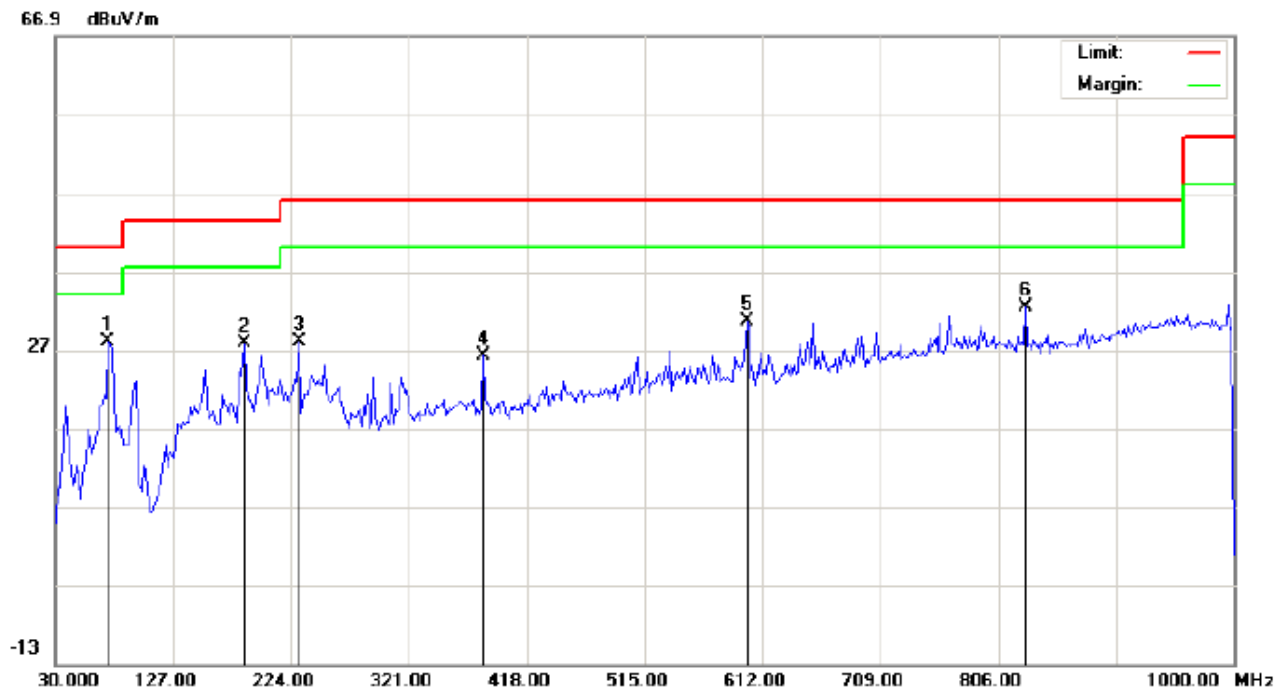

Site: site #1
Limit: FCC Class B 3M Radiation
EUT: Bluetooth Speaker
M/N: U171
Mode: Low Channel TX
Note:

Polarization: *Vertical*
Power:
Distance: 3m

Temperature: 26.3
Humidity: 53.7 %

No.	Mk	Freq.	Reading	Factor	Measurement	Limit	Over	Detector	Antenna Height	Table Degree	Comment
		MHz	dBuV	dB/m	dBuV/m	dBuV/m	dB		cm	degree	
1	*	73.6500	24.59	3.36	27.95	40.00	-12.05	peak			
2		185.2000	14.98	12.75	27.73	43.50	-15.77	peak			
3		230.4667	15.96	11.99	27.95	46.00	-18.05	peak			
4		382.4333	7.35	18.95	26.30	46.00	-19.70	peak			
5		599.0667	7.85	22.73	30.58	46.00	-15.42	peak			
6		828.6333	5.00	27.31	32.31	46.00	-13.69	peak			

RESULT: PASS

Note: 1. Factor=Antenna Factor + Cable loss, Margin=Measurement-Limit.

2. The "Factor" value can be calculated automatically by software of measurement system.

RADIATED EMISSION TEST- (30MHZ-1GHZ)-MIDDLE CHANNEL-HORIZONTAL

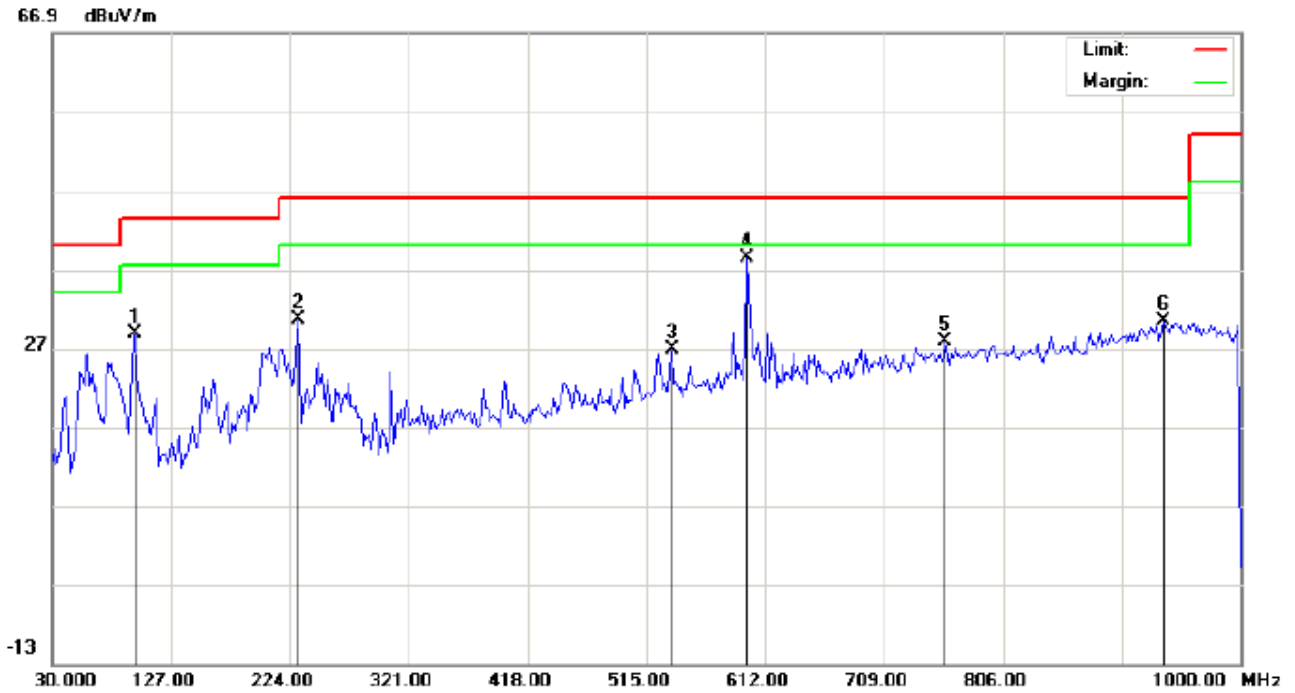

Site: site #1
 Limit: FCC Class B 3M Radiation
 EUT: Bluetooth Speaker
 M/N: U171
 Mode: Middle Channel TX
 Note:

Polarization: *Horizontal*
 Power:
 Distance: 3m

Temperature: 26.3
 Humidity: 53.7 %

No.	Mk	Freq.	Reading	Factor	Measurement	Limit	Over	Detector	Antenna Height	Table Degree	Comment
		MHz	dBuV	dB/m	dBuV/m	dBuV/m	dB		cm	degree	
1		97.9000	18.55	10.25	28.80	43.50	-14.70	peak			
2		230.4667	17.53	13.16	30.69	46.00	-15.31	peak			
3		536.0167	4.78	22.10	26.88	46.00	-19.12	peak			
4	*	597.4500	14.72	23.67	38.39	46.00	-7.61	peak			
5		759.1167	0.99	26.76	27.75	46.00	-18.25	peak			
6		936.9500	0.78	29.64	30.42	46.00	-15.58	peak			

RESULT: PASS

RADIATED EMISSION TEST- (30MHZ-1GHZ)- MIDDLE CHANNEL -VERTICAL

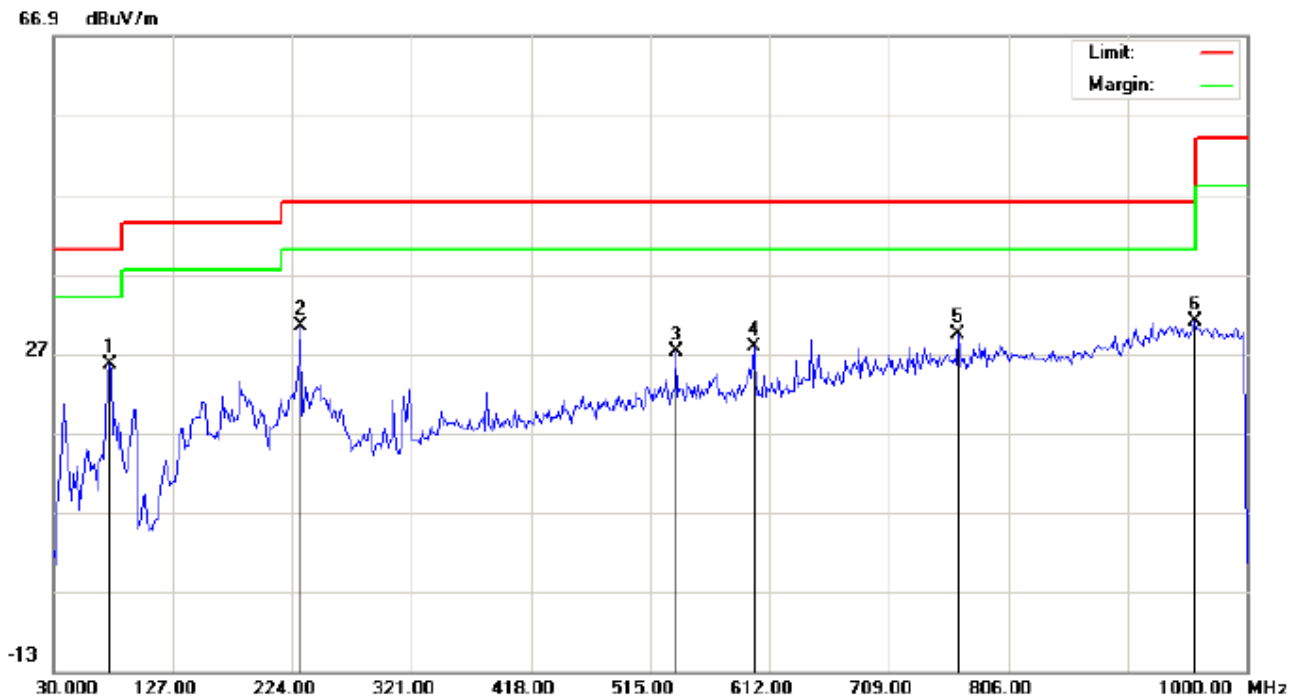

Site: site #1
Limit: FCC Class B 3M Radiation
EUT: Bluetooth Speaker
M/N: U171
Mode: Middle Channel TX
Note:

Polarization: *Vertical*
Power:
Distance: 3m

Temperature: 26.3
Humidity: 53.7 %

No.	Mk	Freq.	Reading	Factor	Measurement	Limit	Over	Detector	Antenna Height	Table Degree	Comment
		MHz	dBuV	dB/m	dBuV/m	dBuV/m	dB		cm	degree	
1	*	75.2667	22.58	2.96	25.54	40.00	-14.46	peak			
2		230.4667	18.48	11.99	30.47	46.00	-15.53	peak			
3		536.0167	5.04	22.10	27.14	46.00	-18.86	peak			
4		599.0667	5.11	22.73	27.84	46.00	-18.16	peak			
5		765.5833	2.63	26.85	29.48	46.00	-16.52	peak			
6		957.9667	1.07	29.92	30.99	46.00	-15.01	peak			

RESULT: PASS

Note: 1. Factor=Antenna Factor + Cable loss, Margin=Measurement-Limit.

2. The "Factor" value can be calculated automatically by software of measurement system.

RADIATED EMISSION TEST- (30MHZ-1GHZ)-HIGH CHANNEL-HORIZONTAL

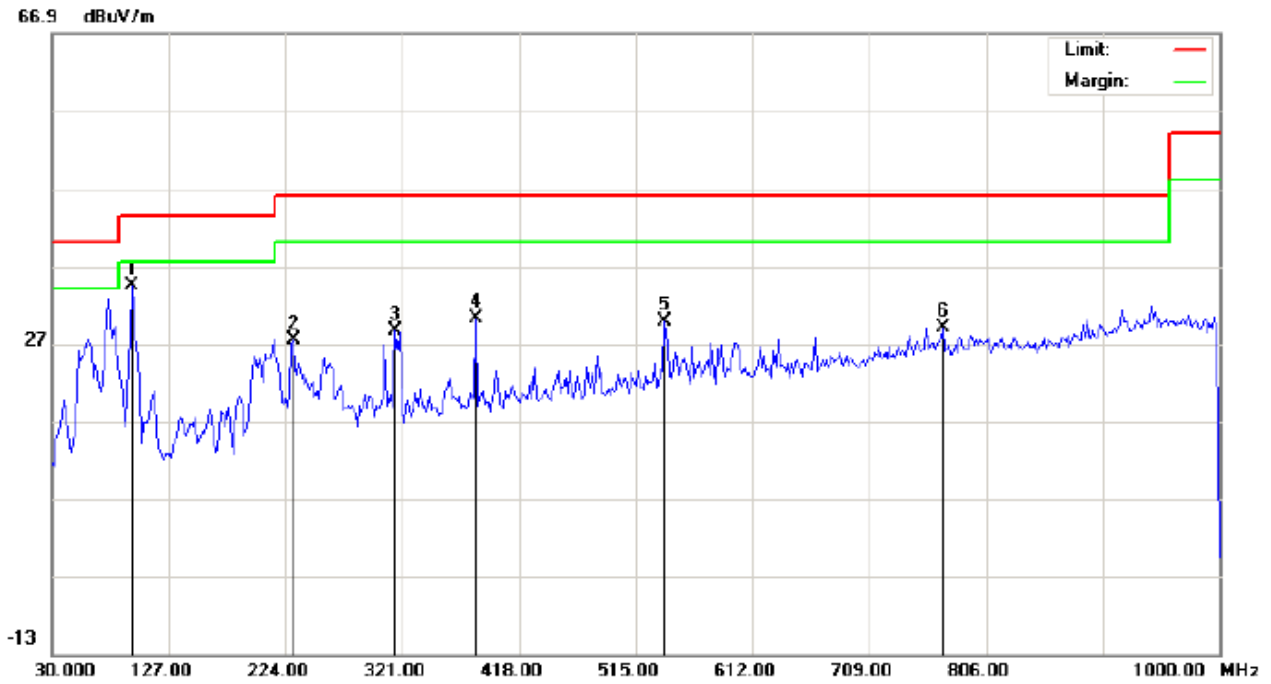

Site: site #1
 Limit: FCC Class B 3M Radiation
 EUT: Bluetooth Speaker
 M/N: U171
 Mode: High Channel TX
 Note:

Polarization: *Horizontal*
 Power:
 Distance: 3m

Temperature: 26.3
 Humidity: 53.7 %

No.	Mk	Freq.	Reading	Factor	Measurement	Limit	Over	Detector	Antenna Height	Table Degree	Comment
		MHz	dBuV	dB/m	dBuV/m	dBuV/m	dB		cm	degree	
1	*	96.2833	24.27	10.07	34.34	43.50	-9.16	peak			
2		230.4667	14.31	13.16	27.47	46.00	-18.53	peak			
3		314.5333	12.29	16.38	28.67	46.00	-17.33	peak			
4		382.4333	11.26	18.95	30.21	46.00	-15.79	peak			
5		539.2500	7.67	22.19	29.86	46.00	-16.14	peak			
6		770.4333	2.15	26.91	29.06	46.00	-16.94	peak			

RESULT: PASS

RADIATED EMISSION TEST- (30MHZ-1GHZ)-HIGH CHANNEL -VERTICAL

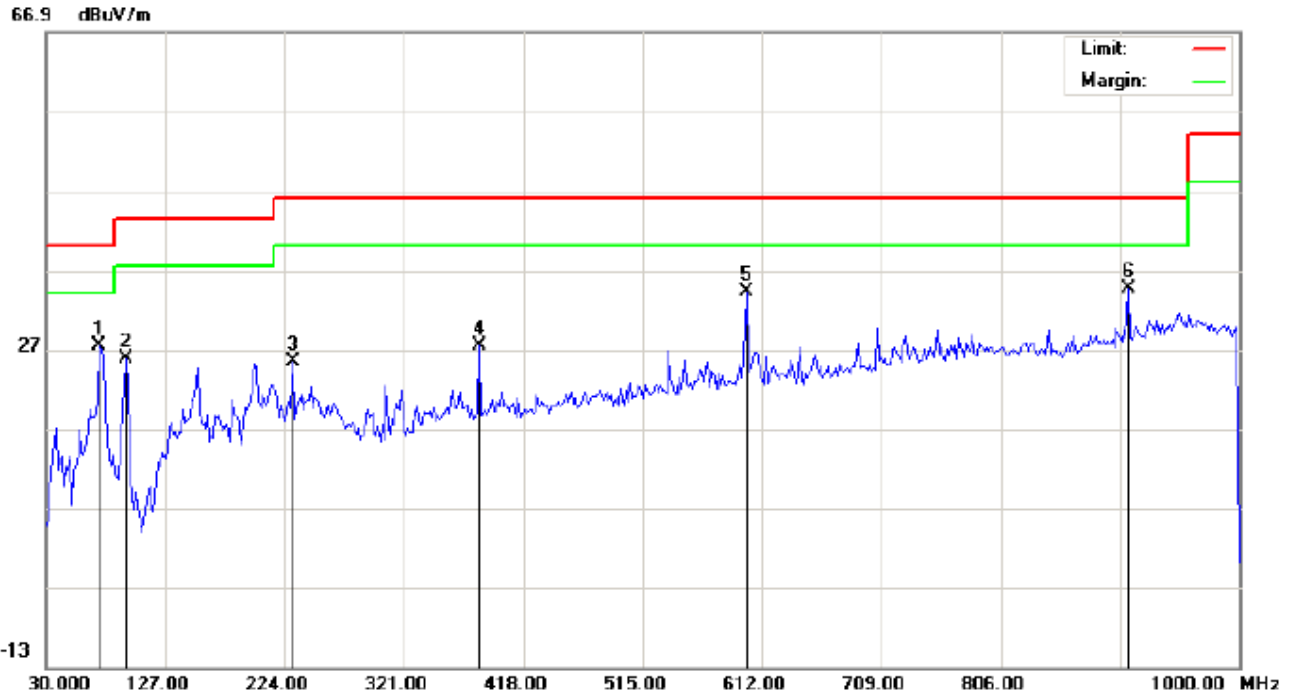

Site: site #1
Limit: FCC Class B 3M Radiation
EUT: Bluetooth Speaker
M/N: U171
Mode: High Channel TX
Note:

Polarization: *Vertical*
Power:
Distance: 3m

Temperature: 26.3
Humidity: 53.7 %

No.	Mk	Freq.	Reading	Factor	Measurement	Limit	Over	Detector	Antenna Height	Table Degree	Comment
		MHz	dBuV	dB/m	dBuV/m	dBuV/m	dB		cm	degree	
1		73.6500	24.02	3.36	27.38	40.00	-12.62	peak			
2		94.6667	24.35	1.42	25.77	43.50	-17.73	peak			
3		230.4667	13.48	11.99	25.47	46.00	-20.53	peak			
4		382.4333	8.36	18.95	27.31	46.00	-18.69	peak			
5		599.0667	11.52	22.73	34.25	46.00	-11.75	peak			
6	*	909.4667	5.69	28.87	34.56	46.00	-11.44	peak			

RESULT: PASS

Note: 1. Factor=Antenna Factor + Cable loss, Margin=Measurement-Limit.

2. The "Factor" value can be calculated automatically by software of measurement system.

RADIATED EMISSION ABOVE 1GHZ

RADIATED EMISSION TEST- (ABOVE 1GHZ)-LOW CHANNEL-HORIZONTAL

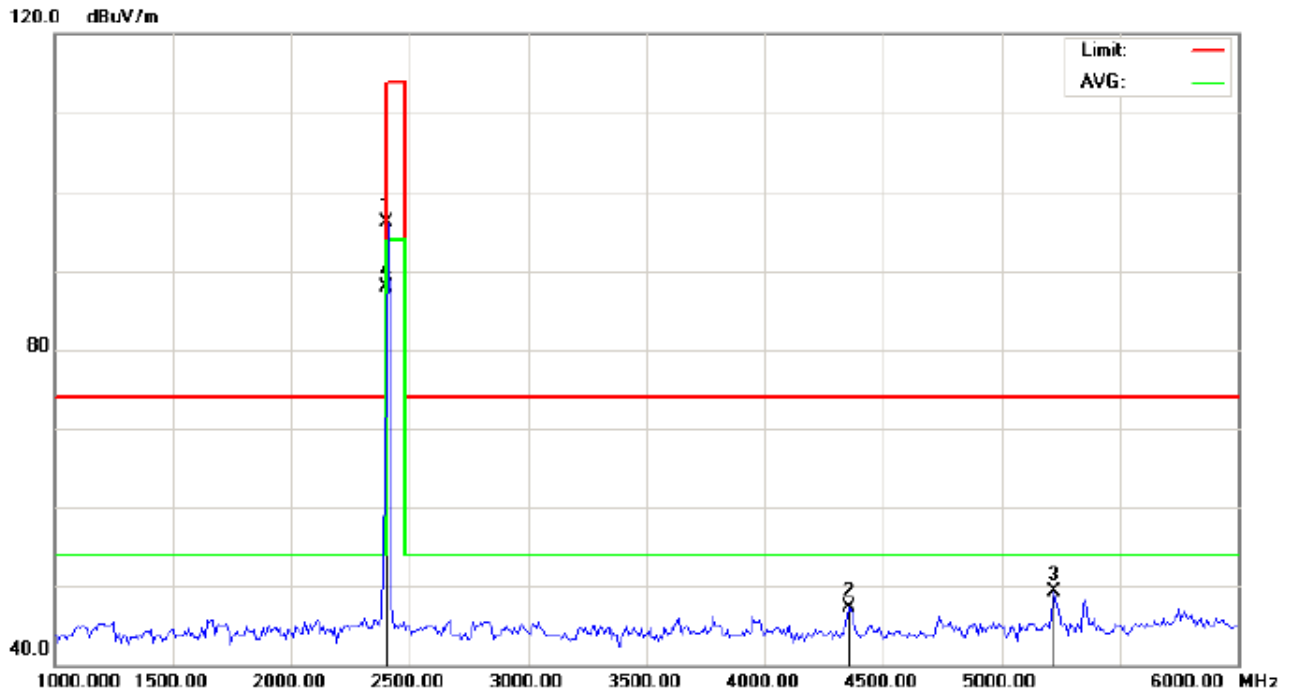

Site: site #1
Limit: FCC Class B 3M Radiation above 1GHZ(PK)-
EUT: Bluetooth Speaker
M/N: U171
Mode: Low Channel TX
Note:

Polarization: *Horizontal*
Power:
Distance: 3m

Temperature: 26
Humidity: 60 %

No.	Mk	Freq.	Reading	Factor	Measurement	Limit	Over	Detector	Antenna Height	Table Degree	Comment
		MHz	dBuV	dB/m	dBuV/m	dBuV/m	dB		cm	degree	
1		2402.000	105.73	-9.68	96.05	114.00	-17.95	peak			
2		4358.333	50.90	-3.59	47.31	74.00	-26.69	peak			
3		5225.000	51.09	-1.80	49.29	74.00	-24.71	peak			
4	*	2402.000	97.67	-9.68	87.99	94.00	-6.01	AVG	150	0	

RESULT: PASS

RADIATED EMISSION TEST- (ABOVE 1GHZ)-LOW CHANNEL- VERTICAL

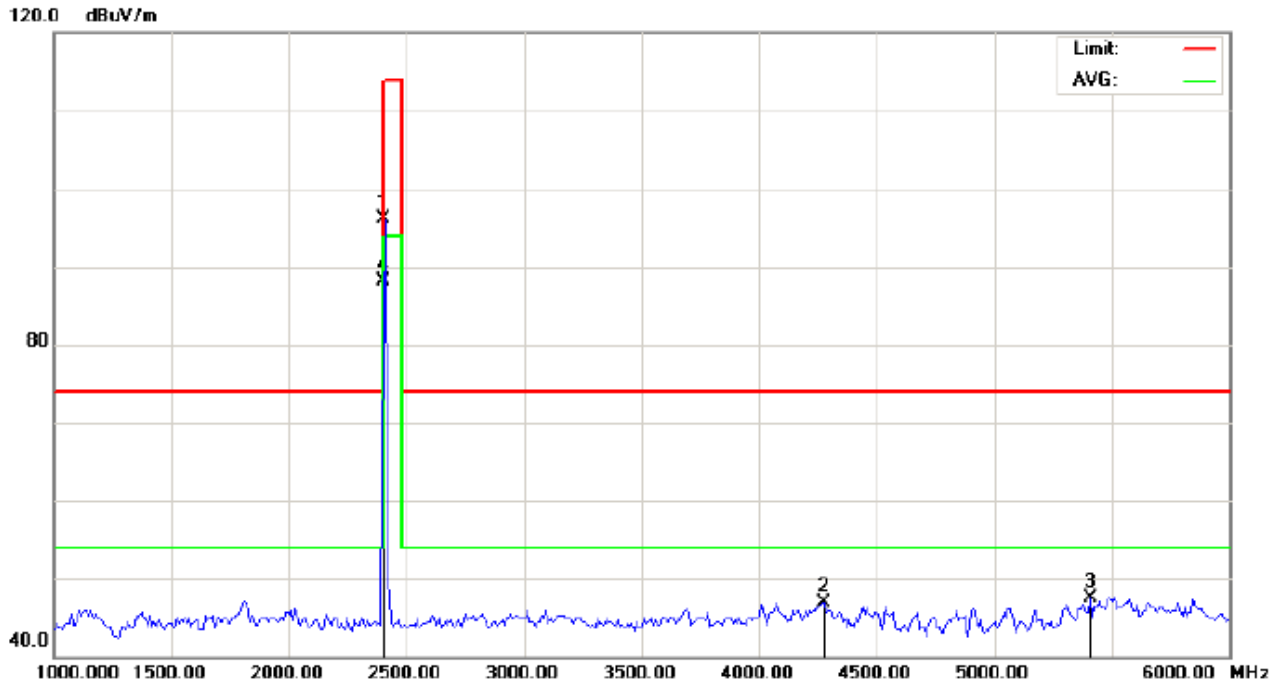

Site: site #1
 Limit: FCC Class B 3M Radiation above 1GHZ(PK)-
 EUT: Bluetooth Speaker
 M/N: U171
 Mode: Low Channel TX
 Note:

Polarization: *Vertical*
 Power:
 Distance: 3m

Temperature: 26
 Humidity: 60 %

No.	Mk	Freq.	Reading	Factor	Measurement	Limit	Over	Detector	Antenna Height	Table Degree	Comment
		MHz	dBuV	dB/m	dBuV/m	dBuV/m	dB		cm	degree	
1		2402.000	105.73	-9.68	96.05	114.00	-17.95	peak			
2		4275.000	50.83	-3.87	46.96	74.00	-27.04	peak			
3		5408.333	49.39	-1.81	47.58	74.00	-26.42	peak			
4	*	2402.000	97.86	-9.68	88.18	94.00	-5.82	AVG	150	51	

RESULT: PASS

RADIATED EMISSION TEST- (ABOVE 1GHZ)-MIDDLE CHANNEL- VERTICAL

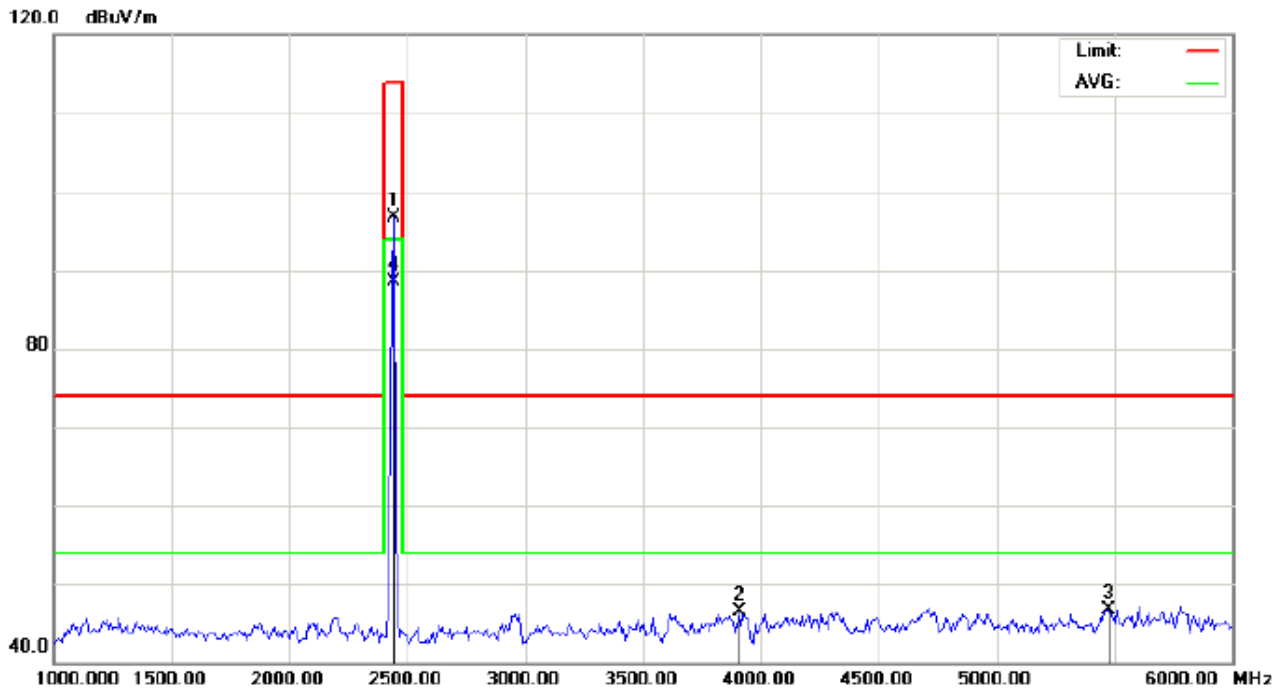

Site: site #1 Polarization: *Vertical* Temperature: 26
 Limit: FCC Class B 3M Radiation above 1GHZ(PK)- Power: Humidity: 60 %
 EUT: Bluetooth Speaker Distance: 3m
 M/N: U171
 Mode: Middle Channel TX
 Note:

No.	Mk	Freq.	Reading	Factor	Measurement	Limit	Over	Detector	Antenna	Table	Comment
		MHz	dBuV	dB/m	dBuV/m	dBuV/m	dB		Height	Degree	
									cm	degree	
1		2441.000	106.25	-9.63	96.62	114.00	-17.38	peak			
2		3908.333	51.85	-5.37	46.48	74.00	-27.52	peak			
3		5475.000	48.56	-1.81	46.75	74.00	-27.25	peak			
4	*	2441.000	98.12	-9.63	88.49	94.00	-5.51	AVG	150	90	

RESULT: PASS

Field strength of the fundamental signal

Peak value

Frequency	Reading Level	Factor	Measurement	Limit	Over	Antenna
(MHz)	(dBuv)	(dB/m)	(dBuv/m)	(dBuv/m)	(dB)	Polarization
2402	105.73	-9.68	96.05	114	-17.95	Horizontal
2402	105.73	-9.68	96.05	114	-17.95	Vertical
2441	106.32	-9.63	96.69	114	-17.31	Horizontal
2441	106.25	-9.63	96.62	114	-17.38	Vertical
2480	106.87	-9.59	97.28	114	-16.72	Horizontal
2480	106.91	-9.59	97.32	114	-16.88	Vertical

Average value

Frequency	Reading Level	Factor	Measurement	Limit	Over	Antenna
(MHz)	(dBuv)	(dB/m)	(dBuv/m)	(dBuv/m)	(dB)	Polarization
2402	97.67	-9.68	87.99	94	-6.01	Horizontal
2402	97.86	-9.68	88.18	94	-5.82	Vertical
2441	97.95	-9.63	88.32	94	-5.68	Horizontal
2441	98.12	-9.63	88.49	94	-5.51	Vertical
2480	98.04	-9.59	88.45	94	-5.55	Horizontal
2480	97.56	-9.59	87.97	94	-6.03	Vertical

9. BAND EDGE EMISSION

9.1. MEASUREMENT PROCEDURE

1The EUT operates at hopping-off test mode. The lowest or highest channels are tested to verify the largest transmission and spurious emissions power at the continuous transmission mode.

2Max hold the trace of the setp 1,and the EUT operates at hopping-on test mode to verify the largest spurious emissions power.

3Set the spectrum analyzer in the following setting in order to capture the lower and upper band-edges of the emission: (a) PEAK: RBW=VBW=1.5MHz / Sweep=AUTO

9.2 TEST SETUP

RADIATED EMISSION TEST SETUP

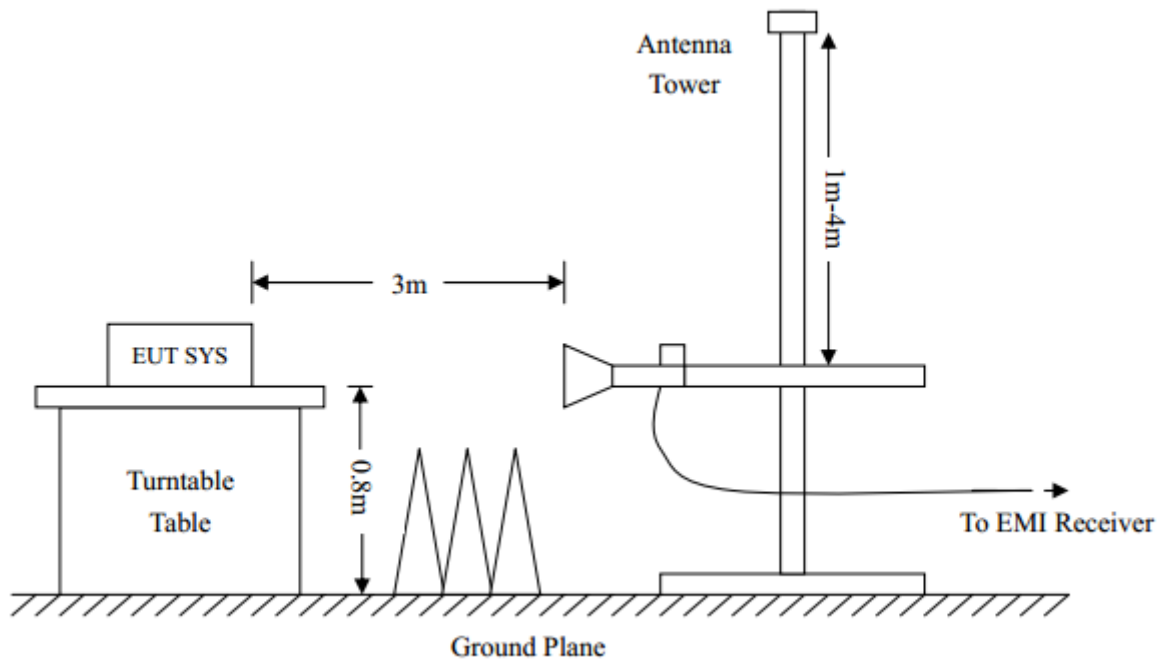

CONDUCTED TEST SETUP

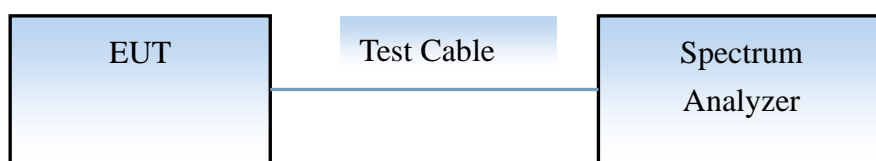

10. 20DB BANDWIDTH

10.1. MEASUREMENT PROCEDURE

1. Connect EUT RF output port to the Spectrum Analyzer through an RF attenuator
2. Set the EUT Work on the top, the middle and the bottom operation frequency individually.
3. Set Span = approximately 2 to 3 times the 20 dB bandwidth, centered on a hopping channel
RBW \geq 1% of the 20 dB bandwidth, VBW \geq RBW; Sweep = auto; Detector function = peak
4. Set SPA Trace 1 Max hold, then View.

10.2. TEST SET-UP

(BLOCK DIAGRAM OF CONFIGURATION)

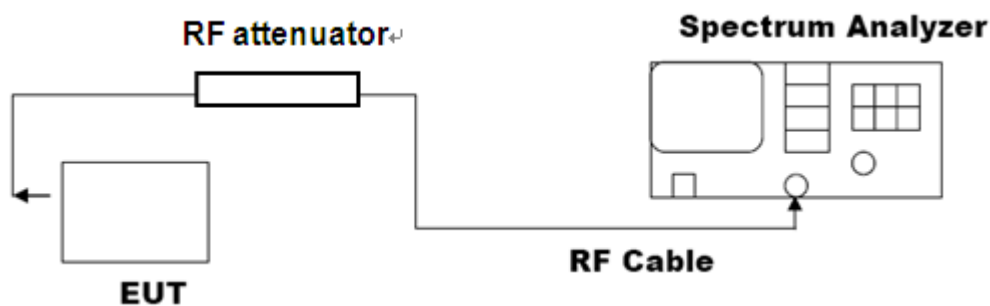

10.3. LIMITS AND MEASUREMENT RESULTS

BLUETOOTH 1MBPS LIMITS AND MEASUREMENT RESULT			
Applicable Limits	Measurement Result		
	Test Data (MHz)		Criteria
N/A	Low Channel	0.907	PASS
	Middle Channel	1.009	PASS
	High Channel	1.009	PASS

TEST PLOT OF BANDWIDTH FOR LOW CHANNEL

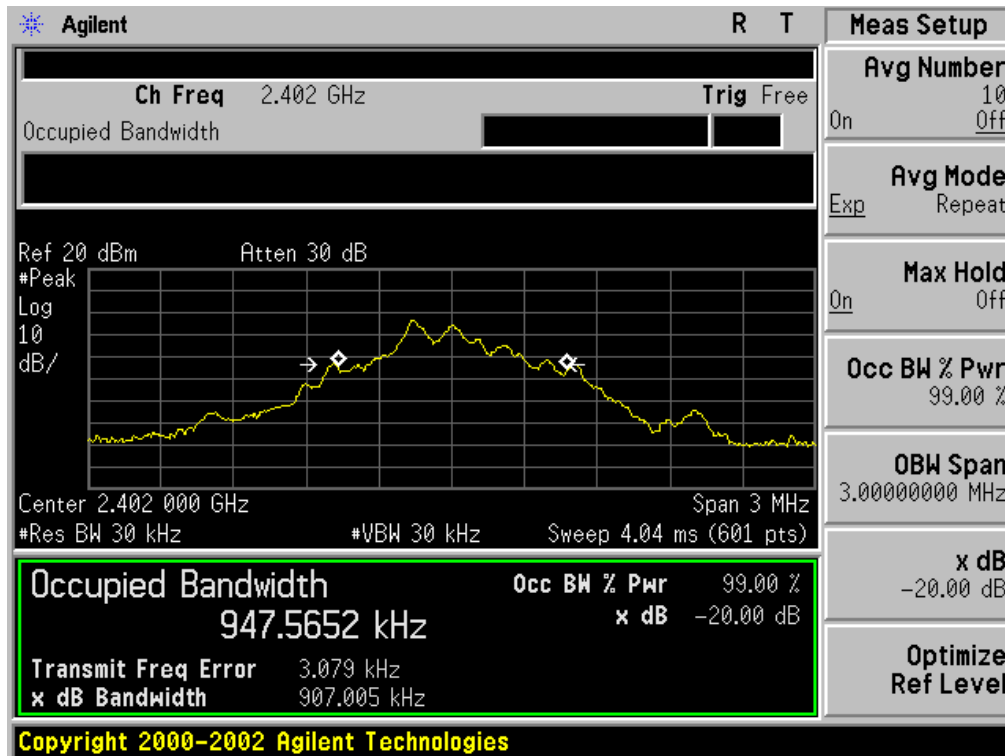

TEST PLOT OF BANDWIDTH FOR MIDDLE CHANNEL

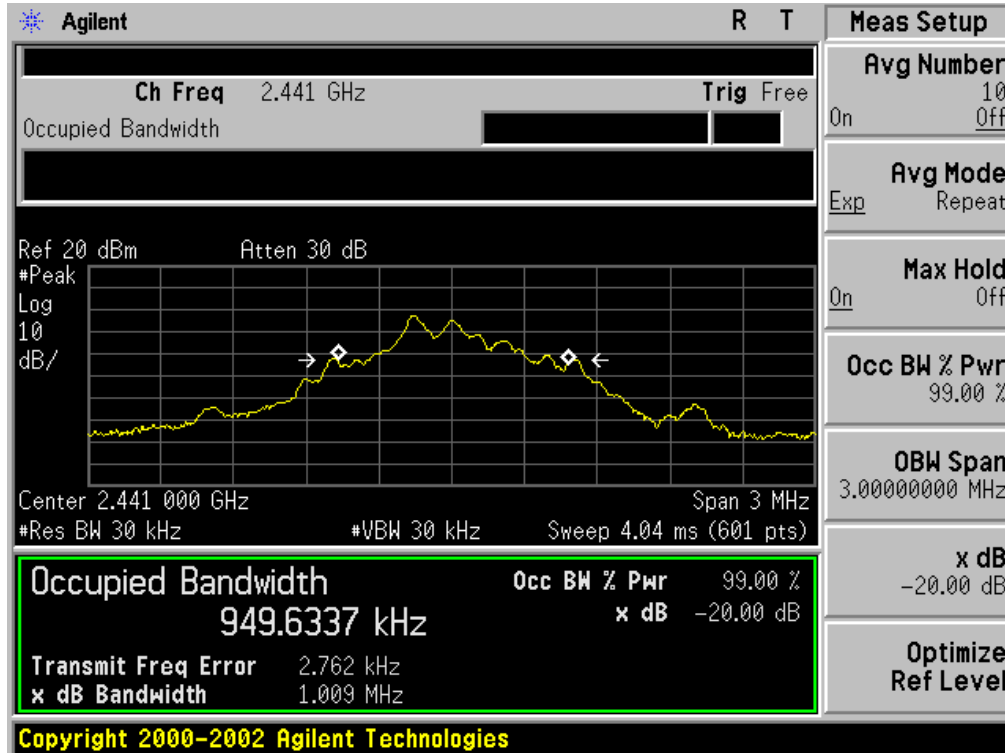

TEST PLOT OF BANDWIDTH FOR HIGH CHANNEL

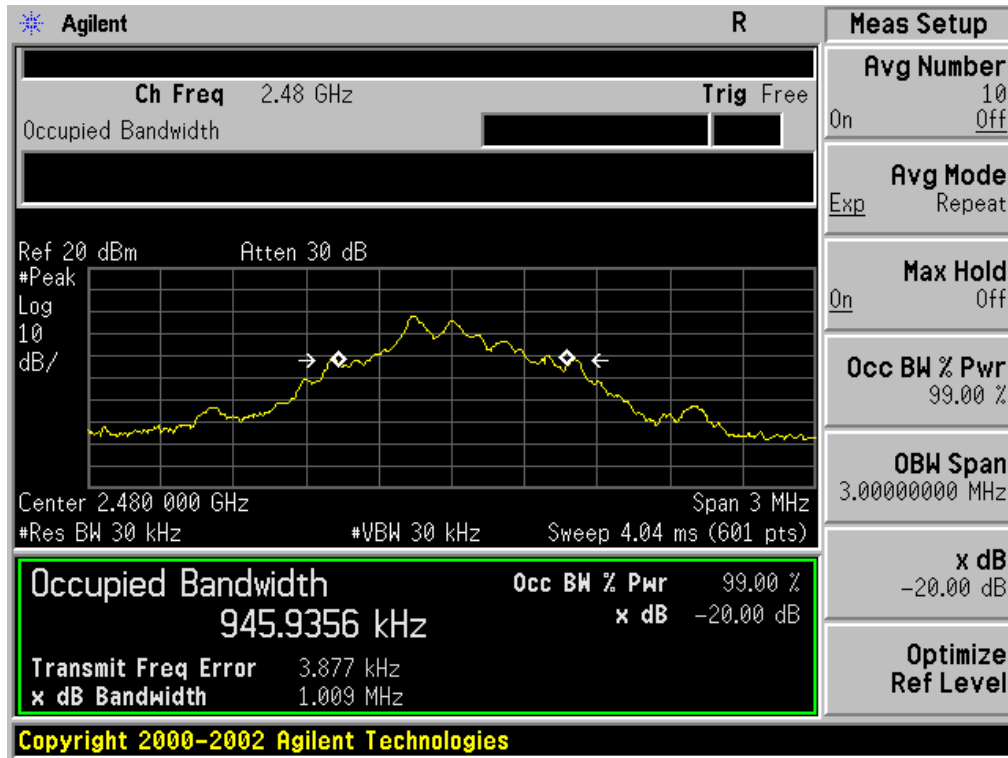

BLUETOOTH 2Mbps LIMITS AND MEASUREMENT RESULT			
Applicable Limits	Measurement Result		
	Test Data (MHz)		Criteria
N/A	Low Channel	1.123	PASS
	Middle Channel	1.119	PASS
	High Channel	1.121	PASS

TEST PLOT OF BANDWIDTH FOR LOW CHANNEL

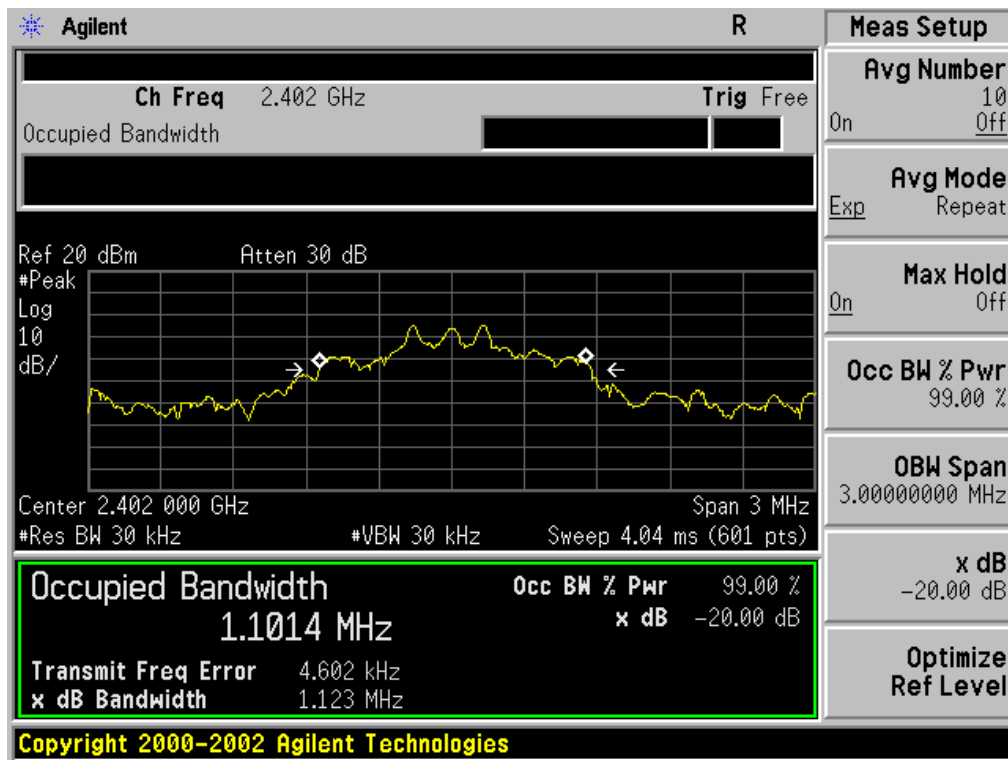

TEST PLOT OF BANDWIDTH FOR MIDDLE CHANNEL

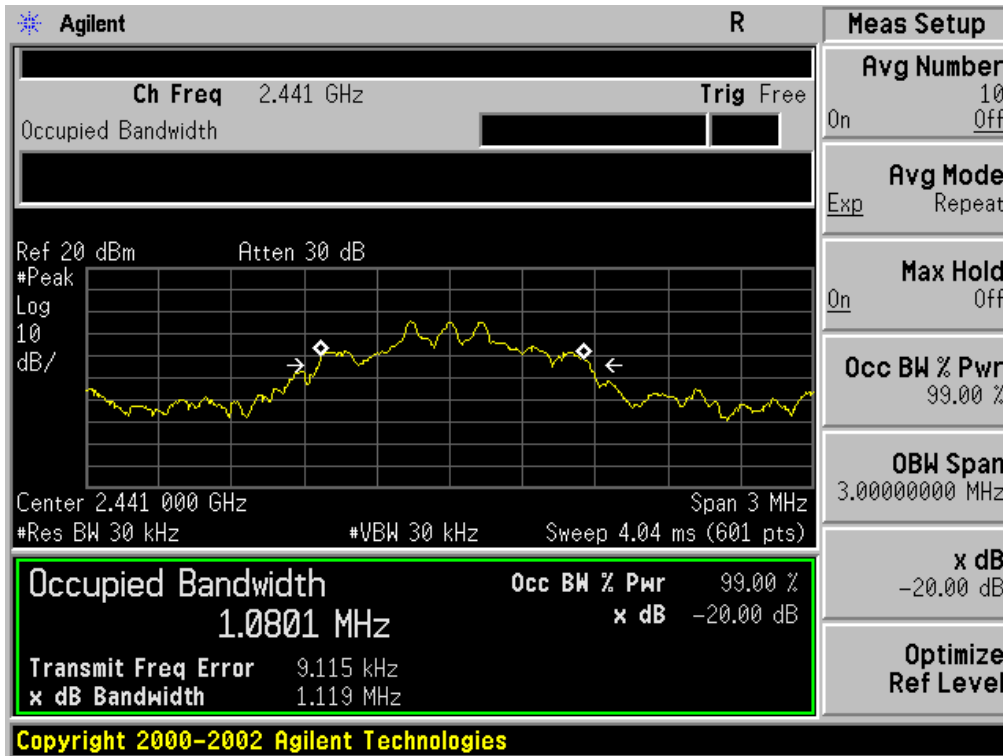

TEST PLOT OF BANDWIDTH FOR HIGH CHANNEL

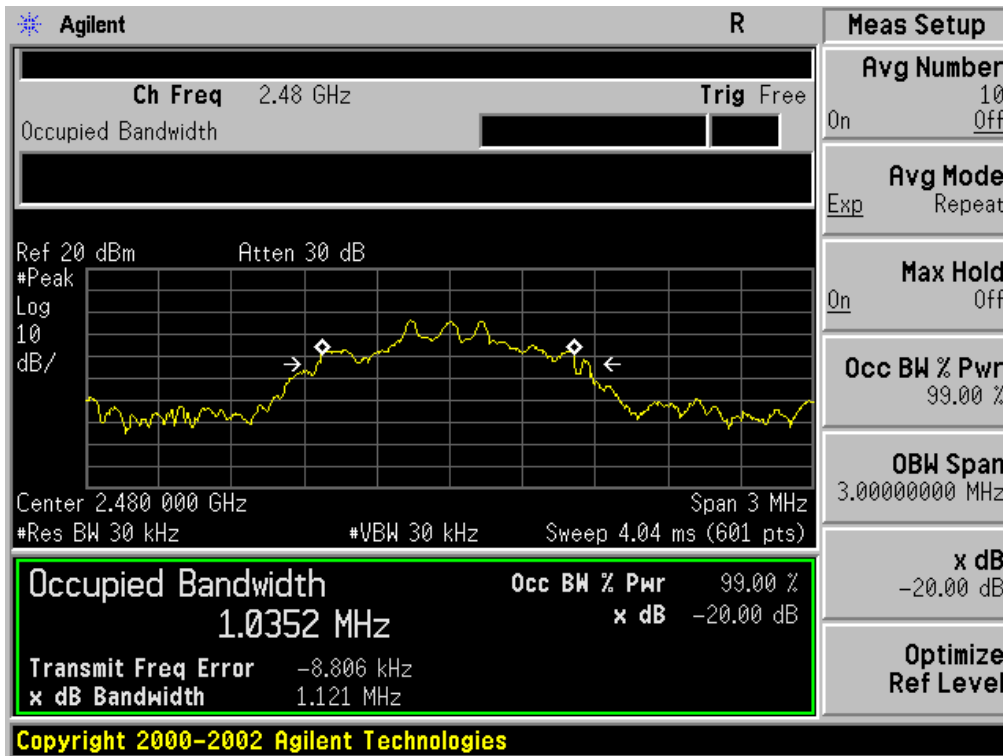

BLUETOOTH 3MBPS LIMITS AND MEASUREMENT RESULT			
Applicable Limits	Measurement Result		
	Test Data (MHz)		Criteria
N/A	Low Channel	1.134	PASS
	Middle Channel	1.136	PASS
	High Channel	1.134	PASS

TEST PLOT OF BANDWIDTH FOR LOW CHANNEL

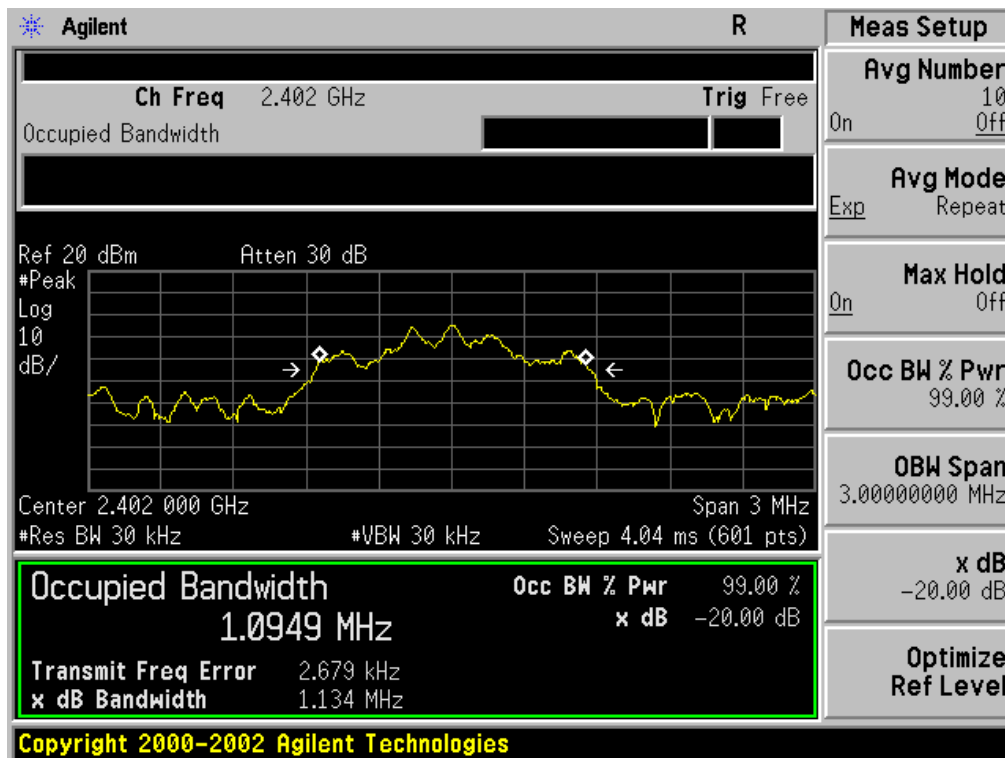

TEST PLOT OF BANDWIDTH FOR MIDDLE CHANNEL

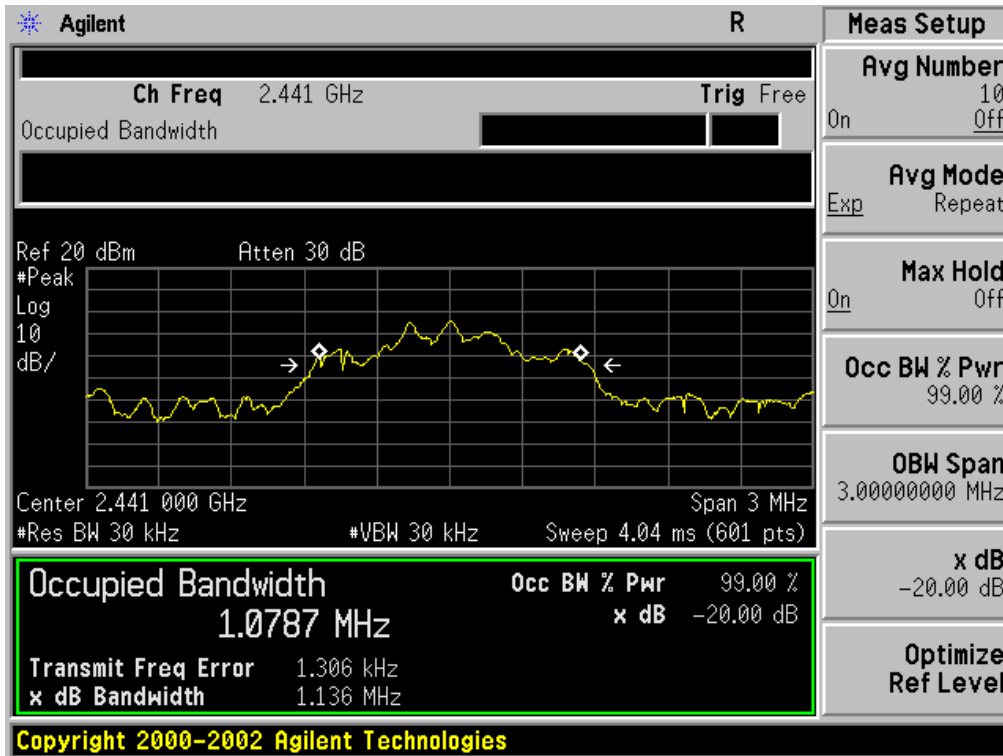

TEST PLOT OF BANDWIDTH FOR HIGH CHANNEL

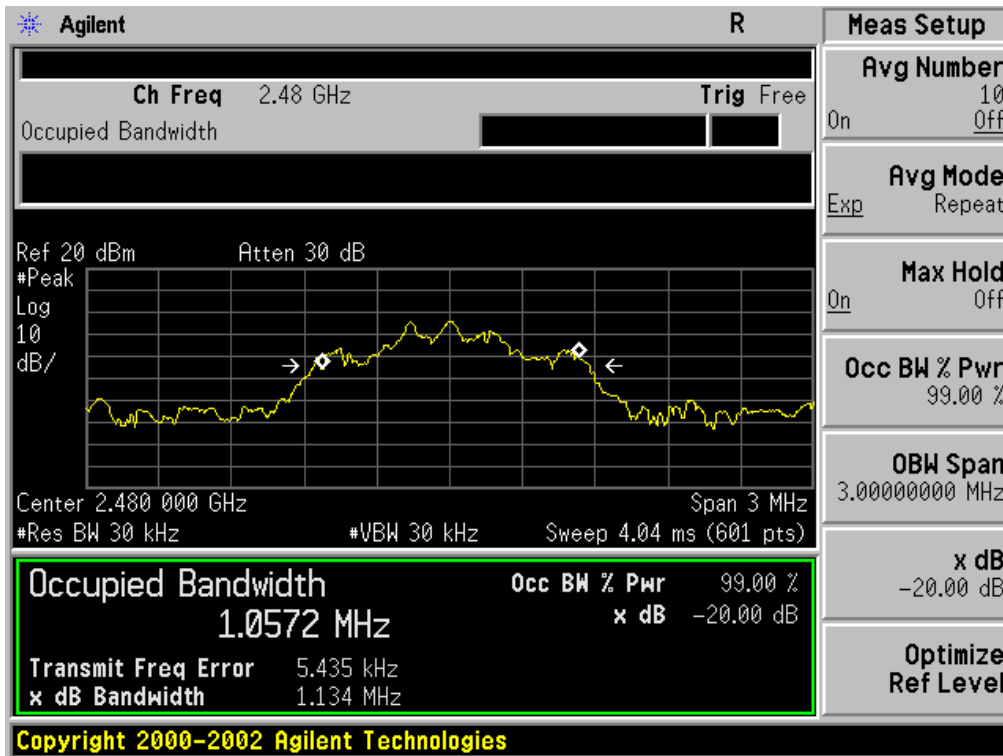

11. FCC LINE CONDUCTED EMISSION TEST

11.1. LIMITS OF LINE CONDUCTED EMISSION TEST

Frequency	Maximum RF Line Voltage	
	Q.P.(dBuV)	Average(dBuV)
150kHz~500kHz	66-56	56-46
500kHz~5MHz	56	46
5MHz~30MHz	60	50

Note:

1. The lower limit shall apply at the transition frequency.
2. The limit decreases linearly with the logarithm of the frequency in the range 0.15 MHz to 0.50 MHz.

11.2. BLOCK DIAGRAM OF LINE CONDUCTED EMISSION TEST

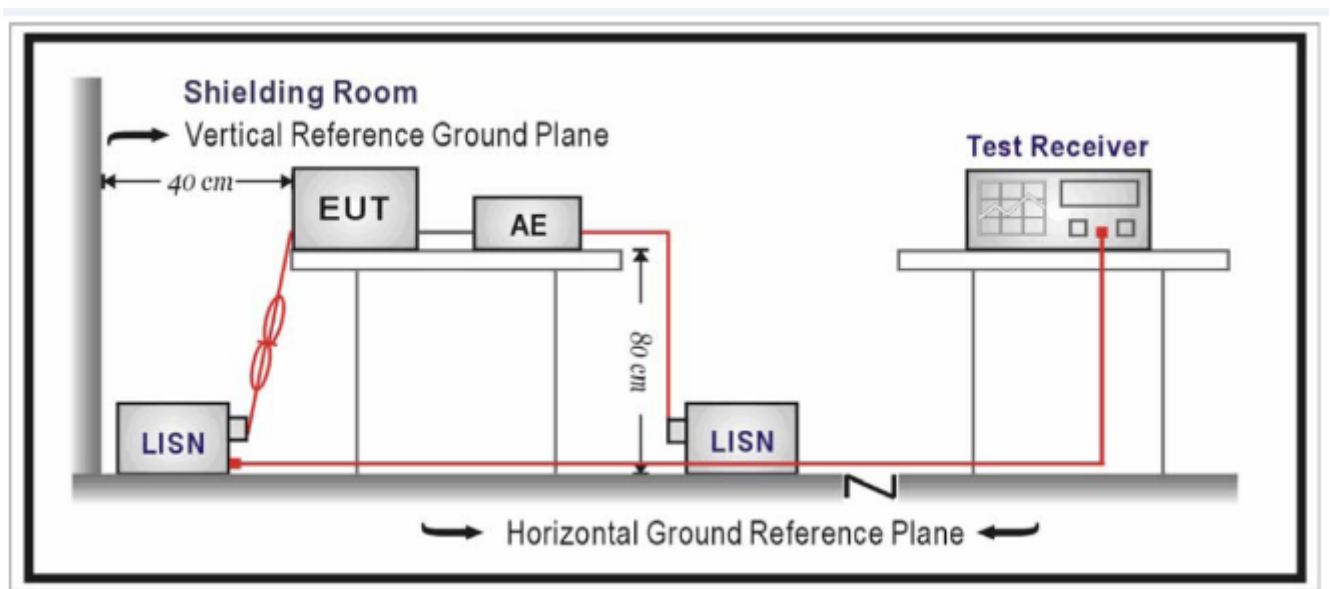

11.3. PRELIMINARY PROCEDURE OF LINE CONDUCTED EMISSION TEST

1. The equipment was set up as per the test configuration to simulate typical actual usage per the user's manual. When the EUT is a tabletop system, a wooden table with a height of 0.8 meters is used and is placed on the ground plane as per ANSI C63.4 (see Test Facility for the dimensions of the ground plane used). When the EUT is a floor-standing equipment, it is placed on the ground plane which has a 3-12 mm non-conductive covering to insulate the EUT from the ground plane.
2. Support equipment, if needed, was placed as per ANSI C63.4.
3. All I/O cables were positioned to simulate typical actual usage as per ANSI C63.4.
4. All support equipments received AC120V/60Hz power from a LISN, if any.
5. The EUT received DC charging voltage by PC which received 120V/60Hz power by a LISN..
6. The test program was started. Emissions were measured on each current carrying line of the EUT using a spectrum Analyzer / Receiver connected to the LISN powering the EUT. The LISN has two monitoring points: Line 1 (Hot Side) and Line 2 (Neutral Side). Two scans were taken: one with Line 1 connected to Analyzer / Receiver and Line 2 connected to a 50 ohm load; the second scan had Line 1 connected to a 50 ohm load and Line 2 connected to the Analyzer / Receiver.
7. Analyzer / Receiver scanned from 150 kHz to 30MHz for emissions in each of the test modes.
8. During the above scans, the emissions were maximized by cable manipulation.
9. The test mode(s) were scanned during the preliminary test.

Then, the EUT configuration and cable configuration of the above highest emission level were recorded for reference of final testing.

11.4. FINAL PROCEDURE OF LINE CONDUCTED EMISSION TEST

- EUT and support equipment was set up on the test bench as per step 2 of the preliminary test.
2. A scan was taken on both power lines, Line 1 and Line 2, recording at least the six highest emissions. Emission frequency and amplitude were recorded into a computer in which correction factors were used to calculate the emission level and compare reading to the applicable limit. If EUT emission level was less -2dB to the A.V. limit in Peak mode, then the emission signal was re-checked using Q.P and Average detector.
3. The test data of the worst case condition(s) was reported on the Summary Data page.

11.5. TEST RESULT OF LINE CONDUCTED EMISSION TEST

Line Conducted Emission Test Line 1-L

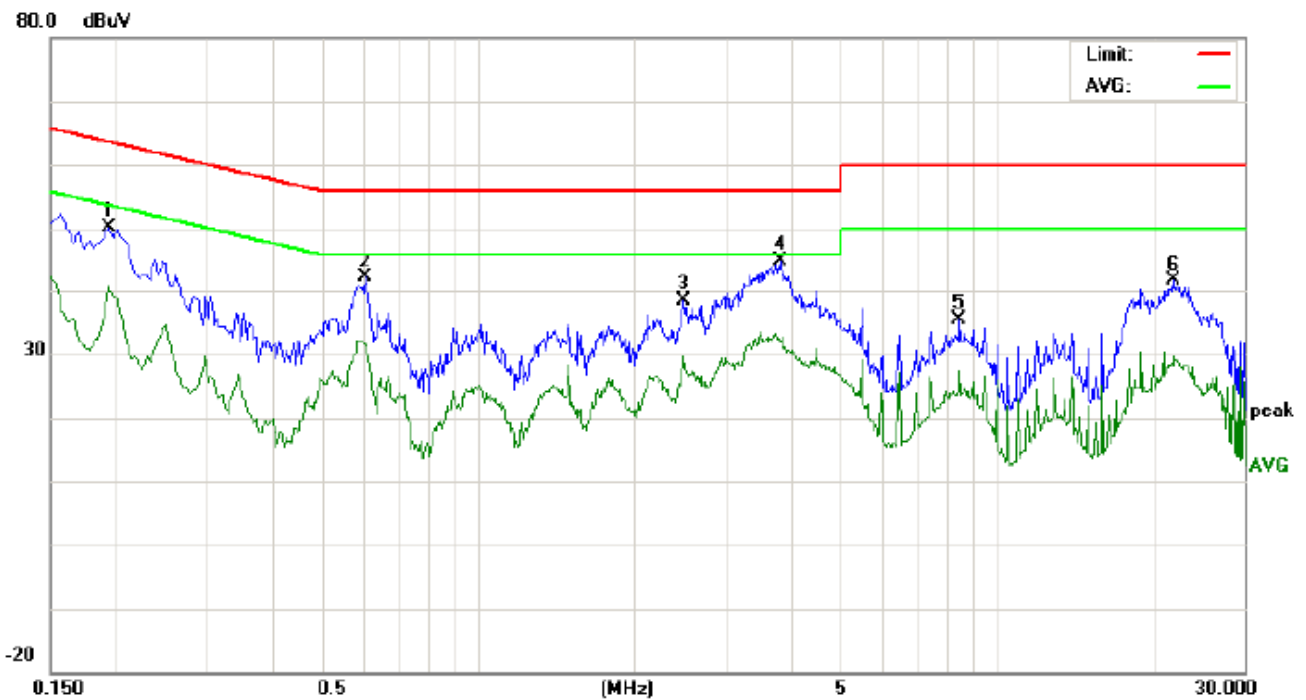

Site: Conduction Phase: **L1** Temperature: 25.3
 Limit: FCC Class B Conduction(QP) Power: Humidity: 51.8 %
 EUT: Bluetooth Speaker
 M/N: U171
 Mode: BT Link with charging
 Note:

No.	Freq. (MHz)	Reading_Level (dBuV)			Correct Factor (dB)	Measurement (dBuV)			Limit (dBuV)		Margin (dB)		P/F	Comment
		Peak	QP	AVG		Peak	QP	AVG	QP	AVG	QP	AVG		
1	0.1940	39.93		30.38	10.21	50.14		40.59	63.86	53.86	-13.72	-13.27	P	
2	0.6060	31.75		21.08	10.31	42.06		31.39	56.00	46.00	-13.94	-14.61	P	
3	2.4980	28.05		19.20	10.43	38.48		29.63	56.00	46.00	-17.52	-16.37	P	
4	3.8340	34.48		21.50	10.46	44.94		31.96	56.00	46.00	-11.06	-14.04	P	
5	8.4899	24.91		17.08	10.34	35.25		27.42	60.00	50.00	-24.75	-22.58	P	
6	21.8500	31.45		18.11	10.12	41.57		28.23	60.00	50.00	-18.43	-21.77	P	

Line Conducted Emission Test Line 2-N

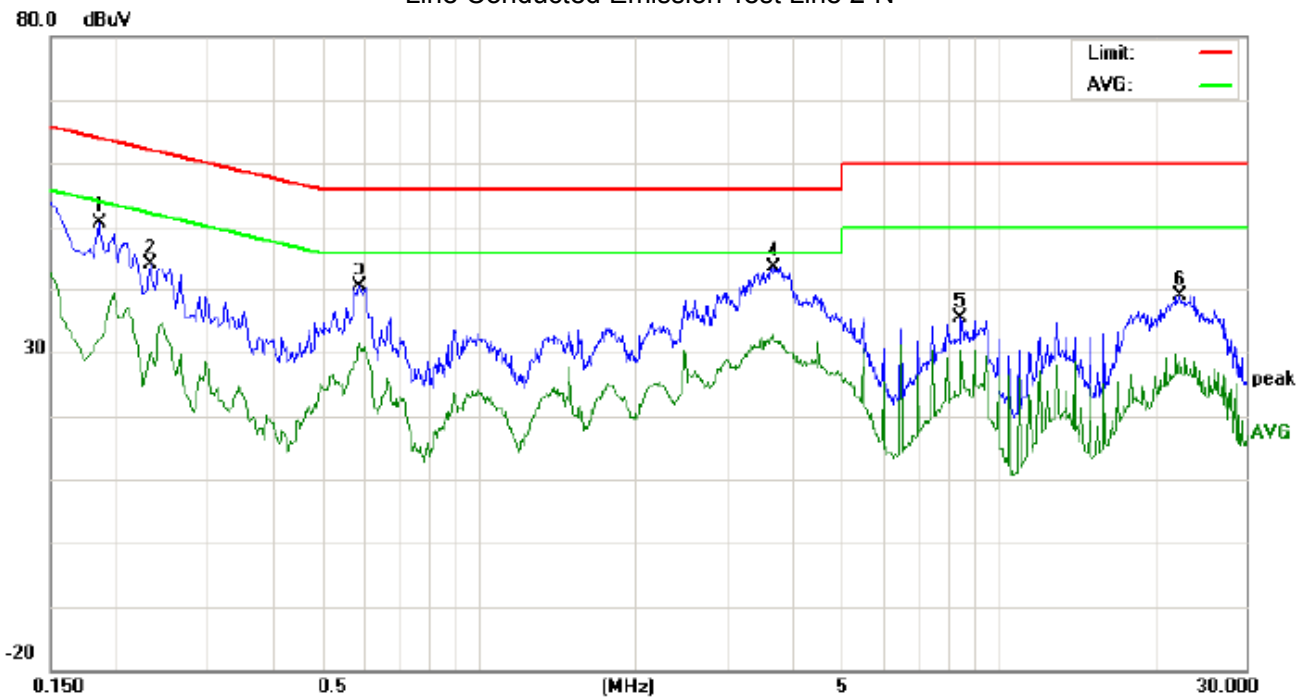

Site: Conduction Phase: **N** Temperature: 25.3
 Limit: FCC Class B Conduction(QP) Power: Humidity: 51.8 %
 EUT: Bluetooth Speaker
 M/N: U171
 Mode: BT Link with charging
 Note:

No.	Freq. (MHz)	Reading_Level (dBuV)			Correct Factor (dB)	Measurement (dBuV)			Limit (dBuV)		Margin (dB)		P/F	Comment
		Peak	QP	AVG		Peak	QP	AVG	QP	AVG	QP	AVG		
1	0.1860	40.42		21.90	10.20	50.62		32.10	64.21	54.21	-13.59	-22.11	P	
2	0.2340	33.90		20.00	10.25	44.15		30.25	62.30	52.30	-18.15	-22.05	P	
3	0.5899	30.10		20.96	10.32	40.42		31.28	56.00	46.00	-15.58	-14.72	P	
4	3.7140	33.04		21.40	10.48	43.52		31.88	56.00	46.00	-12.48	-14.12	P	
5	8.4980	25.14		20.05	10.34	35.48		30.39	60.00	50.00	-24.52	-19.61	P	
6	22.3700	28.71		17.25	10.12	38.83		27.37	60.00	50.00	-21.17	-22.63	P	

APPENDIX A: PHOTOGRAPHS OF TEST SETUP
FCC LINE CONDUCTED EMISSION TEST SETUP



FCC RADIATED EMISSION TEST SETUP

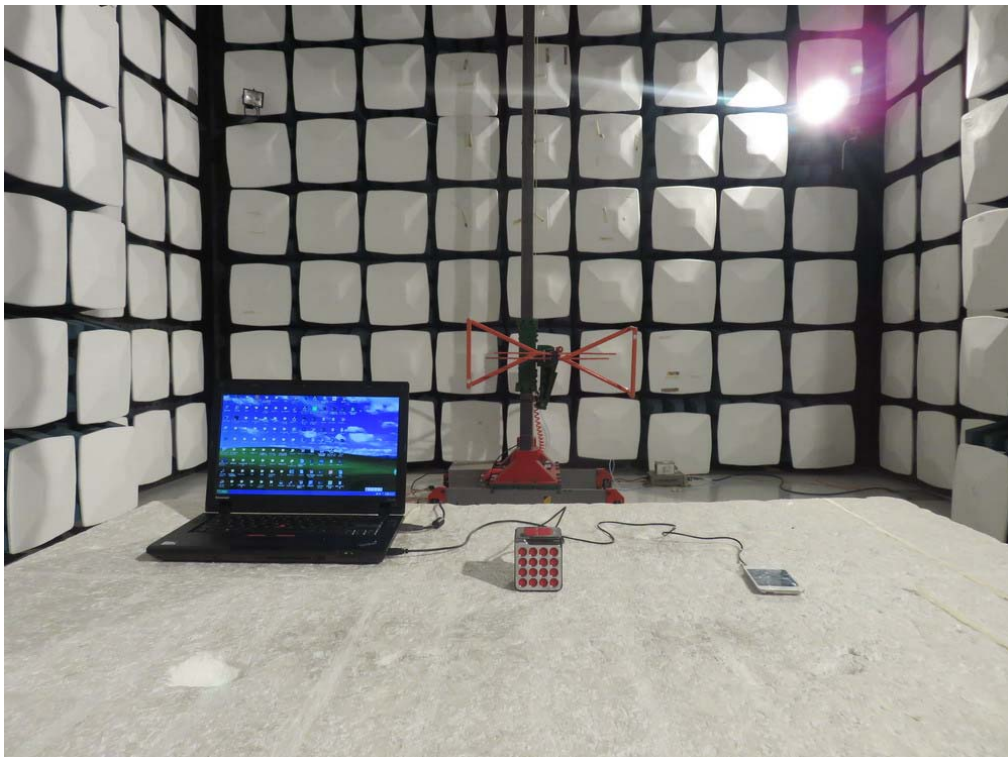

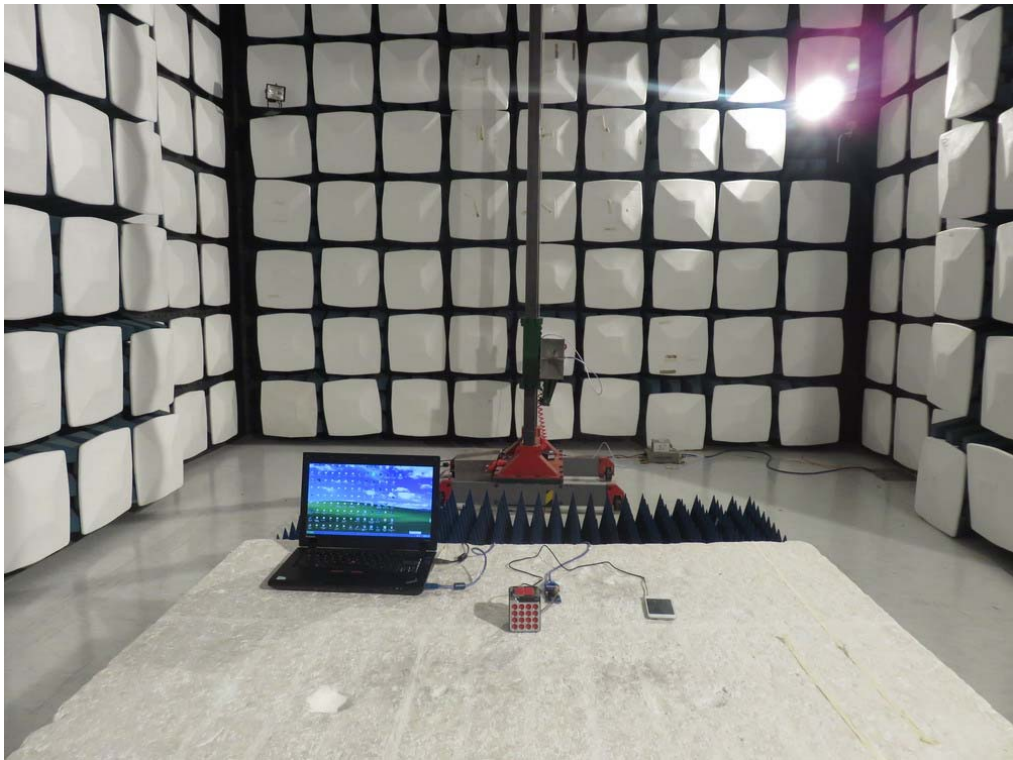

APPENDIX B: PHOTOGRAPHS OF EUT
TOTAL VIEW OF EUT



TOP VIEW OF EUT

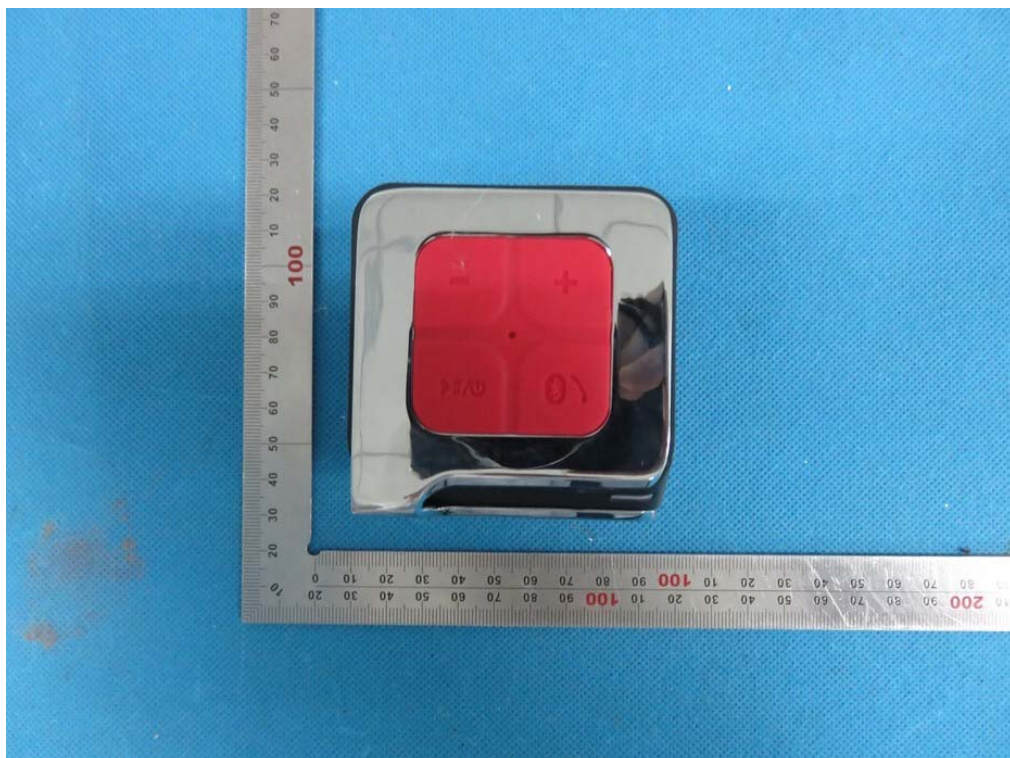

BOTTOM VIEW OF EUT

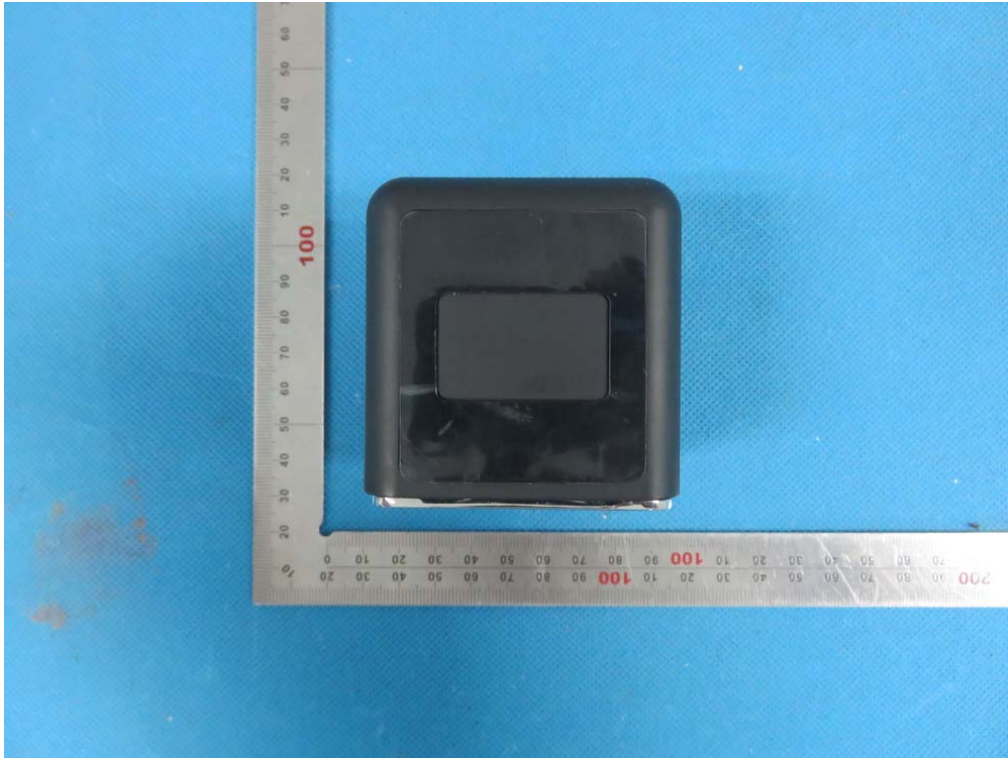

FRONT VIEW OF EUT

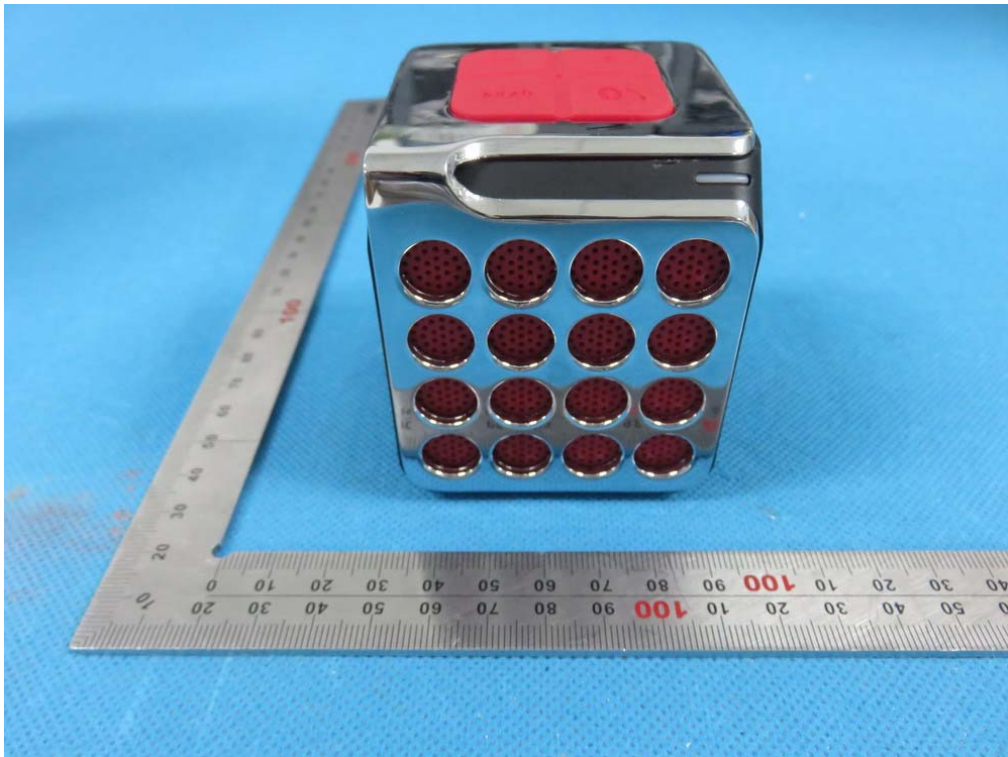

BACK VIEW OF EUT



LEFT VIEW OF EUT

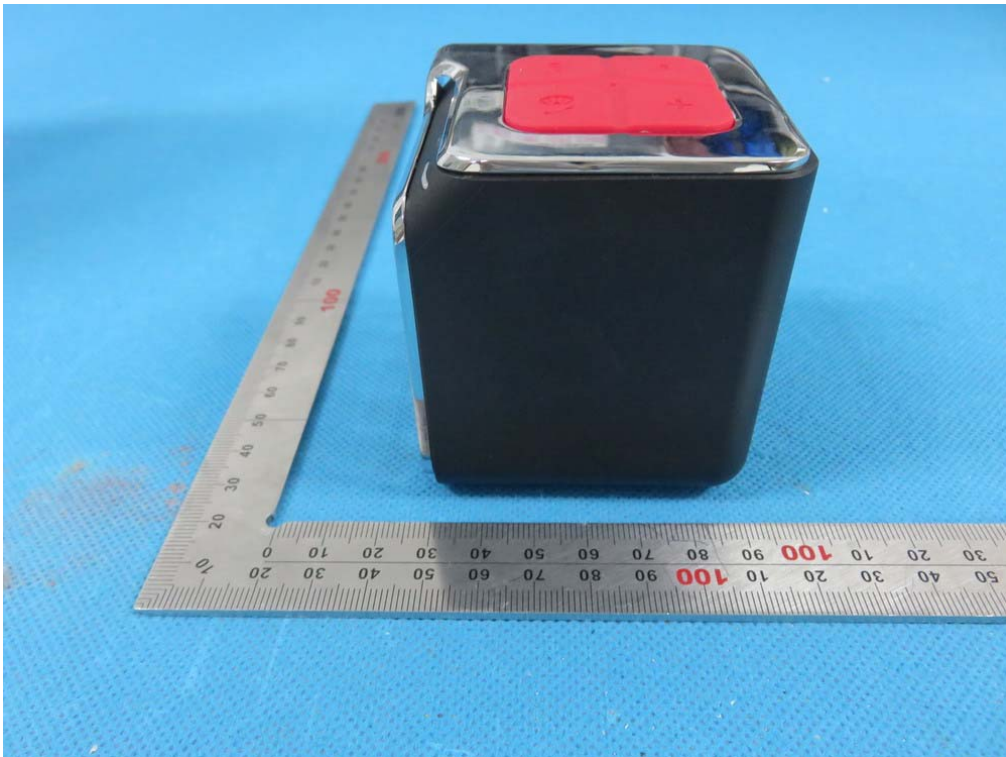

RIGHT VIEW OF EUT



OPEN VIEW OF EUT-1

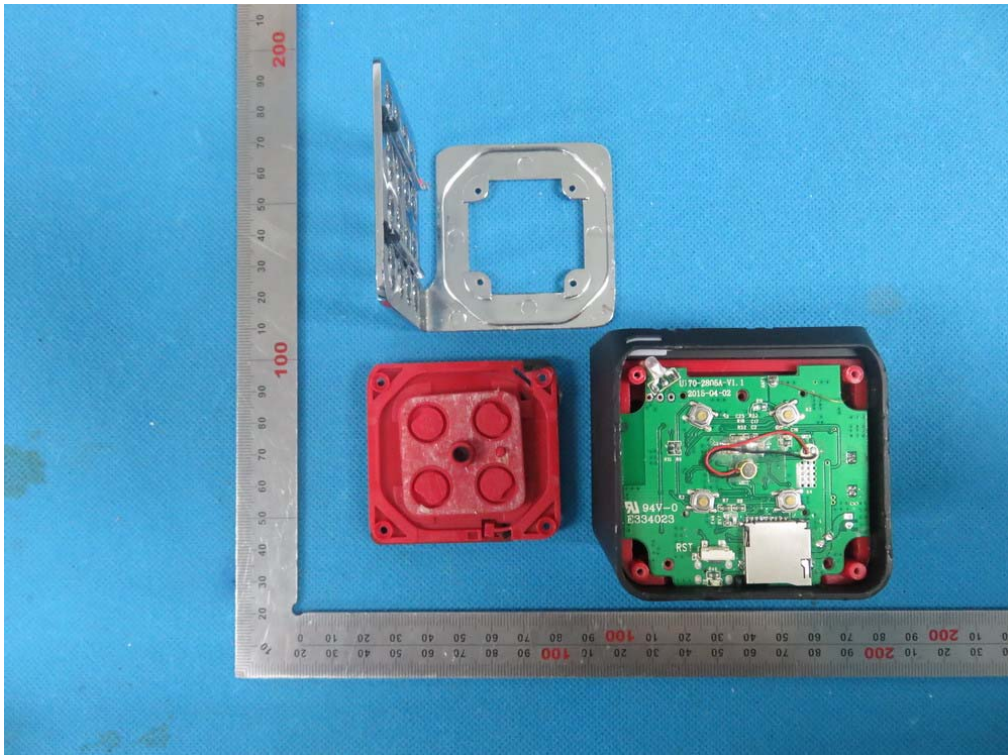

OPEN VIEW OF EUT-2



INTERNAL VIEW OF EUT-1

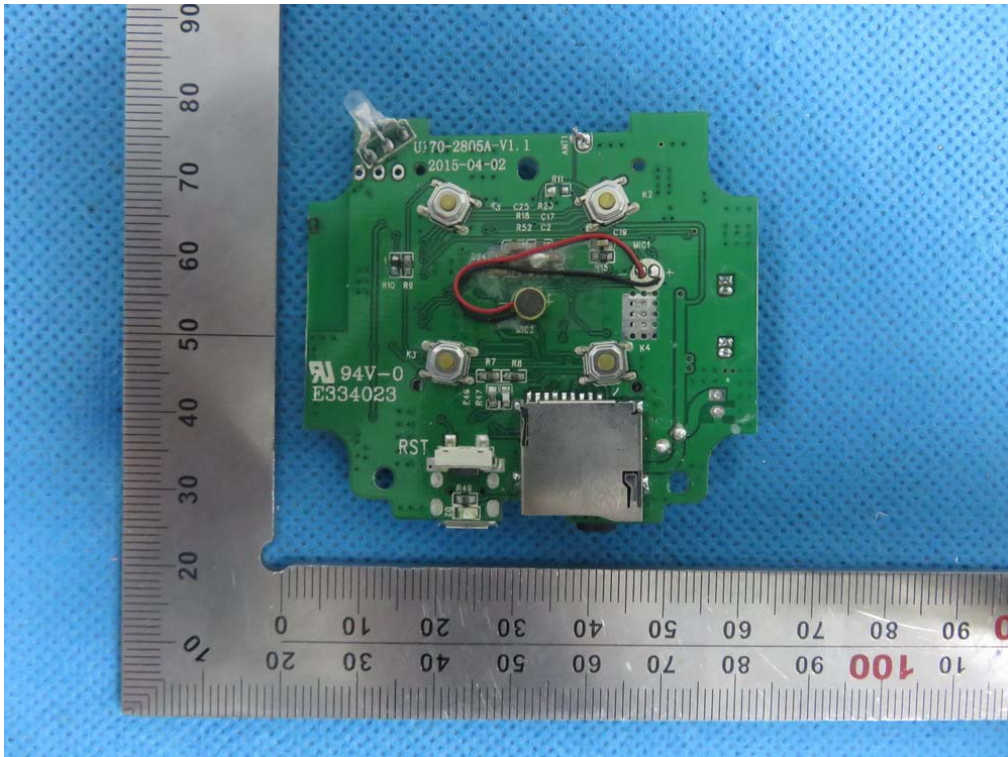

INTERNAL VIEW OF EUT-2

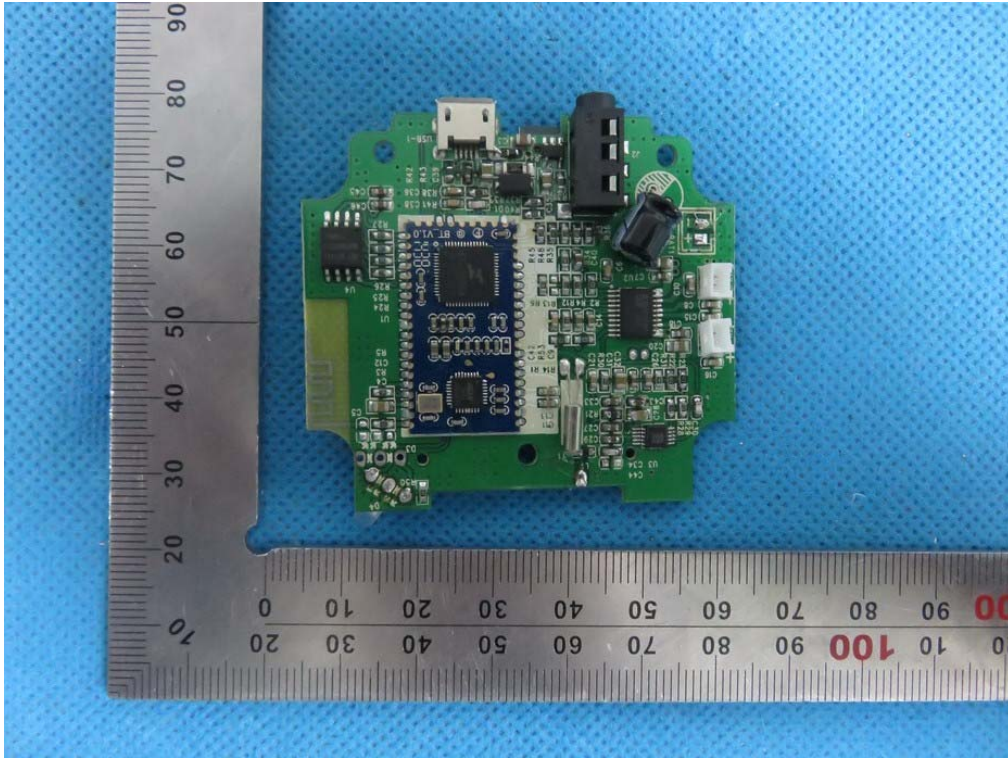

INTERNAL VIEW OF EUT-3

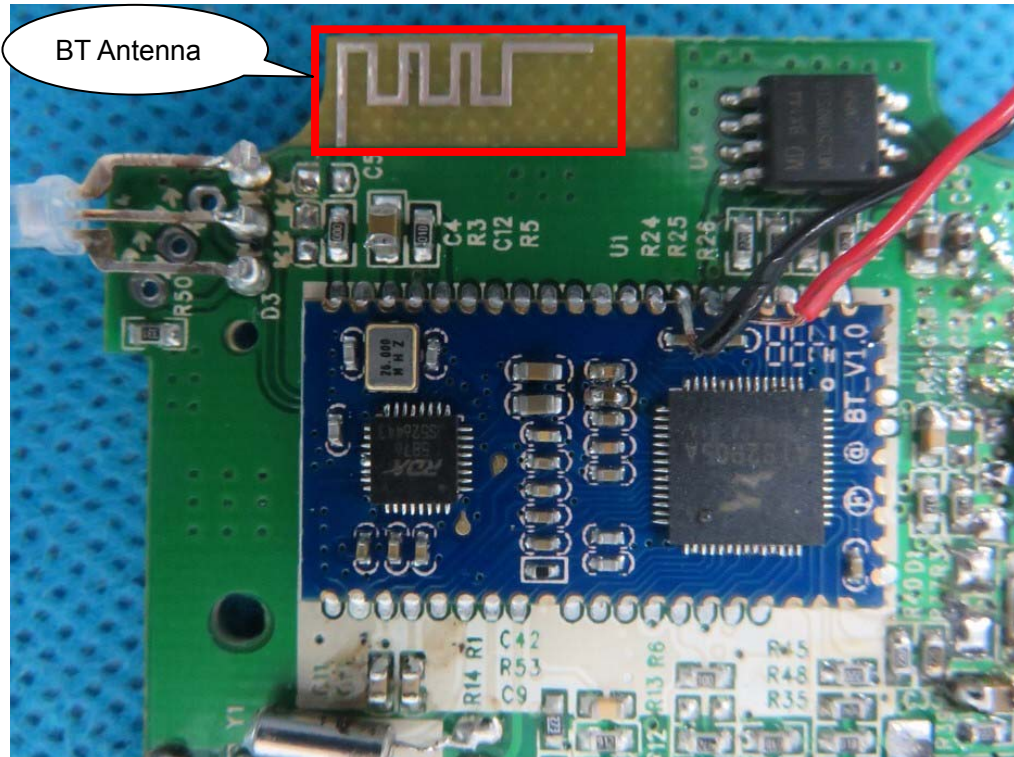

INTERNAL VIEW OF EUT-4

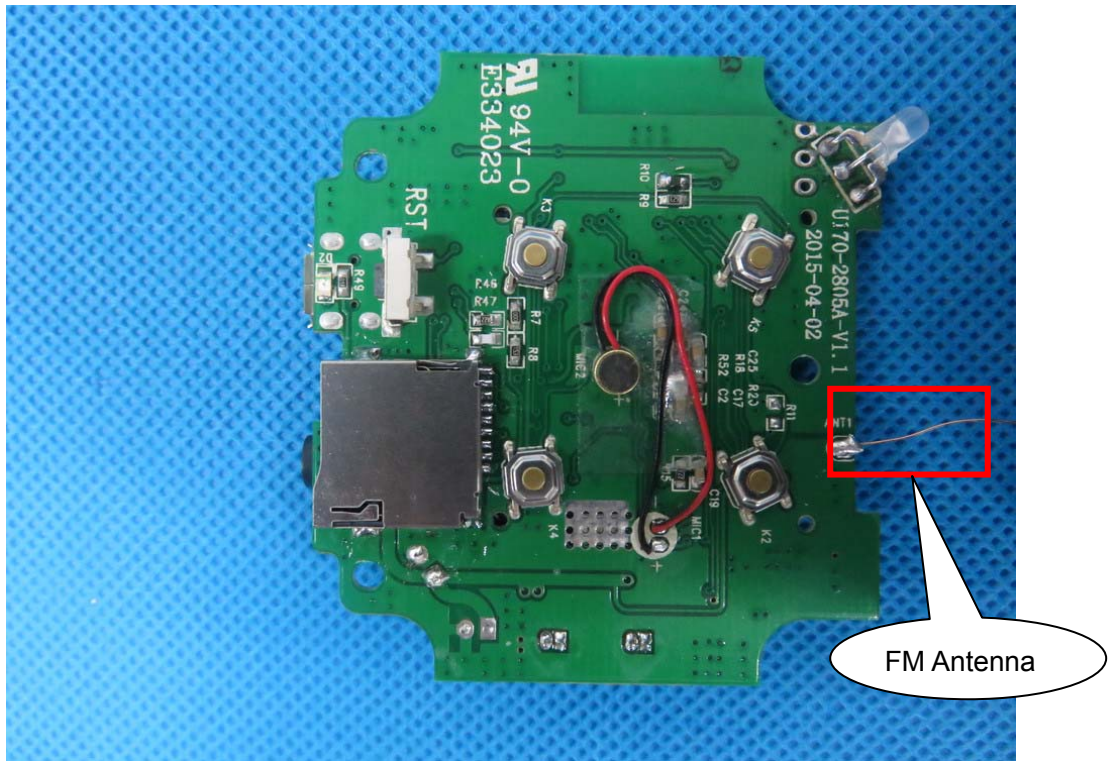

----END OF REPORT----