



# FCC TEST REPORT

## FCC ID: SXQ-MXB010

**Report Number**..... : ZKT-2406066368E

Date of Test..... Jun. 11, 2024 to Jun. 18, 2024

Date of issue..... Jun. 18, 2024

Total number of pages..... 28

Test Result ..... : PASS

**Testing Laboratory**..... : Shenzhen ZKT Technology Co., Ltd.

Address ..... : 1/F, No. 101, Building B, No. 6, Tangwei Community Industrial Avenue, Fuhai Street, Bao'an District, Shenzhen, China

**Applicant's name** ..... : U2O GLOBAL CO., LTD.

Address ..... : U2O building, Huanzhu Road 385, Jimei district Xiamen, Fujian China

**Manufacturer's name** ..... : U2O GLOBAL CO., LTD.

Address ..... : U2O building, Huanzhu Road 385, Jimei district Xiamen, Fujian China

**Test specification:**

Standard..... : FCC CFR Title 47 Part 15 Subpart C

Test procedure..... : /

Non-standard test method ..... : N/A

**Test Report Form No**..... : TRF-EL-107\_V0

**Test Report Form(s) Originator**..... : ZKT Testing

**Master TRF** ..... : Dated: 2020-01-06

This device described above has been tested by ZKT, and the test results show that the equipment under test (EUT) is in compliance with the FCC requirements. And it is applicable only to the tested sample identified in the report.

This report shall not be reproduced except in full, without the written approval of ZKT, this document may be altered or revised by ZKT, personal only, and shall be noted in the revision of the document.

**Product name**..... : PowerHybrid

Trademark ..... : N/A

Model/Type reference..... : MXB010

Ratings..... : USB-C Cable/Port Input: 5V --- 3A, 9V --- 3A, 12V --- 2.5A, 15V --- 2A, 20V --- 1.5A  
USB-C Cable/Port Output: 5V --- 3A, 9V --- 3A, 12V --- 2.5A, 15V --- 2A, 20V --- 1.5A  
Wireless Charging: 5W/7.5W/10W/15W  
Battery Capacity: 10000mAh(DC 3.85V/38.5Wh)



**Testing procedure and testing location:**

**Testing Laboratory**.....: **Shenzhen ZKT Technology Co., Ltd.**

**Address**.....: 1/F, No. 101, Building B, No. 6, Tangwei Community Industrial Avenue, Fuhai Street, Bao'an District, Shenzhen, China

**Tested by (name + signature)**.....: Jim Liu

**Reviewer (name + signature)**.....: Jackson Fang

**Approved (name + signature)**.....: Lake Xie





## TABLE OF CONTENTS

<b>1. VERSION</b> .....	<b>4</b>
<b>2. TEST SUMMARY</b> .....	<b>5</b>
2.1 TEST FACILITY .....	6
2.2 MEASUREMENT UNCERTAINTY .....	6
<b>3. GENERAL INFORMATION</b> .....	<b>7</b>
3.1 GENERAL DESCRIPTION OF EUT .....	7
3.2 Test mode .....	8
3.3 Block Diagram of EUT Configuration .....	9
3.4 Test Conditions .....	10
3.5 Description Of Support Units (Conducted Mode) .....	10
3.6 EQUIPMENTS LIST FOR ALL TEST ITEMS .....	11
<b>4. CONDUCTED EMISSION TEST</b> .....	<b>13</b>
4.1 CONDUCTED EMISSION MEASUREMENT .....	13
4.1.1 POWER LINE CONDUCTED EMISSION Limits .....	13
4.1.2 TEST PROCEDURE .....	13
4.1.3 DEVIATION FROM TEST STANDARD .....	13
4.1.4 TEST SETUP .....	14
4.1.5 EUT OPERATING CONDITIONS .....	14
4.1.6 Test Result .....	15
<b>5. RADIATED EMISSION MEASUREMENT</b> .....	<b>17</b>
5.1 Radiated Emission Limits .....	17
5.2 Anechoic Chamber Test Setup Diagram .....	18
5.3 Test Procedure .....	18
5.4 DEVIATION FROM TEST STANDARD .....	18
5.5 Test Result .....	19
<b>6. 20DB BANDWIDTH TEST</b> .....	<b>25</b>
<b>7. ANTENNA REQUIREMENT</b> .....	<b>27</b>
<b>8. TEST SETUP PHOTO</b> .....	<b>28</b>
<b>9. EUT CONSTRUCTIONAL DETAILS</b> .....	<b>28</b>



### 1. VERSION

Report No.	Version	Description	Approved
ZKT-2406066368E	Rev.01	Initial issue of report	Jun. 18, 2024



## 2. TEST SUMMARY

Test Item	Section in CFR 47	Result
Antenna requirement	15.203	Pass
AC Power Line Conducted Emission	15.207	Pass
Spurious Emission	15.209(a)(f)	Pass
20dB Bandwidth	15.215	Pass

NOTE:

(1) "N/A" denotes test is not applicable in this Test Report



## 2.1 TEST FACILITY

Shenzhen ZKT Technology Co., Ltd.  
Add. : 1/F, No. 101, Building B, No. 6, Tangwei Community Industrial Avenue, Fuhai Street, Bao'an District, Shenzhen, China

FCC Test Firm Registration Number: 692225  
Designation Number: CN1299  
IC Registered No.: 27033  
CAB identifier: CN0110

## 2.2 MEASUREMENT UNCERTAINTY

The reported uncertainty of measurement  $y \pm U$ , where expanded uncertainty  $U$  is based on a standard uncertainty multiplied by a coverage factor of  $k=2$ , providing a level of confidence of approximately 95 %.

No.	Item	Uncertainty
1	3m chamber Radiated spurious emission(9KHz-30MHz)	U=4.5dB
2	3m chamber Radiated spurious emission(30MHz-1GHz)	U=4.8dB
3	3m chamber Radiated spurious emission(1GHz-6GHz)	U=4.9dB
4	3m chamber Radiated spurious emission(6GHz-40GHz)	U=5.0dB
5	Conducted disturbance	U=3.2dB
6	RF conducted Spurious Emission	U=2.2dB
7	RF Occupied Bandwidth	U=1.8MHz
8	humidity uncertainty	U=5.3%
9	Temperature uncertainty	U=0.59°C



### 3. GENERAL INFORMATION

#### 3.1 GENERAL DESCRIPTION OF EUT

Product Name:	PowerHybrid
Model No.:	MXB010
Serial No.:	N/A
Model Difference:	N/A
Hardware Version:	H 1.0
Software Version:	V 1.1
Operation Frequency:	115kHz-205kHz
Modulation Type:	ASK
Antenna Type:	Loop Coil Antenna
Antenna Gain:	0dBi
Ratings:	USB-C Cable/Port Input: 5V $\equiv$ 3A, 9V $\equiv$ 3A, 12V $\equiv$ 2.5A, 15V $\equiv$ 2A, 20V $\equiv$ 1.5A USB-C Cable/Port Output: 5V $\equiv$ 3A, 9V $\equiv$ 3A, 12V $\equiv$ 2.5A, 15V $\equiv$ 2A, 20V $\equiv$ 1.5A Wireless Charging: 5W/7.5W/10W/15W
Battery Capacity:	10000mAh(DC 3.85V/38.5Wh)
Transmitting Mode:	Keep the EUT in continuously wireless charging mode



### 3.2 Test mode

To investigate the maximum EMI emission characteristics generated from EUT, the test system was pre-scanning tested based on the consideration of following EUT operation mode or test configuration mode which possibly have effect on EMI emission level. Each of these EUT operation mode(s) or test configuration mode(s) mentioned above was evaluated respectively.

#### a. EUT mode of adapter input + wireless charge output:

Test Modes:	Test Coil	Description:
Mode 1	ANT 1	AC/DC Adapter + EUT + Phone (Battery Status: <1%)
Mode 2		AC/DC Adapter + EUT + Phone (Battery Status: 50%)
Mode 3		AC/DC Adapter + EUT + Phone (Battery Status: >98%)

#### b. EUT mode of wireless charge output:

Test Modes:	Test Coil	Description:
Mode 1a	ANT 1	EUT + Phone (Battery Status: <1%)
Mode 2a		EUT + Phone (Battery Status: 50%)
Mode 3a		EUT + Phone (Battery Status: >98%)





### 3.3 Block Diagram of EUT Configuration

#### Conducted Emission

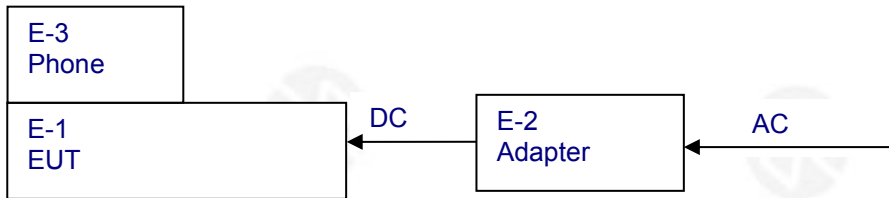

#### Radiated Emission

A:

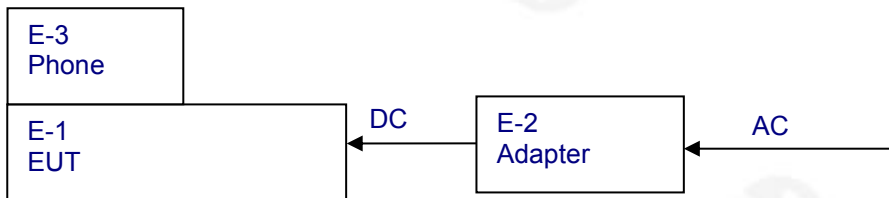

B:

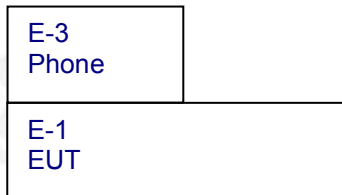



### 3.4 Test Conditions

Temperature: 23~26°C

Relative Humidity: 54~63 %

### 3.5 Description Of Support Units (Conducted Mode)

The EUT has been tested as an independent unit together with other necessary accessories or support units. The following support units or accessories were used to form a representative test configuration during the tests.

Item	Equipment	Mfr/Brand	Model/Type No.	Series No.	Note
E-1	PowerHybrid	N/A	MXB010	N/A	EUT
E-2	AC/DC Adapter	HUAWEI	HW-200200CP1	N/A	Auxiliary
E-3	Phone	Apple	iPhone 13	N/A	Auxiliary

Item	Shielded Type	Ferrite Core	Length	Note
C1	NO	NO	0.8M	DC cable unshielded

Note:

- (1) The support equipment was authorized by Declaration of Confirmation.
- (2) For detachable type I/O cable should be specified the length in cm in 『Length』 column.
- (3) “YES” is means “shielded” “with core”; “NO” is means “unshielded” “without core”.



### 3.6 EQUIPMENTS LIST FOR ALL TEST ITEMS

#### Conduction Test equipment

Item	Kind of Equipment	Manufacturer	Type No.	Serial No.	Firmware Version	Last calibration	Calibrated until
1	LISN	R&S	ENV216	101471	N/A	Nov. 14, 2023	Nov. 13, 2024
2	LISN	CYBERTEK	EM5040A	E1850400149	N/A	Nov. 02, 2023	Nov. 01, 2024
3	Test Cable	N/A	C-01	N/A	N/A	Nov. 02, 2023	Nov. 01, 2024
4	Test Cable	N/A	C-02	N/A	N/A	Nov. 02, 2023	Nov. 01, 2024
5	Test Cable	N/A	C-03	N/A	N/A	Nov. 02, 2023	Nov. 01, 2024
6	EMI Test Receiver	R&S	ESCI3	101393	4.42 SP3	Nov. 02, 2023	Nov. 01, 2024
7	Triple-Loop Antenna	N/A	RF300	N/A	N/A	Nov. 02, 2023	Nov. 01, 2024
8	Absorbing Clamp	DZ	ZN23201	15034	N/A	Nov. 07, 2023	Nov. 06, 2024
9	EMC Software	Frad	EZ-EMC	Ver.EMC-CON 3A1.1	N/A	\	\

#### Radiation Test equipment

Item	Equipment	Manufacturer	Type No.	Serial No.	Firmware Version	Last calibration	Calibrated until
1	Spectrum Analyzer (9kHz-26.5GHz)	KEYSIGHT	9020A	MY55370835	A.17.05	Nov. 02, 2023	Nov. 01, 2024
2	Spectrum Analyzer (10kHz-39.9GHz)	R&S	FSV40-N	100363	1.71 SP2	Nov. 02, 2023	Nov. 01, 2024
3	EMI Test Receiver (9kHz-7GHz)	R&S	ESCI7	101169	4.32	Nov. 02, 2023	Nov. 01, 2024
4	Bilog Antenna (30MHz-1500MHz)	Schwarzbeck	VULB9168	N/A	N/A	Nov. 13, 2023	Nov. 12, 2024
5	Horn Antenna (1GHz-18GHz)	Agilent	AH-118	071145	N/A	Nov. 13, 2023	Nov. 12, 2024
6	Horn Antenna (15GHz-40GHz)	A.H.System	SAS-574	588	N/A	Nov. 13, 2023	Nov. 12, 2024
7	Loop Antenna	TESEQ	HLA6121	58357	N/A	Nov. 16, 2023	Nov. 15, 2024
8	Amplifier (30-1000MHz)	EM Electronics	EM330 Amplifier	060747	N/A	Nov. 02, 2023	Nov. 01, 2024
9	Amplifier (1GHz-26.5GHz)	Agilent	8449B	3008A00315	N/A	Nov. 02, 2023	Nov. 01, 2024
10	Amplifier (500MHz-40GHz)	QuanJuDa	DLE-161	097	N/A	Nov. 02, 2023	Nov. 01, 2024
11	Test Cable	N/A	R-01	N/A	N/A	Nov. 02, 2023	Nov. 01, 2024
12	Test Cable	N/A	R-02	N/A	N/A	Nov. 02, 2023	Nov. 01, 2024
13	Test Cable	N/A	R-03	N/A	N/A	Nov. 02, 2023	Nov. 01, 2024
14	D.C. Power Supply	LongWei	TPR-6405D	N/A	N/A	\	\
15	EMC Software	Frad	EZ-EMC	Ver.EMC-CO N 3A1.1	N/A	\	\
16	Turntable	MF	MF-7802BS	N/A	N/A	\	\
17	Antenna tower	MF	MF-7802BS	N/A	N/A	\	\



RF Test equipment

Item	Equipment	Manufacturer	Type No.	Serial No.	Firmware Version	Last calibration	Calibrated until
1	Spectrum Analyzer (9kHz-26.5GHz)	KEYSIGHT	9020A	MY55370835	A.17.05	Nov. 02, 2023	Nov. 01, 2024
2	Spectrum Analyzer (10kHz-39.9GHz)	R&S	FSV40-N	100363	1.71 SP2	Nov. 02, 2023	Nov. 01, 2024
3	Test Cable	N/A	RF-01	N/A	N/A	Nov. 02, 2023	Nov. 01, 2024
4	Test Cable	N/A	RF-02	N/A	N/A	Nov. 02, 2023	Nov. 01, 2024
5	Test Cable	N/A	RF-03	N/A	N/A	Nov. 02, 2023	Nov. 01, 2024
6	ESG Signal Generator	Agilent	E4421B	N/A	B.03.84	Nov. 02, 2023	Nov. 01, 2024
7	Signal Generator	Agilent	N5182A	N/A	A.01.87	Nov. 02, 2023	Nov. 01, 2024
8	Magnetic Field Probe Tester	Narda	ELT-400	0-0344	N/A	Nov. 16, 2023	Nov. 15, 2024
9	Wideband Radio Communication Test	R&S	CMW500	106504	V 3.7.22	Nov. 02, 2023	Nov. 01, 2024
10	MWRF Power Meter Test system	MW	MW100-RF CB	N/A	N/A	Nov. 02, 2023	Nov. 01, 2024
11	D.C. Power Supply	LongWei	TPR-6405D	N/A	N/A	\	\
12	RF Software	MW	MTS8310	V2.0.0.0	N/A	\	\



#### 4. CONDUCTED EMISSION TEST

##### 4.1 CONDUCTED EMISSION MEASUREMENT

Test Requirement:	FCC Part15 C Section 15.207
Test Method:	ANSI C63.10:2013
Test Frequency Range:	150KHz to 30MHz
Receiver setup:	RBW=9KHz, VBW=30KHz, Sweep time=auto

##### 4.1.1 POWER LINE CONDUCTED EMISSION Limits

FREQUENCY (MHz)	Limit (dBuV)		Standard
	Quas-peak	Average	
0.15 -0.5	66 - 56 *	56 - 46 *	FCC
0.50 -5.0	56.00	46.00	FCC
5.0 -30.0	60.00	50.00	FCC

Note:

(1) \*Decreases with the logarithm of the frequency.

##### 4.1.2 TEST PROCEDURE

- a. The EUT was placed 0.8 meters from the horizontal ground plane with EUT being connected to the power mains through a line impedance stabilization network (LISN). All other support equipments powered from additional LISN(s). The LISN provide 50 Ohm/ 50uH of coupling impedance for the measuring instrument.
- b. Interconnecting cables that hang closer than 40 cm to the ground plane shall be folded back and forth in the center forming a bundle 30 to 40 cm long.
- c. I/O cables that are not connected to a peripheral shall be bundled in the center. The end of the cable may be terminated, if required, using the correct terminating impedance. The overall length shall not exceed 1 m.
- d. LISN at least 80 cm from nearest part of EUT chassis.
- e. For the actual test configuration, please refer to the related Item –EUT Test Photos.

##### 4.1.3 DEVIATION FROM TEST STANDARD

No deviation



#### 4.1.4 TEST SETUP

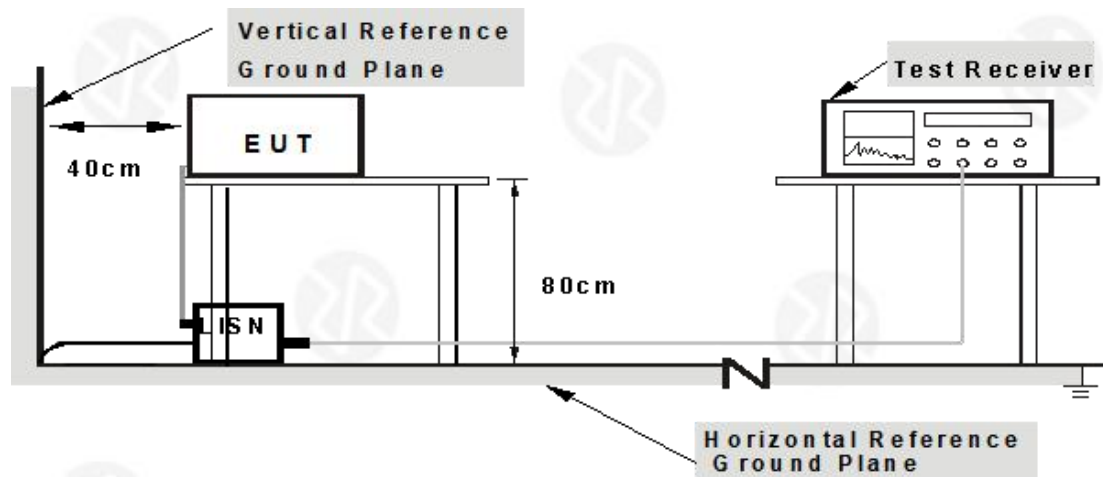

- Note:**
- 1.Support units were connected to second LISN.
  - 2.Both of LISNs (AMN) are 80 cm from EUT and at least 80 from other units and other metal planes

#### 4.1.5 EUT OPERATING CONDITIONS

The EUT was configured for testing in a typical fashion (as a customer would normally use it). The EUT has been programmed to continuously transmit during test. This operating condition was tested and used to collect the included data.





4.1.6 Test Result

Temperature:	26°C	Relative Humidity:	54%
Pressure:	101kPa	Phase :	L
Test Voltage :	AC 120V/60Hz	Test Mode:	Mode 1

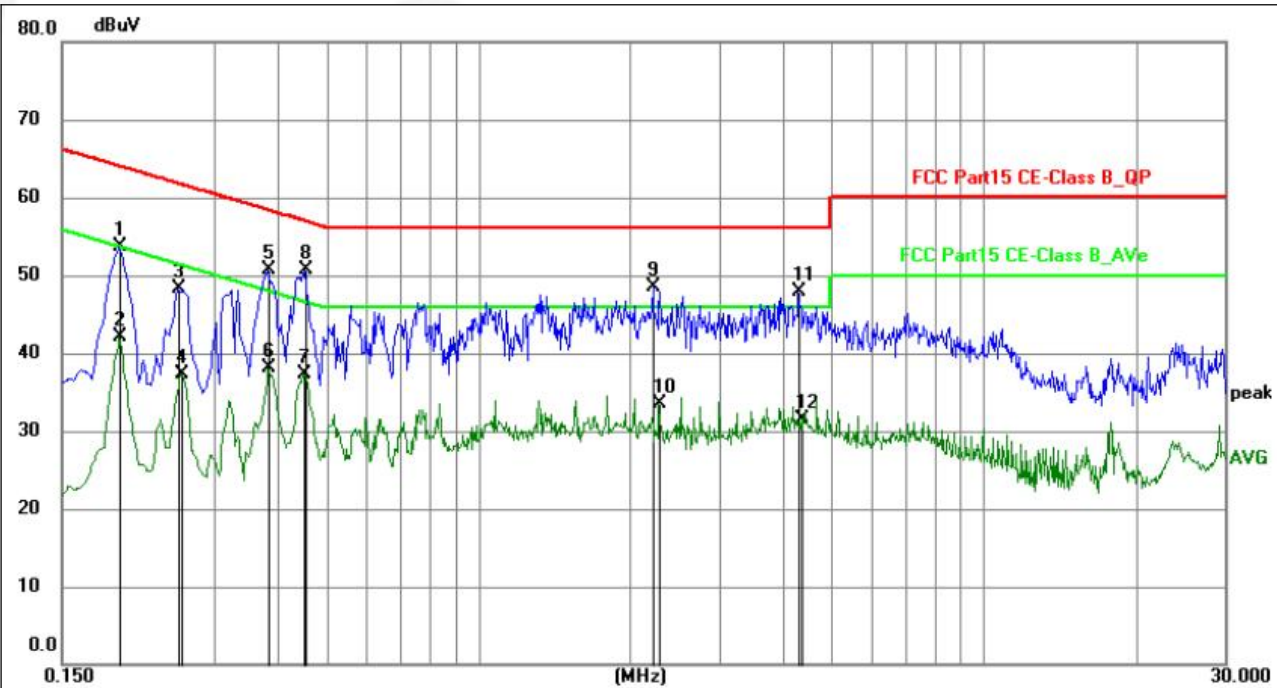

No.	Frequency (MHz)	Reading (dBuV)	Factor (dB)	Level (dBuV)	Limit (dBuV)	Margin (dB)	Detector	P/F	Remark
1	0.1949	32.66	21.02	53.68	63.83	-10.15	QP	P	
2	0.1949	21.12	21.02	42.14	53.83	-11.69	AVG	P	
3	0.2535	27.32	21.01	48.33	61.64	-13.31	QP	P	
4	0.2580	16.34	21.01	37.35	51.50	-14.15	AVG	P	
5	0.3840	29.77	20.97	50.74	58.19	-7.45	QP	P	
6	0.3840	17.07	20.97	38.04	48.19	-10.15	AVG	P	
7	0.4515	16.43	20.89	37.32	46.85	-9.53	AVG	P	
8	0.4560	29.79	20.89	50.68	56.77	-6.09	QP	P	
9	2.2154	27.45	21.03	48.48	56.00	-7.52	QP	P	
10	2.2829	12.43	21.04	33.47	46.00	-12.53	AVG	P	
11	4.2990	26.89	21.11	48.00	56.00	-8.00	QP	P	
12	4.3755	10.42	21.12	31.54	46.00	-14.46	AVG	P	

Notes:

1. An initial pre-scan was performed on the line and neutral lines with peak detector.
2. Quasi - Peak and Average measurement were performed at the frequencies with maximized peak emission.
3. Final Level = Reading level + Correct Factor.
4. Correct Factor = Lisn factor+ Cable loss factor + limiter factor.
5. Margin = Measurement Level-Limit.
6. All test modes were tested, with only the worst Mode 1 recorded.



Temperature:	26°C	Relative Humidity:	54%
Pressure:	101kPa	Phase :	N
Test Voltage :	AC 120V/60Hz	Test Mode:	Mode 1

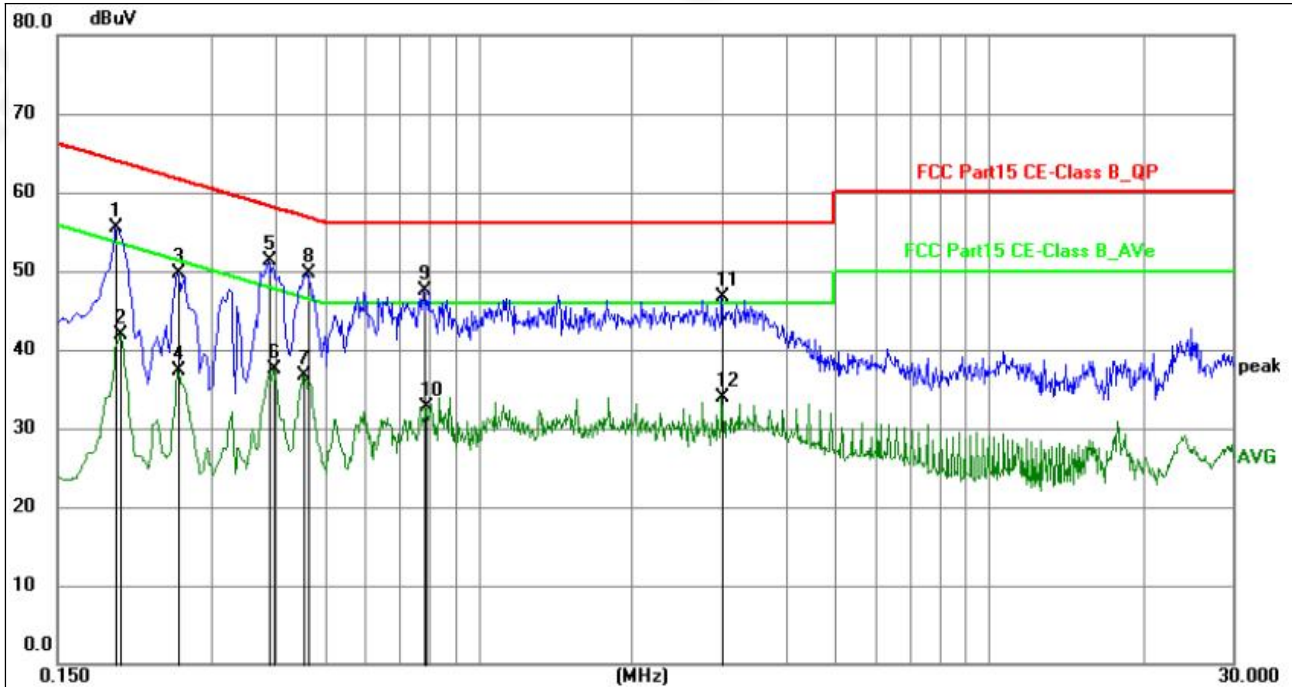

No.	Frequency (MHz)	Reading (dBuV)	Factor (dB)	Level (dBuV)	Limit (dBuV)	Margin (dB)	Detector	P/F	Remark
1	0.1949	34.54	20.99	55.53	63.83	-8.30	QP	P	
2	0.1995	21.00	21.00	42.00	53.63	-11.63	AVG	P	
3	0.2580	28.80	20.98	49.78	61.50	-11.72	QP	P	
4	0.2580	16.30	20.98	37.28	51.50	-14.22	AVG	P	
5	0.3885	30.41	20.93	51.34	58.10	-6.76	QP	P	
6	0.3975	16.54	20.92	37.46	47.91	-10.45	AVG	P	
7	0.4560	15.81	20.88	36.69	46.77	-10.08	AVG	P	
8	0.4650	28.76	20.88	49.64	56.60	-6.96	QP	P	
9	0.7799	26.55	20.90	47.45	56.00	-8.55	QP	P	
10	0.7889	11.88	20.90	32.78	46.00	-13.22	AVG	P	
11	3.0030	25.60	21.08	46.68	56.00	-9.32	QP	P	
12	3.0030	12.81	21.08	33.89	46.00	-12.11	AVG	P	

Notes:

1. An initial pre-scan was performed on the line and neutral lines with peak detector.
2. Quasi - Peak and Average measurement were performed at the frequencies with maximized peak emission.
3. Final Level = Reading level + Correct Factor.
4. Correct Factor = Lisen factor+ Cable loss factor + limiter factor.
5. Margin = Measurement Level-Limit.
6. All test modes were tested, with only the worst Mode 1 recorded.





### 5. RADIATED EMISSION MEASUREMENT

Test Requirement:	FCC Part15 C Section 15.209				
Test Method:	ANSI C63.10:2013				
Test Frequency Range:	9kHz to 1GHz				
Test site:	Measurement Distance: 3m				
Receiver setup:	Frequency	Detector	RBW	VBW	Value
	9KHz-150KHz	Quasi-peak	200Hz	600Hz	Quasi-peak
	150KHz-30MHz	Quasi-peak	9KHz	30KHz	Quasi-peak
	30MHz-1GHz	Quasi-peak	100KHz	300KHz	Quasi-peak
	Above 1GHz	Peak	1MHz	3MHz	Peak
		Peak	1MHz	10Hz	Average

#### 5.1 Radiated Emission Limits

##### Limits for frequency below 30MHz

Frequency	Limit (uV/m)	Measurement Distance(m)	Remark
0.009-0.490	2400/F(kHz)	300	Quasi-peak Value
0.490-1.705	24000/F(kHz)	30	Quasi-peak Value
1.705-30	30	30	Quasi-peak Value

##### Limits for frequency Above 30MHz

Frequency	Limit (dBuV/m @3m)	Remark
30MHz-88MHz	40.00	Quasi-peak Value
88MHz-216MHz	43.50	Quasi-peak Value
216MHz-960MHz	46.00	Quasi-peak Value
960MHz-1GHz	54.00	Quasi-peak Value
Above 1GHz	54.00	Average Value
	74.00	Peak Value



## 5.2 Anechoic Chamber Test Setup Diagram

(A) Radiated Emission Test-Up Frequency Below 30MHz

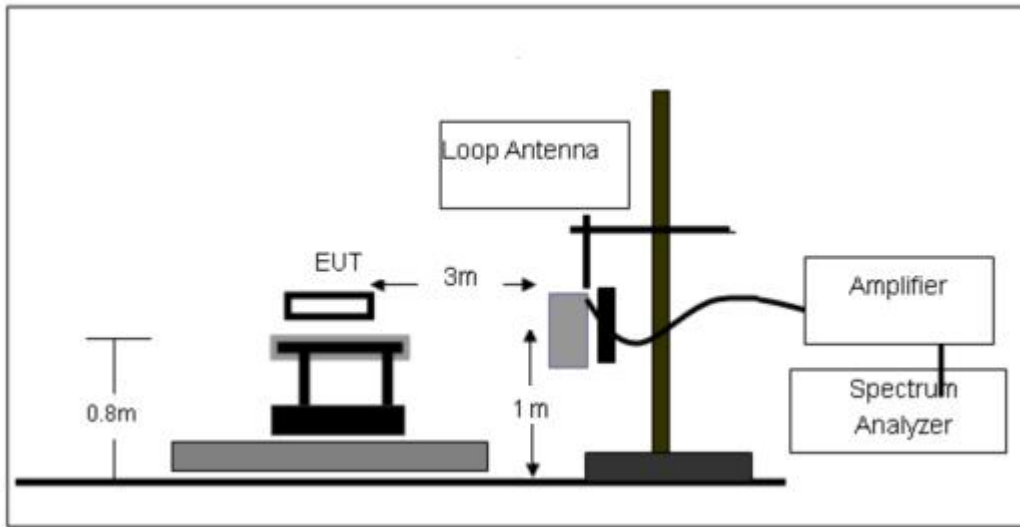

(B) Radiated Emission Test-Up Frequency 30MHz~1GHz

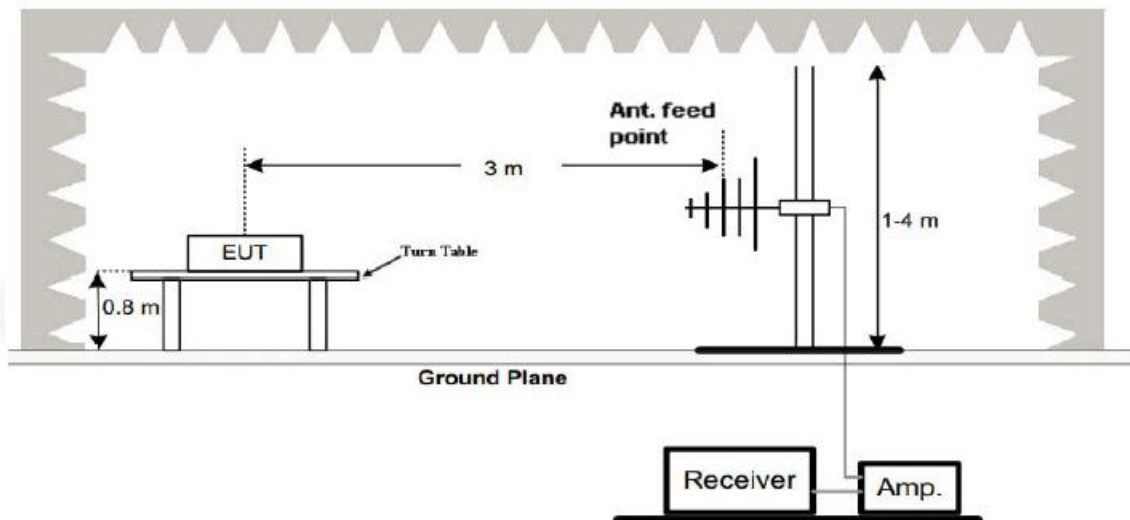

The radiated emission tests were performed in the 3 meters chamber test site, using the setup accordance with the ANSI C63.10-2013. The specification used was the FCC 15.209 and FCC 15.205 limits.

## 5.3 Test Procedure

The EUT is placed on a turn table which is 0.8 meter above ground. The turn table can rotate 360 degrees to determine the position of the maximum emission level. The EUT is set 3 meters away from the receiving antenna which is mounted on a antenna tower. The antenna can move up and down between 1 to 4 meters to find out the maximum emission level. Broadband antenna (calibrated by dipole antenna) are used as a receiving antenna. Both horizontal and vertical polarization of the antenna are set on measurement.

## 5.4 DEVIATION FROM TEST STANDARD

No deviation



5.5 Test Result

Measurement data:

Note: Limit dBuV/m @3m = Limit dBuV/m @300m+ 80  
Limit dBuV/m @3m = Limit dBuV/m @30m + 40

A: 9 kHz~30 MHz

Temperature:	26°C	Relative Humidity:	54%
Pressure:	101 kPa	Polarization:	coaxial
Test Voltage:	DC 20V	Test Mode:	Mode 1

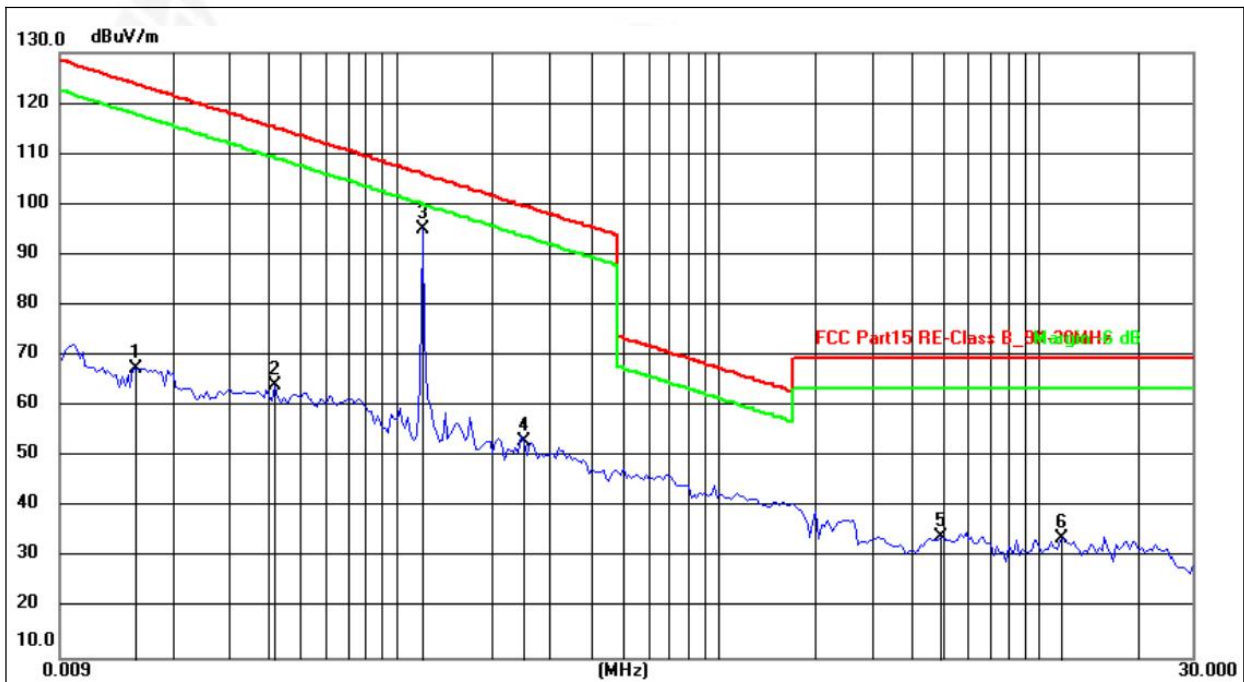

No.	Frequency (MHz)	Reading (dBuV)	Factor (dB/m)	Level (dBuV/m)	Limit (dBuV/m)	Margin (dB)	Detector
1	0.0154	47.07	20.50	67.57	123.85	-56.28	peak
2	0.0420	44.33	19.94	64.27	115.14	-50.87	peak
3	0.1200	75.04	19.88	94.92	106.02	-11.10	peak
4	0.2503	33.04	20.10	53.14	99.63	-46.49	peak
5	4.9348	14.59	19.47	34.06	69.54	-35.48	peak
6	11.8025	14.82	18.98	33.80	69.54	-35.74	peak

Remarks:

- 1.An initial pre-scan was performed on the line and neutral lines with peak detector.
- 2.Quasi - Peak and Average measurement were performed at the frequencies with maximized peak emission.
- 3.Final Level = Reading level + Correct Factor.
- 4.Correct Factor = Lisen factor + Cable loss factor + limiter factor.
- 5.Margin = Measurement Level - Limit.



B: 30MHz-1GHz

Temperature:	26°C	Relative Humidity:	54%
Pressure:	101 kPa	Polarization:	Horizontal
Test Voltage:	DC 20V	Test Mode:	Mode 1

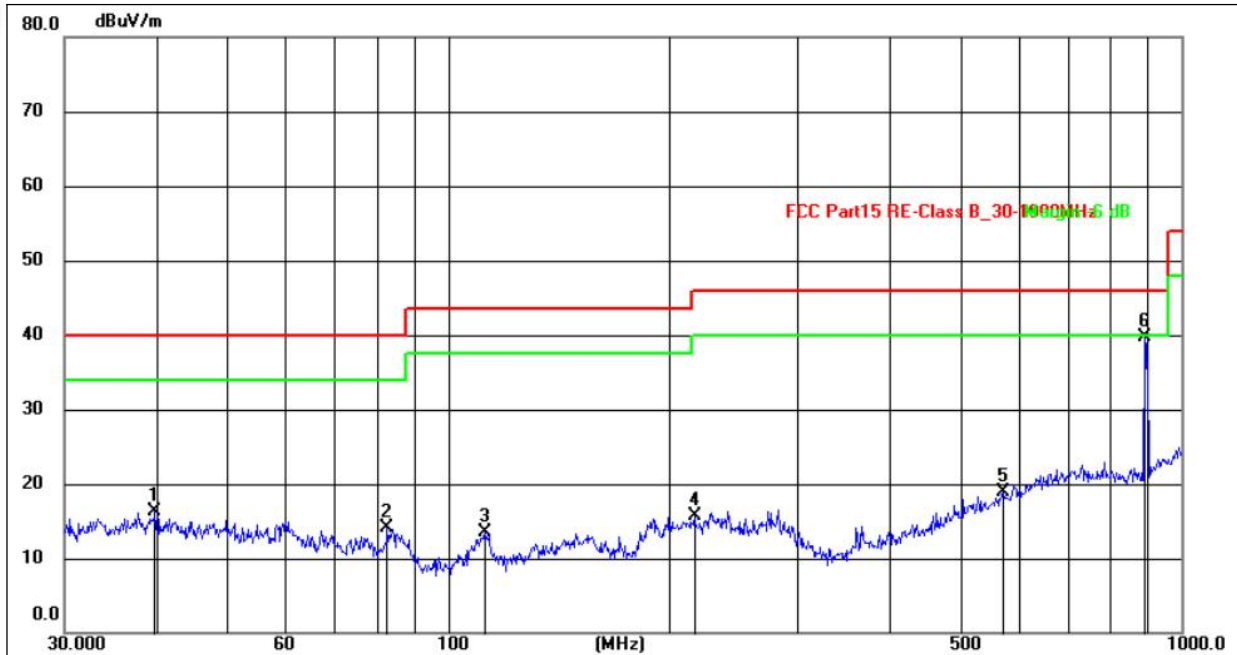

No.	Frequency (MHz)	Reading (dBuV)	Factor (dB/m)	Level (dBuV/m)	Limit (dBuV/m)	Margin (dB)	Detector
1	39.8542	30.50	-14.17	16.33	40.00	-23.67	QP
2	82.6481	33.77	-19.66	14.11	40.00	-25.89	QP
3	112.1304	32.61	-19.07	13.54	43.50	-29.96	QP
4	216.7828	33.67	-17.95	15.72	46.00	-30.28	QP
5	570.6100	28.60	-9.64	18.96	46.00	-27.04	QP
6	890.7277	46.74	-6.98	39.76	46.00	-6.24	QP

Remarks:

- 1.An initial pre-scan was performed on the line and neutral lines with peak detector.
- 2.Quasi - Peak and Average measurement were performed at the frequencies with maximized peak emission.
- 3.Final Level = Reading level + Correct Factor.
- 4.Correct Factor = Lisen factor + Cable loss factor + limiter factor.
- 5.Margin = Measurement Level - Limit.
- 6.All test modes were tested, with only the worst Mode 1 recorded.





Temperature:	26°C	Relative Humidity:	54%
Pressure:	101kPa	Polarization:	Vertical
Test Voltage:	DC 20V	Test Mode:	Mode 1

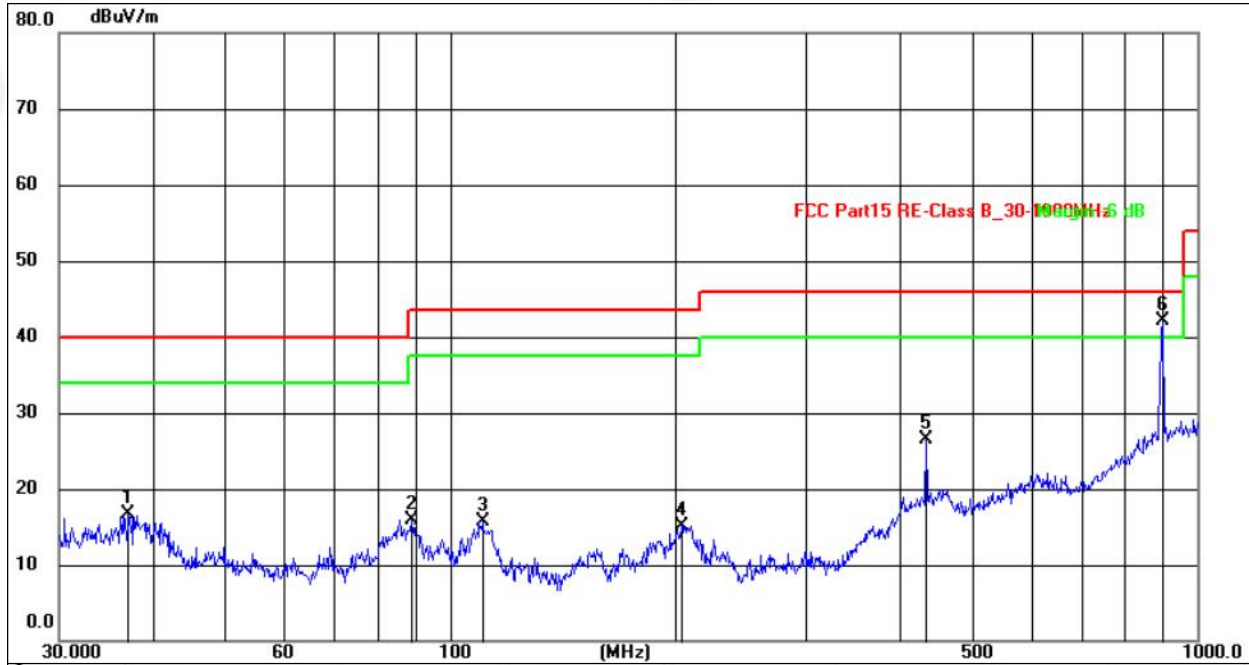

No.	Frequency (MHz)	Reading (dBuV)	Factor (dB/m)	Level (dBuV/m)	Limit (dBuV/m)	Margin (dB)	Detector
1	37.1549	34.08	-17.29	16.79	40.00	-23.21	QP
2	88.9637	37.50	-21.54	15.96	43.50	-27.54	QP
3	110.5686	37.02	-21.30	15.72	43.50	-27.78	QP
4	204.2377	35.70	-20.63	15.07	43.50	-28.43	QP
5	434.0650	40.32	-13.85	26.47	46.00	-19.53	QP
6	900.1474	42.90	-0.74	42.16	46.00	-3.84	QP

Remarks:

1. An initial pre-scan was performed on the line and neutral lines with peak detector.
2. Quasi - Peak and Average measurement were performed at the frequencies with maximized peak emission.
3. Final Level = Reading level + Correct Factor.
4. Correct Factor = Lisen factor + Cable loss factor + limiter factor.
5. Margin = Measurement Level - Limit.
6. All test modes were tested, with only the worst Mode 1 recorded.



B: 9 kHz~30 MHz

Temperature:	26°C	Relative Humidity:	54%
Pressure:	101 kPa	Polarization:	coaxial
Test Voltage:	DC 3.85V	Test Mode:	Mode 1a

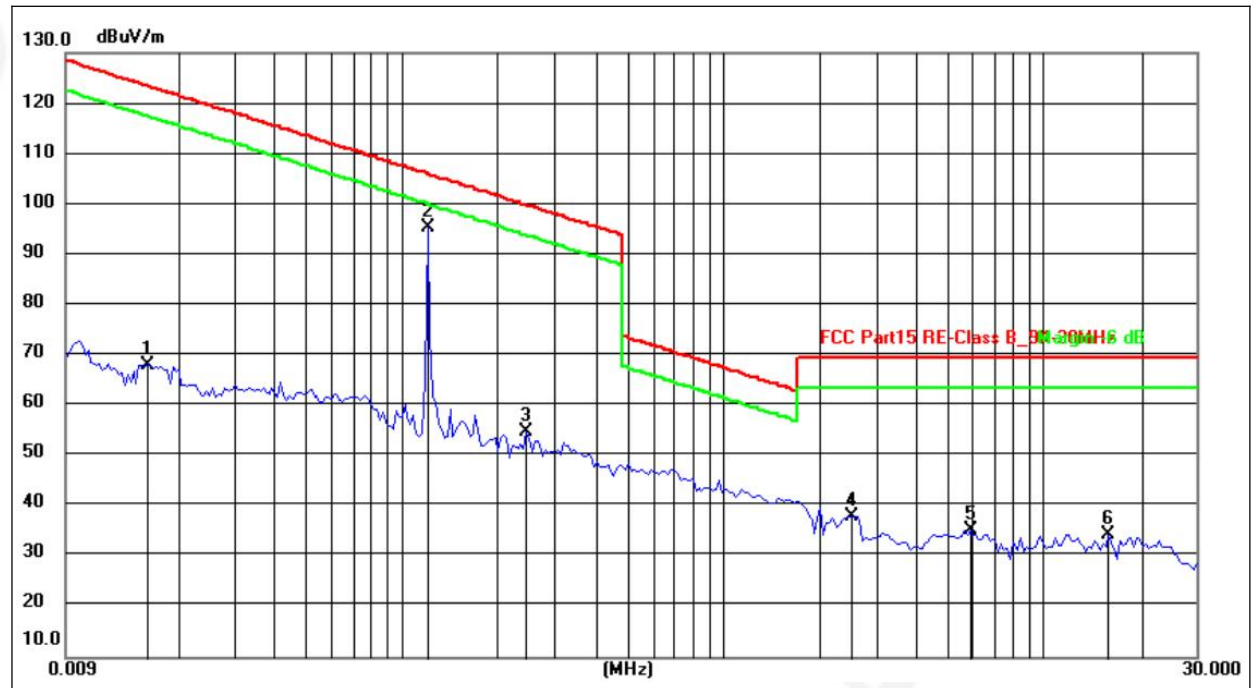

No.	Frequency (MHz)	Reading (dBuV)	Factor (dB/m)	Level (dBuV/m)	Limit (dBuV/m)	Margin (dB)	Detector
1	0.0160	47.57	20.49	68.06	123.52	-55.46	peak
2	0.1200	75.54	19.88	95.42	106.02	-10.60	peak
3	0.2452	34.70	20.10	54.80	99.81	-45.01	peak
4	2.5272	18.30	19.72	38.02	69.54	-31.52	peak
5	5.9230	16.05	19.38	35.43	69.54	-34.11	peak
6	15.9991	15.70	18.82	34.52	69.54	-35.02	peak

Remarks:

- 1.An initial pre-scan was performed on the line and neutral lines with peak detector.
- 2.Quasi - Peak and Average measurement were performed at the frequencies with maximized peak emission.
- 3.Final Level = Reading level + Correct Factor.
- 4.Correct Factor = Lisn factor + Cable loss factor + limiter factor.
- 5.Margin = Measurement Level - Limit.



B: 30MHz-1GHz

Temperature:	26°C	Relative Humidity:	54%
Pressure:	101 kPa	Polarization:	Horizontal
Test Voltage:	DC 3.85V	Test Mode:	Mode 1a

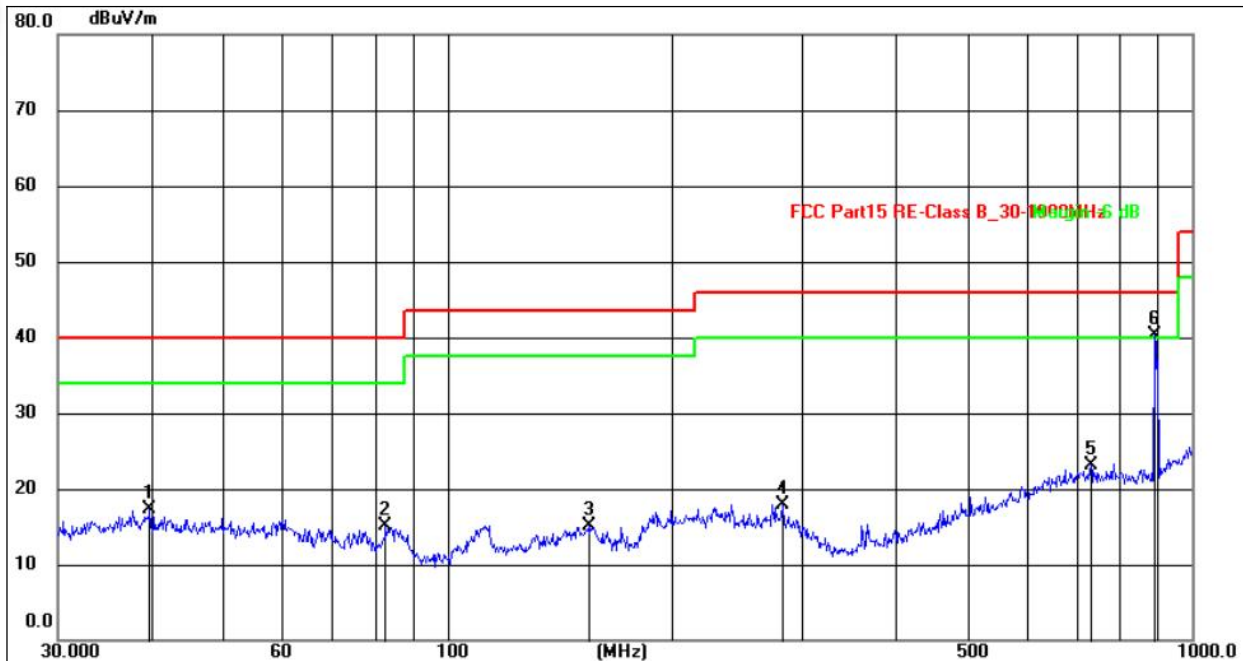

No.	Frequency (MHz)	Reading (dBuV)	Factor (dB/m)	Level (dBuV/m)	Limit (dBuV/m)	Margin (dB)	Detector
1	39.8541	31.50	-14.17	17.33	40.00	-22.67	QP
2	82.6478	34.77	-19.66	15.11	40.00	-24.89	QP
3	154.8204	31.48	-16.37	15.11	43.50	-28.39	QP
4	281.9945	32.51	-14.60	17.91	46.00	-28.09	QP
5	731.9202	29.82	-6.78	23.04	46.00	-22.96	QP
6	890.7277	47.24	-6.98	40.26	46.00	-5.74	QP

Remarks:

1. An initial pre-scan was performed on the line and neutral lines with peak detector.
2. Quasi - Peak and Average measurement were performed at the frequencies with maximized peak emission.
3. Final Level = Reading level + Correct Factor.
4. Correct Factor = Lisen factor + Cable loss factor + limiter factor.
5. Margin = Measurement Level - Limit.
6. All test modes were tested, with only the worst Mode 1a recorded.





Temperature:	26°C	Relative Humidity:	54%
Pressure:	101kPa	Polarization:	Vertical
Test Voltage:	DC 3.85V	Test Mode:	Mode 1a

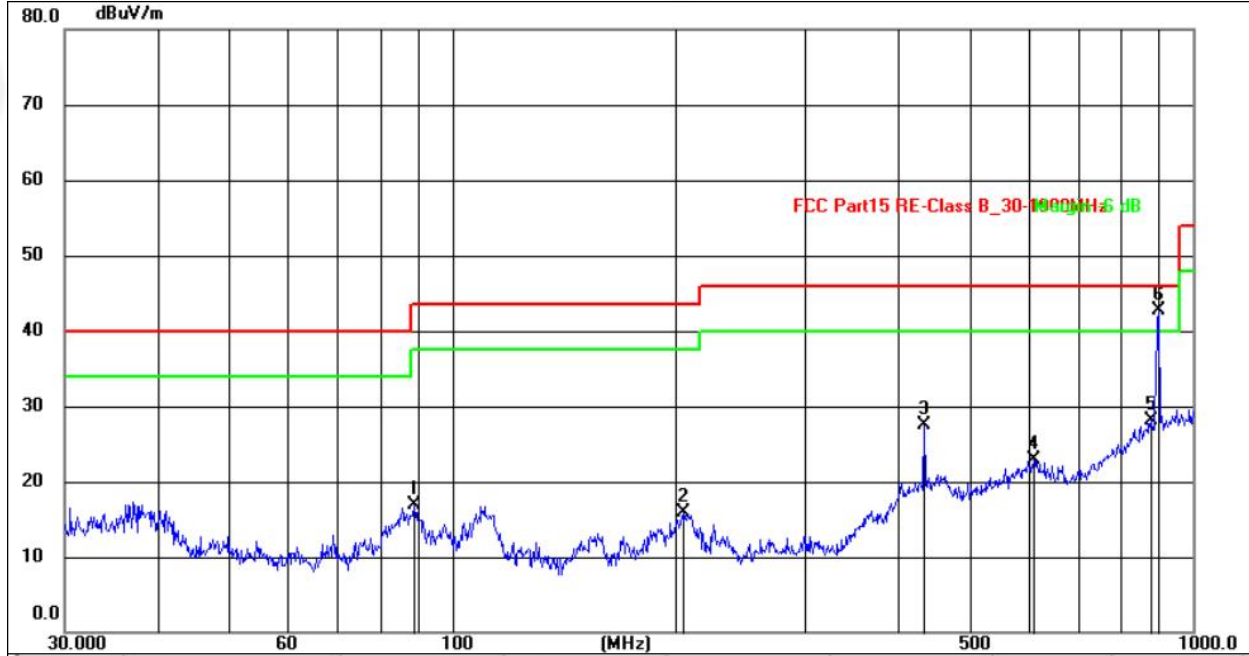

No.	Frequency (MHz)	Reading (dBuV)	Factor (dB/m)	Level (dBuV/m)	Limit (dBuV/m)	Margin (dB)	Detector
1	88.9637	38.50	-21.54	16.96	43.50	-26.54	QP
2	205.6750	36.49	-20.61	15.88	43.50	-27.62	QP
3	434.0649	41.32	-13.85	27.47	46.00	-18.53	QP
4	609.9215	30.70	-7.75	22.95	46.00	-23.05	QP
5	878.3214	29.40	-1.35	28.05	46.00	-17.95	QP
6	900.1472	43.40	-0.74	42.66	46.00	-3.34	QP

Remarks:

- 1.An initial pre-scan was performed on the line and neutral lines with peak detector.
- 2.Quasi - Peak and Average measurement were performed at the frequencies with maximized peak emission.
- 3.Final Level = Reading level + Correct Factor.
- 4.Correct Factor = Lism factor + Cable loss factor + limiter factor.
- 5.Margin = Measurement Level - Limit.
- 6.All test modes were tested, with only the worst Mode 1a recorded.





## 6. 20DB BANDWIDTH TEST

1. Se span = 1.5 ~ 5 times OBW.
2. Set RBW = 1%~5% OBW.
3. Set the video bandwidth (VBW)  $\geq 3 \times$  RBW.
4. Detector = peak.
5. Trace mode = max hold.
6. Sweep = auto couple.
7. Allow the trace to stabilize.
8. Measure the maximum width of the emission that is constrained by the frequencies associated with the two outermost amplitude points (upper and lower frequencies) that are attenuated by 20 dB relative to the maximum level measured in the fundamental emission.

### TEST SETUP





Temperature:	26 °C	Relative Humidity:	54%
Pressure:	101kPa	Test Voltage:	DC 20V

Test Coil	Frequency (kHz)	20dB Bandwidth (kHz)	Result
ANT 1	120.00	2.710	Pass

ANT 1:





## 7. ANTENNA REQUIREMENT

Standard requirement:	FCC Part15 C Section 15.203
15.203 requirement:	An intentional radiator shall be designed to ensure that no antenna other than that furnished by the responsible party shall be used with the device. The use of a permanently attached antenna or of an antenna that uses a unique coupling to the intentional radiator, the manufacturer may design the unit so that a broken antenna can be replaced by the user, but the use of a standard antenna jack or electrical connector is prohibited.
EUT Antenna:	
	The antenna is Loop Coil antenna, the best case gain of the antennas is 0dBi, reference to the appendix II for details.



## 8. TEST SETUP PHOTO

Reference to the appendix I for details.

## 9. EUT CONSTRUCTIONAL DETAILS

Reference to the appendix II for details.

\*\*\*\*\* END OF REPORT \*\*\*\*\*