

FCC Test Report

Report No.: RF151111C28

FCC ID: SXE-JAO1801

Test Model: JAO18

Received Date: Nov. 11, 2015

Test Date: Nov. 14, 2015 ~ Nov. 21, 2015

Issued Date: Dec. 16, 2015

Applicant: Barco N.V

Address: President Kennedypark 35, Kortrijk 8500, Belgium

Issued By: Bureau Veritas Consumer Products Services (H.K.) Ltd., Taoyuan Branch

Lab Address: No. 47-2, 14th Ling, Chia Pau Vil., Lin Kou Dist., New Taipei City, Taiwan
(R.O.C)

Test Location (1): No.19, Hwa Ya 2nd Rd., Wen Hwa Vil., Kwei Shan Dist., Taoyuan City
33383, Taiwan, R.O.C.

Test Location (2): No.215, Sec. 3, Beixin Rd., Xindian Dist., New Taipei City 231, Taiwan,
R.O.C



This report is for your exclusive use. Any copying or replication of this report to or for any other person or entity, or use of our name or trademark, is permitted only with our prior written permission. This report sets forth our findings solely with respect to the test samples identified herein. The results set forth in this report are not indicative or representative of the quality or characteristics of the lot from which a test sample was taken or any similar or identical product unless specifically and expressly noted. Our report includes all of the tests requested by you and the results thereof based upon the information that you provided to us. You have 60 days from date of issuance of this report to notify us of any material error or omission caused by our negligence, provided, however, that such notice shall be in writing and shall specifically address the issue you wish to raise. A failure to raise such issue within the prescribed time shall constitute your unqualified acceptance of the completeness of this report, the tests conducted and the correctness of the report contents. Unless specific mention, the uncertainty of measurement has been explicitly taken into account to declare the compliance or non-compliance to the specification.

Table of Contents

Release Control Record	4
1 Certificate of Conformity	5
2 Summary of Test Results	6
2.1 Measurement Uncertainty	6
2.2 Modification Record	6
3 General Information	7
3.1 General Description of EUT	7
3.2 Description of Test Modes	8
3.2.1 Test Mode Applicability and Tested Channel Detail	9
3.3 Duty Cycle of Test Signal	11
3.4 Description of Support Units	12
3.4.1 Configuration of System under Test	12
3.5 General Description of Applied Standards	12
4 Test Types and Results	13
4.1 Radiated Emission and Bandedge Measurement	13
4.1.1 Limits of Radiated Emission and Bandedge Measurement	13
4.1.2 Test Instruments	14
4.1.3 Test Procedures	15
4.1.4 Deviation from Test Standard	15
4.1.5 Test Set Up	16
4.1.6 EUT Operating Conditions	16
4.1.7 Test Results	17
4.2 Conducted Emission Measurement	30
4.2.1 Limits of Conducted Emission Measurement	30
4.2.2 Test Instruments	30
4.2.3 Test Procedures	31
4.2.4 Deviation from Test Standard	31
4.2.5 Test Setup	31
4.2.6 EUT Operating Conditions	31
4.2.7 Test Results	32
4.3 6 dB Bandwidth Measurement	34
4.3.1 Limits of 6 dB Bandwidth Measurement	34
4.3.2 Test Setup	34
4.3.3 Test Instruments	34
4.3.4 Test Procedure	34
4.3.5 Deviation from Test Standard	34
4.3.6 EUT Operating Conditions	34
4.3.7 Test Result	35
4.4 Conducted Output Power Measurement	37
4.4.1 Limits of Conducted Output Power Measurement	37
4.4.2 Test Setup	37
4.4.3 Test Instruments	37
4.4.4 Test Procedures	37
4.4.5 Deviation from Test Standard	37
4.4.6 EUT Operating Conditions	37
4.4.7 Test Results	38
4.5 Power Spectral Density Measurement	39
4.5.1 Limits of Power Spectral Density Measurement	39
4.5.2 Test Setup	39
4.5.3 Test Instruments	39
4.5.4 Test Procedure	39
4.5.5 Deviation from Test Standard	39
4.5.6 EUT Operating Condition	39



4.5.7 Test Results	40
4.6 Conducted Out of Band Emission Measurement	42
4.6.1 Limits of Conducted Out of Band Emission Measurement.....	42
4.6.2 Test Setup.....	42
4.6.3 Test Instruments	42
4.6.4 Test Procedure	42
4.6.5 Deviation from Test Standard	42
4.6.6 EUT Operating Condition	42
4.6.7 Test Results	43
5 Pictures of Test Arrangements.....	51
Appendix – Information on the Testing Laboratories	52



Release Control Record

Issue No.	Description	Date Issued
RF151111C28	Original Release	Dec. 16, 2015



1 Certificate of Conformity

Product: Panel PC
Brand: Barco
Test Model: JAO18
Sample Status: Identical Prototype
Applicant: Barco N.V
Test Date: Nov. 14, 2015 ~ Nov. 21, 2015
Standards: 47 CFR FCC Part 15, Subpart C (Section 15.247)
ANSI C63.10:2013

The above equipment has been tested by **Bureau Veritas Consumer Products Services (H.K.) Ltd., Taoyuan Branch**, and found compliance with the requirement of the above standards. The test record, data evaluation & Equipment Under Test (EUT) configurations represented herein are true and accurate accounts of the measurements of the sample's EMC characteristics under the conditions specified in this report.

Prepared by : Rona Chen , **Date:** Dec. 16, 2015
Rona Chen / Specialist

Approved by : Stanley Wu , **Date:** Dec. 16, 2015
Stanley Wu / Assistant Manager

2 Summary of Test Results

47 CFR FCC Part 15, Subpart C (Section 15.247)			
FCC Clause	Test Item	Result	Remarks
15.207	AC Power Conducted Emission	Pass	Meet the requirement of limit. Minimum passing margin is -18.99 dB at 0.36505 MHz.
15.205 / 15.209 / 15.247(d)	Radiated Emissions and Band Edge Measurement	Pass	Meet the requirement of limit. Minimum passing margin is -1.02 dB at 2484 MHz.
15.247(d)	Antenna Port Emission	Pass	Meet the requirement of limit.
15.247(a)(2)	6 dB Bandwidth	Pass	Meet the requirement of limit.
15.247(b)	Conducted power	Pass	Meet the requirement of limit.
15.247(e)	Power Spectral Density	Pass	Meet the requirement of limit.
15.203	Antenna Requirement	Pass	No antenna connector is used.

2.1 Measurement Uncertainty

Where relevant, the following measurement uncertainty levels have been estimated for tests performed on the EUT:

The listed uncertainties are the worst case uncertainty for the entire range of measurement. Please note that the uncertainty values are provided for informational purposes only and are not used in determining the PASS/FAIL results.

Measurement	Frequency	Expanded Uncertainty (k=2) (\pm)
Conducted Emissions at mains ports	150 kHz ~ 30 MHz	2.44 dB
Radiated Emissions up to 1 GHz	30 MHz ~ 200 MHz	2.0153 dB
	200 MHz ~ 1000 MHz	2.0224 dB
Radiated Emissions above 1 GHz	1 GHz ~ 18 GHz	1.0121 dB
	18 GHz ~ 40 GHz	1.1508 dB

2.2 Modification Record

There were no modifications required for compliance.

3 General Information

3.1 General Description of EUT

Product	Panel PC
Brand	Barco
Test Model	JAO18
Status of EUT	Identical Prototype
Power Supply Rating	19 Vdc (adapter)
Modulation Type	CCK, DQPSK, DBPSK for DSSS 64QAM, 16QAM, QPSK, BPSK for OFDM
Modulation Technology	DSSS, OFDM
Transfer Rate	802.11b: 11.0 / 5.5 / 2.0 / 1.0 Mbps 802.11g: 54.0 / 48.0 / 36.0 / 24.0 / 18.0 / 12.0 / 9.0 / 6.0 Mbps 802.11n: up to MCS7
Operating Frequency	2412 ~ 2462 MHz
Number of Channel	11 for 802.11b, 802.11g, 802.11n (HT20) 7 for 802.11n (HT40)
Output Power	207.01 mW
Antenna Type	PCB antenna with 3.66 dBi gain
Antenna Connector	N/A
Accessory Device	Refer to Note as below
Data Cable Supplied	Refer to Note as below

Note:

- The EUT provides two completed 1 transmitter and 1 receiver.

Modulation Mode	TX Function
802.11b	1TX
802.11g	1TX
802.11n (HT20)	1TX
802.11n (HT40)	1TX

- The EUT contains following accessory devices.

Product	Brand	Model	Description
Adapter	DELTA ELECTRONICS, INC.	MDS-090AAS19 B	I/P: 100-240 Vac, 1.5 A O/P: 19 Vdc, 4.74 A

- The above EUT information is declared by manufacturer and for more detailed features description, please refer to the manufacturer's specifications or user's manual.

3.2 Description of Test Modes

11 channels are provided for 802.11b, 802.11g and 802.11n (HT20):

Channel	Frequency (MHz)	Channel	Frequency (MHz)
1	2412	7	2442
2	2417	8	2447
3	2422	9	2452
4	2427	10	2457
5	2432	11	2462
6	2437		

7 channels are provided for 802.11n (HT40):

Channel	Frequency (MHz)	Channel	Frequency (MHz)
3	2422	7	2442
4	2427	8	2447
5	2432	9	2452
6	2437		

3.2.1 Test Mode Applicability and Tested Channel Detail

EUT Configure Mode	Applicable To				Description
	RE \geq 1G	RE<1G	PLC	APCM	
-	√	√	√	√	-

Where **RE \geq 1G**: Radiated Emission above 1 GHz **RE<1G**: Radiated Emission below 1 GHz
PLC: Power Line Conducted Emission **APCM**: Antenna Port Conducted Measurement

NOTE: The EUT had been pre-tested on the positioned of each 3 axis. The worst case was found when positioned on **X-plane**.
NOTE: “-” means no effect.

Radiated Emission Test (Above 1 GHz):

- Pre-Scan has been conducted to determine the worst-case mode from all possible combinations between available modulations, data rates and antenna ports (if EUT with antenna diversity architecture).
- Following channel(s) was (were) selected for the final test as listed below.

EUT Configure Mode	Mode	Available Channel	Tested Channel	Modulation Technology	Modulation Type	Data Rate (Mbps)
-	802.11b	1 to 11	1, 6, 11	DSSS	DBPSK	1.0
-	802.11g	1 to 11	1, 6, 11	OFDM	BPSK	6.0
-	802.11n (HT20)	1 to 11	1, 6, 11	OFDM	BPSK	MCS0
-	802.11n (HT40)	3 to 9	3, 6, 9	OFDM	BPSK	MCS0

Radiated Emission Test (Below 1 GHz):

- Pre-Scan has been conducted to determine the worst-case mode from all possible combinations between available modulations, data rates and antenna ports (if EUT with antenna diversity architecture).
- Following channel(s) was (were) selected for the final test as listed below.

EUT Configure Mode	Mode	Available Channel	Tested Channel	Modulation Technology	Modulation Type	Data Rate (Mbps)
-	802.11g	1 to 11	11	OFDM	BPSK	6.0

Power Line Conducted Emission Test:

- Pre-Scan has been conducted to determine the worst-case mode from all possible combinations between available modulations, data rates and antenna ports (if EUT with antenna diversity architecture).
- Following channel(s) was (were) selected for the final test as listed below.

EUT Configure Mode	Mode	Available Channel	Tested Channel	Modulation Technology	Modulation Type	Data Rate (Mbps)
-	802.11g	1 to 11	11	OFDM	BPSK	6.0

Bandedge Measurement:

- Pre-Scan has been conducted to determine the worst-case mode from all possible combinations between available modulations, data rates and antenna ports (if EUT with antenna diversity architecture).
- Following channel(s) was (were) selected for the final test as listed below.

EUT Configure Mode	Mode	Available Channel	Tested Channel	Modulation Technology	Modulation Type	Data Rate (Mbps)
-	802.11b	1 to 11	1, 11	DSSS	DBPSK	1.0
-	802.11g	1 to 11	1, 11	OFDM	BPSK	6.0
-	802.11n (HT20)	1 to 11	1, 11	OFDM	BPSK	MCS0
-	802.11n (HT40)	3 to 9	3, 9	OFDM	BPSK	MCS0

Antenna Port Conducted Measurement:

- This item includes all test value of each mode, but only includes spectrum plot of worst value of each mode.
- Pre-Scan has been conducted to determine the worst-case mode from all possible combinations between available modulations, data rates and antenna ports (if EUT with antenna diversity architecture).
- Following channel(s) was (were) selected for the final test as listed below.

EUT Configure Mode	Mode	Available Channel	Tested Channel	Modulation Technology	Modulation Type	Data Rate (Mbps)
-	802.11b	1 to 11	1, 6, 11	DSSS	DBPSK	1.0
-	802.11g	1 to 11	1, 6, 11	OFDM	BPSK	6.0
-	802.11n (HT20)	1 to 11	1, 6, 11	OFDM	BPSK	MCS0
-	802.11n (HT40)	3 to 9	3, 6, 9	OFDM	BPSK	MCS0

Test Condition:

Applicable To	Environmental Conditions	Input Power	Tested by
RE≥1G	25 deg. C, 65 % RH	120 Vac, 60 Hz	Charles Hsiao
RE<1G	25 deg. C, 65 % RH	120 Vac, 60 Hz	Charles Hsiao
PLC	25 deg. C, 65 % RH	120 Vac, 60 Hz	Toby Tian
APCM	25 deg. C, 65 % RH	19 Vdc	Carlos Chen

3.3 Duty Cycle of Test Signal

802.11b: Duty cycle of test signal is 100 %, duty factor is not required.

802.11g: Duty cycle = $5.350/5.475 = 0.977$, Duty factor = $10 * \log(1/0.977) = 0.10$

802.11n (HT20): Duty cycle of test signal is > 98 %, duty factor is not required.

802.11n (HT40): Duty cycle = $2.358/2.458 = 0.959$, Duty factor = $10 * \log(1/0.959) = 0.18$

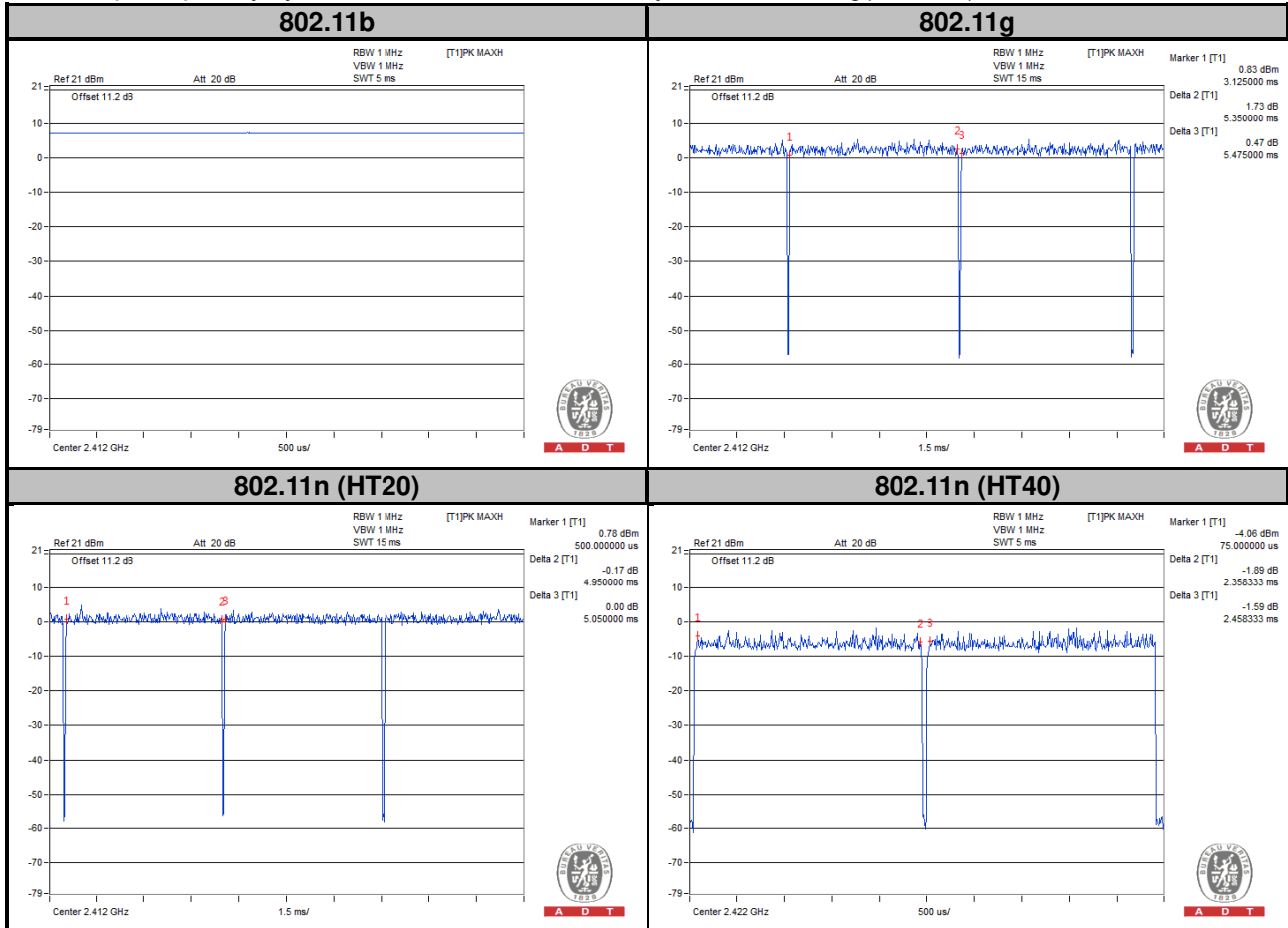

3.4 Description of Support Units

3.4.1 Configuration of System under Test

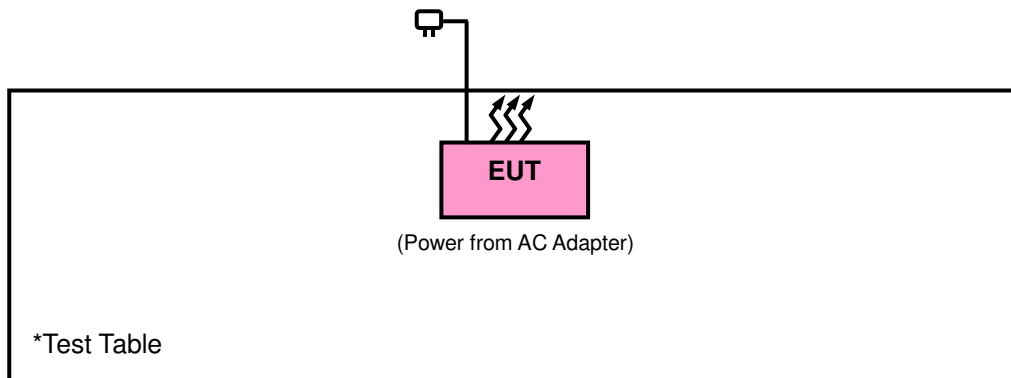

3.5 General Description of Applied Standards

The EUT is a RF Product. According to the specifications of the manufacturer, it must comply with the requirements of the following standards:

FCC Part 15, Subpart C (15.247)

558074 D01 DTS Meas Guidance v03r03

ANSI C63.10-2013

All test items have been performed and recorded as per the above standards.

NOTE: The EUT has been verified to comply with the requirements of FCC Part 15, Subpart B, Class B (DoC). The test report has been issued separately.

4 Test Types and Results

4.1 Radiated Emission and Bandedge Measurement

4.1.1 Limits of Radiated Emission and Bandedge Measurement

Radiated emissions which fall in the restricted bands must comply with the radiated emission limits specified as below table. Other emissions shall be at least 20 dB below the highest level of the desired power:

Frequencies (MHz)	Field Strength (microvolts/meter)	Measurement Distance (meters)
0.009 ~ 0.490	2400/F (kHz)	300
0.490 ~ 1.705	24000/F (kHz)	30
1.705 ~ 30.0	30	30
30 ~ 88	100	3
88 ~ 216	150	3
216 ~ 960	200	3
Above 960	500	3

NOTE:

1. The lower limit shall apply at the transition frequencies.
2. Emission level (dBuV/m) = 20 log Emission level (uV/m).
3. For frequencies above 1000 MHz, the field strength limits are based on average detector, however, the peak field strength of any emission shall not exceed the maximum permitted average limits, specified above by more than 20 dB under any condition of modulation.

4.1.2 Test Instruments

Description & Manufacturer	Model No.	Serial No.	Date of Calibration	Due Date of Calibration
Test Receiver Agilent Technologies	N9038A	MY52260177	May 19, 2015	May 18, 2016
Spectrum Analyzer ROHDE & SCHWARZ	FSU43	101261	Dec. 10, 2014	Dec. 09, 2015
BILOG Antenna SCHWARZBECK	VULB9168	9168-472	Feb. 04, 2015	Feb. 04, 2016
HORN Antenna SCHWARZBECK	BBHA 9170	9170-480	Feb. 04, 2015	Feb. 04, 2016
HORN Antenna ETS-Lindgren	3117	00143293	Jan. 05, 2015	Jan. 04, 2016
Bluetooth Tester	CBT	100980	Apr. 27, 2015	Apr. 26, 2017
Loop Antenna	EM-6879	269	Jul. 31, 2015	Jul. 30, 2016
Agilent Communications Tester-Wireless	8960 Series 10	MY53201073	Jul. 03, 2015	Jul. 02, 2017
Preamplifier Agilent	310N	187226	Jun. 29, 2015	Jun. 28, 2016
Preamplifier Agilent	83017A	MY39501357	Jun. 29, 2015	Jun. 28, 2016
Power Meter Anritsu	ML2495A	1232002	Sep. 21, 2015	Sep. 20, 2016
Power Sensor Anritsu	MA2411B	1207325	Sep. 21, 2015	Sep. 20, 2016
RF signal cable ETS-LINDGREN	5D-FB	Cable-CH1-01(R FC-SMS-100-SM S-120+RFC-SMS -100-SMS-400)	Jun. 27, 2015	Jun. 26, 2016
RF signal cable ETS-LINDGREN	8D-FB	Cable-CH1-02(R FC-SMS-100-SM S-24)	Jun. 27, 2015	Jun. 26, 2016
Software BV ADT	E3 8.130425b	NA	NA	NA
Antenna Tower MF	NA	NA	NA	NA
Turn Table MF	NA	NA	NA	NA
Antenna Tower & Turn Table Controller MF	MF-7802	NA	NA	NA

Note: 1. The calibration interval of the above test instruments is 12 months and the calibrations are traceable to NML/ROC and NIST/USA.

2. The test was performed in HsinTien Chamber 1.

3. The horn antenna and preamplifier (model: 83017A) are used only for the measurement of emission frequency above 1 GHz if tested.

4. The FCC Site Registration No. is 149147.

5. The IC Site Registration No. is IC7450I-1.

4.1.3 Test Procedures

- a. The EUT was placed on the top of a rotating table 0.8 meters (for below 1 GHz) / 1.5 meters (for above 1 GHz) above the ground at 3 meter chamber room for test. The table was rotated 360 degrees to determine the position of the highest radiation.
- b. The EUT was set 3 meters away from the interference-receiving antenna, which was mounted on the top of a variable-height antenna tower.
- c. The height of antenna is varied from one meter to four meters above the ground to determine the maximum value of the field strength. Both horizontal and vertical polarizations of the antenna are set to make the measurement.
- d. For each suspected emission, the EUT was arranged to its worst case and then the antenna was tuned to heights from 1 meter to 4 meters and the rotatable table was turned from 0 degrees to 360 degrees to find the maximum reading.
- e. The test-receiver system was set to quasi-peak detect function and specified bandwidth with maximum hold mode when the test frequency is below 1 GHz.
- f. The test-receiver system was set to peak and average detected function and specified bandwidth with maximum hold mode when the test frequency is above 1 GHz. If the peak reading value also meets average limit, measurement with the average detector is unnecessary.

Note:

1. The resolution bandwidth and video bandwidth of test receiver/spectrum analyzer is 120 kHz for Quasi-peak detection (QP) at frequency below 1 GHz.
2. The resolution bandwidth of test receiver/spectrum analyzer is 1 MHz and the video bandwidth is 3 MHz for Peak detection (PK) at frequency above 1 GHz.
3. The resolution bandwidth of test receiver/spectrum analyzer is 1 MHz and the video bandwidth is 3 MHz for RMS Average (Duty cycle < 98 %) for Average detection (AV) at frequency above 1 GHz, then the measurement results was added to a correction factor ($10 \log(1/\text{duty cycle})$).
4. The resolution bandwidth of test receiver/spectrum analyzer is 1MHz and the video bandwidth is 10 Hz (Duty cycle ≥ 98 %) for Average detection (AV) at frequency above 1 GHz.
5. All modes of operation were investigated and the worst-case emissions are reported.

4.1.4 Deviation from Test Standard

No deviation.

4.1.5 Test Set Up

<Frequency Range below 1 GHz>

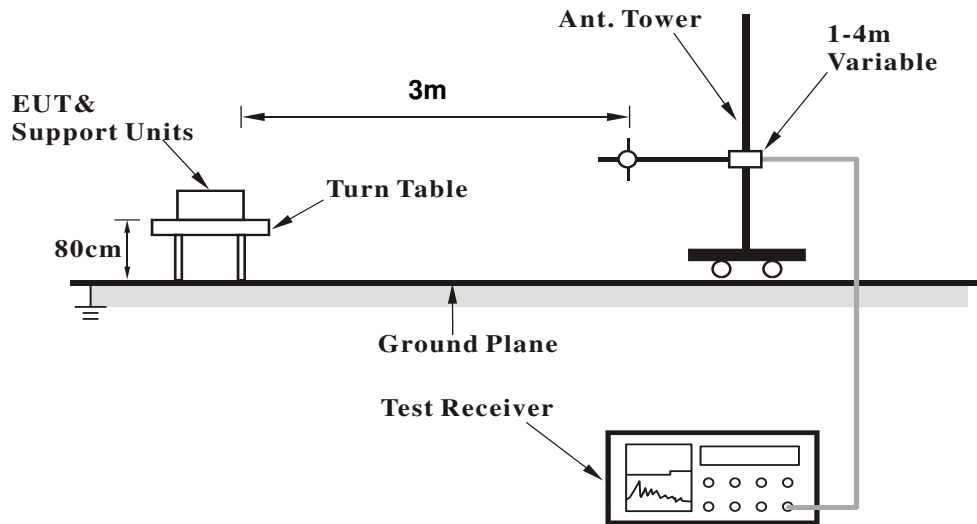

<Frequency Range above 1 GHz>

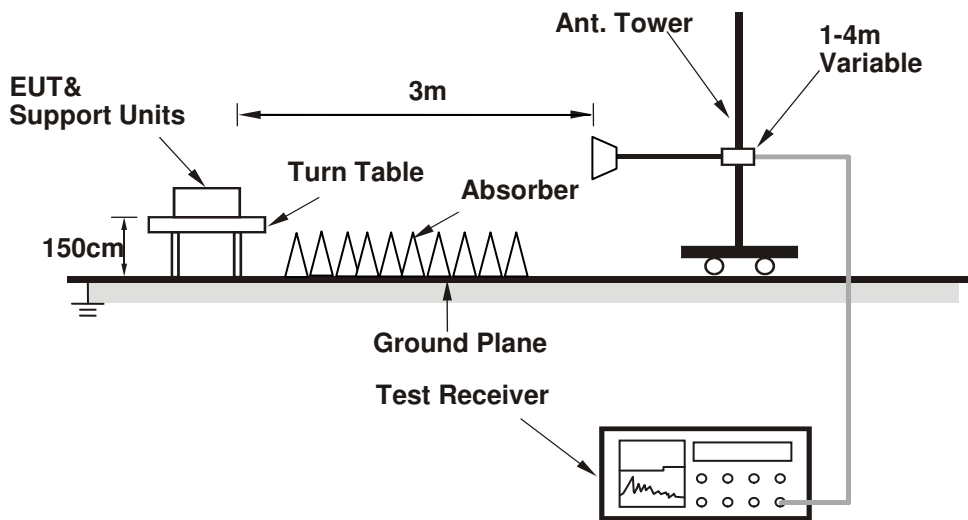

For the actual test configuration, please refer to the attached file (Test Setup Photo).

4.1.6 EUT Operating Conditions

- Placed the EUT on a testing table.
- Use the software to control the EUT under transmission condition continuously at specific channel frequency.

4.1.7 Test Results
Above 1 GHz Data :
802.11b

EUT TEST CONDITION		MEASUREMENT DETAIL	
CHANNEL	Channel 1	FREQUENCY RANGE	1 GHz ~ 25 GHz
INPUT POWER	120 Vac, 60 Hz	DETECTOR FUNCTION	Peak (PK) Average (AV)
ENVIRONMENTAL CONDITIONS	25 deg. C, 65 % RH	TESTED BY	Charles Hsiao

ANTENNA POLARITY & TEST DISTANCE: HORIZONTAL AT 3 M										
FREQ. (MHz)	EMISSION LEVEL (dBuV/m)	READ LEVEL (dBuV)	LIMIT (dBuV/m)	MARGIN (dB)	ANTENNA FACTOR (dB/m)	CABLE LOSS (dB)	PREAMP FACTOR (dB)	ANTENNA HEIGHT (cm)	TABLE ANGLE (Degree)	REMARK
2390	46.2	44.47	54	-7.8	31.8	5.4	35.47	113	268	Average
2390	58.26	56.53	74	-15.74	31.8	5.4	35.47	113	268	Peak
2412	108.85	107.08			31.81	5.43	35.47	113	268	Average
2412	111.56	109.79			31.81	5.43	35.47	113	268	Peak
2500	40.99	38.97	54	-13.01	31.9	5.53	35.41	113	268	Average
2500	55.75	53.73	74	-18.25	31.9	5.53	35.41	113	268	Peak
4824	52.93	44.8	54	-1.07	33.97	8.26	34.1	186	238	Average
4824	56.92	48.79	74	-17.08	33.97	8.26	34.1	186	238	Peak
ANTENNA POLARITY & TEST DISTANCE: VERTICAL AT 3 M										
FREQ. (MHz)	EMISSION LEVEL (dBuV/m)	READ LEVEL (dBuV)	LIMIT (dBuV/m)	MARGIN (dB)	ANTENNA FACTOR (dB/m)	CABLE LOSS (dB)	PREAMP FACTOR (dB)	ANTENNA HEIGHT (cm)	TABLE ANGLE (Degree)	REMARK
2362	44.13	42.5	54	-9.87	31.76	5.37	35.5	100	353	Average
2362	56.53	54.9	74	-17.47	31.76	5.37	35.5	100	353	Peak
2412	104.85	103.08			31.81	5.43	35.47	100	353	Average
2412	107.02	105.25			31.81	5.43	35.47	100	353	Peak
2496	40.53	38.51	54	-13.47	31.9	5.53	35.41	100	353	Average
2496	55.65	53.63	74	-18.35	31.9	5.53	35.41	100	353	Peak
4824	48.33	40.2	54	-5.67	33.97	8.26	34.1	101	177	Average
4824	53.25	45.12	74	-20.75	33.97	8.26	34.1	101	177	Peak

REMARKS:

- Emission Level = Read Level + Antenna Factor + Cable Loss - Preamp Factor
Margin value = Emission level – Limit value
- 2412 MHz: Fundamental frequency.



EUT TEST CONDITION		MEASUREMENT DETAIL	
CHANNEL	Channel 6	FREQUENCY RANGE	1 GHz ~ 25 GHz
INPUT POWER	120 Vac, 60 Hz	DETECTOR FUNCTION	Peak (PK) Average (AV)
ENVIRONMENTAL CONDITIONS	25 deg. C, 65 % RH	TESTED BY	Charles Hsiao

ANTENNA POLARITY & TEST DISTANCE: HORIZONTAL AT 3 M										
FREQ. (MHz)	EMISSION LEVEL (dBuV/m)	READ LEVEL (dBuV)	LIMIT (dBuV/m)	MARGIN (dB)	ANTENNA FACTOR (dB/m)	CABLE LOSS (dB)	PREAMP FACTOR (dB)	ANTENNA HEIGHT (cm)	TABLE ANGLE (Degree)	REMARK
2346	41.38	39.81	54	-12.62	31.74	5.33	35.5	113	268	Average
2346	55.09	53.52	74	-18.91	31.74	5.33	35.5	113	268	Peak
2437	106.56	104.71			31.85	5.46	35.46	113	268	Average
2437	109.11	107.26			31.85	5.46	35.46	113	268	Peak
2484	40.48	38.52	54	-13.52	31.88	5.5	35.42	113	268	Average
2484	55.37	53.41	74	-18.63	31.88	5.5	35.42	113	268	Peak
4874	52.69	44.5	54	-1.31	33.98	8.27	34.06	176	236	Average
4874	56.2	48.01	74	-17.8	33.98	8.27	34.06	176	236	Peak
ANTENNA POLARITY & TEST DISTANCE: VERTICAL AT 3 M										
FREQ. (MHz)	EMISSION LEVEL (dBuV/m)	READ LEVEL (dBuV)	LIMIT (dBuV/m)	MARGIN (dB)	ANTENNA FACTOR (dB/m)	CABLE LOSS (dB)	PREAMP FACTOR (dB)	ANTENNA HEIGHT (cm)	TABLE ANGLE (Degree)	REMARK
2356	41.88	40.25	54	-12.12	31.76	5.37	35.5	100	353	Average
2356	55.43	53.8	74	-18.57	31.76	5.37	35.5	100	353	Peak
2437	102.71	100.86			31.85	5.46	35.46	100	353	Average
2437	105.31	103.46			31.85	5.46	35.46	100	353	Peak
2500	40.21	38.19	54	-13.79	31.9	5.53	35.41	100	353	Average
2500	55.74	53.72	74	-18.26	31.9	5.53	35.41	100	353	Peak
4874	47.29	39.1	54	-6.71	33.98	8.27	34.06	101	177	Average
4874	52.22	44.03	74	-21.78	33.98	8.27	34.06	101	177	Peak

REMARKS:

- Emission Level = Read Level + Antenna Factor + Cable Loss - Preamp Factor
Margin value = Emission level – Limit value
- 2437 MHz: Fundamental frequency.



EUT TEST CONDITION		MEASUREMENT DETAIL	
CHANNEL	Channel 11	FREQUENCY RANGE	1 GHz ~ 25 GHz
INPUT POWER	120 Vac, 60 Hz	DETECTOR FUNCTION	Peak (PK) Average (AV)
ENVIRONMENTAL CONDITIONS	25 deg. C, 65 % RH	TESTED BY	Charles Hsiao

ANTENNA POLARITY & TEST DISTANCE: HORIZONTAL AT 3 M										
FREQ. (MHz)	EMISSION LEVEL (dBuV/m)	READ LEVEL (dBuV)	LIMIT (dBuV/m)	MARGIN (dB)	ANTENNA FACTOR (dB/m)	CABLE LOSS (dB)	PREAMP FACTOR (dB)	ANTENNA HEIGHT (cm)	TABLE ANGLE (Degree)	REMARK
2384	41.68	39.99	54	-12.32	31.78	5.4	35.49	113	268	Average
2384	56.18	54.49	74	-17.82	31.78	5.4	35.49	113	268	Peak
2462	104.36	102.43			31.87	5.5	35.44	113	268	Average
2462	107.98	106.05			31.87	5.5	35.44	113	268	Peak
2492	41.83	39.81	54	-12.17	31.9	5.53	35.41	113	268	Average
2492	56.11	54.09	74	-17.89	31.9	5.53	35.41	113	268	Peak
4924	52.94	44.69	54	-1.06	33.99	8.28	34.02	100	234	Average
4924	56.66	48.41	74	-17.34	33.99	8.28	34.02	100	234	Peak
ANTENNA POLARITY & TEST DISTANCE: VERTICAL AT 3 M										
FREQ. (MHz)	EMISSION LEVEL (dBuV/m)	READ LEVEL (dBuV)	LIMIT (dBuV/m)	MARGIN (dB)	ANTENNA FACTOR (dB/m)	CABLE LOSS (dB)	PREAMP FACTOR (dB)	ANTENNA HEIGHT (cm)	TABLE ANGLE (Degree)	REMARK
2370	39.55	37.89	54	-14.45	31.78	5.37	35.49	113	360	Average
2370	55.81	54.15	74	-18.19	31.78	5.37	35.49	113	360	Peak
2462	100.66	98.73			31.87	5.5	35.44	113	360	Average
2462	103.14	101.21			31.87	5.5	35.44	113	360	Peak
2488	40.33	38.32	54	-13.67	31.9	5.53	35.42	113	360	Average
2488	55.28	53.27	74	-18.72	31.9	5.53	35.42	113	360	Peak
4924	49.64	41.39	54	-4.36	33.99	8.28	34.02	115	151	Average
4924	54.39	46.14	74	-19.61	33.99	8.28	34.02	115	151	Peak

REMARKS:

- Emission Level = Read Level + Antenna Factor + Cable Loss - Preamp Factor
Margin value = Emission level – Limit value
- 2462 MHz: Fundamental frequency.

802.11g

EUT TEST CONDITION		MEASUREMENT DETAIL	
CHANNEL	Channel 1	FREQUENCY RANGE	1 GHz ~ 25 GHz
INPUT POWER	120 Vac, 60 Hz	DETECTOR FUNCTION	Peak (PK) Average (AV)
ENVIRONMENTAL CONDITIONS	25 deg. C, 65 % RH	TESTED BY	Charles Hsiao

ANTENNA POLARITY & TEST DISTANCE: HORIZONTAL AT 3 M

FREQ. (MHz)	EMISSION LEVEL (dBuV/m)	READ LEVEL (dBuV)	LIMIT (dBuV/m)	MARGIN (dB)	ANTENNA FACTOR (dB/m)	CABLE LOSS (dB)	PREAMP FACTOR (dB)	ANTENNA HEIGHT (cm)	TABLE ANGLE (Degree)	REMARK
2390	52.85	51.12	54	-1.15	31.8	5.4	35.47	114	268	Average
2390	69.69	67.96	74	-4.31	31.8	5.4	35.47	114	268	Peak
2412	101.45	99.68			31.81	5.43	35.47	114	268	Average
2412	109.65	107.88			31.81	5.43	35.47	114	268	Peak
2496	40.53	38.51	54	-13.47	31.9	5.53	35.41	114	268	Average
2496	56.28	54.26	74	-17.72	31.9	5.53	35.41	114	268	Peak

ANTENNA POLARITY & TEST DISTANCE: VERTICAL AT 3 M

FREQ. (MHz)	EMISSION LEVEL (dBuV/m)	READ LEVEL (dBuV)	LIMIT (dBuV/m)	MARGIN (dB)	ANTENNA FACTOR (dB/m)	CABLE LOSS (dB)	PREAMP FACTOR (dB)	ANTENNA HEIGHT (cm)	TABLE ANGLE (Degree)	REMARK
2390	48	46.27	54	-6	31.8	5.4	35.47	100	353	Average
2390	64.81	63.08	74	-9.19	31.8	5.4	35.47	100	353	Peak
2412	97.35	95.58			31.81	5.43	35.47	100	353	Average
2412	105.07	103.3			31.81	5.43	35.47	100	353	Peak
2498	40.77	38.75	54	-13.23	31.9	5.53	35.41	100	353	Average
2498	55.83	53.81	74	-18.17	31.9	5.53	35.41	100	353	Peak

REMARKS:

- Emission Level = Read Level + Antenna Factor + Cable Loss - Preamp Factor
Margin value = Emission level – Limit value
- 2412 MHz: Fundamental frequency.



A D T

EUT TEST CONDITION		MEASUREMENT DETAIL	
CHANNEL	Channel 6	FREQUENCY RANGE	1 GHz ~ 25 GHz
INPUT POWER	120 Vac, 60 Hz	DETECTOR FUNCTION	Peak (PK) Average (AV)
ENVIRONMENTAL CONDITIONS	25 deg. C, 65 % RH	TESTED BY	Charles Hsiao

ANTENNA POLARITY & TEST DISTANCE: HORIZONTAL AT 3 M										
FREQ. (MHz)	EMISSION LEVEL (dBuV/m)	READ LEVEL (dBuV)	LIMIT (dBuV/m)	MARGIN (dB)	ANTENNA FACTOR (dB/m)	CABLE LOSS (dB)	PREAMP FACTOR (dB)	ANTENNA HEIGHT (cm)	TABLE ANGLE (Degree)	REMARK
2390	51.3	49.57	54	-2.7	31.8	5.4	35.47	113	268	Average
2390	71.95	70.22	74	-2.05	31.8	5.4	35.47	113	268	Peak
2437	107.61	105.76			31.85	5.46	35.46	113	268	Average
2437	115.54	113.69			31.85	5.46	35.46	113	268	Peak
2484	46.38	44.42	54	-7.62	31.88	5.5	35.42	113	268	Average
2484	64.82	62.86	74	-9.18	31.88	5.5	35.42	113	268	Peak
4874	48.55	40.36	54	-5.45	33.98	8.27	34.06	177	238	Average
4874	58.24	50.05	74	-15.76	33.98	8.27	34.06	177	238	Peak
7311	44.72	34.23	54	-9.28	35.54	9.95	35	177	216	Average
7311	55.95	45.46	74	-18.05	35.54	9.95	35	177	216	Peak

ANTENNA POLARITY & TEST DISTANCE: VERTICAL AT 3 M										
FREQ. (MHz)	EMISSION LEVEL (dBuV/m)	READ LEVEL (dBuV)	LIMIT (dBuV/m)	MARGIN (dB)	ANTENNA FACTOR (dB/m)	CABLE LOSS (dB)	PREAMP FACTOR (dB)	ANTENNA HEIGHT (cm)	TABLE ANGLE (Degree)	REMARK
2390	45.65	43.92	54	-8.35	31.8	5.4	35.47	100	353	Average
2390	66.55	64.82	74	-7.45	31.8	5.4	35.47	100	353	Peak
2437	103.51	101.66			31.85	5.46	35.46	100	353	Average
2437	111.41	109.56			31.85	5.46	35.46	100	353	Peak
2498	40.73	38.71	54	-13.27	31.9	5.53	35.41	100	353	Average
2498	55.25	53.23	74	-18.75	31.9	5.53	35.41	100	353	Peak
4874	42.59	34.4	54	-11.41	33.98	8.27	34.06	101	177	Average
4874	51.03	42.84	74	-22.97	33.98	8.27	34.06	101	177	Peak
7311	43.79	33.3	54	-10.21	35.54	9.95	35	101	170	Average
7311	53.53	43.04	74	-20.47	35.54	9.95	35	101	170	Peak

REMARKS:

- Emission Level = Read Level + Antenna Factor + Cable Loss - Preamp Factor
Margin value = Emission level – Limit value
- 2437 MHz: Fundamental frequency.



A D T

EUT TEST CONDITION		MEASUREMENT DETAIL	
CHANNEL	Channel 11	FREQUENCY RANGE	1 GHz ~ 25 GHz
INPUT POWER	120 Vac, 60 Hz	DETECTOR FUNCTION	Peak (PK) Average (AV)
ENVIRONMENTAL CONDITIONS	25 deg. C, 65 % RH	TESTED BY	Charles Hsiao

ANTENNA POLARITY & TEST DISTANCE: HORIZONTAL AT 3 M										
FREQ. (MHz)	EMISSION LEVEL (dBuV/m)	READ LEVEL (dBuV)	LIMIT (dBuV/m)	MARGIN (dB)	ANTENNA FACTOR (dB/m)	CABLE LOSS (dB)	PREAMP FACTOR (dB)	ANTENNA HEIGHT (cm)	TABLE ANGLE (Degree)	REMARK
2380	42.35	40.69	54	-11.65	31.78	5.37	35.49	113	268	Average
2380	55.87	54.21	74	-18.13	31.78	5.37	35.49	113	268	Peak
2462	99.96	98.03			31.87	5.5	35.44	113	268	Average
2462	107.24	105.31			31.87	5.5	35.44	113	268	Peak
2484	52.98	51.02	54	-1.02	31.88	5.5	35.42	113	268	Average
2484	70.02	68.06	74	-3.98	31.88	5.5	35.42	113	268	Peak

ANTENNA POLARITY & TEST DISTANCE: VERTICAL AT 3 M										
FREQ. (MHz)	EMISSION LEVEL (dBuV/m)	READ LEVEL (dBuV)	LIMIT (dBuV/m)	MARGIN (dB)	ANTENNA FACTOR (dB/m)	CABLE LOSS (dB)	PREAMP FACTOR (dB)	ANTENNA HEIGHT (cm)	TABLE ANGLE (Degree)	REMARK
2370	40.45	38.79	54	-13.55	31.78	5.37	35.49	113	360	Average
2370	55.46	53.8	74	-18.54	31.78	5.37	35.49	113	360	Peak
2462	95.36	93.43			31.87	5.5	35.44	113	360	Average
2462	103.07	101.14			31.87	5.5	35.44	113	360	Peak
2484	44.69	42.73	54	-9.31	31.88	5.5	35.42	113	360	Average
2484	61.36	59.4	74	-12.64	31.88	5.5	35.42	113	360	Peak

REMARKS:

- Emission Level = Read Level + Antenna Factor + Cable Loss - Preamp Factor
Margin value = Emission level – Limit value
- 2462 MHz: Fundamental frequency.



802.11n (HT20)

EUT TEST CONDITION		MEASUREMENT DETAIL	
CHANNEL	Channel 1	FREQUENCY RANGE	1 GHz ~ 25 GHz
INPUT POWER	120 Vac, 60 Hz	DETECTOR FUNCTION	Peak (PK) Average (AV)
ENVIRONMENTAL CONDITIONS	25 deg. C, 65 % RH	TESTED BY	Charles Hsiao

ANTENNA POLARITY & TEST DISTANCE: HORIZONTAL AT 3 M

FREQ. (MHz)	EMISSION LEVEL (dBuV/m)	READ LEVEL (dBuV)	LIMIT (dBuV/m)	MARGIN (dB)	ANTENNA FACTOR (dB/m)	CABLE LOSS (dB)	PREAMP FACTOR (dB)	ANTENNA HEIGHT (cm)	TABLE ANGLE (Degree)	REMARK
2390	52.52	50.79	54	-1.48	31.8	5.4	35.47	114	268	Average
2390	67.87	66.14	74	-6.13	31.8	5.4	35.47	114	268	Peak
2412	99.75	97.98			31.81	5.43	35.47	114	268	Average
2412	107.78	106.01			31.81	5.43	35.47	114	268	Peak
2498	41.53	39.51	54	-12.47	31.9	5.53	35.41	114	268	Average
2498	56.26	54.24	74	-17.74	31.9	5.53	35.41	114	268	Peak

ANTENNA POLARITY & TEST DISTANCE: VERTICAL AT 3 M

FREQ. (MHz)	EMISSION LEVEL (dBuV/m)	READ LEVEL (dBuV)	LIMIT (dBuV/m)	MARGIN (dB)	ANTENNA FACTOR (dB/m)	CABLE LOSS (dB)	PREAMP FACTOR (dB)	ANTENNA HEIGHT (cm)	TABLE ANGLE (Degree)	REMARK
2390	47.3	45.57	54	-6.7	31.8	5.4	35.47	100	353	Average
2390	62.09	60.36	74	-11.91	31.8	5.4	35.47	100	353	Peak
2412	95.25	93.48			31.81	5.43	35.47	100	353	Average
2412	103.08	101.31			31.81	5.43	35.47	100	353	Peak
2486	40.71	38.72	54	-13.29	31.88	5.53	35.42	100	353	Average
2486	55.28	53.29	74	-18.72	31.88	5.53	35.42	100	353	Peak

REMARKS:

- Emission Level = Read Level + Antenna Factor + Cable Loss - Preamp Factor
Margin value = Emission level – Limit value
- 2412 MHz: Fundamental frequency.



A D T

EUT TEST CONDITION		MEASUREMENT DETAIL	
CHANNEL	Channel 6	FREQUENCY RANGE	1 GHz ~ 25 GHz
INPUT POWER	120 Vac, 60 Hz	DETECTOR FUNCTION	Peak (PK) Average (AV)
ENVIRONMENTAL CONDITIONS	25 deg. C, 65 % RH	TESTED BY	Charles Hsiao

ANTENNA POLARITY & TEST DISTANCE: HORIZONTAL AT 3 M										
FREQ. (MHz)	EMISSION LEVEL (dBuV/m)	READ LEVEL (dBuV)	LIMIT (dBuV/m)	MARGIN (dB)	ANTENNA FACTOR (dB/m)	CABLE LOSS (dB)	PREAMP FACTOR (dB)	ANTENNA HEIGHT (cm)	TABLE ANGLE (Degree)	REMARK
2388	51.61	49.9	54	-2.39	31.8	5.4	35.49	100	268	Average
2388	72.77	71.06	74	-1.23	31.8	5.4	35.49	100	268	Peak
2437	106.31	104.46			31.85	5.46	35.46	100	268	Average
2437	114.27	112.42			31.85	5.46	35.46	100	268	Peak
2484	46.68	44.72	54	-7.32	31.88	5.5	35.42	100	268	Average
2484	63.35	61.39	74	-10.65	31.88	5.5	35.42	100	268	Peak
4874	47.99	39.8	54	-6.01	33.98	8.27	34.06	177	238	Average
4874	56.4	48.21	74	-17.6	33.98	8.27	34.06	177	238	Peak
7311	43.89	33.4	54	-10.11	35.54	9.95	35	177	216	Average
7311	53.21	42.72	74	-20.79	35.54	9.95	35	177	216	Peak
ANTENNA POLARITY & TEST DISTANCE: VERTICAL AT 3 M										
FREQ. (MHz)	EMISSION LEVEL (dBuV/m)	READ LEVEL (dBuV)	LIMIT (dBuV/m)	MARGIN (dB)	ANTENNA FACTOR (dB/m)	CABLE LOSS (dB)	PREAMP FACTOR (dB)	ANTENNA HEIGHT (cm)	TABLE ANGLE (Degree)	REMARK
2390	47.3	45.57	54	-6.7	31.8	5.4	35.47	100	353	Average
2390	65.67	63.94	74	-8.33	31.8	5.4	35.47	100	353	Peak
2437	101.41	99.56			31.85	5.46	35.46	100	353	Average
2437	109.99	108.14			31.85	5.46	35.46	100	353	Peak
2498	41.43	39.41	54	-12.57	31.9	5.53	35.41	100	353	Average
2498	56	53.98	74	-18	31.9	5.53	35.41	100	353	Peak
4874	41.89	33.7	54	-12.11	33.98	8.27	34.06	101	177	Average
4874	50.94	42.75	74	-23.06	33.98	8.27	34.06	101	177	Peak
7311	43.32	32.83	54	-10.68	35.54	9.95	35	101	170	Average
7311	53.1	42.61	74	-20.9	35.54	9.95	35	101	170	Peak

REMARKS:

- Emission Level = Read Level + Antenna Factor + Cable Loss - Preamp Factor
Margin value = Emission level – Limit value
- 2437 MHz: Fundamental frequency.



A D T

EUT TEST CONDITION		MEASUREMENT DETAIL	
CHANNEL	Channel 11	FREQUENCY RANGE	1 GHz ~ 25 GHz
INPUT POWER	120 Vac, 60 Hz	DETECTOR FUNCTION	Peak (PK) Average (AV)
ENVIRONMENTAL CONDITIONS	25 deg. C, 65 % RH	TESTED BY	Charles Hsiao

ANTENNA POLARITY & TEST DISTANCE: HORIZONTAL AT 3 M										
FREQ. (MHz)	EMISSION LEVEL (dBuV/m)	READ LEVEL (dBuV)	LIMIT (dBuV/m)	MARGIN (dB)	ANTENNA FACTOR (dB/m)	CABLE LOSS (dB)	PREAMP FACTOR (dB)	ANTENNA HEIGHT (cm)	TABLE ANGLE (Degree)	REMARK
2386	42.7	40.99	54	-11.3	31.8	5.4	35.49	113	268	Average
2386	56.25	54.54	74	-17.75	31.8	5.4	35.49	113	268	Peak
2462	98.96	97.03			31.87	5.5	35.44	113	268	Average
2462	106.37	104.44			31.87	5.5	35.44	113	268	Peak
2484	52.58	50.62	54	-1.42	31.88	5.5	35.42	113	268	Average
2484	69.04	67.08	74	-4.96	31.88	5.5	35.42	113	268	Peak

ANTENNA POLARITY & TEST DISTANCE: VERTICAL AT 3 M										
FREQ. (MHz)	EMISSION LEVEL (dBuV/m)	READ LEVEL (dBuV)	LIMIT (dBuV/m)	MARGIN (dB)	ANTENNA FACTOR (dB/m)	CABLE LOSS (dB)	PREAMP FACTOR (dB)	ANTENNA HEIGHT (cm)	TABLE ANGLE (Degree)	REMARK
2384	40.58	38.89	54	-13.42	31.78	5.4	35.49	113	360	Average
2384	55.92	54.23	74	-18.08	31.78	5.4	35.49	113	360	Peak
2462	94.36	92.43			31.87	5.5	35.44	113	360	Average
2462	102.37	100.44			31.87	5.5	35.44	113	360	Peak
2484	44.58	42.62	54	-9.42	31.88	5.5	35.42	113	360	Average
2484	61.21	59.25	74	-12.79	31.88	5.5	35.42	113	360	Peak

REMARKS:

- Emission Level = Read Level + Antenna Factor + Cable Loss - Preamp Factor
Margin value = Emission level – Limit value
- 2462 MHz: Fundamental frequency.

802.11n (HT40)

EUT TEST CONDITION		MEASUREMENT DETAIL	
CHANNEL	Channel 3	FREQUENCY RANGE	1 GHz ~ 25 GHz
INPUT POWER	120 Vac, 60 Hz	DETECTOR FUNCTION	Peak (PK) Average (AV)
ENVIRONMENTAL CONDITIONS	25 deg. C, 65 % RH	TESTED BY	Charles Hsiao

ANTENNA POLARITY & TEST DISTANCE: HORIZONTAL AT 3 M

FREQ. (MHz)	EMISSION LEVEL (dBuV/m)	READ LEVEL (dBuV)	LIMIT (dBuV/m)	MARGIN (dB)	ANTENNA FACTOR (dB/m)	CABLE LOSS (dB)	PREAMP FACTOR (dB)	ANTENNA HEIGHT (cm)	TABLE ANGLE (Degree)	REMARK
2388	52.7	50.99	54	-1.3	31.8	5.4	35.49	113	268	Average
2388	72	70.29	74	-2	31.8	5.4	35.49	113	268	Peak
2422	97.56	95.76			31.83	5.43	35.46	113	268	Average
2422	105.85	104.05			31.83	5.43	35.46	113	268	Peak
2484	41.88	39.92	54	-12.12	31.88	5.5	35.42	113	268	Average
2484	58.29	56.33	74	-15.71	31.88	5.5	35.42	113	268	Peak

ANTENNA POLARITY & TEST DISTANCE: VERTICAL AT 3 M

FREQ. (MHz)	EMISSION LEVEL (dBuV/m)	READ LEVEL (dBuV)	LIMIT (dBuV/m)	MARGIN (dB)	ANTENNA FACTOR (dB/m)	CABLE LOSS (dB)	PREAMP FACTOR (dB)	ANTENNA HEIGHT (cm)	TABLE ANGLE (Degree)	REMARK
2386	48	46.29	54	-6	31.8	5.4	35.49	100	353	Average
2386	67.13	65.42	74	-6.87	31.8	5.4	35.49	100	353	Peak
2422	93.76	91.96			31.83	5.43	35.46	100	353	Average
2422	101.35	99.55			31.83	5.43	35.46	100	353	Peak
2488	40.83	38.82	54	-13.17	31.9	5.53	35.42	100	353	Average
2488	55.5	53.49	74	-18.5	31.9	5.53	35.42	100	353	Peak

REMARKS:

- Emission Level = Read Level + Antenna Factor + Cable Loss - Preamp Factor
Margin value = Emission level – Limit value
- 2422 MHz: Fundamental frequency.



A D T

EUT TEST CONDITION		MEASUREMENT DETAIL	
CHANNEL	Channel 6	FREQUENCY RANGE	1 GHz ~ 25 GHz
INPUT POWER	120 Vac, 60 Hz	DETECTOR FUNCTION	Peak (PK) Average (AV)
ENVIRONMENTAL CONDITIONS	25 deg. C, 65 % RH	TESTED BY	Charles Hsiao

ANTENNA POLARITY & TEST DISTANCE: HORIZONTAL AT 3 M										
FREQ. (MHz)	EMISSION LEVEL (dBuV/m)	READ LEVEL (dBuV)	LIMIT (dBuV/m)	MARGIN (dB)	ANTENNA FACTOR (dB/m)	CABLE LOSS (dB)	PREAMP FACTOR (dB)	ANTENNA HEIGHT (cm)	TABLE ANGLE (Degree)	REMARK
2384	52.81	51.12	54	-1.19	31.78	5.4	35.49	113	268	Average
2384	69.5	67.81	74	-4.5	31.78	5.4	35.49	113	268	Peak
2437	99.91	98.06			31.85	5.46	35.46	113	268	Average
2437	107.57	105.72			31.85	5.46	35.46	113	268	Peak
2484	49.77	47.81	54	-4.23	31.88	5.5	35.42	113	268	Average
2484	67.47	65.51	74	-6.53	31.88	5.5	35.42	113	268	Peak

ANTENNA POLARITY & TEST DISTANCE: VERTICAL AT 3 M										
FREQ. (MHz)	EMISSION LEVEL (dBuV/m)	READ LEVEL (dBuV)	LIMIT (dBuV/m)	MARGIN (dB)	ANTENNA FACTOR (dB/m)	CABLE LOSS (dB)	PREAMP FACTOR (dB)	ANTENNA HEIGHT (cm)	TABLE ANGLE (Degree)	REMARK
2390	45.8	44.07	54	-8.2	31.8	5.4	35.47	112	353	Average
2390	63.11	61.38	74	-10.89	31.8	5.4	35.47	112	353	Peak
2437	95.61	93.76			31.85	5.46	35.46	112	353	Average
2437	103.09	101.24			31.85	5.46	35.46	112	353	Peak
2498	41.53	39.51	54	-12.47	31.9	5.53	35.41	112	353	Average
2498	55.54	53.52	74	-18.46	31.9	5.53	35.41	112	353	Peak

REMARKS:

- Emission Level = Read Level + Antenna Factor + Cable Loss - Preamp Factor
Margin value = Emission level – Limit value
- 2437 MHz: Fundamental frequency.



A D T

EUT TEST CONDITION		MEASUREMENT DETAIL	
CHANNEL	Channel 9	FREQUENCY RANGE	1 GHz ~ 25 GHz
INPUT POWER	120 Vac, 60 Hz	DETECTOR FUNCTION	Peak (PK) Average (AV)
ENVIRONMENTAL CONDITIONS	25 deg. C, 65 % RH	TESTED BY	Charles Hsiao

ANTENNA POLARITY & TEST DISTANCE: HORIZONTAL AT 3 M										
FREQ. (MHz)	EMISSION LEVEL (dBuV/m)	READ LEVEL (dBuV)	LIMIT (dBuV/m)	MARGIN (dB)	ANTENNA FACTOR (dB/m)	CABLE LOSS (dB)	PREAMP FACTOR (dB)	ANTENNA HEIGHT (cm)	TABLE ANGLE (Degree)	REMARK
2390	42.3	40.57	54	-11.7	31.8	5.4	35.47	113	268	Average
2390	66.64	64.91	74	-7.36	31.8	5.4	35.47	113	268	Peak
2452	95.81	93.94			31.85	5.46	35.44	113	268	Average
2452	103.48	101.61			31.85	5.46	35.44	113	268	Peak
2484	51.63	49.67	54	-2.37	31.88	5.5	35.42	113	268	Average
2484	69.54	67.58	74	-4.46	31.88	5.5	35.42	113	268	Peak

ANTENNA POLARITY & TEST DISTANCE: VERTICAL AT 3 M										
FREQ. (MHz)	EMISSION LEVEL (dBuV/m)	READ LEVEL (dBuV)	LIMIT (dBuV/m)	MARGIN (dB)	ANTENNA FACTOR (dB/m)	CABLE LOSS (dB)	PREAMP FACTOR (dB)	ANTENNA HEIGHT (cm)	TABLE ANGLE (Degree)	REMARK
2382	40.38	38.69	54	-13.62	31.78	5.4	35.49	113	360	Average
2382	56.83	55.14	74	-17.17	31.78	5.4	35.49	113	360	Peak
2452	91.31	89.44			31.85	5.46	35.44	113	360	Average
2452	99.76	97.89			31.85	5.46	35.44	113	360	Peak
2484	43.93	41.97	54	-10.07	31.88	5.5	35.42	113	360	Average
2484	59.35	57.39	74	-14.65	31.88	5.5	35.42	113	360	Peak

REMARKS:

- Emission Level = Read Level + Antenna Factor + Cable Loss - Preamp Factor
Margin value = Emission level – Limit value
- 2452 MHz: Fundamental frequency.

9 kHz ~ 30 MHz DATA:

The amplitude of spurious emissions attenuated more than 20 dB below the permissible value is not required to be report.

30 MHz ~ 1 GHz WORST-CASE DATA:
802.11g

EUT TEST CONDITION		MEASUREMENT DETAIL	
CHANNEL	Channel 11	FREQUENCY RANGE	30 MHz ~ 1 GHz
INPUT POWER	120 Vac, 60 Hz	DETECTOR FUNCTION	Peak (PK)
ENVIRONMENTAL CONDITIONS	25 deg. C, 65 % RH	TESTED BY	Charles Hsiao

ANTENNA POLARITY & TEST DISTANCE: HORIZONTAL AT 3 M										
FREQ. (MHz)	EMISSION LEVEL (dBuV/m)	READ LEVEL (dBuV)	LIMIT (dBuV/m)	MARGIN (dB)	ANTENNA FACTOR (dB/m)	CABLE LOSS (dB)	PREAMP FACTOR (dB)	ANTENNA HEIGHT (cm)	TABLE ANGLE (Degree)	REMARK
95.88	24.06	43.07	43.5	-19.44	11.75	1.28	32.04	145	121	Peak
219.27	29.71	48.96	46	-16.29	11.32	1.65	32.22	146	108	Peak
288.66	35.93	53.18	46	-10.07	12.85	2.03	32.13	169	122	Peak
342	33.01	48.79	46	-12.99	14.11	2.19	32.08	163	238	Peak
628.3	30.16	41.2	46	-15.84	18.2	2.93	32.17	146	128	Peak
857.2	36.59	43.78	46	-9.41	21.12	3.44	31.75	169	217	Peak
ANTENNA POLARITY & TEST DISTANCE: VERTICAL AT 3 M										
FREQ. (MHz)	EMISSION LEVEL (dBuV/m)	READ LEVEL (dBuV)	LIMIT (dBuV/m)	MARGIN (dB)	ANTENNA FACTOR (dB/m)	CABLE LOSS (dB)	PREAMP FACTOR (dB)	ANTENNA HEIGHT (cm)	TABLE ANGLE (Degree)	REMARK
95.88	16.59	35.6	43.5	-26.91	11.75	1.28	32.04	169	211	Peak
168.24	13.5	35.16	43.5	-30	9.06	1.52	32.24	145	281	Peak
251.94	23.74	41.55	46	-22.26	12.35	1.94	32.1	163	230	Peak
350.4	31.12	46.78	46	-14.88	14.22	2.19	32.07	163	238	Peak
503.7	28.61	41.68	46	-17.39	16.4	2.63	32.1	145	281	Peak
707.4	32.46	42.12	46	-13.54	19.33	3.11	32.1	162	124	Peak

REMARKS:

- Emission Level = Read Level + Antenna Factor + Cable Loss - Preamp Factor
Margin value = Emission level – Limit value

4.2 Conducted Emission Measurement

4.2.1 Limits of Conducted Emission Measurement

Frequency (MHz)	Conducted Limit (dBuV)	
	Quasi-peak	Average
0.15 - 0.5	66 - 56	56 - 46
0.50 - 5.0	56	46
5.0 - 30.0	60	50

Note: 1. The lower limit shall apply at the transition frequencies.

2. The limit decreases in line with the logarithm of the frequency in the range of 0.15 to 0.50 MHz.

4.2.2 Test Instruments

Description & Manufacturer	Model No.	Serial No.	Date of Calibration	Due Date of Calibration
Test Receiver ROHDE & SCHWARZ	ESCI	100613	Nov. 16, 2015	Nov. 15, 2016
RF signal cable Woken	5D-FB	Cable-cond1-01	Dec. 26, 2014	Dec. 25, 2015
LISN ROHDE & SCHWARZ (EUT)	ESH3-Z5	835239/001	Feb. 26, 2015	Feb. 25, 2016
LISN ROHDE & SCHWARZ (Peripheral)	ESH3-Z5	100311	Jul. 24, 2015	Jul. 23, 2016
Software ADT	BV ADT_Cond_ V7.3.7.3	NA	NA	NA

Note: 1. The calibration interval of the above test instruments is 12 months and the calibrations are traceable to NML/ROC and NIST/USA.

2. The test was performed in HwaYa Shielded Room 1.

3. The VCCI Site Registration No. is C-2040.

4.2.3 Test Procedures

- a. The EUT was placed 0.4 meters from the conducting wall of the shielded room with EUT being connected to the power mains through a line impedance stabilization network (LISN). Other support units were connected to the power mains through another LISN. The two LISNs provide 50 ohm/50 uH of coupling impedance for the measuring instrument.
- b. Both lines of the power mains connected to the EUT were checked for maximum conducted interference.
- c. The frequency range from 150 kHz to 30 MHz was searched. Emission levels under (Limit – 20 dB) was not recorded.

NOTE: All modes of operation were investigated and the worst-case emissions are reported.

4.2.4 Deviation from Test Standard

No deviation.

4.2.5 Test Setup

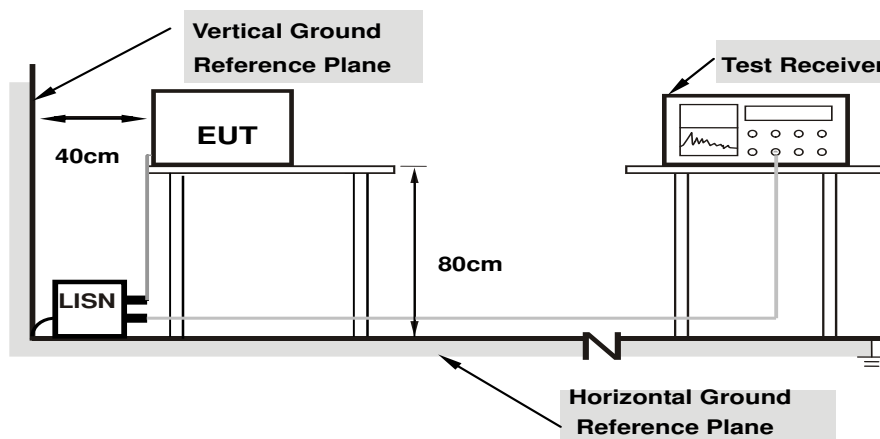

Note: 1.Support units were connected to second LISN.

For the actual test configuration, please refer to the attached file (Test Setup Photo).

4.2.6 EUT Operating Conditions

- a. Placed the EUT on a testing table.
- b. Use the software to control the EUT under transmission condition continuously at specific channel frequency.

4.2.7 Test Results

Frequency Range	150kHz ~ 30MHz	Detector Function & Resolution Bandwidth	Quasi-Peak (QP) / Average (AV), 9kHz
Input Power	120Vac, 60Hz	Environmental Conditions	25°C, 65%RH
Tested by	Toboy Tian	Test Date	2015/11/21

Phase Of Power : Line (L)										
No	Frequency (MHz)	Correction Factor (dB)	Reading Value (dBuV)		Emission Level (dBuV)		Limit (dBuV)		Margin (dB)	
			Q.P.	AV.	Q.P.	AV.	Q.P.	AV.	Q.P.	AV.
1	0.15391	9.85	29.33	22.54	39.18	32.39	65.79	55.79	-26.61	-23.40
2	0.19305	9.92	24.71	15.50	34.63	25.42	63.90	53.90	-29.28	-28.49
3	0.41979	9.90	24.89	18.48	34.79	28.38	57.45	47.45	-22.66	-19.07
4	0.67785	9.96	23.37	13.87	33.33	23.83	56.00	46.00	-22.67	-22.17
5	1.85476	10.09	24.55	12.81	34.64	22.90	56.00	46.00	-21.36	-23.10
6	16.11453	10.92	25.07	16.16	35.99	27.08	60.00	50.00	-24.01	-22.92

Remarks:

1. Q.P. and AV. are abbreviations of quasi-peak and average individually.
2. The emission levels of other frequencies were very low against the limit.
3. Margin value = Emission level – Limit value
4. Correction factor = Insertion loss + Cable loss
5. Emission Level = Correction Factor + Reading Value

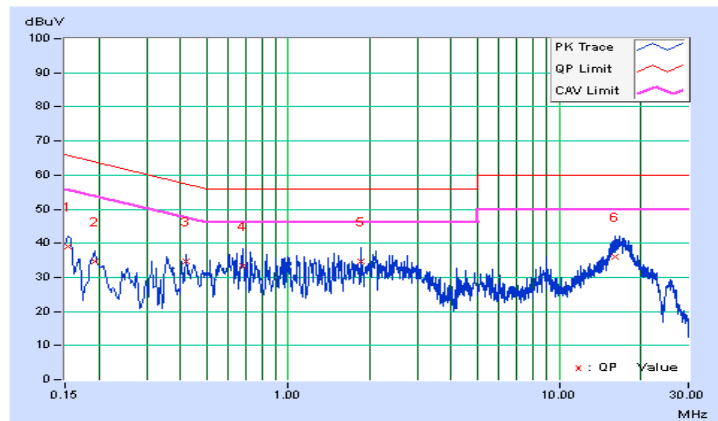

Frequency Range	150kHz ~ 30MHz	Detector Function & Resolution Bandwidth	Quasi-Peak (QP) / Average (AV), 9kHz
Input Power	120Vac, 60Hz	Environmental Conditions	25°C, 65%RH
Tested by	Toboy Tian	Test Date	2015/11/21

Phase Of Power : Neutral (N)										
No	Frequency (MHz)	Correction Factor (dB)	Reading Value (dBuV)		Emission Level (dBuV)		Limit (dBuV)		Margin (dB)	
			Q.P.	AV.	Q.P.	AV.	Q.P.	AV.	Q.P.	AV.
1	0.15391	9.90	30.71	23.49	40.61	33.39	65.79	55.79	-25.18	-22.40
2	0.36505	10.00	28.26	19.63	38.26	29.63	58.61	48.61	-20.36	-18.99
3	0.68564	10.01	25.21	12.71	35.22	22.72	56.00	46.00	-20.78	-23.28
4	1.40120	10.05	22.64	15.86	32.69	25.91	56.00	46.00	-23.31	-20.09
5	2.09718	10.10	24.87	13.60	34.97	23.70	56.00	46.00	-21.03	-22.30
6	17.07248	10.92	25.95	17.56	36.87	28.48	60.00	50.00	-23.13	-21.52

Remarks:

1. Q.P. and AV. are abbreviations of quasi-peak and average individually.
2. The emission levels of other frequencies were very low against the limit.
3. Margin value = Emission level – Limit value
4. Correction factor = Insertion loss + Cable loss
5. Emission Level = Correction Factor + Reading Value

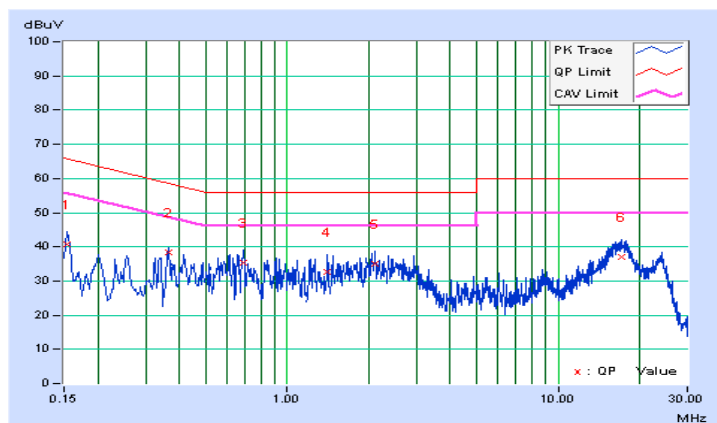

4.3 6 dB Bandwidth Measurement

4.3.1 Limits of 6 dB Bandwidth Measurement

The minimum of 6 dB Bandwidth Measurement is 0.5 MHz.

4.3.2 Test Setup

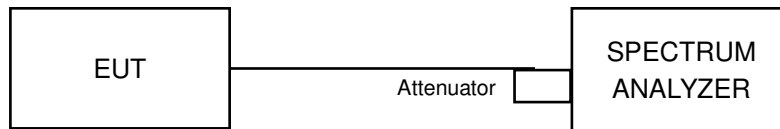

4.3.3 Test Instruments

Refer to section 4.1.2 to get information of above instrument.

4.3.4 Test Procedure

- Set resolution bandwidth (RBW) = 100 kHz
- Set the video bandwidth (VBW) $\geq 3 \times$ RBW, Detector = Peak.
- Trace mode = max hold.
- Sweep = auto couple.
- Measure the maximum width of the emission that is constrained by the frequencies associated with the two amplitude points (upper and lower) that are attenuated by 6 dB relative to the maximum level measured in the fundamental emission

4.3.5 Deviation from Test Standard

No deviation.

4.3.6 EUT Operating Conditions

The software provided by client to enable the EUT under transmission condition continuously at lowest, middle and highest channel frequencies individually.

4.3.7 Test Result

802.11b

Channel	Frequency (MHz)	6 db Bandwidth (MHz)	Minimum Limit (MHz)	Pass / Fail
1	2412	10.09	0.5	Pass
6	2437	10.11	0.5	Pass
11	2462	10.11	0.5	Pass

802.11g

Channel	Frequency (MHz)	6 db Bandwidth (MHz)	Minimum Limit (MHz)	Pass / Fail
1	2412	16.36	0.5	Pass
6	2437	16.36	0.5	Pass
11	2462	16.36	0.5	Pass

802.11n (HT20)

Channel	Frequency (MHz)	6 db Bandwidth (MHz)	Minimum Limit (MHz)	Pass / Fail
1	2412	17.19	0.5	Pass
6	2437	17.56	0.5	Pass
11	2462	17.34	0.5	Pass

802.11n (HT40)

Channel	Frequency (MHz)	6 db Bandwidth (MHz)	Minimum Limit (MHz)	Pass / Fail
3	2422	35.15	0.5	Pass
6	2437	35.21	0.5	Pass
9	2452	35.19	0.5	Pass

Spectrum Plot of Worst Value

802.11b

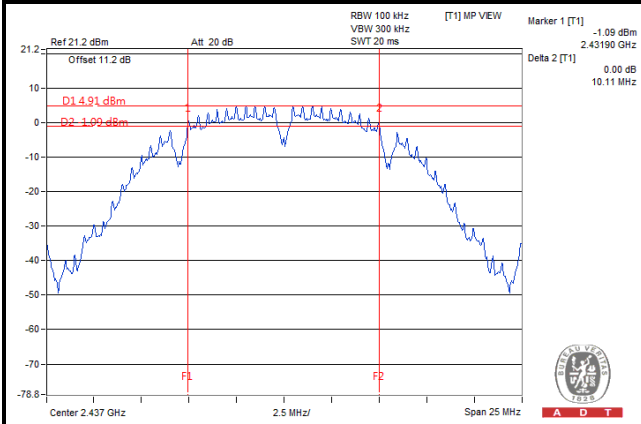

802.11g

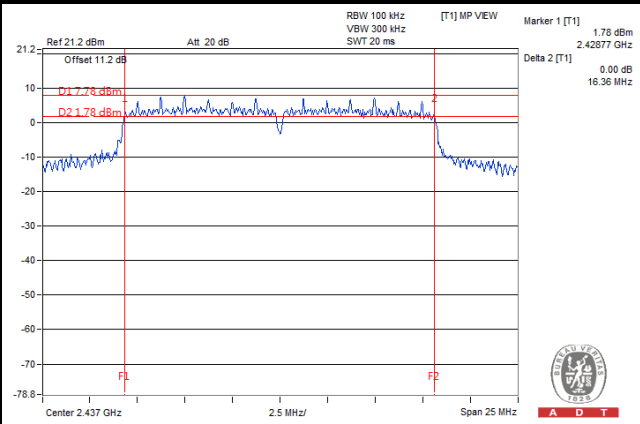

802.11n (HT20)

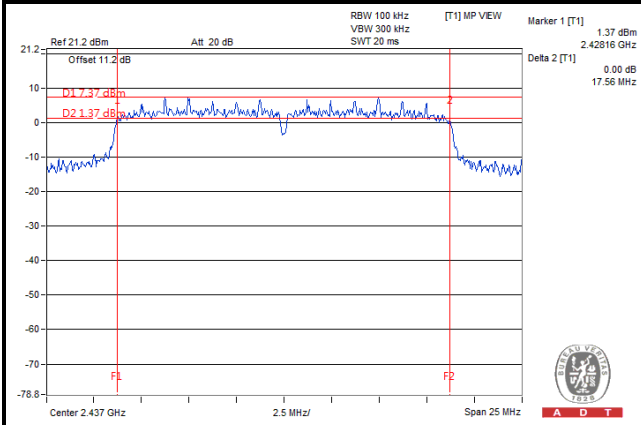

802.11n (HT40)

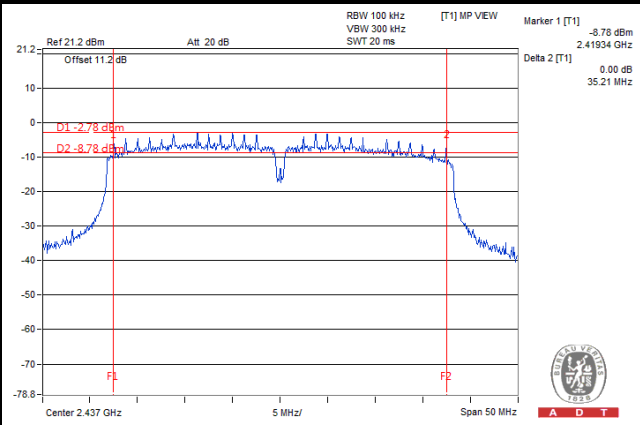

4.4 Conducted Output Power Measurement

4.4.1 Limits of Conducted Output Power Measurement

For systems using digital modulation in the 2400–2483.5 MHz bands: 1 Watt (30 dBm)

4.4.2 Test Setup

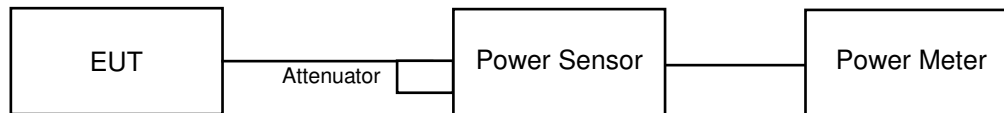

4.4.3 Test Instruments

Refer to section 4.1.2 to get information of above instrument.

4.4.4 Test Procedures

A peak power sensor was used on the output port of the EUT. A power meter was used to read the response of the peak power sensor. Record the power level.

4.4.5 Deviation from Test Standard

No deviation.

4.4.6 EUT Operating Conditions

The software provided by client to enable the EUT under transmission condition continuously at lowest, middle and highest channel frequencies individually.

4.4.7 Test Results

802.11b

Channel	Frequency (MHz)	Peak Power (mW)	Peak Power (dBm)	Limit (dBm)	Pass / Fail
1	2412	59.02	17.71	30	Pass
6	2437	53.33	17.27	30	Pass
11	2462	48.42	16.85	30	Pass

802.11g

Channel	Frequency (MHz)	Peak Power (mW)	Peak Power (dBm)	Limit (dBm)	Pass / Fail
1	2412	80.54	19.06	30	Pass
6	2437	199.99	23.01	30	Pass
11	2462	74.47	18.72	30	Pass

802.11n (HT20)

Channel	Frequency (MHz)	Peak Power (mW)	Peak Power (dBm)	Limit (dBm)	Pass / Fail
1	2412	73.28	18.65	30	Pass
6	2437	207.01	23.16	30	Pass
11	2462	65.46	18.16	30	Pass

802.11n (HT40)

Channel	Frequency (MHz)	Peak Power (mW)	Peak Power (dBm)	Limit (dBm)	Pass / Fail
3	2422	55.46	17.44	30	Pass
6	2437	80.54	19.06	30	Pass
9	2452	52.48	17.2	30	Pass

4.5 Power Spectral Density Measurement

4.5.1 Limits of Power Spectral Density Measurement

The Maximum of Power Spectral Density Measurement is 8 dBm.

4.5.2 Test Setup

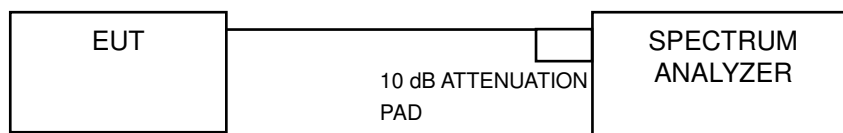

4.5.3 Test Instruments

Refer to section 4.1.2 to get information of above instrument.

4.5.4 Test Procedure

- Set analyzer center frequency to DTS channel center frequency.
- Set the span to 1.5 times the DTS bandwidth.
- Set the RBW to: $3 \text{ kHz} \leq \text{RBW} \leq 100 \text{ kHz}$.
- Set the VBW $\geq 3 \times \text{RBW}$.
- Detector = peak.
- Sweep time = auto couple.
- Trace mode = max hold.
- Allow trace to fully stabilize.
- Use the peak marker function to determine the maximum amplitude level within the RBW.

4.5.5 Deviation from Test Standard

No deviation.

4.5.6 EUT Operating Condition

The software provided by client to enable the EUT under transmission condition continuously at lowest, middle and highest channel frequencies individually.

4.5.7 Test Results

802.11b

Channel	Frequency (MHz)	PSD (dBm)	Limit (dBm)	Pass / Fail
1	2412	-8.37	8	Pass
6	2437	-8.29	8	Pass
11	2462	-10.24	8	Pass

802.11g

Channel	Frequency (MHz)	PSD (dBm)	Limit (dBm)	Pass / Fail
1	2412	-14.97	8	Pass
6	2437	-8.03	8	Pass
11	2462	-15.33	8	Pass

802.11n (HT20)

Channel	Frequency (MHz)	PSD (dBm)	Limit (dBm)	Pass / Fail
1	2412	-15.18	8	Pass
6	2437	-8.23	8	Pass
11	2462	-17.24	8	Pass

802.11n (HT40)

Channel	Frequency (MHz)	PSD (dBm)	Limit (dBm)	Pass / Fail
3	2422	-16.50	8	Pass
6	2437	-17.09	8	Pass
9	2452	-19.53	8	Pass

Spectrum Plot of Worst Value

802.11b

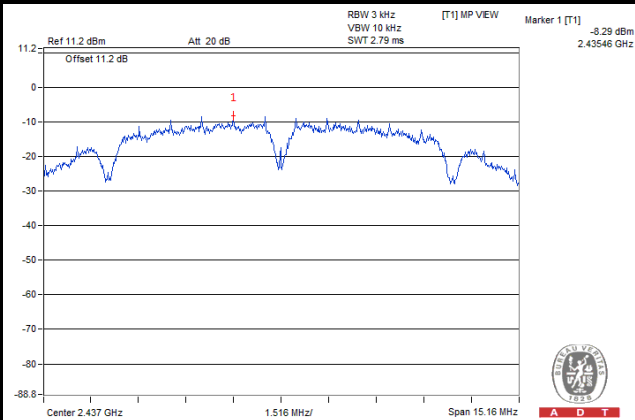

802.11g

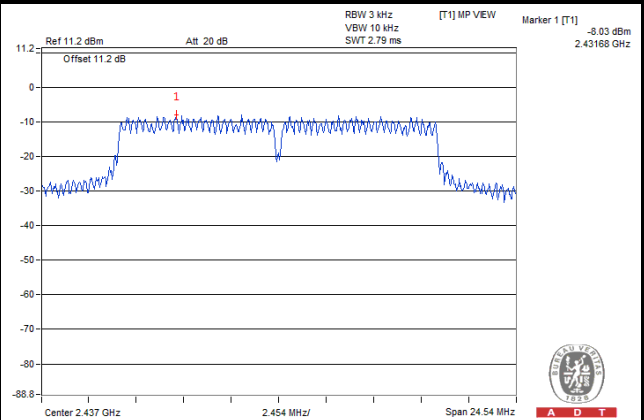

802.11n (HT20)

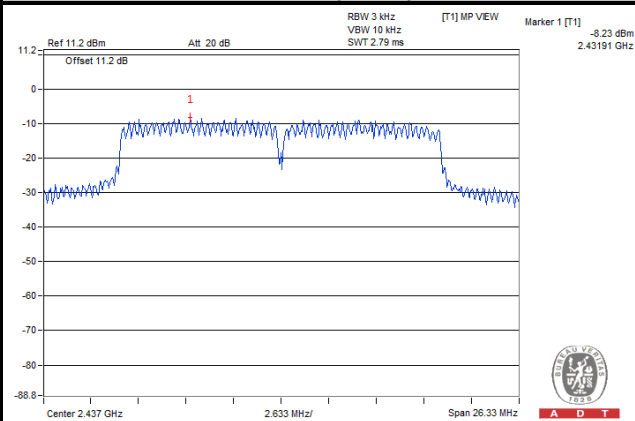

802.11n (HT40)

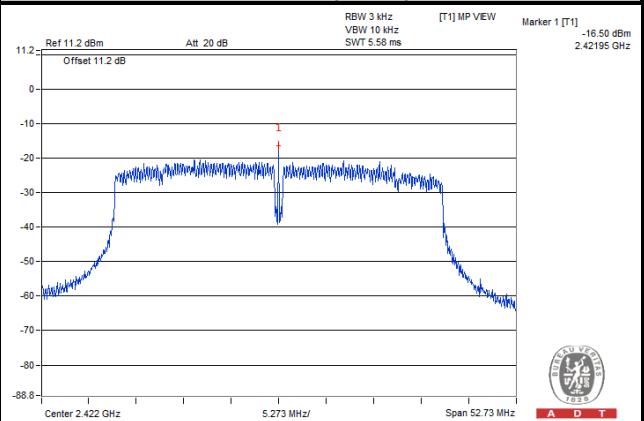

4.6 Conducted Out of Band Emission Measurement

4.6.1 Limits of Conducted Out of Band Emission Measurement

Below 20 dB of the highest emission level of operating band (in 100 kHz Resolution Bandwidth).

4.6.2 Test Setup

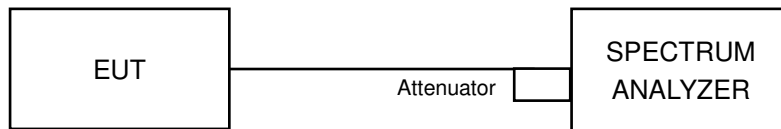

4.6.3 Test Instruments

Refer to section 4.1.2 to get information of above instrument.

4.6.4 Test Procedure

MEASUREMENT PROCEDURE REF

1. Set the RBW = 100 kHz.
2. Set the VBW \geq 300 kHz.
3. Detector = peak.
4. Sweep time = auto couple.
5. Trace mode = max hold.
6. Allow trace to fully stabilize.
7. Use the peak marker function to determine the maximum power level in any 100 kHz band segment within the fundamental EBW.

MEASUREMENT PROCEDURE OOB

1. Set RBW = 100 kHz.
2. Set VBW \geq 300 kHz.
3. Detector = peak.
4. Sweep = auto couple.
5. Trace Mode = max hold.
6. Allow trace to fully stabilize.
7. Use the peak marker function to determine the maximum amplitude level.

4.6.5 Deviation from Test Standard

No deviation.

4.6.6 EUT Operating Condition

The software provided by client to enable the EUT under transmission condition continuously at lowest, middle and highest channel frequencies individually.

4.6.7 Test Results

The spectrum plots are attached on the following images. D1 line indicates the highest level, and D2 line indicates the 20 dB offset below D1. It shows compliance with the requirement.

802.11b

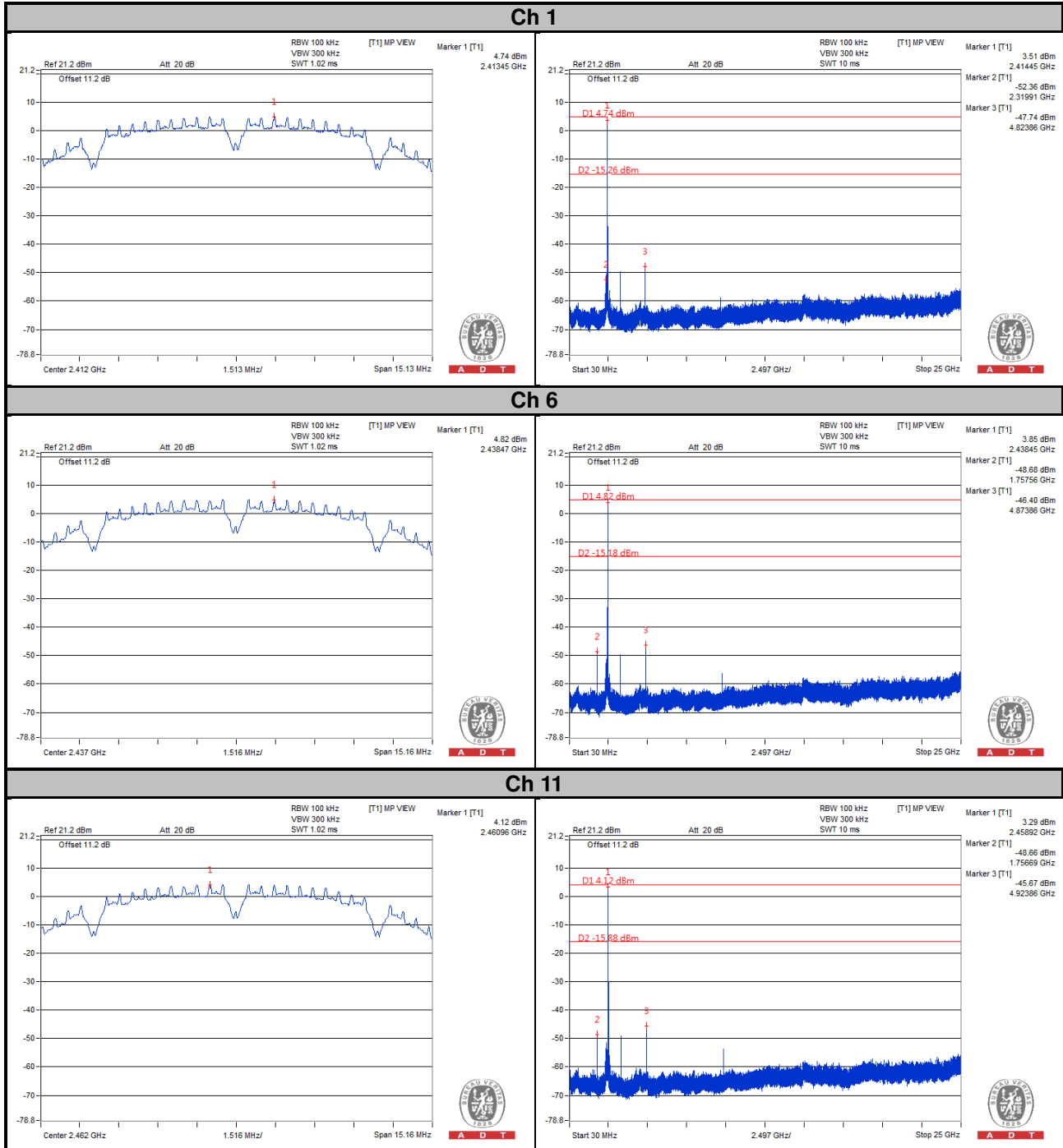

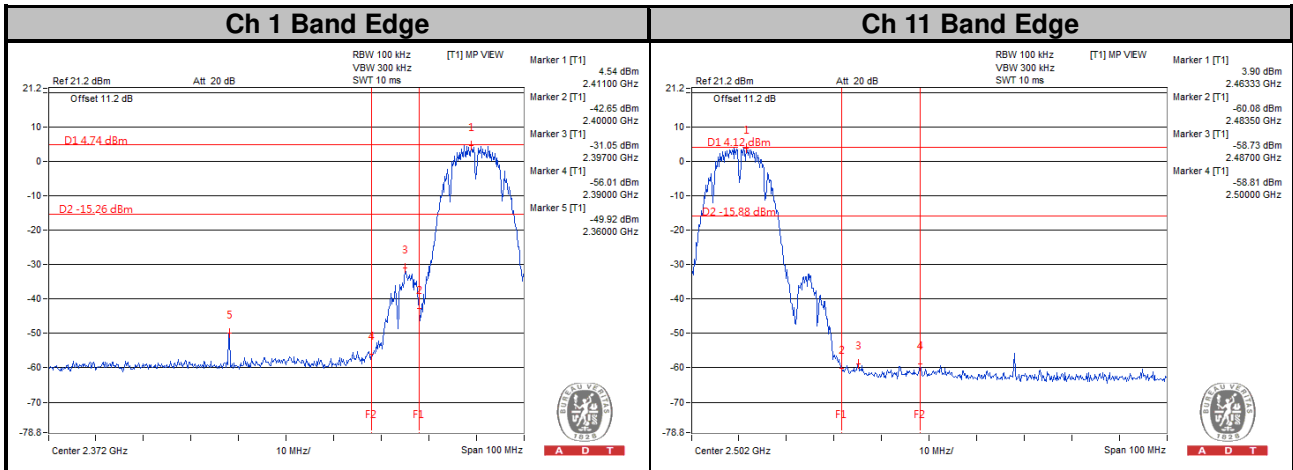

802.11g

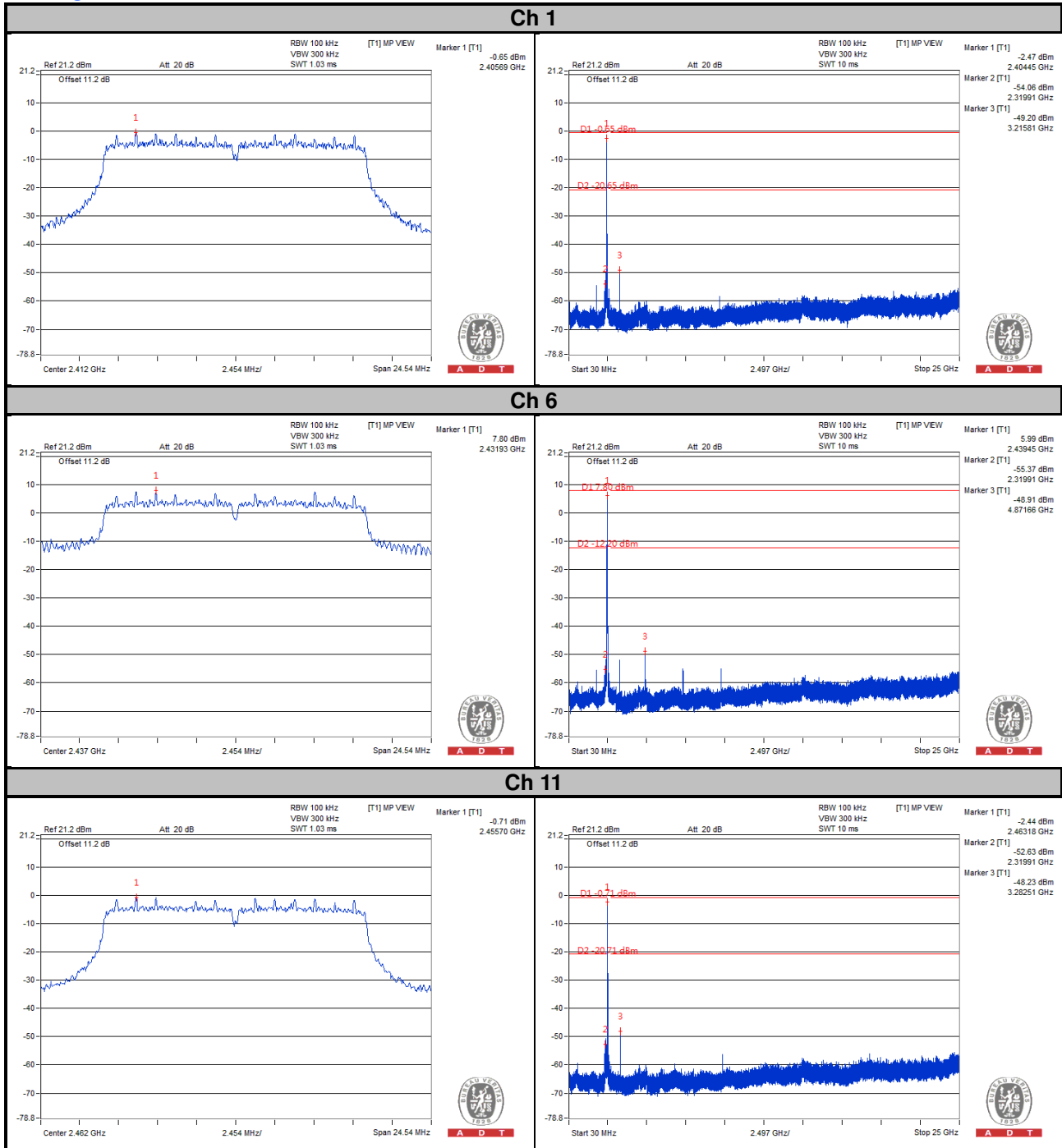

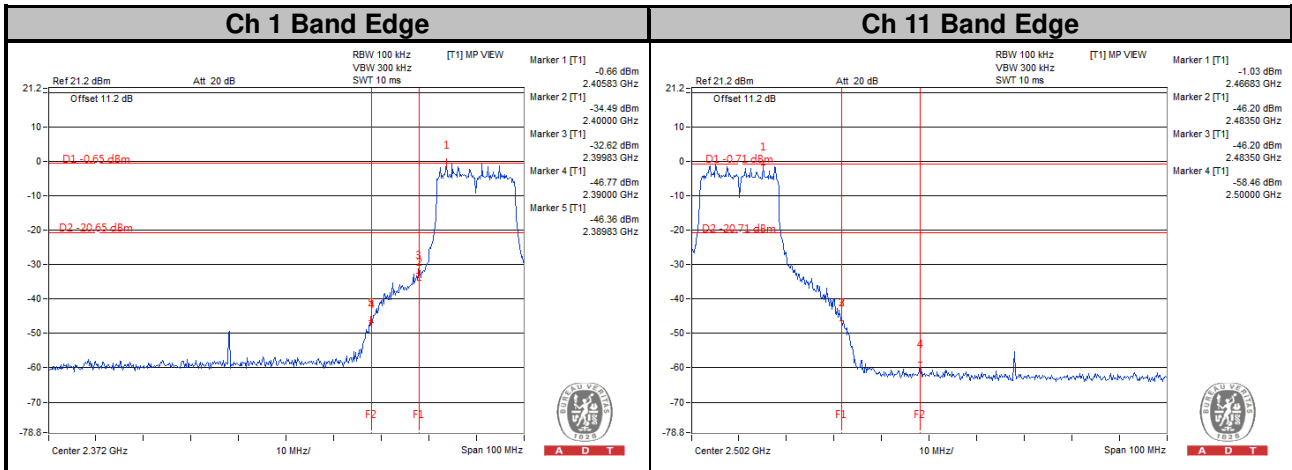

802.11n (HT20)

Ch 1

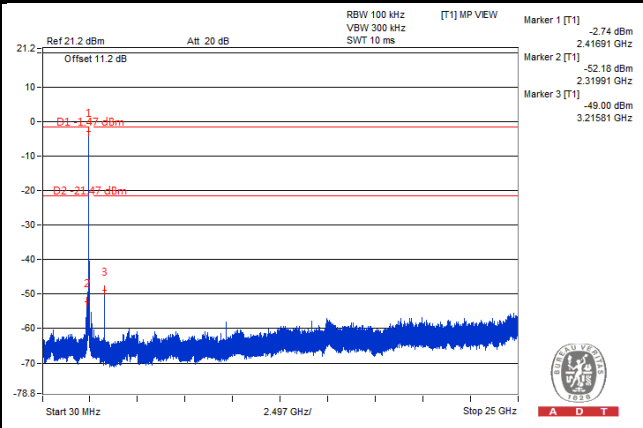
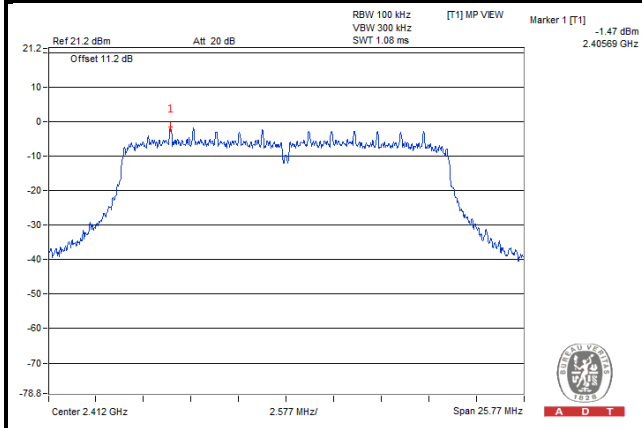

Ch 6

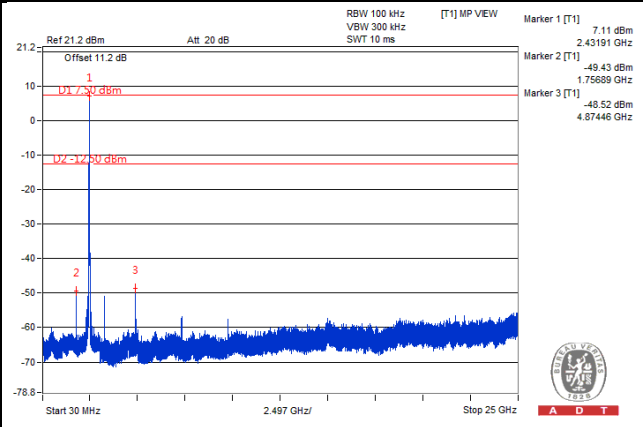
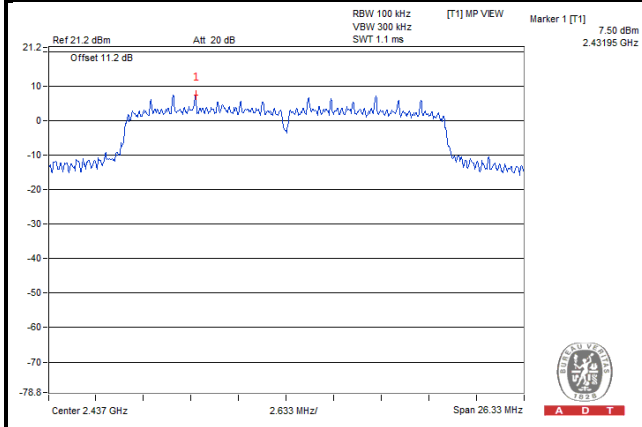

Ch 11

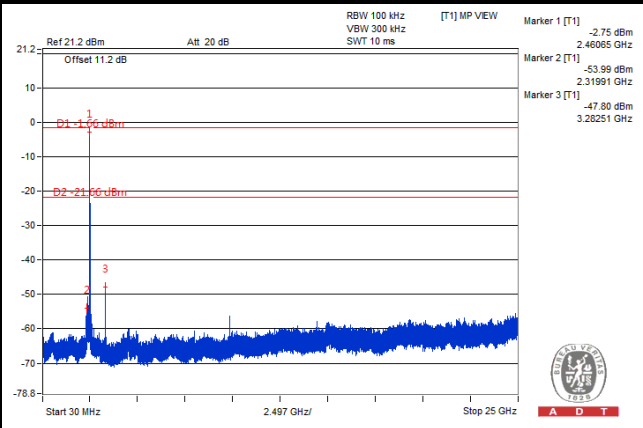
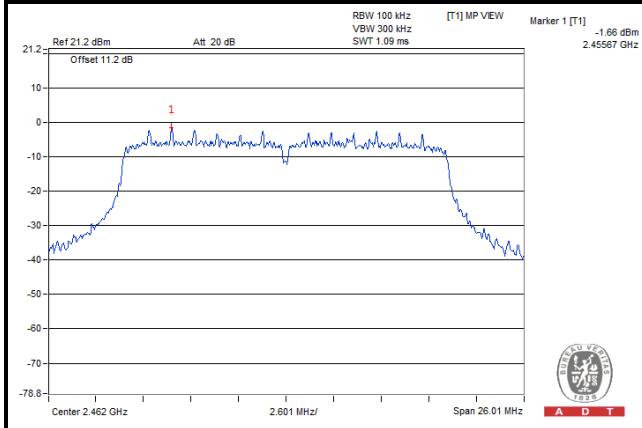

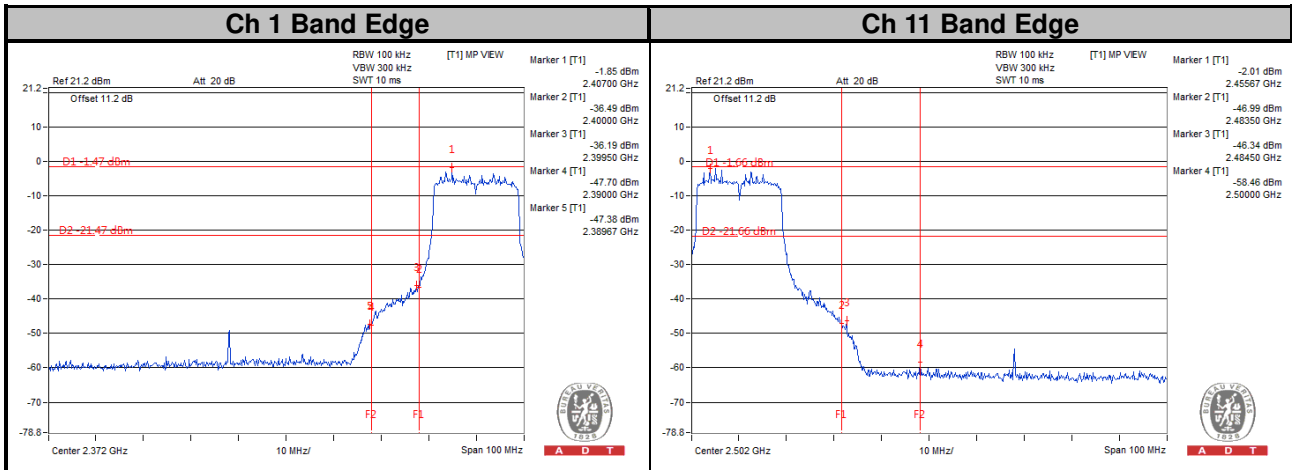

802.11n (HT40)

Ch 3

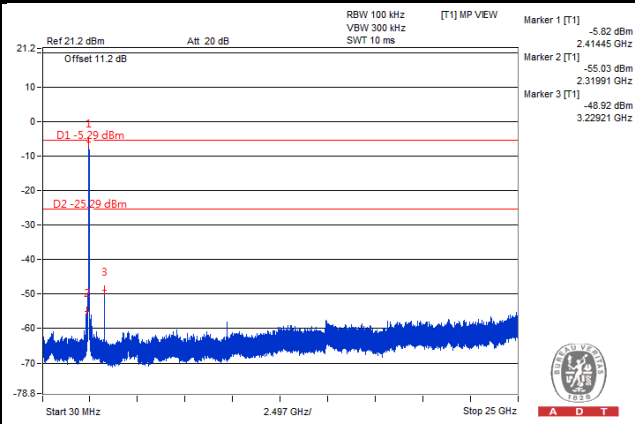
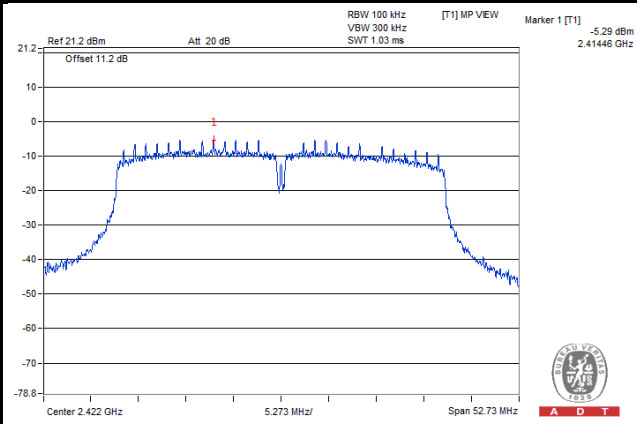

Ch 6

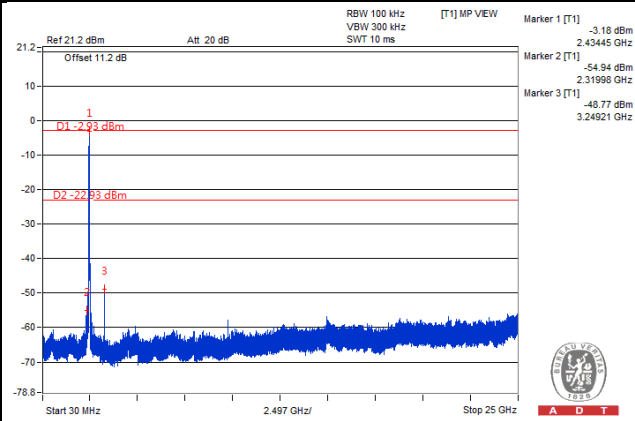
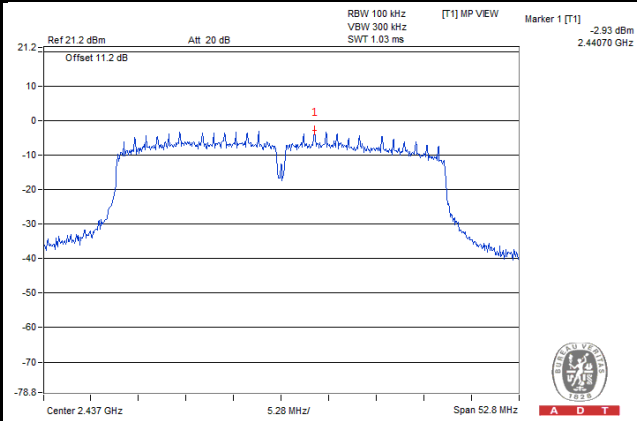

Ch 9

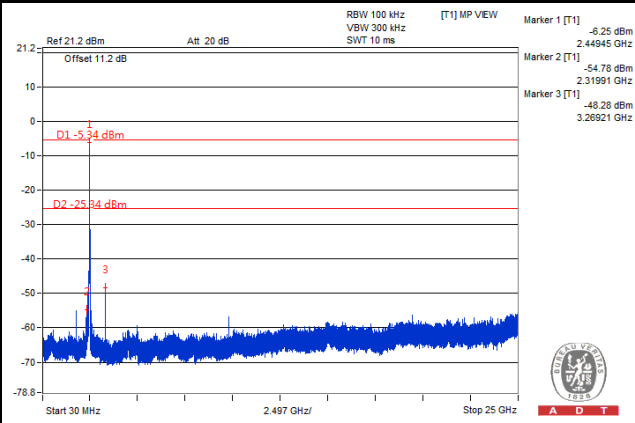
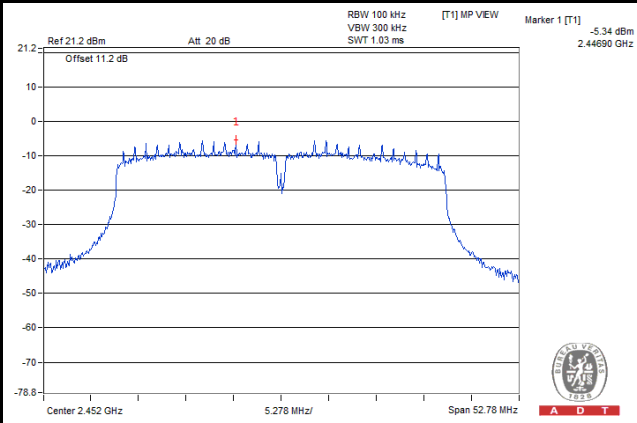

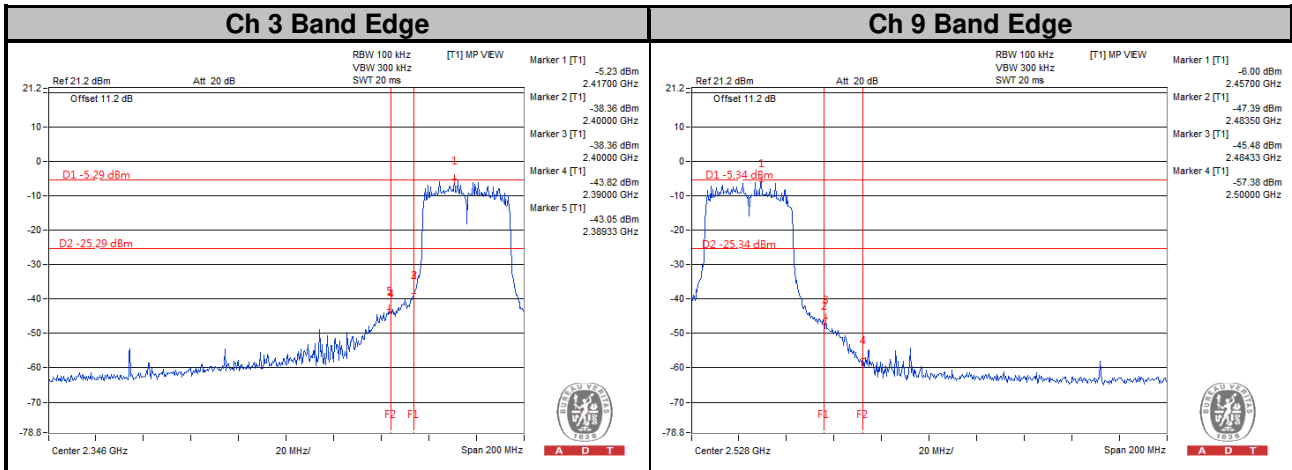



5 Pictures of Test Arrangements

Please refer to the attached file (Test Setup Photo).



A D T

Appendix – Information on the Testing Laboratories

We, Bureau Veritas Consumer Products Services (H.K.) Ltd., Taoyuan Branch, were founded in 1988 to provide our best service in EMC, Radio, Telecom and Safety consultation. Our laboratories are accredited and approved according to ISO/IEC 17025.

If you have any comments, please feel free to contact us at the following:

Linko EMC/RF Lab

Tel: 886-2-26052180

Fax: 886-2-26051924

Hsin Chu EMC/RF/Telecom Lab

Tel: 886-3-6668565

Fax: 886-3-6668323

Hwa Ya EMC/RF/Safety Lab

Tel: 886-3-3183232

Fax: 886-3-3270892

Email: service.adt@tw.bureauveritas.com

Web Site: www.bureauveritas-adt.com

The address and road map of all our labs can be found in our web site also.

--- END ---