



**RADIO TEST REPORT**

Report No: STS2112037W01

Issued for

Bartec USA LLC.

44231 Phoenix Drive, Sterling Heights, Michigan 48314,  
United States

<b>Product Name:</b>	Rite Sensor
<b>Brand Name:</b>	Bartec
<b>Model Name:</b>	RS-2000
<b>Series Model:</b>	N/A
<b>FCC ID:</b>	SX8-RS2000
<b>Test Standard:</b>	FCC Part 15.231

Any reproduction of this document must be done in full. No single part of this document may be reproduced without permission from STS, all test data presented in this report is only applicable to presented test sample.





TEST REPORT CERTIFICATION

Applicant's Name ..... Bartec USA LLC.
Address..... 44231 Phoenix Drive, Sterling Heights, Michigan 48314, United States
Manufacturer's Name ..... Bartec USA LLC.
Address..... 44231 Phoenix Drive, Sterling Heights, Michigan 48314, United States

Product Description

Product Name ..... Rite Sensor
Brand Name..... Bartec
Model Name..... RS-2000
Series Model ..... N/A
Test Standards..... FCC Part 15.231
Test Procedure..... ANSI C63.10-2013

This device described above has been tested by STS, the test results show that the equipment under test (EUT) is in compliance with the FCC requirements. And it is applicable only to the tested sample identified in the report.

This report shall not be reproduced except in full, without the written approval of STS, this document only be altered or revised by STS, personal only, and shall be noted in the revision of the document.

Date of Test.....
Date of Receipt of Test Item ...: 06 Dec. 2021
Date of performance of tests ...: 06 Dec. 2021 ~ 21 Dec. 2021
Date of Issue..... 21 Dec. 2021
Test Result ..... Pass

Testing Engineer : [Signature]
(Chris Chen)

Technical Manager : [Signature]
(Sean she)

Authorized Signatory : [Signature]
(Vita Li)

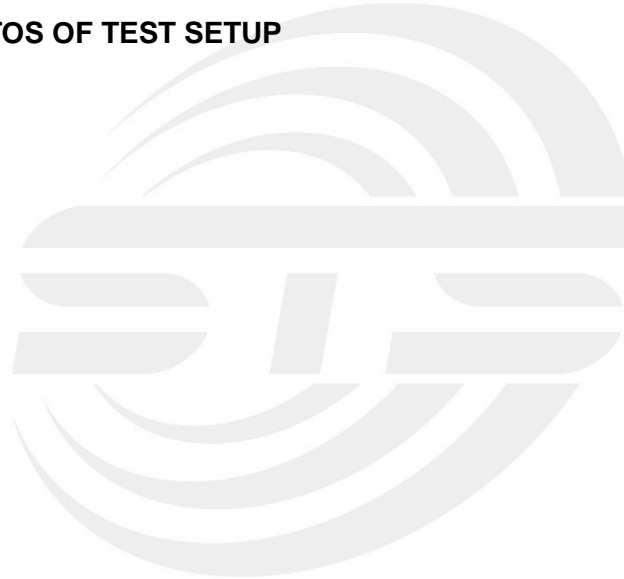



TABLE OF CONTENTS	Page
<b>1. SUMMARY OF TEST RESULTS</b>	<b>6</b>
1.1 TEST FACTORY	6
1.2 MEASUREMENT UNCERTAINTY	6
<b>2. GENERAL INFORMATION</b>	<b>7</b>
2.1 GENERAL DESCRIPTION OF THE EUT	7
2.2 DESCRIPTION OF THE TEST MODES	8
2.3 BLOCK DIAGRAM SHOWING THE CONFIGURATION OF SYSTEM TESTED	8
2.4 DESCRIPTION OF NECESSARY ACCESSORIES AND SUPPORT UNITS	9
2.5 EQUIPMENTS LIST	10
<b>3. EMC EMISSION TEST</b>	<b>11</b>
3.1 CONDUCTED EMISSION MEASUREMENT	11
3.2 TEST PROCEDURE	12
3.3 TEST SETUP	12
3.4 TEST RESULTS	12
<b>4. RADIATED EMISSION MEASUREMENT</b>	<b>13</b>
4.1 RADIATED EMISSION LIMITS	13
4.2 TEST PROCEDURE	15
4.3 DEVIATION FROM TEST STANDARD	15
4.4 TEST SETUP	16
4.5 EUT OPERATING CONDITIONS	17
4.6 TEST RESULTS	17
4.7 FIELD STRENGTH CALCULATION	18
4.8 TEST RESULTS (EMISSION)	18
<b>5. BANDWIDTH TEST</b>	<b>29</b>
5.1 LIMIT	29
5.2 TEST REQUIREMENTS	29
5.3 TEST PROCEDURE	29
5.4 TEST SETUP	29
5.5 EUT OPERATION CONDITIONS	29
5.6 TEST RESULTS	30
<b>6. TRANSMITTER TIMEOUT</b>	<b>34</b>
6.1 LIMIT	34
6.2 TEST PROCEDURE	34
6.3 TEST SETUP	34



TABLE OF CONTENTS	Page
6.4 TEST RESULTS	35
<b>7. PERIODIC OPERATION</b>	<b>39</b>
7.1 TEST PROCEDURE	39
7.2 TEST SETUP	39
7.3 EUT OPERATION CONDITIONS	39
7.4 TEST RESULTS	40
<b>8. ANTENNA REQUIREMENT</b>	<b>48</b>
8.1 STANDARD REQUIREMENT	48
8.2 EUT ANTENNA	48
<b>APPENDIX 1-PHOTOS OF TEST SETUP</b>	<b>49</b>





**Revision History**

Rev.	Issue Date	Report NO.	Effect Page	Contents
00	21 Dec. 2021	STS2112037W01	ALL	Initial Issue





## 1. SUMMARY OF TEST RESULTS

Test procedures according to the technical standards:

FCC Part 15.231, Subpart C			
Standard Section	Test Item	Judgment	Remark
15.207	Conducted Emission	N/A	--
15.205(a)/15.209/ 15.231(e)	Radiated Spurious Emission	PASS	--
15.231(e)	Transmission requirement	PASS	--
15.231(C)	20 dB Bandwidth	PASS	--
15.203	Antenna Requirement	PASS	--

NOTE: (1) "N/A" denotes test is not applicable in this Test Report.

(2) All tests are according to ANSI C63.10-2013.

### 1.1 TEST FACTORY

SHENZHEN STS TEST SERVICES CO., LTD

Add. : A 1/F, Building B, Zhuoke Science Park, No.190 Chongqing Road, HepingShequ, Fuyong Sub-District, Bao'an District, Shenzhen, Guang Dong, China

FCC test Firm Registration Number: 625569

IC test Firm Registration Number: 12108A

A2LA Certificate No.: 4338.01

### 1.2 MEASUREMENT UNCERTAINTY

The reported uncertainty of measurement  $y \pm U$ , where expanded uncertainty  $U$  is based on a standard uncertainty multiplied by a coverage factor of  $k=2$ , providing a level of confidence of approximately **95** %.

No.	Item	Uncertainty
1	RF output power, conducted	$\pm 0.87$ dB
2	Unwanted Emissions, conducted	$\pm 2.895$ dB
3	All emissions, radiated 9K-30MHz	$\pm 3.80$ dB
4	All emissions, radiated 30M-1GHz	$\pm 4.09$ dB
5	All emissions, radiated 1G-6GHz	$\pm 4.92$ dB
6	All emissions, radiated >6G	$\pm 5.49$ dB
7	Conducted Emission (9KHz-30MHz)	$\pm 2.73$ dB



## 2. GENERAL INFORMATION

### 2.1 GENERAL DESCRIPTION OF THE EUT

Product Name	Rite Sensor								
Trade Name	Bartec								
Model Name	RS-2000								
Series Model	N/A								
Model Difference	N/A								
Product Description	<p>The EUT is a Rite Sensor</p> <table border="1"><tr><td>Operation Frequency:</td><td>315MHz, 433.92MHz</td></tr><tr><td>Modulation Type:</td><td>ASK, FSK</td></tr><tr><td>Antenna Designation:</td><td>Internal Antenna</td></tr><tr><td>Antenna Gain(Peak)</td><td>2 dBi</td></tr></table> <p>More details of EUT technical specification, please refer to the User Manual.</p>	Operation Frequency:	315MHz, 433.92MHz	Modulation Type:	ASK, FSK	Antenna Designation:	Internal Antenna	Antenna Gain(Peak)	2 dBi
Operation Frequency:	315MHz, 433.92MHz								
Modulation Type:	ASK, FSK								
Antenna Designation:	Internal Antenna								
Antenna Gain(Peak)	2 dBi								
Battery	Rated Voltage: 3V Capacity: 345mAh								
Hardware version number	V0.0.1								
Software version number	V1.0								
Connecting I/O Port(s)	Please refer to Note 1.								

Note:

1. For a more detailed features description, please refer to the manufacturer's specifications or the User Manual.

2. Table for filed Antenna

Ant.	Brand	Model Name	Antenna Type	Connector	Gain (dBi)	NOTE
1	Bartec	RS-2000	Internal	N/A	2	Antenna



## 2.2 DESCRIPTION OF THE TEST MODES

To investigate the maximum EMI emission characteristics generates from EUT, the test system was pre-scanning tested base on the consideration of following EUT operation mode or test configuration mode which possible have effect on EMI emission level. Each of these EUT operation mode(s) or test configuration mode(s) mentioned above was evaluated respectively.

Pretest Mode	Description
Mode 1	TX Mode(315MHz, ASK)
Mode 2	TX Mode(315MHz, FSK)
Mode 3	TX Mode(433.92MHz, ASK)
Mode 4	TX Mode(433.92MHz, FSK)

	For Radiated Emission
Final Test Mode	Description
Mode 1	TX Mode(315MHz, ASK)
Mode 2	TX Mode(315MHz, FSK)
Mode 3	TX Mode(433.92MHz, ASK)
Mode 4	TX Mode(433.92MHz, FSK)

Note:

(2)The measurements are performed at all Bit Rate of Transmitter, the worst data was reported

## 2.3 BLOCK DIAGRAM SHOWING THE CONFIGURATION OF SYSTEM TESTED

During testing channel & power controlling software provided by the customer was used to control the operating channel as well as the output power level. The RF output power selection is for the setting of RF output power expected by the customer and is going to be fixed on the firmware of the final end product power parameters

E-1  
EUT





### 2.4 DESCRIPTION OF NECESSARY ACCESSORIES AND SUPPORT UNITS

The EUT has been tested as an independent unit together with other necessary accessories or support units. The following support units or accessories were used to form a representative test configuration during the tests.

#### Necessary accessories

Item	Equipment	Mfr/Brand	Model/Type No.	Series No.	Note
N/A	N/A	N/A	N/A	N/A	N/A

#### Support units

Item	Equipment	Mfr/Brand	Model/Type No.	Series No.	Note
N/A	N/A	N/A	N/A	N/A	N/A

Note:

(1) For detachable type I/O cable should be specified the length in cm in 『Length』 column.



## 2.5 EQUIPMENTS LIST

## Radiation Test equipment

Kind of Equipment	Manufacturer	Type No.	Serial No.	Last calibration	Calibrated until
Test Receiver	R&S	ESCI	101427	2021.09.30	2022.09.29
Signal Analyzer	R&S	FSV 40-N	101823	2021.09.30	2022.09.29
Active loop Antenna	ZHINAN	ZN30900C	16035	2021.04.11	2023.04.10
Bilog Antenna	TESEQ	CBL6111D	34678	2020.10.12	2022.10.11
Horn Antenna	SCHWARZBECK	BBHA 9120D	02014	2021.10.11	2023.10.10
SHF-EHF Horn Antenna (18G-40GHz)	A-INFO	LB-180400-KF	J211020657	2020.10.12	2022.10.11
Pre-Amplifier(0.1M-3 GHz)	EM	EM330	060665	2021.10.08	2022.10.07
Pre-Amplifier (1G-18GHz)	SKET	LNPA-01018G-45	SK2018080901	2021.09.30	2022.09.29
Pre-Amplifier (18G-40GHz)	SKET	LNPA-1840-50	SK2018101801	2021.09.28	2022.09.27
Temperature & Humidity	HH660	Mieo	N/A	2021.10.09	2022.10.08
Turn table	EM	SC100_1	60531	N/A	N/A
Antenna mast	EM	SC100	N/A	N/A	N/A
Test SW	FARAD	EZ-EMC(Ver.STSLAB-03A1 RE)			

## RF Connected Test

Kind of Equipment	Manufacturer	Type No.	Serial No.	Last calibration	Calibrated until
Power Sensor	Keysight	U2021XA	MY55520005	2021.09.30	2022.09.29
			MY55520006	2021.09.30	2022.09.29
			MY56120038	2021.09.30	2022.09.29
			MY56280002	2021.09.30	2022.09.29
Signal Analyzer	Agilent	N9020A	MY51110105	2021.03.04	2022.03.03
Temperature & Humidity	HH660	Mieo	N/A	2021.10.09	2022.10.08
Test SW	FARAD	EZ-EMC(Ver.STSLAB-03A1 RE)			



### 3. EMC EMISSION TEST

#### 3.1 CONDUCTED EMISSION MEASUREMENT

##### 3.1.1 POWER LINE CONDUCTED EMISSION LIMITS

The radio frequency voltage that is conducted back onto the AC power line on any frequency or frequencies, within the band 150 kHz to 30 MHz, shall not exceed the limits in the following table.

FREQUENCY (MHz)	Class B (dBuV)		Standard
	Quasi-peak	Average	
0.15 -0.5	66 - 56 *	56 - 46 *	CISPR
0.50 -5.0	56.00	46.00	CISPR
5.0 -30.0	60.00	50.00	CISPR

0.15 -0.5	66 - 56 *	56 - 46 *	FCC
0.50 -5.0	56.00	46.00	FCC
5.0 -30.0	60.00	50.00	FCC

Note:

(1) The tighter limit applies at the band edges.

(2) The limit of " \* " marked band means the limitation decreases linearly with the logarithm of the frequency in the range.

The following table is the setting of the receiver

Receiver Parameters	Setting
Attenuation	10 dB
Start Frequency	0.15 MHz
Stop Frequency	30 MHz
IF Bandwidth	9 kHz

### 3.2 TEST PROCEDURE

- a. The EUT is 0.8 m from the horizontal ground plane and 0.4 m from the vertical ground plane with EUT being connected to the power mains through a line impedance stabilization network (LISN). All other support equipments are powered from additional LISN(s). The LISN provides 50 Ohm/ 50uH of coupling impedance for the measuring instrument.
- b. Interconnecting cables that hang closer than 40 cm to the ground plane shall be folded back and forth in the center forming a bundle 30 to 40 cm long.
- c. I/O cables that are not connected to a peripheral shall be bundled in the center. The end of the cable may be terminated, if required, using the correct terminating impedance. The overall length shall not exceed 1 m.
- d. LISN at least 80 cm from nearest part of EUT chassis.
- e. For the actual test configuration, please refer to the related Item –EUT Test Photos.

### 3.3 TEST SETUP

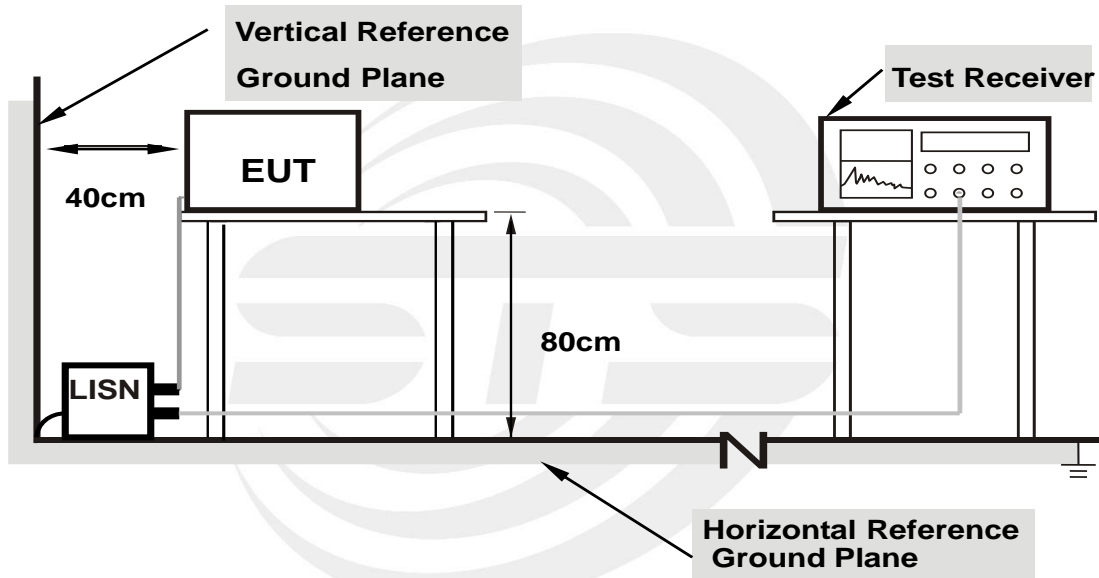

- Note: 1. Support units were connected to second LISN.**  
**2. Both of LISNs (AMN) are 80 cm from EUT and at least 80 cm from other units and other metal planes support units.**

### 3.4 TEST RESULTS

Temperature:	N/A	Relative Humidity:	N/A
Phase:	L/N	Test Mode:	N/A

Note: EUT is only power by battery, So it is not applicable for this test.



## 4. RADIATED EMISSION MEASUREMENT

### 4.1 RADIATED EMISSION LIMITS

In case the emission fall within the restricted band specified on Part 15.205(a), then the Part 15.209(a), Part 15.231(e) limit in the table below has to be followed.

#### LIMITS OF RADIATED EMISSION MEASUREMENT (0.009MHz - 1000MHz)

Frequencies (MHz)	Field Strength (microvolts/meter)	Measurement Distance (meters)
0.009~0.490	2400/F(KHz)	300
0.490~1.705	24000/F(KHz)	30
1.705~30.0	30	30
30~40.66	100	3

Fundamental Frequency (MHz)	Field Strength of fundamental (microvolts/meter)	Field Strength of Unwanted Emissions (microvolts/meter)
40.66 - 40.70	1,000	100
70 - 130	500	50
130 - 174	500 to 1,500 **	50 to 1,50 **
174 - 260	1,500	1,50
260 - 470	1,500 to 5,000 **	1,50 to 5,00 **
Above 470	5,000	5,00

#### LIMITS OF RADIATED EMISSION MEASUREMENT (Above 1000MHz)

FREQUENCY (MHz)	Class B (dBuV/m) (at 3M)	
	PEAK	AVERAGE
Above 1000	74	54

NOTE:\*\* linear interpolations

[Where F is the frequency in MHz, the formulas for calculating the maximum permitted fundamental

field strengths are as follows: for the band 130-174 MHz,  $\mu\text{V/m}$  at 3 meters =  $22.72727(F) - 2454.545$ ; for the band 260-470 MHz,  $\mu\text{V/m}$  at 3 meters =  $16.6667(F) - 2833.3333$ . The maximum permitted unwanted emission level is 20 dB below the maximum permitted fundamental level.]

The limits on the field strength of the spurious emissions in the above table are based on the fundamental frequency of the intentional radiator. Spurious emissions shall be attenuated to the average (or, alternatively, CISPR quasi-peak) limits shown in this table or to the general limits shown in 93 Section 15.209, whichever limit permits a higher field strength.



LIMITS OF RESTRICTED FREQUENCY BANDS

FREQUENCY (MHz)	FREQUENCY (MHz)	FREQUENCY (MHz)	FREQUENCY (GHz)
0.090-0.110	16.42-16.423	399.9-410	4.5-5.15
0.495-0.505	16.69475-16.69525	608-614	5.35-5.46
2.1735-2.1905	16.80425-16.80475	960-1240	7.25-7.75
4.125-4.128	25.5-25.67	1300-1427	8.025-8.5
4.17725-4.17775	37.5-38.25	1435-1626.5	9.0-9.2
4.20725-4.20775	73-74.6	1645.5-1646.5	9.3-9.5
6.215-6.218	74.8-75.2	1660-1710	10.6-12.7
6.26775-6.26825	108-121.94	1718.8-1722.2	13.25-13.4
6.31175-6.31225	123-138	2200-2300	14.47-14.5
8.291-8.294	149.9-150.05	2310-2390	15.35-16.2
8.362-8.366	156.52475-156.52525	2483.5-2500	17.7-21.4
8.37625-8.38675	156.7-156.9	2690-2900	22.01-23.12
8.41425-8.41475	162.0125-167.17	3260-3267	23.6-24.0
12.29-12.293	167.72-173.2	3332-3339	31.2-31.8
12.51975-12.52025	240-285	3345.8-3358	36.43-36.5
12.57675-12.57725	322-335.4	3600-4400	Above 38.6
13.36-13.41			

Spectrum Parameter	Setting
Detector	Peak
Attenuation	Auto
Start Frequency	1000 MHz
Stop Frequency	10th carrier harmonic
RB / VB (emission in restricted band)	1MHz / 3MHz

Receiver Parameter	Setting
Attenuation	Auto
Start ~ Stop Frequency	9kHz~90kHz / RB 200Hz for PK & AV
Start ~ Stop Frequency	90kHz~110kHz / RB 200Hz for QP
Start ~ Stop Frequency	110kHz~490kHz / RB 200Hz for PK & AV
Start ~ Stop Frequency	490kHz~30MHz / RB 9kHz for QP
Start ~ Stop Frequency	30MHz~1000MHz / RB 120kHz for QP



## 4.2 TEST PROCEDURE

- a. The test is performed in a 3m Semi-Anechoic Chamber; the antenna factor, cable loss and so on of the site (factors) is calculated to correct the reading. The EUT is placed on a 0.8m high insulating Turn Table, and keeps 3m away from the Test Antenna, which is mounted on a variable-height antenna master tower.  
During test, The table was rotated 360 degrees to determine the position of the highest radiation.
- b. In the frequency range of 9KHz to 30MHz, magnetic field is measured with Loop Test Antenna. The Test Antenna is positioned with its plane vertical at 1m distance from the EUT. The center of the Loop Test Antenna is 1m above the ground. During the measurement the Loop Test Antenna rotates about its vertical axis for maximum response at each azimuth about the EUT.
- c. In the frequency range 30MHz-1GHz, Bi-Log Test Antenna used. Test Antenna is 3m away from the EUT. Test Antenna height is varied from 1m to 4m above the ground to determine the maximum value of the field strength. The emission levels at both horizontal and vertical polarizations should be tested.
- d. In the frequency above 1GHz, Place the measurement antenna 3m away from the EUT for each area of the EUT determined to be a source of emissions at the specified measurement distance, while keeping the measurement antenna aimed at the source of emissions at each frequency of significant emissions, with polarization oriented for maximum response. The measurement antenna elevation for maximum emissions shall be restricted to a range of heights of from 1 m to 4 m above the ground or reference ground plane.
- f. The initial step in collecting conducted emission data is a spectrum analyzer peak detector mode pre-scanning the measurement frequency range. Significant peaks are then marked and then Quasi Peak detector mode re-measured.
- g. If the Peak Mode measured value compliance with and lower than Quasi Peak Mode Limit, the EUT shall be deemed to meet QP Limits and then no additional QP Mode measurement performed.
- h. For the actual test configuration, please refer to the related Item –EUT Test Photos.  
Note: Both horizontal and vertical antenna polarities were tested and performed pretest to three orthogonal axis. The worst case emissions were reported

## 4.3 DEVIATION FROM TEST STANDARD

No deviation

#### 4.4 TEST SETUP

##### (A) Radiated Emission Test-Up Frequency Below 30MHz

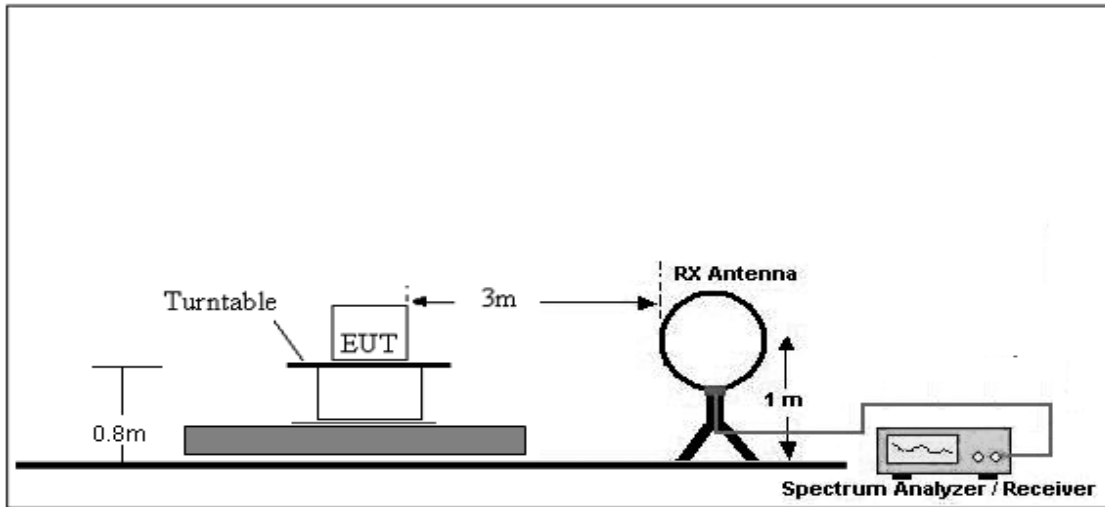

##### (B) Radiated Emission Test-Up Frequency 30MHz~1GHz

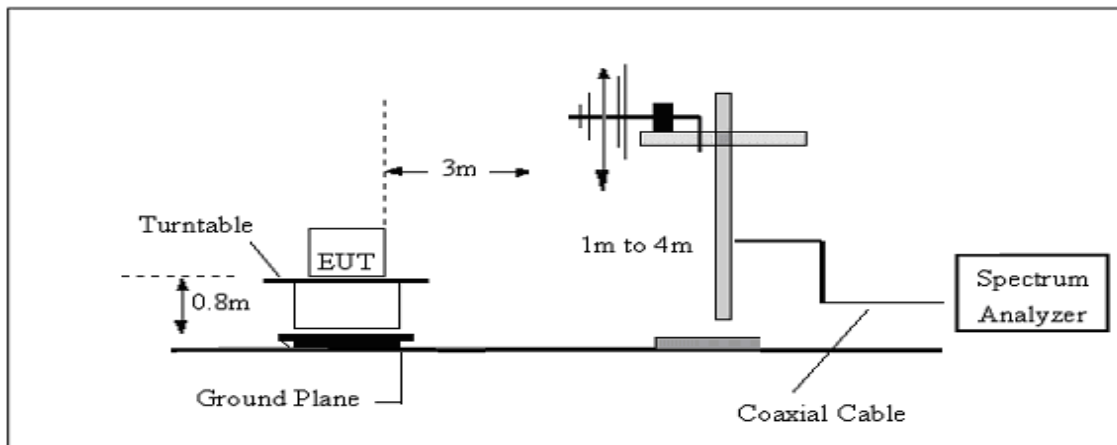

##### (C) Radiated Emission Test-Up Frequency Above 1GHz

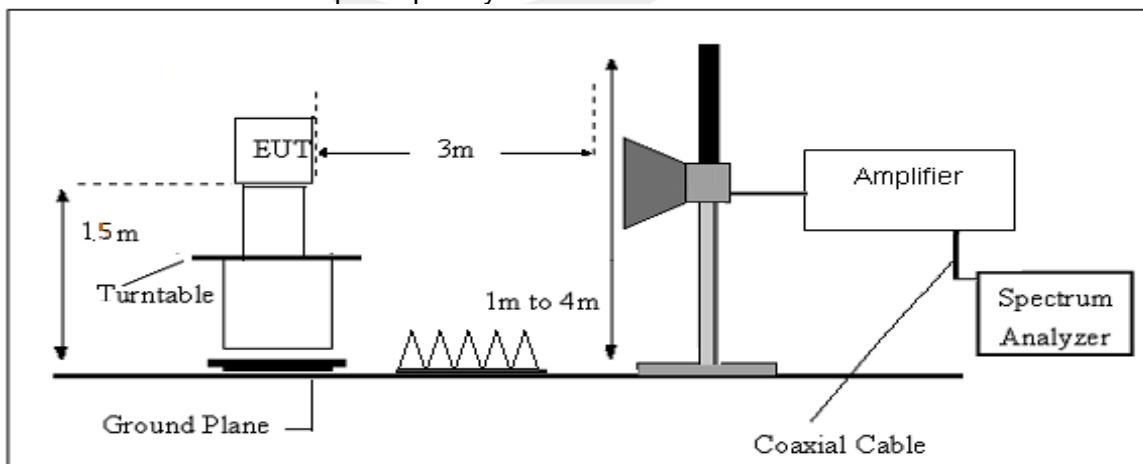



#### 4.5 EUT OPERATING CONDITIONS

The EUT tested system was configured as the statements of 2.4 Unless otherwise a special operating condition is specified in the follows during the testing.

#### 4.6 TEST RESULTS

##### INTRODUCTION TO PDCF

Reference: (§15.35 Measurement detector functions and bandwidths.)

- a. Part 15 of the FCC Rules provides for the operation of low power communication devices without an individual license (e.g., intrusion detectors, pulsed water tank level gauges, etc.), subject to certain requirements. Some of these devices use extremely narrow pulses to generate wideband emissions, which are measured to determine compliance with the rules. These measurements are typically performed with a receiver or spectrum analyzer. Depending on a number of factors (e.g., resolution bandwidth, pulsewidth, etc.), the spectrum analyzer may not always display the true peak value of the measured emission. This effect, called “pulse desensitization,” relates to the capabilities of the measuring instrument. For the measurement and reporting of the true peak of pulsed emissions, it may be necessary to apply a “pulse desensitization correction factor” (PDCF) to the measured value, pursuant to 47 CFR 15.35(a).

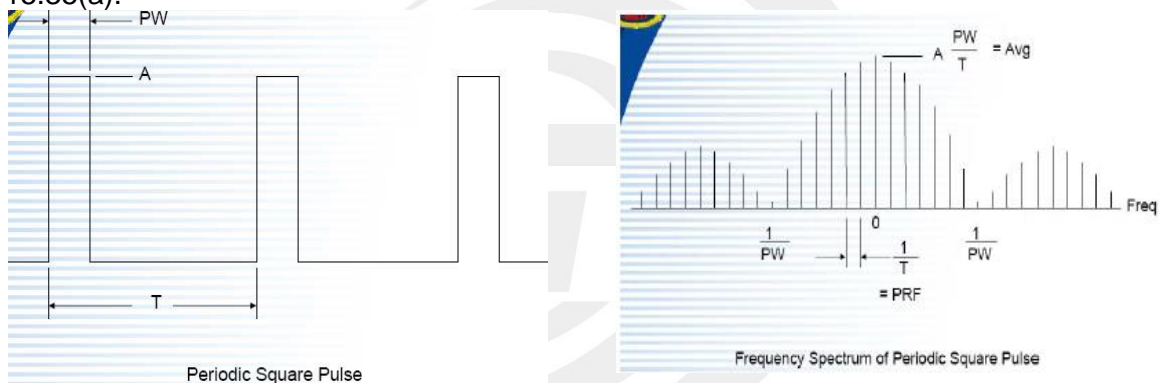

If using spectrum analyzer to measure pulse signal, it have to make sure the RBW use is at least  $2/PW$ .

•When RBW is less than  $2/PW$ , you are able to measure the true peak level of the pulse signal. If this is the case, PDCF is required to compensate to determine true peak value.

Pulse desensitization:

315MHz, ASK

PW =28800usec,Period=100000usec, Level=A

RBW>2/PW=0.069K , PRF=1/T=0.01K ,

315MHz, FSK

PW =29600usec,Period=100000usec, Level=A

RBW>2/PW=0.068K , PRF=1/T=0.01K ,

433.92MHz, ASK

PW =16730usec,Period=100000usec, Level=A

RBW>2/PW=0.1K , PRF=1/T=0.01K ,

433.92MHz, FSK

PW =17600usec,Period=100000usec, Level=A

RBW>2/PW=0.1K , PRF=1/T=0.01K

NOTE:  $2 / PW < RBW$ , first don't need

- b. For the actual test, please refer to the ANSI C63.10,Annex C refer to section 7 for more detail



#### 4.7 FIELD STRENGTH CALCULATION

The field strength is calculated by adding the Antenna Factor and Cable Factor and subtracting the Amplifier Gain and Duty Cycle Correction Factor (if any) from the measured reading. The basic equation with a sample calculation is as follows:

$$FS = RA + AF + CL - AG$$

Where

FS = Field Strength

CL = Cable Attenuation Factor (Cable Loss)

RA = Reading Amplitude

AG = Amplifier Gain

AF = Antenna Factor

For example

Frequency (MHz)	FS (dB $\mu$ V/m)	RA (dB $\mu$ V/m)	AF (dB)	CL (dB)	AG (dB)	Factor (dB)
300	40	58.1	12.2	1.6	31.9	-18.1

$$\text{Factor} = \text{AF} + \text{CL} - \text{AG}$$

#### 4.8 TEST RESULTS (EMISSION)

(Radiated Emission < 30MHz (9KHz-30MHz, H-field))

Temperature:	20 °C	Relative Humidity:	48%
Test Mode:	Mode 1	Polarization:	--

Freq. (MHz)	Reading (dBuV/m)	Limit (dBuV/m)	Margin (dB)	State P/F
--	--	--	--	PASS
--	--	--	--	PASS

Note: The amplitude of spurious emissions which are attenuated by more than 20dB below the permissible value has no need to be reported.

Distance extrapolation factor =  $40 \log(\text{specific distance}/\text{test distance})$ (dB);

Limit line = specific limits (dBuV) + distance extrapolation factor.



Between 30MHz – 5000 MHz

Temperature:	23.1℃	Relative Humidity:	60%
Phase:	Horizontal	Test Mode:	Mode 1

No.	Frequency (MHz)	Reading (dBuV)	Factor (dB)	Results (dBuV/m)	Limit (dBuV/m)	Margin (dB)	Detector
1	84.3200	46.58	-22.35	24.23	40.00	-15.77	peak
3	433.5200	32.36	-10.13	22.23	46.00	-23.77	peak
4	630.4300	39.59	-5.03	34.56	46.00	-11.44	peak
5	834.1300	27.27	-0.59	26.68	46.00	-19.32	peak
6	945.6800	43.05	1.50	44.55	46.00	-1.45	peak

Fundamental Frequency

No.	Frequency (MHz)	Reading (dBuV)	Correct Factor(dB/m)	Duty cycle Factor(dB)	Result (dBuV/m)	Limit (dBuV/m)	Margin (dB)	Remark
2	315.0000	88.66	-14.22	-	74.44	87.66	-13.22	Peak
7	315.0000	88.66	-14.22	10.81	63.63	67.66	-4.03	AVG

Remark:

- Margin = Result (Result =Reading + Factor) –Limit
- Factor= Antenna factor+Cable attenuation factor(cable loss)-Amplifier gain

100.0 dBuV/m

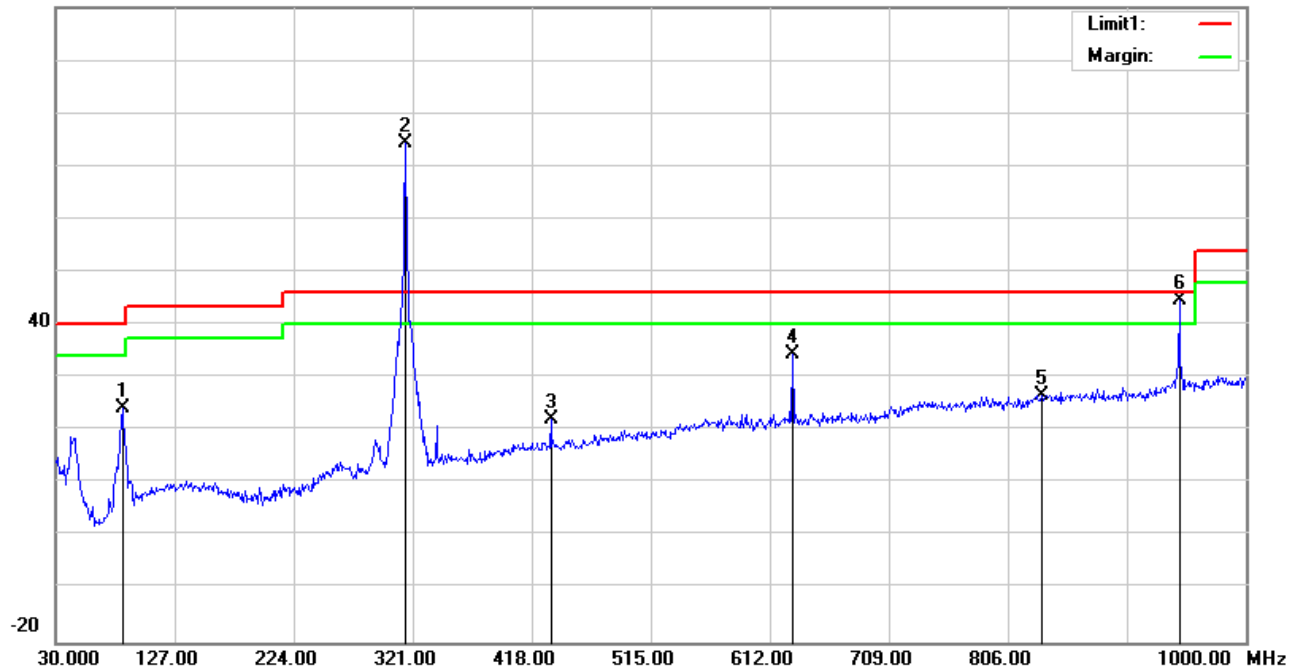



Temperature:	23.1°C	Relative Humidity:	60%
Phase:	Vertical	Test Mode:	Mode 1

No.	Frequency (MHz)	Reading (dBuV)	Factor (dB)	Results (dBuV/m)	Limit (dBuV/m)	Margin (dB)	Detector
1	84.3200	49.41	-22.35	27.06	40.00	-12.94	peak
3	402.4800	30.17	-11.00	19.17	46.00	-26.83	peak
4	630.4300	42.58	-5.03	37.55	46.00	-8.45	peak
5	856.4400	28.78	-0.53	28.25	46.00	-17.75	peak
6	945.6800	30.29	1.50	31.79	46.00	-14.21	peak

Fundamental Frequency

No.	Frequency (MHz)	Reading (dBuV)	Correct Factor(dB/m)	Duty cycle Factor(dB)	Result (dBuV/m)	Limit (dBuV/m)	Margin (dB)	Remark
2	315.0000	82.10	-14.22	-	68.88	87.66	-18.78	Peak
7	315.0000	82.10	-14.22	10.81	58.07	67.66	-9.59	AVG

Remark:

- Margin = Result (Result = Reading + Factor) - Limit
- Factor = Antenna factor + Cable attenuation factor (cable loss) - Amplifier gain

100.0 dBuV/m

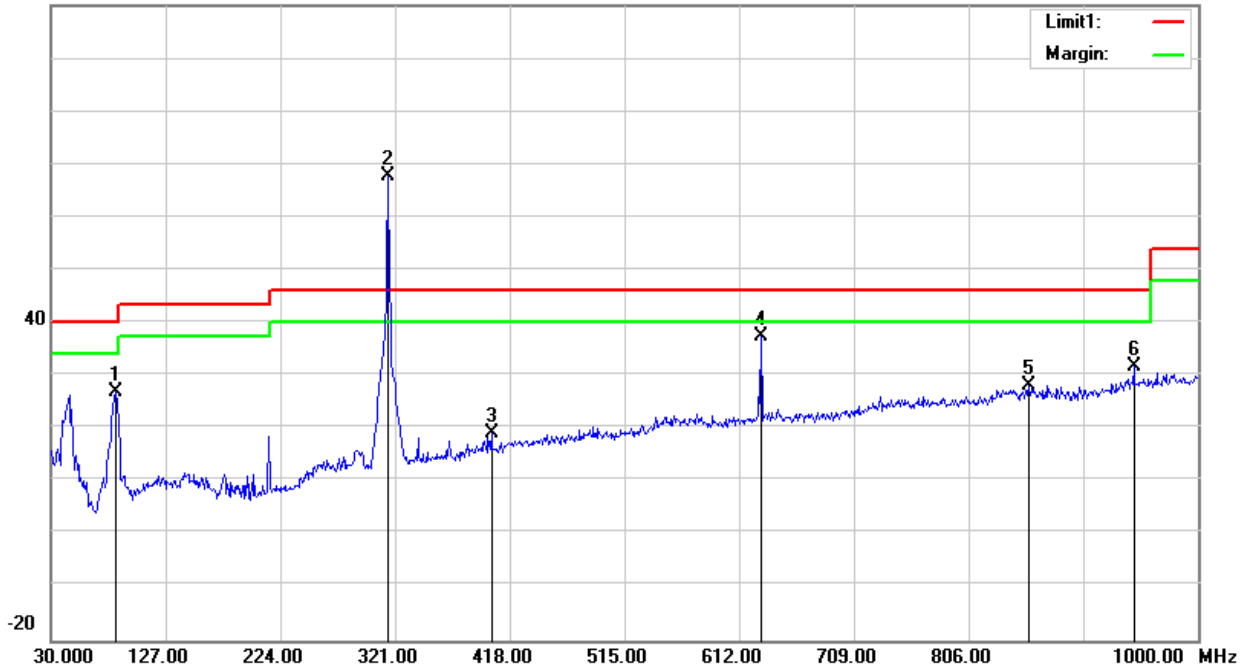



Temperature:	23.1 °C	Relative Humidity:	60%
Phase:	Horizontal	Test Mode:	Mode 2

No.	Frequency (MHz)	Reading (dBuV)	Factor (dB)	Results (dBuV/m)	Limit (dBuV/m)	Margin (dB)	Detector
1	45.5200	36.04	-20.91	15.13	40.00	-24.87	peak
2	444.1900	29.22	-9.92	19.30	46.00	-26.70	peak
4	630.4300	40.31	-5.03	35.28	46.00	-10.72	peak
5	880.6900	28.18	-0.66	27.52	46.00	-18.48	peak
6	945.6800	43.50	1.50	45.00	46.00	-1.00	peak

Fundamental Frequency

No.	Frequency (MHz)	Reading (dBuV)	Correct Factor(dB/m)	Duty cycle Factor(dB)	Result (dBuV/m)	Limit (dBuV/m)	Margin (dB)	Remark
3	315.0000	89.62	-14.22	-	75.40	87.66	-12.26	Peak
7	315.0000	89.62	-14.22	10.57	64.83	67.66	-2.83	AVG

Remark:

- Margin = Result (Result = Reading + Factor) - Limit
- Factor = Antenna factor + Cable attenuation factor (cable loss) - Amplifier gain

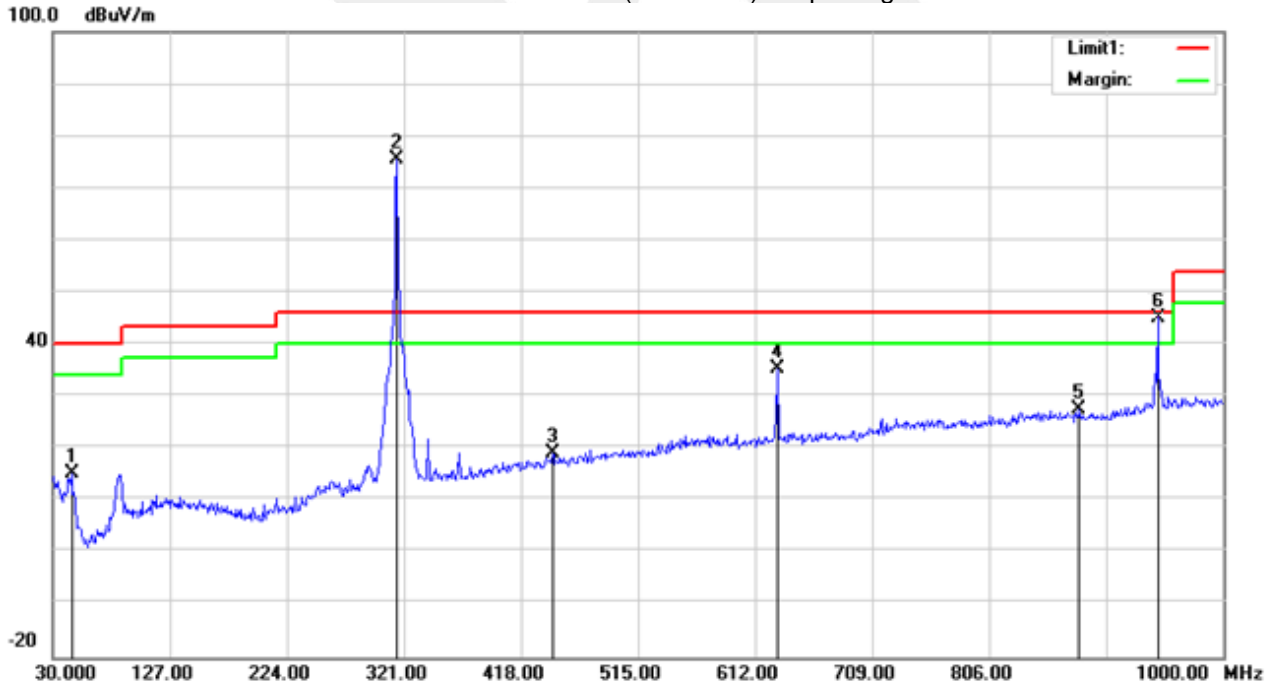



Temperature:	23.1°C	Relative Humidity:	60%
Phase:	Vertical	Test Mode:	Mode 2

No.	Frequency (MHz)	Reading (dBuV)	Factor (dB)	Results (dBuV/m)	Limit (dBuV/m)	Margin (dB)	Detector
1	85.2900	47.68	-22.13	25.55	40.00	-14.45	peak
3	488.8100	28.59	-8.27	20.32	46.00	-25.68	peak
4	630.4300	43.65	-5.03	38.62	46.00	-7.38	peak
5	837.0400	28.59	-0.46	28.13	46.00	-17.87	peak
6	945.6800	29.92	1.50	31.42	46.00	-14.58	peak

Fundamental Frequency

No.	Frequency (MHz)	Reading (dBuV)	Correct Factor(dB/m)	Duty cycle Factor(dB)	Result (dBuV/m)	Limit (dBuV/m)	Margin (dB)	Remark
2	315.0000	82.59	-14.22	-	68.37	87.66	-19.29	Peak
7	315.0000	82.59	-14.22	10.57	57.80	67.66	-9.86	AVG

Remark:

- Margin = Result (Result = Reading + Factor) - Limit
- Factor = Antenna factor + Cable attenuation factor (cable loss) - Amplifier gain

100.0 dBuV/m

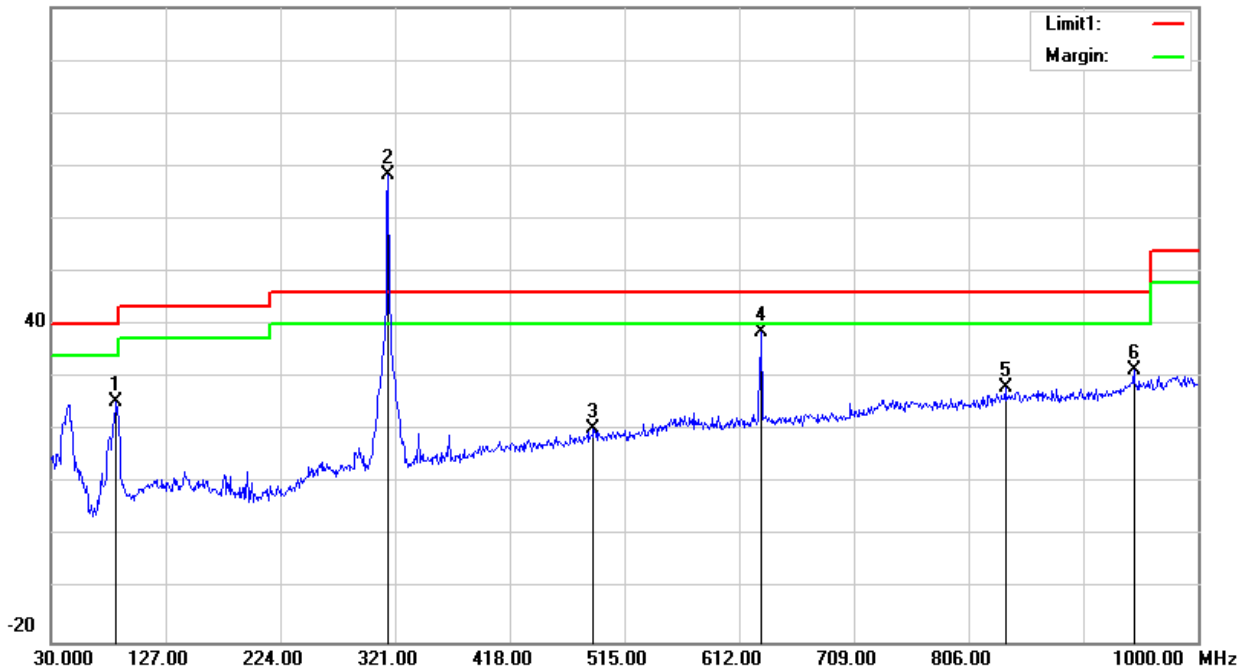



Temperature:	23.1 °C	Relative Humidity:	60%
Phase:	Horizontal	Test Mode:	Mode 3

No.	Frequency (MHz)	Reading (dBuV)	Factor (dB)	Results (dBuV/m)	Limit (dBuV/m)	Margin (dB)	Detector
1	85.2900	38.39	-22.13	16.26	40.00	-23.74	peak
2	315.1800	34.66	-14.22	20.44	46.00	-25.56	peak
4	669.2300	28.19	-4.60	23.59	46.00	-22.41	peak
5	868.0800	31.94	-0.51	31.43	46.00	-14.57	peak
6	994.1800	28.77	2.05	30.82	54.00	-23.18	peak

Fundamental Frequency

No.	Frequency (MHz)	Reading (dBuV)	Correct Factor(dB/m)	Duty cycle Factor(dB)	Result (dBuV/m)	Limit (dBuV/m)	Margin (dB)	Remark
3	433.9200	71.88	-10.13	-	61.75	92.87	-31.12	Peak

Remark:

- Margin = Result (Result = Reading + Factor) - Limit
- Factor = Antenna factor + Cable attenuation factor (cable loss) - Amplifier gain

100.0 dBuV/m

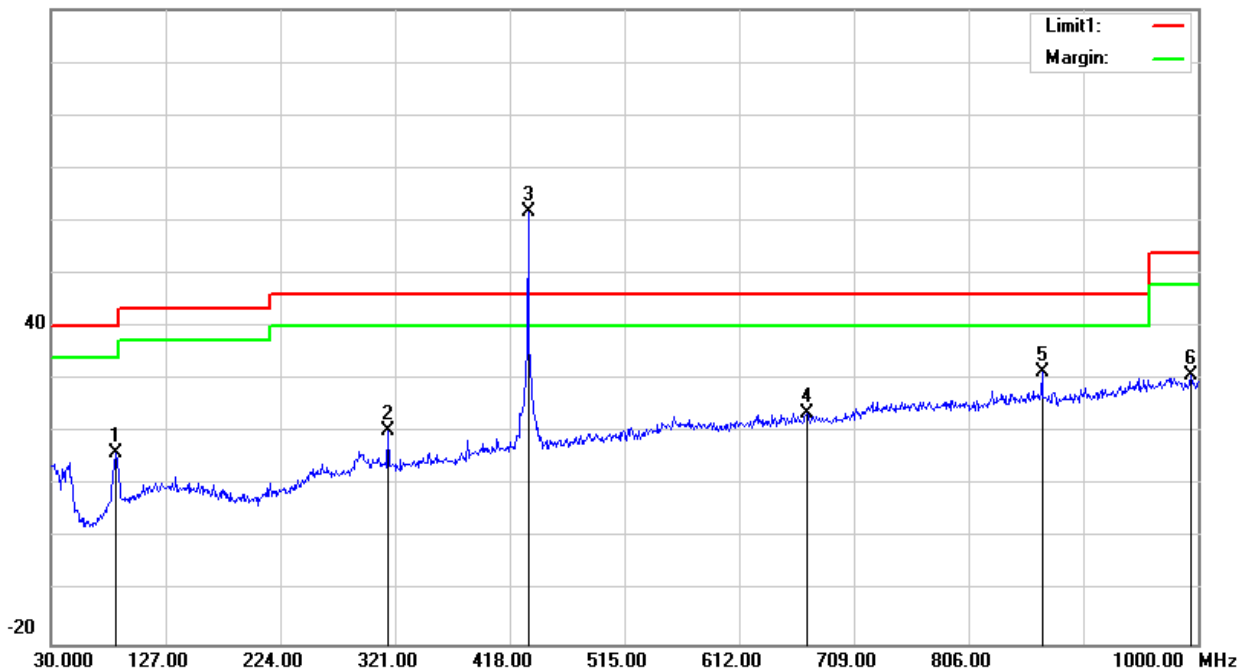



Temperature:	23.1°C	Relative Humidity:	60%
Phase:	Vertical	Test Mode:	Mode 3

No.	Frequency (MHz)	Reading (dBuV)	Factor (dB)	Results (dBuV/m)	Limit (dBuV/m)	Margin (dB)	Detector
1	83.3500	47.95	-22.52	25.43	40.00	-14.57	peak
2	288.9900	31.49	-15.21	16.28	46.00	-29.72	peak
4	532.4600	33.53	-7.31	26.22	46.00	-19.78	peak
5	842.8600	27.97	-0.46	27.51	46.00	-18.49	peak
6	977.6900	28.16	2.52	30.68	54.00	-23.32	peak

Fundamental Frequency

No.	Frequency (MHz)	Reading (dBuV)	Correct Factor(dB/m)	Duty cycle Factor(dB)	Result (dBuV/m)	Limit (dBuV/m)	Margin (dB)	Remark
3	433.9200	81.24	-10.13	-	71.11	92.87	-21.76	Peak

Remark:

- Margin = Result (Result = Reading + Factor) - Limit
- Factor = Antenna factor + Cable attenuation factor (cable loss) - Amplifier gain

100.0 dBuV/m

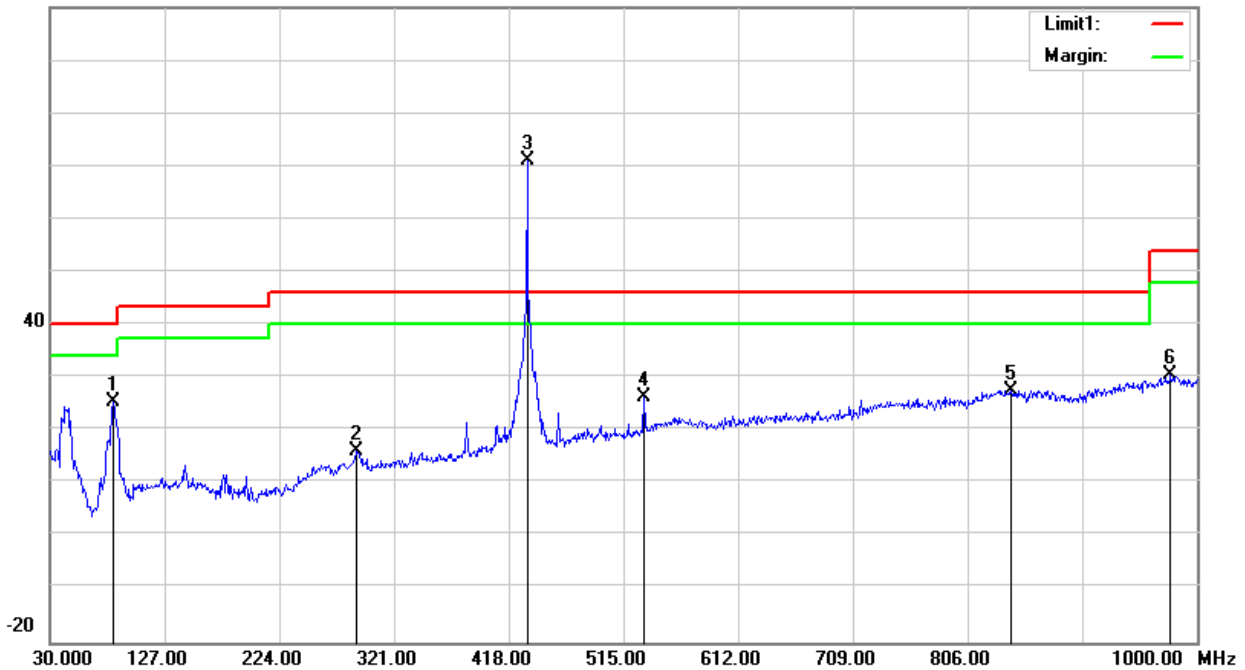





Temperature:	23.1 °C	Relative Humidity:	60%
Phase:	Horizontal	Test Mode:	Mode 4

No.	Frequency (MHz)	Reading (dBuV)	Factor (dB)	Results (dBuV/m)	Limit (dBuV/m)	Margin (dB)	Detector
1	85.2900	37.01	-22.13	14.88	40.00	-25.12	peak
2	289.9600	32.12	-15.16	16.96	46.00	-29.04	peak
4	569.3200	29.19	-5.59	23.60	46.00	-22.40	peak
5	868.0800	32.38	-0.51	31.87	46.00	-14.13	peak
6	992.2400	28.68	2.05	30.73	54.00	-23.27	peak

Fundamental Frequency

No.	Frequency (MHz)	Reading (dBuV)	Correct Factor(dB/m)	Duty cycle Factor(dB)	Result (dBuV/m)	Limit (dBuV/m)	Margin (dB)	Remark
3	433.9200	70.27	-10.13	-	60.14	92.87	-32.73	Peak

Remark:

- Margin = Result (Result =Reading + Factor) –Limit
- Factor= Antenna factor+Cable attenuation factor(cable loss)-Amplifier gain

100.0 dBuV/m

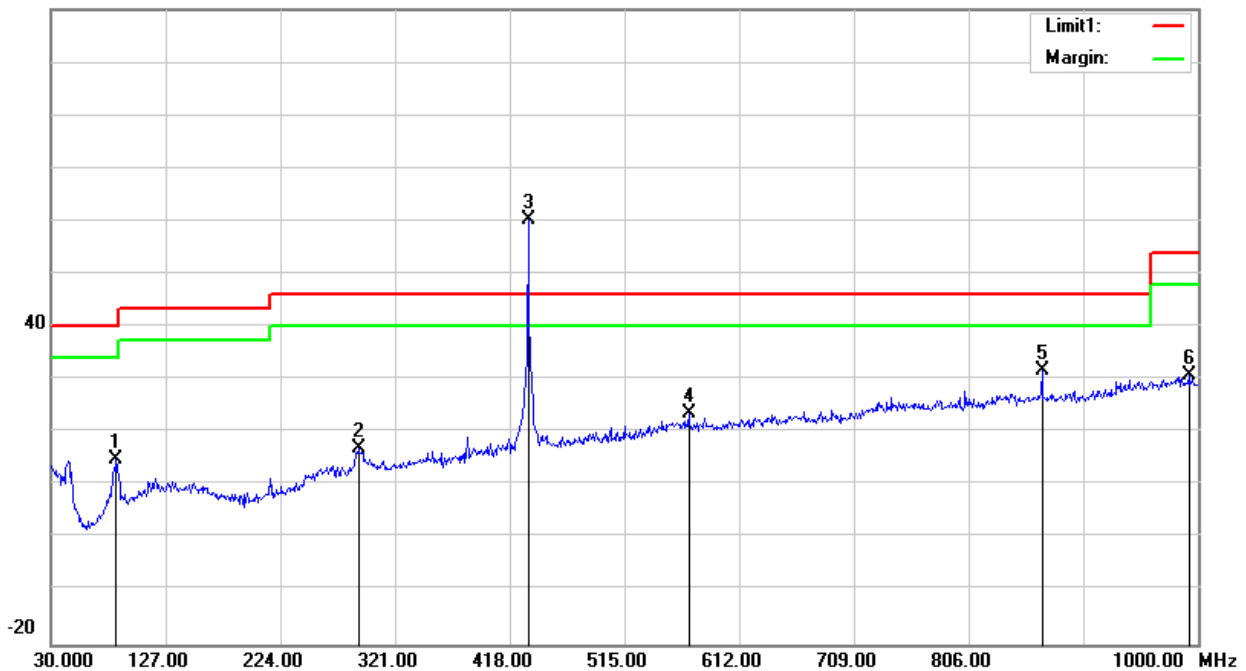



Temperature:	23.1°C	Relative Humidity:	60%
Phase:	Vertical	Test Mode:	Mode 4

No.	Frequency (MHz)	Reading (dBuV)	Factor (dB)	Results (dBuV/m)	Limit (dBuV/m)	Margin (dB)	Detector
1	44.5500	47.62	-20.43	27.19	40.00	-12.81	peak
2	289.9600	31.44	-15.16	16.28	46.00	-29.72	peak
4	626.5500	28.78	-5.19	23.59	46.00	-22.41	peak
5	837.0400	29.00	-0.46	28.54	46.00	-17.46	peak
6	970.9000	29.08	2.06	31.14	54.00	-22.86	peak

Fundamental Frequency

No.	Frequency (MHz)	Reading (dBuV)	Correct Factor(dB/m)	Duty cycle Factor(dB)	Result (dBuV/m)	Limit (dBuV/m)	Margin (dB)	Remark
3	433.9200	80.06	-10.13	-	69.93	92.87	-22.94	Peak

Remark:

- Margin = Result (Result = Reading + Factor) - Limit
- Factor = Antenna factor + Cable attenuation factor (cable loss) - Amplifier gain

100.0 dBuV/m

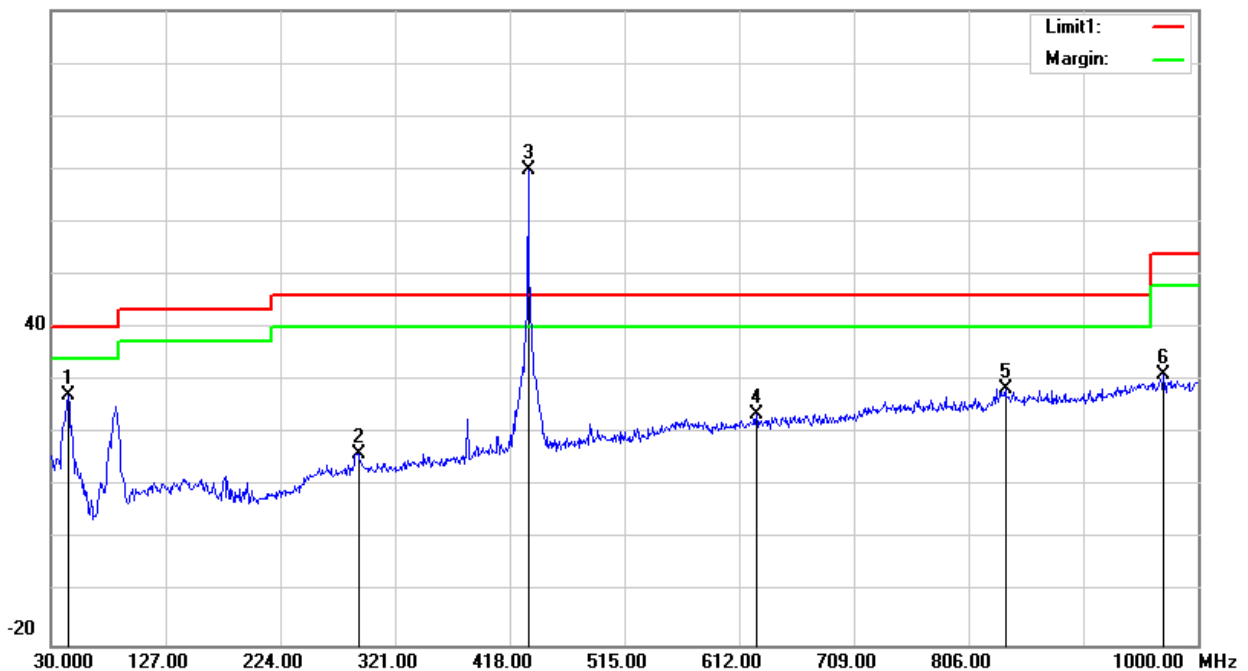



## PEAK TEST RESULTS:

## Mode 1

Frequency	Reading	Detector	Amplifier	Loss	Antenna Factor	Corrected Factor	Corrected Amplitude	FCC Part 15.231/15.209/205		RX Antenna
								Limit	Margin	Polar
(MHz)	(dB $\mu$ V/m)	(PK/QP/AV)	(dB)	(dB)	(dB)	(dB)	(dB $\mu$ V/m)	(dB $\mu$ V/m)	(dB)	(H/V)
1260.1036	63.43	PK	45.1	4.0	25.1	-16.00	47.43	74	-26.57	H
1260.1036	64.16	PK	45.1	4.0	25.1	-16.00	48.16	74	-25.84	V
1575.1623	61.25	PK	44.1	5.3	25	-13.80	47.45	74	-26.55	H
1575.1623	62.89	PK	44.1	5.3	25	-13.80	49.09	74	-24.91	V
1890.0068	59.96	PK	43.8	5.4	25.9	-12.47	47.50	74	-26.50	H
1890.0068	60.71	PK	43.8	5.4	25.9	-12.47	48.24	74	-25.76	V

## Mode 2

Frequency	Reading	Detector	Amplifier	Loss	Antenna Factor	Corrected Factor	Corrected Amplitude	FCC Part 15.231/15.209/205		RX Antenna
								Limit	Margin	Polar
(MHz)	(dB $\mu$ V/m)	(PK/QP/AV)	(dB)	(dB)	(dB)	(dB)	(dB $\mu$ V/m)	(dB $\mu$ V/m)	(dB)	(H/V)
1259.9475	65.19	PK	45.1	4.0	25.1	-16.00	49.19	74	-24.81	H
1259.9475	65.56	PK	45.1	4.0	25.1	-16.00	49.56	74	-24.44	V
1574.9044	63.04	PK	44.1	5.3	25	-13.80	49.24	74	-24.76	H
1574.9044	64.28	PK	44.1	5.3	25	-13.80	50.48	74	-23.52	V
1889.9679	61.47	PK	43.8	5.4	25.9	-12.47	49.00	74	-25.00	H
1889.9679	62.09	PK	43.8	5.4	25.9	-12.47	49.62	74	-24.38	V



## Mode 3

Frequency	Reading	Detector	Amplifier	Loss	Antenna Factor	Corrected Factor	Corrected Amplitude	FCC Part 15.231/15.209/205		RX
								Limit	Margin	Antenna
(MHz)	(dB $\mu$ V/m)	(PK/QP/AV)	(dB)	(dB)	(dB)	(dB)	(dB $\mu$ V/m)	(dB $\mu$ V/m)	(dB)	(H/V)
1301.8700	64.92	PK	45.1	4.0	25.1	-16.00	48.92	74	-25.08	H
1301.8700	65.74	PK	45.1	4.0	25.1	-16.00	49.74	74	-24.26	V
1735.8300	62.98	PK	44.1	5.3	25	-13.80	49.18	74	-24.82	H
1735.8300	64.28	PK	44.1	5.3	25	-13.80	50.48	74	-23.52	V
2169.6400	61.49	PK	43.8	5.4	25.9	-12.47	49.02	74	-24.98	H
2169.6400	61.95	PK	43.8	5.4	25.9	-12.47	49.48	74	-24.52	V
2603.5300	57.19	PK	44.4	6.0	27.6	-10.77	46.42	74	-27.58	H
2603.5300	57.24	PK	44.4	6.0	27.6	-10.77	46.47	74	-27.53	V

## Mode 4

Frequency	Reading	Detector	Amplifier	Loss	Antenna Factor	Corrected Factor	Corrected Amplitude	FCC Part 15.231/15.209/205		RX
								Limit	Margin	Antenna
(MHz)	(dB $\mu$ V/m)	(PK/QP/AV)	(dB)	(dB)	(dB)	(dB)	(dB $\mu$ V/m)	(dB $\mu$ V/m)	(dB)	(H/V)
1301.7321	65.06	PK	45.1	4.0	25.1	-16.00	49.06	74	-24.94	H
1301.7321	65.71	PK	45.1	4.0	25.1	-16.00	49.71	74	-24.29	V
1735.8511	62.83	PK	44.1	5.3	25	-13.80	49.03	74	-24.97	H
1735.8511	64.21	PK	44.1	5.3	25	-13.80	50.41	74	-23.59	V
2169.5553	61.46	PK	43.8	5.4	25.9	-12.47	48.99	74	-25.01	H
2169.5553	62.23	PK	43.8	5.4	25.9	-12.47	49.77	74	-24.23	V
2603.6197	56.97	PK	44.4	6.0	27.6	-10.77	46.21	74	-27.79	H
2603.6197	57.19	PK	44.4	6.0	27.6	-10.77	46.43	74	-27.57	V

## Note:

1. Above 2.6 GHz The amplitude of spurious emissions which are attenuated by more than 20dB below the permissible value has no need to be reported.
2. The peak value is less than the AV limit, so AV data does not need to be tested.

### 5. BANDWIDTH TEST

#### 5.1 LIMIT

FCC Part15.231,Subpart C			
Section	Test Item	Limit	Result
15.231(C)	20 Bandwidth& 99% Bandwidth	The20dB bandwidth&99% Bandwidth of the emissions shall not exceed 0.25% of the center frequency	PASS

Spectrum Parameter	Setting
Attenuation	Auto
Span Frequency	> Measurement Bandwidth
RB	1% to 5% of the OBW
VB	≥3RB
Detector	Peak
Trace	Max Hold
Sweep Time	Auto

#### 5.2 TEST REQUIREMENTS

The bandwidth of the emission shall be no wider than 0.25% of the center frequency for devices operating above 70 MHz and below 900 MHz. For devices operating above 900 MHz, the emission shall be no wider than 0.5% of the center frequency. Bandwidth is determined at the points 20 dB down from the modulated carrier.

#### 5.3 TEST PROCEDURE

- a. The EUT was directly connected to the spectrum analyzer and antenna output port as show in the block diagram below.
- b. Spectrum Setting: 1% to 5% of the OBW, VBW≥3RBW, Sweep time = Auto.

#### 5.4 TEST SETUP



#### 5.5 EUT OPERATION CONDITIONS

TX mode.



5.6 TEST RESULTS

Temperature:	25 °C	Relative Humidity:	60%
Test Mode:	Mode 1		

Centre Frequency	Measurement			
	20dB Bandwidth (KHz)	99% Bandwidth (KHz)	Limit(kHz)	Frequency Range (MHz)
315 MHz	42.62	55.094	787.5	PASS

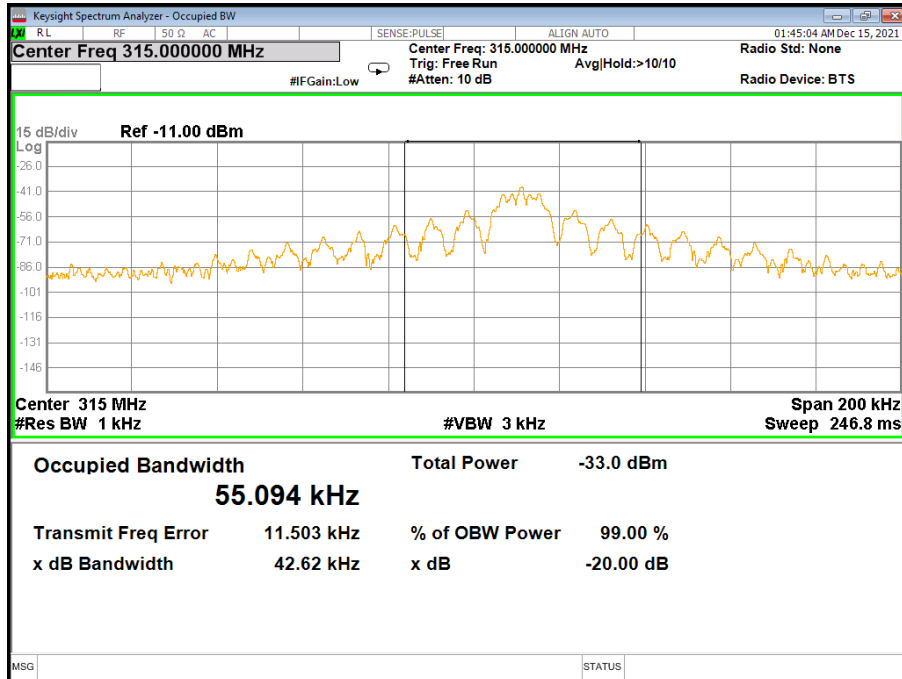



Temperature:	25 °C	Relative Humidity:	60%
Test Mode:	Mode 2		

Centre Frequency	Measurement			
	20dB Bandwidth (KHz)	99% Bandwidth (KHz)	Limit(kHz)	Frequency Range (MHz)
315 MHz	105.2	110.89	787.5	PASS

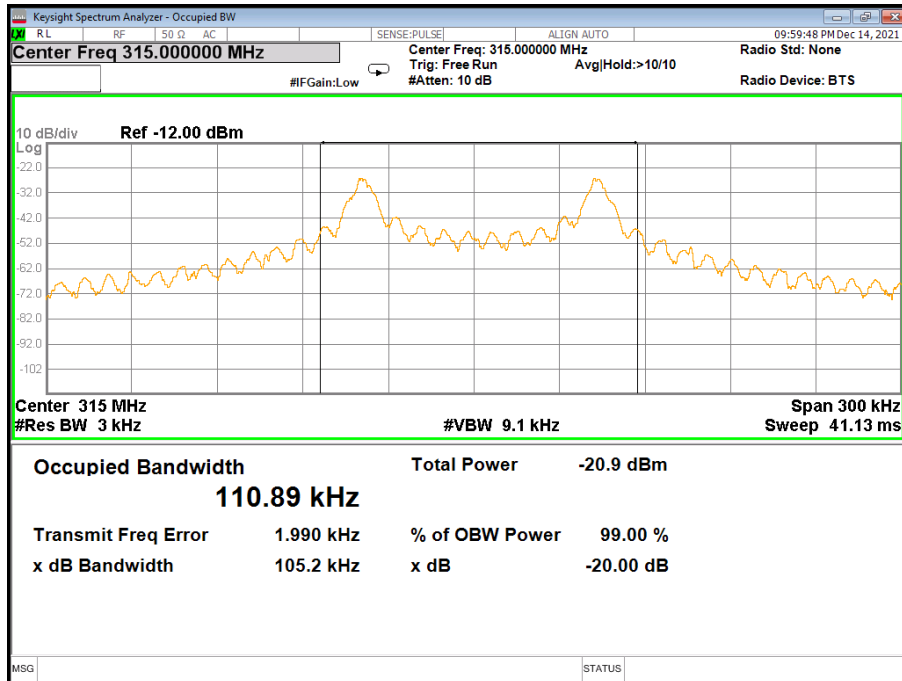



Temperature:	25 °C	Relative Humidity:	60%
Test Mode:	Mode 3		

Centre Frequency	Measurement			
	20dB Bandwidth (KHz)	99% Bandwidth (KHz)	Limit(kHz)	Frequency Range (MHz)
433.92 MHz	34.36	45.478	1085	PASS

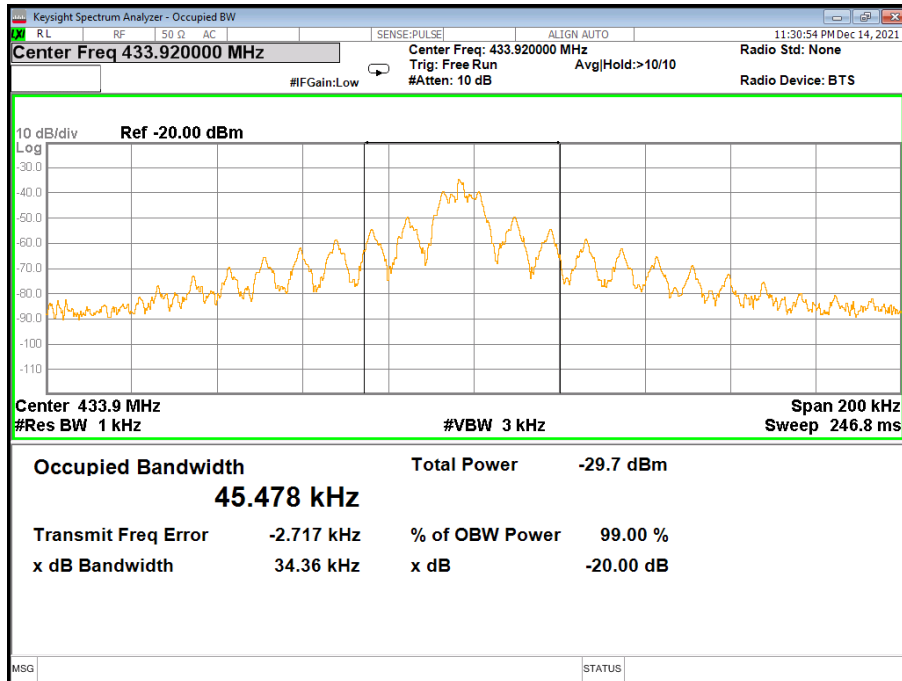





Temperature:	25 °C	Relative Humidity:	60%
Test Mode:	Mode 4		

Centre Frequency	Measurement			
	20dB Bandwidth (KHz)	99% Bandwidth (KHz)	Limit(kHz)	Frequency Range (MHz)
433.92 MHz	98.37	109.25	1085	PASS

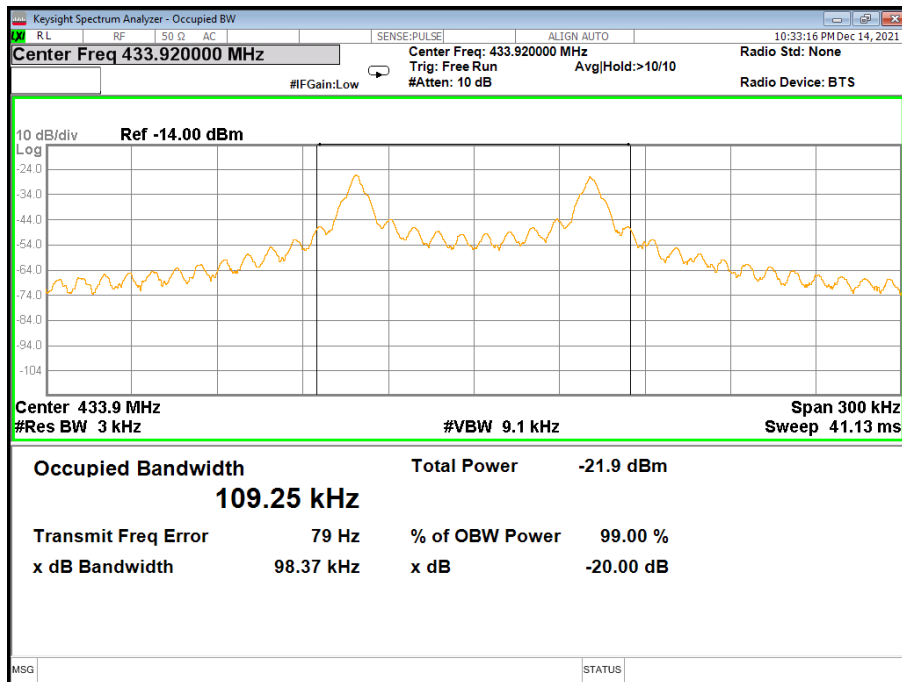

## 6. TRANSMITTER TIMEOUT

### 6.1 LIMIT

In addition, devices operated under the provisions of this paragraph shall be provided with a means for automatically limiting operation so that the duration of each transmission shall not be greater than one second and the silent period between transmissions shall be at least 30 times the duration of the but in no case less than 10 seconds.

### 6.2 TEST PROCEDURE

- (1) Put the EUT on the support in its standard position with associated equipment and switched on.
- (2) Set center frequency of spectrum analyzer = operating frequency.
- (3) Set the spectrum analyzer as RBW=100kHz, VBW=100kHz, Span=0Hz, Adjust Sweep=Auto.
- (4) record the duration time

### 6.3 TEST SETUP





6.4 TEST RESULTS

Temperature:	26 °C	Relative Humidity:	53%
Test Mode:	Mode 1		

Frequency(MHz)	Each transmission time(s)	silent period between transmissions(s)
315	0.42	15.57
Limit	<1s	>10s and > 30*(duration of transmission)
Result	Pass	

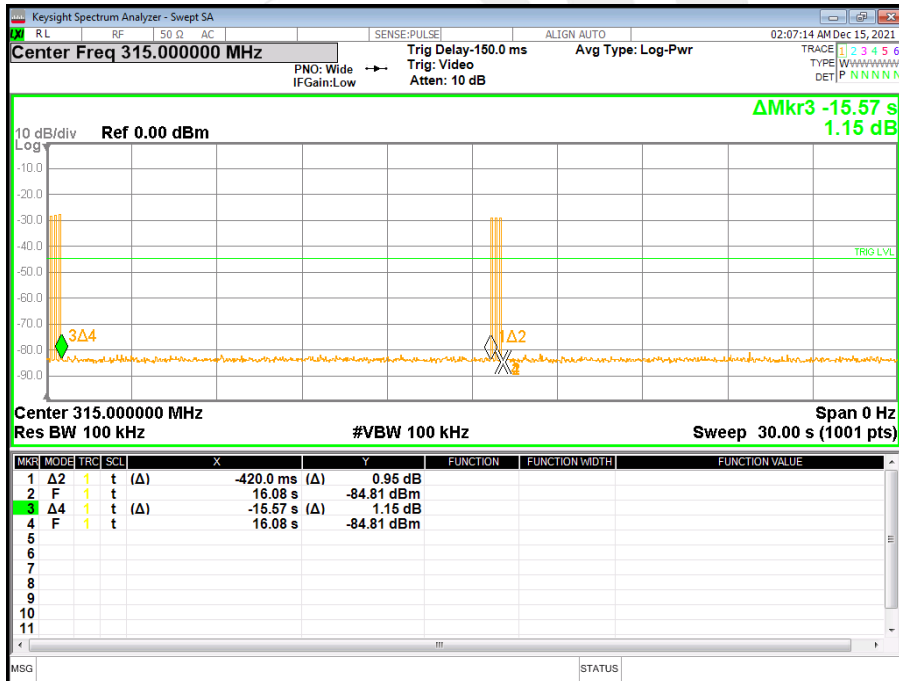



Temperature:	26 °C	Relative Humidity:	53%
Test Mode:	Mode 2		

Frequency(MHz)	Each transmission time(s)	silent period between transmissions(s)
315	0.39	15.56
Limit	<1s	>10s and > 30*(duration of transmission)
Result	Pass	

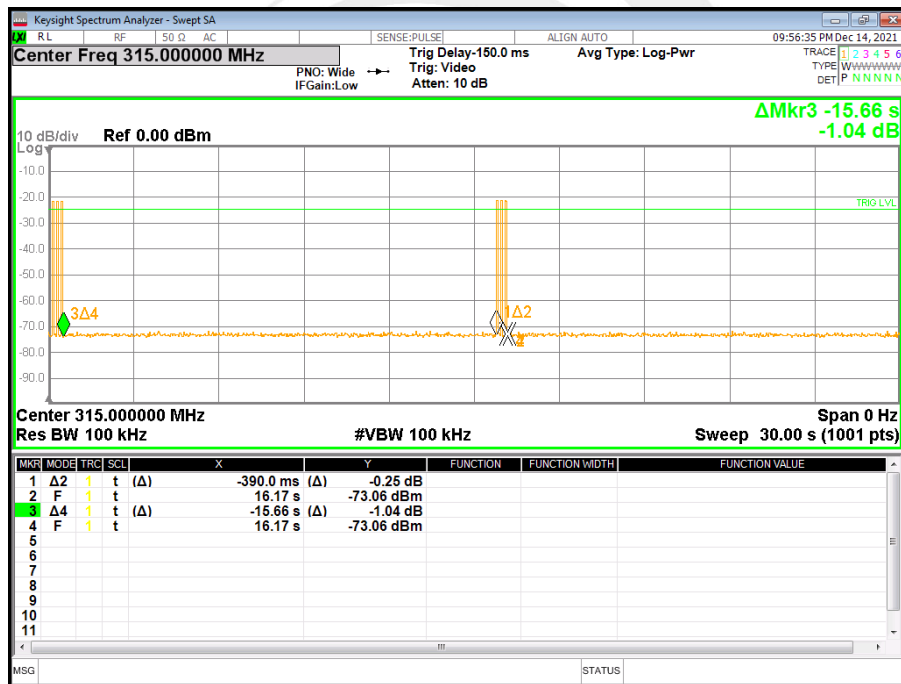



Temperature:	26 °C	Relative Humidity:	53%
Test Mode:	Mode 3		

Frequency(MHz)	Each transmission time(s)	silent period between transmissions(s)
433.92	0.88	30.16
Limit	<1s	>10s and > 30*(duration of transmission)
Result	Pass	





Temperature:	26 °C	Relative Humidity:	53%
Test Mode:	Mode 4		

Frequency(MHz)	Each transmission time(s)	silent period between transmissions(s)
433.92	0.4	23.72
Limit	<1s	>10s and > 30*(duration of transmission)
Result	Pass	



## 7. PERIODIC OPERATION

### 7.1 TEST PROCEDURE

The EUT was directly connected to the spectrum analyzer and antenna output port as show in the block diagram below.

The Duty Cycle Was Determined By The Following Equation: To Calculate The Actual Field Intensity,The Duty Cycle Correction Factor In Decibel Is Needed For Later Use And Can Be Obtained From Following Conversion

Duty Cycle(%)=Total On Interval In A Complete Pulse Train/ Length Of A Complete Pulse Train \* %

Duty Cycle Correction Factor(dB)=20 \* Log10(Duty Cycle(%))

### 7.2 TEST SETUP



### 7.3 EUT OPERATION CONDITIONS

TX mode.



### 7.4 TEST RESULTS

Mode 1

FCC Part15.231(e)	
Total On interval in a complete pulse train(ms)	30.5
Length of a complete pulse train(ms)	100
Duty Cycle(%)	30.50%
Duty Cycle Correction Factor(dB)	10.31

Refer to the duty cycle plot (as below), This device meets the FCC requirement. Length of a complete pulse train

Remark:FCC part15.35(c) and RSS 210 required that a complete pulse train is more than 0.1 seconds, the measured field strength shall be determined from the average absolute voltage during a 0.1 second interval during which the field strength is at its maximum value.





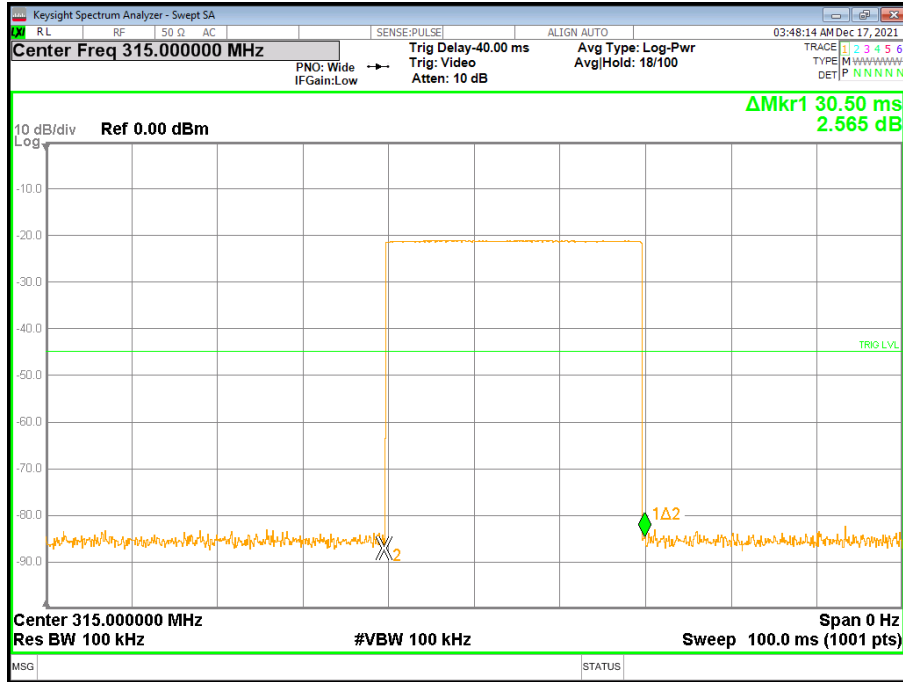



Mode 2

FCC Part15.231(e)	
Total On interval in a complete pulse train(ms)	29.8
Length of a complete pulse train(ms)	100
Duty Cycle(%)	29.80%
Duty Cycle Correction Factor(dB)	10.52

Refer to the duty cycle plot (as below), This device meets the FCC requirement. Length of a complete pulse train  
Remark:FCC part15.35(c) and RSS 210 required that a complete pulse train is more than 0.1 seconds, the measured field strength shall be determined from the average absolute voltage during a 0.1 second interval during which the field strength is at its maximum value.



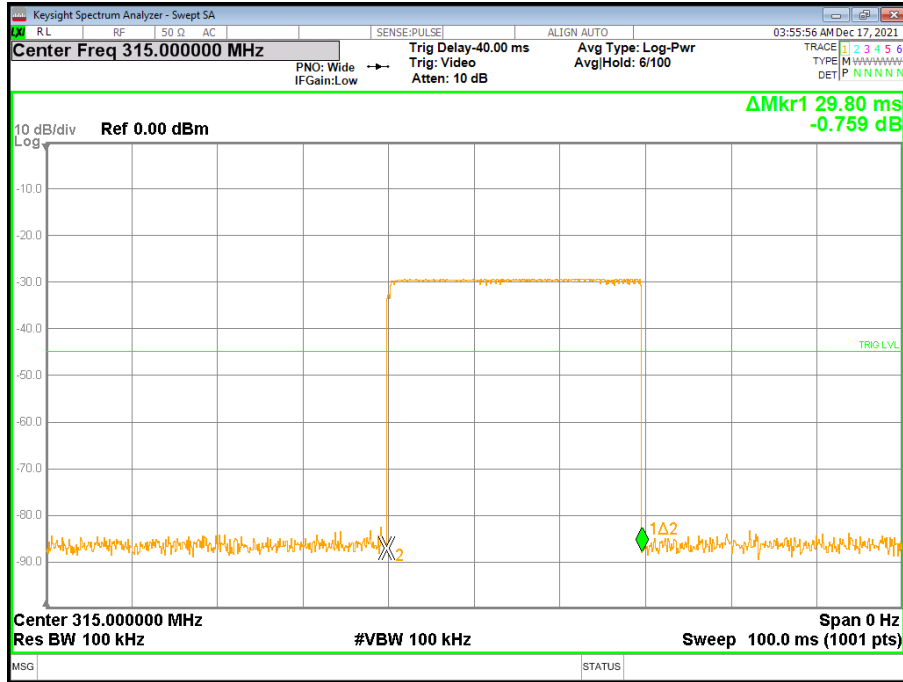



Mode 3

FCC Part15.231(e)	
Total On interval in a complete pulse train(ms)	16.8
Length of a complete pulse train(ms)	100
Duty Cycle(%)	16.80%
Duty Cycle Correction Factor(dB)	15.49

Refer to the duty cycle plot (as below), This device meets the FCC requirement. Length of a complete pulse train  
Remark:FCC part15.35(c) and RSS 210 required that a complete pulse train is more than 0.1 seconds, the measured field strength shall be determined from the average absolute voltage during a 0.1 second interval during which the field strength is at its maximum value.



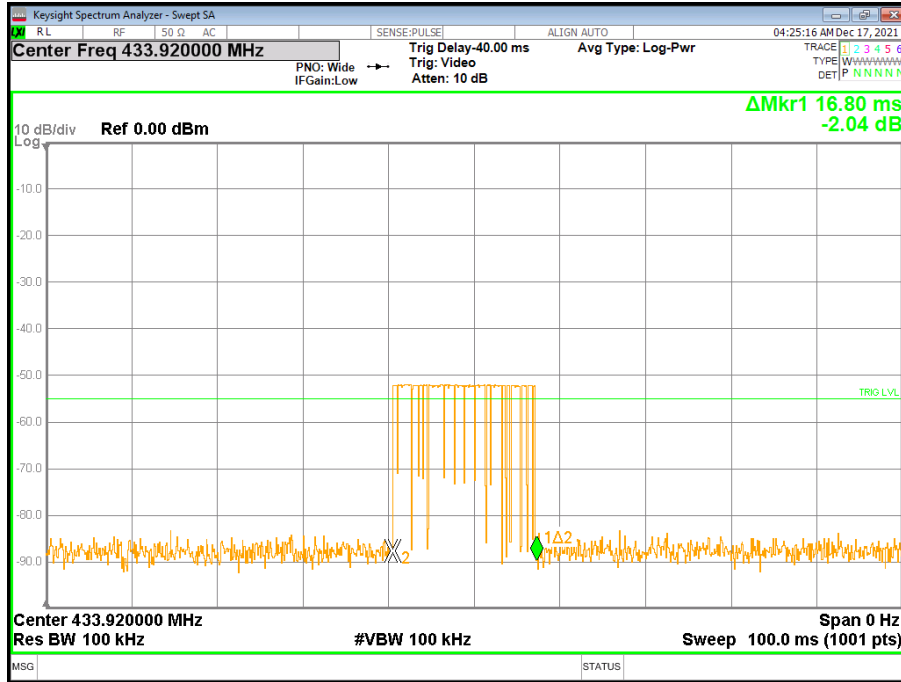



Mode 4

FCC Part15.231(e)	
Total On interval in a complete pulse train(ms)	19
Length of a complete pulse train(ms)	100
Duty Cycle(%)	19.00%
Duty Cycle Correction Factor(dB)	14.42

Refer to the duty cycle plot (as below), This device meets the FCC requirement. Length of a complete pulse train  
 Remark:FCC part15.35(c) and RSS 210 required that a complete pulse train is more than 0.1 seconds, the measured field strength shall be determined from the average absolute voltage during a 0.1 second interval during which the field strength is at its maximum value.

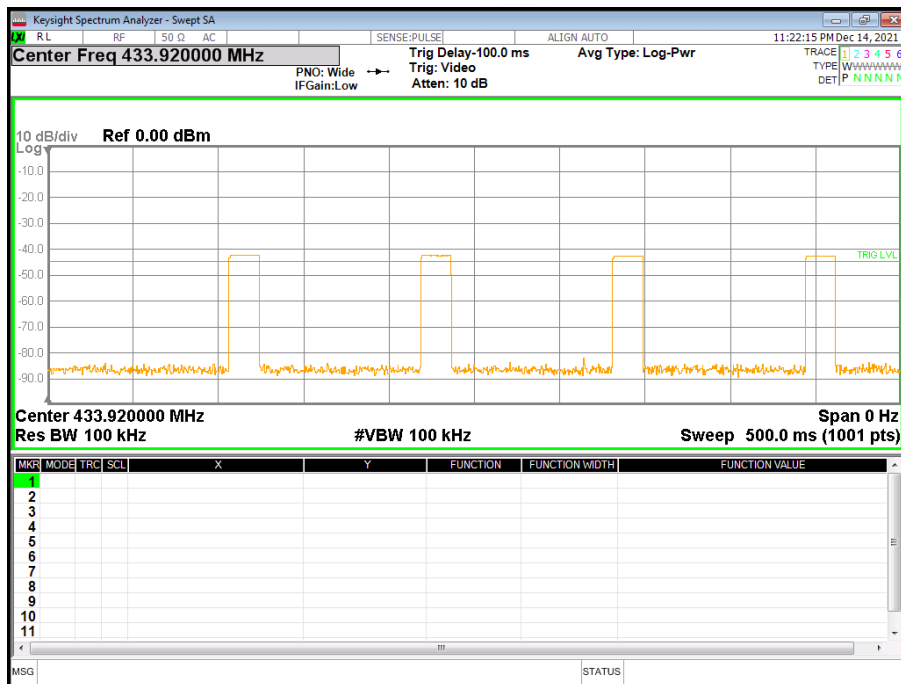





## 8. ANTENNA REQUIREMENT

### 8.1 STANDARD REQUIREMENT

According to the FCC Part 15 Paragraph 15.203, an intentional radiator shall be designed to ensure that no antenna other than that furnished by the responsible party shall be used with the device. The use of a permanently attached antenna to the intentional radiator shall be considered sufficient to comply with the provisions of this section. This product use a permanent ceramic printed antenna, fulfill the requirement of this section

### 8.2 EUT ANTENNA

The EUT antenna is Internal antenna.It conforms to the standard requirements.







## APPENDIX 1-PHOTOS OF TEST SETUP

Note: See test photos in setup photo document for the actual connections between Product and support equipment.

\*\*\*\*\*END OF THE REPORT\*\*\*\*\*

