



427 West 12800 South
Draper, UT 84020

Test Report Certification

FCC ID	SWX-WAVELR
IC ID	6545A-WAVELR
Equipment Under Test	Wave-LR
Test Report Serial Number	TR7005_01
Date of Tests	1, 21, 25, 28 March 2022
Report Issue Date	30 March 2022

Test Specification	Applicant
47 CFR FCC Part 15, Subpart C	Ubiquiti Inc. 685 Third Avenue New York, NY 10017 U.S.A.



NVLAP LAB CODE 600241-0

Certification of Engineering Report

This report has been prepared by Unified Compliance Laboratory (UCL) to document compliance of the device described below with the requirement of Federal Communication Commissions (FCC) Part 15, Subpart C. This report may be reproduced in full. Partial reproduction of this report may only be made with the written consent of the laboratory. The results in this report apply only to the sample tested.

Applicant	Ubiquiti Inc.
Manufacturer	Ubiquiti Inc.
Brand Name	airFiber
Model Number	Wave-LR
FCC ID	SWX-WAVELR
IC ID	6545A-WAVELR

On this 30th day of March 2022, I individually and for Unified Compliance Laboratory certify that the statements made in this engineering report are true, complete, and correct to the best of my knowledge and are made in good faith.

Although NVLAP has accredited the Unified Compliance Laboratory testing facilities, this report must not be used to claim product certification, approval, or endorsement by NVLAP, NIST or any agency of the U.S. federal government.

Unified Compliance Laboratory

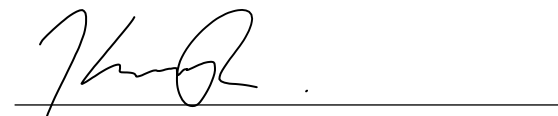

Written By: Kimberly Rodriguez



Reviewed By: Richard L. Winter

Revision History		
Revision	Description	Date
01	Original Report Release	30 March 2022

Table of Contents

1	Client Information.....	5
1.1	Applicant.....	5
1.2	Manufacturer.....	5
2	Equipment Under Test (EUT).....	6
2.1	Identification of EUT	6
2.2	Description of EUT	6
2.3	EUT and Support Equipment.....	6
2.4	Interface Ports on EUT	7
2.5	Operating Environment.....	7
2.6	Operating Modes.....	7
2.7	EUT Exercise Software.....	7
2.8	Block Diagram of Test Configuration	8
2.9	Modification Incorporated/Special Accessories on EUT.....	8
2.10	Deviation, Opinions Additional Information or Interpretations from Test Standard.....	8
3	Test Specification, Method and Procedures.....	9
3.1	Test Specification.....	9
3.2	Methods & Procedures.....	9
3.3	FCC Part 15, Subpart C	9
3.4	Results.....	10
3.5	Test Location	10
4	Test Equipment	11
4.1	Conducted Emissions at Mains Ports.....	11
4.2	Direct Connect at the Antenna Port Tests.....	11
4.3	Radiated Emissions.....	12
4.4	Equipment Calibration	13
4.5	Measurement Uncertainty.....	13
5	Test Results.....	14
5.1	§15.203 Antenna Requirements.....	14
5.2	Conducted Emissions at Mains Ports Data	14
5.3	§15.247(a)(2) Emissions Bandwidth.....	16
5.4	§15.247(b)(3) Maximum Average Output Power.....	16
5.5	§15.247(d) Spurious Emissions	16
5.6	§15.247(e) Maximum Average Power Spectral Density	19

1 Client Information

1.1 Applicant

Company	Ubiquiti Inc. 685 Third Avenue New York, NY 10017 U.S.A.
Contact Name	Mark Feil
Title	Compliance Manager

1.2 Manufacturer

Company	Ubiquiti Inc. 685 Third Avenue New York, NY 10017 U.S.A.
Contact Name	Mark Feil
Title	Compliance Manager

2 Equipment Under Test (EUT)

2.1 Identification of EUT

Brand Name	airFiber
Model Number	Wave-LR
Serial Number	245A4C2F9F38
Dimensions (cm)	42.4 x 42.4 x 6.6

2.2 Description of EUT

The Wave-LR is a 60 GHz point-to-multipoint customer premise equipment that features wave technology with a 1.5+ Gbps throughput rate. The Wave-LR is also equipped with a 5 GHz WiFi 6 backup radio to sustain connectivity during a 60 GHz link disruption caused by inclement weather conditions. A Bluetooth LE transceiver is included for device management. The Wave-LR is an outdoor device and has an Ethernet port which is used for data transfer and to provide power using an Ubiquiti U-POE-at 48-volt PoE power adapter.

This report covers the circuitry of the device subject to FCC Part 15, Subpart C. The circuitry of the device subject to FCC Part 15 Subpart B was found to be compliant and is covered under a separate Unified Compliance Laboratory test report.

2.3 EUT and Support Equipment

The EUT and support equipment used during the test are listed below.

Brand Name Model Number Serial Number	Description	Name of Interface Ports / Interface Cables
BN: airFiber MN: Wave-LR (Note 1) SN: 245A4C2F9F38	Wireless Access Point	See Section 2.4
BN: Ubiquiti MN: U-POE-at SN: N/A	PoE Power Adapter	Shielded or Un-shielded cat 5e cable
BN: Dell MN: XPS 13 SN: N/A	Laptop Computer	Shielded or Un-shielded cat 5e cable

Notes: (1) EUT

(2) Interface port connected to EUT (See Section 2.4)

The support equipment listed above was not modified in order to achieve compliance with this standard.

2.4 Interface Ports on EUT

Name of Ports	No. of Ports Fitted to EUT	Cable Description/Length
AC (PoE Injector)	1	3 conductor power cord/80cm
LAN (PoE Injector)	1	Shielded or Un-shielded cat 5e cable/1 meter
Data	1	Shielded or Un-shielded cat 5e cable/1 meter

2.5 Operating Environment

Power Supply	120 Volts ac to 48 Volts PoE
AC Mains Frequency	60 Hz
Temperature	22.0-22.7 °C
Humidity	18.7-22.9 %
Barometric Pressure	1000 mBar

2.6 Operating Modes

The Wave-LR was connected to a personal computer laptop and tested using test software in order to enable to constant duty cycle greater or equal to 98% of the Bluetooth transceiver.

2.7 EUT Exercise Software

EUT firmware version 1.0 was used to operate the transmitter using a constant transmit mode.

2.8 Block Diagram of Test Configuration

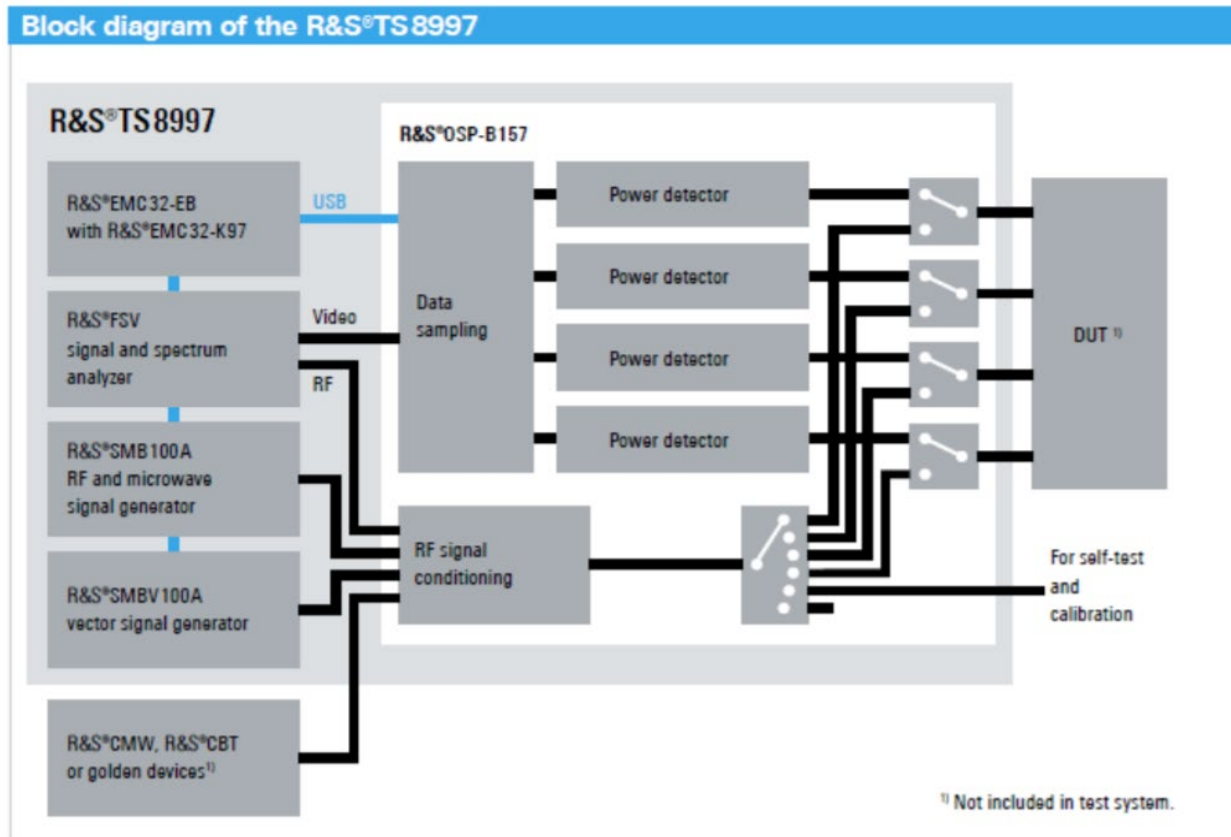

Diagram 1: Test Configuration Block Diagram

2.9 Modification Incorporated/Special Accessories on EUT

There were no modifications made to the EUT during testing to comply with the specification.

2.10 Deviation, Opinions Additional Information or Interpretations from Test Standard

There were no deviations, opinions, additional information or interpretations from the test specification.

3 Test Specification, Method and Procedures

3.1 Test Specification

Title	47 CFR FCC Part 15, Subpart C 15.203, 15.207 and 15.247 Limits and methods of measurement of radio interference characteristics of radio frequency devices.
Purpose of Test	The tests were performed to demonstrate initial compliance

3.2 Methods & Procedures

3.2.1 47 CFR FCC Part 15 Section 15.203

See test standard for details.

3.2.2 47 CFR FCC Part 15 Section 15.207

See test standard for details.

3.2.3 47 CFR FCC Part 15 Section 15.247

See test standard for details.

3.3 FCC Part 15, Subpart C

3.3.1 Summary of Tests

FCC Section	ISED Section	Environmental Phenomena	Frequency Range (MHZ)	Result
15.203	N/A	Antenna requirements	Structural Requirement	Compliant
15.207	RSS-Gen	Conducted Disturbance at Mains Port	0.15 to 30	Compliant
15.247(a)	RSS-247 § 5.2	Bandwidth Requirement	2400 to 2480	Compliant
15.247(b)	RSS-247 § 5.4	Peak Output Power	2400 to 2480	Compliant
15.247(d)	RSS-247 § 5.4	Antenna Conducted Spurious Emissions	0.009 to 40000	N/A
15.247(d)	RSS-247 § 5.4	Radiated Spurious Emissions	30 to 40000	Compliant
15.247(e)	RSS-247 § 5.2	Peak Power Spectral Density	2400 to 2480	Compliant

The testing was performed according to the procedures in ANSI C63.10-2013, KDB 558074 and 47 CFR Part 15. Where applicable, KDB 662911 was followed to sum required measurements.

3.4 Results

In the configuration tested, the EUT complied with the requirements of the specification.

3.5 Test Location

Testing was performed at the Unified Compliance Laboratory 3-meter and 10-meter chamber located at 427 West 12800 South, Draper, UT 84020. Unified Compliance Laboratory is accredited by National Voluntary Laboratory Accreditation Program (NVLAP); NVLAP Code 600241-0 which is effective until 30 June 2022. This site has also been registered with Innovations, Science and Economic Development (ISED) department and was accepted under Appendix B, Phase 1 procedures of the APEC Tel MRA for Canadian recognition. ISED No.: 25346, effective until 30 June 2022. Unified Compliance Laboratory has been assigned Conformity Assessment Number US0223 by ISED.

4 Test Equipment

4.1 Conducted Emissions at Mains Ports

Type of Equipment	Manufacturer	Model Number	Asset Number	Date of Last Calibration	Due Date of Calibration
EMI Receiver	AFJ	FFT3010	UCL-6754	12/8/2021	12/8/2022
LISN	AFJ	LS16C/10	UCL-6749	12/6/2021	12/6/2023
Cat6 ISN	Teseq	ISN T8-Cat6	UCL-2971	1/30/2022	1/30/2023
ISN	Teseq	ISN T800	UCL-2974	6/4/2021	6/4/2022
LISN	Com-Power	LIN-120C	UCL-2612	1/6/2022	1/6/2023
AC Power Source	Laplace Instruments	AC1000A	UCL-2857	N/A	N/A
Test Software	UCL	Revision 1	UCL-3107	N/A	N/A

Table 1: List of equipment used for Conducted Emissions Testing at Mains Port

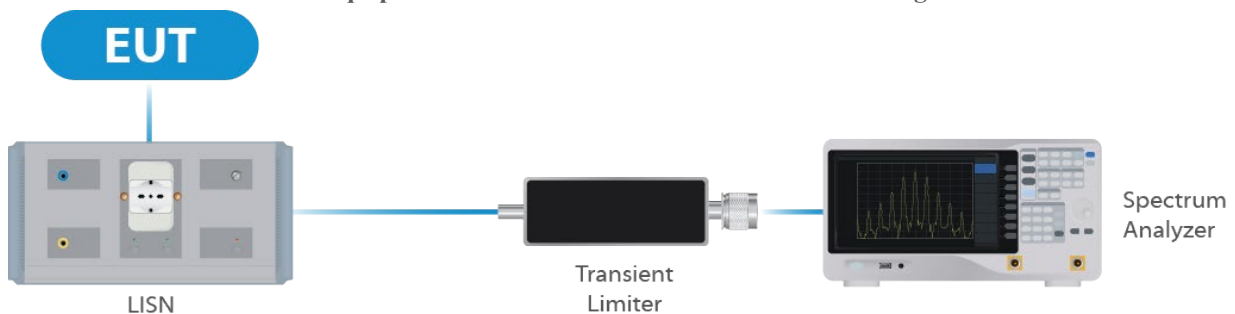

Figure 1: Conducted Emissions Test

4.2 Direct Connect at the Antenna Port Tests

Type of Equipment	Manufacturer	Model Number	Asset Number	Date of Last Calibration	Due Date of Calibration
Spectrum Analyzer	R&S	FSV40	UCL-2861	1/03/2022	1/03/2023
Signal Generator	R&S	SMB100A	UCL-2864	N/A	N/A
Vector Signal Generator	R&S	SMBV100A	UCL-2873	N/A	N/A
Switch Extension	R&S	OSP-B157WX	UCL-2867	1/03/2022	1/03/2023
Switch Extension	R&S	OSP-150W	UCL-2870	1/03/2022	1/03/2023

Table 2: List of equipment used for Direct Connect at the Antenna Port

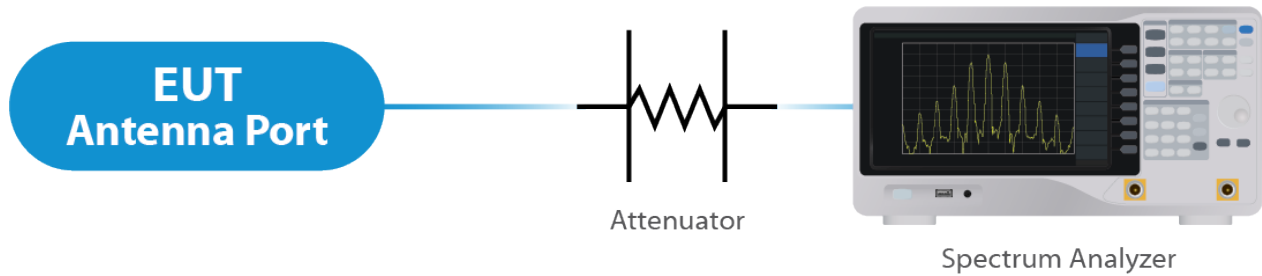

Figure 2: Direct Connect at the Antenna Port Test

4.3 Radiated Emissions

Type of Equipment	Manufacturer	Model Number	Asset Number	Date of Last Calibration	Due Date of Calibration
EMI Receiver	Keysight	N9038A	UCL-2778	6/21/2021	6/21/2022
Pre-Amplifier 9 kHz – 1 GHz	Sonoma Instruments	310N	UCL-2889	10/7/2021	10/7/2022
Broadband Antenna	Scwarzbeck	VULB 9163	UCL-3062	8/28/2020	8/27/2022
Broadband Antenna	Scwarzbeck	VULB 9163	UCL-3071	5/19/2020	5/19/2022
Double Ridge Horn Antenna	Scwarzbeck	BBHA 9120D	UCL-3065	7/8/2021	7/8/2022
Log Periodic	Scwarzbeck	STLP 9129	UCL-3068	11/16/2020	11/16/2022
15 - 40 GHz Horn Antenna	Scwarzbeck	BBHA 9170	UCL-2487	5/21/2020	5/21/2022
1 – 18 GHz Amplifier	Com-Power	PAM 118A	UCL-3833	10/7/2021	10/7/2022
Test Software	UCL	Revision 1	UCL-3108	N/A	N/A

Table 3: List of equipment used for Radiated Emissions

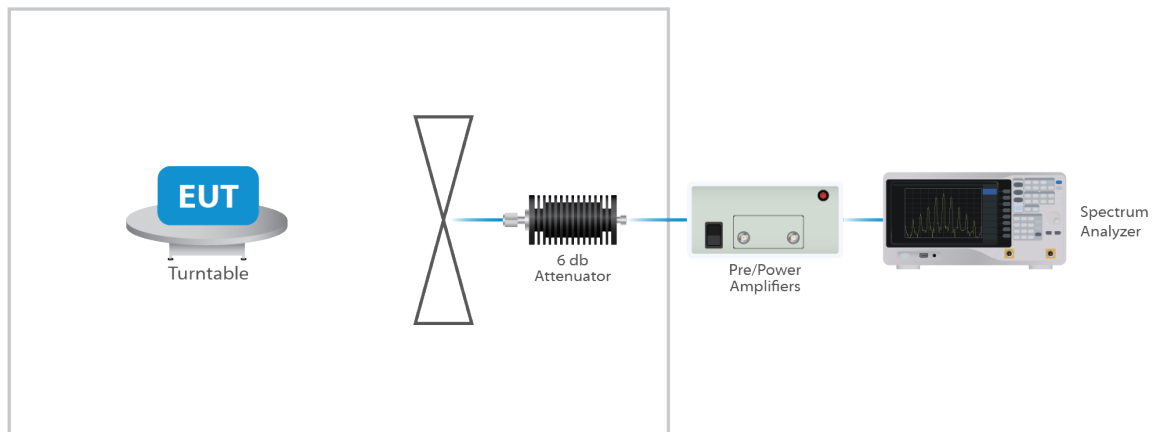

Figure 3: Radiated Emissions Test

4.4 Equipment Calibration

All applicable equipment is calibrated using either an independent calibration laboratory or Unified Compliance Laboratory personnel at intervals defined in ANSI C63.4:2014 following outlined calibration procedures. All measurement instrumentation is traceable to the National Institute of Standards and Technology (NIST). Supporting documentation relative to traceability is on file and is available for examination upon request.

4.5 Measurement Uncertainty

Test	Uncertainty (\pm dB)	Confidence (%)
Conducted Emissions	1.44	95
Radiated Emissions (9 kHz to 30 MHz)	2.50	95
Radiated Emissions (30 MHz to 1 GHz)	4.38	95
Radiated Emissions (1 GHz to 18 GHz)	4.37	95
Radiated Emissions (18 GHz to 40 GHz)	3.93	95
Direct Connect Tests	K Factor	Value
Emissions Bandwidth	2	2.0%
Output Power	2	1.0 dB
Peak Power Spectral Density	2	1.3 dB
Band Edge	2	0.8 dB
Transmitter Spurious Emissions	2	1.8 dB

5 Test Results

5.1 §15.203 Antenna Requirements

The EUT uses an integral antenna. The Maximum gain of the antenna is 2 dBi. The antenna is not user replaceable.

Results

The EUT complied with the specification

5.2 Conducted Emissions at Mains Ports Data

Frequency (MHZ)	AC Mains Lead	Detector	Measured Level (dBµV)	Limit (dBµV)	Margin (dB)
0.540	Hot Lead	Quasi-Peak (Note 2)	47.3	56.0	- 8.70
0.153	Hot Lead	Quasi-Peak (Note 2)	52.0	65.9	- 13.90
0.531	Hot Lead	Average (Note 2)	40.0	46.0	- 6.00
0.540	Neutral Lead	Quasi-Peak (Note 2)	47.8	56.0	- 8.20
0.150	Neutral Lead	Quasi-Peak (Note 2)	50.7	66.0	- 15.30
0.546	Neutral Lead	Average (Note 2)	40.9	46.0	- 5.10

Note 1: The reference detector used for the measurements was Quasi-Peak or Peak and the data was compared to the average limit: therefore, the EUT was deemed to meet both the average and quasi-peak limits.

Note 2: The reference detector used for the measurements was quasi-peak and average and the data was compared to the respective limits.

Note 3: The device the transceiver is in is a Class A device and the limits shown are from §15.207 which are the same as the limits for a Class B device under §15.107. These emissions were investigated and were found to be at the same level regardless of whether the transceivers of the device were not powered, powered and idle, or powered and active, therefore, the conducted emissions of the transceivers were deemed compliant with the requirements of the standard.

Result

The EUT complied with the specification limit.

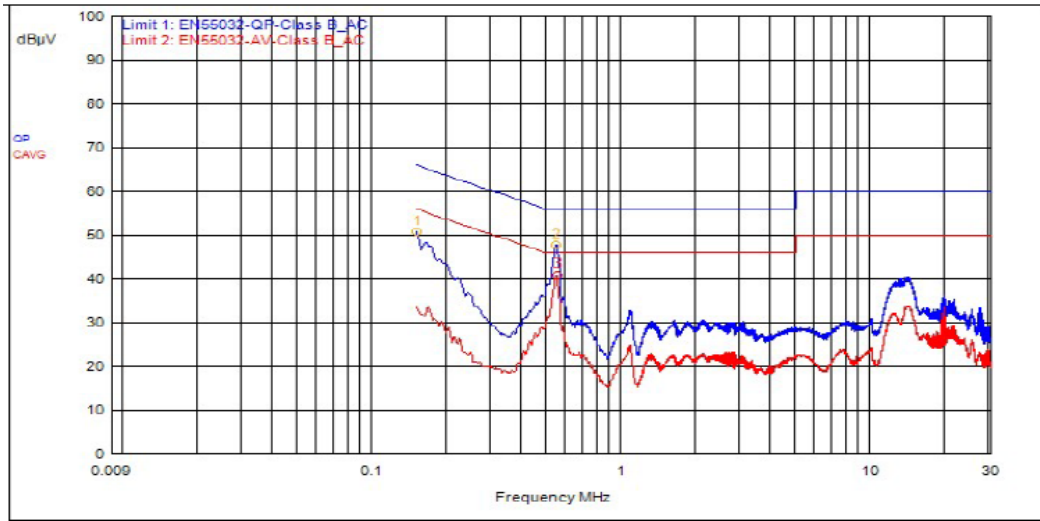

Graph 1: Conducted Emissions Plot - Neutral

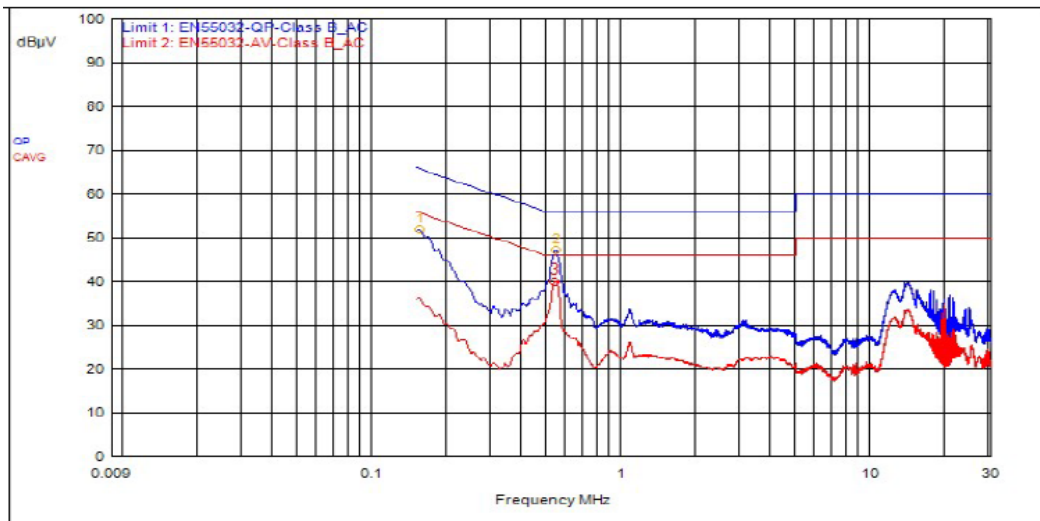

Graph 2: Conducted Emissions Plot - Line 1

5.3 §15.247(a)(2) Emissions Bandwidth

Frequency (MHz)	Emissions 6 dB Bandwidth (MHz)	Emissions 99% Bandwidth (MHz)
2402	0.71	1.03
2442	0.71	1.03
2480	0.69	1.02

Result

In the configuration tested, the 6 dB bandwidth was greater than 500 kHz; therefore, the EUT complied with the requirements of the specification (see spectrum analyzer plot within the Annex).

5.4 §15.247(b)(3) Maximum Average Output Power

The maximum average RF conducted output power measured for this device was 12.16 dBm or 16.44 mW. The limit is 30 dBm or 1 Watt when using antennas with 6 dBi or less gain. The antenna has a gain of 2 dBi.

Frequency (MHz)	Measured Output Power (dBm)	Output Power (mW)
2402	12.16	16.44
2442	11.14	13.00
2480	10.42	11.02

Result

In the configuration tested, the maximum average RF output power was less than 1 watt; therefore, the EUT complied with the requirements of the specification (see spectrum analyzer plot within the Annex).

5.5 §15.247(d) Spurious Emissions

5.5.1 Conducted Spurious Emissions

The frequency range is from the lowest frequency generated or used in the device to the tenth harmonic of the highest fundamental frequency was investigated to measure any antenna-conducted emissions. The table show the measurement data from spurious emissions noted across the frequency range when transmitting at the lowest frequency, middle frequency and upper frequency. Shown within the Annex are plots with the EUT tuned to the upper and lower channels. These demonstrate compliance with the provisions of this section at the band edges.

The emissions must be attenuated 30 dB below the highest power spectral density level measured within the authorized band as measured with a 100 kHz RBW.

Result

Conducted spurious emissions were attenuated 30 dB or more below the fundamental; therefore, the EUT complies with the specification.

5.5.2 Radiated Spurious Emissions in the Restricted Bands of §15.205

The frequency range is from the lowest frequency generated or used in the device to the tenth harmonic of the highest fundamental emissions was investigated to measure any radiated emissions in the restricted bands. The following tables show measurements of any emissions that fell into the restricted bands of §15.205. The tables show the worst-case emissions measured from the EUT. For frequencies above 18.0 GHz, a measurement distance of 1 meter was used. The noise floor was a minimum of 6 dB below the limits. The emissions in the restricted bands must meet the limits specified in §15.209. Tabular data for each of the spurious emissions is shown below for each of the units. Plots of the band edges are also shown.

Result

All emissions in the restricted bands of §15.205 met the limits specified in §15.209; therefore, the EUT complies with the specification.

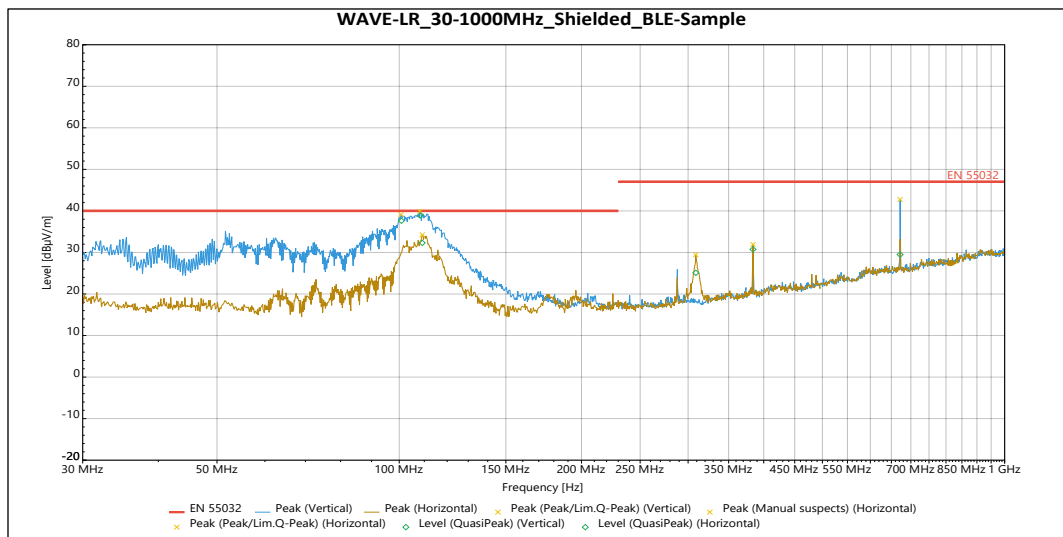

Frequency	SR #	Level (dBµV/m)	Limit (dBµV/m)	Margin	Azimuth (°)	Height	Pol.	RBW (Hz)	Correction (dB)
100.83 MHz	QPeak	37.627	40	-2.373	340	1.378	Vertical	120000	-12.8
108.29 MHz	QPeak	38.899	40	-1.101	102	1.053	Vertical	120000	-13.591
671.94 MHz	QPeak	29.487	47	-17.513	301	2.656	Vertical	120000	-4.084
109.13 MHz	QPeak	32.305	40	-7.695	56	3.826	Horizontal	120000	-13.784
308.98 MHz	QPeak	25.1	47	-21.9	183	2.535	Horizontal	120000	-11.098
383.97 MHz	QPeak	30.743	47	-16.257	163	1.791	Horizontal	120000	-9.171

Table 4: Radiated Emission within 30 – 1000 MHz (worst case)

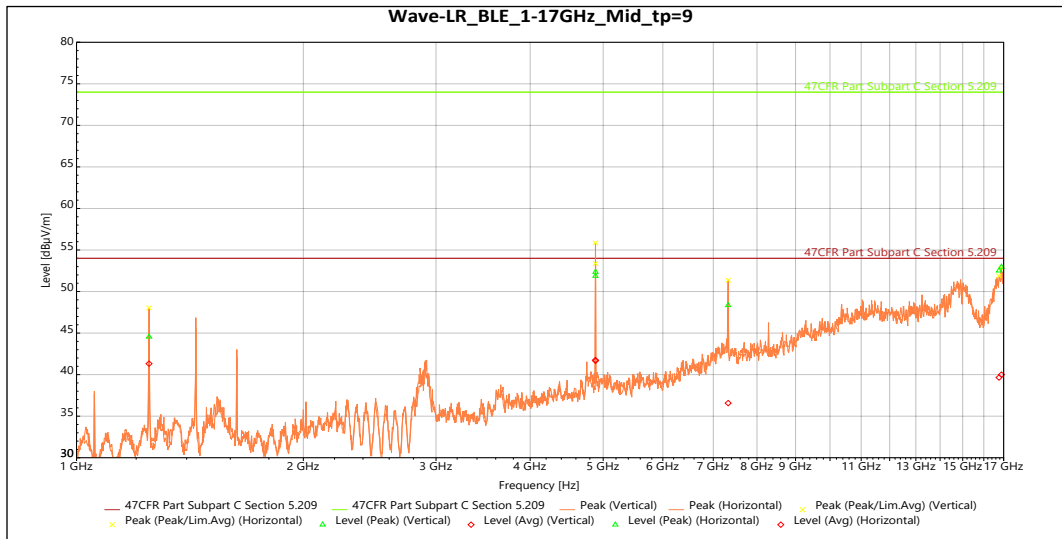

Frequency	SR #	Level (dBµV/m)	Limit (dBµV/m)	Margin (dB)	Azimuth (°)	Height (m)	Pol.	RBW	Correction (dB)
4.8844 GHz	Peak	52.364	74	-21.636	166	2.325	Vertical	1000000	-11.916
7.3253 GHz	Peak	48.345	74	-25.655	210	2.65	Vertical	1000000	-4.992
16.887 GHz	Peak	52.967	74	-21.033	326	1.643	Vertical	1000000	9.405
4.8844 GHz	AVG	41.665	54	-12.335	166	2.325	Vertical	1000000	-11.916
7.3253 GHz	AVG	36.567	54	-17.433	210	2.65	Vertical	1000000	-4.992
16.887 GHz	AVG	39.998	54	-14.002	326	1.643	Vertical	1000000	9.405
1.2481 GHz	Peak	44.56	74	-29.44	279	3.798	Horizontal	1000000	-19.791
4.8836 GHz	Peak	51.884	74	-22.116	150	3.798	Horizontal	1000000	-11.907
16.761 GHz	Peak	52.509	74	-21.491	188	1.83	Horizontal	1000000	8.929
1.2481 GHz	AVG	41.32	54	-12.68	279	3.798	Horizontal	1000000	-19.791
4.8836 GHz	AVG	41.75	54	-12.25	150	3.798	Horizontal	1000000	-11.907
16.761 GHz	AVG	39.652	54	-14.348	188	1.83	Horizontal	1000000	8.929

Table 5: Radiated Emissions within 1-17GHz Transmitting at the Middle Frequency (worst-case)

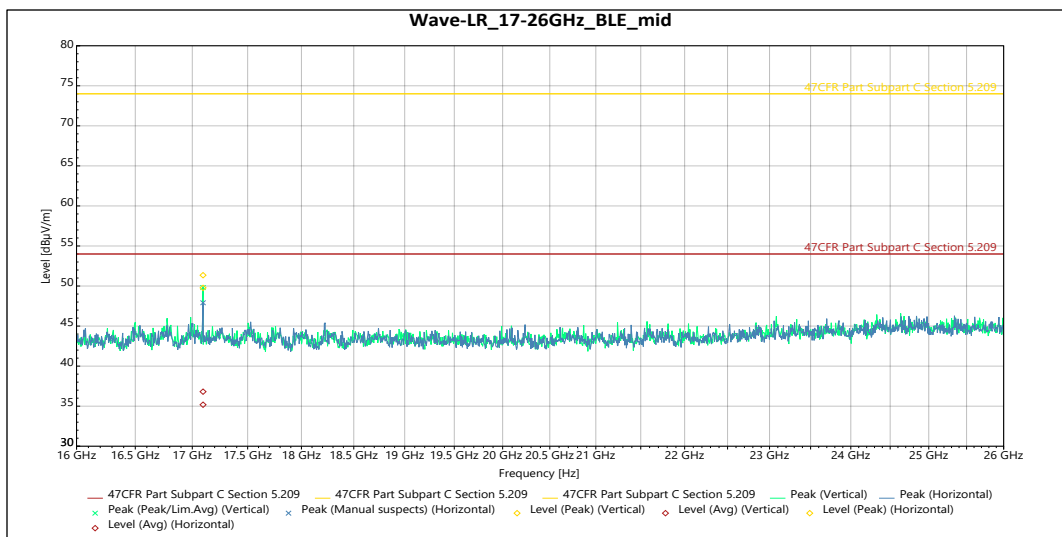

Frequency	SR #	Level (dB μ V/m)	Limit (dB μ V/m)	Margin (dB)	Azimuth (°)	Pol.	RBW (Hz)	Correction (dB)
17.096 GHz	Peak	51.355	74	-22.645	150	Vertical	1000000	-4.905
17.096 GHz	AVG	36.805	54	-17.195	150	Vertical	1000000	-4.905
17.096 GHz	Peak	49.771	74	-24.229	175	Horizontal	1000000	-4.905
17.096 GHz	AVG	35.177	54	-18.823	175	Horizontal	1000000	-4.905

Table 6: Transmitting at the Middle Frequency

5.6 §15.247(e) Maximum Average Power Spectral Density

The maximum average power spectral density conducted from the intentional radiator of the antenna shall not be greater than 8 dBm in any 3 kHz band during any time interval of continuous transmission. Results of this testing are summarized.

Frequency (MHz)	Measurement (dBm)	Criteria (dBm)
2402	-0.50	8.0
2442	-1.55	8.0
2480	-2.09	8.0

Result

The maximum average power spectral density was less than the limit of 8 dBm; therefore, the EUT complies with the specification.

-- End of Test Report --