



# FCC RADIO TEST REPORT

Applicant : Ubiquiti Inc.  
Address : 685 Third Avenue, New York, New York 10017,  
USA  
Equipment : UISP Router  
Model No. : UISP-R  
Trade Name : UBIQUITI  
FCC ID. : SWX-UISPR

**I HEREBY CERTIFY THAT :**

The sample was received on May. 04, 2021 and the testing was completed on Jul. 13, 2021 at CerpPASS Technology Corp. The test result refers exclusively to the test presented test model / sample. Without written approval of CerpPASS Technology Corp., the test report shall not be reproduced except in full.

Approved by:

Mark Liao / Supervisor

Laboratory Accreditation:

CerpPASS Technology Corporation Test Laboratory





**CONTENTS**

- 1. Summary of Test Procedure and Test Results..... 5**
  - 1.1 Applicable Standards ..... 5
- 2. Test Configuration of Equipment under Test ..... 6**
  - 2.1 Feature of Equipment under Test..... 6
  - 2.2 Carrier Frequency of Channels ..... 6
  - 2.3 Test Mode and Test Software ..... 7
  - 2.4 Description of Test System..... 7
  - 2.5 General Information of Test..... 8
  - 2.6 Measurement Uncertainty ..... 9
- 3. Test Equipment and Ancillaries Used for Tests ..... 10**
- 4. Antenna Requirements ..... 12**
  - 4.1 Standard Applicable ..... 12
  - 4.2 Antenna Construction and Directional Gain..... 12
- 5. Test of AC Power Line Conducted Emission ..... 13**
  - 5.1 Test Limit ..... 13
  - 5.2 Test Procedures ..... 13
  - 5.3 Typical Test Setup ..... 14
  - 5.4 Test Result and Data ..... 15
  - 5.5 Test Photographs ..... 17
- 6. Test of Spurious Emission (Radiated) ..... 18**
  - 6.1 Test Limit ..... 18
  - 6.2 Test Procedures ..... 19
  - 6.3 Typical Test Setup ..... 20
  - 6.4 Test Result and Data (9kHz ~ 30MHz)..... 22
  - 6.5 Test Result and Data (30MHz ~ 1GHz)..... 22
  - 6.6 Test Result and Data (1GHz ~ 25GHz)..... 24
  - 6.7 Restricted Bands of Operation ..... 30
  - 6.8 Test Photographs (30MHz ~ 1GHz)..... 31
  - 6.9 Test Photographs (1GHz ~ 25GHz) ..... 32
- 7. Test of Spurious Emission (Conducted)..... 34**
  - 7.1 Test Limit ..... 34
  - 7.2 Test Procedure ..... 34
  - 7.3 Test Setup Layout ..... 34
  - 7.4 Test Result and Data ..... 34
- 8. On Time, Duty Cycle and Measurement methods ..... 37**
  - 8.1 Test Limit ..... 37
  - 8.2 Test Procedure ..... 37
  - 8.3 Test Setup Layout ..... 37
  - 8.4 Test Result and Data ..... 37
- 9. 6dB Bandwidth Measurement Data ..... 39**
  - 9.1 Test Limit ..... 39



9.2 Test Procedures ..... 39

9.3 Test Setup Layout ..... 39

9.4 Test Result and Data ..... 39

**10. Maximum Peak and Average Output Power ..... 41**

10.1 Test Limit ..... 41

10.2 Test Procedures ..... 41

10.3 Test Setup Layout ..... 41

10.4 Test Result and Data ..... 41

**11. Power Spectral Density ..... 42**

11.1 Test Limit ..... 42

11.2 Test Procedures ..... 42

11.3 Test Setup Layout ..... 42

11.4 Test Result and Data ..... 42

**12. Radio Frequency Exposure ..... 44**

12.1 Applicable Standards ..... 44

12.2 EUT Specification ..... 44

12.3 Test Results ..... 45

12.4 Calculation ..... 45

12.5 Maximum Permissible Exposure ..... 46



### History of this test report

Report No.	Issue Date	Description
21050017-TRFCC01	Jul. 15, 2021	Original



# 1. Summary of Test Procedure and Test Results

## 1.1 Applicable Standards

**ANSI C63.10:2013**

**FCC Rules and Regulations Part 15 Subpart C §15.247**

FCC Rule	Description of Test	Result
15.203	Antenna Requirement	PASS
15.207	AC Power Line Conducted Emission	PASS
15.209 15.205	Radiated Spurious Emission	PASS
15.247(d)	Conducted Spurious Emission	PASS
15.247(a)(2)	6dB Bandwidth	PASS
15.247(b)	Maximum Peak Output Power	PASS
15.247(e)	Power Spectral Density	PASS

\*The lab has reduced the uncertainty risk factor from test equipment, environment and staff technicians which according to the standard on contract. Therefore, the test result will only be determined by standard requirement.

\*This EUT has been also tested and compiled with the requirement of FCC Part 15, Subpart B, recorded in a separate test report(21050017-TEFV01).



## 2. Test Configuration of Equipment under Test

### 2.1 Feature of Equipment under Test

Frequency Range	2402-2480MHz
Modulation Type	GFSK
Modulation Technology	DTS
Data Rate	1Mbps
Antenna Type	Internal Antenna
Antenna Gain	1.7 dBi
Adapter	Brand: N/A Model: UACC-Adapter-PT-120W
Power Cord	Brand: N/A Model:N/A
DC Cable	Brand: N/A Model:N/A
Firmware Number	1.12.1
Serial Number	2123A 68D79A1F5D42-7WITd0

Note: For more details, please refer to the User's manual of the EUT.

### 2.2 Carrier Frequency of Channels

Channel	Frequency (MHz)	Channel	Frequency (MHz)	Channel	Frequency (MHz)
<b>*00</b>	<b>2402</b>	14	2430	28	2458
01	2404	15	2432	29	2460
02	2406	16	2434	30	2462
03	2408	17	2436	31	2464
04	2410	18	2438	32	2466
05	2412	<b>*19</b>	<b>2440</b>	33	2468
06	2414	20	2442	34	2470
07	2416	21	2444	35	2472
08	2418	22	2446	36	2474
09	2420	23	2448	37	2476
10	2422	24	2450	38	2478
11	2424	25	2452	<b>*39</b>	<b>2480</b>
12	2426	26	2454	--	--
13	2428	27	2456	--	--

Note: Channels remarked \* are selected to perform test.



### 2.3 Test Mode and Test Software

- a. During testing, the interface cables and equipment positions were varied according to ANSI C63.10.
- b. The complete test system included Notebook and EUT for RF test.
- c. An executive program, " hcitool command" under Windows OS system was executed to transmit and receive data via Bluetooth.
- d. The following test modes were performed for the test:

Test Mode	Operating Description
1	GFSK (1Mbps)

Modulation Type	TX CONFIGURATION
GFSK	1TX

### 2.4 Description of Test System

RF Conducted				
Equipment	Brand	Model	Length/Type	Power cord/Length/Type
Notebook	ASUS	P2430U	N/A	Adapter / 1.8m / NS
RJ45 Cable	N/A	N/A	1.2m / NS	N/A
Radiated Emissions				
Equipment	Brand	Model	Length/Type	Power cord/Length/Type
Notebook	ASUS	P2430U	N/A	Adapter / 1.8m / NS
RJ45 Cable	N/A	N/A	1.2m / NS	N/A
AC Power Line Conducted Emission				
Equipment	Brand	Model	Length/Type	Power cord/Length/Type
Notebook	ASUS	P2430U	N/A	Adapter / 1.8m / NS
RJ45 Cable	N/A	N/A	1.2m / NS	N/A



## 2.5 General Information of Test

Test Site	<b>CerpPASS Technology Corporation Test Laboratory</b> Address: No.10, Ln. 2, Lianfu St., Luzhu Dist., Taoyuan City 33848, Taiwan (R.O.C.) Tel:+886-3-3226-888 Fax:+886-3-3226-881	
	FCC	TW1439, TW1079
	IC	4934E-1, 4934E-2
	VCCI	T-2205 for Telecommunication test C-4663 for Conducted emission test R-4218 for Radiated emission test G-10812, G-10813 for radiated disturbance above 1GHz
Frequency Range Investigated:	Conducted: from 150kHz to 30 MHz Radiation: from 30 MHz to 25,000MHz	
Test Distance:	The test distance of radiated emission from antenna to EUT is 3 M.	

Test Item	Test Site	Test period	Environmental Conditions	Tested By
RF Conducted	RFCON01-NK	2021/05/18	23.5°C / 50%	Nick Guan
Radiated Emissions, for above 1GHz.	3M02-NK	2021/05/18	21.1°C / 37%	Nick Guan
Radiated Emissions, for below 1GHz.	3M02-NK	2021/07/12	23°C / 42%	Nick Guan
AC Power Line Conducted Emission	CON01-NK	2021/07/13	29°C / 59%	Dian Chen





## 2.6 Measurement Uncertainty

Measurement Item	Uncertainty
AC Power Line Conduction(150K~30MHz)	±3.63dB
Radiated Spurious Emission(9KHz~30MHz)	±3.4dB
Radiated Spurious Emission(30MHz~1GHz)	±5.6dB
Radiated Spurious Emission(1GHz~25GHz)	±6.6dB
Conducted Spurious Emission	±1.8dB
6dB Bandwidth	±4.4%
20dB Bandwidth	±4.4%
Occupied Bandwidth	±4.4%
Peak Output Power(Conducted Power Meter)	±1.1dB
Dwell Time / Deactivation Time	±1.2%
Power Spectral Density	±1.8dB
Duty Cycle	±1.2%



### 3. Test Equipment and Ancillaries Used for Tests

Test Item	Radiated Emissions, for above 1GHz.				
Test Site	Semi Anechoic Room(3M02-NK)				
Instrument	Manufacturer	Model No	Serial No	Calibration Date	Valid Date
Horn Antenna	EMCO	3115	31601	2020/10/16	2021/10/15
Horn Antenna	EMCO	3116	31974	2020/09/24	2021/09/23
Spectrum Analyzer	ROHDE & SCHWARZ	FSV 40-N	102151	2020/08/03	2021/08/02
Preamplifier	Agilent	8449B	3008A01954	2021/03/22	2022/03/21
Preamplifier	EMC INSTRUMENTS	EMC184045	980065	2020/11/06	2021/11/05
Bluetooth Tester	ROHDE & SCHWARZ	CBT	101133	2021/04/19	2022/04/18
Cable-0.5m(1G-18G)	HUBER SUHNER	SUCOFLEX 104	805443/4	2020/05/27	2021/05/26
Cable-3m(1G-18G)	HUBER SUHNER	SUCOFLEX 104	805796/4	2020/05/27	2021/05/26
Cable-8m(1G-18G)	HUBER SUHNER	SUCOFLEX 104	805795/4	2020/05/27	2021/05/26
Cable-0.5m(30M-40G)	HUBER SUHNER	SUCOFLEX 102	28420/2	2021/04/03	2022/04/02
Cable-3m(30M-40G)	HUBER SUHNER	SUCOFLEX 102	MY2608/2	2021/04/09	2022/04/08
Cable-0.5m(1G-40G)	Rapidtek	40GHZ 50CM	38MS-38MS50 314	2021/04/08	2022/04/07
E3	AUDIX	v8.2014-8-6	RK-000529	NA	NA

Test Item	Radiated Emissions, for below 1GHz.				
Test Site	Semi Anechoic Room(3M02-NK)				
Instrument	Manufacturer	Model No	Serial No	Calibration Date	Valid Date
Bilog Antenna	Schwarzbeck	VULB9168	369	2021/04/26	2022/04/25
Active Loop Antenna	EMCO	6507	40855	2021/06/10	2022/06/09
EMI Receiver	ROHDE & SCHWARZ	ESCI	101423	2021/06/30	2022/06/29
Preamplifier	EM Electronics corp.	EM330	60658	2020/10/20	2021/10/19
Preamplifier	EM Electronics corp.	EM330	60660	2021/03/18	2022/03/17
Bluetooth Tester	ROHDE & SCHWARZ	CBT	101133	2021/04/19	2022/04/18
Cable-3in1(30M-1G)	HARBOUR INDUSTRIES	LL142	CCE1315	2021/04/12	2022/04/11
Cable-0.5m(30M-40G)	HUBER SUHNER	SUCOFLEX 102	28420/2	2021/04/03	2022/04/02
Cable-3m(30M-40G)	HUBER SUHNER	SUCOFLEX 102	MY2608/2	2021/04/09	2022/04/08
Cable-6m(9k~300M)	NA	EMC5D-BM-BM-6	130605	2020/09/18	2021/09/17
E3	AUDIX	v8.2014-8-6	RK-000529	NA	NA



Test Item	RF Conducted				
Test Site	RFCON01-NK				
Instrument	Manufacturer	Model No	Serial No	Calibration Date	Valid Date
Spectrum Analyzer	ROHDE & SCHWARZ	FSV 40-N	101329	2020/07/07	2021/07/06
Bluetooth Tester	ROHDE & SCHWARZ	CBT	101133	2021/04/19	2022/04/18
CAX Signal Analyzer	KEYSIGHT	N9000B	MY57100339	2020/12/25	2021/12/24
Attenuator	KEYSIGHT	8491B	MY39250703	2021/04/09	2022/04/08
TEMP & HUMIDITY CHAMBER	T-MACHINE	TMJ-9712	T-12-040111	2020/08/25	2021/08/24
Power Meter	Anritsu	ML2495A	1224005	2021/04/14	2022/04/13
Power Sensor	Anritsu	MA2411B	1207295	2021/04/14	2022/04/13

Test Item	AC Power Line Conducted Emission				
Test Site	CON01-NK				
Instrument	Manufacturer	Model No	Serial No	Calibration Date	Valid Date
EMI Receiver	ROHDE & SCHWARZ	ESCI	100821	2020/09/11	2021/09/10
Line Impedance Stabilization Network	Schwarzbeck	NSLK 8127	8127-516	2020/09/26	2021/09/25
Pulse Limiter	ROHDE & SCHWARZ	ESH3-Z2	101933	2020/09/17	2021/09/16
Cable-6m(9k~300M)	NA	EMC5D-BM-BM-6	130605	2020/09/18	2021/09/17
E3	AUDIX	v8.2014-8-6	RK-000531	NA	NA



## 4. Antenna Requirements

### 4.1 Standard Applicable

For intentional device, according to FCC 47 CFR Section 15.203, an intentional radiator shall be designed to ensure that no antenna other than that furnished by the responsible party shall be used with the device.

And according to FCC 47 CFR Section 15.247 (b), if transmitting antennas of directional gain greater than 6dBi are used, the power shall be reduced by the amount in dB that the directional gain of the antenna exceeds 6dBi.

### 4.2 Antenna Construction and Directional Gain

Antenna Type	Internal Antenna
Antenna Gain	1.70 dBi



## 5. Test of AC Power Line Conducted Emission

The power supply is DC source, so this item doesn't require testing.

### 5.1 Test Limit

Conducted Emissions were measured from 150 kHz to 30 MHz with a bandwidth of 9 KHz, according to the methods defined in ANSI C63.4-2014. The EUT was placed on a nonmetallic stand in a shielded room 0.8 meters above the ground plane. The interface cables and equipment positioning were varied within limits of reasonable applications to determine the position produced maximum conducted emissions.

Frequency (MHz)	Quasi Peak (dB $\mu$ V)	Average (dB $\mu$ V)
0.15 – 0.5	66-56*	56-46*
0.5 – 5.0	56	46
5.0 – 30.0	60	50

\*Decreases with the logarithm of the frequency.

### 5.2 Test Procedures

- a. The EUT was placed 0.4 meter from the conducting wall of the shielding room was kept at least 80 centimeters from any other grounded conducting surface.
- b. Connect EUT to the power mains through a line impedance stabilization network (LISN).
- c. All the support units are connecting to the other LISN.
- d. The LISN provides 50 ohm coupling impedance for the measuring instrument.
- e. The FCC states that a 50 ohm, 50 micro-Henry LISN should be used.
- f. Both sides of AC line were checked for maximum conducted interference.
- g. The frequency range from 150 kHz to 30 MHz was searched.
- h. Set the test-receiver system to Peak Detect Function and Specified Bandwidth with Maximum Hold Mode.



### 5.3 Typical Test Setup

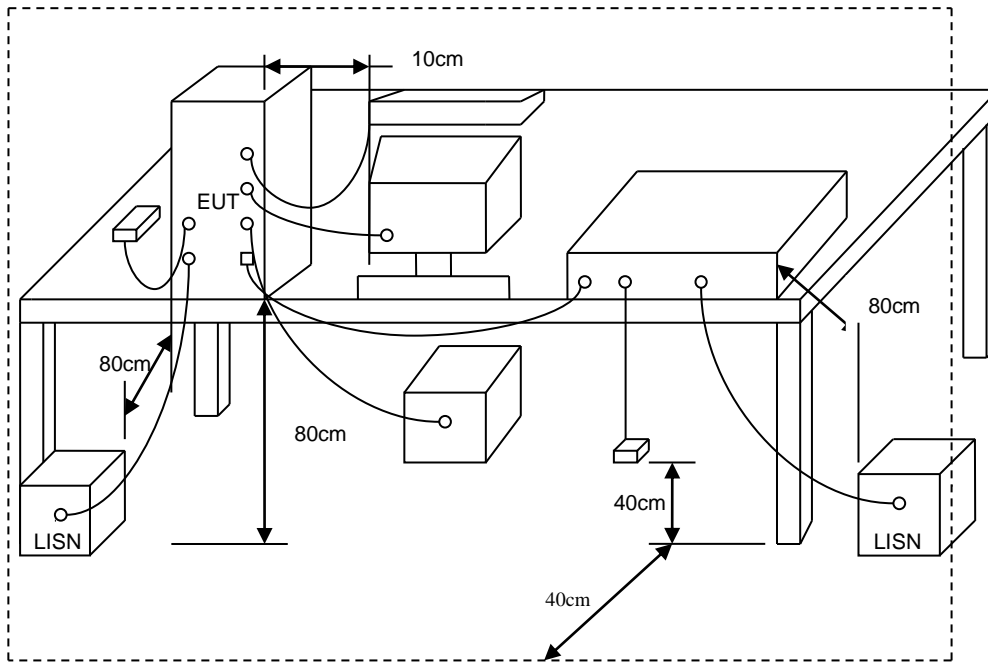



5.4 Test Result and Data

Power	: AC 120V / 60Hz	Pol/Phase	: LINE
Test Mode	: Mode 1		:

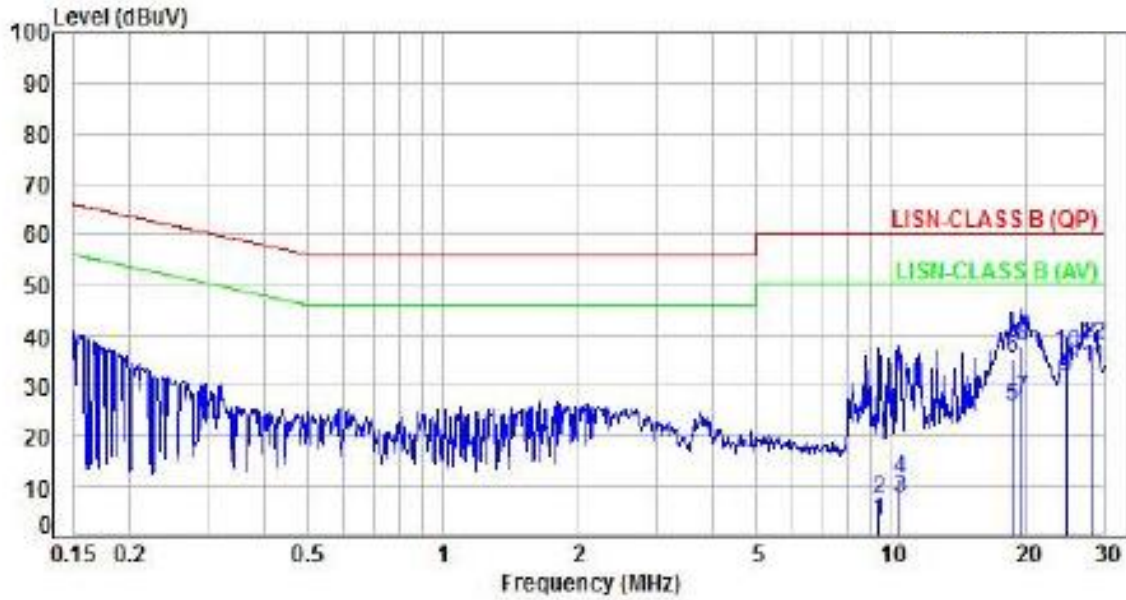

No.	Frequency (MHz)	Factor (dB)	Reading (dBuV)	Level (dBuV)	Limit (dBuV)	Margin (dB)	Detector	P/F
1	9.48	10.31	-7.38	2.93	50.00	-47.07	Average	P
2	9.48	10.31	-3.15	7.16	60.00	-52.84	QP	P
3	10.47	10.33	-2.62	7.71	50.00	-42.29	Average	P
4	10.47	10.33	1.03	11.36	60.00	-48.64	QP	P
5	18.72	10.60	15.19	25.79	50.00	-24.21	Average	P
6	18.72	10.60	24.81	35.41	60.00	-24.59	QP	P
7	19.63	10.62	16.59	27.21	50.00	-22.79	Average	P
8	19.63	10.62	26.85	37.47	60.00	-22.53	QP	P
9	24.66	10.81	20.58	31.39	50.00	-18.61	Average	P
10	24.66	10.81	25.75	36.56	60.00	-23.44	QP	P
11	28.00	10.92	22.43	33.35	50.00	-16.65	Average	P
12	28.00	10.92	26.99	37.91	60.00	-22.09	QP	P

Note: Level=Reading+Factor  
 Margin=Level-Limit  
 Factor=(LISM or ISN or Current Probe)Factor + Cable Loss



Power	: AC 120V / 60Hz	Pol/Phase	: NEUTRAL
Test Mode	: Mode 1		

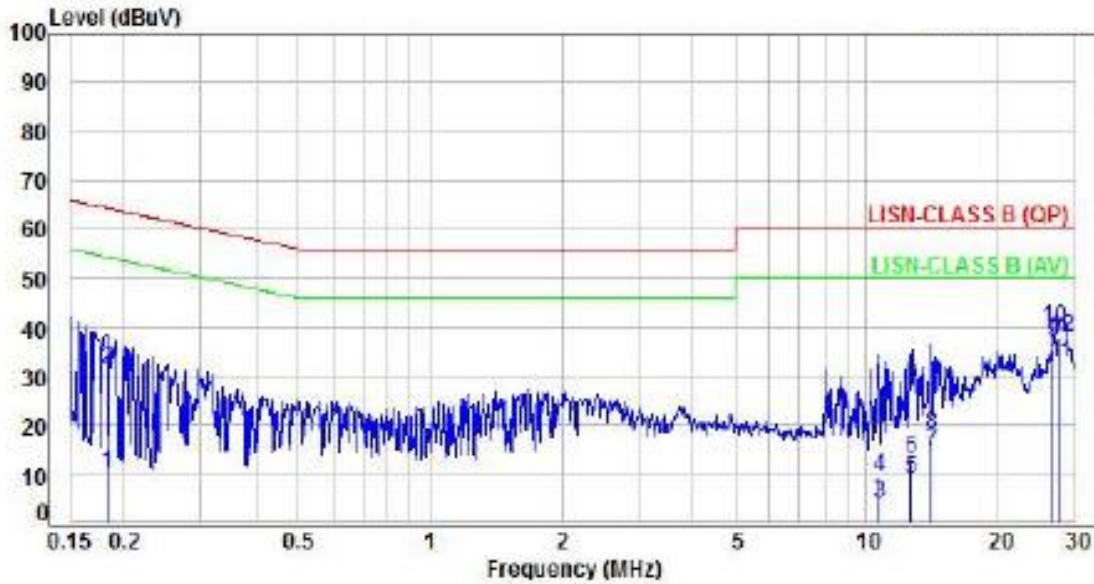

No.	Frequency (MHz)	Factor (dB)	Reading (dBuV)	Level (dBuV)	Limit (dBuV)	Margin (dB)	Detector	P/F
1	0.18	9.95	0.40	10.35	54.37	-44.02	Average	P
2	0.18	9.95	21.68	31.63	64.37	-32.74	QP	P
3	10.66	10.37	-6.08	4.29	50.00	-45.71	Average	P
4	10.66	10.37	-0.93	9.44	60.00	-50.56	QP	P
5	12.66	10.45	-1.21	9.24	50.00	-40.76	Average	P
6	12.66	10.45	2.94	13.39	60.00	-46.61	QP	P
7	14.06	10.50	4.04	14.54	50.00	-35.46	Average	P
8	14.06	10.50	7.75	18.25	60.00	-41.75	QP	P
9	26.62	10.90	25.87	36.77	50.00	-13.23	Average	P
10	26.62	10.90	29.01	39.91	60.00	-20.09	QP	P
11	27.66	10.93	21.70	32.63	50.00	-17.37	Average	P
12	27.66	10.93	27.01	37.94	60.00	-22.06	QP	P

Note: Level=Reading+Factor  
 Margin=Level-Limit  
 Factor=(LISN or ISN or Current Probe)Factor + Cable Loss





## 6. Test of Spurious Emission (Radiated)

### 6.1 Test Limit

In any 100kHz bandwidth outside the frequency band in which the spread spectrum or digitally modulated intentional radiator is operating, the radio frequency power that is produced by the intentional radiator shall be at least 20dB below that in the 100kHz bandwidth within the band that contains the highest level of the desired power, based on either an RF conducted or a radiated measurement. If the transmitter measurement is based on the maximum conducted output power, the attenuation required under this paragraph shall be 30dB instead of 20dB. In addition, radiated emissions which fall in section 15.205(a) the restricted bands must also comply with the radiated emission limit specified in section 15.209(a).

Frequency (MHz)	Field Strength (microvolt/meter)	Measurement Distance (meters)
0.009 ~ 0.490	2400/F(kHz)	300
0.490 ~ 1.705	24000/F(kHz)	30
1.705 ~ 30.0	30	30
30 ~ 88	100	3
88 ~ 216	150	3
216 ~ 960	200	3
Above 960	500	3



## 6.2 Test Procedures

- a. The EUT was placed on a rotatable table top 0.8 meter above ground.
- b. The EUT was set 3 meters from the interference receiving antenna which was mounted on the top of a variable height antenna tower.
- c. The table was rotated 360 degrees to determine the position of the highest radiation.
- d. The antenna is a broadband antenna and its height is varied between one meter and four meters above ground to find the maximum value of the field strength both horizontal polarization and vertical polarization of the antenna are set to make the measurement.
- e. For each suspected emission the EUT was arranged to its worst case and then tune the antenna tower (from 1 M to 4 M) and turn table (from 0 degree to 360 degrees) to find the maximum reading.
- f. Set the test-receiver system to Peak or CISPR quasi-peak Detect Function and specified bandwidth with Maximum Hold Mode.
- g. If the emission level of the EUT in peak mode was 3 dB lower than the limit specified, then testing will be stopped and peak values of EUT will be reported, otherwise, the emissions which do not have 3 dB margin will be repeated one by one using the quasi-peak method and reported.
- h. For testing above 1GHz, the emission level of the EUT in peak mode was 20dB lower than average limit (that means the emission level in peak mode also complies with the limit in average mode), then testing will be stopped and peak values of EUT will be reported, otherwise, the emissions will be measured in average mode again and reported.
- i. "Cone of radiation" has been considered to be 3dB bandwidth of the measurement antenna.

Note: The supporting fixture shall permit orientation of the EUT in each of three orthogonal axis positions such that emissions from the EUT are maximized.  
(X-AXIS is the worst.)



### 6.3 Typical Test Setup

Below 30MHz test setup

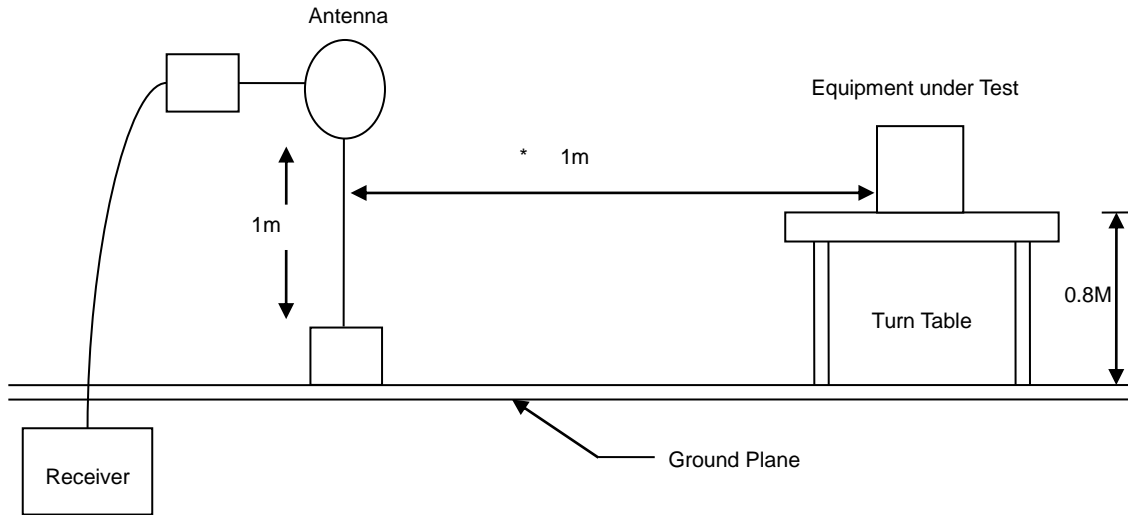

30MHz- 1GHz Test Setup

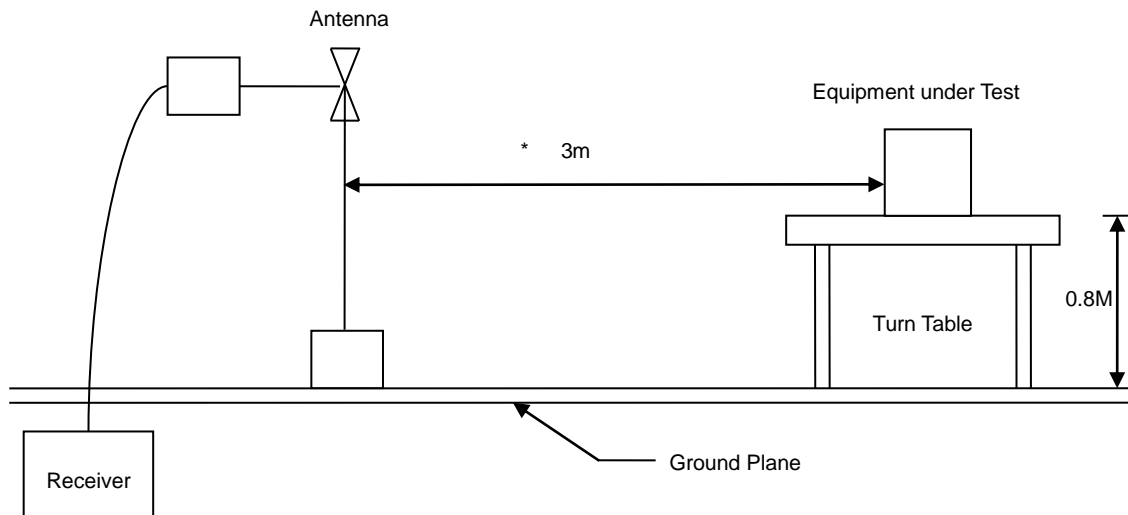



Above 1GHz Test Setup

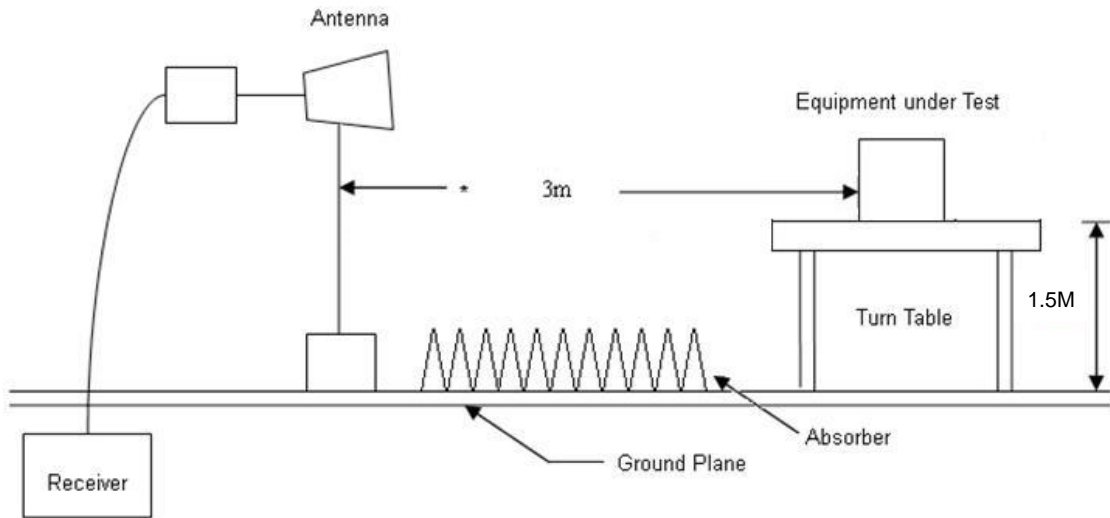



### 6.4 Test Result and Data (9kHz ~ 30MHz)

The 9kHz - 30MHz spurious emission is under limit 20dB more.

### 6.5 Test Result and Data (30MHz ~ 1GHz)

Power	: AC 120V / 60Hz	Pol/Phase	: VERTICAL
Test Mode	: Mode 1		:

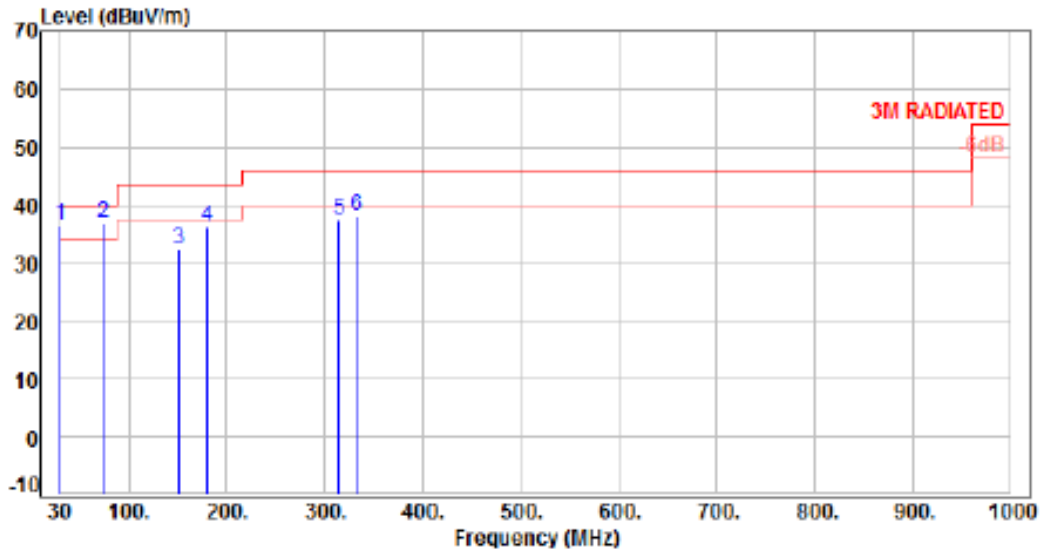

No.	Frequency (MHz)	Factor (dB)	Reading (dBuV)	Level (dBuV/m)	Limit (dBuV/m)	Margin (dB)	Detector	Height (cm)	Azimuth (deg)	P/F
1	30.00	-11.62	48.24	36.62	40.00	-3.38	QP	100	231	P
2	73.65	-13.37	50.21	36.84	40.00	-3.16	QP	100	138	P
3	150.45	-10.88	43.27	32.39	43.50	-11.11	Peak	400	360	P
4	179.46	-12.07	48.39	36.32	43.50	-7.18	Peak	400	360	P
5	315.32	-9.32	46.78	37.46	46.00	-8.54	Peak	400	360	P
6	332.84	-8.71	46.68	37.97	46.00	-8.03	Peak	400	360	P

Note: Level=Reading+Factor  
 Margin=Level-Limit  
 Factor=Antenna Factor + cable loss - Amplifier Factor



Power	: AC 120V / 60Hz	Pol/Phase	: HORIZONTAL
Test Mode	: Mode 1		:

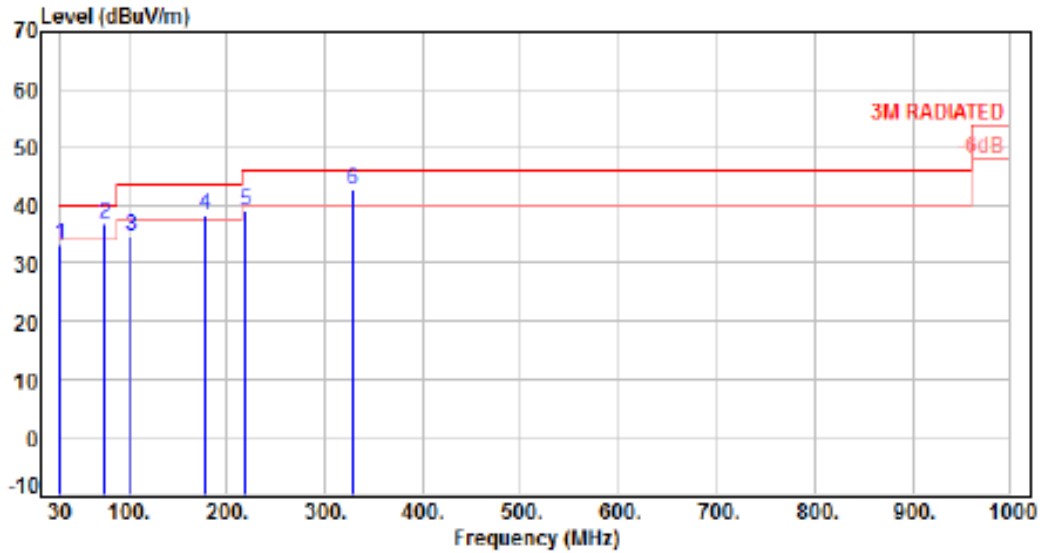

No.	Frequency (MHz)	Factor (dB)	Reading (dBuV)	Level (dBuV/m)	Limit (dBuV/m)	Margin (dB)	Detector	Height (cm)	Azimuth (deg)	P/F
1	30.00	-11.62	44.68	33.06	40.00	-6.94	Peak	400	360	P
2	74.54	-13.55	50.27	36.72	40.00	-3.28	Peak	400	360	P
3	101.55	-15.37	50.16	34.79	43.50	-8.71	Peak	400	360	P
4	177.78	-11.86	50.22	38.36	43.50	-5.14	Peak	400	360	P
5	218.45	-12.79	51.67	38.88	46.00	-7.12	Peak	400	360	P
6	328.78	-8.84	51.59	42.75	46.00	-3.25	Peak	400	360	P

Note: Level=Reading+Factor  
Margin=Level-Limit  
Factor=Antenna Factor + cable loss - Amplifier Factor



6.6 Test Result and Data (1GHz ~ 25GHz)

Power	: AC 120V / 60Hz	Pol/Phase	: VERTICAL
Test Mode	: Mode 1, CH00		

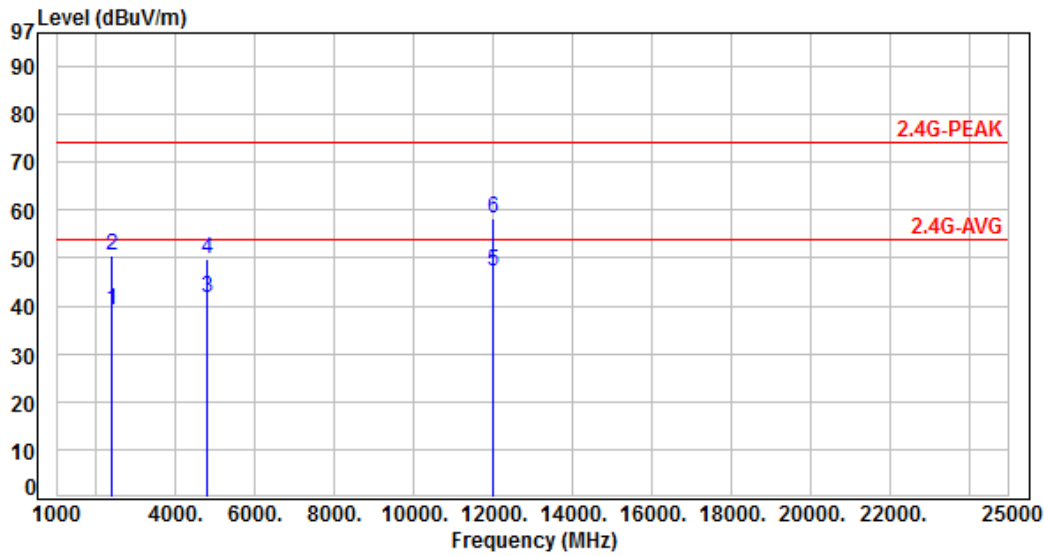

No.	Frequency (MHz)	Factor (dB)	Reading (dBuV)	Level (dBuV/m)	Limit (dBuV/m)	Margin (dB)	Detector	Height (cm)	Azimuth (deg)	P/F
1	2390.00	-2.98	42.04	39.06	54.00	-14.94	Average	386	345	P
2	2390.00	-2.98	53.46	50.48	74.00	-23.52	Peak	386	345	P
3	4804.00	4.56	36.99	41.55	54.00	-12.45	Average	100	157	P
4	4804.00	4.56	45.41	49.97	74.00	-24.03	Peak	100	157	P
5	12010.00	14.61	32.62	47.23	54.00	-6.77	Average	100	327	P
6	12010.00	14.61	43.78	58.39	74.00	-15.61	Peak	100	327	P

Note: Level=Reading+Factor  
 Margin=Level-Limit  
 Factor=Antenna Factor + cable loss - Amplifier Factor



Power	: AC 120V / 60Hz	Pol/Phase	: HORIZONTAL
Test Mode	: Mode 1, CH00		:

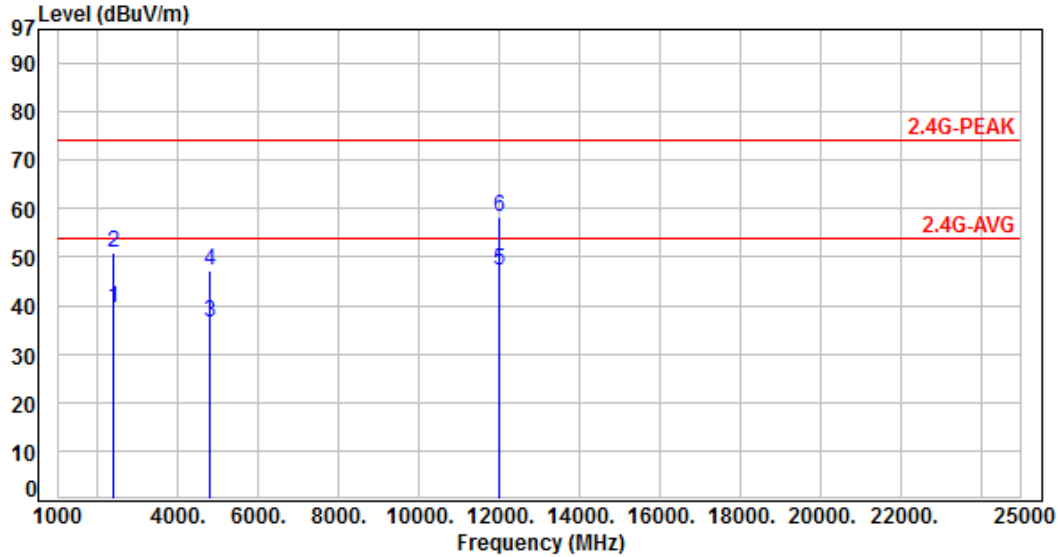

No.	Frequency (MHz)	Factor (dB)	Reading (dBuV)	Level (dBuV/m)	Limit (dBuV/m)	Margin (dB)	Detector	Height (cm)	Azimuth (deg)	P/F
1	2390.00	-2.98	42.41	39.43	54.00	-14.57	Average	381	65	P
2	2390.00	-2.98	53.89	50.91	74.00	-23.09	Peak	381	65	P
3	4804.00	4.56	32.06	36.62	54.00	-17.38	Average	100	274	P
4	4804.00	4.56	42.59	47.15	74.00	-26.85	Peak	100	274	P
5	12010.00	14.61	32.71	47.32	54.00	-6.68	Average	100	86	P
6	12010.00	14.61	43.82	58.43	74.00	-15.57	Peak	100	86	P

Note: Level=Reading+Factor  
 Margin=Level-Limit  
 Factor=Antenna Factor + cable loss - Amplifier Factor





Power	: AC 120V / 60Hz	Pol/Phase	: VERTICAL
Test Mode	: Mode 1, CH19		:

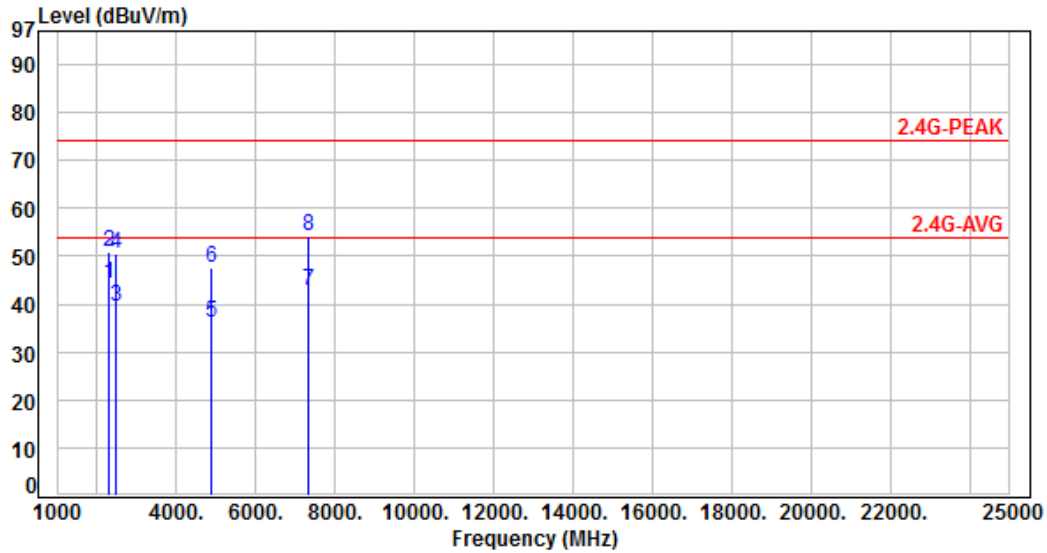

No.	Frequency (MHz)	Factor (dB)	Reading (dBuV)	Level (dBuV/m)	Limit (dBuV/m)	Margin (dB)	Detector	Height (cm)	Azimuth (deg)	P/F
1	2310.06	-3.31	47.71	44.40	54.00	-9.60	Average	374	344	P
2	2310.06	-3.31	54.09	50.78	74.00	-23.22	Peak	374	344	P
3	2483.50	-2.75	42.10	39.35	54.00	-14.65	Average	374	344	P
4	2483.50	-2.75	53.43	50.68	74.00	-23.32	Peak	374	344	P
5	4880.00	4.80	31.43	36.23	54.00	-17.77	Average	100	299	P
6	4880.00	4.80	42.86	47.66	74.00	-26.34	Peak	100	299	P
7	7320.00	9.71	33.22	42.93	54.00	-11.07	Average	100	58	P
8	7320.00	9.71	44.59	54.30	74.00	-19.70	Peak	100	58	P

Note: Level=Reading+Factor  
Margin=Level-Limit  
Factor=Antenna Factor + cable loss - Amplifier Factor



Power	: AC 120V / 60Hz	Pol/Phase	: HORIZONTAL
Test Mode	: Mode 1, CH19		:

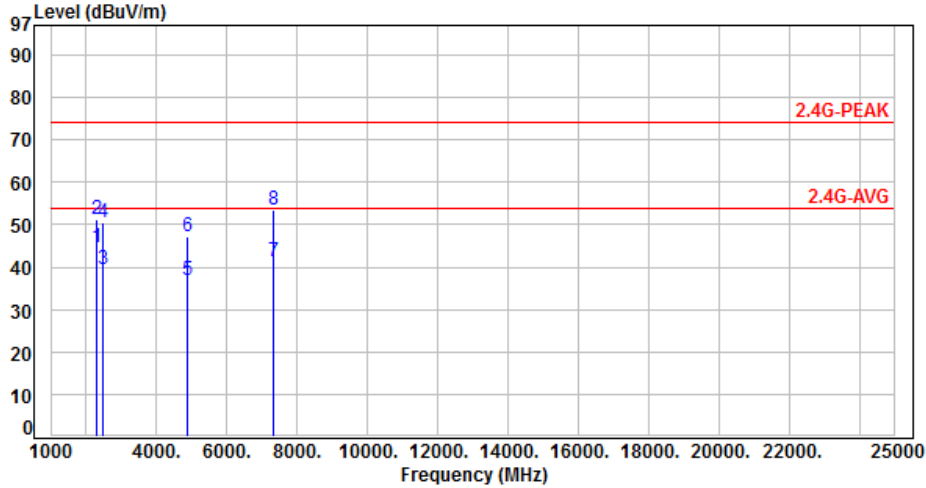

No.	Frequency (MHz)	Factor (dB)	Reading (dBuV)	Level (dBuV/m)	Limit (dBuV/m)	Margin (dB)	Detector	Height (cm)	Azimuth (deg)	P/F
1	2310.00	-3.31	48.01	44.70	54.00	-9.30	Average	284	64	P
2	2310.00	-3.31	54.70	51.39	74.00	-22.61	Peak	284	64	P
3	2483.50	-2.75	42.29	39.54	54.00	-14.46	Average	284	64	P
4	2483.50	-2.75	53.39	50.64	74.00	-23.36	Peak	284	64	P
5	4880.00	4.80	31.96	36.76	54.00	-17.24	Average	100	76	P
6	4880.00	4.80	42.54	47.34	74.00	-26.66	Peak	100	76	P
7	7320.00	9.71	31.44	41.15	54.00	-12.85	Average	100	89	P
8	7320.00	9.71	43.83	53.54	74.00	-20.46	Peak	100	89	P

Note: Level=Reading+Factor  
 Margin=Level-Limit  
 Factor=Antenna Factor + cable loss - Amplifier Factor



Power	: AC 120V / 60Hz	Pol/Phase	: VERTICAL
Test Mode	: Mode 1, CH39		:

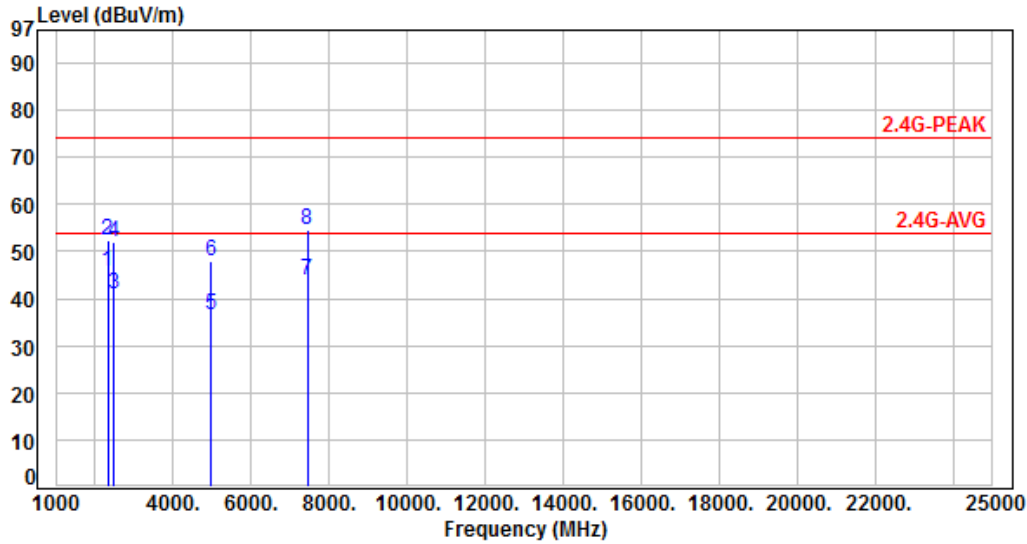

No.	Frequency (MHz)	Factor (dB)	Reading (dBuV)	Level (dBuV/m)	Limit (dBuV/m)	Margin (dB)	Detector	Height (cm)	Azimuth (deg)	P/F
1	2323.80	-3.21	48.82	45.61	54.00	-8.39	Average	361	334	P
2	2323.80	-3.21	55.71	52.50	74.00	-21.50	Peak	361	334	P
3	2483.50	-2.75	43.76	41.01	54.00	-12.99	Average	356	24	P
4	2483.50	-2.75	54.73	51.98	74.00	-22.02	Peak	356	24	P
5	4960.00	5.16	31.20	36.36	54.00	-17.64	Average	100	53	P
6	4960.00	5.16	42.66	47.82	74.00	-26.18	Peak	100	53	P
7	7440.00	9.83	33.88	43.71	54.00	-10.29	Average	280	57	P
8	7440.00	9.83	44.78	54.61	74.00	-19.39	Peak	280	57	P

Note: Level=Reading+Factor  
 Margin=Level-Limit  
 Factor=Antenna Factor + cable loss - Amplifier Factor



Power	: AC 120V / 60Hz	Pol/Phase	: HORIZONTAL
Test Mode	: Mode 1, CH39		:

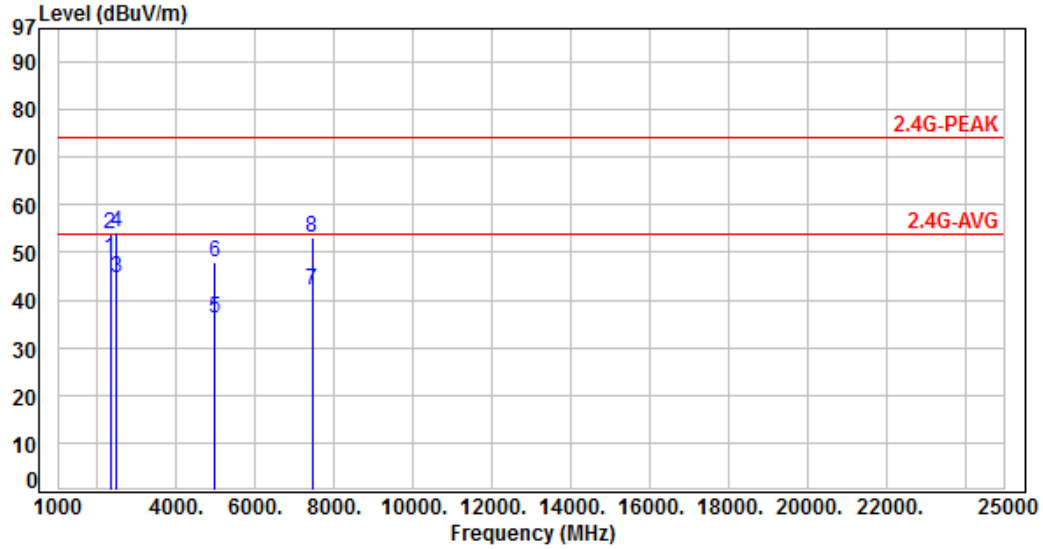

No.	Frequency (MHz)	Factor (dB)	Reading (dBuV)	Level (dBuV/m)	Limit (dBuV/m)	Margin (dB)	Detector	Height (cm)	Azimuth (deg)	P/F
1	2323.80	-3.21	51.86	48.65	54.00	-5.35	Average	315	42	P
2	2323.80	-3.21	56.94	53.73	74.00	-20.27	Peak	315	42	P
3	2483.50	-2.75	47.43	44.68	54.00	-9.32	Average	217	70	P
4	2483.50	-2.75	57.14	54.39	74.00	-19.61	Peak	217	70	P
5	4960.00	5.16	31.06	36.22	54.00	-17.78	Average	100	137	P
6	4960.00	5.16	42.62	47.78	74.00	-26.22	Peak	100	137	P
7	7440.00	9.83	32.22	42.05	54.00	-11.95	Average	100	97	P
8	7440.00	9.83	43.46	53.29	74.00	-20.71	Peak	100	97	P

Note: Level=Reading+Factor  
 Margin=Level-Limit  
 Factor=Antenna Factor + cable loss - Amplifier Factor



### 6.7 Restricted Bands of Operation

Only spurious emissions are permitted in any of the frequency bands listed below:

MHz	MHz	MHz	GHz
0.09000 – 0.11000	16.42000 – 16.42300	399.9 – 410.0	4.500 – 5.250
0.49500 – 0.505**	16.69475 – 16.69525	608.0 – 614.0	5.350 – 5.460
2.17350 – 2.19050	16.80425 – 16.80475	960.0 – 1240.0	7.250 – 7.750
4.12500 – 4.12800	25.50000 – 25.67000	1300.0 – 1427.0	8.025 – 8.500
4.17725 – 4.17775	37.50000 – 38.25000	1435.0 – 1626.5	9.000 – 9.200
4.20725 – 4.20775	73.00000 – 74.60000	1645.5 – 1646.5	9.300 – 9.500
6.21500 – 6.21800	74.80000 – 75.20000	1660.0 – 1710.0	10.600 – 12.700
6.26775 – 6.26825	108.00000 – 121.94000	1718.8 – 1722.2	13.250 – 13.400
6.31175 – 6.31225	123.00000 – 138.00000	2200.0 – 2300.0	14.470 – 14.500
8.29100 – 8.29400	149.90000 – 150.05000	2310.0 – 2390.0	15.350 – 16.200
8.36200 – 8.36600	156.52475 – 156.52525	2483.5 – 2500.0	17.700 – 21.400
8.37625 – 8.38675	156.70000 – 156.90000	2655.0 – 2900.0	22.010 – 23.120
8.41425 – 8.41475	162.01250 – 167.17000	3260.0 – 3267.0	23.600 – 24.000
12.29000 – 12.29300	167.72000 – 173.20000	3332.0 – 3339.0	31.200 – 31.800
12.51975 – 12.52025	240.00000 – 285.00000	3345.8 – 3358.0	36.430 – 36.500
12.57675 – 12.57725	322.00000 – 335.40000	3600.0 – 4400.0	Above 38.6
13.36000 – 13.41000			

\*\* : Until February 1, 1999, this restricted band shall be 0.490-0.510 MHz



## 7. Test of Spurious Emission (Conducted)

### 7.1 Test Limit

Below -20dB of the highest emission level of operating band (In 100 kHz Resolution Bandwidth)

### 7.2 Test Procedure

- a. The transmitter output was connected to the spectrum analyzer via a low loss cable.
- b. Set RBW of spectrum analyzer to 100 KHz and VBW of spectrum analyzer to 300 KHz with convenient frequency span including 100 KHz bandwidth from band edge.
- c. Peak conducted output power measured within any 100 kHz outside the authorized frequency band shall be attenuated by at least 20dB relative to the maximum measured in-band peak PSD level.
- d. The band edges was measured and recorded.

### 7.3 Test Setup Layout

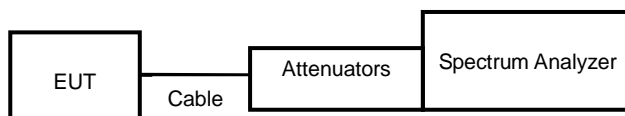

### 7.4 Test Result and Data

Note: Test plots refer to the following pages.



Modulation Type: GFSK  
CH00

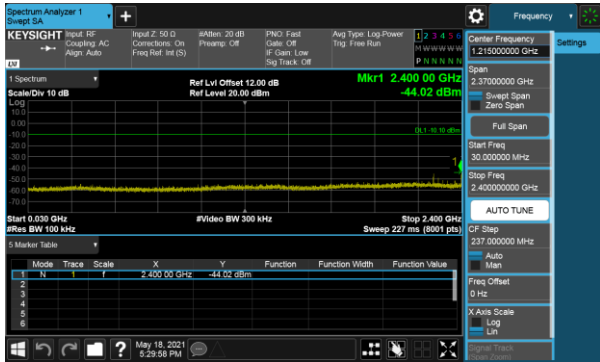

Modulation Type: GFSK  
CH19

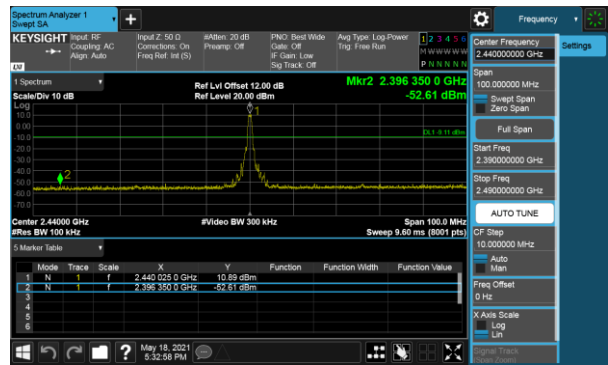
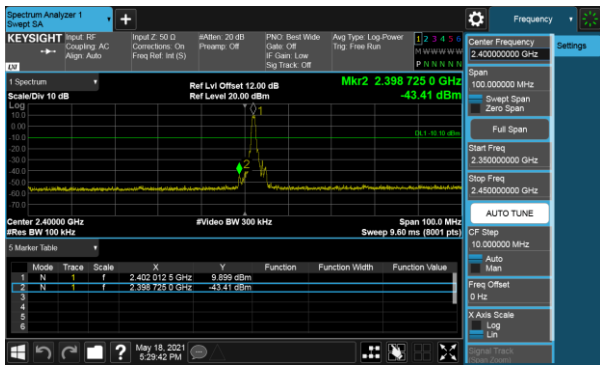
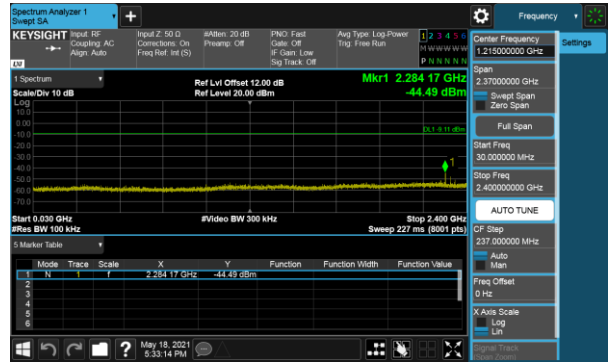



Modulation Type: GFSK  
CH39

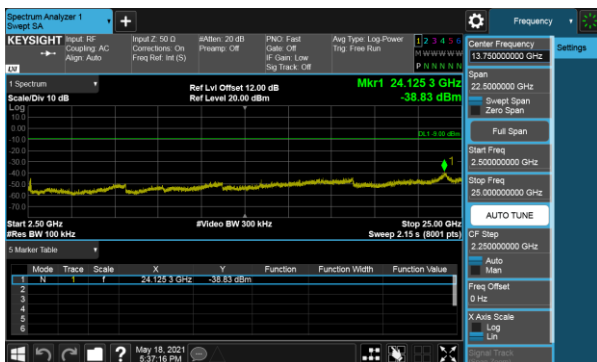
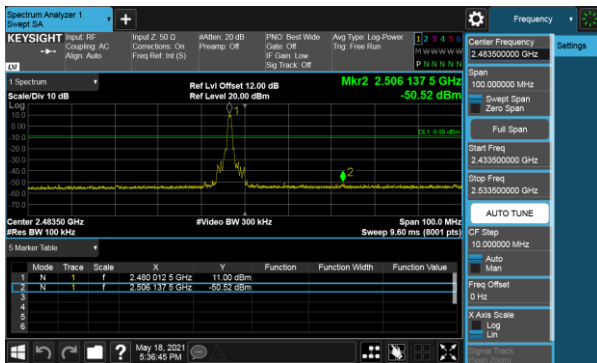
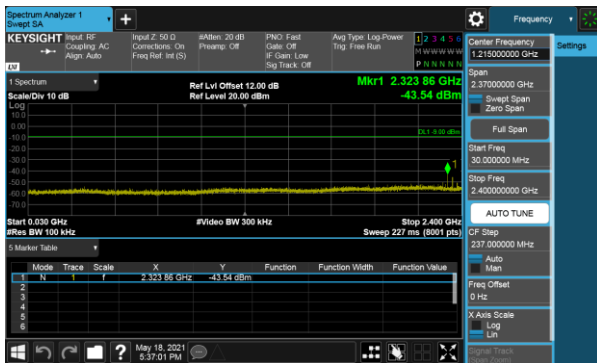





## 8. On Time, Duty Cycle and Measurement methods

### 8.1 Test Limit

None; for reporting purposes only.

### 8.2 Test Procedure

Zero-Span Spectrum Analyzer Method.

### 8.3 Test Setup Layout

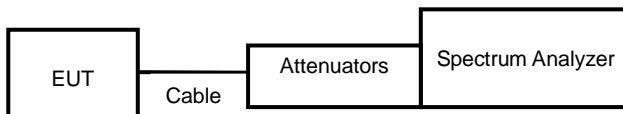

### 8.4 Test Result and Data

Modulation Type	On Time (ms)	Period Time (ms)	Duty Cycle (%)
GFSK	0.40	0.65	62.44%



Modulation Type: GFSK





### 9. 6dB Bandwidth Measurement Data

#### 9.1 Test Limit

The minimum of 6dB Bandwidth Measurement is 0.5 MHz.

#### 9.2 Test Procedures

- a. The transmitter output was connected to the spectrum analyzer.
- b. Set RBW of spectrum analyzer to 100 KHz and VBW to 300 KHz.
- c. The 6 dB bandwidth is defined as the total spectrum the power of which is higher than peak power minus 6 dB.
- d. The 6dB Bandwidth was measured and recorded.

#### 9.3 Test Setup Layout

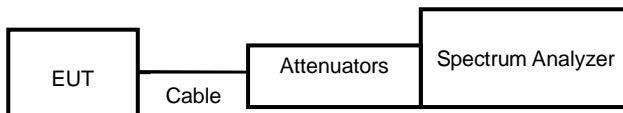

#### 9.4 Test Result and Data

Modulation Type	Channel	Frequency (MHz)	6dB Bandwidth (KHz)	Limit (KHz)
GFSK(1Mbps)	0	2402	690.00	500
	19	2440	699.00	500
	39	2480	696.00	500



### Modulation Type: GFSK CH00

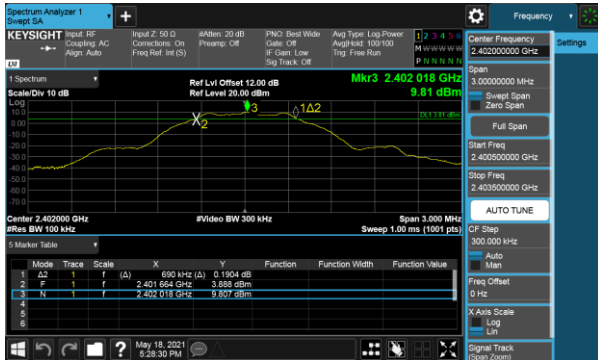

### Modulation Type: GFSK CH19

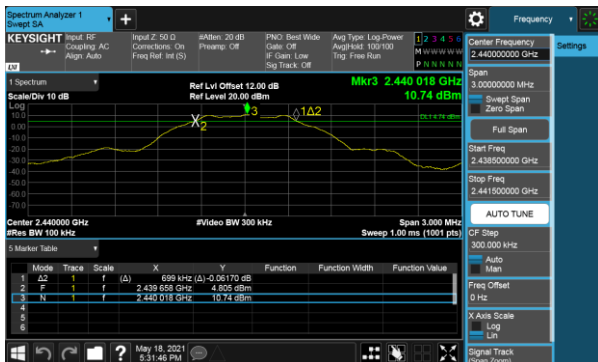

### Modulation Type: GFSK CH39

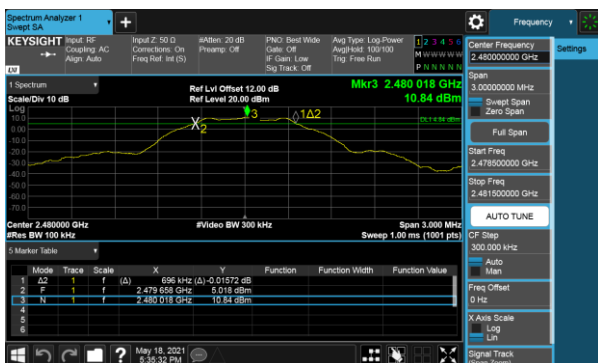



## 10. Maximum Peak and Average Output Power

### 10.1 Test Limit

The Maximum Peak Output Power Measurement is 30dBm.

### 10.2 Test Procedures

The antenna port (RF output) of the EUT was connected to the input (RF input) of a power meter. Power was read directly from the meter and cable loss connection was added to the reading to obtain power at the EUT antenna terminal. The EUT Output Power was set to maximum to produce the worse case test result.

### 10.3 Test Setup Layout

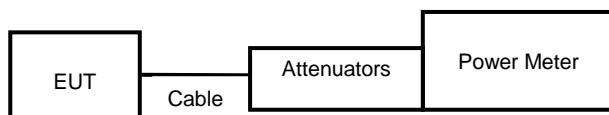

### 10.4 Test Result and Data

Power Set	Modulation Type	Channel	Frequency (MHz)	Power Output (dBm)		Power Output (mW)	
				Peak	Average	Peak	Average
Default	GFSK	0	2402	9.58	9.38	9.078	8.670
Default		19	2440	10.44	10.32	11.066	10.765
Default		39	2480	10.51	10.36	11.246	10.864

\*Average Power is for reference only



## 11. Power Spectral Density

### 11.1 Test Limit

The Maximum of Power Spectral Density Measurement is 8dBm.

### 11.2 Test Procedures

- a. The transmitter output was connected to spectrum analyzer.
- b. The spectrum analyzer's resolution bandwidth were set at 3KHz RBW and 10KHz VBW as that of the fundamental frequency. Set the sweep time=auto couple.
- c. The power spectral density was measured and recorded.

### 11.3 Test Setup Layout

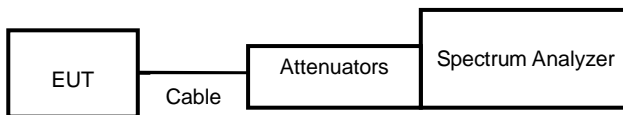

### 11.4 Test Result and Data

Modulation Type	Channel	Frequency (MHz)	Maximum Power Density of 3KHz Bandwidth(dBm)	Limit
GFSK(1Mbps)	0	2402	-5.59	8.00
	19	2440	-4.47	8.00
	39	2480	-4.49	8.00



Modulation Type: GFSK  
CH00

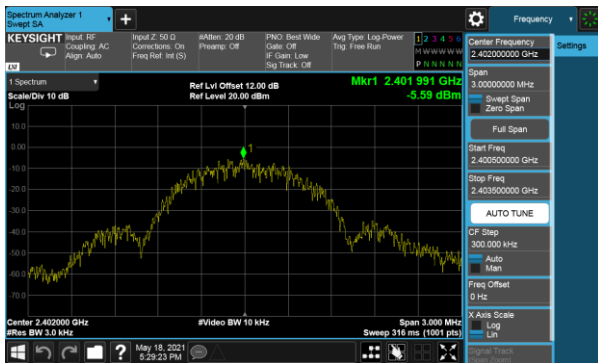

Modulation Type: GFSK  
CH19



Modulation Type: GFSK  
CH39

