



# FCC SAR TEST REPORT

Applicant : Ubiquiti Inc.  
Address : 685 Third Avenue, New York, New York 10017, USA  
Manufacturer : Ubiquiti Inc.  
Address : 685 Third Avenue, New York, New York 10017, USA  
Equipment : WiFiMan Wizard  
Model No. : WM-W  
Trade Name : UBIQUITI  
FCC ID. : SWX-WMW

**I HEREBY CERTIFY THAT:**

The sample was received on May 26, 2022 and the testing was completed on Jun. 01, 2022 at CerpPASS Technology Corp. The test result refers exclusively to the test presented test model / sample. Without written approval of CerpPASS Technology Corp., the test report shall not be reproduced except in full.

Approved by:

Vic Hsiao / Supervisor

Laboratory Accreditation:

CerpPASS Technology Corporation Test Laboratory





## Contents

|   |           |
|---|-----------|
| <b>1. Summary of Maximum SAR Value.....</b>                 | <b>4</b>  |
| <b>2. Test Configuration of Equipment under Test.....</b>   | <b>5</b>  |
| <b>3. General Information of Test .....</b>                 | <b>6</b>  |
| <b>4. Basic restrictions and Standards.....</b>             | <b>7</b>  |
| 4.1 Test Standards .....                                    | 7         |
| 4.2 Environment Condition.....                              | 7         |
| 4.3 RF Exposure Limits.....                                 | 7         |
| <b>5. DASY5 Measurement System.....</b>                     | <b>8</b>  |
| 5.1 Uncertainty of Inter-/Extrapolation and Averaging ..... | 9         |
| 5.2 DASY5 E-Field Probe .....                               | 9         |
| 5.3 Data Acquisition Electronics (DAE).....                 | 10        |
| 5.4 Robot.....  | 10        |
| 5.5 Measurement Server.....                                 | 11        |
| 5.6 Measurement Server.....                                 | 11        |
| 5.7 SAM Phantom .....                                       | 12        |
| 5.8 Device Holder.....                                      | 13        |
| 5.9 Test Equipment and Ancillaries Used for Tests .....     | 14        |
| <b>6. The SAR Measurement Procedure.....</b>                | <b>15</b> |
| 6.1 System Performance Check .....                          | 15        |
| 6.2 Test Requirements .....                                 | 19        |
| <b>7. Wi-Fi SAR Exclusion and Results .....</b>             | <b>22</b> |
| 7.1 Measured Conducted Average Power .....                  | 22        |
| 7.2 Antenna Location .....                                  | 23        |
| 7.3 SAR exclusion calculation.....                          | 24        |
| 7.4 Required Edges for SAR Testing .....                    | 25        |
| 7.5 Estimated SAR.....                                      | 25        |
| SAR Test Results Summary.....                               | 26        |
| 7.6 SAR Measurement Variability .....                       | 27        |
| <b>8. Simultaneous Transmission Analysis .....</b>          | <b>28</b> |
| 8.1 Co-location .....                                       | 28        |
| 8.2 SPLSR Evaluation.....                                   | 28        |
| <b>9. Measurement Uncertainty .....</b>                     | <b>29</b> |
| <b>Appendix A. DASY Calibration Certificate</b>             |           |
| <b>Appendix B. System Performance Check</b>                 |           |
| <b>Appendix C. Measured Conducted Power</b>                 |           |
| <b>Appendix D. SAR Measurement Data</b>                     |           |
| <b>Appendix E. Photographs of EUT Set up</b>                |           |



### History of this test report

| Attachment No.   | Issued Date   | Description |
|------------------|---------------|-------------|
| 22050245-TRFCC02 | Jun. 24, 2022 | Original    |
|                  |               |             |
|                  |               |             |
|                  |               |             |
|                  |               |             |
|                  |               |             |
|                  |               |             |
|                  |               |             |
|                  |               |             |
|                  |               |             |
|                  |               |             |
|                  |               |             |
|                  |               |             |
|                  |               |             |
|                  |               |             |



## 1. Summary of Maximum SAR Value

Results for highest reported SAR values for each frequency band and mode are as below:

| Band  | Mode | Highest Body standalone SAR 1g (W/kg) |
|-------|------|---------------------------------------|
| BT-LE | GFSK | 0.31                                  |

Note \*The lab has reduced the uncertainty risk factor from test equipment, environment and staff technicians which according to the standard on contract. Therefore, the test result will only be determined by standard requirement.



## 2. Test Configuration of Equipment under Test

|                           |  |
|---------------------------|--|
| Operation Frequency Range | BLE: 2400-2483.5MHz<br>802.11b/g/n/ax: 2400-2483.5MHz<br>802.11a/n/ac/ax: 5150-5250MHz, 5250-5350MHz, 5470-5725MHz, 5725-5850MHz   |
| Center Frequency Range    | BLE: 2402MHz-2480MHz<br>802.11b/g/n/ax: 2412MHz-2462MHz<br>802.11a/n/ac/ax: 5180-5240MHz, 5260-5320MHz, 5500-5720MHz, 5745-5825MHz   |
| Modulation Type           | BLE: GFSK<br>802.11b: CCK, DQPSK, DBPSK<br>802.11g/n/a: BPSK, QPSK, 16QAM, 64QAM<br>802.11ac: BPSK, QPSK, 16QAM, 64QAM, 256QAM<br>802.11ax: BPSK, QPSK, 16QAM, 64QAM, 256QAM, 1024QAM  |
| Modulation Technology     | DSSS, OFDM, DTS, OFDMA   |
| Data Rate                 | BLE:<br>GFSK: 1Mbps<br>WLAN:<br>802.11b: 1, 2, 5.5, 11Mbps<br>802.11g: 6, 9, 12, 18, 24, 36, 48, 54Mbps<br>802.11n: MCS0 – MCS7, HT20<br>802.11a: 6, 9, 12, 18, 24, 36, 48, 54Mbps<br>802.11ac: MCS0 – MCS9, VHT20<br>802.11ax: MCS0 – MCS11, HE20 |
| Antenna Type              | PCB Antenna  |
| Antenna Gain              | 2400-2483.5MHz: 3dBi<br>5150-5250MHz: 2.5dBi<br>5250-5350MHz: 2.5dBi<br>5470-5725MHz: 2.5dBi<br>5725-5850MHz: 2.5dBi   |
| Firmware Number           | V 0.6.0  |
| Serial Number             | 2210A 245AC2FB1F9-PrCStf   |

Note:

1. WLAN 2.4GHz and 5GHz only support receiver function.
2. For more details, please refer to the User's manual of the EUT.



### 3. General Information of Test

|           |  |
|-----------|--|
| Test Site | <b>CerpPASS Technology Corporation Test Laboratory</b><br>Address: No.10, Ln. 2, Lianfu St., Luzhu Dist., Taoyuan City 33848,<br>Taiwan (R.O.C.)<br>Tel:+886-3-3226-888<br>Fax:+886-3-3226-881 |
|-----------|--|

| Test Item | Test Site  | Test Period | Environmental Conditions | Tested By    |
|-----------|------------|-------------|--------------------------|--------------|
| SAR       | RFSAR01-NK | 2022/06/01  | 23.5 °C / 47%            | Angelo Chang |



## 4. Basic restrictions and Standards

### 4.1 Test Standards

FCC 47 CFR Part 2 (2.1093)

### 4.2 Reference Standards

FCC KDB Publication 447498 D01 General RF Exposure Guidance v06  
FCC KDB Publication 865664 D01 SAR Measurement 100 MHz to 6 GHz v01r04  
FCC KDB Publication 248227 D01 802.11 Wi-Fi SAR v02r02  
FCC KDB Publication 941225D06 Hot Spot SAR v02r01  
IEEE 62209-1528

### 4.3 Environment Condition

| Item                        | Target |
|-----------------------------|--------|
| Ambient Temperature(°C)     | 18~25  |
| Temperature of Simulant(°C) | 20~22  |
| Relative Humidity(%RH)      | 30~70  |

### 4.4 RF Exposure Limits

| Human Exposure                                | Basic restrictions for electric, magnetic and electromagnetic fields. (Unit in mW/g or W/kg) |
|---|--|
| Spatial Peak SAR <sup>1</sup> (Head and Body) | 1.6  |
| Spatial Average SAR <sup>2</sup> (Whole Body) | 0.08   |
| Spatial Peak SAR <sup>3</sup> (Arms and Legs) | 4  |

Notes:

1. The Spatial Peak value of the SAR averaged over any 1gram of tissue (defined as a tissue volume in the shape of a cube) and over the appropriate averaging time.
2. The Spatial Average value of the SAR averaged over the whole body.
3. The Spatial Peak value of the SAR averaged over any 1 gram of tissue (defined as a tissue volume in the shape of a cube) and over appropriate averaging time.

## 5. DASY5 Measurement System

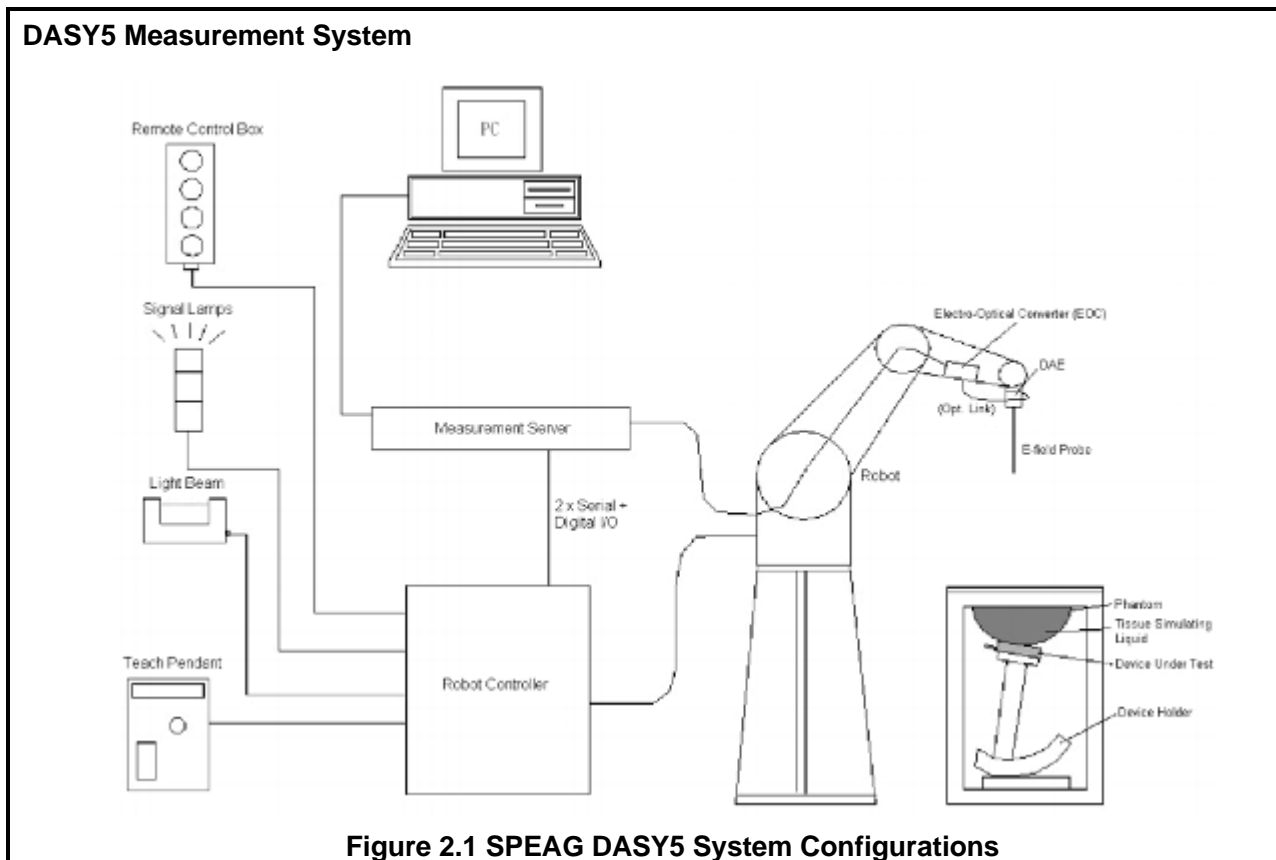

The DASY5 system for performance compliance tests is illustrated above graphically. This system consists of the following items:

- A standard high precision 6-axis robot with controller, a teach pendant and software
- A data acquisition electronic(DAE)attached to the robot arm extension
- A dosimetric probe equipped with an optical surface detector system
- The electro-optical converter(ECO)performs the conversion between optical and electrical signals
- A measurement server performs the time critical tasks such as signal filtering, control of the robot operation and fast movement interrupts.
- A probe alignment unit which improves the accuracy of the probe positioning
- A computer operating Windows 7
- DASY5 software
- Remove control with teach pendant additional circuitry for robot safety such as warming lamps, etc.
- The SAM twin phantom
- A device holder
- Tissue simulating liquid
- Dipole for evaluating the proper functioning of the system





### 5.1 Uncertainty of Inter-/Extrapolation and Averaging

In order to evaluate the uncertainty of the interpolation, extrapolation and averaged SAR calculation algorithms of the Postprocessor, DASY5 allows the generation of measurement grids which are artificially predefined by analytically based test functions. Therefore, the grids of area scans and zoom scans can be filled with uncertainty test data, according to the SAR benchmark functions of IEEE 1528. The three analytical functions shown in equations as below are used to describe the possible range of the expected SAR distributions for the tested handsets. The field gradients are covered by the spatially flat distribution f1, the spatially steep distribution f3 and f2 accounts for H-field cancellation on the phantom/tissue surface.

$$f_1(x, y, z) = Ae^{-\frac{z}{2a}} \cos^2\left(\frac{\pi}{2} \frac{\sqrt{x'^2 + y'^2}}{5a}\right)$$

$$f_2(x, y, z) = Ae^{-\frac{z}{a}} \frac{a^2}{a^2 + x'^2} \left(3 - e^{-\frac{2z}{a}}\right) \cos^2\left(\frac{\pi}{2} \frac{y'}{3a}\right)$$

$$f_3(x, y, z) = A \frac{a^2}{\frac{a^2}{4} + x'^2 + y'^2} \left(e^{-\frac{2z}{a}} + \frac{a^2}{2(a + 2z)^2}\right)$$

### 5.2 DASY5 E-Field Probe

The SAR measurement is conducted with the dosimetric probe manufactured by SPEAG. The probe is specially designed and calibrated for use in liquid with high permittivity. The dosimetric probe has special calibration in liquid at different frequency.

SPEAG conducts the probe calibration in compliance with international and national standards (e.g. IEEE 1528, EN 62209-1, IEC 62209, etc.) under ISO 17025. The calibration data are in Appendix D.

|                      |  |   |
|----------------------|--|---|
| <b>Model</b>         | EX3DV4   |   |
| <b>Construction</b>  | Symmetrical design with triangular core Built-in shielding against static charges PEEK enclosure material (resistant to organic solvents, e.g., DGBE)  |   |
| <b>Frequency</b>     | 10 MHz to 6 GHz<br>Linearity: ± 0.2 dB (30 MHz to 6 GHz)   |  |
| <b>Directivity</b>   | ± 0.3 dB in HSL (rotation around probe axis)<br>± 0.5 dB in tissue material (rotation normal to probe axis)  |   |
| <b>Dynamic Range</b> | 10 µW/g to 100 mW/g<br>Linearity: ± 0.2 dB (noise: typically < 1 µW/g)   |   |
| <b>Dimensions</b>    | Overall length: 330 mm (Tip: 20 mm)<br>Tip diameter: 2.5 mm (Body: 12 mm)<br>Typical distance from probe tip to dipole centers: 1 mm   |   |
| <b>Application</b>   | High precision dosimetric measurements in any exposure scenario (e.g., very strong gradient fields). Only probe which enables compliance testing for frequencies up to 6 GHz with precision of better 30%. |   |



### 5.3 Data Acquisition Electronics (DAE)

The data acquisition electronics (DAE) consists of a highly sensitive electrometer-grade preamplifier with auto-zeroing, a channel and gain-switching multiplexer, a fast 16 bit AD-converter and a command decoder and control logic unit. Transmission to the measurement server is accomplished through an optical downlink for data and status information as well as an optical uplink for commands and the clock. The input impedance of the DAE4 is 200M Ohm; the inputs are symmetrical and floating. Common mode rejection is above 80dB.

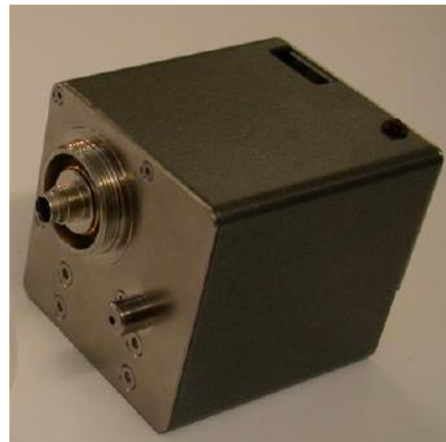

### 5.4 Robot

The DASY5 system uses the high precision robots TX90 XL type out of the newer series from Stäubli SA (France). For the 6-axis controller DASY5 system, the CS8C robot controller version from Stäubli is used. The XL robot series have many features that are important for our application:

- High precision (repeatability 0.02 mm)
- High reliability (industrial design)
- Jerk-free straight movements
- Low ELF interference (the closed metallic construction shields against motor control fields)
- 6-axis controller





### 5.5 Measurement Server

The light beam switch allows automatic "tooling" of the probe. During the process, the actual position of the probe tip with respect to the robot arm is measured, as well as the probe length and the horizontal probe offset. The software then corrects all movements, such that the robot coordinates are valid for the probe tip.

The repeatability of this process is better than 0.1 mm. If a position has been taught with an aligned probe, the same position will be reached with another aligned probe within 0.1 mm, even if the other probe has different dimensions. During probe rotations, the probe tip will keep its actual position.





### 5.6 Measurement Server

The DASY5 measurement server is based on a PC/104 CPU board with a 400MHz intel ULV Celeron, 112MB chipdisk and 112MB RAM. The necessary circuits for communication with the DAE electronics box, as well as the 16 bit AD converter system for optical detection and digital I/O interface are contained on the DASY5 I/O board, which is directly connected to the PC/104 bus of the CPU board.





### 5.7 SAM Phantom

|   |  |
|---|--|
| <p>The SAM twin phantom is a fiberglass shell phantom with 2mm shell thickness (except the ear region where shell thickness increases to 6mm). It has three measurement areas:</p> <ul style="list-style-type: none"><li>■ Left head</li><li>■ Right head</li><li>■ Flat phantom</li></ul>  |  A photograph of the SAM twin phantom setup. It consists of a white fiberglass shell phantom mounted on a wooden frame. A black robotic arm is positioned above the phantom, and a black base is visible on the floor.                                     |
| <p>The ELI4 Phantom also is a fiberglass shell phantom with 2mm shell thickness. It has 30 liters filling volume, and with a dimension of 600mm for major ellipse axis, 400mm for minor axis. It is intended for compliance testing of handheld and body-mounted wireless devices in frequency range of 30 MHz to 6GHz. ELI4 is fully compatible with standard and all known tissue simulating liquids.</p>                                       |  A photograph of the ELI4 Phantom setup. It features a white fiberglass shell phantom with a large red circular opening on top, mounted on a wooden frame. A black robotic arm is positioned above the phantom, and a black base is visible on the floor. |
| <p>The bottom plate contains three pair of bolts for locking the device holder. The device holder positions are adjusted to the standard measurement positions in the three sections. A white cover is provided to tap the phantom during off-periods to prevent water evaporation and changes in the liquid parameters. On the phantom top, three reference markers are provided to identify the phantom position with respect to the robot.</p> |  |

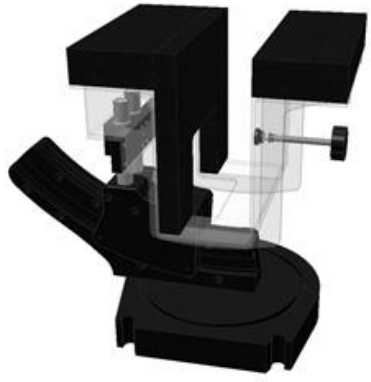

### 5.8 Device Holder

|  |  |
|--|--|
| <p>The DASY5 device holder is designed to cope with different positions given in the standard. It has two scales for the device rotation (with respect to the body axis) and the device inclination (with respect to the line between the ear reference points). The rotation center for both scales is the ear reference point (EPR). Thus the device needs no repositioning when changing the angles. The DASY5 device holder has been made out of low-loss POM material having the following dielectric parameters: relative permittivity <math>\epsilon_r = 3</math> and loss tangent <math>\delta = 0.02</math>. The amount of dielectric material has been reduced in the closest vicinity of the device, since measurements have suggested that the influence of the clamp on the test results could thus be lowered.</p> |    |
| <p>The laptop extension is lightweight and made of POM, acrylic glass and foam. It fits easily on upper part of the mounting device in place of the phone positioned. The extension is fully compatible with the SAM Twin and ELI phantoms.</p>  |  |



### 5.9 Test Equipment and Ancillaries Used for Tests

| Name of Equipment                | Manufacturer  | Type/Model                  | Serial Number     | Calibration Cycle(year) | Calibration Period |
|----------------------------------|---------------|-----------------------------|-------------------|-------------------------|--------------------|
| Robot                            | Staubli       | TX60L Lspeag                | F13/5P6VA1/A/01   | /                       | NCR                |
| DASY5 Test Software              | Staubli       | DASY5.2                     | 14.6.14.7483      | /                       | NCR                |
| Signal Grenerator                | Agilent       | MXG Vector Signal Generator | N5182A            | 1                       | 2022/6/16          |
| S-Parameter Network Analyzer     | Agilent       | E5071C                      | 70045-459-220-350 | 1                       | 2022/8/3           |
| Dielectric parameter probes      | SPEAG         | DAKS-3.5                    | 1121              | N/A                     | NCR                |
| Power Meter                      | Anritsu       | ML2495A                     | 1224005           | 1                       | 2023/4/11          |
| Power Sensor                     | Anritsu       | MA2411B                     | 1207295           | 1                       | 2023/4/11          |
| Power Meter                      | Anritsu       | ML2495A                     | 2034001           | 1                       | 2022/9/22          |
| Power Sensor                     | Anritsu       | MA2411B                     | 1911175           | 1                       | 2022/9/22          |
| Data Acquisition Electronics     | SPEAG         | DAE4                        | 1379              | 1                       | 2022/7/14          |
| Dosimetric E-Field Probe         | SPEAG         | EX3DV4                      | 3927              | 1                       | 2022/7/26          |
| Dosimetric E-Field Probe         | SPEAG         | EX3DV4                      | 3753              | 1                       | 2022/7/25          |
| 2450MHz System Validation Dipole | SPEAG         | D2450V2                     | 914               | 3                       | 2024/8/26          |
| 5GHz System Validation Dipole    | SPEAG         | D5GHzV2                     | 1156              | 3                       | 2024/8/11          |
| Amplifier                        | Mini-Circuits | ZVE-8G+                     | 70501814          | /                       | NCR                |
| Thermometer                      | Hi Sun        | TH05A                       | 11442             | 1                       | 2022/7/6           |

\*Please Refer to the Appendix A. DASY Calibration Certificate.

Note:

1. Prior to system verification and validation, the path loss from the signal generator to the system check source and the power meter, which includes the amplifier, cable, attenuator and directional coupler, was measured by the network analyzer. The reading of the power meter was offset by the path loss difference between the path to the power meter and the path to the system check source to monitor the actual power level fed to the system check source.
2. Referring to KDB 865664 D01v01r04, the dipole calibration interval can be extended to 3 years with justification. The dipoles are also not physically damaged, or repaired during the interval.
3. The justification data of dipole can be found in Appendix B. The return loss is < -20dB, within 20% of prior calibration, the impedance is within 5 ohm of prior calibration



## 6. The SAR Measurement Procedure

### 6.1 System Performance Check

#### 6.1.1 Purpose

1. To verify the simulating liquids are valid for testing.
2. To verify the performance of testing system is valid for testing.

#### 6.1.2 Tissue Dielectric Parameters for Head and Body Phantoms

| Target Frequency<br>(MHz) | Head         |                | Body         |                |
|---------------------------|--------------|----------------|--------------|----------------|
|                           | $\epsilon_r$ | $\sigma$ (S/m) | $\epsilon_r$ | $\sigma$ (S/m) |
| 150                       | 52.3         | 0.76           | 61.9         | 0.8            |
| 300                       | 45.3         | 0.87           | 58.2         | 0.92           |
| 450                       | 43.5         | 0.87           | 56.7         | 0.94           |
| 835                       | 41.5         | 0.9            | 55.2         | 0.97           |
| 850                       | 41.5         | 0.92           | 55.2         | 0.99           |
| 900                       | 41.5         | 0.97           | 55           | 1.05           |
| 915                       | 41.5         | 0.98           | 55           | 1.06           |
| 1450                      | 40.5         | 1.2            | 54           | 1.3            |
| 1610                      | 40.3         | 1.29           | 53.8         | 1.4            |
| 1800 – 2000               | 40           | 1.4            | 53.3         | 1.52           |
| 2450                      | 39.2         | 1.8            | 52.7         | 1.95           |
| 3000                      | 38.5         | 2.4            | 52           | 2.73           |
| 5200                      | 36           | 4.66           | 49           | 5.3            |
| 5250                      | 35.95        | 4.71           | 48.9         | 5.4            |
| 5300                      | 35.87        | 4.76           | 48.9         | 5.4            |
| 5600                      | 35.5         | 5.07           | 48.5         | 5.8            |
| 5750                      | 35.35        | 5.22           | 48.3         | 5.9            |
| 5800                      | 35.3         | 5.27           | 48.2         | 6              |

( $\epsilon_r$  = relative permittivity,  $\sigma$  = conductivity and  $\rho = 1000 \text{ kg/m}^3$ )

According to April 2019 TCB workshop, Effective February 19,2019,FCC has permitted the use of single head-tissue simulating liquid specified in IEC 62209-1 for all SAR tests.



### 6.1.3 Tissue Calibration Result

- The dielectric parameters of the liquids were verified prior to the SAR evaluation using DASY5 Dielectric Assessment Kit and Agilent Vector Network Analyzer E5071C.

**Please Refer to the Appendix B System Performance Check.**

Note:

1. The Delta Permittivity% and Delta Conductivity% should be both within  $\pm 5\%$  limit of target values.
2. Refer to KDB 865664 D01 v01r04, The depth of body tissue-equivalent liquid in a phantom must be  $\geq 15.0$  cm with  $\leq \pm 0.5$  cm variation for SAR measurements  $\leq 3$  GHz and  $\geq 10.0$  cm with  $\leq \pm 0.5$  cm variation for measurements  $> 3$  GHz.





#### 6.1.4 System Performance Check Procedure

The DASY5 installation includes predefined files with recommended procedures for measurements and the system performance check. They are read-only document files and destined as fully defined but unmeasured masks, so the finished system performance check must be saved under a different name. The system performance check document requires the SAM Twin Phantom or ELI4 Phantom, so the phantom must be properly installed in your system. (User defined measurement procedures can be created by opening a new document or editing an existing document file). Before you start the system performance check, you need only to tell the system with which components (probe, medium, and device) you are performing the system performance check; the system will take care of all parameters.

■ **The Power Reference Measurement and Power Drift Measurement** jobs are located at the beginning and end of the batch process. They measure the field drift at one single point in the liquid over the complete procedure. The indicated drift is mainly the variation of the Dipole output power. If it is too high (above  $\pm 0.2$  dB), the system performance check should be repeated;

■ **The Surface Check** job tests the optical surface detection system of the DASY5 system by repeatedly detecting the surface with the optical and mechanical surface detector and comparing the results. The output gives the detecting heights of both systems, the difference between the two systems and the standard deviation of the detection repeatability. Air bubbles or refraction in the liquid due to separation of the sugar-water mixture gives poor repeatability (above  $\pm 0.1$  mm). In that case it is better to abort the system performance check and stir the liquid;

■ **The Area Scan** job measures the SAR above the dipole on a plane parallel to the surface. It is used to locate the approximate location of the peak SAR. The proposed scan uses large grid spacing for faster measurement; due to the symmetric field, the peak detection is reliable;

■ **The Zoom Scan** job measures the field in a volume around the peak SAR value assessed in the previous Area Scan job (for more information see the application note on SAR evaluation). If the system performance check gives reasonable results. The dipole input power (forward power) was 250 mW, 1 g and 10 g spatial average SAR values normalized to 1 W dipole input power give reference data for comparisons and it's equal to  $10 \times$  (dipole forward power). The next sections analyze the expected uncertainties of these values, as well as additional checks for further information or troubleshooting.



### 6.1.5 System Performance Check Setup

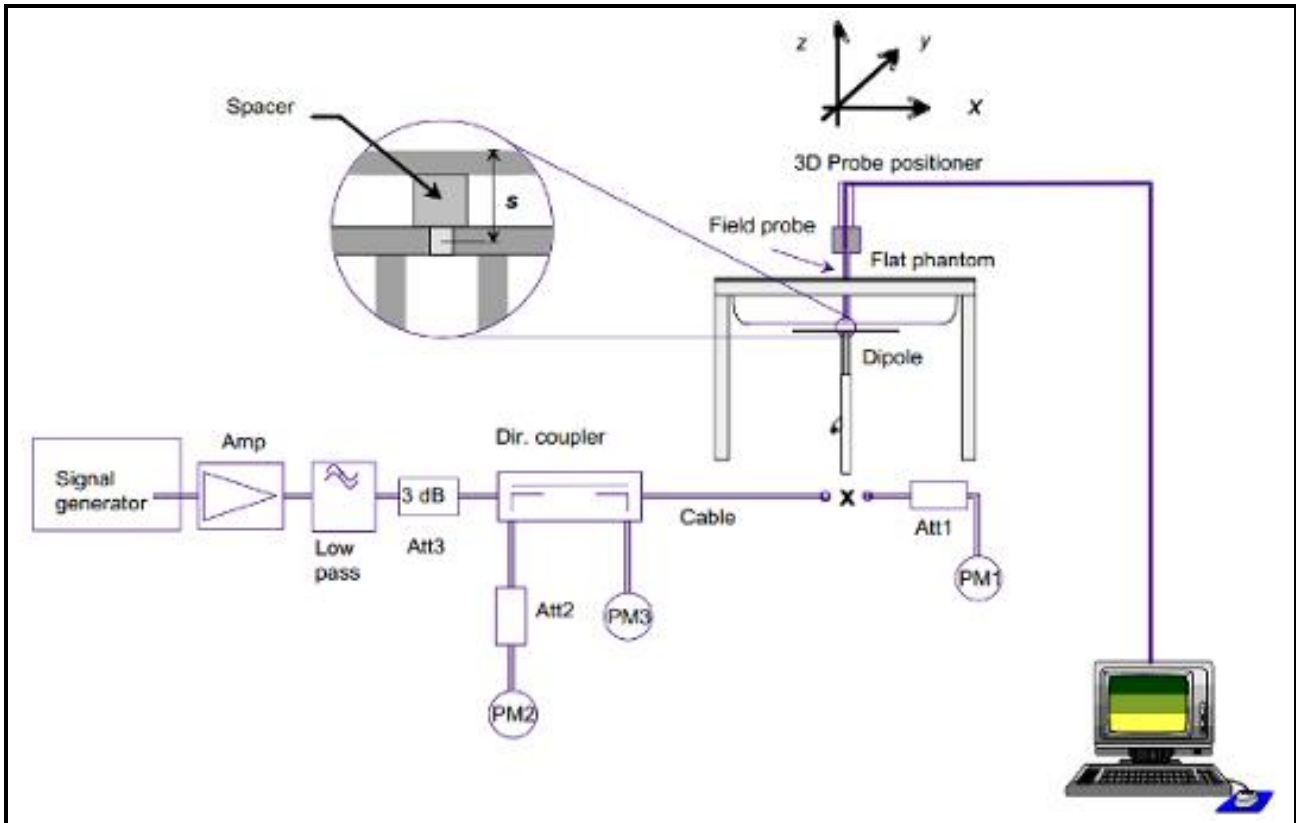

### 6.1.6 Validation Dipoles

The dipoles use is based on the IEEE Std.1528-2013 and FCC KDB 865664 D01 SAR Measurement 100 MHz to 6 GHz v01r04 standard, and is complied with mechanical and electrical specifications in line with the requirements of both EN62209-1 and EN62209-2. The table below provides details for the mechanical and electrical specifications for the dipoles.

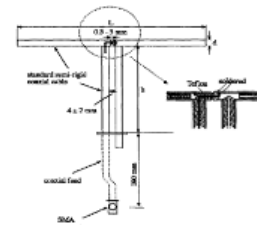

### 6.1.7 Result of System Performance Check: Valid Result

Please Refer to the Appendix B System Performance Check.



## 6.2 Test Requirements

### 6.2.1 Test Procedures

#### Step 1 Setup a Connection

First, engineer should record the conducted power before the test. Then establish a call in handset at the maximum power level with a base station simulator via air interface, or make the EUT estimate by itself in testing band. Place the EUT to the specific test location. After the testing, must export SAR test data by SEMCAD. Then writing down the conducted power of the EUT into the report, also the SAR values tested.

#### Step 2 Power Reference Measurements

To measure the local E-field value at a fixed location which value will be taken as a reference value for calculating a possible power drift.

#### Step 3 Area Scan

The Area Scan is used as a fast scan in two dimensions to find the area of high field values, before doing a fine measurement around the hot spot. The sophisticated interpolation routines implemented in DASY software can find the maximum locations even in relatively coarse grids. When an Area Scan has measured all reachable points, it computes the field maximal found in the scanned area, within a range of the global maximum. The range (in dB) is specified in the standards for compliance testing. For example, a 2 dB range is required in IEEE Standard 1528 and IEC 62209 standards, whereby 3 dB is a requirement when compliance is assessed in accordance with the ARIB standard (Japan). If only one Zoom Scan follows the Area Scan, then only the absolute maximum will be taken as reference. For cases where multiple maximums are detected, the number of Zoom Scans has to be increased accordingly.

Area Scan Parameters extracted from KDB 865664 D01v01r04

|  | ≤ 3 GHz   | > 3 GHz  |
|--|---|--|
| Maximum distance from closest measurement point (geometric center of probe sensors) to phantom surface | 5 ± 1 mm  | $\frac{1}{2} \cdot \delta \cdot \ln(2) \pm 0.5$ mm |
| Maximum probe angle from probe axis to phantom surface normal at the measurement location              | 30° ± 1°  | 20° ± 1°   |
| Maximum area scan spatial resolution: $\Delta x_{Area}, \Delta y_{Area}$                               | ≤ 2 GHz: ≤ 15 mm<br>2 – 3 GHz: ≤ 12 mm  | 3 – 4 GHz: ≤ 12 mm<br>4 – 6 GHz: ≤ 10 mm           |
|  | When the x or y dimension of the test device, in the measurement plane orientation, is smaller than the above, the measurement resolution must be ≤ the corresponding x or y dimension of the test device with at least one measurement point on the test device. |  |



### Step 4 Zoom Scan

Zoom Scans are used to assess the peak spatial SAR values within a cubic averaging volume containing 1 g and 10 g of simulated tissue. The Zoom Scan measures points (refer to table below) within a cube whose base faces are centered on the maxima found in a preceding area scan job within the same procedure. When the measurement is done, the Zoom Scan evaluates the averaged SAR for 1 g and 10 g and displays these values next to the job’s label.

**Zoom Scan Parameters extracted from KDB 865664 D01 v01r04**

|  |                                    | ≤ 3 GHz  | > 3 GHz   |
|--|------------------------------------|--|---|
| Maximum zoom scan spatial resolution: $\Delta x_{Zoom}$ , $\Delta y_{Zoom}$  |                                    | $\leq 2$ GHz: $\leq 8$ mm<br>$2 - 3$ GHz: $\leq 5$ mm*                               | $3 - 4$ GHz: $\leq 5$ mm*<br>$4 - 6$ GHz: $\leq 4$ mm*                              |
| Maximum zoom scan spatial resolution, normal to phantom surface  | uniform grid: $\Delta z_{Zoom}(n)$ | $\leq 5$ mm  | $3 - 4$ GHz: $\leq 4$ mm<br>$4 - 5$ GHz: $\leq 3$ mm<br>$5 - 6$ GHz: $\leq 2$ mm    |
|  | graded grid                        | $\Delta z_{Zoom}(1)$ : between 1 <sup>st</sup> two points closest to phantom surface | $\leq 4$ mm   |
|  |                                    | $\Delta z_{Zoom}(n>1)$ : between subsequent points                                   | $\leq 1.5 \cdot \Delta z_{Zoom}(n-1)$   |
| Minimum zoom scan volume   | x, y, z                            | $\geq 30$ mm   | $3 - 4$ GHz: $\geq 28$ mm<br>$4 - 5$ GHz: $\geq 25$ mm<br>$5 - 6$ GHz: $\geq 22$ mm |
| Note: $\delta$ is the penetration depth of a plane-wave at normal incidence to the tissue medium; see draft standard IEEE P1528-2011 for details.<br>* When zoom scan is required and the <i>reported</i> SAR from the <i>area scan based 1-g SAR estimation</i> procedures of KDB 447498 is $\leq 1.4$ W/kg, $\leq 8$ mm, $\leq 7$ mm and $\leq 5$ mm zoom scan resolution may be applied, respectively, for 2 GHz to 3 GHz, 3 GHz to 4 GHz and 4 GHz to 6 GHz. |                                    |  |   |

### Step 5 Power Drift Measurements

Repetition of the E-field measurement at the fixed location mentioned in Step 1 to make sure the two results differ by less than  $\pm 0.2$  dB.



### 6.2.2 Measurement Evaluation

Per KDB248227 D01 v02r02, channel selection procedures below apply to both the initial test configuration and subsequent test configuration(s):

- 1) 802.11a is chosen over 802.11n then 802.11ac or 802.11g is chosen over 802.11n.
- 2) The largest channel bandwidth configuration is selected among the multiple configurations in a frequency band with the same specified maximum output power.
- 3) If multiple configurations have the same specified maximum output power and largest channel bandwidth, the lowest order modulation among the largest channel bandwidth configurations is selected.
- 4) If multiple configurations have the same specified maximum output power, largest channel bandwidth and lowest order modulation, the lowest data rate configuration among these configurations is selected.
- 5) The same procedures also apply to subsequent highest output power channel(s) selection.
  - a> The channel closest to mid-band frequency is selected for SAR measurement.
  - b> For channels with equal separation from mid-band frequency; for example, high and low channels or two mid-band channels, the higher frequency (number) channel is selected for SAR measurement.



## **7. Wi-Fi SAR Exclusion and Results**

### **7.1 Measured Conducted Average Power**

**Please Refer to the Appendix C Measured Conducted Power.**



### 7.2 Antenna Location

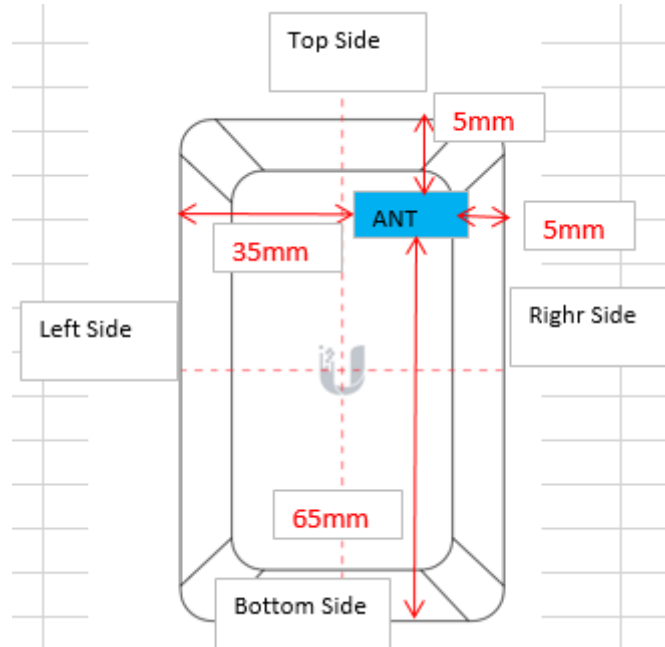

|          |                    |
|----------|--------------------|
| Antennas | Wireless Interface |
| Main Ant | BT-LE              |

| Separation Distances(mm) |      |           |            |          |             |
|--------------------------|------|-----------|------------|----------|-------------|
| Front                    | Back | Left Side | Right Side | Top Side | Bottom Side |
| 5.00                     | 5.00 | 35.00     | 5.00       | 5.00     | 65.00       |



### 7.3 SAR exclusion calculation

Per FCC KDB 447498 D01 v06 for 100MHz~6GHz:

1) **The SAR exclusion threshold for distances<50mm** is defined by the following equation :

$$\frac{\text{Max Power of Channel(mW)}}{\text{Test Separation Distance(mm)}} \times \sqrt{\text{Frequency(GHz)}} \leq 3.0, \text{ for 1-g SAR}$$

| Band  | Frequency (MHz) | Maximum power |    | Calculated Threshold Value |      |           |            |          |             |
|-------|-----------------|---------------|----|----------------------------|------|-----------|------------|----------|-------------|
|       |                 | dBm           | mW | Front                      | Back | Left Side | Right Side | Top Side | Bottom Side |
| BT-LE | 2480            | 10.0          | 10 | 3.15                       | 3.15 | 0.45      | 3.15       | 3.15     | 0.24        |

2) **At test separation distances > 50 mm**, the SAR test exclusion threshold is determined according to the following:

- a. [Power allowed at numeric threshold for 50 mm in step 1) + (test separation distance - 50mm)·(f(MHz)/150)] mW, at 100 MHz to 1500 MHz
- b. [Power allowed at numeric threshold for 50 mm in step 1) + (test separation distance - 50 mm)·10] mW at > 1500 MHz and ≤ 6 GHz

| Band  | Frequency (MHz) | Maximum power |    | Testing required? |      |           |            |          |             |
|-------|-----------------|---------------|----|-------------------|------|-----------|------------|----------|-------------|
|       |                 | dBm           | mW | Front             | Back | Left Side | Right Side | Top Side | Bottom Side |
| BT-LE | 2480            | 10.0          | 10 | yes               | yes  | no        | yes        | yes      | >50mm       |





### 7.4 Required Edges for SAR Testing

| Band      | Test Position | Frequency | Pavg | Pavg | Exclusion Distance |         | Thresholds |       | Test Require |
|-----------|---------------|-----------|------|------|--------------------|---------|------------|-------|--------------|
|           |               |           |      |      |                    |         | (MHz)      | (dBm) |              |
| Bluetooth | Front         | 2480      | 10   | 10   | 5                  | (1g)/mW | -354       | -211  | Yes          |
|           | Back          | 2480      | 10   | 10   | 5                  | (1g)/mW | -354       | -211  | Yes          |
|           | Left Side     | 2480      | 10   | 10   | 35                 | (1g)/mW | -54        | 88    | No           |
|           | Right Side    | 2480      | 10   | 10   | 5                  | (1g)/mW | -354       | -211  | Yes          |
|           | Top Side      | 2480      | 10   | 10   | 5                  | (1g)/mW | -354       | -211  | Yes          |
|           | Bottom Side   | 2480      | 10   | 10   | 65                 | (1g)/mW | 245        | 388   | No           |

### 7.5 Estimated SAR

This device contains transmitters that may operate simultaneously. Therefore simultaneous transmission analysis is required. Per FCC KDB 447498 D01v06, simultaneous transmission SAR test exclusion may be applied when the sum of the 1-g SAR for all the simultaneous transmitting antennas in a specific a physical test configuration is ≤1.6W/kg. When standalone SAR is not required to be measured, per FCC KDB 447498 D01v06 4.3.2 2, the following equation must be used to estimate the standalone 1g SAR for simultaneous transmission assessment involving that transmitter.

$$Estimated\ SAR = \frac{\sqrt{f(GHz)}}{7.5} * \frac{(Max\ Power\ of\ channel,\ mW)}{Min.\ Separation,\ mm}$$

Where: Test separation distances ≤ 50mm.



## SAR Test Results Summary

**Please Refer to the Appendix D SAR measurement data.**

### **General Note:**

1. Per KDB 447498 D01v06, the reported SAR is the measured SAR value adjusted for maximum tune-up tolerance.
  - a. Tune-up scaling Factor = tune-up limit power (mW) / EUT RF power (mW), where tune-up limit is the maximum rated power among all production units.
  - b. For SAR testing of WLAN signal with non-100% duty cycle, the measured SAR is scaled-up by the duty cycle scaling factor which is equal to "1/(duty cycle)"
  - c. For WWAN: Reported SAR(W/kg)= Measured SAR(W/kg)\*Tune-up Scaling Factor
  - d. For WLAN/Bluetooth: Reported SAR(W/kg)= Measured SAR(W/kg)\* Duty Cycle scaling factor \* Tune-up scaling factor
2. Per KDB 447498 D01v06, for each exposure position, testing of other required channels within the operating mode of a frequency band is not required when the reported 1-g or 10-g SAR for the mid-band or highest output power channel is:
  - $\leq 0.8$  W/kg or 2.0 W/kg, for 1-g or 10-g respectively, when the transmission band is  $\leq 100$  MHz
  - $\leq 0.6$  W/kg or 1.5 W/kg, for 1-g or 10-g respectively, when the transmission band is between 100 MHz and 200 MHz
  - $\leq 0.4$  W/kg or 1.0 W/kg, for 1-g or 10-g respectively, when the transmission band is  $\geq 200$  MHz
3. Per KDB 865664 D01v01r04, for each frequency band, repeated SAR measurement is required only when the measured SAR is  $\geq 0.8$ W/kg.

### **WLAN Note:**

1. Per KDB248227 D01 v02r02 section 5.2.1 2), when the reported SAR is  $> 0.8$  W/kg, SAR is required for that exposure configuration using the next highest measured output power channel. When any reported SAR is  $> 1.2$  W/kg, SAR is required for the third channel; i.e., all channels require testing.
2. When the highest reported SAR for DSSS is adjusted by the ratio of OFDM to DSSS specified maximum output power and the adjusted SAR is  $\leq 1.2$  W/kg, 802.11g/n OFDM SAR is not required, per KDB248227 D01 v02r01 section 5.2.2 2).



## 7.6 SAR Measurement Variability

According to KDB 865664 D01v01r04, SAR measurement variability must be assessed for each frequency band, which is determined by the SAR probe calibration point and tissue-equivalent medium used for the device measurements. When both head and body tissue-equivalent media are required for SAR measurements in a frequency band, the variability measurement procedures should be applied to the tissue medium with the highest measured SAR, using the highest measured SAR configuration for that tissue-equivalent medium. The following procedures are applied to determine if repeated measurements are required:

1. The original highest measured Reported SAR 1-g is  $\geq 0.80$  W/kg, repeated that measurement once.
2. Perform a second repeated measurement the ratio of the largest to the smallest SAR for the original and first repeated measurements is  $<1.2$  W/kg, or when the original or repeated measurement is  $\geq 1.45$  W/kg (~10% from the 1-g SAR limit).

N/A



## 8. Simultaneous Transmission Analysis

1. The reported SAR summation is calculated based on the same configuration and test position.
8. Per KDB 447498 D01v06, simultaneous transmission SAR is compliant if,
  - i) Scalar SAR summation  $< 1.6\text{W/kg}$ .
  - ii)  $\text{SPLSR} = (\text{SAR1} + \text{SAR2})^{1.5} / (\text{min. separation distance, mm})$ , and the peak separation distance is determined from the square root of  $[(x1-x2)^2 + (y1-y2)^2 + (z1-z2)^2]$ , where  $(x1, y1, z1)$  and  $(x2, y2, z2)$  are the coordinates of the extrapolated peak SAR locations in the zoom scan.
  - iii) If  $\text{SPLSR} \leq 0.04$ , simultaneously transmission SAR measurement is not necessary.
  - iv) Simultaneously transmission SAR measurement, and the reported multi-band SAR  $< 1.6\text{W/kg}$ .
  - v) The SPLSR calculated results please refer to section 8.2.

### 8.1 Co-location

N/A

### 8.2 SPLSR Evaluation

N/A



### 9. Measurement Uncertainty

| DASY5 Uncertainty Budget<br>According to IEEE 1528-2013 and IEC 62209-1/201x<br>(0.3 - 3 GHz range) |                        |             |         |         |          |                                |                                 |           |
|---|------------------------|-------------|---------|---------|----------|--------------------------------|---------------------------------|-----------|
| Error Description   | Uncertainty Value (±%) | Probability | Divisor | (Ci) 1g | (Ci) 10g | Standard Uncertainty (1g) (±%) | Standard Uncertainty (10g) (±%) | (Vi) Veff |
| <b>Measurement System</b>   |                        |             |         |         |          |                                |                                 |           |
| Probe Calibration   | 6.00                   | N           | 1       | 1       | 1        | 6.0                            | 6.0                             | ∞         |
| Axial Isotropy  | 4.70                   | R           | 1.732   | 0.7     | 0.7      | 1.9                            | 1.9                             | ∞         |
| Hemispherical Isotropy  | 9.60                   | R           | 1.732   | 0.7     | 0.7      | 3.9                            | 3.9                             | ∞         |
| Boundary Effects  | 1.00                   | R           | 1.732   | 1       | 1        | 0.6                            | 0.6                             | ∞         |
| Linearity   | 4.70                   | R           | 1.732   | 1       | 1        | 2.7                            | 2.7                             | ∞         |
| System Detection Limits   | 0.25                   | R           | 1.732   | 1       | 1        | 0.1                            | 0.1                             | ∞         |
| Modulation Response   | 2.40                   | R           | 1.732   | 1       | 1        | 1.4                            | 1.4                             | ∞         |
| Readout Electronics   | 0.30                   | N           | 1       | 1       | 1        | 0.3                            | 0.3                             | ∞         |
| Response Time   | 0.00                   | R           | 1.732   | 1       | 1        | 0.0                            | 0.0                             | ∞         |
| Integration Time  | 2.60                   | R           | 1.732   | 1       | 1        | 1.5                            | 1.5                             | ∞         |
| RF Ambient Noise  | 3.00                   | R           | 1.732   | 1       | 1        | 1.7                            | 1.7                             | ∞         |
| RF Ambient Reflections  | 3.00                   | R           | 1.732   | 1       | 1        | 1.7                            | 1.7                             | ∞         |
| Probe Positioner  | 0.40                   | R           | 1.732   | 1       | 1        | 0.2                            | 0.2                             | ∞         |
| Probe Positioning   | 2.90                   | R           | 1.732   | 1       | 1        | 1.7                            | 1.7                             | ∞         |
| Max. SAR Eval.  | 2.00                   | R           | 1.732   | 1       | 1        | 1.2                            | 1.2                             | ∞         |
| <b>Test Sample Related</b>  |                        |             |         |         |          |                                |                                 |           |
| Device Positioning  | 2.90                   | N           | 1       | 1       | 1        | 2.9                            | 2.9                             | 145       |
| Device Holder   | 3.60                   | N           | 1       | 1       | 1        | 3.6                            | 3.6                             | 5         |
| Power Drift   | 5.00                   | R           | 1.732   | 1       | 1        | 2.9                            | 2.9                             | ∞         |
| Power Scaling   | 0.00                   | R           | 1.732   | 1       | 1        | 0.0                            | 0.0                             | ∞         |
| <b>Phantom and Setup</b>  |                        |             |         |         |          |                                |                                 |           |
| Phantom Uncertainty   | 6.10                   | R           | 1.732   | 1       | 1        | 3.5                            | 3.5                             | ∞         |
| SAR correction  | 1.90                   | R           | 1.732   | 1       | 0.84     | 1.1                            | 0.9                             | ∞         |
| Liquid Conductivity (mea.)  | 2.50                   | R           | 1.732   | 0.78    | 0.71     | 1.1                            | 1.0                             | ∞         |
| Temp. unc. - Conductivity   | 3.36                   | R           | 1.732   | 0.78    | 0.71     | 1.5                            | 1.4                             | ∞         |
| Liquid Permittivity (mea.)  | 2.50                   | R           | 1.732   | 0.23    | 0.26     | 0.3                            | 0.4                             | ∞         |
| Temp. unc. - Permittivity   | 0.40                   | R           | 1.732   | 0.23    | 0.26     | 0.1                            | 0.1                             | ∞         |
| <b>Combined Std. Uncertainty</b>  |                        |             |         |         |          | 11.1%                          | 11.1%                           | 441       |
| <b>Coverage Factor for 95 %</b>   |                        |             |         |         |          | K=2                            | K=2                             |           |
| <b>Expanded STD Uncertainty</b>   |                        |             |         |         |          | 22.3%                          | 22.2%                           |           |



| DASY5 Uncertainty Budget<br>According to IEEE 1528-2013 and IEC 62209-1/201x<br>(3 - 6 GHz range) |                        |             |         |         |          |                                |                                 |           |
|---|------------------------|-------------|---------|---------|----------|--------------------------------|---------------------------------|-----------|
| Error Description   | Uncertainty Value (±%) | Probability | Divisor | (Ci) 1g | (Ci) 10g | Standard Uncertainty (1g) (±%) | Standard Uncertainty (10g) (±%) | (Vi) Veff |
| <b>Measurement System</b>   |                        |             |         |         |          |                                |                                 |           |
| Probe Calibration   | 6.55                   | N           | 1       | 1       | 1        | 6.6                            | 6.6                             | ∞         |
| Axial Isotropy  | 4.70                   | R           | 1.732   | 0.7     | 0.7      | 1.9                            | 1.9                             | ∞         |
| Hemispherical Isotropy  | 9.60                   | R           | 1.732   | 0.7     | 0.7      | 3.9                            | 3.9                             | ∞         |
| Boundary Effects  | 2.00                   | R           | 1.732   | 1       | 1        | 1.2                            | 1.2                             | ∞         |
| Linearity   | 4.70                   | R           | 1.732   | 1       | 1        | 2.7                            | 2.7                             | ∞         |
| System Detection Limits   | 0.25                   | R           | 1.732   | 1       | 1        | 0.1                            | 0.1                             | ∞         |
| Modulation Response   | 2.40                   | R           | 1.732   | 1       | 1        | 1.4                            | 1.4                             | ∞         |
| Readout Electronics   | 0.30                   | N           | 1       | 1       | 1        | 0.3                            | 0.3                             | ∞         |
| Response Time   | 0.00                   | R           | 1.732   | 1       | 1        | 0.0                            | 0.0                             | ∞         |
| Integration Time  | 2.60                   | R           | 1.732   | 1       | 1        | 1.5                            | 1.5                             | ∞         |
| RF Ambient Noise  | 3.00                   | R           | 1.732   | 1       | 1        | 1.7                            | 1.7                             | ∞         |
| RF Ambient Reflections  | 3.00                   | R           | 1.732   | 1       | 1        | 1.7                            | 1.7                             | ∞         |
| Probe Positioner  | 0.80                   | R           | 1.732   | 1       | 1        | 0.5                            | 0.5                             | ∞         |
| Probe Positioning   | 6.70                   | R           | 1.732   | 1       | 1        | 3.9                            | 3.9                             | ∞         |
| Max. SAR Eval.  | 2.00                   | R           | 1.732   | 1       | 1        | 1.2                            | 1.2                             | ∞         |
| <b>Test Sample Related</b>  |                        |             |         |         |          |                                |                                 |           |
| Device Positioning  | 2.90                   | N           | 1       | 1       | 1        | 2.9                            | 2.9                             | 145       |
| Device Holder   | 3.60                   | N           | 1       | 1       | 1        | 3.6                            | 3.6                             | 5         |
| Power Drift   | 5.00                   | R           | 1.732   | 1       | 1        | 2.9                            | 2.9                             | ∞         |
| Power Scaling   | 0.00                   | R           | 1.732   | 1       | 1        | 0.0                            | 0.0                             | ∞         |
| <b>Phantom and Setup</b>  |                        |             |         |         |          |                                |                                 |           |
| Phantom Uncertainty   | 6.60                   | R           | 1.732   | 1       | 1        | 3.8                            | 3.8                             | ∞         |
| SAR correction  | 1.90                   | R           | 1.732   | 1       | 0.84     | 1.1                            | 0.9                             | ∞         |
| Liquid Conductivity (mea.)  | 2.50                   | R           | 1.732   | 0.78    | 0.71     | 1.1                            | 1.0                             | ∞         |
| Temp. unc. - Conductivity   | 3.36                   | R           | 1.732   | 0.78    | 0.71     | 1.5                            | 1.4                             | ∞         |
| Liquid Permittivity (mea.)  | 2.50                   | R           | 1.732   | 0.23    | 0.26     | 0.3                            | 0.4                             | ∞         |
| Temp. unc. - Permittivity   | 0.40                   | R           | 1.732   | 0.23    | 0.26     | 0.1                            | 0.1                             | ∞         |
| <b>Combined Std. Uncertainty</b>  |                        |             |         |         |          | 12.1%                          | 12.1%                           | 614       |
| <b>Coverage Factor for 95 %</b>   |                        |             |         |         |          | K=2                            | K=2                             |           |
| <b>Expanded STD Uncertainty</b>   |                        |             |         |         |          | 24.2%                          | 24.1%                           |           |

-----THE END OF REPORT-----



**Appendix A. DASYS Calibration Certificate**



In Collaboration with  
**s p e a g**  
CALIBRATION LABORATORY



中国认可  
国际互认  
校准  
CALIBRATION  
CNAS L0570

Add: No.52 HuaYuanBei Road, Haidian District, Beijing, 100191, China  
Tel: +86-10-62304633-2512 Fax: +86-10-62304633-2504  
E-mail: cttl@chinattl.com [Http://www.chinattl.cn](http://www.chinattl.cn)

Client

**Cerpass**

Certificate No: **Z21-60266**

## CALIBRATION CERTIFICATE

Object **EX3DV4 - SN : 3927**

Calibration Procedure(s) **FF-Z11-004-02  
Calibration Procedures for Dosimetric E-field Probes**

Calibration date: **July 28, 2021**

This calibration Certificate documents the traceability to national standards, which realize the physical units of measurements(SI). The measurements and the uncertainties with confidence probability are given on the following pages and are part of the certificate.

All calibrations have been conducted in the closed laboratory facility: environment temperature(22±3)°C and humidity<70%.

### Calibration Equipment used (M&TE critical for calibration)

| Primary Standards        | ID #        | Cal Date(Calibrated by, Certificate No.) | Scheduled Calibration |
|--------------------------|-------------|--|-----------------------|
| Power Meter NRP2         | 101919      | 15-Jun-21(CTTL, No.J21X04466)            | Jun-22                |
| Power sensor NRP-Z91     | 101547      | 15-Jun-21(CTTL, No.J21X04466)            | Jun-22                |
| Power sensor NRP-Z91     | 101548      | 15-Jun-21(CTTL, No.J21X04466)            | Jun-22                |
| Reference 10dBAttenuator | 18N50W-10dB | 10-Feb-20(CTTL, No.J20X00525)            | Feb-22                |
| Reference 20dBAttenuator | 18N50W-20dB | 10-Feb-20(CTTL, No.J20X00526)            | Feb-22                |
| Reference Probe EX3DV4   | SN 3617     | 27-Jan-21(SPEAG, No.EX3-3617_Jan21)      | Jan-22                |
| DAE4                     | SN 1556     | 15-Jan-21(SPEAG, No.DAE4-1556_Jan21)     | Jan-22                |

| Secondary Standards     | ID #       | Cal Date(Calibrated by, Certificate No.) | Scheduled Calibration |
|-------------------------|------------|--|-----------------------|
| SignalGenerator MG3700A | 6201052605 | 16-Jun-21(CTTL, No.J21X04467)            | Jun-22                |
| Network Analyzer E5071C | MY46110673 | 21-Jan-21(CTTL, No.J20X00515)            | Jan-22                |

|                | Name        | Function           | Signature |
|----------------|-------------|--------------------|-----------|
| Calibrated by: | Yu Zongying | SAR Test Engineer  |           |
| Reviewed by:   | Lin Hao     | SAR Test Engineer  |           |
| Approved by:   | Qi Dianyuan | SAR Project Leader |           |

Issued: July 30, 2021

This calibration certificate shall not be reproduced except in full without written approval of the laboratory.





## Glossary:

|                       |  |
|-----------------------|--|
| TSL                   | tissue simulating liquid   |
| NORM <sub>x,y,z</sub> | sensitivity in free space  |
| ConvF                 | sensitivity in TSL / NORM <sub>x,y,z</sub>   |
| DCP                   | diode compression point  |
| CF                    | crest factor (1/duty_cycle) of the RF signal   |
| A,B,C,D               | modulation dependent linearization parameters  |
| Polarization $\Phi$   | $\Phi$ rotation around probe axis  |
| Polarization $\theta$ | $\theta$ rotation around an axis that is in the plane normal to probe axis (at measurement center), $\theta=0$ is normal to probe axis |

Connector Angle information used in DASY system to align probe sensor X to the robot coordinate system

## Calibration is Performed According to the Following Standards:

- IEEE Std 1528-2013, "IEEE Recommended Practice for Determining the Peak Spatial-Averaged Specific Absorption Rate (SAR) in the Human Head from Wireless Communications Devices: Measurement Techniques", June 2013
- IEC 62209-1, "Measurement procedure for the assessment of Specific Absorption Rate (SAR) from hand-held and body-mounted devices used next to the ear (frequency range of 300 MHz to 6 GHz)", July 2016
- IEC 62209-2, "Procedure to determine the Specific Absorption Rate (SAR) for wireless communication devices used in close proximity to the human body (frequency range of 30 MHz to 6 GHz)", March 2010
- KDB 865664, "SAR Measurement Requirements for 100 MHz to 6 GHz"

## Methods Applied and Interpretation of Parameters:

- NORM<sub>x,y,z</sub>**: Assessed for E-field polarization  $\theta=0$  ( $f \leq 900$  MHz in TEM-cell;  $f > 1800$  MHz: waveguide). NORM<sub>x,y,z</sub> are only intermediate values, i.e., the uncertainties of NORM<sub>x,y,z</sub> does not effect the  $E^2$ -field uncertainty inside TSL (see below ConvF).
- NORM(f)<sub>x,y,z</sub>** = NORM<sub>x,y,z</sub> \* frequency\_response (see Frequency Response Chart). This linearization is implemented in DASY4 software versions later than 4.2. The uncertainty of the frequency response is included in the stated uncertainty of ConvF.
- DCP<sub>x,y,z</sub>**: DCP are numerical linearization parameters assessed based on the data of power sweep (no uncertainty required). DCP does not depend on frequency nor media.
- PAR**: PAR is the Peak to Average Ratio that is not calibrated but determined based on the signal characteristics.
- A<sub>x,y,z</sub>; B<sub>x,y,z</sub>; C<sub>x,y,z</sub>; VR<sub>x,y,z</sub>; A,B,C** are numerical linearization parameters assessed based on the data of power sweep for specific modulation signal. The parameters do not depend on frequency nor media. VR is the maximum calibration range expressed in RMS voltage across the diode.
- ConvF and Boundary Effect Parameters**: Assessed in flat phantom using E-field (or Temperature Transfer Standard for  $f \leq 800$  MHz) and inside waveguide using analytical field distributions based on power measurements for  $f > 800$  MHz. The same setups are used for assessment of the parameters applied for boundary compensation (alpha, depth) of which typical uncertainty valued are given. These parameters are used in DASY4 software to improve probe accuracy close to the boundary. The sensitivity in TSL corresponds to NORM<sub>x,y,z</sub> \* ConvF whereby the uncertainty corresponds to that given for ConvF. A frequency dependent ConvF is used in DASY version 4.4 and higher which allows extending the validity from  $\pm 50$  MHz to  $\pm 100$  MHz.
- Spherical isotropy (3D deviation from isotropy)**: in a field of low gradients realized using a flat phantom exposed by a patch antenna.
- Sensor Offset**: The sensor offset corresponds to the offset of virtual measurement center from the probe tip (on probe axis). No tolerance required.
- Connector Angle**: The angle is assessed using the information gained by determining the NORM<sub>x</sub> (no uncertainty required).



## DASY/EASY – Parameters of Probe: EX3DV4 – SN:3927

### Basic Calibration Parameters

|  | Sensor X | Sensor Y | Sensor Z | Unc (k=2) |
|--|----------|----------|----------|-----------|
| Norm( $\mu\text{V}/(\text{V}/\text{m})^2$ ) <sup>A</sup> | 0.60     | 0.69     | 0.61     | ±10.0%    |
| DCP(mV) <sup>B</sup>                                     | 103.5    | 98.9     | 103.0    |           |

### Modulation Calibration Parameters

| UID | Communication System Name |   | A dB | B dB/ $\mu\text{V}$ | C   | D dB | VR mV | Unc <sup>E</sup> (k=2) |
|-----|---------------------------|---|------|---------------------|-----|------|-------|------------------------|
| 0   | CW                        | X | 0.0  | 0.0                 | 1.0 | 0.00 | 183.1 | ±2.3%                  |
|     |                           | Y | 0.0  | 0.0                 | 1.0 |      | 197.5 |                        |
|     |                           | Z | 0.0  | 0.0                 | 1.0 |      | 184.7 |                        |

The reported uncertainty of measurement is stated as the standard uncertainty of Measurement multiplied by the coverage factor  $k=2$ , which for a normal distribution Corresponds to a coverage probability of approximately 95%.

<sup>A</sup> The uncertainties of Norm X, Y, Z do not affect the E<sup>2</sup>-field uncertainty inside TSL (see Page 4).

<sup>B</sup> Numerical linearization parameter: uncertainty not required.

<sup>E</sup> Uncertainty is determined using the max. deviation from linear response applying rectangular distribution and is expressed for the square of the field value.



## DASY/EASY – Parameters of Probe: EX3DV4 – SN:3927

### Calibration Parameter Determined in Head Tissue Simulating Media

| f [MHz] <sup>C</sup> | Relative Permittivity <sup>F</sup> | Conductivity (S/m) <sup>F</sup> | ConvF X | ConvF Y | ConvF Z | Alpha <sup>G</sup> | Depth <sup>G</sup> (mm) | Unct. (k=2) |
|----------------------|------------------------------------|---------------------------------|---------|---------|---------|--------------------|-------------------------|-------------|
| 2450                 | 39.2                               | 1.80                            | 7.75    | 7.75    | 7.75    | 0.45               | 0.81                    | ±12.1%      |
| 5250                 | 35.9                               | 4.71                            | 5.45    | 5.45    | 5.45    | 0.40               | 1.45                    | ±13.3%      |
| 5750                 | 35.4                               | 5.22                            | 4.98    | 4.98    | 4.98    | 0.50               | 1.30                    | ±13.3%      |

<sup>C</sup> Frequency validity above 300 MHz of ±100MHz only applies for DASY v4.4 and higher (Page 2), else it is restricted to ±50MHz. The uncertainty is the RSS of ConvF uncertainty at calibration frequency and the uncertainty for the indicated frequency band. Frequency validity below 300 MHz is ± 10, 25, 40, 50 and 70 MHz for ConvF assessments at 30, 64, 128, 150 and 220 MHz respectively. Above 5 GHz frequency validity can be extended to ± 110 MHz.

<sup>F</sup> At frequency below 3 GHz, the validity of tissue parameters ( $\epsilon$  and  $\sigma$ ) can be relaxed to ±10% if liquid compensation formula is applied to measured SAR values. At frequencies above 3 GHz, the validity of tissue parameters ( $\epsilon$  and  $\sigma$ ) is restricted to ±5%. The uncertainty is the RSS of the ConvF uncertainty for indicated target tissue parameters.

<sup>G</sup> Alpha/Depth are determined during calibration. SPEAG warrants that the remaining deviation due to the boundary effect after compensation is always less than ± 1% for frequencies below 3 GHz and below ± 2% for the frequencies between 3-6 GHz at any distance larger than half the probe tip diameter from the boundary.



## Frequency Response of E-Field (TEM-Cell: ifi110 EXX, Waveguide: R22)

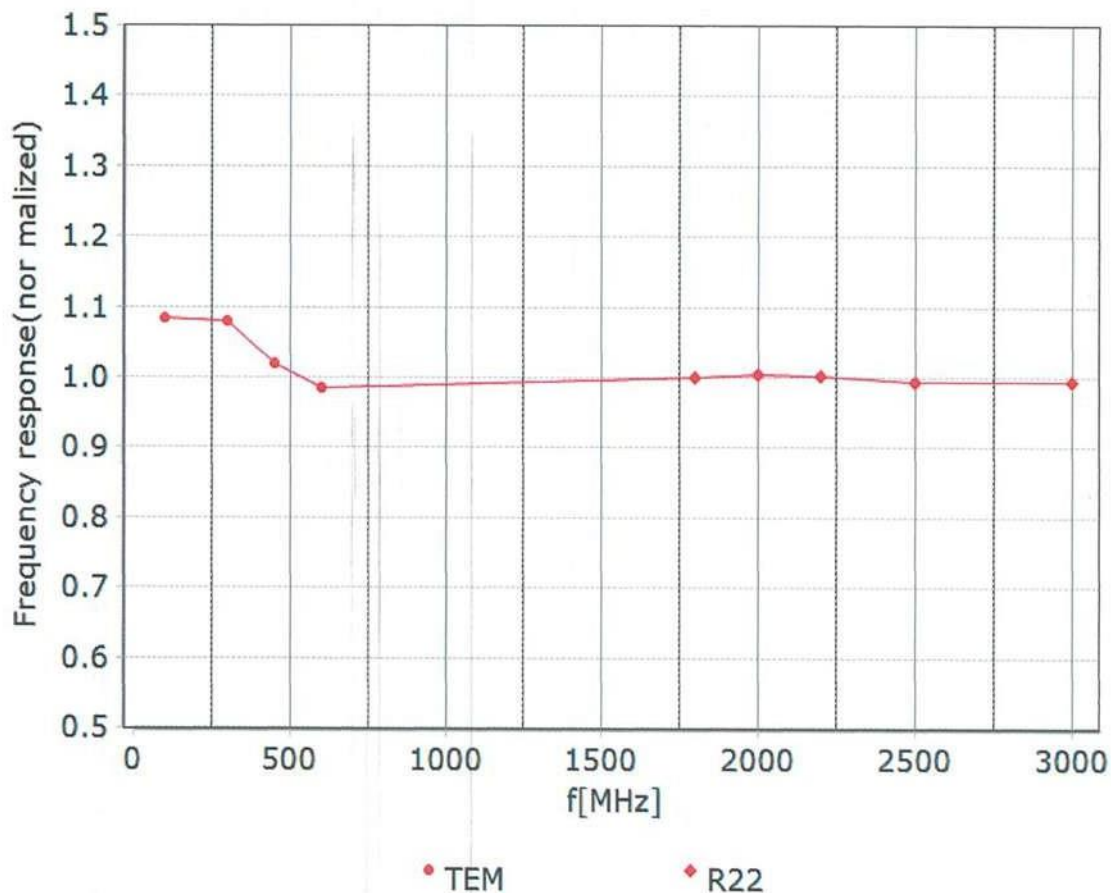

Uncertainty of Frequency Response of E-field:  $\pm 7.4\%$  ( $k=2$ )



## Receiving Pattern ( $\Phi$ ), $\theta=0^\circ$

**f=600 MHz, TEM**

**f=1800 MHz, R22**

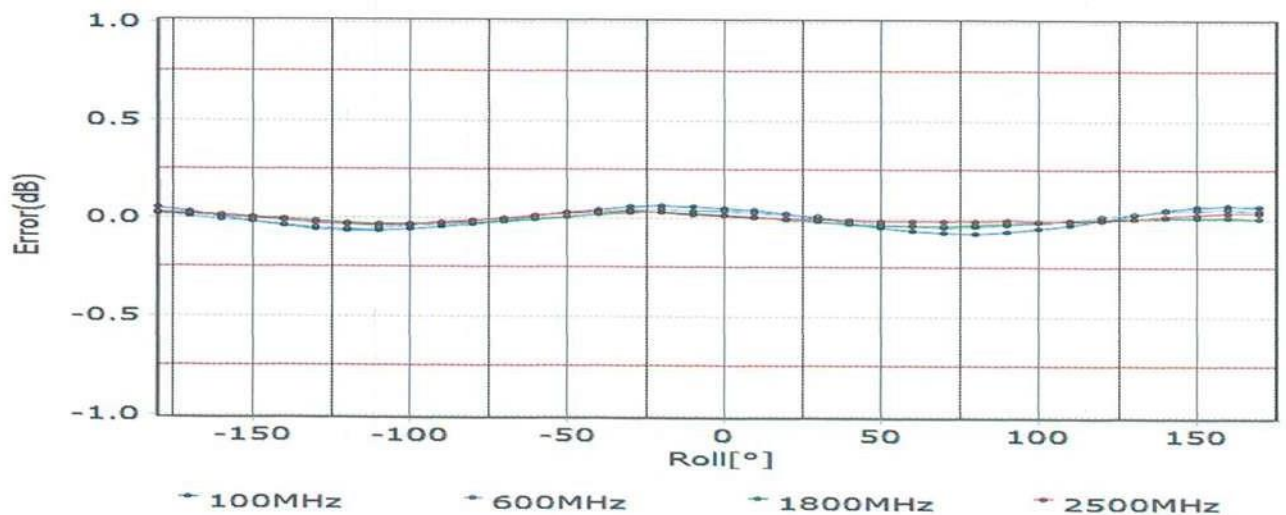
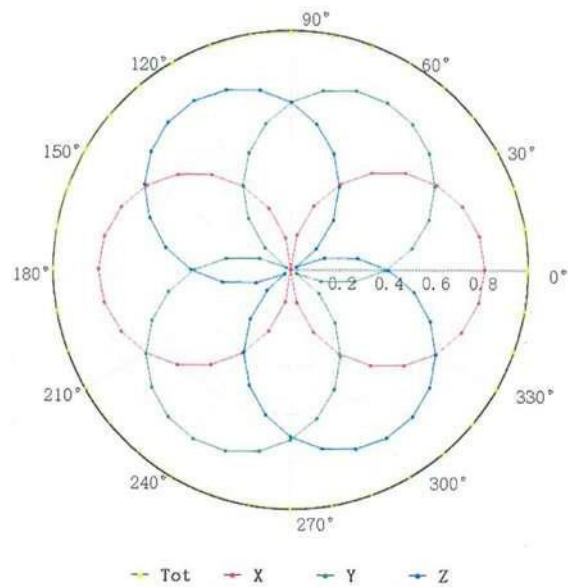
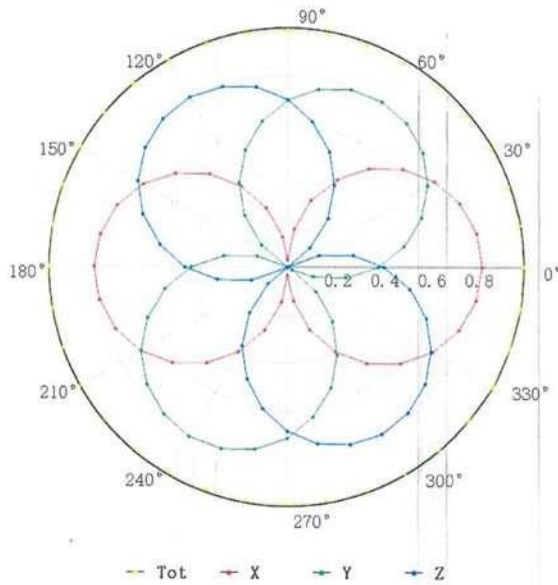

Uncertainty of Axial Isotropy Assessment:  $\pm 1.2\%$  ( $k=2$ )



## Dynamic Range f(SAR<sub>head</sub>) (TEM cell, f = 900 MHz)

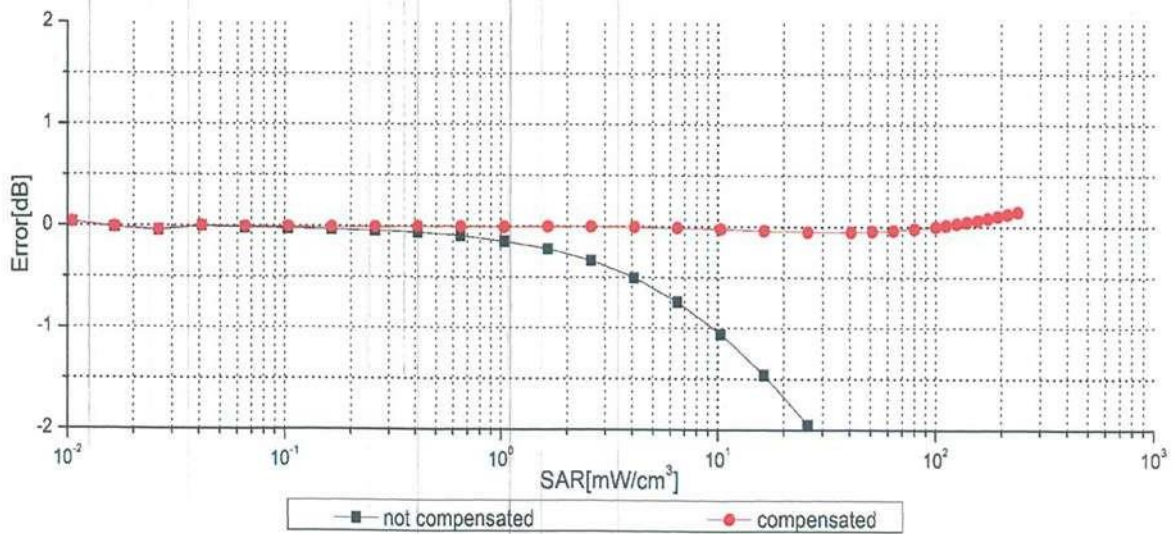
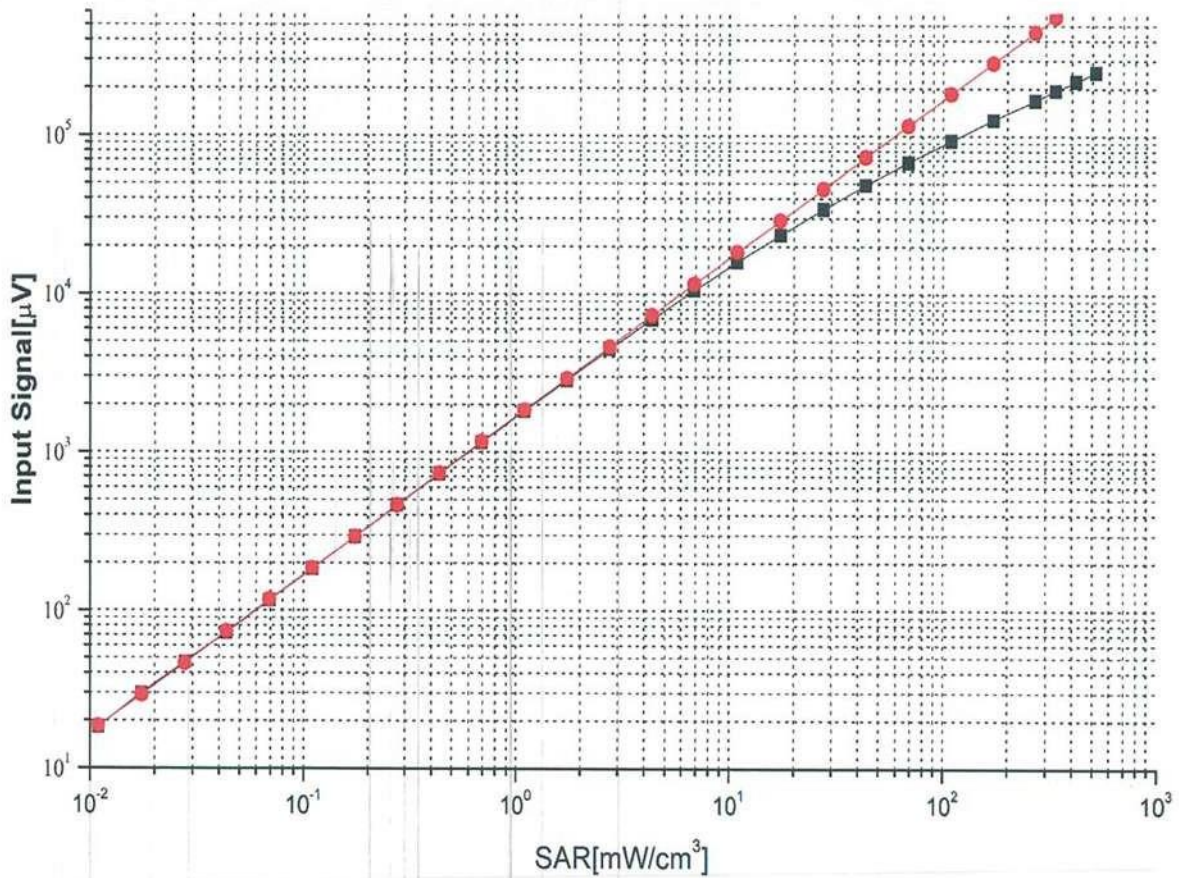

Uncertainty of Linearity Assessment: ±0.9% (k=2)



## Conversion Factor Assessment

f=2450 MHz,WGLS R26(H\_convF)

f=5250 MHz,WGLS R58(H\_convF)

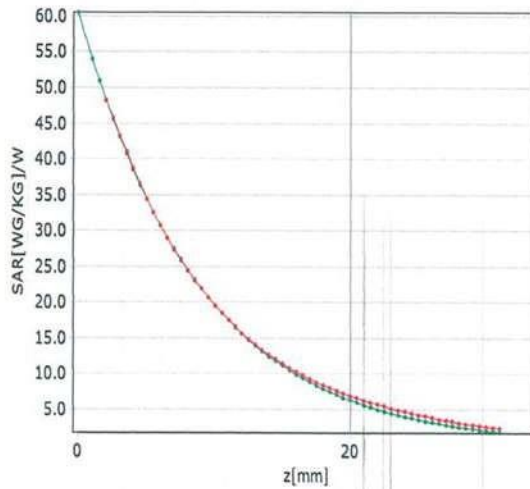

\* analytical \* measured

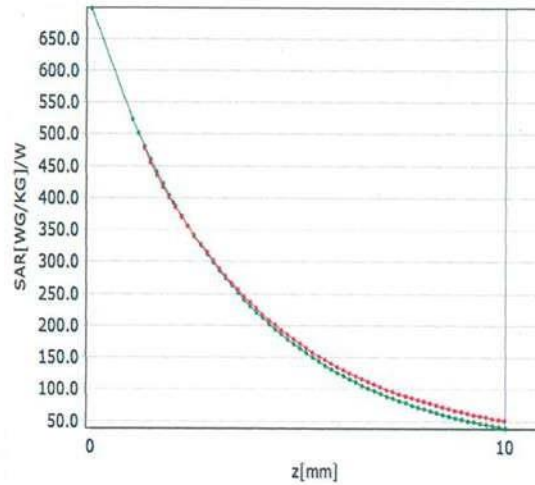

\* analytical \* measured

## Deviation from Isotropy in Liquid

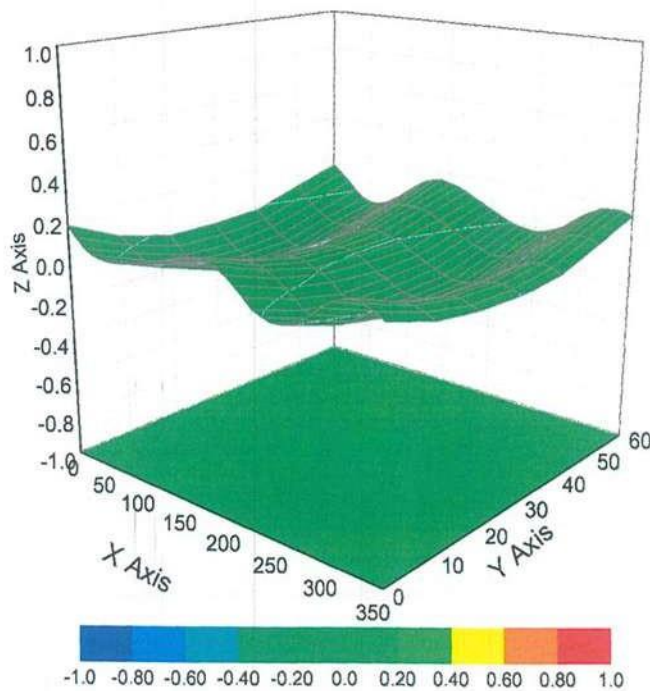

Uncertainty of Spherical Isotropy Assessment:  $\pm 3.2\%$  ( $k=2$ )



## DASY/EASY – Parameters of Probe: EX3DV4 – SN:3927

### Other Probe Parameters

|   |            |
|---|------------|
| Sensor Arrangement                            | Triangular |
| Connector Angle (°)                           | 22.2       |
| Mechanical Surface Detection Mode             | enabled    |
| Optical Surface Detection Mode                | disable    |
| Probe Overall Length                          | 337mm      |
| Probe Body Diameter                           | 10mm       |
| Tip Length                                    | 9mm        |
| Tip Diameter                                  | 2.5mm      |
| Probe Tip to Sensor X Calibration Point       | 1mm        |
| Probe Tip to Sensor Y Calibration Point       | 1mm        |
| Probe Tip to Sensor Z Calibration Point       | 1mm        |
| Recommended Measurement Distance from Surface | 1.4mm      |





In Collaboration with  
**s p e a g**  
CALIBRATION LABORATORY



中国认可  
国际互认  
校准  
CALIBRATION  
CNAS L0570

Add: No.52 HuaYuanBei Road, Haidian District, Beijing, 100191, China  
Tel: +86-10-62304633-2512 Fax: +86-10-62304633-2504  
E-mail: cttl@chinattl.com [Http://www.chinattl.cn](http://www.chinattl.cn)

Client : **Cerpass**

Certificate No: **Z21-60265**

## CALIBRATION CERTIFICATE

Object: **DAE4 - SN: 1379**

Calibration Procedure(s): **FF-Z11-002-01**  
Calibration Procedure for the Data Acquisition Electronics (DAEx)

Calibration date: **July 15, 2021**

This calibration Certificate documents the traceability to national standards, which realize the physical units of measurements(SI). The measurements and the uncertainties with confidence probability are given on the following pages and are part of the certificate.

All calibrations have been conducted in the closed laboratory facility: environment temperature(22±3)°C and humidity<70%.

Calibration Equipment used (M&TE critical for calibration)

| Primary Standards      | ID #    | Cal Date(Calibrated by, Certificate No.) | Scheduled Calibration |
|------------------------|---------|--|-----------------------|
| Process Calibrator 753 | 1971018 | 15-Jun-21 (CTTL, No.J21X04465)           | Jun-22                |

|                | Name        | Function           | Signature |
|----------------|-------------|--------------------|-----------|
| Calibrated by: | Yu Zongying | SAR Test Engineer  |           |
| Reviewed by:   | Lin Hao     | SAR Test Engineer  |           |
| Approved by:   | Qi Dianyuan | SAR Project Leader |           |

Issued: July 22, 2021

This calibration certificate shall not be reproduced except in full without written approval of the laboratory.



In Collaboration with

**s p e a g**  
**CALIBRATION LABORATORY**

Add: No.52 HuaYuanBei Road, Haidian District, Beijing, 100191, China

Tel: +86-10-62304633-2512 Fax: +86-10-62304633-2504

E-mail: cttl@chinattl.com Http://www.chinattl.cn

### **Glossary:**

DAE data acquisition electronics  
Connector angle information used in DASY system to align probe sensor X to the robot coordinate system.

### **Methods Applied and Interpretation of Parameters:**

- *DC Voltage Measurement:* Calibration Factor assessed for use in DASY system by comparison with a calibrated instrument traceable to national standards. The figure given corresponds to the full scale range of the voltmeter in the respective range.
- *Connector angle:* The angle of the connector is assessed measuring the angle mechanically by a tool inserted. Uncertainty is not required.
- The report provide only calibration results for DAE, it does not contain other performance test results.



Add: No.52 HuaYuanBei Road, Haidian District, Beijing, 100191, China  
Tel: +86-10-62304633-2512 Fax: +86-10-62304633-2504  
E-mail: cttl@chinattl.com Http://www.chinattl.cn

### DC Voltage Measurement

A/D - Converter Resolution nominal

High Range: 1LSB = 6.1 $\mu$ V, full range = -100...+300 mV

Low Range: 1LSB = 61nV, full range = -1.....+3mV

DASY measurement parameters: Auto Zero Time: 3 sec; Measuring time: 3 sec

| Calibration Factors | X                         | Y                         | Z                         |
|---------------------|---------------------------|---------------------------|---------------------------|
| High Range          | 403.898 $\pm$ 0.15% (k=2) | 404.162 $\pm$ 0.15% (k=2) | 404.105 $\pm$ 0.15% (k=2) |
| Low Range           | 4.00888 $\pm$ 0.7% (k=2)  | 3.98053 $\pm$ 0.7% (k=2)  | 4.00108 $\pm$ 0.7% (k=2)  |

### Connector Angle

|   |                                   |
|---|-----------------------------------|
| Connector Angle to be used in DASY system | 149 $^{\circ}$ $\pm$ 1 $^{\circ}$ |
|---|-----------------------------------|



In Collaboration with  
**s p e a g**  
CALIBRATION LABORATORY



中国认可  
国际互认  
校准  
CALIBRATION  
CNAS L0570

Add: No.52 HuaYuanBei Road, Haidian District, Beijing, 100191, Chi  
Tel: +86-10-62304633-2079 Fax: +86-10-62304633-2504  
E-mail: cttl@chinattl.com http://www.chinattl.cn

Client

Cerpass

Certificate No: Z21-60267

## CALIBRATION CERTIFICATE

Object D2450V2 - SN: 914

Calibration Procedure(s) FF-Z11-003-01  
Calibration Procedures for dipole validation kits

Calibration date: August 26, 2021

This calibration Certificate documents the traceability to national standards, which realize the physical units of measurements (SI). The measurements and the uncertainties with confidence probability are given on the following pages and are part of the certificate.

All calibrations have been conducted in the closed laboratory facility: environment temperature (22±3)°C and humidity<70%.

Calibration Equipment used (M&TE critical for calibration)

| Primary Standards       | ID #       | Cal Date (Calibrated by, Certificate No.) | Scheduled Calibration |
|-------------------------|------------|---|-----------------------|
| Power Meter NRP2        | 106277     | 23-Sep-20 (CTTL, No.J20X08336)            | Sep-21                |
| Power sensor NRP8S      | 104291     | 23-Sep-20 (CTTL, No.J20X08336)            | Sep-21                |
| Reference Probe EX3DV4  | SN 7517    | 03-Feb-21(CTTL-SPEAG,No.Z21-60001)        | Feb-22                |
| DAE3                    | SN 536     | 06-Nov-20(CTTL-SPEAG,No.Z20-60452)        | Nov-21                |
| Secondary Standards     | ID #       | Cal Date (Calibrated by, Certificate No.) | Scheduled Calibration |
| Signal Generator E4438C | MY49071430 | 01-Feb-21 (CTTL, No.J21X00593)            | Jan-22                |
| NetworkAnalyzer E5071C  | MY46110673 | 14-Jan-21 (CTTL, No.J21X00232)            | Jan-22                |

|                | Name        | Function           | Signature |
|----------------|-------------|--------------------|-----------|
| Calibrated by: | Zhao Jing   | SAR Test Engineer  |           |
| Reviewed by:   | Lin Hao     | SAR Test Engineer  |           |
| Approved by:   | Qi Dianyuan | SAR Project Leader |           |

Issued: August 31, 2021

This calibration certificate shall not be reproduced except in full without written approval of the laboratory.



**Glossary:**

|       |  |
|-------|--|
| TSL   | tissue simulating liquid                   |
| ConvF | sensitivity in TSL / NORM <sub>x,y,z</sub> |
| N/A   | not applicable or not measured             |

**Calibration is Performed According to the Following Standards:**

- IEEE Std 1528-2013, "IEEE Recommended Practice for Determining the Peak Spatial-Averaged Specific Absorption Rate (SAR) in the Human Head from Wireless Communications Devices: Measurement Techniques", June 2013
- IEC 62209-1, "Measurement procedure for assessment of specific absorption rate of human exposure to radio frequency fields from hand-held and body-mounted wireless communication devices- Part 1: Device used next to the ear (Frequency range of 300MHz to 6GHz)", July 2016
- IEC 62209-2, "Procedure to measure the Specific Absorption Rate (SAR) For wireless communication devices used in close proximity to the human body (frequency range of 30MHz to 6GHz)", March 2010
- KDB865664, SAR Measurement Requirements for 100 MHz to 6 GHz

**Additional Documentation:**

- DASY4/5 System Handbook

**Methods Applied and Interpretation of Parameters:**

- Measurement Conditions:* Further details are available from the Validation Report at the end of the certificate. All figures stated in the certificate are valid at the frequency indicated.
- Antenna Parameters with TSL:* The dipole is mounted with the spacer to position its feed point exactly below the center marking of the flat phantom section, with the arms oriented parallel to the body axis.
- Feed Point Impedance and Return Loss:* These parameters are measured with the dipole positioned under the liquid filled phantom. The impedance stated is transformed from the measurement at the SMA connector to the feed point. The Return Loss ensures low reflected power. No uncertainty required.
- Electrical Delay:* One-way delay between the SMA connector and the antenna feed point. No uncertainty required.
- SAR measured:* SAR measured at the stated antenna input power.
- SAR normalized:* SAR as measured, normalized to an input power of 1 W at the antenna connector.
- SAR for nominal TSL parameters:* The measured TSL parameters are used to calculate the nominal SAR result.

The reported uncertainty of measurement is stated as the standard uncertainty of Measurement multiplied by the coverage factor  $k=2$ , which for a normal distribution Corresponds to a coverage probability of approximately 95%.



Add: No.52 HuaYuanBei Road, Haidian District, Beijing, 100191, China  
 Tel: +86-10-62304633-2079 Fax: +86-10-62304633-2504  
 E-mail: cttl@chinattl.com http://www.chinattl.cn

### Measurement Conditions

DASY system configuration, as far as not given on page 1.

|                              |                          |             |
|------------------------------|--------------------------|-------------|
| DASY Version                 | DASY52                   | V52.10.4    |
| Extrapolation                | Advanced Extrapolation   |             |
| Phantom                      | Triple Flat Phantom 5.1C |             |
| Distance Dipole Center - TSL | 10 mm                    | with Spacer |
| Zoom Scan Resolution         | dx, dy, dz = 5 mm        |             |
| Frequency                    | 2450 MHz ± 1 MHz         |             |

### Head TSL parameters

The following parameters and calculations were applied.

|   | Temperature     | Permittivity | Conductivity     |
|---|-----------------|--------------|------------------|
| Nominal Head TSL parameters             | 22.0 °C         | 39.2         | 1.80 mho/m       |
| Measured Head TSL parameters            | (22.0 ± 0.2) °C | 40.0 ± 6 %   | 1.77 mho/m ± 6 % |
| Head TSL temperature change during test | <1.0 °C         | ----         | ----             |

### SAR result with Head TSL

|   |                    |                                 |
|---|--------------------|---------------------------------|
| SAR averaged over 1 cm <sup>3</sup> (1 g) of Head TSL   | Condition          |                                 |
| SAR measured  | 250 mW input power | 13.0 W/kg                       |
| SAR for nominal Head TSL parameters                     | normalized to 1W   | <b>52.6 W/kg ± 18.8 % (k=2)</b> |
| SAR averaged over 10 cm <sup>3</sup> (10 g) of Head TSL | Condition          |                                 |
| SAR measured  | 250 mW input power | 5.92 W/kg                       |
| SAR for nominal Head TSL parameters                     | normalized to 1W   | <b>23.9 W/kg ± 18.7 % (k=2)</b> |



Add: No.52 HuaYuanBei Road, Haidian District, Beijing, 100191, China  
Tel: +86-10-62304633-2079 Fax: +86-10-62304633-2504  
E-mail: cttl@chinattl.com http://www.chinattl.cn

### Appendix (Additional assessments outside the scope of CNAS L0570)

#### Antenna Parameters with Head TSL

|                                      |               |
|--------------------------------------|---------------|
| Impedance, transformed to feed point | 54.3Ω+ 2.55jΩ |
| Return Loss                          | - 26.4dB      |

#### General Antenna Parameters and Design

|                                  |          |
|----------------------------------|----------|
| Electrical Delay (one direction) | 1.056 ns |
|----------------------------------|----------|

After long term use with 100W radiated power, only a slight warming of the dipole near the feedpoint can be measured.

The dipole is made of standard semirigid coaxial cable. The center conductor of the feeding line is directly connected to the second arm of the dipole. The antenna is therefore short-circuited for DC-signals. On some of the dipoles, small end caps are added to the dipole arms in order to improve matching when loaded according to the position as explained in the "Measurement Conditions" paragraph. The SAR data are not affected by this change. The overall dipole length is still according to the Standard. No excessive force must be applied to the dipole arms, because they might bend or the soldered connections near the feedpoint may be damaged.

#### Additional EUT Data

|                 |       |
|-----------------|-------|
| Manufactured by | SPEAG |
|-----------------|-------|



Add: No.52 HuaYuanBei Road, Haidian District, Beijing, 100191, China  
Tel: +86-10-62304633-2079 Fax: +86-10-62304633-2504  
E-mail: cttl@chinattl.com http://www.chinattl.cn

### DASY5 Validation Report for Head TSL

Date: 08.26.2021

Test Laboratory: CTTL, Beijing, China

**DUT: Dipole 2450 MHz; Type: D2450V2; Serial: D2450V2 - SN: 914**

Communication System: UID 0, CW; Frequency: 2450 MHz; Duty Cycle: 1:1

Medium parameters used:  $f = 2450$  MHz;  $\sigma = 1.772$  S/m;  $\epsilon_r = 40.04$ ;  $\rho = 1000$  kg/m<sup>3</sup>

Phantom section: Right Section

DASY5 Configuration:

- Probe: EX3DV4 - SN7517; ConvF(7.34, 7.34, 7.34) @ 2450 MHz; Calibrated: 2021-02-03
- Sensor-Surface: 1.4mm (Mechanical Surface Detection)
- Electronics: DAE3 Sn536; Calibrated: 2020-11-06
- Phantom: MFP\_V5.1C (20deg probe tilt); Type: QD 000 P51 Cx; Serial: 1062
- Measurement SW: DASY52, Version 52.10 (4); SEMCAD X Version 14.6.14 (7483)

**Dipole Calibration/Zoom Scan (7x7x7) (7x7x7)/Cube 0:** Measurement grid: dx=5mm, dy=5mm, dz=5mm

Reference Value = 108.2 V/m; Power Drift = -0.03 dB

Peak SAR (extrapolated) = 27.7 W/kg

**SAR(1 g) = 13 W/kg; SAR(10 g) = 5.92 W/kg**

Smallest distance from peaks to all points 3 dB below = 9 mm

Ratio of SAR at M2 to SAR at M1 = 46.8%

Maximum value of SAR (measured) = 22.2 W/kg

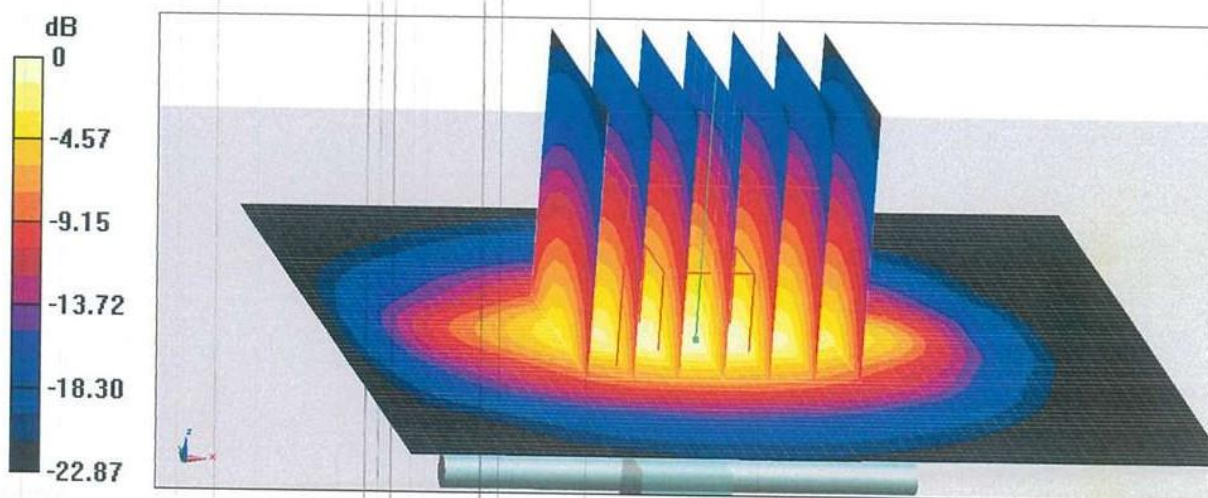

0 dB = 22.2 W/kg = 13.46 dBW/kg





Add: No.52 HuaYuanBei Road, Haidian District, Beijing, 100191, China  
Tel: +86-10-62304633-2079 Fax: +86-10-62304633-2504  
E-mail: cttl@chinattl.com http://www.chinattl.cn

### Impedance Measurement Plot for Head TSL

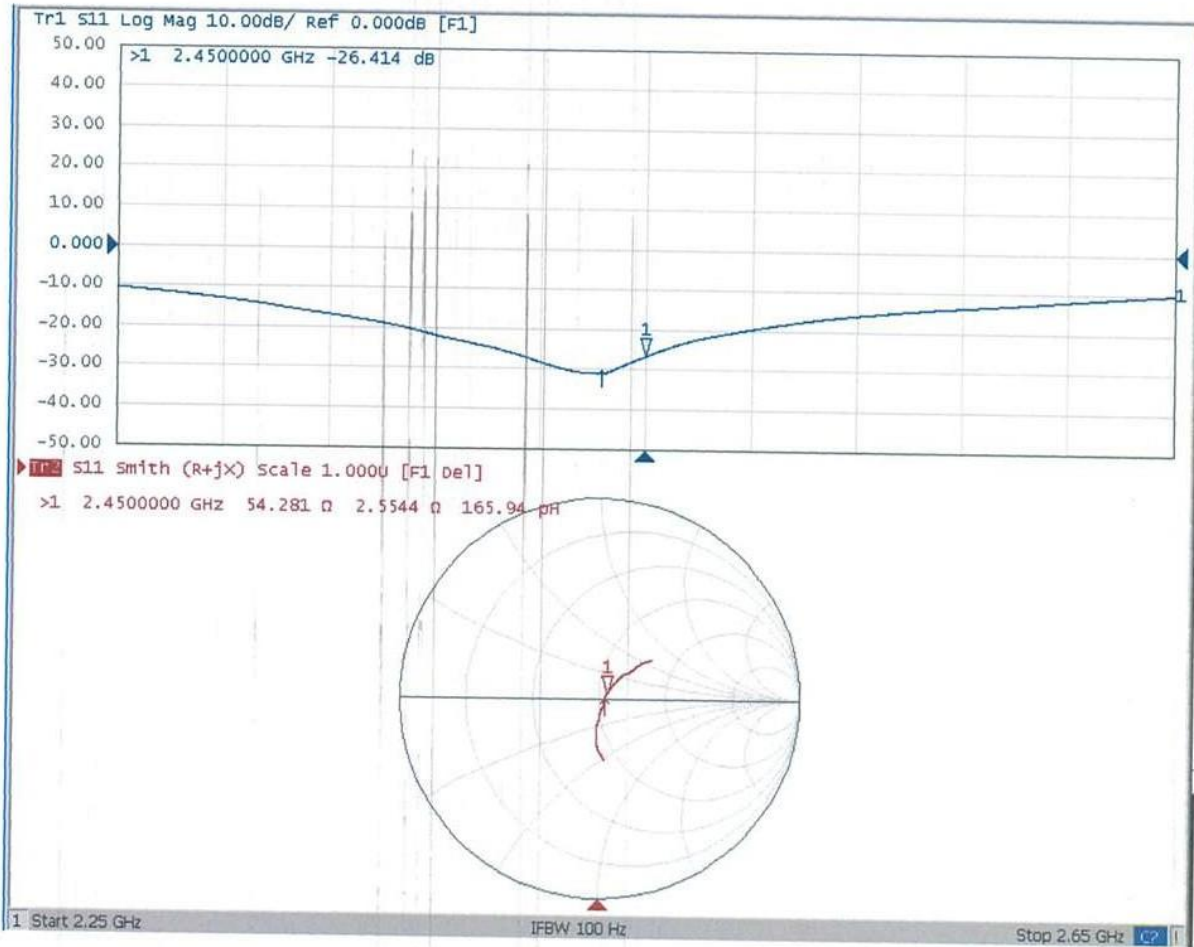



### Appendix B. System Performance Check

Tissue Calibration Result :

#### 6.1.3

| Frequency (MHz) | Liquid Temp | Measured Values (W/kg) |                   | Target Values (W/kg) |                   | Deviation[%] |       | Limit | Measured. Date |
|-----------------|-------------|------------------------|-------------------|----------------------|-------------------|--------------|-------|-------|----------------|
|                 |             | $\sigma$               | $\epsilon r (e')$ | $\sigma$             | $\epsilon r (e')$ | 1g           | 10g   | %     |                |
| 2450            | 22.5        | 1.86                   | 40.665            | 1.8                  | 39.2              | 3.33%        | 3.74% | ±5%   | 2022/6/1       |
| 2402            | 22.5        | 1.82                   | 40.7              | 1.76                 | 39.29             | 3.41%        | 3.59% | ±5%   | 2022/6/1       |
| 2440            | 22.5        | 1.85                   | 40.68             | 1.79                 | 39.22             | 3.35%        | 3.72% | ±5%   | 2022/6/1       |
| 2480            | 22.5        | 1.88                   | 40.61             | 1.83                 | 39.16             | 2.73%        | 3.70% | ±5%   | 2022/6/1       |

Result of System Performance Check :

#### 6.1.7

| Frequency (MHz) | Dipole S/N | Measured SAR Values (W/kg) |      | Target SAR Values (W/kg) |      | Deviation[%] |       | Limit | Measured. Date |
|-----------------|------------|----------------------------|------|--------------------------|------|--------------|-------|-------|----------------|
|                 |            | 1g                         | 10g  | 1g                       | 10g  | 1g           | 10g   | %     |                |
| 2450            | 914        | 13.4                       | 6.25 | 52.6                     | 23.9 | 1.90%        | 4.60% | ±10%  | 2022/6/1       |



**System Check\_Head\_2450MHz**

Date: 2022/6/1

**DUT: D2450V2 - SN:914**

Communication System: CW; Frequency: 2450 MHz; Duty Cycle: 1:1

Medium parameters used :  $f = 2450 \text{ MHz}$ ;  $\sigma = 1.86 \text{ S/m}$ ;  $\epsilon_r = 40.665$ ;  $\rho = 1000 \text{ kg/m}^3$

Phantom section: Flat Section

DASY5 Configuration:

- Probe: EX3DV4 - SN3927; ConvF(7.75, 7.75, 7.75) @ 2450 MHz; Calibrated: 2021/7/28
- Sensor-Surface: 1.4mm (Mechanical Surface Detection)
- Electronics: DAE4 Sn1379; Calibrated: 2021/7/19
- Phantom: ELI v5.0 (20deg probe tilt); Type: QDOVA002AA; Serial: TP:xxxx
- Measurement SW: DASY52, Version 52.10 (4); SEMCAD X Version 14.6.14 (7483)

**2450MHz/Area Scan (81x81x1):** Interpolated grid:  $dx=1.200 \text{ mm}$ ,  $dy=1.200 \text{ mm}$

Maximum value of SAR (interpolated) = 22.9 W/kg

**2450MHz/Zoom Scan (7x7x7)/Cube 0:** Measurement grid:  $dx=5\text{mm}$ ,  $dy=5\text{mm}$ ,  $dz=5\text{mm}$

Reference Value = 117.2 V/m; Power Drift = -0.15 dB

Peak SAR (extrapolated) = 28.0 W/kg

**SAR(1 g) = 13.4 W/kg; SAR(10 g) = 6.25 W/kg**

Smallest distance from peaks to all points 3 dB below = 9 mm

Ratio of SAR at M2 to SAR at M1 = 48.1%

Maximum value of SAR (measured) = 22.6 W/kg

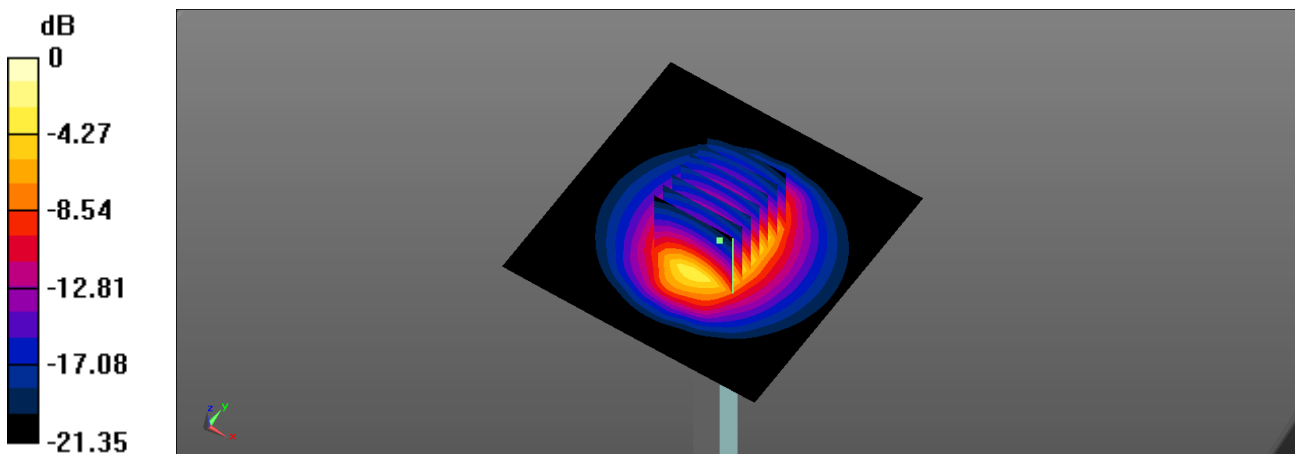

0 dB = 22.6 W/kg = 13.54 dBW/kg



### Appendix C. Measured Conducted Power

**BT-LE:**

| Frequency | Modulation | Data Rate | Conducted Power | Target power |
|-----------|------------|-----------|-----------------|--------------|
| 2402      | GFSK       | 1M        | 9.55            | 10           |
| 2440      | GFSK       | 1M        | 9.51            | 10           |
| 2480      | GFSK       | 1M        | 9.34            | 10           |



### Appendix D. SAR Measurement Data

| Plot.No | Band  | Mode | Channel | Frequency (MHz) | Data Rate | Test Position | Gap (mm) | Avg Power (dBm) | Tune-up (dBm) | SAR 1g (W/Kg) | Reported SAR 1 g (W/Kg) |
|---------|-------|------|---------|-----------------|-----------|---------------|----------|-----------------|---------------|---------------|-------------------------|
| 1       | BT-LE | GFSK | 0       | 2402            | 1M        | Front         | 0        | 9.55            | 10            | 0.246         | 0.27                    |
| 2       | BT-LE | GFSK | 0       | 2402            | 1M        | Back          | 0        | 9.55            | 10            | 0.274         | 0.30                    |
| 3       | BT-LE | GFSK | 0       | 2402            | 1M        | Left Side     | 0        | 9.55            | 10            | 0.0681        | 0.08                    |
| 4       | BT-LE | GFSK | 0       | 2402            | 1M        | Right Side    | 0        | 9.55            | 10            | 0.144         | 0.16                    |
| 5       | BT-LE | GFSK | 0       | 2402            | 1M        | Top Side      | 0        | 9.55            | 10            | 0.049         | 0.05                    |
| 6       | BT-LE | GFSK | 0       | 2402            | 1M        | Bottom Sode   | 0        | 9.55            | 10            | 0.0335        | 0.04                    |
| 7       | BT-LE | GFSK | 19      | 2440            | 1M        | Back          | 0        | 9.51            | 10            | 0.261         | 0.29                    |
| 8       | BT-LE | GFSK | 39      | 2480            | 1M        | Back          | 0        | 9.34            | 10            | 0.267         | 0.31                    |



### 08 BT-LE GFSK CH39\_1M\_Back\_0mm

Communication System: BT-LE; Frequency: 2480 MHz; Duty Cycle: 1:1

Medium parameters used:  $f = 2480$  MHz;  $\sigma = 1.884$  S/m;  $\epsilon_r = 40.61$ ;  $\rho = 1000$  kg/m<sup>3</sup>

Phantom section: Flat Section

DASY5 Configuration:

- Probe: EX3DV4 - SN3927; ConvF(7.75, 7.75, 7.75) @ 2480 MHz; Calibrated: 2021/7/28
- Sensor-Surface: 1.4mm (Mechanical Surface Detection)
- Electronics: DAE4 Sn1379; Calibrated: 2021/7/19
- Phantom: ELI v5.0 (20deg probe tilt); Type: QDOVA002AA; Serial: TP:xxxx
- Measurement SW: DASY52, Version 52.10 (4); SEMCAD X Version 14.6.14 (7483)

**Area Scan (51x81x1):** Interpolated grid: dx=1.200 mm, dy=1.200 mm

Maximum value of SAR (interpolated) = 0.540 W/kg

**Zoom Scan (7x7x7)/Cube 0:** Measurement grid: dx=5mm, dy=5mm, dz=5mm

Reference Value = 12.29 V/m; Power Drift = -0.05 dB

Peak SAR (extrapolated) = 0.586 W/kg

**SAR(1 g) = 0.267 W/kg; SAR(10 g) = 0.118 W/kg**

Smallest distance from peaks to all points 3 dB below = 8 mm

Ratio of SAR at M2 to SAR at M1 = 47%

Maximum value of SAR (measured) = 0.454 W/kg

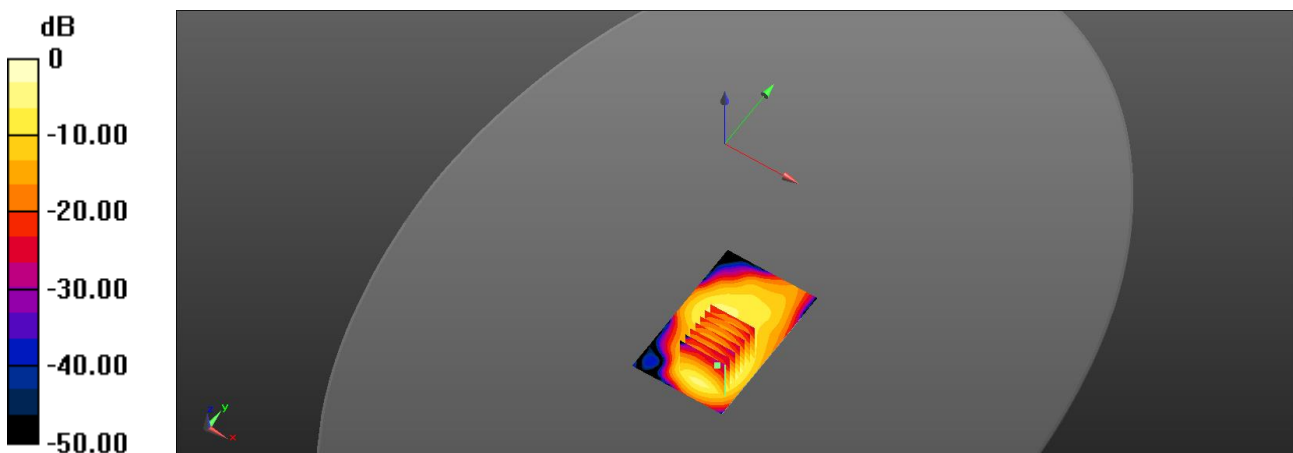

0 dB = 0.454 W/kg = -3.43 dBW/kg