



FCC RADIO TEST REPORT

Applicant : Ubiquiti Inc.
Address : 685 Third Avenue, New York, New York 10017, USA
Equipment : UISP Wave LR
Model No. : Wave-LR
Trade Name : UBIQUITI
FCC ID : SWX-WAVELR

I HEREBY CERTIFY THAT :

The sample was received on May. 09, 2022 and the testing was completed on May. 16, 2022 at CerpPASS Technology Corp. The test result refers exclusively to the test presented test model / sample. Without written approval of CerpPASS Technology Corp., the test report shall not be reproduced except in full.

Approved by:

Mark Liao / Supervisor

Laboratory Accreditation:

CerpPASS Technology Corporation Test Laboratory





CONTENTS

- 1. Summary of Test Procedure and Test Results 5
 - 1.1. Applicable Standards 5
- 2. Test Configuration of Equipment under Test 6
 - 2.1. Feature of Equipment under Test..... 6
 - 2.2. Carrier Frequency of Channels 6
 - 2.3. Test Mode and Test Software 7
 - 2.4. Description of Test System..... 8
 - 2.5. General Information of Test..... 9
 - 2.6. Measurement Uncertainty 9
- 3. Test Equipment and Ancillaries Used for Tests 10
- 4. Antenna Requirements 12
 - 4.1. Standard Applicable 12
 - 4.2. Antenna Construction and Directional Gain..... 12
- 5. Test of AC Power Line Conducted Emission 13
 - 5.1. Test Limit 13
 - 5.2. Test Procedures 13
 - 5.3. Typical Test Setup 14
 - 5.4. Test Result and Data 15
 - 5.5. Test Photographs 17
- 6. Test of Spurious Emission (Radiated) 18
 - 6.1. Test Limit 18
 - 6.2. Test Procedures 19
 - 6.3. Typical Test Setup 20
 - 6.4. Test Result and Data (9kHz ~ 30MHz)..... 21
 - 6.5. Test Result and Data (30MHz ~ 1GHz)..... 21
 - 6.6. Test Result and Data (1GHz ~ 40GHz)..... 23
 - 6.7. Restricted Bands of Operation 29
 - 6.8. Test Photographs (30MHz ~ 1GHz) 30
 - 6.9. Test Photographs (1GHz ~ 40GHz) 31
- 7. On Time, Duty Cycle and Measurement methods 33
 - 7.1. Test Limit 33
 - 7.2. Test Procedure 33
 - 7.3. Test Setup Layout 33
 - 7.4. Test Result and Data 33
 - 7.5. Measurement Methods 33
- 8. 6dB Bandwidth & 99% Occupied Bandwidth 35
 - 8.1. Test Limit 35
 - 8.2. Test Procedure 35
 - 8.3. Test Setup Layout 35
 - 8.4. Test Result and Data 36
- 9. Average Power..... 39
 - 9.1. Test Limit 39



- 9.2. Test Procedure 40
- 9.3. Test Setup Layout 40
- 9.4. Test Result and Data 41
- 10. Power Spectral Density 42
 - 10.1. Test Limit 42
 - 10.2. Test Procedure 42
 - 10.3. Test Setup Layout 42
 - 10.4. Test Result and Data 42
- 11. Radio Frequency Exposure 44
 - 11.1. Applicable Standards 44
 - 11.2. EUT Specification 44
 - 11.3. Test Results 44
 - 11.4. Calculation 45
 - 11.5. Maximum Permissible Exposure 46



History of this test report

Report No.	Issued Date	Description
22050039-TRFCC01	May. 17, 2022	Original



1. Summary of Test Procedure and Test Results

1.1. Applicable Standards

ANSI C63.10:2013

FCC Rules and Regulations Part 15 Subpart E §15.407

KDB 789033

FCC Rule	Description of Test	Result
15.203	Antenna Requirement	PASS
15.207(a)	AC Power Line Conducted Emission	PASS
15.407(b) 15.209	Radiated Spurious Emission	PASS
15.407(a)	26 dB & Occupied Bandwidth	PASS
15.407	6 dB Bandwidth	PASS
15.407 (a) & (a)(3)	Average Power	PASS
15.407(a)	Power Spectral Density	PASS
2.1091	Radio Frequency Exposure	PASS

*The lab has reduced the uncertainty risk factor from test equipment, environment and staff technicians which according to the standard on contract. Therefore, the test result will only be determined by standard requirement.



2. Test Configuration of Equipment under Test

2.1. Feature of Equipment under Test

Operation Frequency Range	5725-5850MHz
Center Frequency Range	5740-5835MHz
Modulation Type	BPSK, QPSK, 16QAM, 64QAM, 256QAM, 1024QAM
Data Rate	MCS0 – MCS11,HE20
Antenna Type	Internal Antenna
Antenna Gain	5725-5850MHz: ANT A:22dBi , ANT B:22dBi
PoE Adaptor	Brand: UBIQUITI Model: GP-H480-065G
Power Cord	Brand: UBIQUITI Model: N/A

Note:

1. EUT support TPC Function.
2. For more details, please refer to the User's manual of the EUT.

2.2. Carrier Frequency of Channels

Band: 5725MHz -5850MHz

Frequency(MHz)
*5740
*5790
*5835

Note: Remarked * are selected to perform test.



2.3. Test Mode and Test Software

- a. During testing, the interface cables and equipment positions were varied according to ANSI C63.10.
- b. The complete test system included remote workstation and EUT for RF test. The remote workstation included Notebook.
- c. An executive program, " qcatetestcmd command" under Windows OS system was executed to transmit and receive data via WLAN.
- d. The following test modes were performed for the test:

Conducted Emissions from the AC mains power ports	
Test Mode	Operating Description
1	Normal Mode
caused "Test Mode 1" generated the worst case, it was reported as the final data.	
Radiation Emissions (9KHz ~30MHz & 30MHz ~ 1GHz)	
Test Mode	Operating Description
1	Normal Mode
caused "Test Mode 1" generated the worst case, it was reported as the final data.	
Radiation Emissions (1GHz ~ 40GHz)	
Test Mode	Operating Description
1	Transmitter Mode
caused "Test Mode 1" generated the worst case, it was reported as the final data.	

Note:

- 1. There are two kinds of test voltage: AC 120V / 60Hz and AC 240V / 60Hz.
 For AC Power Line Conducted Emission, AC 240V / 60Hz is worst case.
 For Radiated Spurious Emission(9KHz ~30MHz & 30MHz ~ 1GHz), AC 120V / 60Hz is worst case.

The EUT incorporates a MIMO function

TX CONFIGURATION
2TX



2.4. Description of Test System

RF Conducted				
Equipment	Brand	Model	Length/Type	Power cord/Length/Type
Notebook	Lenovo	S1GL2W	N/A	Adapter / 1.8m / NS
Power Cord	UBIQUITI	N/A	0.6m / NS	N/A
RJ45 Cable*2	TE CONNECTIVITY	CAT5E	1.2m / NS	N/A
Radiated Emissions				
Equipment	Brand	Model	Length/Type	Power cord/Length/Type
Notebook	ASUS	P2430U	N/A	Adapter / 1.8m / NS
Power Cord	UBIQUITI	N/A	0.6m / NS	N/A
RJ45 Cable	TE CONNECTIVITY	CAT5E	1.2m / NS	N/A
RJ45 Cable	TE CONNECTIVITY	CAT5E	15m / NS	N/A
AC Power Line Conducted Emission				
Equipment	Brand	Model	Length/Type	Power cord/Length/Type
Notebook	ASUS	P2430U	N/A	Adapter / 1.8m / NS
Power Cord	UBIQUITI	N/A	0.6m / NS	N/A
RJ45 Cable*2	TE CONNECTIVITY	CAT5E	1.2m / NS	N/A



2.5. General Information of Test

Test Site	Cerpass Technology Corporation Test Laboratory Address: No.10, Ln. 2, Lianfu St., Luzhu Dist., Taoyuan City 33848, Taiwan (R.O.C.) Tel:+886-3-3226-888 Fax:+886-3-3226-881	
	FCC	TW1439, TW1079
	IC	4934E-1, 4934E-2
	VCCI	T-2205 for Telecommunication test C-4663 for Conducted emission test R-4218 for Radiated emission test G-10812, G-10813 for radiated disturbance above 1GHz
Frequency Range Investigated:	Conducted: from 150kHz to 30 MHz Radiation: from 30 MHz to 40,000MHz	
Test Distance:	The test distance of radiated emission from antenna to EUT is 3 M.	

Test Item	Test Site	Test period	Environmental Conditions	Tested By
RF Conducted	RFCON01-NK	2022/05/12~2022/05/16	23.5~26.3°C / 50~53%	Dian Chen
Radiated Emissions	3M02-NK	2022/05/12~2022/05/13	22~27°C / 42~44%	Dian Chen
AC Power Line Conducted Emission	CON01-NK	2022/05/06	22°C / 51%	Dian Chen

2.6. Measurement Uncertainty

ISO/IEC 17025 requires that an estimate of the measurement uncertainties associated with the emissions test results be included in the report. The measurement uncertainties given below are based on a 95% confidence level (based on a coverage factor (k=2))

Measurement Item	Uncertainty
AC Power Line Conduction(150K~30MHz)	±3.12dB
Radiated Spurious Emission(9KHz~30MHz)	±3.4dB
Radiated Spurious Emission(30MHz~1GHz)	±5.7dB
Radiated Spurious Emission(1GHz~40GHz)	±6.8dB
6dB Bandwidth	±4.4%
26dB Bandwidth	±4.4%
Occupied Bandwidth	±4.4%
Peak Output Power(Conducted Power Meter)	±1.1dB
Power Spectral Density	±1.8dB
Duty Cycle	±1.2%
Frequency Stability	±0.21KHz



3. Test Equipment and Ancillaries Used for Tests

Test Item	Radiated Emissions				
Test Site	Semi Anechoic Room(3M02-NK)				
Instrument	Manufacturer	Model No	Serial No	Calibration Date	Valid Date
Bilog Antenna	Schwarzbeck	VULB9168	275	2021/11/05	2022/11/04
Active Loop Antenna	EMCO	6507	40855	2021/06/10	2022/06/09
Horn Antenna	EMCO	3115	31601	2021/10/14	2022/10/13
Horn Anrenna	EMCO	3116	31974	2021/10/04	2022/10/03
EMI Receiver	ROHDE & SCHWARZ	ESCI	101423	2021/06/30	2022/06/29
Spectrum Analyzer	ROHDE & SCHWARZ	FSV 40-N	102151	2021/08/06	2022/08/05
Preamplifier	Agilent	8449B	3008A01954	2022/03/17	2023/03/16
Preamplifier	EM Electronics corp.	EM330	60658	2021/10/13	2022/10/12
Cable-6m(9k~300M)	NA	EMC5D-BM-BM-6	130605	2021/09/22	2022/09/21
Cable-3in1(30M-1G)	HARBOUR INDUSTRIES	LL142	CCE1315	2022/03/21	2023/03/20
Cable-3in1(30M-1G)	HARBOUR INDUSTRIES	LL142	CCE1316	2022/01/11	2023/01/10
Cable-0.5m(1G-40G)	HUBER SUHNER	SUCOFLEX 102	MY4569/2	2021/09/03	2022/09/02
Cable-1m(1G-40G)	HUBER SUHNER	SUCOFLEX 102	MY5739/2	2021/09/03	2022/09/02
Cable-6m(1G-40G)	HUBER SUHNER	SUCOFLEX 102	MY5740/2	2021/09/03	2022/09/02
Cable-0.5m(1G-40G)	HUBER SUHNER	SUCOFLEX 104	805443/4	2022/01/11	2023/01/10
Cable-3m(1G-40G)	HUBER SUHNER	SUCOFLEX 104	805796/4	2022/01/11	2023/01/10
Cable-3m(1G-26.5G)	WOKEN	WCBA-WCA203SM	CCE1374	2022/04/25	2023/04/24
E3	AUDIX	v8.2014-8-6	RK-000529	NA	NA

Test Item	RF Conducted				
Test Site	RFCON01-NK				
Instrument	Manufacturer	Model No	Serial No	Calibration Date	Valid Date
Spectrum Analyzer	ROHDE & SCHWARZ	FSP 40	100047	2022/03/04	2023/03/03
Attenuator	KEYSIGHT	8491B	MY39250703	2022/04/12	2023/04/11
Cable-0.5m(1G-26.5G)	HUBER SUHNER	SUCOFLEX 102	28422/2	2022/04/09	2023/04/08
Power Meter	Anritsu	ML2495A	1224005	2022/04/12	2023/04/11
Power Sensor	Anritsu	MA2411B	1207295	2022/04/12	2023/04/11
Switch Box	Theda	1-4	TW5451159	NA	NA



Test Item	AC Power Line Conducted Emission				
Test Site	CON01-NK				
Instrument	Manufacturer	Model No	Serial No	Calibration Date	Valid Date
EMI Receiver	ROHDE & SCHWARZ	ESCI	101200	2021/08/30	2022/08/29
Line Impedance Stabilization Network	Schwarzbeck	NSLK 8127	8127-516	2021/10/05	2022/10/04
Pulse Limiter	ROHDE & SCHWARZ	ESH3-Z2	101933	2021/09/15	2022/09/14
Cable-6m(9k~300M)	NA	EMC5D-BM-BM-6	130605	2021/09/22	2022/09/21
E3	AUDIX	v8.2014-8-6	RK-000531	NA	NA



4. Antenna Requirements

4.1. Standard Applicable

For intentional device, according to FCC 47 CFR Section 15.203, an intentional radiator shall be designed to ensure that no antenna other than that furnished by the responsible party shall be used with the device.

And according to FCC 47 CFR Section 15.407 (a), if transmitting antennas of directional gain greater than 6dBi are used, the power shall be reduced by the amount in dB that the directional gain of the antenna exceeds 6dBi.

4.2. Antenna Construction and Directional Gain

Antenna Type	Internal Antenna
Antenna Gain	5725-5850MHz: ANT A:22dBi , ANT B:22dBi

5725MHz -5850MHz

For Power directional gain= G_{ant} = 22.00 dBi

For PSD directional gain = $10 \log[(10^{G^1/20} + 10^{G^2/20} + \dots + 10^{G^N/20})^2 / NANT]$
= 25.01 (dBi)

*MIMO type: Cyclic Delay Diversity (CDD) mode.



5. Test of AC Power Line Conducted Emission

5.1. Test Limit

Conducted Emissions were measured from 150 kHz to 30 MHz with a bandwidth of 9 KHz, according to the methods defined in ANSI C63.10-2013. The EUT was placed on a nonmetallic stand in a shielded room 0.8 meters above the ground plane. The interface cables and equipment positioning were varied within limits of reasonable applications to determine the position produced maximum conducted emissions.

Frequency (MHz)	Quasi Peak (dB μ V)	Average (dB μ V)
0.15 – 0.5	66-56*	56-46*
0.5 – 5.0	56	46
5.0 – 30.0	60	50

*Decreases with the logarithm of the frequency.

5.2. Test Procedures

- The EUT was placed 0.4 meter from the conducting wall of the shielding room was kept at least 80 centimeters from any other grounded conducting surface.
- Connect EUT to the power mains through a line impedance stabilization network (LISN).
- All the support units are connecting to the other LISN.
- The LISN provides 50 ohm coupling impedance for the measuring instrument.
- The FCC states that a 50 ohm, 50 micro-Henry LISN should be used.
- Both sides of AC line were checked for maximum conducted interference.
- The frequency range from 150 kHz to 30 MHz was searched.
- Set the test-receiver system to Peak Detect Function and Specified Bandwidth with Maximum Hold Mode.



5.3. Typical Test Setup

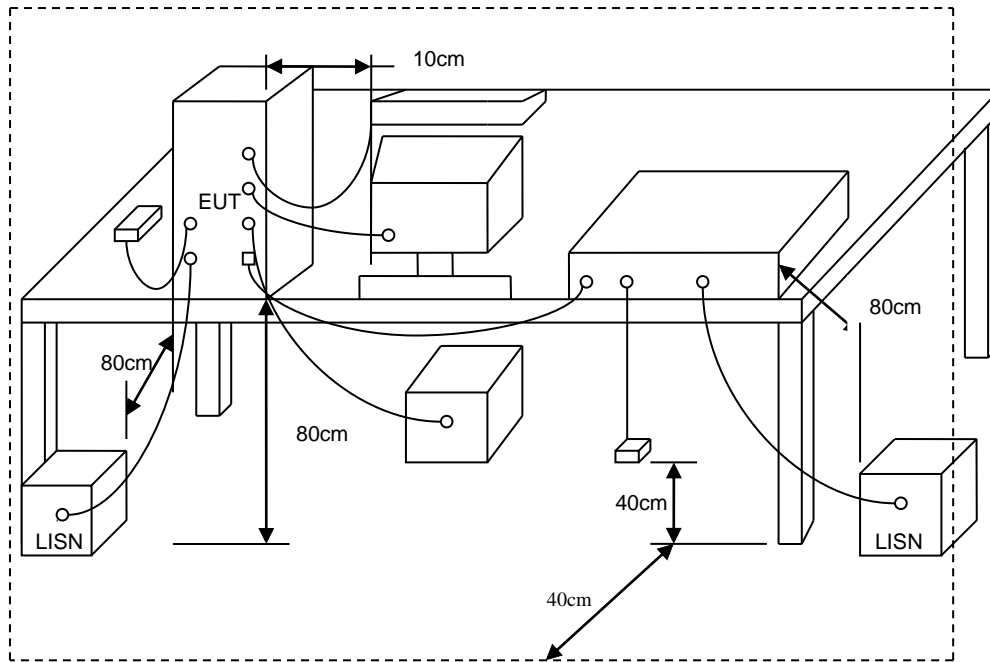



5.4. Test Result and Data

Power	: DC 48V From Adapter (AC 240V / 60Hz)	Pol/Phase	: LINE
Test Mode	: Mode 1		

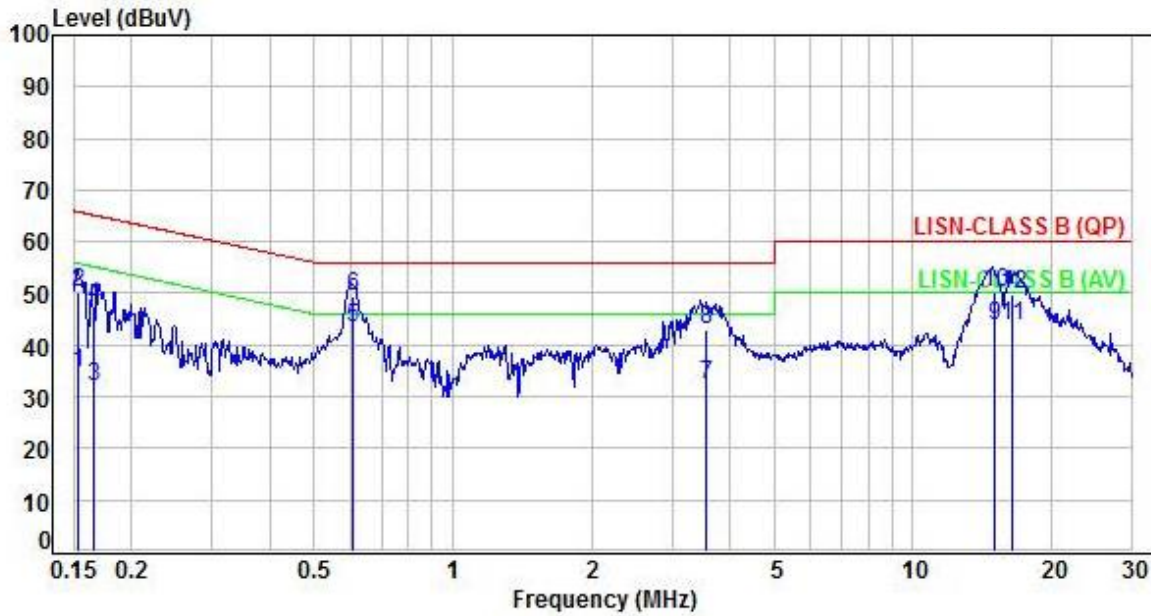

No.	Frequency (MHz)	Factor (dB)	Reading (dBuV)	Level (dBuV)	Limit (dBuV)	Margin (dB)	Detector	P/F
1	0.15	9.96	24.81	34.77	55.85	-21.08	Average	P
2	0.15	9.96	40.29	50.25	65.85	-15.60	QP	P
3	0.17	9.96	21.95	31.91	55.13	-23.22	Average	P
4	0.17	9.96	37.62	47.58	65.13	-17.55	QP	P
5	0.61	9.97	33.24	43.21	46.00	-2.79	Average	P
6	0.61	9.97	39.60	49.57	56.00	-6.43	QP	P
7	3.55	10.20	22.14	32.34	46.00	-13.66	Average	P
8	3.55	10.20	32.77	42.97	56.00	-13.03	QP	P
9	15.05	10.61	33.22	43.83	50.00	-6.17	Average	P
10	15.05	10.61	39.56	50.17	60.00	-9.83	QP	P
11	16.46	10.65	33.26	43.91	50.00	-6.09	Average	P
12	16.46	10.65	39.10	49.75	60.00	-10.25	QP	P

Note: Level=Reading+Factor
 Margin=Level-Limit
 Factor=(LISN or ISN or Current Probe)Factor + Cable Loss



Power	: DC 48V From Adapter (AC 240V / 60Hz)	Pol/Phase	: NEUTRAL
Test Mode	: Mode 1		

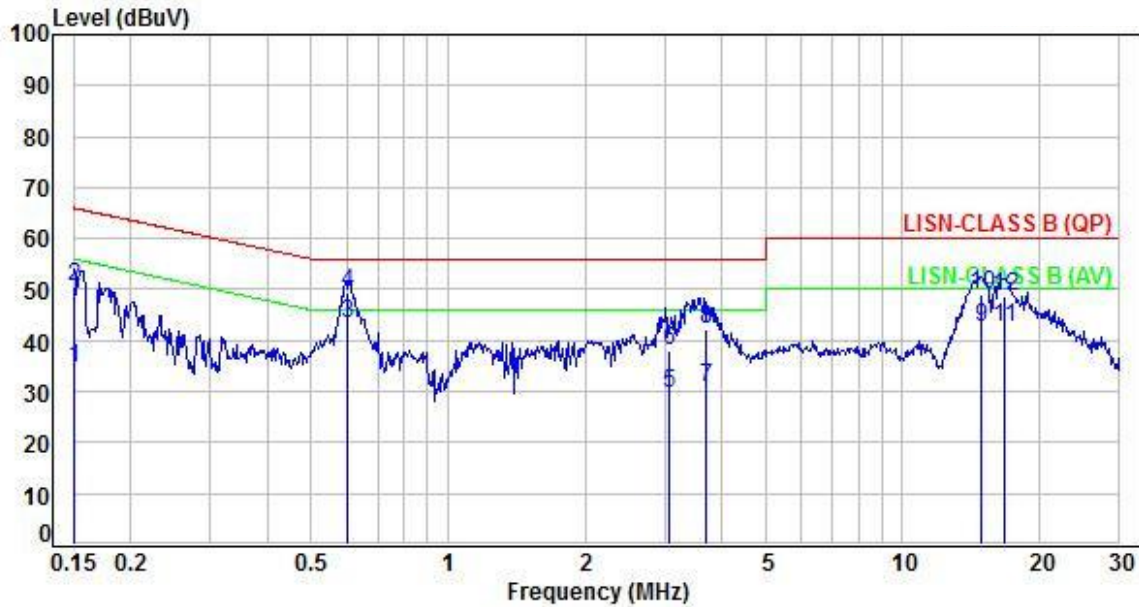

No.	Frequency (MHz)	Factor (dB)	Reading (dBuV)	Level (dBuV)	Limit (dBuV)	Margin (dB)	Detector	P/F
1	0.15	9.94	24.70	34.64	55.98	-21.34	Average	P
2	0.15	9.94	40.65	50.59	65.98	-15.39	QP	P
3	0.60	9.94	33.35	43.29	46.00	-2.71	Average	P
4	0.60	9.94	39.49	49.43	56.00	-6.57	QP	P
5	3.08	10.10	19.43	29.53	46.00	-16.47	Average	P
6	3.08	10.10	28.03	38.13	56.00	-17.87	QP	P
7	3.68	10.12	20.59	30.71	46.00	-15.29	Average	P
8	3.68	10.12	31.93	42.05	56.00	-13.95	QP	P
9	14.92	10.50	32.11	42.61	50.00	-7.39	Average	P
10	14.92	10.50	38.36	48.86	60.00	-11.14	QP	P
11	16.76	10.54	32.06	42.60	50.00	-7.40	Average	P
12	16.76	10.54	37.95	48.49	60.00	-11.51	QP	P

Note: Level=Reading+Factor
 Margin=Level-Limit
 Factor=(LISN or ISN or Current Probe)Factor + Cable Loss



6. Test of Spurious Emission (Radiated)

6.1. Test Limit

Undesirable emission limits. Except as shown in paragraph (b)(7) of this section, the maximum emissions outside of the frequency bands of operation shall be attenuated in accordance with the following limits:

- (1) For transmitters operating in the 5.15-5.25 GHz band: All emissions outside of the 5.15-5.35 GHz band shall not exceed an e.i.r.p. of -27 dBm/MHz.
- (2) For transmitters operating in the 5.25-5.35 GHz band: All emissions outside of the 5.15-5.35 GHz band shall not exceed an e.i.r.p. of -27 dBm/MHz.
- (3) For transmitters operating in the 5.47-5.725 GHz band: All emissions outside of the 5.47-5.725 GHz band shall not exceed an e.i.r.p. of -27 dBm/MHz.
- (4) For transmitters operating in the 5.725-5.85 GHz band:
All emissions shall be limited to a level of -27 dBm/MHz at 75 MHz or more above or below the band edge increasing linearly to 10 dBm/MHz at 25 MHz above or below the band edge, and from 25MHz above or below the band edge increasing linearly to a level of 15.6 dBm/MHz at 5 MHz above or below the band edge, and from 5 MHz above or below the band edge increasing linearly to a level of 27dBm/MHz at the band edge.
- (5) The emission measurements shall be performed using a minimum resolution bandwidth of 1 MHz. A lower resolution bandwidth may be employed near the band edge, when necessary, provided the measured energy is integrated to show the total power over 1 MHz.
- (6) Unwanted emissions below 1 GHz must comply with the general field strength limits set forth in §15.209. Further, any U-NII devices using an AC power line are required to comply also with the conducted limits set forth in §15.207.
- (7) The provisions of §15.205 apply to intentional radiators operating under this section.
- (8) When measuring the emission limits, the nominal carrier frequency shall be adjusted as close to the upper and lower frequency band edges as the design of the equipment permits.



6.2. Test Procedures

- a. The EUT was placed on a rotatable table top 0.8 meter above ground.
- b. The EUT was set 3 meters from the interference receiving antenna which was mounted on the top of a variable height antenna tower.
- c. The table was rotated 360 degrees to determine the position of the highest radiation.
- d. The antenna is a broadband antenna and its height is varied between one meter and four meters above ground to find the maximum value of the field strength both horizontal polarization and vertical polarization of the antenna are set to make the measurement.
- e. For each suspected emission the EUT was arranged to its worst case and then tune the antenna tower (from 1 M to 4 M) and turn table (from 0 degree to 360 degrees) to find the maximum reading.
- f. Set the test-receiver system to Peak or CISPR quasi-peak Detect Function and specified bandwidth with Maximum Hold Mode.
- g. If the emission level of the EUT in peak mode was 3 dB lower than the limit specified, then testing will be stopped and peak values of EUT will be reported, otherwise, the emissions which do not have 3 dB margin will be repeated one by one using the quasi-peak method and reported.
- h. For testing above 1GHz, the emission level of the EUT in peak mode was 20dB lower than average limit (that means the emission level in peak mode also complies with the limit in average mode), then testing will be stopped and peak values of EUT will be reported, otherwise, the emissions will be measured in average mode again and reported.
- i. "Cone of radiation" has been considered to be 3dB bandwidth of the measurement antenna.

Note:

1. The supporting fixture shall permit orientation of the EUT in each of three orthogonal axis positions such that emissions from the EUT are maximized.
(Y-AXIS is the worst.)



6.3. Typical Test Setup

Below 30MHz test setup

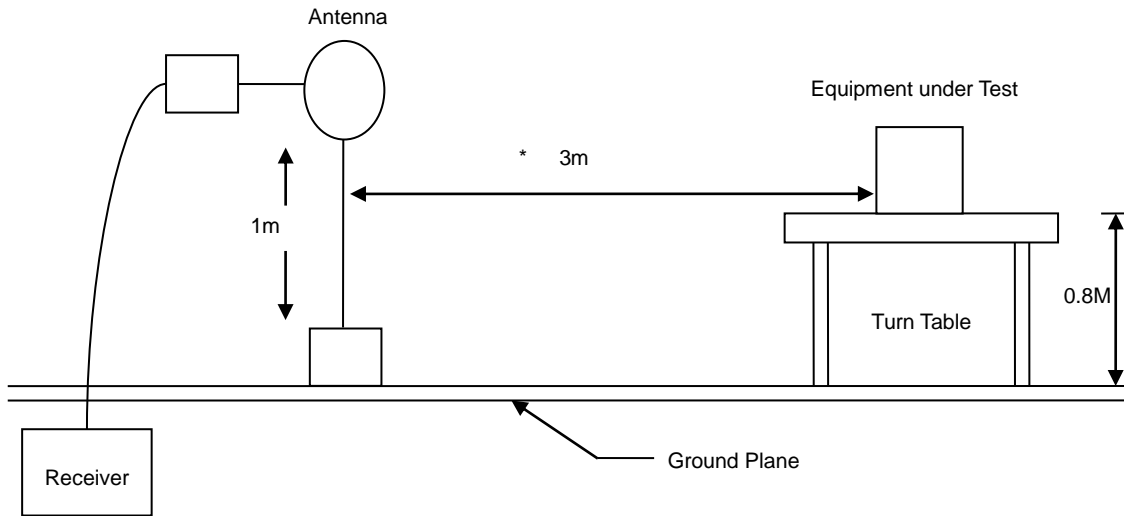

30MHz- 1GHz Test Setup

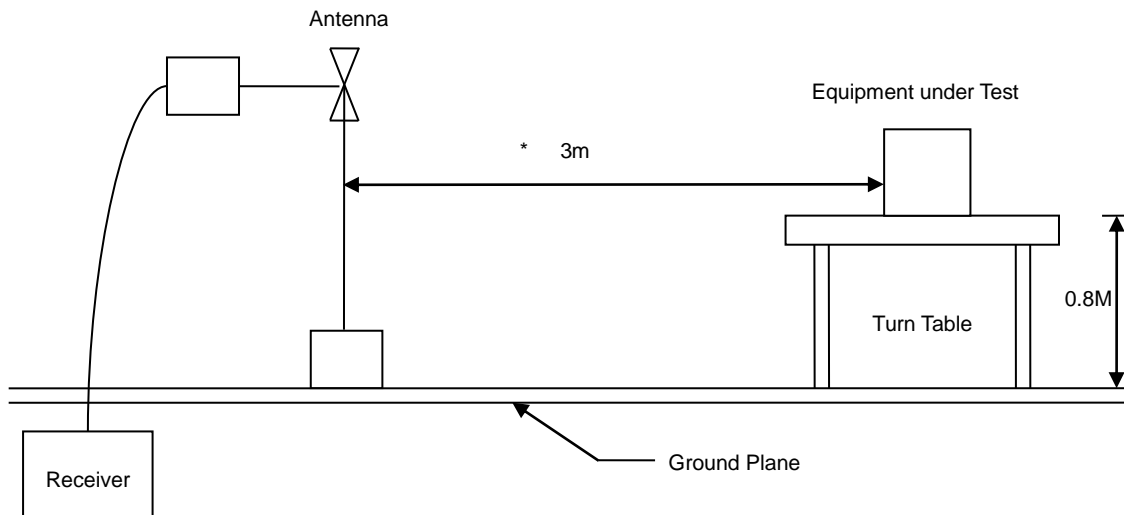

Above 1GHz Test Setup

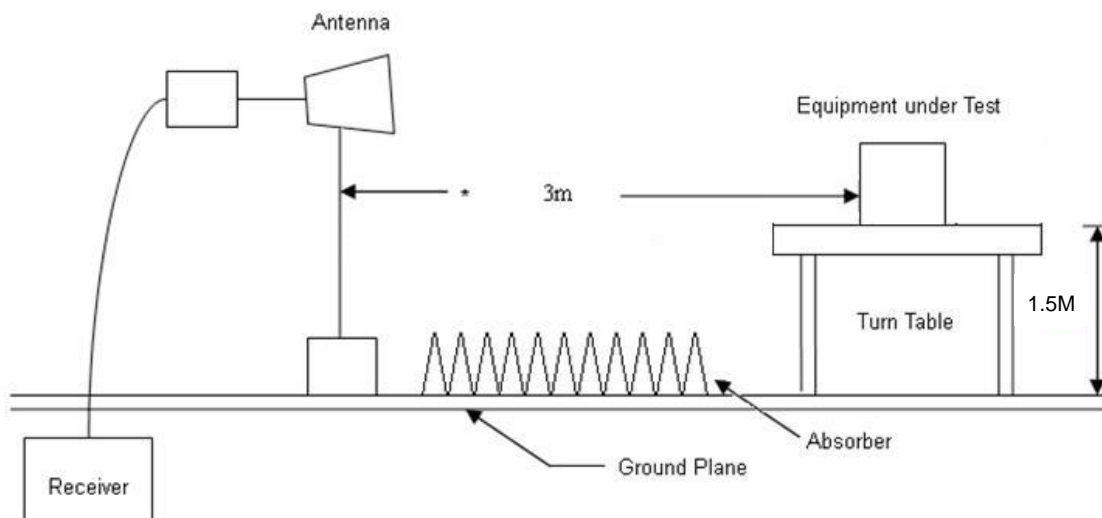



6.4. Test Result and Data (9kHz ~ 30MHz)

The 9kHz - 30MHz spurious emission is under limit 20dB more.

6.5. Test Result and Data (30MHz ~ 1GHz)

Power	: DC 48V From Adapter (AC 120V / 60Hz)	Pol/Phase	: VERTICAL
Test Mode	: Mode 1		:

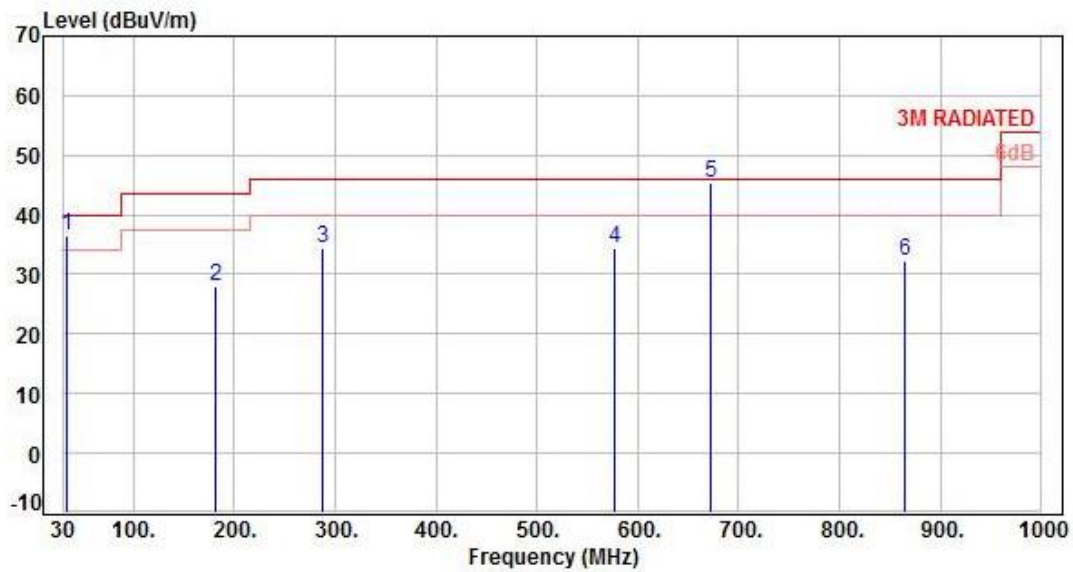

No.	Frequency (MHz)	Factor (dB)	Reading (dBuV)	Level (dBuV/m)	Limit (dBuV/m)	Margin (dB)	Detector	Height (cm)	Azimuth (deg)	P/F
1	33.88	-12.42	48.86	36.44	40.00	-3.56	Peak	400	360	P
2	181.32	-12.98	40.87	27.89	43.50	-15.61	Peak	400	360	P
3	288.02	-10.44	44.96	34.52	46.00	-11.48	Peak	400	360	P
4	577.08	-3.29	37.63	34.34	46.00	-11.66	Peak	400	360	P
5	672.14	-1.70	47.15	45.45	46.00	-0.55	QP	150	171	P
6	864.20	1.10	31.21	32.31	46.00	-13.69	Peak	400	360	P

Note: Level=Reading+Factor
Margin=Level-Limit
Factor=Antenna Factor + cable loss - Amplifier Factor



Power	: DC 48V From Adapter (AC 120V / 60Hz)	Pol/Phase	: HORIZONTAL
Test Mode	: Mode 1		:

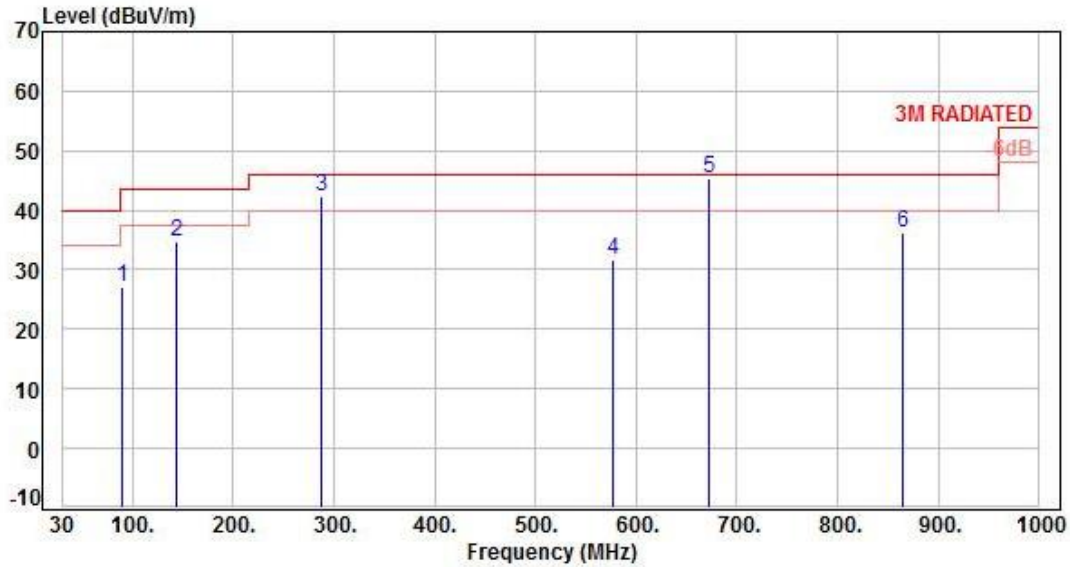

No.	Frequency (MHz)	Factor (dB)	Reading (dBuV)	Level (dBuV/m)	Limit (dBuV/m)	Margin (dB)	Detector	Height (cm)	Azimuth (deg)	P/F
1	90.14	-16.74	43.79	27.05	43.50	-16.45	Peak	400	360	P
2	144.46	-11.73	46.30	34.57	43.50	-8.93	Peak	400	360	P
3	288.02	-10.44	52.66	42.22	46.00	-3.78	Peak	400	360	P
4	577.08	-3.29	34.88	31.59	46.00	-14.41	Peak	400	360	P
5	672.14	-1.70	47.12	45.42	46.00	-0.58	QP	115	230	P
6	864.20	1.10	35.29	36.39	46.00	-9.61	Peak	400	360	P

Note: Level=Reading+Factor
 Margin=Level-Limit
 Factor=Antenna Factor + cable loss - Amplifier Factor



6.6. Test Result and Data (1GHz ~ 40GHz)

Power	:	DC 48V From Adapter (AC 120V / 60Hz)	Pol/Phase	:	VERTICAL
Test Mode	:	Mode 1, 5740MHz		:	

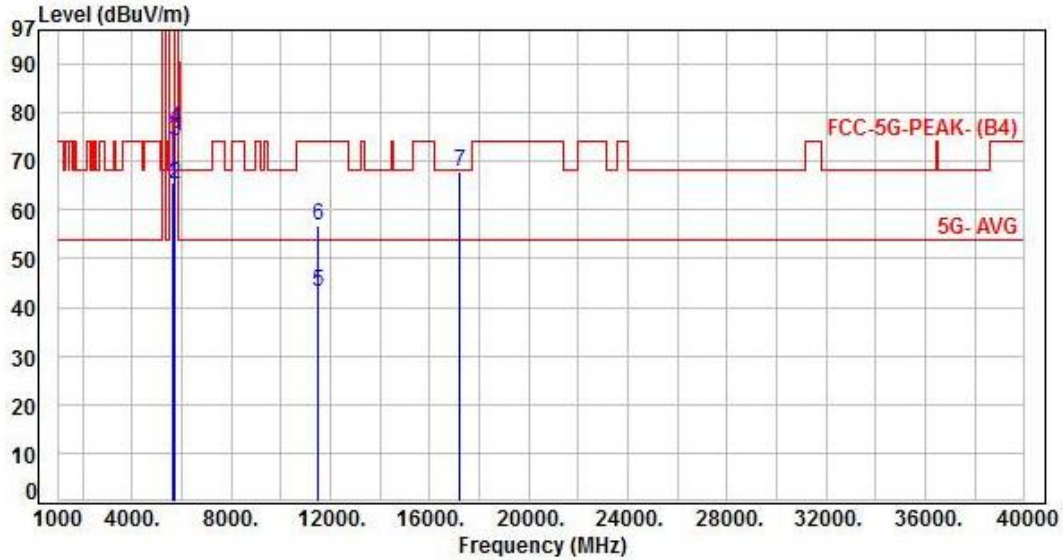

No.	Frequency (MHz)	Factor (dB)	Reading (dBuV)	Level (dBuV/m)	Limit (dBuV/m)	Margin (dB)	Detector	Height (cm)	Azimuth (deg)	P/F
1	5650.00	6.52	59.01	65.53	68.20	-2.67	Peak	100	10	P
2	5700.00	6.56	58.67	65.23	105.20	-39.97	Peak	100	10	P
3	5720.00	6.61	67.58	74.19	110.80	-36.61	Peak	100	10	P
4	5725.00	6.63	69.93	76.56	122.20	-45.64	Peak	100	10	P
5	11480.00	15.06	27.99	43.05	54.00	-10.95	Average	188	222	P
6	11480.00	15.06	41.79	56.85	74.00	-17.15	Peak	188	222	P
7	17220.00	20.86	47.12	67.98	68.20	-0.22	Peak	100	162	P

Note: Level=Reading+Factor
Margin=Level-Limit
Factor=Antenna Factor + cable loss - Amplifier Factor



Power	: DC 48V From Adapter (AC 120V / 60Hz)	Pol/Phase	: HORIZONTAL
Test Mode	: Mode 1, 5740MHz		:

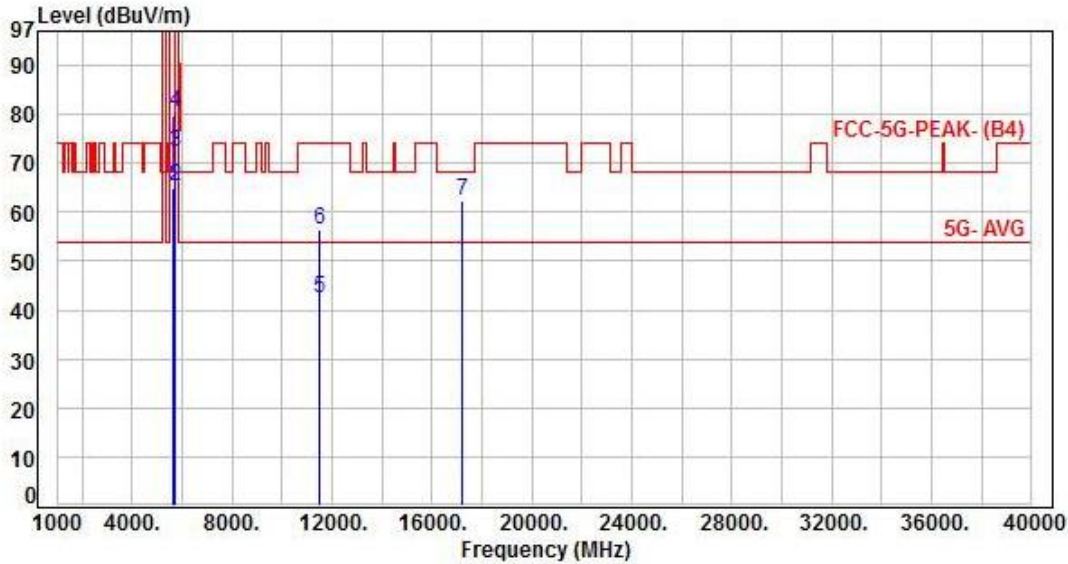

No.	Frequency (MHz)	Factor (dB)	Reading (dBuV)	Level (dBuV/m)	Limit (dBuV/m)	Margin (dB)	Detector	Height (cm)	Azimuth (deg)	P/F
1	5650.00	6.52	58.25	64.77	68.20	-3.43	Peak	228	7	P
2	5700.00	6.56	58.86	65.42	105.20	-39.78	Peak	228	7	P
3	5720.00	6.61	65.63	72.24	110.80	-38.56	Peak	228	7	P
4	5725.00	6.63	73.74	80.37	122.20	-41.83	Peak	228	7	P
5	11480.00	15.06	27.48	42.54	54.00	-11.46	Average	100	231	P
6	11480.00	15.06	41.27	56.33	74.00	-17.67	Peak	100	231	P
7	17220.00	20.86	41.61	62.47	68.20	-5.73	Peak	300	156	P

Note: Level=Reading+Factor
 Margin=Level-Limit
 Factor=Antenna Factor + cable loss - Amplifier Factor



Power	: DC 48V From Adapter (AC 120V / 60Hz)	Pol/Phase	: VERTICAL
Test Mode	: Mode 1, 5790MHz		:

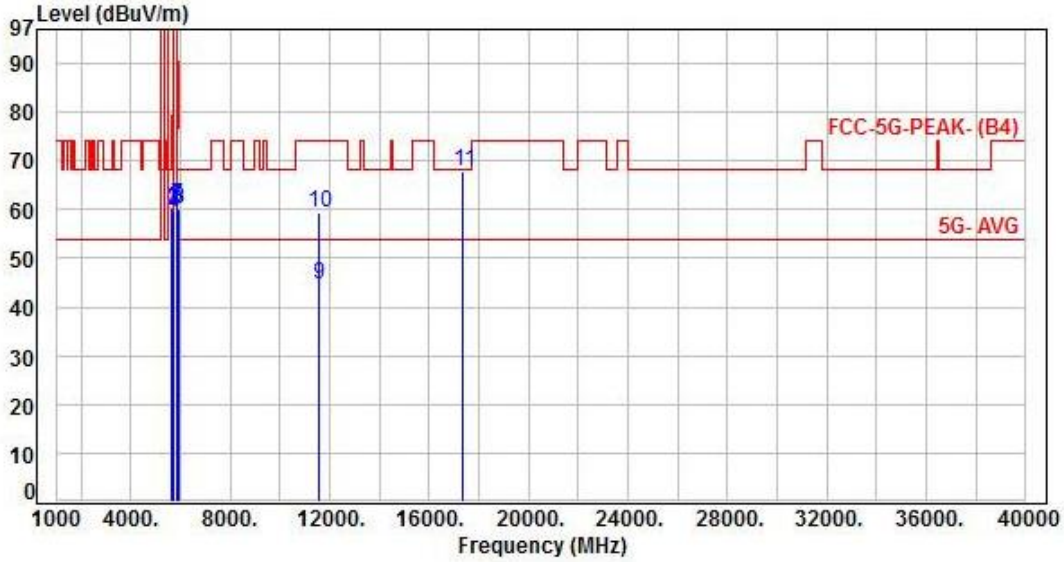

No.	Frequency (MHz)	Factor (dB)	Reading (dBuV)	Level (dBuV/m)	Limit (dBuV/m)	Margin (dB)	Detector	Height (cm)	Azimuth (deg)	P/F
1	5650.00	6.33	54.00	60.33	68.20	-7.87	Peak	100	10	P
2	5700.00	6.37	53.40	59.77	105.20	-45.43	Peak	100	10	P
3	5720.00	6.42	53.17	59.59	110.80	-51.21	Peak	100	10	P
4	5725.00	6.44	52.98	59.42	122.20	-62.78	Peak	100	10	P
5	5850.00	6.58	53.78	60.36	122.20	-61.84	Peak	100	10	P
6	5855.00	6.60	53.84	60.44	110.80	-50.36	Peak	100	10	P
7	5875.00	6.64	54.10	60.74	105.20	-44.46	Peak	100	10	P
8	5925.00	6.78	53.40	60.18	68.20	-8.02	Peak	100	10	P
9	11580.00	15.10	29.56	44.66	54.00	-9.34	Average	100	145	P
10	11580.00	15.10	44.13	59.23	74.00	-14.77	Peak	100	145	P
11	17370.00	21.34	46.44	67.78	68.20	-0.42	Peak	100	167	P

Note: Level=Reading+Factor
 Margin=Level-Limit
 Factor=Antenna Factor + cable loss - Amplifier Factor



Power	: DC 48V From Adapter (AC 120V / 60Hz)	Pol/Phase	: HORIZONTAL
Test Mode	: Mode 1, 5790MHz		

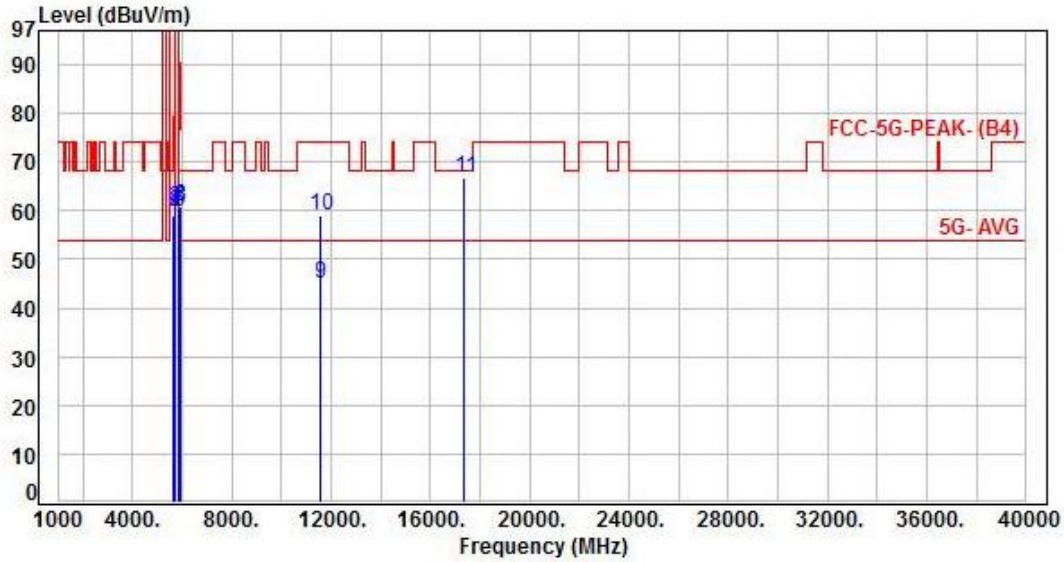

No.	Frequency (MHz)	Factor (dB)	Reading (dBuV)	Level (dBuV/m)	Limit (dBuV/m)	Margin (dB)	Detector	Height (cm)	Azimuth (deg)	P/F
1	5650.00	6.33	52.84	59.17	68.20	-9.03	Peak	100	9	P
2	5700.00	6.37	53.34	59.71	105.20	-45.49	Peak	100	9	P
3	5720.00	6.42	54.05	60.47	110.80	-50.33	Peak	100	9	P
4	5725.00	6.44	53.50	59.94	122.20	-62.26	Peak	100	9	P
5	5850.00	6.58	53.35	59.93	122.20	-62.27	Peak	100	9	P
6	5855.00	6.60	53.28	59.88	110.80	-50.92	Peak	100	9	P
7	5875.00	6.64	54.00	60.64	105.20	-44.56	Peak	100	9	P
8	5925.00	6.78	54.19	60.97	68.20	-7.23	Peak	100	9	P
9	11580.00	15.10	29.97	45.07	54.00	-8.93	Average	100	183	P
10	11580.00	15.10	43.99	59.09	74.00	-14.91	Peak	100	183	P
11	17370.00	21.34	45.45	66.79	68.20	-1.41	Peak	100	128	P

Note: Level=Reading+Factor
 Margin=Level-Limit
 Factor=Antenna Factor + cable loss - Amplifier Factor



Power	: DC 48V From Adapter (AC 120V / 60Hz)	Pol/Phase	: VERTICAL
Test Mode	: Mode 1, 5835MHz		:

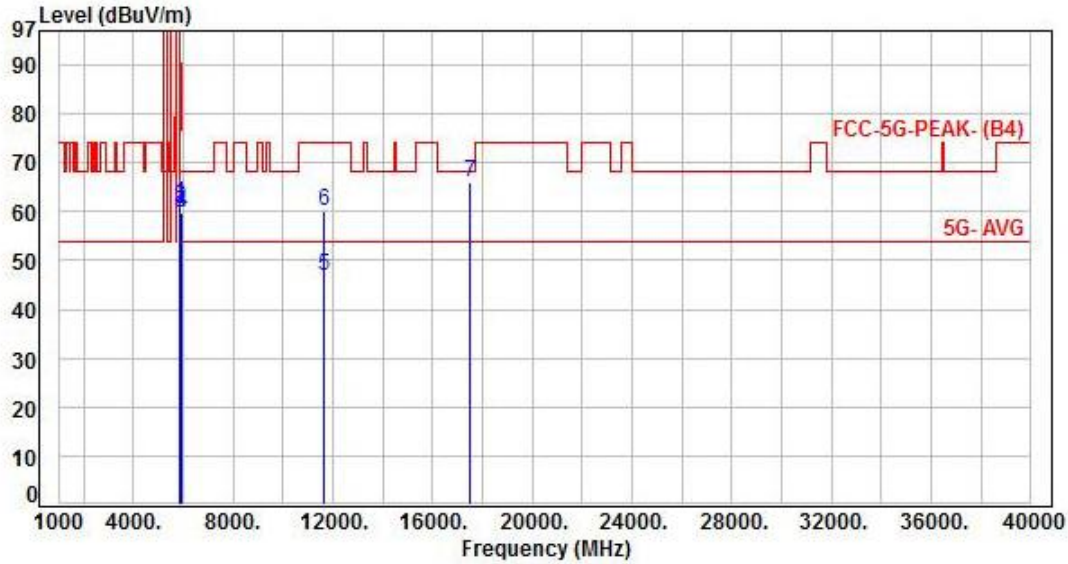

No.	Frequency (MHz)	Factor (dB)	Reading (dBuV)	Level (dBuV/m)	Limit (dBuV/m)	Margin (dB)	Detector	Height (cm)	Azimuth (deg)	P/F
1	5850.00	6.58	55.12	61.70	122.20	-60.50	Peak	107	9	P
2	5855.00	6.60	54.37	60.97	110.80	-49.83	Peak	107	9	P
3	5875.00	6.64	53.08	59.72	105.20	-45.48	Peak	107	9	P
4	5925.00	6.78	52.81	59.59	68.20	-8.61	Peak	107	9	P
5	11670.00	15.23	31.55	46.78	54.00	-7.22	Average	107	204	P
6	11670.00	15.23	45.04	60.27	74.00	-13.73	Peak	107	204	P
7	17505.00	22.45	43.53	65.98	68.20	-2.22	Peak	100	349	P

Note: Level=Reading+Factor
Margin=Level-Limit
Factor=Antenna Factor + cable loss - Amplifier Factor



Power	:	DC 48V From Adapter (AC 120V / 60Hz)	Pol/Phase	:	HORIZONTAL
Test Mode	:	Mode 1, 5835MHz		:	

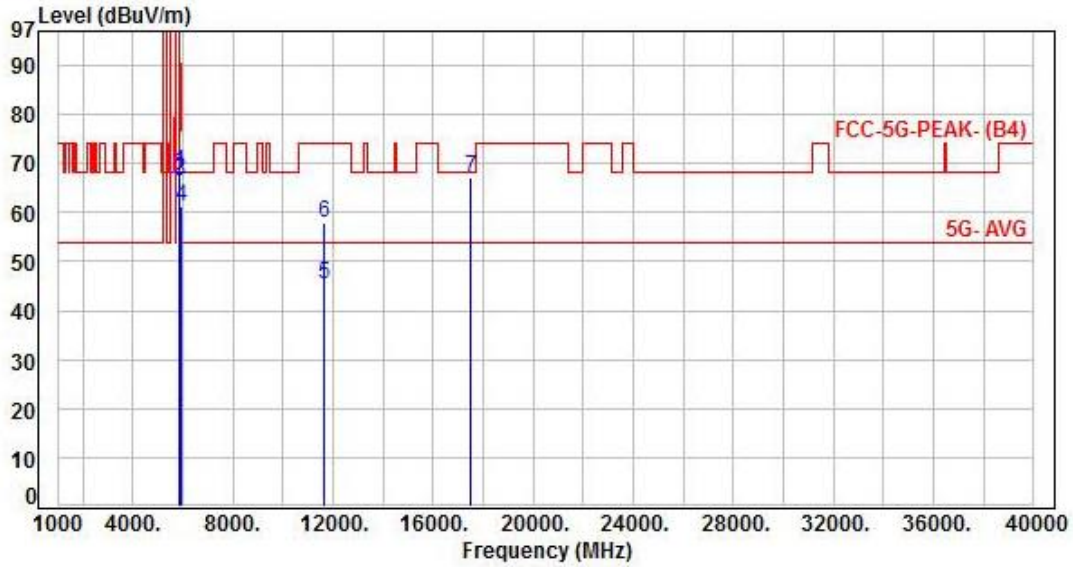

No.	Frequency (MHz)	Factor (dB)	Reading (dBuV)	Level (dBuV/m)	Limit (dBuV/m)	Margin (dB)	Detector	Height (cm)	Azimuth (deg)	P/F
1	5850.00	6.58	61.62	68.20	122.20	-54.00	Peak	185	0	P
2	5855.00	6.60	60.24	66.84	110.80	-43.96	Peak	185	0	P
3	5875.00	6.64	59.91	66.55	105.20	-38.65	Peak	185	0	P
4	5925.00	6.78	54.53	61.31	68.20	-6.89	Peak	185	0	P
5	11670.00	15.23	30.26	45.49	54.00	-8.51	Average	100	233	P
6	11670.00	15.23	42.57	57.80	74.00	-16.20	Peak	100	233	P
7	17505.00	22.45	44.82	67.27	68.20	-0.93	Peak	100	28	P

Note: Level=Reading+Factor
Margin=Level-Limit
Factor=Antenna Factor + cable loss - Amplifier Factor



6.7. Restricted Bands of Operation

Only spurious emissions are permitted in any of the frequency bands listed below:

MHz	MHz	MHz	GHz
0.09000 – 0.11000	16.42000 – 16.42300	399.9 – 410.0	4.500 – 5.150
0.49500 – 0.505**	16.69475 – 16.69525	608.0 – 614.0	5.350 – 5.460
2.17350 – 2.19050	16.80425 – 16.80475	960.0 – 1240.0	7.250 – 7.750
4.12500 – 4.12800	25.50000 – 25.67000	1300.0 – 1427.0	8.025 – 8.500
4.17725 – 4.17775	37.50000 – 38.25000	1435.0 – 1626.5	9.000 – 9.200
4.20725 – 4.20775	73.00000 – 74.60000	1645.5 – 1646.5	9.300 – 9.500
6.21500 – 6.21800	74.80000 – 75.20000	1660.0 – 1710.0	10.600 – 12.700
6.26775 – 6.26825	108.00000 – 121.94000	1718.8 – 1722.2	13.250 – 13.400
6.31175 – 6.31225	123.00000 – 138.00000	2200.0 – 2300.0	14.470 – 14.500
8.29100 – 8.29400	149.90000 – 150.05000	2310.0 – 2390.0	15.350 – 16.200
8.36200 – 8.36600	156.52475 – 156.52525	2483.5 – 2500.0	17.700 – 21.400
8.37625 – 8.38675	156.70000 – 156.90000	2655.0 – 2900.0	22.010 – 23.120
8.41425 – 8.41475	162.01250 – 167.17000	3260.0 – 3267.0	23.600 – 24.000
12.29000 – 12.29300	167.72000 – 173.20000	3332.0 – 3339.0	31.200 – 31.800
12.51975 – 12.52025	240.00000 – 285.00000	3345.8 – 3358.0	36.430 – 36.500
12.57675 – 12.57725	322.00000 – 335.40000	3600.0 – 4400.0	Above 38.6
13.36000 – 13.41000			

** : Until February 1, 1999, this restricted band shall be 0.490-0.510 MHz



7. On Time, Duty Cycle and Measurement methods

7.1. Test Limit

None; for reporting purposes only.

7.2. Test Procedure

KDB 789033 Zero-Span Spectrum Analyzer Method.

7.3. Test Setup Layout

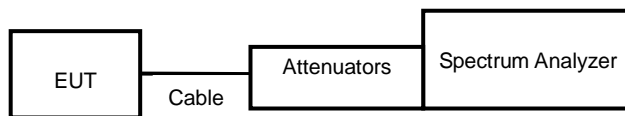

7.4. Test Result and Data

On Time (ms)	Period Time (ms)	Duty Cycle (%)
5.44	5.92	91.89%

7.5. Measurement Methods

26 dB and 6dB Emission BW	KDB 789033 D02 v02r01, Section C
99% Occupied BW	KDB 789033 D02 v02r01, Section D
Conducted Output Power	KDB 789033 D02 v02r01, Section E.2.d and E.3.b (Method PM-G)
Power Spectral Density	KDB 789033 D02 v02r01, Section F
Unwanted emissions in restricted bands	KDB 789033 D02 v02r01, Sections G and H
Unwanted emissions in non-restricted bands	KDB 789033 D02 v02r01, Sections G and H

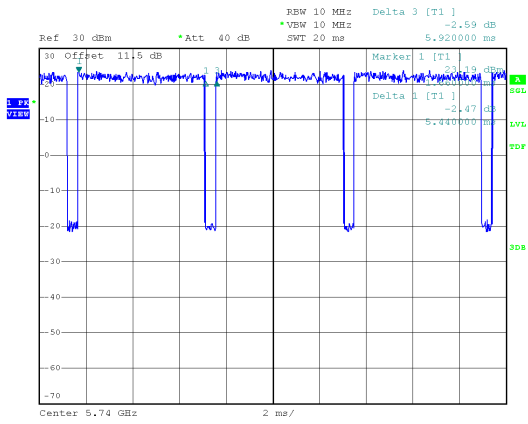



8. 6dB Bandwidth & 99% Occupied Bandwidth

8.1. Test Limit

FCC §15.407

The minimum 6 dB bandwidth shall be at least 500 kHz.

8.2. Test Procedure

Reference to 789033 D02 General UNII Test Procedures New Rules v01: The transmitter output is connected to a spectrum analyzer with the RBW set to 100KHz, the VBW $\geq 3 \times$ RBW, peak detector and max hold.

8.3. Test Setup Layout

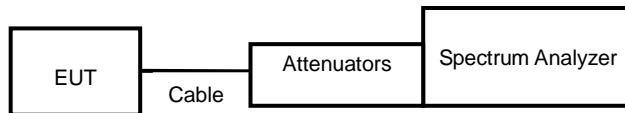



8.4. Test Result and Data

In the 5.8G Band

Frequency (MHz)	6dB Bandwidth(MHz)		Minimum Limit (MHz)
	ANT A	ANT B	
5740	15.00	15.06	0.50
5790	15.09	15.09	0.50
5835	15.12	15.36	0.50

In the 5.8G Band

Frequency (MHz)	99% Bandwidth(MHz)	
	ANT A	ANT B
5740	18.87	18.84
5790	18.93	18.87
5835	18.93	18.87



6dB Bandwidth
ANT A
5740MHz

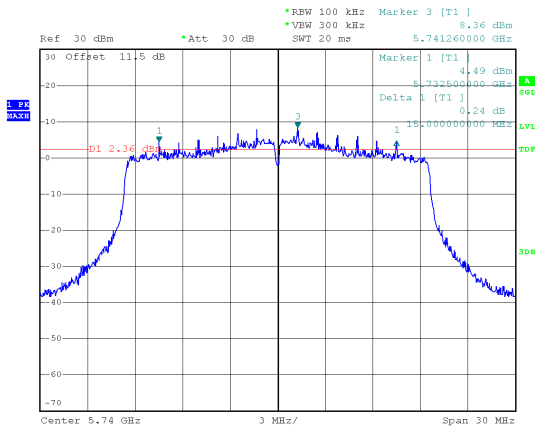

ANT B
5740MHz

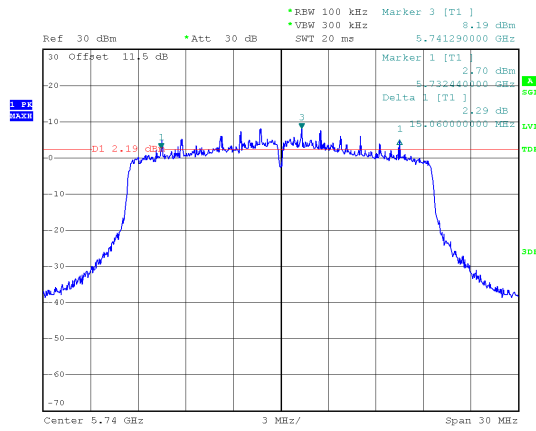

5790MHz

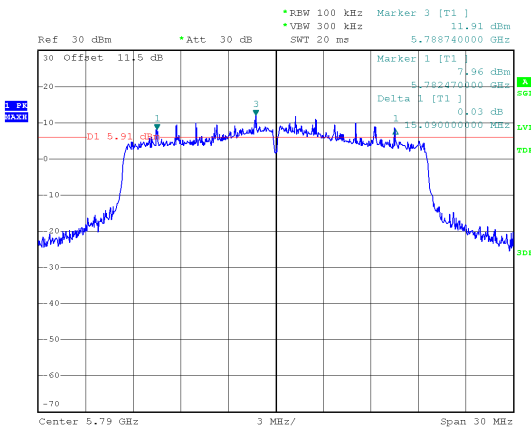

5790MHz

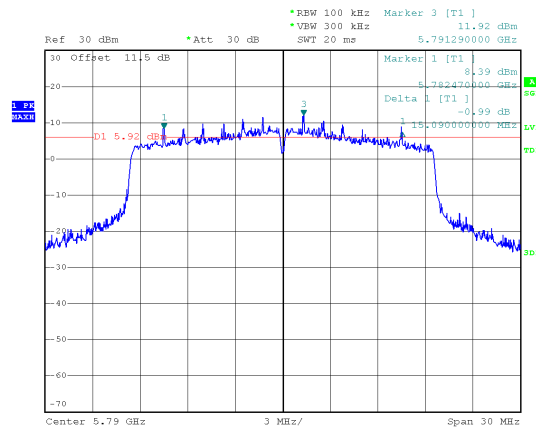

5835MHz

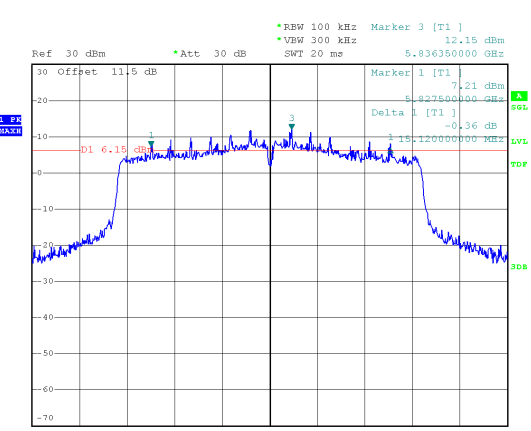

5835MHz

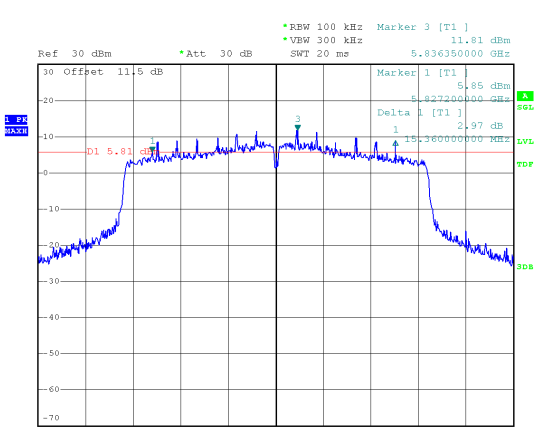



99% Occupied Bandwidth
ANT A
5740MHz

ANT B
5740MHz

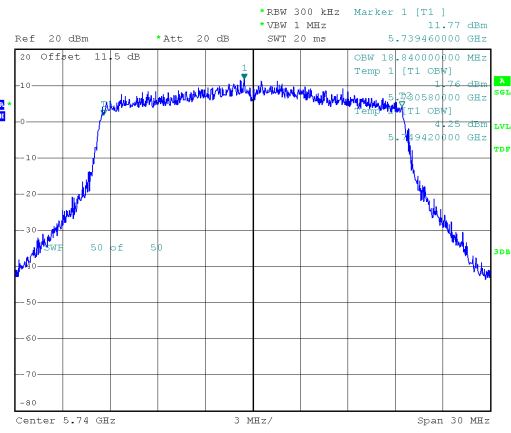
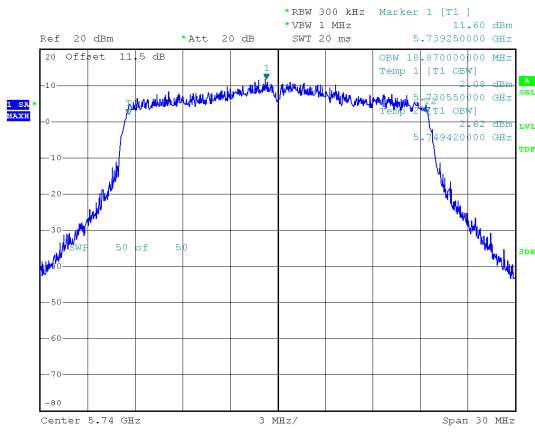

5790MHz

5790MHz

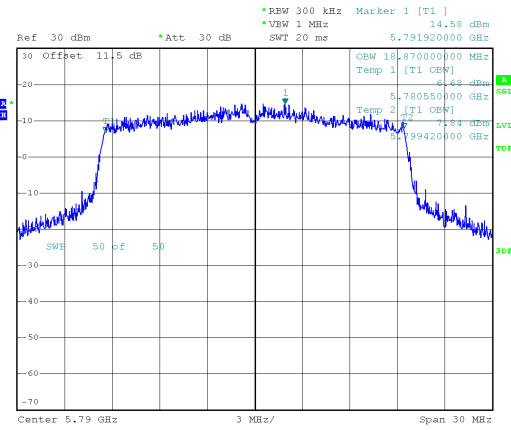
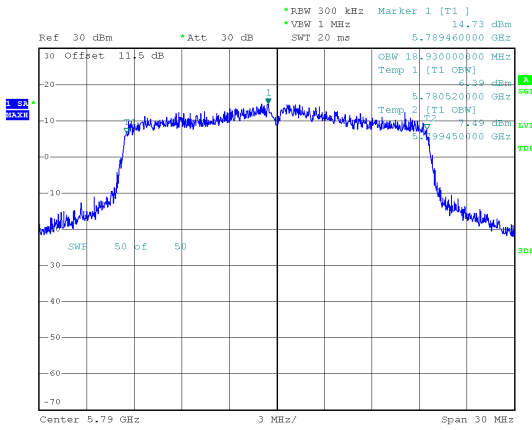

5835MHz

5835MHz

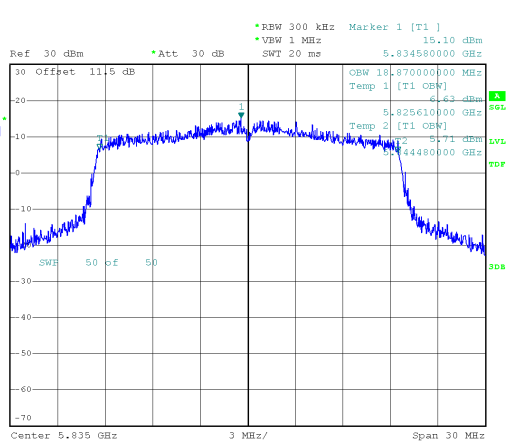
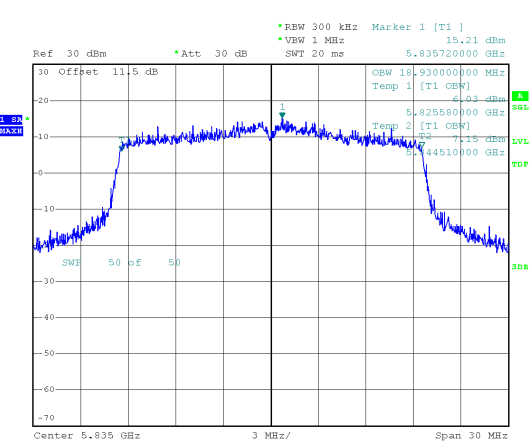



9. Average Power

9.1. Test Limit

Output Power:

Frequency Band	Limit
<input type="checkbox"/> 5.15~5.25GHz	
Operating Mode	
<input type="checkbox"/> Outdoor access point	The maximum conducted output power over the frequency band of operation shall not exceed 1 W (30dBm) provided the maximum antenna gain does not exceed 6 dBi. If transmitting antennas of directional gain greater than 6 dBi are used, both the maximum conducted output power and the maximum power spectral density shall be reduced by the amount in dB that the directional gain of the antenna exceeds 6 dBi. The maximum e.i.r.p. at any elevation angle above 30degrees as measured from the horizon must not exceed 125 mW (21 dBm).
<input type="checkbox"/> Indoor access point	The maximum conducted output power over the frequency band of operation shall not exceed 1 W (30dBm) provided the maximum antenna gain does not exceed 6 dBi. If transmitting antennas of directional gain greater than 6 dBi are used, both the maximum conducted output power and the maximum power spectral density shall be reduced by the amount in dB that the directional gain of the antenna exceeds 6 dBi.
<input type="checkbox"/> Fixed point-to-point access points	The maximum conducted output power over the frequency band of operation shall not exceed 1 W (30dBm). Fixed point-to-point U-NII devices may employ antennas with directional gain up to 23 dBi without any corresponding reduction in the maximum conducted output power or maximum power spectral density. For fixed point-to-point transmitters that employ a directional antenna gain greater than 23 dBi, a 1 dB reduction in maximum conducted output power and maximum power spectral density is required for each 1 dB of antenna gain in excess of 23 dBi.
<input type="checkbox"/> client devices	The maximum conducted output power over the frequency band of operation shall not exceed 250 mW (24dBm) provided the maximum antenna gain does not exceed 6 dBi. If transmitting antennas of directional gain greater than 6 dBi are used, both the maximum conducted output power and the maximum power spectral density shall be reduced by the amount in dB that the directional gain of the antenna exceeds 6 dBi.



Frequency Band	Limit
<input type="checkbox"/> 5.25-5.35 GHz	The maximum conducted output power over the frequency bands of operation shall not exceed the lesser of 250 mW (24dBm) or 11 dBm 10 log B, where B is the 26 dB emission bandwidth in megahertz. If transmitting antennas of directional gain greater than 6 dBi are used, both the maximum conducted output power and the maximum power spectral density shall be reduced by the amount in dB that the directional gain of the antenna exceeds 6 dBi.
<input type="checkbox"/> 5.470-5.725 GHz	
<input checked="" type="checkbox"/> 5.725~5.85 GHz	

9.2. Test Procedure

According to the methods defined in ANSI C63.10-2013 Section 12.3

The transmitter output is connected to a power meter.

The cable assembly insertion loss of 11.5 dB (including 10 dB pad and 1.5 dB cable) was entered as an offset in the power meter to allow for direct reading of power.

9.3. Test Setup Layout

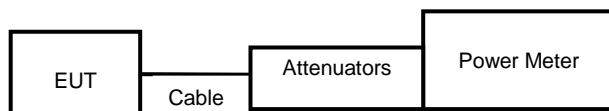



9.4. Test Result and Data

Data Rate	Setting	Frequency (MHz)	Measured value of each antenna port (dBm)		Total power (dBm)	Total power (mW)	FCC Limit (dBm)
			ANT A	ANT B			
NSS1-MCS0	40	5740	19.66	19.84	22.76	188.853	30.00
NSS1-MCS0	42	5790	21.16	21.18	24.18	261.837	30.00
NSS1-MCS0	42	5835	21.33	20.98	24.17	261.145	30.00



10. Power Spectral Density

10.1. Test Limit

PSD:

Frequency Band		Limit
<input type="checkbox"/>	5.15~5.25GHz	
	Operating Mode	
<input type="checkbox"/>	Outdoor access point	17 dBm/MHz
<input type="checkbox"/>	Indoor access point	17 dBm/MHz
<input type="checkbox"/>	Fixed point-to-point access points	17 dBm/MHz
<input type="checkbox"/>	Mobile and portable client devices	11 dBm/MHz
<input type="checkbox"/>	5.725~5.85 GHz	11 dBm/MHz
<input type="checkbox"/>	5.470-5.725 GHz	11 dBm/MHz
<input checked="" type="checkbox"/>	5.725~5.85 GHz	30 dBm/500kHz

10.2. Test Procedure

Reference to KDB789033 D02 General UNII Test Procedures New Rules v02r01

10.3. Test Setup Layout

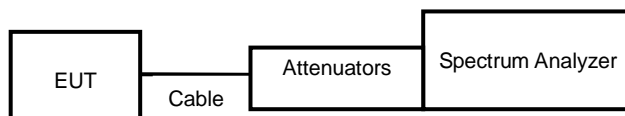

10.4. Test Result and Data

Frequency (MHz)	Meas PSD (dBm/MHz)		Sum chain (dBm)	Duty Cycle CF(dB)	10log(500KHz/RBW) CF (dB)	Total Corr'd PSD (dBm/500kHz)	PSD Limit (dBm/500kHz)
	ANT A	ANT B					
5740	8.68	8.69	11.70	0.37	-3.01	9.06	30.00
5790	10.35	9.92	13.15	0.37	-3.01	10.51	30.00
5835	10.29	9.91	13.11	0.37	-3.01	10.47	30.00



ANT A
5740MHz

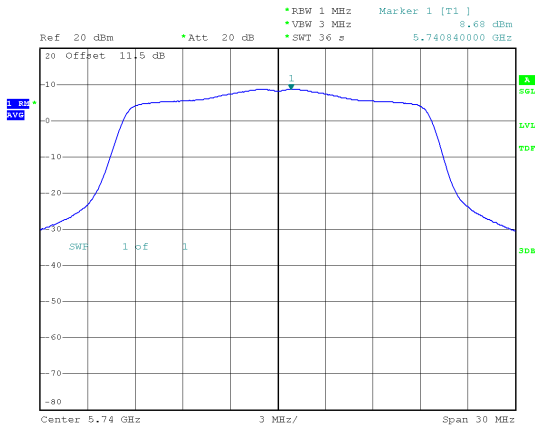

ANT B
5740MHz

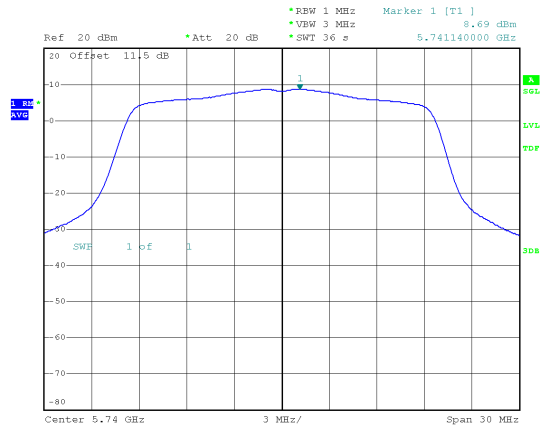

5790MHz

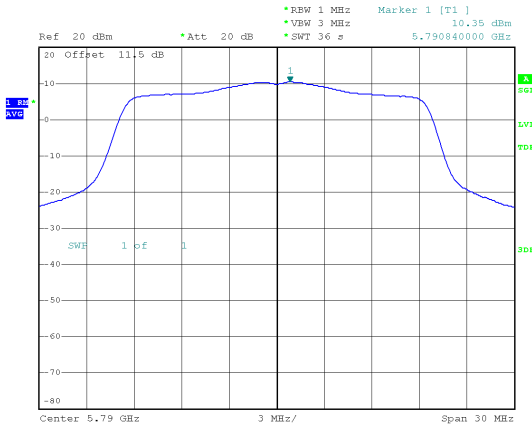

5790MHz

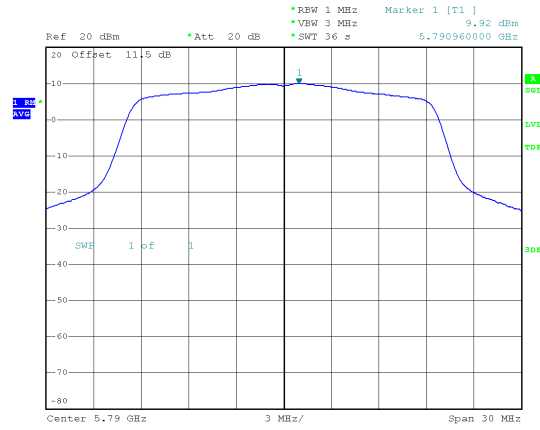

5835MHz

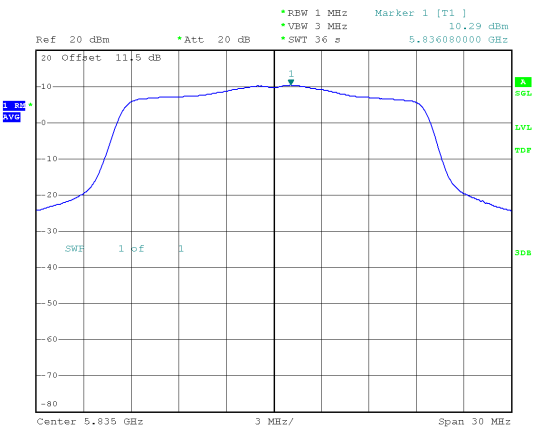

5835MHz

