

EMC Test Report

Application for Grant of Equipment Authorization

*Industry Canada RSS-Gen Issue 3 / RSS 210 Issue 8
FCC Part 15 Subpart C*

Model: MFi-VPS (mPort-S)

IC CERTIFICATION #: 6545A-VPS
FCC ID: SWX-VPS

APPLICANT: Ubiquiti Networks
2580 Orchard Pkwy
San Jose, CA 95131

TEST SITE(S): NTS Silicon Valley
41039 Boyce Road.
Fremont, CA. 94538-2435

IC SITE REGISTRATION #: 2845B-3; 2845B-4, 2845B-5, 2845B-7

REPORT DATE: July 23, 2012

REISSUE DATE: December 5, 2012

FINAL TEST DATES: January 13, February 10, March 30, April 2, 9
and 11, May 1, 14 and 18, 2012

TOTAL NUMBER OF PAGES: 72

PROGRAM MGR /
TECHNICAL REVIEWER:

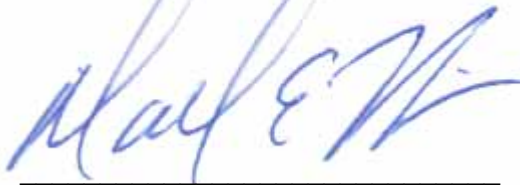

Mark E Hill
Staff Engineer

QUALITY ASSURANCE DELEGATE /
FINAL REPORT PREPARER:

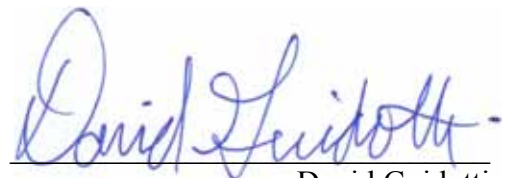

David Guidotti
Senior Technical Writer



NTS Silicon Valley is accredited by the A2LA, certificate number 0214.26, to perform the test(s) listed in this report, except where noted otherwise. This report and the information contained herein represent the results of testing test articles identified and selected by the client performed to specifications and/or procedures selected by the client. National Technical Systems (NTS) makes no representations, expressed or implied, that such testing is adequate (or inadequate) to demonstrate efficiency, performance, reliability, or any other characteristic of the articles being tested, or similar products. This report should not be relied upon as an endorsement or certification by NTS of the equipment tested, nor does it represent any statement whatsoever as to its merchantability or fitness of the test article, or similar products, for a particular purpose. This report shall not be reproduced except in full

REVISION HISTORY

Rev#	Date	Comments	Modified By
-	07-23-2012	First release	
1	08-20-2012	Reissued to correct the model name	DMG
2	12-05-12	Updated antenna information and results. Included results from the external antenna.	MEH

TABLE OF CONTENTS

REVISION HISTORY2

TABLE OF CONTENTS3

SCOPE.....4

OBJECTIVE4

STATEMENT OF COMPLIANCE.....5

DEVIATIONS FROM THE STANDARDS.....5

TEST RESULTS SUMMARY6

 DIGITAL TRANSMISSION SYSTEMS (2400 – 2483.5MHZ)6

 GENERAL REQUIREMENTS APPLICABLE TO ALL BANDS7

 MEASUREMENT UNCERTAINTIES8

EQUIPMENT UNDER TEST (EUT) DETAILS.....9

 GENERAL.....9

 OTHER EUT DETAILS.....9

 ANTENNA SYSTEM9

 ENCLOSURE.....9

 MODIFICATIONS.....9

 SUPPORT EQUIPMENT10

 EUT INTERFACE PORTS10

 EUT OPERATION10

TEST SITE.....11

 GENERAL INFORMATION.....11

 CONDUCTED EMISSIONS CONSIDERATIONS11

 RADIATED EMISSIONS CONSIDERATIONS11

MEASUREMENT INSTRUMENTATION12

 RECEIVER SYSTEM12

 INSTRUMENT CONTROL COMPUTER12

 LINE IMPEDANCE STABILIZATION NETWORK (LISN).....12

 FILTERS/ATTENUATORS13

 ANTENNAS.....13

 ANTENNA MAST AND EQUIPMENT TURNTABLE13

 INSTRUMENT CALIBRATION.....13

TEST PROCEDURES14

 EUT AND CABLE PLACEMENT14

 CONDUCTED EMISSIONS.....14

 RADIATED EMISSIONS.....15

 CONDUCTED EMISSIONS FROM ANTENNA PORT17

 BANDWIDTH MEASUREMENTS17

 SPECIFICATION LIMITS AND SAMPLE CALCULATIONS18

 CONDUCTED EMISSIONS SPECIFICATION LIMITS: FCC 15.207; FCC 15.107(A), RSS GEN18

 GENERAL TRANSMITTER RADIATED EMISSIONS SPECIFICATION LIMITS19

 RECEIVER RADIATED SPURIOUS EMISSIONS SPECIFICATION LIMITS19

 OUTPUT POWER LIMITS – DIGITAL TRANSMISSION SYSTEMS20

 TRANSMIT MODE SPURIOUS RADIATED EMISSIONS LIMITS – FHSS AND DTS SYSTEMS.....20

 SAMPLE CALCULATIONS - CONDUCTED EMISSIONS20

 SAMPLE CALCULATIONS - RADIATED EMISSIONS.....21

 SAMPLE CALCULATIONS - FIELD STRENGTH TO EIRP CONVERSION.....22

APPENDIX A TEST EQUIPMENT CALIBRATION DATA23

APPENDIX B TEST DATA24

END OF REPORT72

SCOPE

An electromagnetic emissions test has been performed on the Ubiquiti Networks model mPort, pursuant to the following rules:

Industry Canada RSS-Gen Issue 3
RSS 210 Issue 8 "Low-power Licence-exempt Radiocommunication Devices (All Frequency Bands): Category I Equipment"
FCC Part 15 Subpart C

Conducted and radiated emissions data has been collected, reduced, and analyzed within this report in accordance with measurement guidelines set forth in the following reference standards and as outlined in NTS Silicon Valley test procedures:

ANSI C63.4:2003
FCC DTS Measurement Procedure KDB558074, March 2005

The intentional radiator above has been tested in a simulated typical installation to demonstrate compliance with the relevant Industry Canada performance and procedural standards.

Final system data was gathered in a mode that tended to maximize emissions by varying orientation of EUT, orientation of power and I/O cabling, antenna search height, and antenna polarization.

Every practical effort was made to perform an impartial test using appropriate test equipment of known calibration. All pertinent factors have been applied to reach the determination of compliance.

OBJECTIVE

The primary objective of the manufacturer is compliance with the regulations outlined in the previous section.

Prior to marketing in the USA, all unlicensed transmitters and transceivers require certification. Receive-only devices operating between 30 MHz and 960 MHz are subject to either certification or a manufacturer's declaration of conformity, with all other receive-only devices exempt from the technical requirements.

Prior to marketing in Canada, Class I transmitters, receivers and transceivers require certification. Class II devices are required to meet the appropriate technical requirements but are exempt from certification requirements.

Certification is a procedure where the manufacturer submits test data and technical information to a certification body and receives a certificate or grant of equipment authorization upon successful completion of the certification body's review of the submitted documents. Once the equipment authorization has been obtained, the label indicating compliance must be attached to all identical units, which are subsequently manufactured.

Maintenance of compliance is the responsibility of the manufacturer. Any modification of the product which may result in increased emissions should be checked to ensure compliance has been maintained (i.e., printed circuit board layout changes, different line filter, different power supply, harnessing or I/O cable changes, etc.).

Testing was performed only on model MFi-VPM (mPort). This model was considered representative of the following models.

MFi-VPS (mPort-S) – Sensor connector changed from DB9 connector on MFi-VPS (mPort-S) to RJ45 connectors on the MFi-VPM (mPort). All other circuitry and layout are the same.

STATEMENT OF COMPLIANCE

The tested sample of Ubiquiti Networks model mPort complied with the requirements of the following regulations:

Industry Canada RSS-Gen Issue 3
RSS 210 Issue 8 “Low-power Licence-exempt Radiocommunication Devices (All Frequency Bands): Category I Equipment”
FCC Part 15 Subpart C

Maintenance of compliance is the responsibility of the manufacturer. Any modifications to the product should be assessed to determine their potential impact on the compliance status of the device with respect to the standards detailed in this test report.

The test results recorded herein are based on a single type test of Ubiquiti Networks model MFi-VPS (mPort-S) and therefore apply only to the tested sample. The sample was selected and prepared by Jennifer Sanchez of Ubiquiti Networks.

DEVIATIONS FROM THE STANDARDS

No deviations were made from the published requirements listed in the scope of this report.

TEST RESULTS SUMMARY

DIGITAL TRANSMISSION SYSTEMS (2400 – 2483.5MHz)

FCC Rule Part	RSS Rule Part	Description	Measured Value / Comments	Limit / Requirement	Result
15.247(a)	RSS 210 A8.2	Digital Modulation	Systems uses OFDM / DSSS techniques	System must utilize a digital transmission technology	Complies
15.247 (a) (2)	RSS 210 A8.2 (1)	6dB Bandwidth	g: 16.07 MHz n20: 17.43 MHz	>500kHz	Complies
15.247 (b) (3)	RSS 210 A8.2 (4)	Output Power Internal Antenna	g: 9.8 dBm (0.0095W) n20: 9.2 dBm (0.0083W) EIRP = 0.019 W ^{Note 1}	1Watt, EIRP limited to 4 Watts.	Complies
15.247 (b) (3)	RSS 210 A8.2 (4)	Output Power External Antenna	g: 1.9 dBm (0.0016W) n20: 4.4 dBm (0.0027W) EIRP = 0.007 W ^{Note 1}	1Watt, EIRP limited to 4 Watts.	Complies
15.247(d)	RSS 210 A8.2 (2)	Power Spectral Density	g: -13.4 dBm/3kHz n20: -14.2 dBm/3kHz	8dBm/3kHz	Complies
15.247(c)	RSS 210 A8.5	Antenna Port Spurious Emissions 30MHz – 25 GHz	All emissions < -30dBc	< -30dBc ^{Note 2}	Complies
15.247(c) / 15.209	RSS 210 A8.5	Radiated Spurious Emissions 30MHz – 25 GHz	54.0 dBuV/m @ 2483.6 MHz (-0.0dB)	15.207 in restricted bands, all others <-30dBc ^{Note 2}	Complies
Note 1: EIRP calculated using antenna gain of 3dBi for the internal antenna and 4dBi for the external antenna. Note 2: Limit of -30dBc used because the power was measured using the UNII test procedure (maximum power averaged over a transmission burst).					

GENERAL REQUIREMENTS APPLICABLE TO ALL BANDS

FCC Rule Part	RSS Rule part	Description	Measured Value / Comments	Limit / Requirement	Result (margin)
15.203	-	RF Connector	The external antenna is connected via a reverse SMA	Unique or integral antenna required	Complies
15.207	RSS GEN Table 2	AC Conducted Emissions	36.4 dB μ V @ 0.350 MHz (-12.6 dB)	Refer to page 18	Complies
15.109	RSS GEN 7.2.3 Table 1	Receiver spurious emissions	-	Refer to page 19	N/A
15.247 (b) (5) 15.407 (f)	RSS 102	RF Exposure Requirements	Refer to MPE calculations in Exhibit 11, RSS 102 declaration and User Manual statements.	Refer to OET 65, FCC Part 1 and RSS 102	Complies
-	RSP 100 RSS GEN 7.1.5	User Manual		Statement required regarding non-interference	Complies
-	RSP 100 RSS GEN 7.1.5	User Manual		Statement for products with detachable antenna	Complies
-	RSP 100 RSS GEN 4.4.1	99% Bandwidth	g: 17.0 MHz n20: 18.1 MHz	Information only	N/A

MEASUREMENT UNCERTAINTIES

ISO/IEC 17025 requires that an estimate of the measurement uncertainties associated with the emissions test results be included in the report. The measurement uncertainties given below are based on a 95% confidence level and were calculated in accordance with UKAS document LAB 34.

Measurement Type	Measurement Unit	Frequency Range	Expanded Uncertainty
RF power, conducted (power meter)	dBm	25 to 7000 MHz	± 0.52 dB
RF power, conducted (Spectrum analyzer)	dBm	25 to 7000 MHz	± 0.7 dB
Conducted emission of transmitter	dBm	25 to 26500 MHz	± 0.7 dB
Conducted emission of receiver	dBm	25 to 26500 MHz	± 0.7 dB
Radiated emission (substitution method)	dBm	25 to 26500 MHz	± 2.5 dB
Radiated emission (field strength)	dB μ V/m	25 to 1000 MHz	± 3.6 dB
		1000 to 40000 MHz	± 6.0 dB
Conducted Emissions (AC Power)	dB μ V	0.15 to 30 MHz	± 2.4 dB

EQUIPMENT UNDER TEST (EUT) DETAILS

GENERAL

The Ubiquiti Networks model MFi-VPS (mPort-S) is a network controlled device to which various sensors can be attached. Data collected from the sensors can be transmitted via a wired Ethernet connection or wireless 802.11g/n20 connection. The EUT operate in the 2.4 GHz band only & is a single chain device. It was treated as table-top equipment during testing to most closely simulate the end-user environment. The electrical rating of the EUT is 24 VDC, .5 Amps.

The sample was received on January 13, 2012 and tested on January 13, February 10, March 30, April 2, 9 and 11, May 1, 14 and 18, 2012. The EUT consisted of the following component(s):

Company	Model	Description	Serial Number	FCC ID
Ubiquiti Networks	mPort and mPort-S	802.11 basestation	Prototype	SWX-VPS 6545A-VPS

OTHER EUT DETAILS

The mPort and mPort-S differ in the interface to the door/window sensors. For the mPort, the interface is comprised of two shielded RJ45 connectors. For the mPort-S, the interface is a DB9 connector. All other circuitry is the same. The mPort was tested as the worse case configuration.

Note, the mPort-S model offer an internal antenna and external antenna option. The mPort only offers the internal antenna option.

Radiated spurious emissions and power measurements were performed using on the internal and external antenna options. Power spectral density, bandwidth, and conducted spurious emissions were performed using the worse case power settings from both options.

ANTENNA SYSTEM

The EUT external antenna is a plastic ducky with gain = 4dBi. The internal antenna is integral to the device, with gain = 3dBi

The antenna connects to the EUT via a non-standard SMA antenna connector, thereby meeting the requirements of FCC 15.203.

ENCLOSURE

The EUT enclosure measures approximately 10cm by 6cm by 3cm. It is primarily constructed of uncoated plastic.

MODIFICATIONS

No modifications were made to the EUT during the time the product was at NTS Silicon Valley.

SUPPORT EQUIPMENT

No local support equipment was used during testing.

The following equipment was used as remote support equipment for emissions testing:

Company	Model	Description	Serial Number	FCC ID
Ubiquiti	UBI-POE-24-5	PoE pwr supply	-	-
Dell	Vostro	Laptop	-	-

EUT INTERFACE PORTS

The I/O cabling configuration during testing was as follows:

Port	Connected To	Description	Cable(s)	Length(m)
			Shielded or Unshielded	
Ethernet	Pwr supply PoE port	Cat 5	Shielded	7
Antenna	External antenna	Direct connection	NA	NA
Pwr supply LAN port	Laptop	Cat 5	Unshielded	1
AC pwr (pwr supply)	AC mains	3 wire	Unshielded	1

Note: The USB port was not connected during testing. The manufacturer stated that this is for setup purposes and therefore would not normally be connected. The RJ-45 (2) & 8-terminal sensor ports were not connected during testing. These ports have no radio function.

EUT OPERATION

During emissions testing the EUT was transmitting on the channel & at the power level called out in the individual tests.

TEST SITE

GENERAL INFORMATION

Final test measurements were taken at the test sites listed below. Pursuant to section 2.948 of the FCC’s Rules and section 3.3 of RSP-100, construction, calibration, and equipment data has been filed with the Commission and with industry Canada.

Site	Registration Numbers		Location
	FCC	Canada	
Chamber 3	769238	2845B-3	41039 Boyce Road Fremont, CA 94538-2435
Chamber 4	211948	2845B-4	
Chamber 7	A2LA accreditation	2845B-7	

ANSI C63.4:2003 recommends that ambient noise at the test site be at least 6 dB below the allowable limits. Ambient levels are below this requirement. The test site(s) contain separate areas for radiated and conducted emissions testing. Considerable engineering effort has been expended to ensure that the facilities conform to all pertinent requirements of ANSI C63.4:2003.

CONDUCTED EMISSIONS CONSIDERATIONS

Conducted emissions testing is performed in conformance with ANSI C63.4:2003. Measurements are made with the EUT connected to the public power network through a nominal, standardized RF impedance, which is provided by a line impedance stabilization network, known as a LISN. A LISN is inserted in series with each current-carrying conductor in the EUT power cord.

RADIATED EMISSIONS CONSIDERATIONS

The FCC has determined that radiation measurements made in a shielded enclosure are not suitable for determining levels of radiated emissions. Radiated measurements are performed in an open field environment or in a semi-anechoic chamber. The test sites are maintained free of conductive objects within the CISPR defined elliptical area incorporated in ANSI C63.4:2003 guidelines and meet the Normalized Site Attenuation (NSA) requirements of ANSI C63.4:2003.

MEASUREMENT INSTRUMENTATION

RECEIVER SYSTEM

An EMI receiver as specified in CISPR 16-1-1 is used for emissions measurements. The receivers used can measure over the frequency range of 9 kHz up to 2000 MHz. These receivers allow both ease of measurement and high accuracy to be achieved. The receivers have Peak, Average, and CISPR (Quasi-peak) detectors built into their design so no external adapters are necessary. The receiver automatically sets the required bandwidth for the CISPR detector used during measurements. If the repetition frequency of the signal being measured is below 20Hz, peak measurements are made in lieu of Quasi-Peak measurements.

For measurements above the frequency range of the receivers, a spectrum analyzer is utilized because it provides visibility of the entire spectrum along with the precision and versatility required to support engineering analysis. Average measurements above 1000MHz are performed on the spectrum analyzer using the linear-average method with a resolution bandwidth of 1 MHz and a video bandwidth of 10 Hz, unless the signal is pulsed in which case the average (or video) bandwidth of the measuring instrument is reduced to onset of pulse desensitization and then increased.

INSTRUMENT CONTROL COMPUTER

The receivers utilize either a Rohde & Schwarz EZM Spectrum Monitor/Controller or contain an internal Spectrum Monitor/Controller to view and convert the receiver measurements to the field strength at an antenna or voltage developed at the LISN measurement port, which is then compared directly with the appropriate specification limit. This provides faster, more accurate readings by performing the conversions described under Sample Calculations within the Test Procedures section of this report. Results are printed in a graphic and/or tabular format, as appropriate. A personal computer is used to record all measurements made with the receivers.

The Spectrum Monitor provides a visual display of the signal being measured. In addition, the controller or a personal computer run automated data collection programs which control the receivers. This provides added accuracy since all site correction factors, such as cable loss and antenna factors are added automatically.

LINE IMPEDANCE STABILIZATION NETWORK (LISN)

Line conducted measurements utilize a fifty microhenry Line Impedance Stabilization Network as the monitoring point. The LISN used also contains a 250 uH CISPR adapter. This network provides for calibrated radio frequency noise measurements by the design of the internal low pass and high pass filters on the EUT and measurement ports, respectively.

FILTERS/ATTENUATORS

External filters and precision attenuators are often connected between the receiving antenna or LISN and the receiver. This eliminates saturation effects and non-linear operation due to high amplitude transient events.

ANTENNAS

A loop antenna is used below 30 MHz. For the measurement range 30 MHz to 1000 MHz either a combination of a biconical antenna and a log periodic or a bi-log antenna is used. Above 1000 MHz, horn antennas are used. The antenna calibration factors to convert the received voltage to an electric field strength are included with appropriate cable loss and amplifier gain factors to determine an overall site factor, which is then programmed into the test receivers or incorporated into the test software.

ANTENNA MAST AND EQUIPMENT TURNTABLE

The antennas used to measure the radiated electric field strength are mounted on a non-conductive antenna mast equipped with a motor-drive to vary the antenna height. Measurements below 30 MHz are made with the loop antenna at a fixed height of 1m above the ground plane.

ANSI C63.4:2003 specifies that the test height above ground for table mounted devices shall be 80 centimeters. Floor mounted equipment shall be placed on the ground plane if the device is normally used on a conductive floor or separated from the ground plane by insulating material from 3 to 12 mm if the device is normally used on a non-conductive floor. During radiated measurements, the EUT is positioned on a motorized turntable in conformance with this requirement.

INSTRUMENT CALIBRATION

All test equipment is regularly checked to ensure that performance is maintained in accordance with the manufacturer's specifications. All antennas are calibrated at regular intervals with respect to tuned half-wave dipoles. An exhibit of this report contains the list of test equipment used and calibration information.

TEST PROCEDURES

EUT AND CABLE PLACEMENT

The regulations require that interconnecting cables be connected to the available ports of the unit and that the placement of the unit and the attached cables simulate the worst case orientation that can be expected from a typical installation, so far as practicable. To this end, the position of the unit and associated cabling is varied within the guidelines of ANSI C63.4:2003, and the worst-case orientation is used for final measurements.

CONDUCTED EMISSIONS

Conducted emissions are measured at the plug end of the power cord supplied with the EUT. Excess power cord length is wrapped in a bundle between 30 and 40 centimeters in length near the center of the cord. Preliminary measurements are made to determine the highest amplitude emission relative to the specification limit for all the modes of operation. Placement of system components and varying of cable positions are performed in each mode. A final peak mode scan is then performed in the position and mode for which the highest emission was noted on all current carrying conductors of the power cord.

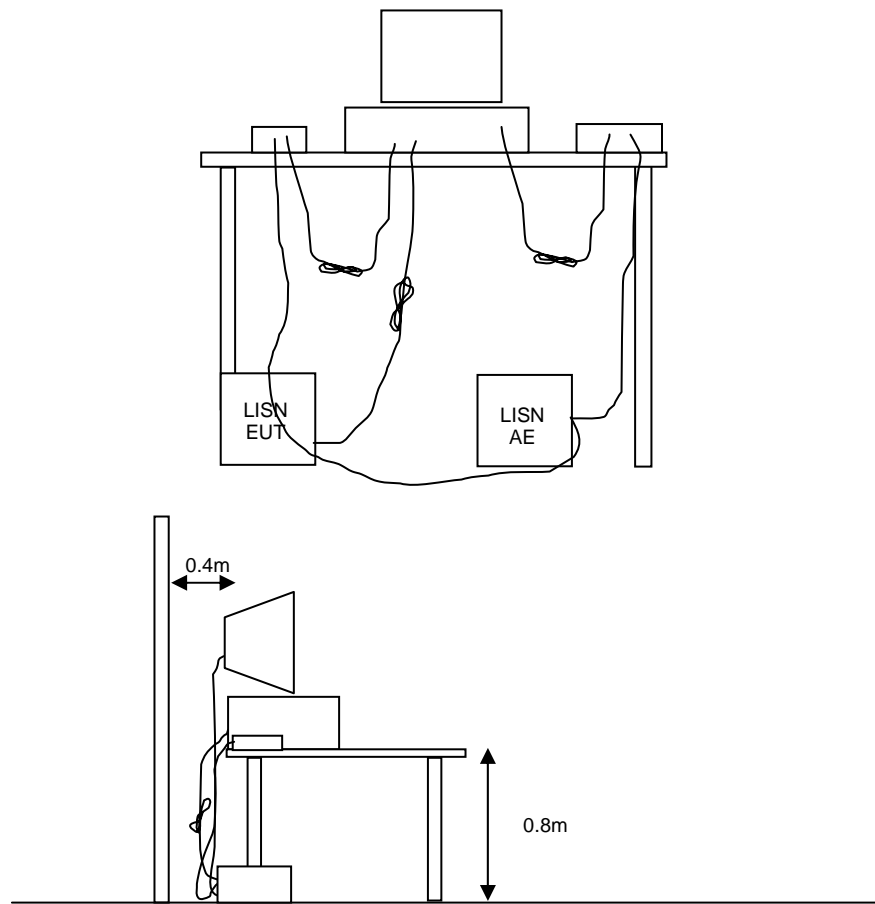

Figure 1 Typical Conducted Emissions Test Configuration

RADIATED EMISSIONS

A preliminary scan of the radiated emissions is performed in which all significant EUT frequencies are identified with the system in a nominal configuration. At least two scans are performed, one scan for each antenna polarization (horizontal and vertical; loop parallel and perpendicular to the EUT). During the preliminary scans, the EUT is rotated through 360°, the antenna height is varied (for measurements above 30 MHz) and cable positions are varied to determine the highest emission relative to the limit. Preliminary scans may be performed in a fully anechoic chamber for the purposes of identifying the frequencies of the highest emissions from the EUT.

A speaker is provided in the receiver to aid in discriminating between EUT and ambient emissions. Other methods used during the preliminary scan for EUT emissions involve scanning with near field magnetic loops, monitoring I/O cables with RF current clamps, and cycling power to the EUT.

Final maximization is a phase in which the highest amplitude emissions identified in the spectral search are viewed while the EUT azimuth angle is varied from 0 to 360 degrees relative to the receiving antenna. The azimuth, which results in the highest emission is then maintained while varying the antenna height from one to four meters (for measurements above 30 MHz, measurements below 30 MHz are made with the loop antenna at a fixed height of 1m). The result is the identification of the highest amplitude for each of the highest peaks. Each recorded level is corrected in the receiver using appropriate factors for cables, connectors, antennas, and preamplifier gain.

When testing above 18 GHz, the receive antenna is located at 1meter from the EUT and the antenna height is restricted to a maximum of 2.5 meters.

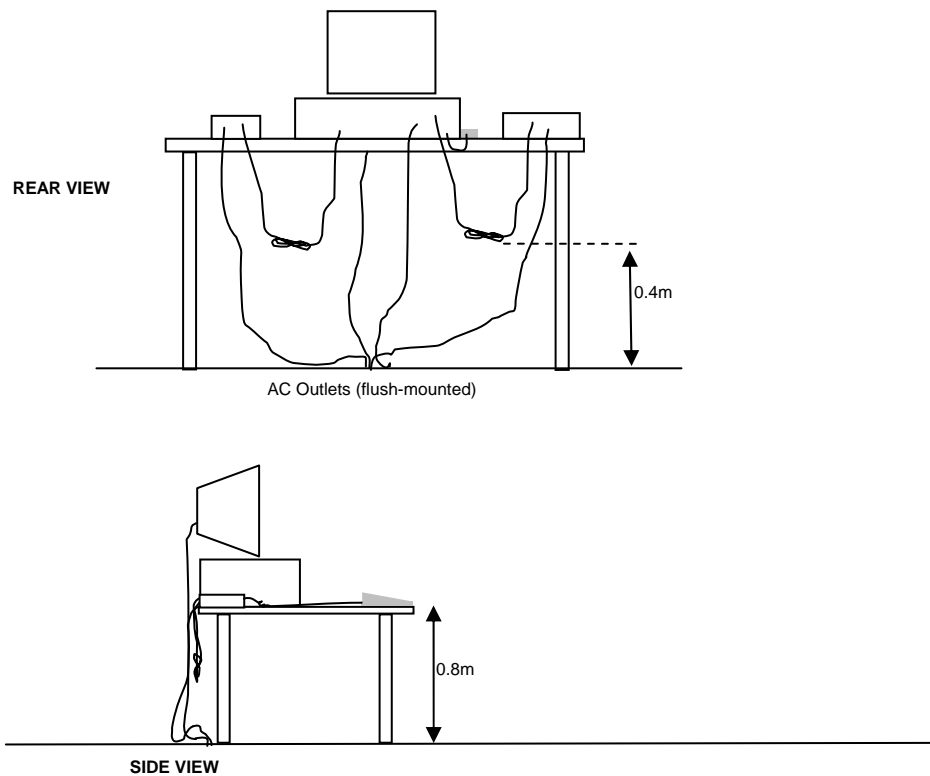

Typical Test Configuration for Radiated Field Strength Measurements

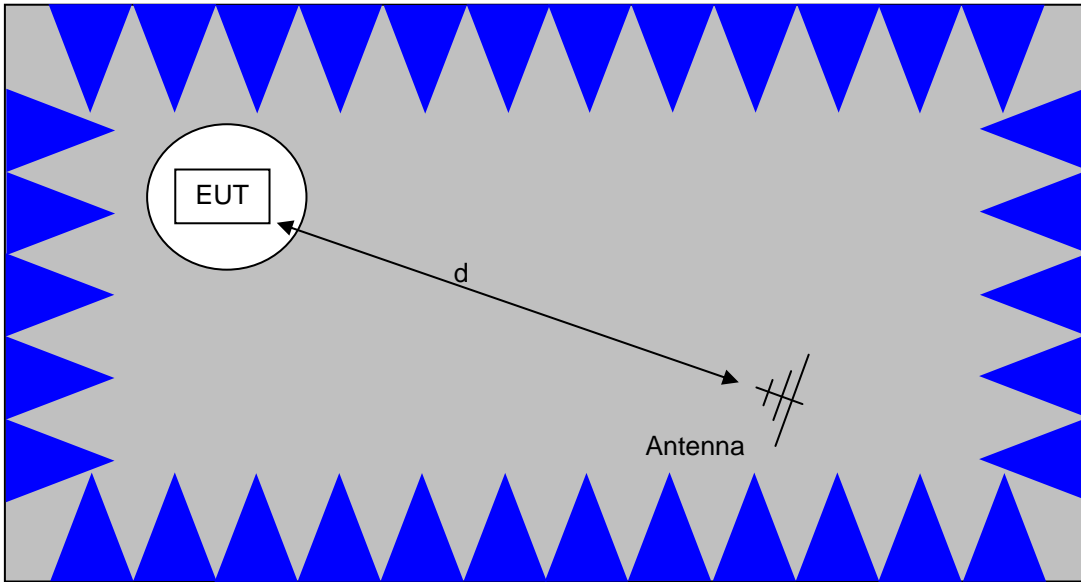

The anechoic materials on the walls and ceiling ensure compliance with the normalized site attenuation requirements of CISPR 16 / CISPR 22 / ANSI C63.4 for an alternate test site at the measurement distances used.

Floor-standing equipment is placed on the floor with insulating supports between the unit and the ground plane.

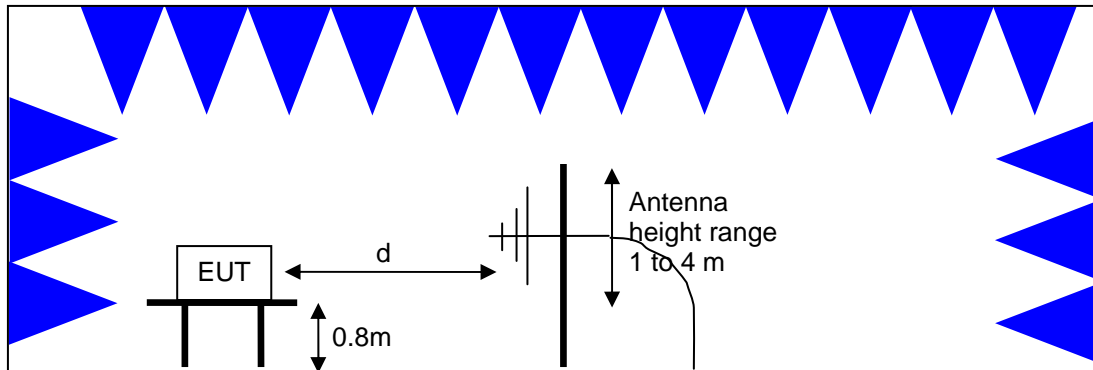

Test Configuration for Radiated Field Strength Measurements
Semi-Anechoic Chamber, Plan and Side Views

CONDUCTED EMISSIONS FROM ANTENNA PORT

Direct measurements of power, bandwidth and power spectral density are performed, where possible, with the antenna port of the EUT connected to either the power meter or spectrum analyzer via a suitable attenuator and/or filter. These are used to ensure that the front end of the measurement instrument is not overloaded by the fundamental transmission.

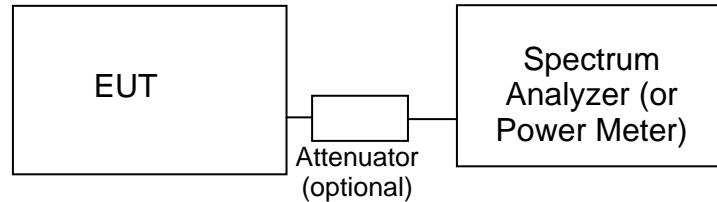
**Test Configuration for Antenna Port Measurements**

Measurement bandwidths (video and resolution) are set in accordance with the relevant standards and NTS Silicon Valley's test procedures for the type of radio being tested. When power measurements are made using a resolution bandwidth less than the signal bandwidth the power is calculated by summing the power across the signal bandwidth using either the analyzer channel power function or by capturing the trace data and calculating the power using software. In both cases the summed power is corrected to account for the equivalent noise bandwidth (ENBW) of the resolution bandwidth used.

If power averaging is used (typically for certain digital modulation techniques), the EUT is configured to transmit continuously. Power averaging is performed using either the built-in function of the analyzer or, if the analyzer does not feature power averaging, using external software. In both cases the average power is calculated over a number of sweeps (typically 100). When the EUT cannot be configured to continuously transmit then either the analyzer is configured to perform a gated sweep to ensure that the power is averaged over periods that the device is transmitting or power averaging is disabled and a max-hold feature is used.

If a power meter is used to make output power measurements the sensor head type (peak or average) is stated in the test data table.

BANDWIDTH MEASUREMENTS

The 6dB, 20dB and/or 26dB signal bandwidth is measured in using the bandwidths recommended by ANSI C63.4. When required, the 99% bandwidth is measured using the methods detailed in RSS GEN.

SPECIFICATION LIMITS AND SAMPLE CALCULATIONS

The limits for conducted emissions are given in units of microvolts, and the limits for radiated emissions are given in units of microvolts per meter at a specified test distance. Data is measured in the logarithmic form of decibels relative to one microvolt, or dB microvolts (dBuV). For radiated emissions, the measured data is converted to the field strength at the antenna in dB microvolts per meter (dBuV/m). The results are then converted to the linear forms of uV and uV/m for comparison to published specifications.

For reference, converting the specification limits from linear to decibel form is accomplished by taking the base ten logarithm, then multiplying by 20. These limits in both linear and logarithmic form are as follows:

CONDUCTED EMISSIONS SPECIFICATION LIMITS: FCC 15.207; FCC 15.107(a), RSS GEN

The table below shows the limits for the emissions on the AC power line from an intentional radiator and a receiver.

Frequency (MHz)	Average Limit (dBuV)	Quasi Peak Limit (dBuV)
0.150 to 0.500	Linear decrease on logarithmic frequency axis between 56.0 and 46.0	Linear decrease on logarithmic frequency axis between 66.0 and 56.0
0.500 to 5.000	46.0	56.0
5.000 to 30.000	50.0	60.0

GENERAL TRANSMITTER RADIATED EMISSIONS SPECIFICATION LIMITS

The table below shows the limits for the spurious emissions from transmitters that fall in restricted bands¹ (with the exception of transmitters operating under FCC Part 15 Subpart D and RSS 210 Annex 9), the limits for all emissions from a low power device operating under the general rules of RSS 310 (tables 3 and 4), RSS 210 (table 2) and FCC Part 15 Subpart C section 15.209.

Frequency Range (MHz)	Limit (uV/m)	Limit (dBuV/m @ 3m)
0.009-0.490	2400/F _{KHz} @ 300m	67.6-20*log ₁₀ (F _{KHz}) @ 300m
0.490-1.705	24000/F _{KHz} @ 30m	87.6-20*log ₁₀ (F _{KHz}) @ 30m
1.705 to 30	30 @ 30m	29.5 @ 30m
30 to 88	100 @ 3m	40 @ 3m
88 to 216	150 @ 3m	43.5 @ 3m
216 to 960	200 @ 3m	46.0 @ 3m
Above 960	500 @ 3m	54.0 @ 3m

RECEIVER RADIATED SPURIOUS EMISSIONS SPECIFICATION LIMITS

The table below shows the limits for the spurious emissions from receivers as detailed in FCC Part 15.109, RSS 210 Table 2, RSS GEN Table 1 and RSS 310 Table 3. Note that receivers operating outside of the frequency range 30 MHz – 960 MHz are exempt from the requirements of 15.109.

Frequency Range (MHz)	Limit (uV/m @ 3m)	Limit (dBuV/m @ 3m)
30 to 88	100	40
88 to 216	150	43.5
216 to 960	200	46.0
Above 960	500	54.0

¹ The restricted bands are detailed in FCC 15.203, RSS 210 Table 1 and RSS 310 Table 2

OUTPUT POWER LIMITS – DIGITAL TRANSMISSION SYSTEMS

The table below shows the limits for output power and output power density. Where the signal bandwidth is less than 20 MHz the maximum output power is reduced to the power spectral density limit plus 10 times the log of the bandwidth (in MHz).

Operating Frequency (MHz)	Output Power	Power Spectral Density
902 – 928	1 Watt (30 dBm)	8 dBm/3kHz
2400 – 2483.5	1 Watt (30 dBm)	8 dBm/3kHz
5725 – 5850	1 Watt (30 dBm)	8 dBm/3kHz

The maximum permitted output power is reduced by 1dB for every dB the antenna gain exceeds 6dBi. Fixed point-to-point applications using the 5725 – 5850 MHz band are not subject to this restriction.

TRANSMIT MODE SPURIOUS RADIATED EMISSIONS LIMITS – FHSS and DTS SYSTEMS

The limits for unwanted (spurious) emissions from the transmitter falling in the restricted bands are those specified in the general limits sections of FCC Part 15 and RSS 210. All other unwanted (spurious) emissions shall be at least 20dB below the level of the highest in-band signal level (30dB if the power is measured using the sample detector/power averaging method).

SAMPLE CALCULATIONS - CONDUCTED EMISSIONS

Receiver readings are compared directly to the conducted emissions specification limit (decibel form) as follows:

$$R_r - S = M$$

where:

R_r = Receiver Reading in dBuV

S = Specification Limit in dBuV

M = Margin to Specification in +/- dB

SAMPLE CALCULATIONS - RADIATED EMISSIONS

Receiver readings are compared directly to the specification limit (decibel form). The receiver internally corrects for cable loss, preamplifier gain, and antenna factor. The calculations are in the reverse direction of the actual signal flow, thus cable loss is added and the amplifier gain is subtracted. The Antenna Factor converts the voltage at the antenna coaxial connector to the field strength at the antenna elements.

A distance factor, when used for electric field measurements above 30MHz, is calculated by using the following formula:

$$F_d = 20 * \text{LOG}_{10} (D_m/D_s)$$

where:

$$F_d = \text{Distance Factor in dB}$$

$$D_m = \text{Measurement Distance in meters}$$

$$D_s = \text{Specification Distance in meters}$$

For electric field measurements below 30MHz the extrapolation factor is either determined by making measurements at multiple distances or a theoretical value is calculated using the formula:

$$F_d = 40 * \text{LOG}_{10} (D_m/D_s)$$

Measurement Distance is the distance at which the measurements were taken and Specification Distance is the distance at which the specification limits are based. The antenna factor converts the voltage at the antenna coaxial connector to the field strength at the antenna elements.

The margin of a given emission peak relative to the limit is calculated as follows:

$$R_c = R_r + F_d$$

and

$$M = R_c - L_s$$

where:

$$R_r = \text{Receiver Reading in dBuV/m}$$

$$F_d = \text{Distance Factor in dB}$$

$$R_c = \text{Corrected Reading in dBuV/m}$$

$$L_s = \text{Specification Limit in dBuV/m}$$

$$M = \text{Margin in dB Relative to Spec}$$

SAMPLE CALCULATIONS - FIELD STRENGTH TO EIRP CONVERSION

Where the radiated electric field strength is expressed in terms of the equivalent isotropic radiated power (eirp), or where a field strength measurement of output power is made in lieu of a direct measurement, the following formula is used to convert between eirp and field strength at a distance of d (meters) from the equipment under test:

$$E = \frac{1000000 \sqrt{30 P}}{d} \quad \text{microvolts per meter}$$

where P is the eirp (Watts)

For a measurement at 3m the conversion from a logarithmic value for field strength (dBuV/m) to an eirp power (dBm) is -95.3dB.

Appendix A Test Equipment Calibration Data

DTS Bandedges, 13-Jan-12

<u>Manufacturer</u>	<u>Description</u>	<u>Model</u>	<u>Asset #</u>	<u>Cal Due</u>
EMCO	Antenna, Horn, 1-18 GHz	3115	1561	6/22/2012
Rohde & Schwarz	EMI Test Receiver, 20 Hz-7 GHz	ESIB7	1756	4/6/2012

DTS Bandedges, 19-Jan-12

<u>Manufacturer</u>	<u>Description</u>	<u>Model</u>	<u>Asset #</u>	<u>Cal Due</u>
EMCO	Antenna, Horn, 1-18 GHz	3115	1561	6/22/2012
Rohde & Schwarz	EMI Test Receiver, 20 Hz-40 GHz	ESIB40 (1088.7490.40)	2493	12/9/2012

Radiated Emissions, 1000 - 10,000 MHz, 10-Feb-12

<u>Manufacturer</u>	<u>Description</u>	<u>Model</u>	<u>Asset #</u>	<u>Cal Due</u>
Hewlett Packard	Microwave Preamplifier, 1-26.5GHz	8449B	785	5/18/2012
Hewlett Packard	SpecAn 9 kHz - 40 GHz, FT (SA40) Blue	8564E (84125C)	1393	8/9/2012
EMCO	Antenna, Horn, 1-18 GHz	3115	1561	6/22/2012
Micro-Tronics	Band Reject Filter, 2400-2500 MHz	BRM50702-02	2238	10/4/2012

Radiated Spurious Emissions, 1000 - 2,500 MHz, Bandedges, 09-Apr-12

<u>Manufacturer</u>	<u>Description</u>	<u>Model</u>	<u>Asset #</u>	<u>Cal Due</u>
EMCO	Antenna, Horn, 1-18 GHz	3115	487	7/6/2012
Rohde & Schwarz	EMI Test Receiver, 20 Hz-7 GHz	ESIB7	1756	5/6/2012

Radio Antenna Port (Power and Spurious Emissions), 22-May-12

<u>Manufacturer</u>	<u>Description</u>	<u>Model</u>	<u>Asset #</u>	<u>Cal Due</u>
Rohde & Schwarz	EMI Test Receiver, 20 Hz-7 GHz	ESIB7	1538	12/6/2012

Radio Antenna Port (Power and Spurious Emissions), 25-May-12

<u>Manufacturer</u>	<u>Description</u>	<u>Model</u>	<u>Asset #</u>	<u>Cal Due</u>
Hewlett Packard	SpecAn 9 KHz-26.5 GHz, Non-Program	8563E	284	1/13/2013

Conducted Emissions - AC Power Ports, 10-Feb-12

<u>Manufacturer</u>	<u>Description</u>	<u>Model</u>	<u>Asset #</u>	<u>Cal Due</u>
EMCO	LISN, 10 kHz-100 MHz	3825/2	1293	3/1/2012
Rohde & Schwarz	Pulse Limiter	ESH3 Z2	1398	1/26/2013
Rohde & Schwarz	EMI Test Receiver, 20 Hz-7 GHz	ESIB7	1538	12/6/2012
Fischer Custom Comm.	Decoupling Network, 100KHz - 1GHz	F-203I-DCN	1567	N/A

Appendix B Test Data

T85772 Pages 25 – 63

T85773 Pages 64 – 71



EMC Test Data

Client:	Ubiquiti Networks	Job Number:	J85169
Model:	mPort-S (Serial Port Version)	T-Log Number:	T85772
		Account Manager:	Susan Pelzl
Contact:	Jennifer Sanchez		-
Emissions Standard(s):	FCC 15.247/EN 300 328	Class:	-
Immunity Standard(s):	-	Environment:	-

EMC Test Data

For The

Ubiquiti Networks

Model

mPort-S (Serial Port Version)

Date of Last Test: 6/11/2012



EMC Test Data

Client: Ubiquiti Networks	Job Number: J85169
Model: mPort-S (Serial Port Version)	T-Log Number: T85772
	Account Manager: Susan Pelzl
Contact: Jennifer Sanchez	
Standard: FCC 15.247/EN 300 328	Class: N/A

RSS 210 and FCC 15.247 (DTS) Radiated Spurious Emissions

Test Specific Details

Objective: The objective of this test session is to perform final qualification testing of the EUT with respect to the specification listed above.

General Test Configuration

The EUT and all local support equipment were located on the turntable for radiated spurious emissions testing. All remote support equipment was located outside the chamber, with all I/O connections running under the groundplane through metal conduit.

For radiated emissions testing the measurement antenna was located 3 meters from the EUT.

Ambient Conditions: Temperature: 13-17 °C
 Rel. Humidity: 30-40 %

Summary of Results - Device Operating in the 2400-2483.5 MHz Band

Run #	Mode	Channel	Power Setting	Measured Power	Test Performed	Limit	Result / Margin
1	802.11g Chain Int	#1 2412MHz	10.0	-	Restricted Band Edge at 2390 MHz	15.209	53.8dBµV/m @ 2390.0MHz (-0.2dB)
		#11 2462MHz	8.0	-	Restricted Band Edge at 2483.5 MHz	15.209	52.1dBµV/m @ 2483.5MHz (-1.9dB)
2	802.11n20 Chain Int	#1 2412MHz	8.5	-	Restricted Band Edge at 2390 MHz	15.209	53.4dBµV/m @ 2390.0MHz (-0.6dB)
		#11 2462MHz	7.5	-	Restricted Band Edge at 2483.5 MHz	15.209	52.7dBµV/m @ 2483.5MHz (-1.3dB)

Modifications Made During Testing

No modifications were made to the EUT during testing

Deviations From The Standard

No deviations were made from the requirements of the standard.

Notes

Preliminary testing showed horizontal polarity was the worse case.



EMC Test Data

Client: Ubiquiti Networks	Job Number: J85169
Model: mPort-S (Serial Port Version)	T-Log Number: T85772
	Account Manager: Susan Pelzl
Contact: Jennifer Sanchez	
Standard: FCC 15.247/EN 300 328	Class: N/A

Run # 1, Band Edge Field Strength - 802.11g, Chain Int

Date of Test: 1/13/2012

Test Location: FT7

Test Engineer: John Caizzi

Config Change: none

Run # 1a, EUT on Channel #1 2412MHz - 802.11g, Chain Int

	Target (dBm)	Power Settings Measured (dBm)	Software Setting
Chain Int			10.0

2390 MHz Band Edge Signal Field Strength

Frequency	Level	Pol	15.209 / 15.247		Detector	Azimuth	Height	Comments
MHz	dB μ V/m	v/h	Limit	Margin	Pk/QP/Avg	degrees	meters	
2390.000	53.8	H	54.0	-0.2	AVG	110	1.21	Setting = 10
2389.200	70.5	H	74.0	-3.5	PK	110	1.21	Setting = 10

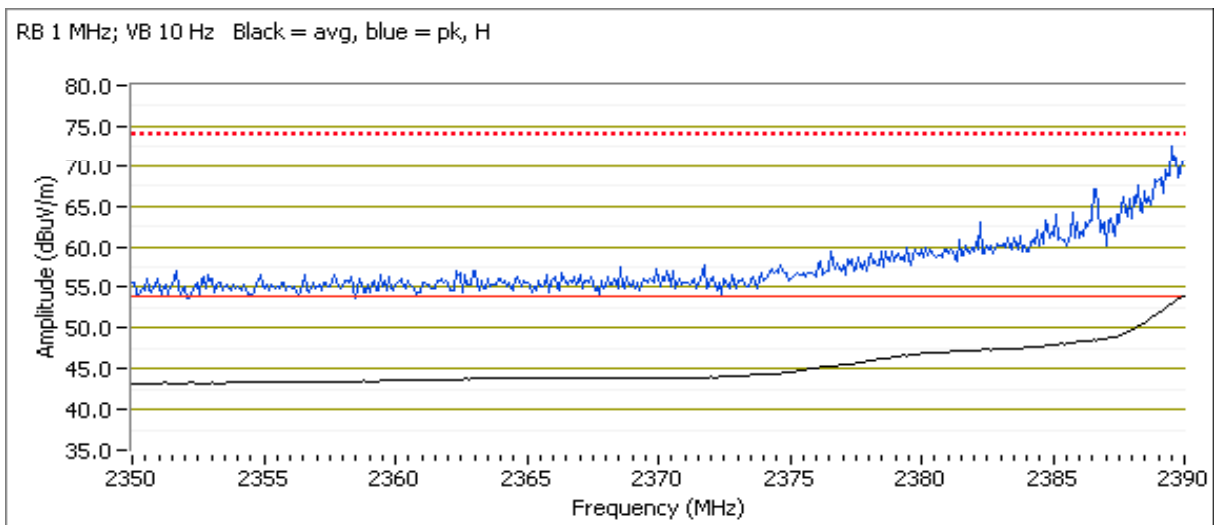



EMC Test Data

Client: Ubiquiti Networks	Job Number: J85169
Model: mPort-S (Serial Port Version)	T-Log Number: T85772
Contact: Jennifer Sanchez	Account Manager: Susan Pelzl
Standard: FCC 15.247/EN 300 328	Class: N/A

Run # 1b, EUT on Channel #11 2462MHz - 802.11g, Chain Int

	Target (dBm)	Power Settings Measured (dBm)	Software Setting
Chain Int			8.0

2483.5 MHz Band Edge Signal Radiated Field Strength

Frequency	Level	Pol	15.209 / 15.247		Detector	Azimuth	Height	Comments
MHz	dB μ V/m	v/h	Limit	Margin	PK/QP/Avg	degrees	meters	
2483.500	52.1	H	54.0	-1.9	AVG	100	1.16	Setting = 8
2484.000	71.6	H	74.0	-2.4	PK	100	1.16	Setting = 8

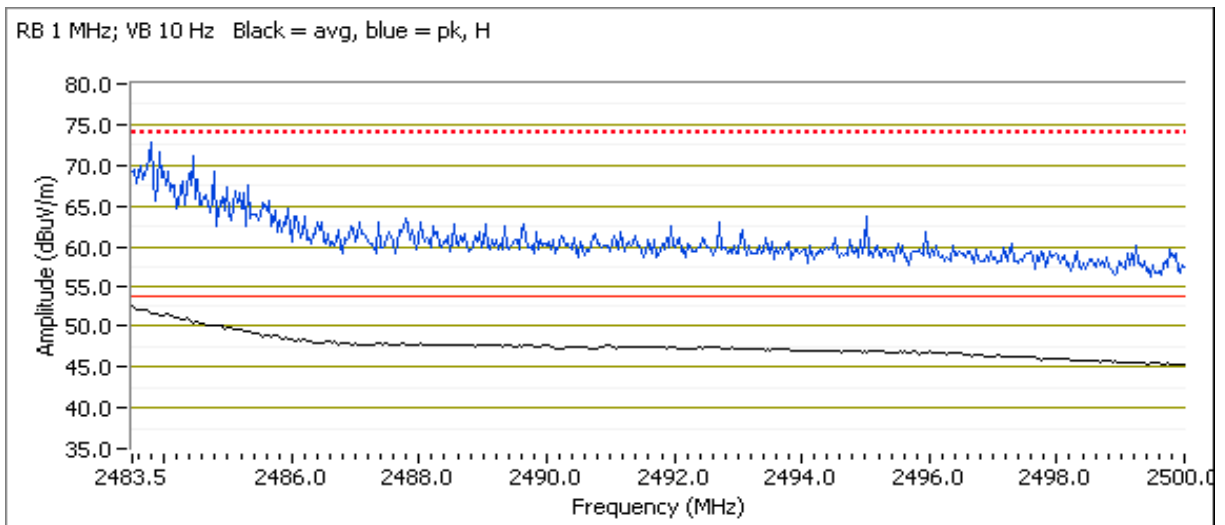



EMC Test Data

Client: Ubiquiti Networks	Job Number: J85169
Model: mPort-S (Serial Port Version)	T-Log Number: T85772
	Account Manager: Susan Pelzl
Contact: Jennifer Sanchez	
Standard: FCC 15.247/EN 300 328	Class: N/A

Run # 2, Band Edge Field Strength - 802.11n20, Chain Int

Date of Test: 1/13/2012
 Test Engineer: John Caizzi

Test Location: FT7
 Config Change: none

Run # 2a, EUT on Channel #1 2412MHz - 802.11n20, Chain Int

	Target (dBm)	Power Settings Measured (dBm)	Software Setting
Chain Int			8.5

2390 MHz Band Edge Signal Field Strength

Frequency	Level	Pol	15.209 / 15.247		Detector	Azimuth	Height	Comments
MHz	dB μ V/m	v/h	Limit	Margin	Pk/QP/Avg	degrees	meters	
2390.000	53.4	H	54.0	-0.6	AVG	107	1.25	Setting = 8.5
2389.920	69.9	H	74.0	-4.1	PK	107	1.25	Setting = 8.5

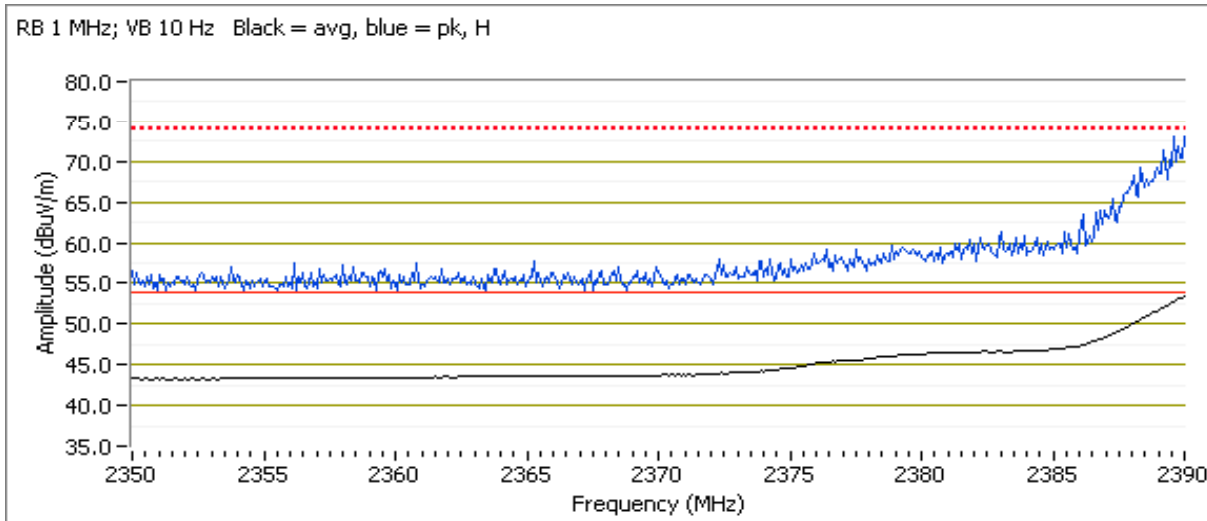



EMC Test Data

Client: Ubiquiti Networks	Job Number: J85169
Model: mPort-S (Serial Port Version)	T-Log Number: T85772
	Account Manager: Susan Pelzl
Contact: Jennifer Sanchez	
Standard: FCC 15.247/EN 300 328	Class: N/A

Run # 2b, EUT on Channel #11 2462MHz - 802.1120, Chain Int

	Target (dBm)	Power Settings Measured (dBm)	Software Setting
Chain Int			7.5

2483.5 MHz Band Edge Signal Radiated Field Strength

Frequency	Level	Pol	15.209 / 15.247		Detector	Azimuth	Height	Comments
MHz	dB μ V/m	v/h	Limit	Margin	PK/QP/Avg	degrees	meters	
2483.500	52.7	H	54.0	-1.3	AVG	101	1.16	Setting = 7.5
2483.570	70.0	H	74.0	-4.0	PK	101	1.16	Setting = 7.5

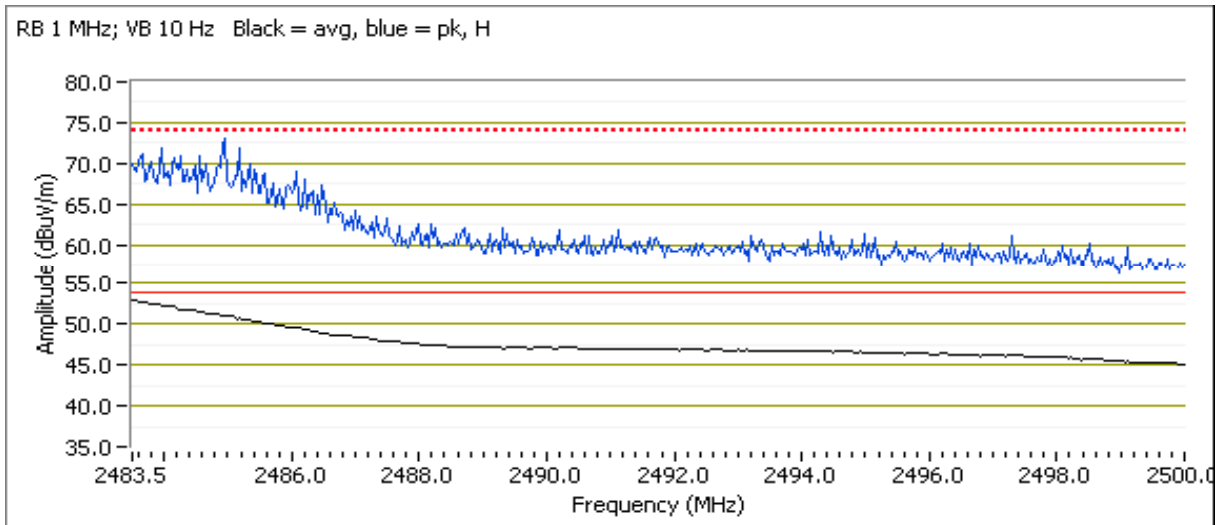



EMC Test Data

Client:	Ubiquiti Networks	Job Number:	J85169
Model:	mPort-S (Serial Port Version)	T-Log Number:	T85772
		Account Manager:	Susan Pelzl
Contact:	Jennifer Sanchez		
Standard:	FCC 15.247/EN 300 328	Class:	N/A

RSS 210 and FCC 15.247 (DTS) Radiated Spurious Emissions

Test Specific Details

Objective: The objective of this test session is to perform final qualification testing of the EUT with respect to the specification listed above.

General Test Configuration

The EUT and all local support equipment were located on the turntable for radiated spurious emissions testing. All remote support equipment was located approximately 30 meters from the EUT with all I/O connections running on top of the groundplane or routed in overhead in the GR-1089 test configuration.

For radiated emissions testing the measurement antenna was located 3 meters from the EUT.

Ambient Conditions:

Temperature: 22 °C
Rel. Humidity: 35 %

Summary of Results - Device Operating in the 2400-2483.5 MHz Band

Run #	Mode	Channel	Power Setting	Measured Power	Test Performed	Limit	Result / Margin
Run # 1	802.11g Chain Int	#1 2412MHz	10.0	-	Radiated Emissions, 1 - 26 GHz	FCC 15.209 / 15.247	51.6 dBµV/m @ 4824.5 MHz (-2.4 dB)
		#6 2437MHz	11.0	-			52.4 dBµV/m @ 4873.4 MHz (-1.6 dB)
		#11 2462MHz	8.0	-			46.4 dBµV/m @ 4923.9 MHz (-7.6 dB)
Run # 2	802.11n20 Chain Int	#1 2412MHz	8.5	-	Radiated Emissions, 1 - 26 GHz	FCC 15.209 / 15.247	48.1 dBµV/m @ 4824.9 MHz (-5.9 dB)
		#6 2437MHz	10.0	-			53.3 dBµV/m @ 4874.3 MHz (-0.7 dB)
		#11 2462MHz	7.5	-			46.6 dBµV/m @ 4923.6 MHz (-7.4 dB)

Modifications Made During Testing

No modifications were made to the EUT during testing

Deviations From The Standard

No deviations were made from the requirements of the standard.



EMC Test Data

Client: Ubiquiti Networks	Job Number: J85169
Model: mPort-S (Serial Port Version)	T-Log Number: T85772
Contact: Jennifer Sanchez	Account Manager: Susan Pelzl
Standard: FCC 15.247/EN 300 328	Class: N/A

Notes

No radio related emissions were observed below 1GHz

Run # 1, Radiated Spurious Emissions, 1-26GHz, 802.11g, Chain Int

Date of Test: 2/10/2012

Test Location: FT7

Test Engineer: Jack Liu

Config Change: None

Run # 1a, EUT on Channel #1 2412MHz - 802.11g, Chain Int

	Target (dBm)	Power Settings Measured (dBm)	Software Setting
Chain Int			10.0

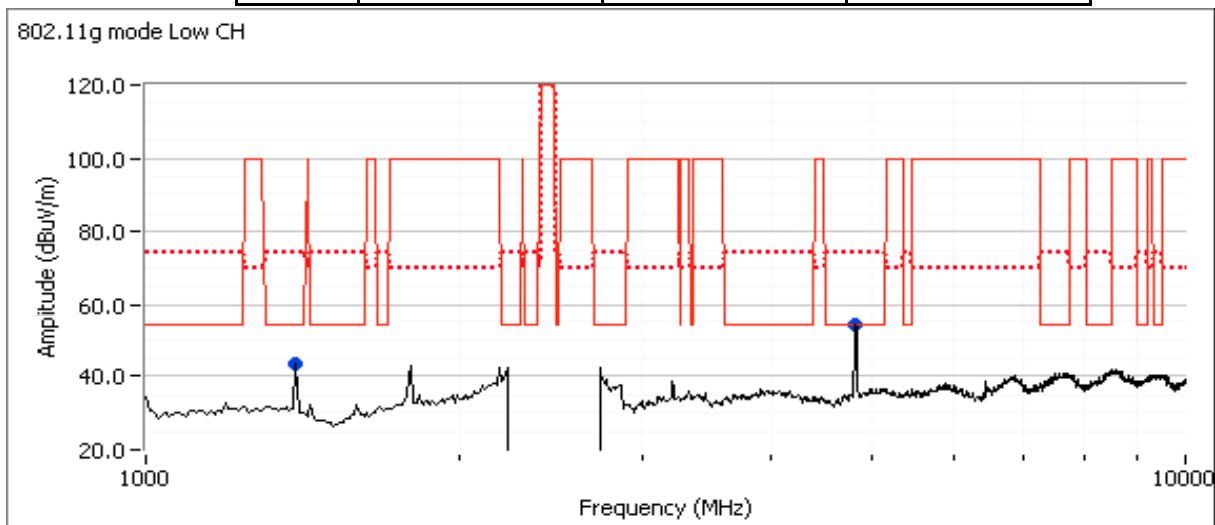

Spurious Radiated Emissions:

Frequency	Level	Pol	15.209/15.247		Detector	Azimuth	Height	Comments
MHz	dBuV/m	v/h	Limit	Margin	PK/QP/Avg	degrees	meters	
4824.460	51.6	V	54.0	-2.4	AVG	25	1.0	
1400.290	44.4	V	54.0	-9.6	AVG	359	1.3	
4827.200	64.1	V	74.0	-9.9	PK	25	1.0	
1400.190	46.4	V	74.0	-27.6	PK	359	1.3	

Note 1: For emissions in restricted bands, the limit of 15.209 was used. For all other emissions, the limit is -30dBc for peak measurements in a measurement bandwidth of 100kHz.

Note 2: Scans made between 18 - 25GHz with the measurement antenna moved around the card and its antennas 20-50cm from the device indicated there were no significant emissions in this frequency range



EMC Test Data

Client: Ubiquiti Networks	Job Number: J85169
Model: mPort-S (Serial Port Version)	T-Log Number: T85772
	Account Manager: Susan Pelzl
Contact: Jennifer Sanchez	
Standard: FCC 15.247/EN 300 328	Class: N/A

Run # 1b: , EUT on Channel #6 2437MHz - 802.11g, Chain Int

	Target (dBm)	Power Settings Measured (dBm)	Software Setting
Chain Int			11.0

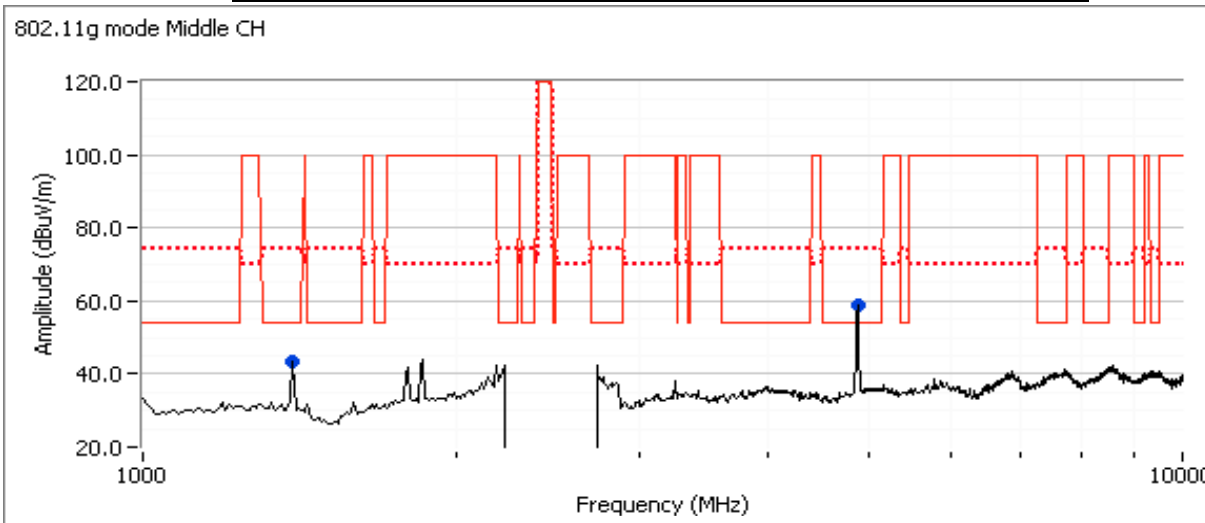

Spurious Radiated Emissions:

Frequency	Level	Pol	15.209/15.247		Detector	Azimuth	Height	Comments
MHz	dBuV/m	v/h	Limit	Margin	Pk/QP/Avg	degrees	meters	
4873.360	52.4	V	54.0	-1.6	AVG	13	1.0	
4876.400	65.0	V	74.0	-9.0	PK	13	1.0	
1400.050	43.5	V	54.0	-10.5	AVG	0	1.3	
1400.120	45.9	V	74.0	-28.1	PK	0	1.3	

Note 1:	For emissions in restricted bands, the limit of 15.209 was used. For all other emissions, the limit is -30dBc for peak measurements in a measurement bandwidth of 100kHz.
Note 2:	Scans made between 18 - 25GHz with the measurement antenna moved around the card and its antennas 20-50cm from the device indicated there were no significant emissions in this frequency range



EMC Test Data

Client: Ubiquiti Networks	Job Number: J85169
Model: mPort-S (Serial Port Version)	T-Log Number: T85772
	Account Manager: Susan Pelzl
Contact: Jennifer Sanchez	
Standard: FCC 15.247/EN 300 328	Class: N/A

Run # 1c : EUT on Channel #11 2462MHz - 802.11g, Chain Int

	Target (dBm)	Power Settings Measured (dBm)	Software Setting
Chain Int			8.0

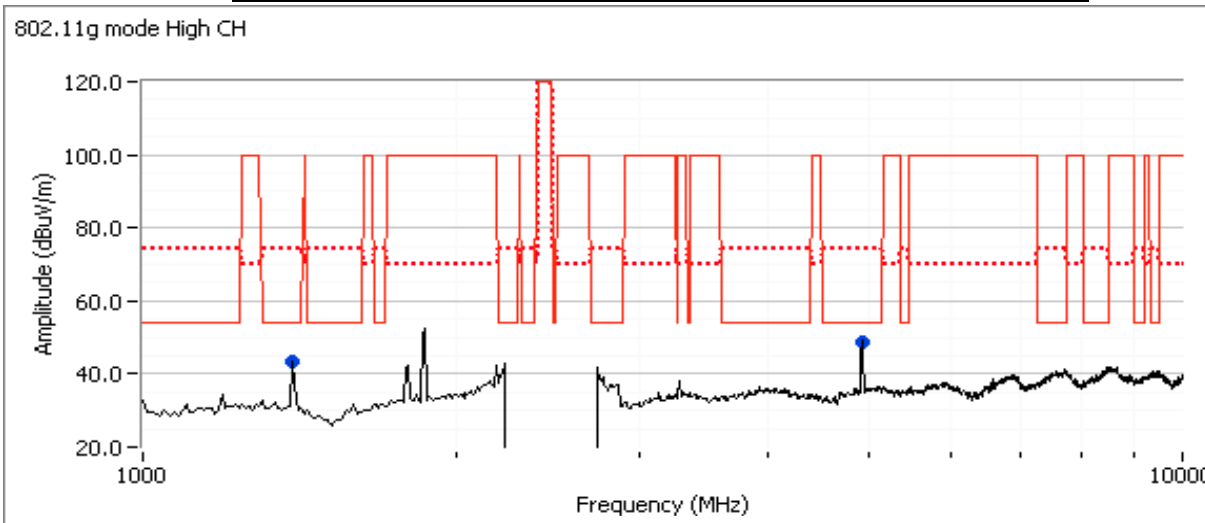

Spurious Radiated Emissions:

Frequency	Level	Pol	15.209/15.247		Detector	Azimuth	Height	Comments
MHz	dBuV/m	v/h	Limit	Margin	Pk/QP/Avg	degrees	meters	
4923.930	46.4	V	54.0	-7.6	AVG	25	1.0	
1400.150	44.1	V	54.0	-9.9	AVG	357	1.3	
4922.460	58.8	V	74.0	-15.2	PK	25	1.0	
1400.290	45.8	V	74.0	-28.2	PK	357	1.3	

- Note 1: For emissions in restricted bands, the limit of 15.209 was used. For all other emissions, the limit is -30dBc for peak measurements in a measurement bandwidth of 100kHz.
- Note 2: Scans made between 18 - 25GHz with the measurement antenna moved around the card and its antennas 20-50cm from the device indicated there were no significant emissions in this frequency range



EMC Test Data

Client: Ubiquiti Networks	Job Number: J85169
Model: mPort-S (Serial Port Version)	T-Log Number: T85772
Contact: Jennifer Sanchez	Account Manager: Susan Pelzl
Standard: FCC 15.247/EN 300 328	Class: N/A

Run # 2, Radiated Spurious Emissions, 1-26GHz, 802.11n20, Chain Int

Date of Test: 2/10/2012

Test Location: FT7

Test Engineer: Jack Liu

Config Change: None

Run # 2a, EUT on Channel #1 2412MHz - 802.11n20, Chain Int

	Target (dBm)	Power Settings Measured (dBm)	Software Setting
Chain Int			8.5

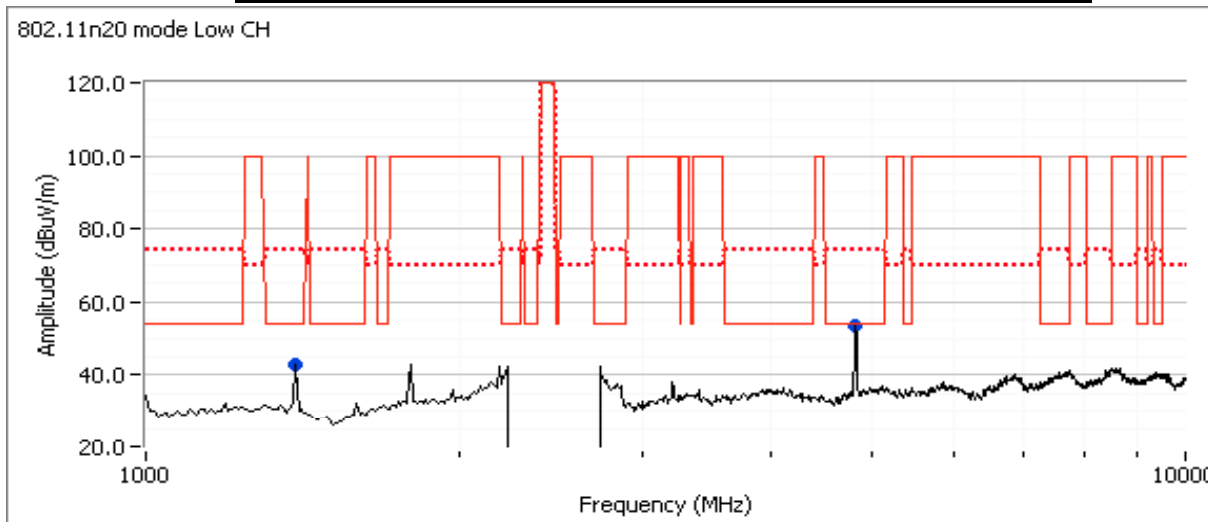

Spurious Radiated Emissions:

Frequency	Level	Pol	15.209/15.247		Detector	Azimuth	Height	Comments
MHz	dBuV/m	v/h	Limit	Margin	Pk/QP/Avg	degrees	meters	
4824.860	48.1	V	54.0	-5.9	AVG	30	1.0	
1400.140	43.5	V	54.0	-10.5	AVG	8	1.3	
4829.060	59.6	V	74.0	-14.4	PK	30	1.0	
1400.170	45.9	V	74.0	-28.1	PK	8	1.3	

- Note 1: For emissions in restricted bands, the limit of 15.209 was used. For all other emissions, the limit is -30dBc for peak measurements in a measurement bandwidth of 100kHz.
- Note 2: Scans made between 18 - 25GHz with the measurement antenna moved around the card and its antennas 20-50cm from the device indicated there were no significant emissions in this frequency range.



EMC Test Data

Client: Ubiquiti Networks	Job Number: J85169
Model: mPort-S (Serial Port Version)	T-Log Number: T85772
	Account Manager: Susan Pelzl
Contact: Jennifer Sanchez	
Standard: FCC 15.247/EN 300 328	Class: N/A

Run # 2b: , EUT on Channel #6 2437MHz - 802.11n20, Chain Int

Date of Test: 5/1/2012 Test Location: FT7
 Test Engineer: Peter Sales Config Change: None

	Target (dBm)	Power Settings Measured (dBm)	Software Setting
Chain Int			10.0

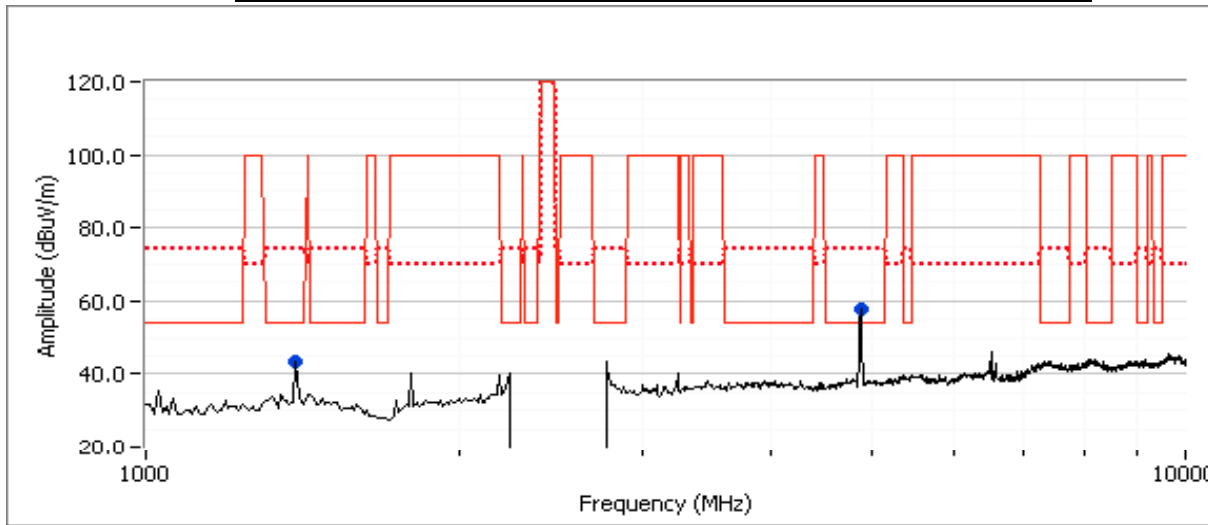

Spurious Radiated Emissions:

Frequency	Level	Pol	15.209/15.247		Detector	Azimuth	Height	Comments
MHz	dBuV/m	v/h	Limit	Margin	Pk/QP/Avg	degrees	meters	
4874.250	53.3	V	54.0	-0.7	AVG	204	1.0	RB 1 MHz;VB 10 Hz;Peak
4873.450	66.2	V	74.0	-7.8	PK	204	1.0	RB 1 MHz;VB 3 MHz;Peak
1400.060	43.7	H	54.0	-10.3	AVG	148	1.4	RB 1 MHz;VB 10 Hz;Peak
1400.370	47.4	H	74.0	-26.6	PK	148	1.4	RB 1 MHz;VB 3 MHz;Peak

- Note 1: For emissions in restricted bands, the limit of 15.209 was used. For all other emissions, the limit is -30dBc for peak measurements in a measurement bandwidth of 100kHz.
- Note 2: Scans made between 18 - 25GHz with the measurement antenna moved around the card and its antennas 20-50cm from the device indicated there were no significant emissions in this frequency range



EMC Test Data

Client: Ubiquiti Networks	Job Number: J85169
Model: mPort-S (Serial Port Version)	T-Log Number: T85772
	Account Manager: Susan Pelzl
Contact: Jennifer Sanchez	
Standard: FCC 15.247/EN 300 328	Class: N/A

Run # 2c: , EUT on Channel #11 2462MHz - 802.11n20, Chain Int

Date of Test: 5/1/2012

Test Location: FT7

Test Engineer: Peter Sales

Config Change: None

	Target (dBm)	Power Settings Measured (dBm)	Software Setting
Chain Int			7.5

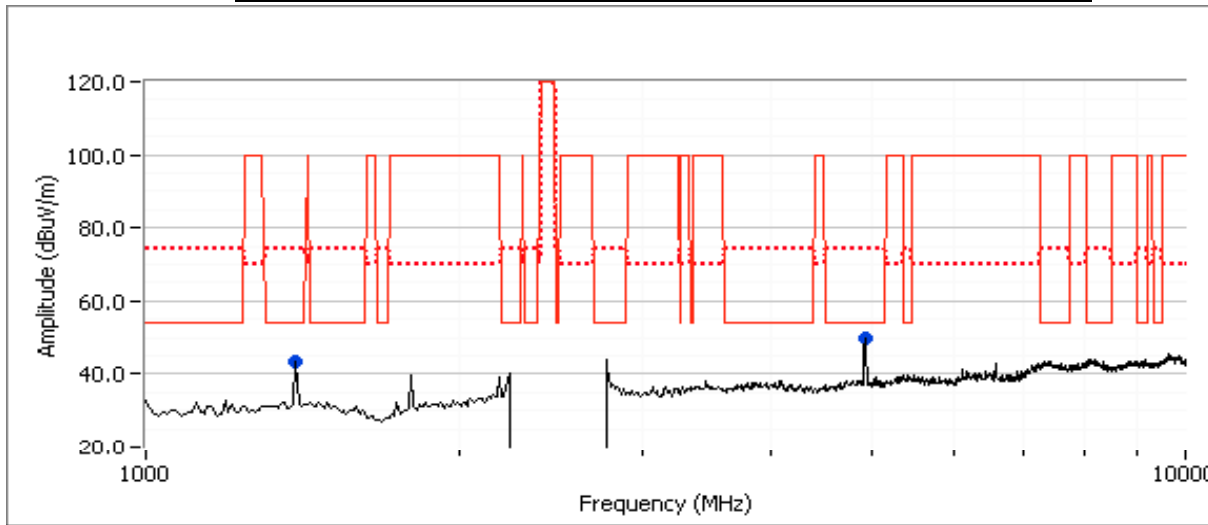

Spurious Radiated Emissions:

Frequency	Level	Pol	15.209/15.247	Detector	Azimuth	Height	Comments	
MHz	dBuV/m	v/h	Limit	Margin	Pk/QP/Avg	degrees	meters	
4923.610	46.6	V	54.0	-7.4	AVG	192	1.6	RB 1 MHz;VB 10 Hz;Peak
1400.130	42.8	H	54.0	-11.2	AVG	250	1.4	RB 1 MHz;VB 10 Hz;Peak
4927.650	60.0	V	74.0	-14.0	PK	192	1.6	RB 1 MHz;VB 3 MHz;Peak
1400.190	46.9	H	74.0	-27.1	PK	250	1.4	RB 1 MHz;VB 3 MHz;Peak

Note 1: For emissions in restricted bands, the limit of 15.209 was used. For all other emissions, the limit is -30dBc for peak measurements in a measurement bandwidth of 100kHz.

Note 2: Scans made between 18 - 25GHz with the measurement antenna moved around the card and its antennas 20-50cm from the device indicated there were no significant emissions in this frequency range



EMC Test Data

Client: Ubiquiti Networks	Job Number: J85169
Model: mPort-S (Serial Port Version)	T-Log Number: T85772
	Account Manager: Susan Pelzl
Contact: Jennifer Sanchez	
Standard: FCC 15.247/EN 300 328	Class: N/A

RSS 210 and FCC 15.247 (DTS) Radiated Spurious Emissions

Test Specific Details

Objective: The objective of this test session is to perform final qualification testing of the EUT with respect to the specification listed above.

General Test Configuration

The EUT and all local support equipment were located on the turntable for radiated spurious emissions testing. All remote support equipment was located outside the chamber, with all I/O connections running under the groundplane through metal conduit.

For radiated emissions testing the measurement antenna was located 3 meters from the EUT.

Ambient Conditions:

Temperature: 13-17 °C
Rel. Humidity: 30-40 %

Summary of Results - Device Operating in the 2400-2483.5 MHz Band

Run #	Mode	Channel	Power Setting	Measured Power	Test Performed	Limit	Result / Margin
1	802.11g Chain Ext	#1 2412MHz	13.0	-	Restricted Band Edge at 2390 MHz	15.209	48.4 dBµV/m @ 2390.0 MHz (-5.6 dB)
		#11 2462MHz	8.0	-	Restricted Band Edge at 2483.5 MHz	15.209	52.4 dBµV/m @ 2483.5 MHz (-1.6 dB)
2	802.11n20 Chain Ext	#1 2412MHz	13.0	-	Restricted Band Edge at 2390 MHz	15.209	52.4 dBµV/m @ 2390.0 MHz (-1.6 dB)
		#11 2462MHz	8.0	-	Restricted Band Edge at 2483.5 MHz	15.209	54.0 dBµV/m @ 2483.6 MHz (0.0 dB)

Modifications Made During Testing

No modifications were made to the EUT during testing

Deviations From The Standard

No deviations were made from the requirements of the standard.

Notes

Preliminary testing showed vertical polarity was the worse case.



EMC Test Data

Client: Ubiquiti Networks	Job Number: J85169
Model: mPort-S (Serial Port Version)	T-Log Number: T85772
	Account Manager: Susan Pelzl
Contact: Jennifer Sanchez	
Standard: FCC 15.247/EN 300 328	Class: N/A

Run #1, Band Edge Field Strength - 802.11g, Chain Ext

Run # 1a, EUT on Channel #1 2412MHz - 802.11g, Chain Ext

Date of Test: 4/2/2012
 Test Engineer: Jack Liu

Test Location: FT7
 Config Change: none

2390 MHz Band Edge Signal Radiated Field Strength

Frequency	Level	Pol	15.209 / 15.247		Detector	Azimuth	Height	Comments
MHz	dB μ V/m	v/h	Limit	Margin	PK/QP/Avg	degrees	meters	
2390.000	48.4	V	54.0	-5.6	AVG	253	1.2	Pwr setting=13
2389.920	61.0	V	74.0	-13.0	PK	253	1.2	Pwr setting=13

Run # 1b, EUT on Channel #11 2462MHz - 802.11g, Chain Ext

Date of Test: 4/2/2012
 Test Engineer: Jack Liu

Test Location: FT7
 Config Change: none

2483.5 MHz Band Edge Signal Radiated Field Strength

Frequency	Level	Pol	15.209 / 15.247		Detector	Azimuth	Height	Comments
MHz	dB μ V/m	v/h	Limit	Margin	PK/QP/Avg	degrees	meters	
2483.500	52.4	V	54.0	-1.6	AVG	36	1.1	Pwr setting=8
2484.000	68.2	V	74.0	-5.8	PK	36	1.1	Pwr setting=8



EMC Test Data

Client: Ubiquiti Networks	Job Number: J85169
Model: mPort-S (Serial Port Version)	T-Log Number: T85772
	Account Manager: Susan Pelzl
Contact: Jennifer Sanchez	
Standard: FCC 15.247/EN 300 328	Class: N/A

Run #2, Band Edge Field Strength - 802.11n20, Chain Ext

Run # 2a, EUT on Channel #1 2412MHz - 802.11n20, Chain Ext

Date of Test: 4/9/2012
 Test Engineer: John Caizzi

Test Location: FT7
 Config Change: none

2390 MHz Band Edge Signal Field Strength (ESI)

Frequency	Level	Pol	15.209 / 15.247		Detector	Azimuth	Height	Comments
MHz	dB μ V/m	v/h	Limit	Margin	Pk/QP/Avg	degrees	meters	
2390.000	52.4	V	54.0	-1.6	AVG	173	1.16	Pwr setting = 13
2389.760	65.6	V	74.0	-8.4	PK	173	1.16	Pwr setting = 13

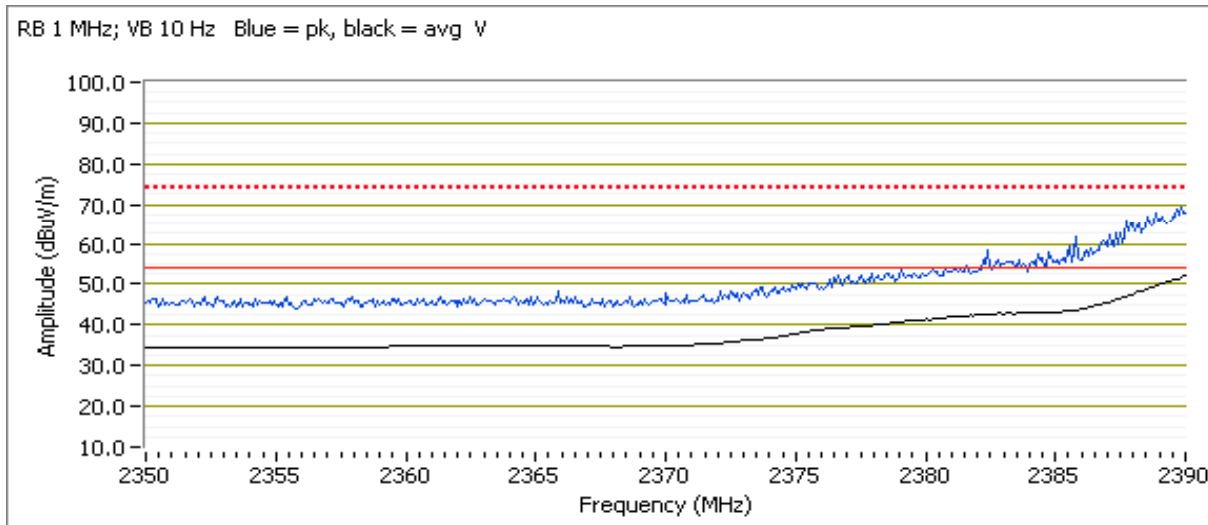



EMC Test Data

Client: Ubiquiti Networks	Job Number: J85169
Model: mPort-S (Serial Port Version)	T-Log Number: T85772
	Account Manager: Susan Pelzl
Contact: Jennifer Sanchez	
Standard: FCC 15.247/EN 300 328	Class: N/A

Run # 2b, EUT on Channel #11 2462MHz - 802.11n20, Chain Ext

Date of Test: 4/9/2012
 Test Engineer: John Caizzi

Test Location: FT7
 Config Change: none

2483.5 MHz Band Edge Radiated Field Strength (ESI)

Frequency	Level	Pol	15.209 / 15.247		Detector	Azimuth	Height	Comments
MHz	dB μ V/m	v/h	Limit	Margin	Pk/QP/Avg	degrees	meters	
2483.570	54.0	V	54.0	0.0	AVG	209	1.12	Pwr setting = 8
2484.590	67.8	V	74.0	-6.2	PK	209	1.12	Pwr setting = 8

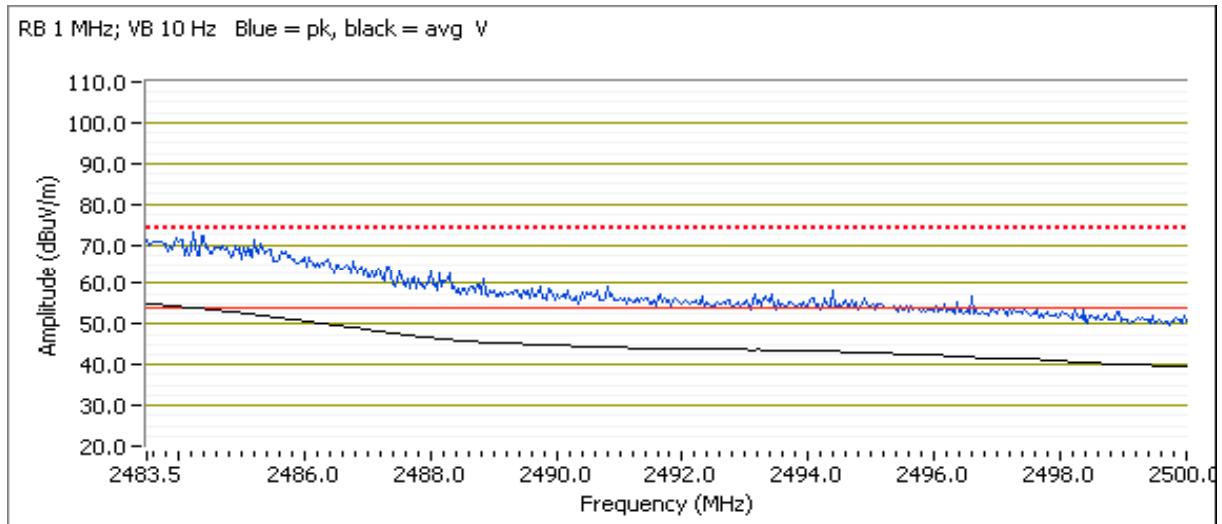



EMC Test Data

Client:	Ubiquiti Networks	Job Number:	J85169
Model:	mPort-S (Serial Port Version)	T-Log Number:	T85772
		Account Manager:	Susan Pelzl
Contact:	Jennifer Sanchez		
Standard:	FCC 15.247/EN 300 328	Class:	N/A

RSS 210 and FCC 15.247 (DTS) Radiated Spurious Emissions

Test Specific Details

Objective: The objective of this test session is to perform final qualification testing of the EUT with respect to the specification listed above.

General Test Configuration

The EUT and all local support equipment were located on the turntable for radiated spurious emissions testing. All remote support equipment was located approximately 30 meters from the EUT with all I/O connections running on top of the groundplane or routed in overhead in the GR-1089 test configuration.

For radiated emissions testing the measurement antenna was located 3 meters from the EUT.

Ambient Conditions:

Temperature: 21 °C
Rel. Humidity: 37 %

Summary of Results - Device Operating in the 2400-2483.5 MHz Band

Run #	Mode	Channel	Power Setting	Measured Power	Test Performed	Limit	Result / Margin
Run # 1	802.11g Chain Ext	#1 2412MHz	8.0	-	Radiated Emissions, 1 - 26 GHz	FCC 15.209 / 15.247	52.7dBµV/m @ 4824.4MHz (-1.3dB)
		#6 2437MHz	8.0	-			53.3dBµV/m @ 4876.9MHz (-0.7dB)
		#11 2462MHz	13.0	-			51.1dBµV/m @ 4921.9MHz (-2.9dB)
Run # 2	802.11n20 Chain Ext	#1 2412MHz	9.0	-	Radiated Emissions, 1 - 26 GHz	FCC 15.209 / 15.247	52.7dBµV/m @ 4823.3MHz (-1.3dB)
		#6 2437MHz	10.0	-			53.2dBµV/m @ 4876.0MHz (-0.8dB)
		#11 2462MHz	8.0	-			51.2dBµV/m @ 4923.2MHz (-2.8dB)

Modifications Made During Testing

No modifications were made to the EUT during testing

Deviations From The Standard

No deviations were made from the requirements of the standard.



EMC Test Data

Client: Ubiquiti Networks	Job Number: J85169
Model: mPort-S (Serial Port Version)	T-Log Number: T85772
Contact: Jennifer Sanchez	Account Manager: Susan Pelzl
Standard: FCC 15.247/EN 300 328	Class: N/A

Notes

No radio related emissions were observed below 1GHz

Run # 1, Radiated Spurious Emissions, 1-26GHz, 802.11g, Chain Ext

Date of Test: 4/11/2012

Test Location: FT4

Test Engineer: Peter Sales

Config Change: None

Run # 1a, EUT on Channel #1 2412MHz - 802.11g, Chain Ext

	Target (dBm)	Power Settings Measured (dBm)	Software Setting
Chain Ext		-	8.0

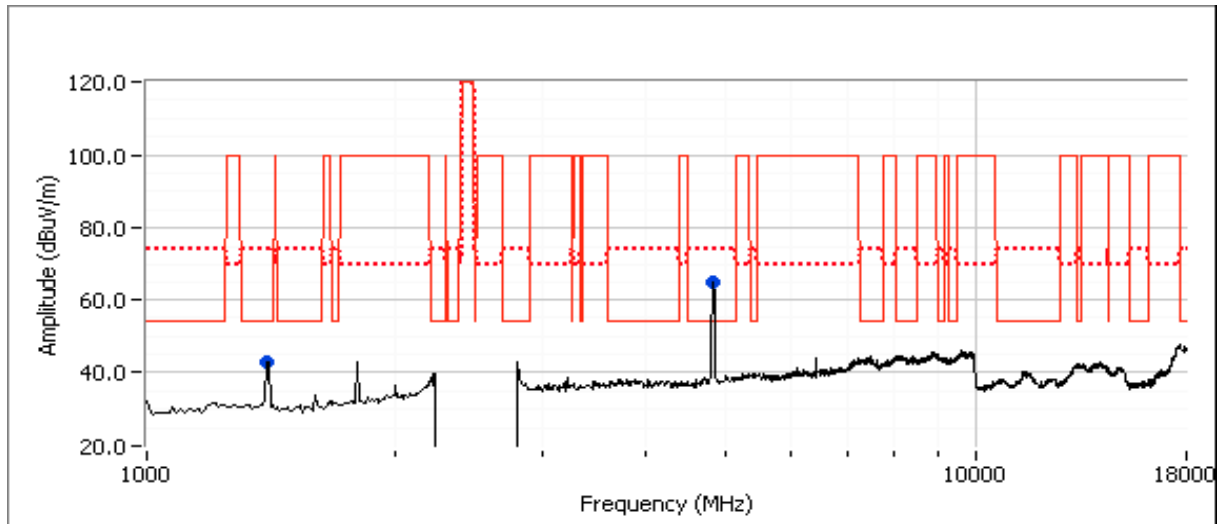

Spurious Radiated Emissions:

Frequency	Level	Pol	15.209/15.247		Detector	Azimuth	Height	Comments
MHz	dBuV/m	v/h	Limit	Margin	PK/QP/Avg	degrees	meters	
4824.420	52.7	V	54.0	-1.3	AVG	206	1.1	Power 8
4823.220	66.2	V	74.0	-7.8	PK	206	1.1	Power 8
1399.990	43.7	V	54.0	-10.3	AVG	125	1.2	Power 8
1400.240	47.1	V	74.0	-26.9	PK	125	1.2	Power 8
Note 1:	For emissions in restricted bands, the limit of 15.209 was used. For all other emissions, the limit is -30dBc for peak measurements in a measurement bandwidth of 100kHz.							
Note 2:	Scans made between 18 - 25GHz with the measurement antenna moved around the card and its antennas 20-50cm from the device indicated there were no significant emissions in this frequency range							

Client: Ubiquiti Networks	Job Number: J85169
Model: mPort-S (Serial Port Version)	T-Log Number: T85772
	Account Manager: Susan Pelzl
Contact: Jennifer Sanchez	
Standard: FCC 15.247/EN 300 328	Class: N/A

Run # 1b: , EUT on Channel #6 2437MHz - 802.11g, Chain Ext

	Target (dBm)	Power Settings Measured (dBm)	Software Setting
Chain Ext		-	8.0

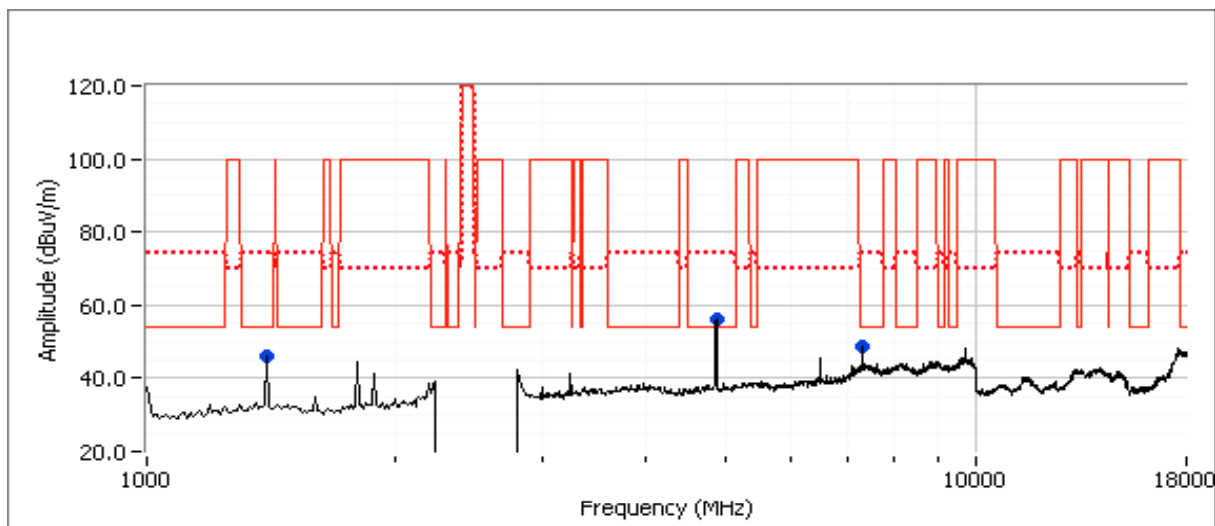

Spurious Radiated Emissions:

Frequency	Level	Pol	15.209/15.247		Detector	Azimuth	Height	Comments
MHz	dBuV/m	v/h	Limit	Margin	Pk/QP/Avg	degrees	meters	
1400.110	44.3	H	54.0	-9.7	AVG	178	1.0	RB 1 MHz;VB 10 Hz;Pk
1400.110	47.6	H	74.0	-26.4	PK	178	1.0	RB 1 MHz;VB 3 MHz;Pk
7312.530	38.5	H	54.0	-15.5	AVG	338	1.9	RB 1 MHz;VB 10 Hz;Pk
7317.030	50.0	H	74.0	-24.0	PK	338	1.9	RB 1 MHz;VB 3 MHz;Pk
4876.980	53.3	V	54.0	-0.7	AVG	216	1.3	RB 1 MHz;VB 10 Hz;Pk
4879.170	67.3	V	74.0	-6.7	PK	216	1.3	RB 1 MHz;VB 3 MHz;Pk

Note 1:	For emissions in restricted bands, the limit of 15.209 was used. For all other emissions, the limit is -30dBc for peak measurements in a measurement bandwidth of 100kHz.
Note 2:	Scans made between 18 - 25GHz with the measurement antenna moved around the card and its antennas 20-50cm from the device indicated there were no significant emissions in this frequency range



EMC Test Data

Client: Ubiquiti Networks	Job Number: J85169
Model: mPort-S (Serial Port Version)	T-Log Number: T85772
Contact: Jennifer Sanchez	Account Manager: Susan Pelzl
Standard: FCC 15.247/EN 300 328	Class: N/A

Run # 1c : EUT on Channel #11 2462MHz - 802.11g, Chain Ext

	Target (dBm)	Power Settings Measured (dBm)	Software Setting
Chain Ext		-	13.0

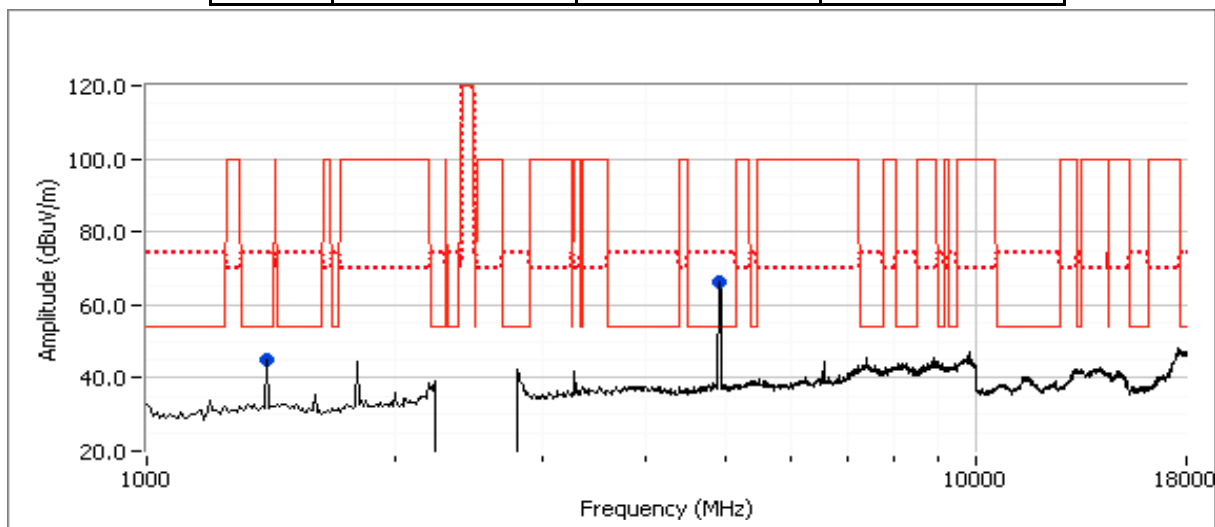

Spurious Radiated Emissions:

Frequency	Level	Pol	15.209/15.247		Detector	Azimuth	Height	Comments
MHz	dBuV/m	v/h	Limit	Margin	Pk/QP/Avg	degrees	meters	
4921.960	51.1	V	54.0	-2.9	AVG	196	1.6	Power 8
4923.040	46.5	V	74.0	-27.5	PK	196	1.6	Power 8
1400.060	44.9	H	54.0	-9.1	AVG	191	1.9	Power 8
1400.160	48.6	H	74.0	-25.4	PK	191	1.9	Power 8

- Note 1: For emissions in restricted bands, the limit of 15.209 was used. For all other emissions, the limit is -30dBc for peak measurements in a measurement bandwidth of 100kHz.
- Note 2: Scans made between 18 - 25GHz with the measurement antenna moved around the card and its antennas 20-50cm from the device indicated there were no significant emissions in this frequency range



EMC Test Data

Client: Ubiquiti Networks	Job Number: J85169
Model: mPort-S (Serial Port Version)	T-Log Number: T85772
	Account Manager: Susan Pelzl
Contact: Jennifer Sanchez	
Standard: FCC 15.247/EN 300 328	Class: N/A

Run # 2, Radiated Spurious Emissions, 1-26GHz, 802.11n20, Chain Ext

Date of Test: 5/18/2012

Test Location: Chamber 3

Test Engineer: Peter Sales

Config Change: none

Run # 2a, EUT on Channel #1 2412MHz - 802.11n20, Chain Ext

	Target (dBm)	Power Settings Measured (dBm)	Software Setting
Chain Ext		-	9.0

Spurious Radiated Emissions:

Frequency	Level	Pol	15.209/15.247		Detector	Azimuth	Height	Comments
MHz	dB μ V/m	v/h	Limit	Margin	Pk/QP/Avg	degrees	meters	
1400.060	41.4	H	54.0	-12.6	AVG	204	1.4	RB 1 MHz;VB 10 Hz;Peak
1400.190	43.9	H	74.0	-30.1	PK	204	1.4	RB 1 MHz;VB 3 MHz;Peak
2728.810	35.4	H	54.0	-18.6	AVG	316	2.0	RB 1 MHz;VB 10 Hz;Peak
2737.810	46.9	H	74.0	-27.1	PK	316	2.0	RB 1 MHz;VB 3 MHz;Peak
4823.320	52.7	V	54.0	-1.3	AVG	211	1.0	Power 9
4822.440	64.5	V	74.0	-9.5	PK	211	1.0	Power 9

- Note 1: For emissions in restricted bands, the limit of 15.209 was used. For all other emissions, the limit is -30dBc for peak measurements in a measurement bandwidth of 100kHz.
- Note 2: Scans made between 18 - 25GHz with the measurement antenna moved around the card and its antennas 20-50cm from the device indicated there were no significant emissions in this frequency range

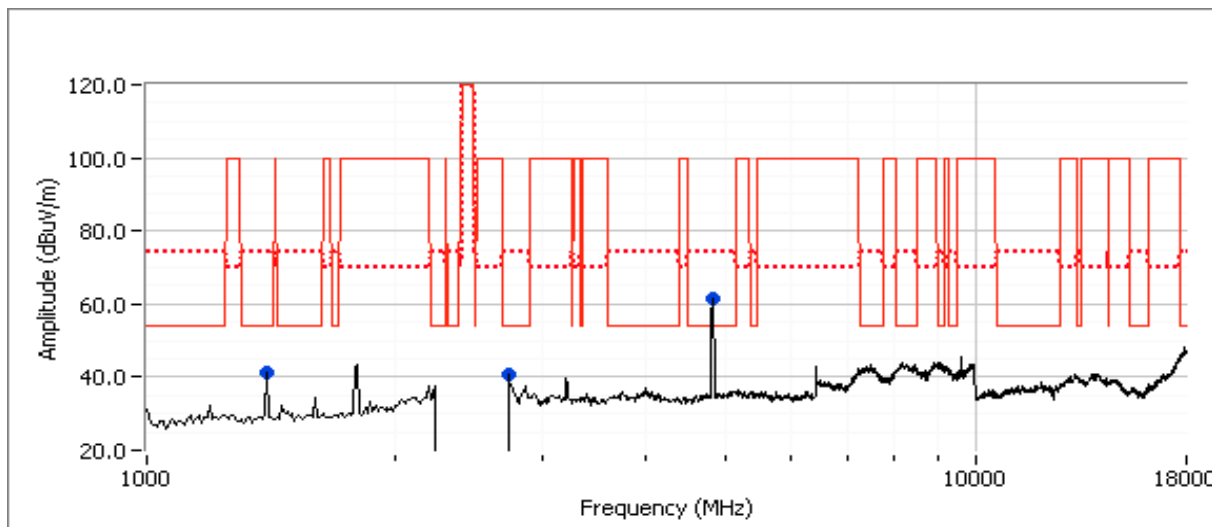



EMC Test Data

Client: Ubiquiti Networks	Job Number: J85169
Model: mPort-S (Serial Port Version)	T-Log Number: T85772
	Account Manager: Susan Pelzl
Contact: Jennifer Sanchez	
Standard: FCC 15.247/EN 300 328	Class: N/A

Run # 2b: , EUT on Channel #6 2437MHz - 802.11n20, Chain Ext

Date of Test: 5/18/2012 Test Location: Chamber 3
 Test Engineer: Peter Sales Config Change: none

	Target (dBm)	Power Settings Measured (dBm)	Software Setting
Chain Ext		-	10.0

Spurious Radiated Emissions:

Frequency	Level	Pol	15.209/15.247		Detector	Azimuth	Height	Comments
MHz	dB μ V/m	v/h	Limit	Margin	Pk/QP/Avg	degrees	meters	
2738.500	34.5	V	54.0	-19.5	AVG	195	2.5	RB 1 MHz;VB 10 Hz;Peak
2737.240	45.8	V	74.0	-28.2	PK	195	2.5	RB 1 MHz;VB 3 MHz;Peak
1400.050	41.2	H	54.0	-12.8	AVG	206	1.4	RB 1 MHz;VB 10 Hz;Peak
1399.890	43.5	H	74.0	-30.5	PK	206	1.4	RB 1 MHz;VB 3 MHz;Peak
4876.050	53.2	V	54.0	-0.8	AVG	212	1.0	Power 10
4877.980	66.3	V	74.0	-7.7	PK	212	1.0	Power 10

- Note 1: For emissions in restricted bands, the limit of 15.209 was used. For all other emissions, the limit is -30dBc for peak measurements in a measurement bandwidth of 100kHz.
- Note 2: Scans made between 18 - 25GHz with the measurement antenna moved around the card and its antennas 20-50cm from the device indicated there were no significant emissions in this frequency range

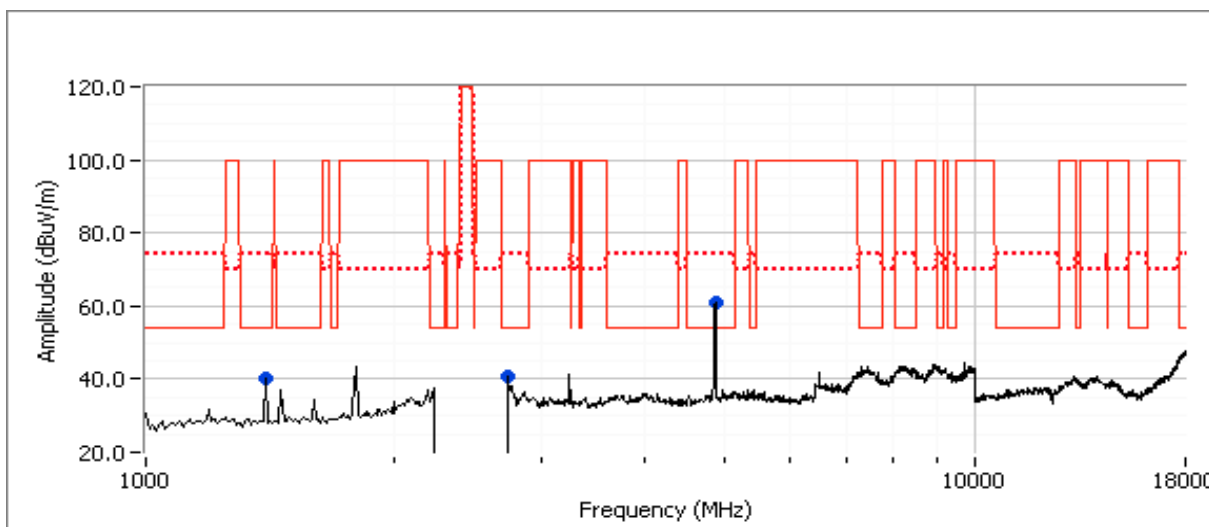



EMC Test Data

Client: Ubiquiti Networks	Job Number: J85169
Model: mPort-S (Serial Port Version)	T-Log Number: T85772
	Account Manager: Susan Pelzl
Contact: Jennifer Sanchez	
Standard: FCC 15.247/EN 300 328	Class: N/A

Run # 2c: , EUT on Channel #11 2462MHz - 802.11n20, Chain Ext

Date of Test: 5/18/2012 Test Location: Chamber 3
 Test Engineer: Peter Sales Config Change: none

	Power Settings		
	Target (dBm)	Measured (dBm)	Software Setting
Chain Ext		-	8.0

Spurious Radiated Emissions:

Frequency	Level	Pol	15.209/15.247		Detector	Azimuth	Height	Comments
MHz	dBμV/m	v/h	Limit	Margin	Pk/QP/Avg	degrees	meters	
2730.540	35.6	V	54.0	-18.4	AVG	337	1.1	RB 1 MHz;VB 10 Hz;Peak
2730.100	46.9	V	74.0	-27.1	PK	337	1.1	RB 1 MHz;VB 3 MHz;Peak
4923.260	51.2	V	54.0	-2.8	AVG	205	1.1	RB 1 MHz;VB 10 Hz;Peak
4921.660	65.9	V	74.0	-8.1	PK	205	1.1	RB 1 MHz;VB 3 MHz;Peak
1399.960	39.9	H	54.0	-14.1	AVG	187	1.0	RB 1 MHz;VB 10 Hz;Peak
1400.000	43.0	H	74.0	-31.0	PK	187	1.0	RB 1 MHz;VB 3 MHz;Peak

- Note 1: For emissions in restricted bands, the limit of 15.209 was used. For all other emissions, the limit is -30dBc for peak measurements in a measurement bandwidth of 100kHz.
- Note 2: Scans made between 18 - 25GHz with the measurement antenna moved around the card and its antennas 20-50cm from the device indicated there were no significant emissions in this frequency range

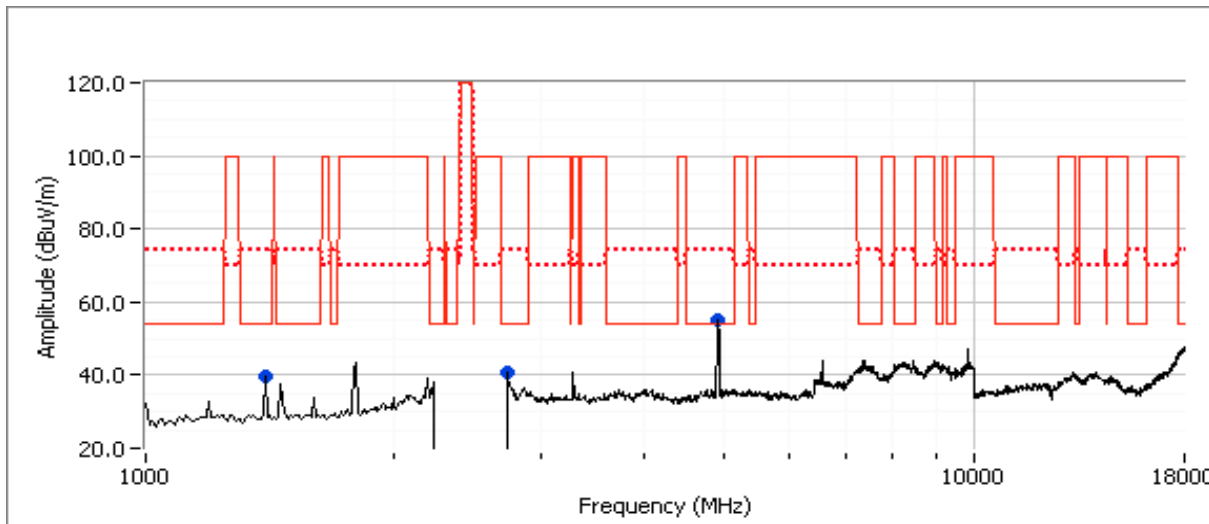



EMC Test Data

Client: Ubiquiti Networks	Job Number: J85169
Model: mPort-S (Serial Port Version)	T-Log Number: T85772
	Account Manager: Susan Pelzl
Contact: Jennifer Sanchez	
Standard: FCC 15.247/EN 300 328	Class: N/A

RSS 210 and FCC 15.247 (DTS) Antenna Port Measurements Power

Test Specific Details

Objective: The objective of this test session is to perform final qualification testing of the EUT with respect to the specification listed above.

Date of Test: 5/22/2012
 Test Engineer: John Caizzi
 Test Location: Chamber 4

Config. Used:
 Config Change:
 EUT Voltage: 24 VDC, PoE

General Test Configuration

The EUT was connected to the spectrum analyzer or power meter via a suitable attenuator. All measurements were made on a single chain.

All measurements have been corrected to allow for the external attenuators used.

Ambient Conditions:

Temperature: 24 °C
 Rel. Humidity: 32 %

Summary of Results

Run #	Test Performed	Limit	Pass / Fail	Result / Margin
1	Output Power - Internal Antenna	15.247(b)	Pass	g: 9.8dBm (0.0095W) n20:9.2dBm (0.0083W)
2	Output Power - External Antenna	15.247(b)	Pass	g: 1.9dBm (0.0016W) n20:4.4dBm (0.0027W)

Modifications Made During Testing

No modifications were made to the EUT during testing

Deviations From The Standard

No deviations were made from the requirements of the standard.

Client: Ubiquiti Networks	Job Number: J85169
Model: mPort-S (Serial Port Version)	T-Log Number: T85772
	Account Manager: Susan Pelzl
Contact: Jennifer Sanchez	
Standard: FCC 15.247/EN 300 328	Class: N/A

Run #1: Output Power, internal antenna sample.

802.11g

Power Setting ²	Frequency (MHz)	Output Power		Antenna Gain (dBi)	Result	EIRP ^{Note 2}		Output Power	
		(dBm) ¹	mW			dBm	W	(dBm) ³	mW
10.0	2412	9.0	8.0	3.0	Pass	12.0	0.016		
11.0	2437	9.8	9.5	3.0	Pass	12.8	0.019		
8.0	2462	8.3	6.7	3.0	Pass	11.3	0.013		

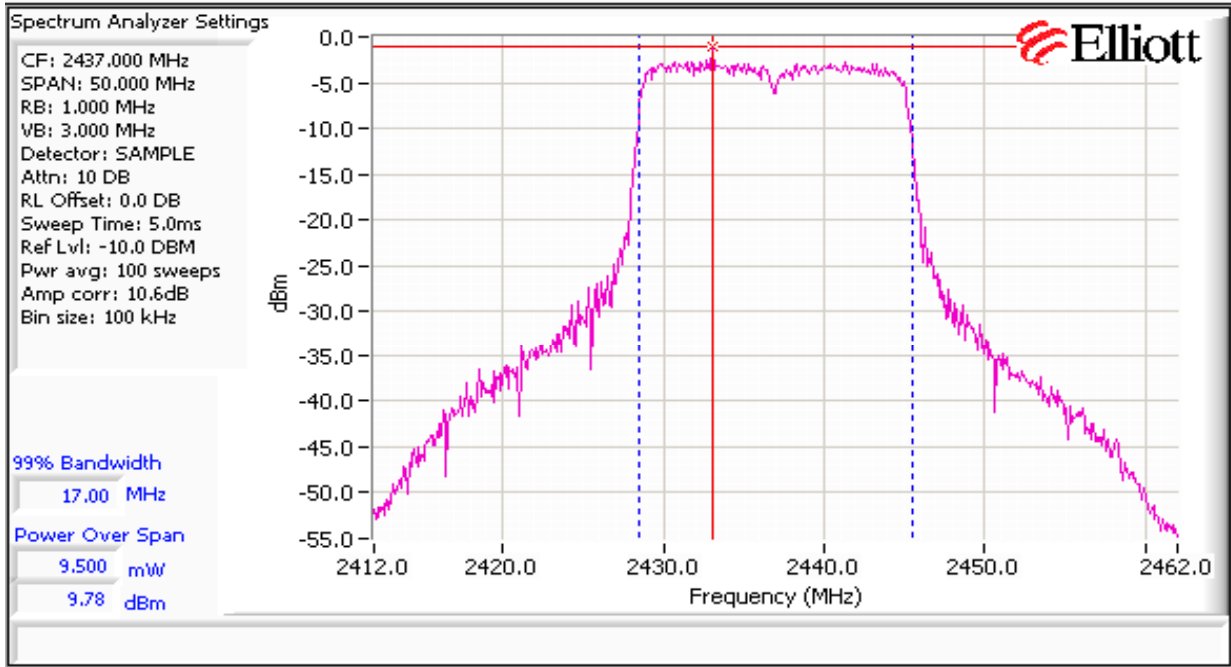

Client: Ubiquiti Networks	Job Number: J85169
Model: mPort-S (Serial Port Version)	T-Log Number: T85772
	Account Manager: Susan Pelzl
Contact: Jennifer Sanchez	
Standard: FCC 15.247/EN 300 328	Class: N/A

802.11n20

Power Setting ²	Frequency (MHz)	Output Power		Antenna Gain (dBi)	Result	EIRP ^{Note 2}		Output Power	
		(dBm) ¹	mW			dBm	W	(dBm) ³	mW
8.5	2412	7.7	5.9	3.0	Pass	10.7	0.012		
10.0	2437	9.2	8.3	3.0	Pass	12.2	0.017		
7.5	2462	7.8	6.0	3.0	Pass	10.8	0.012		

- Note 1: Output power measured using a spectrum analyzer (see plots below) with RBW=1MHz, VB=3 MHz, sample detector, power averaging on (transmitted signal was not continuous but the ESI analyzer was configured with a gated sweep such that the analyzer was only sweeping when the device was transmitting) and power integration over 50 MHz (option #2, method 1 in KDB 558074, equivalent to method 1 of DA-02-2138A1 for U-NII devices). Spurious limit becomes -30dBc.
- Note 2: Power setting - the software power setting used during testing, included for reference only.

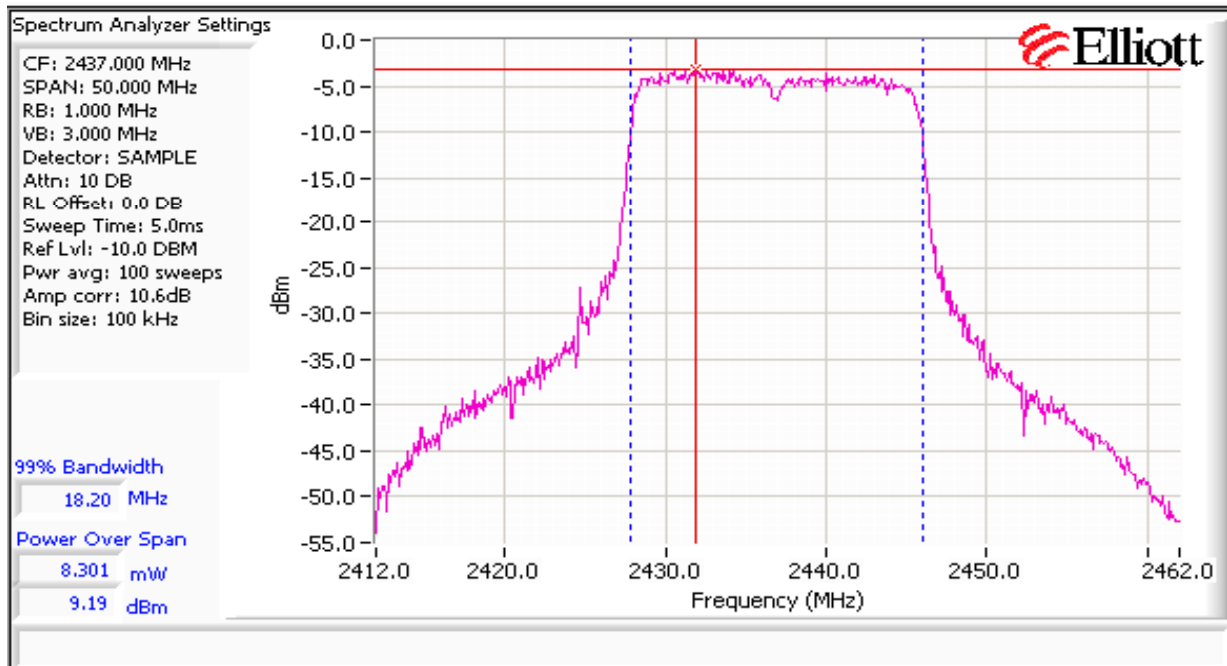

Client: Ubiquiti Networks	Job Number: J85169
Model: mPort-S (Serial Port Version)	T-Log Number: T85772
	Account Manager: Susan Pelzl
Contact: Jennifer Sanchez	
Standard: FCC 15.247/EN 300 328	Class: N/A

Run #2: Output Power, external antenna sample.

802.11g

Power Setting ²	Frequency (MHz)	Output Power		Antenna Gain (dBi)	Result	EIRP ^{Note 2}		Output Power	
		(dBm) ¹	mW			dBm	W	(dBm) ³	mW
8.0	2412	1.5	1.4	4.0	Pass	5.5	0.004		
8.0	2437	1.9	1.6	4.0	Pass	5.9	0.004		
8.0	2462	-4.7	0.3	4.0	Pass	-0.7	0.001		

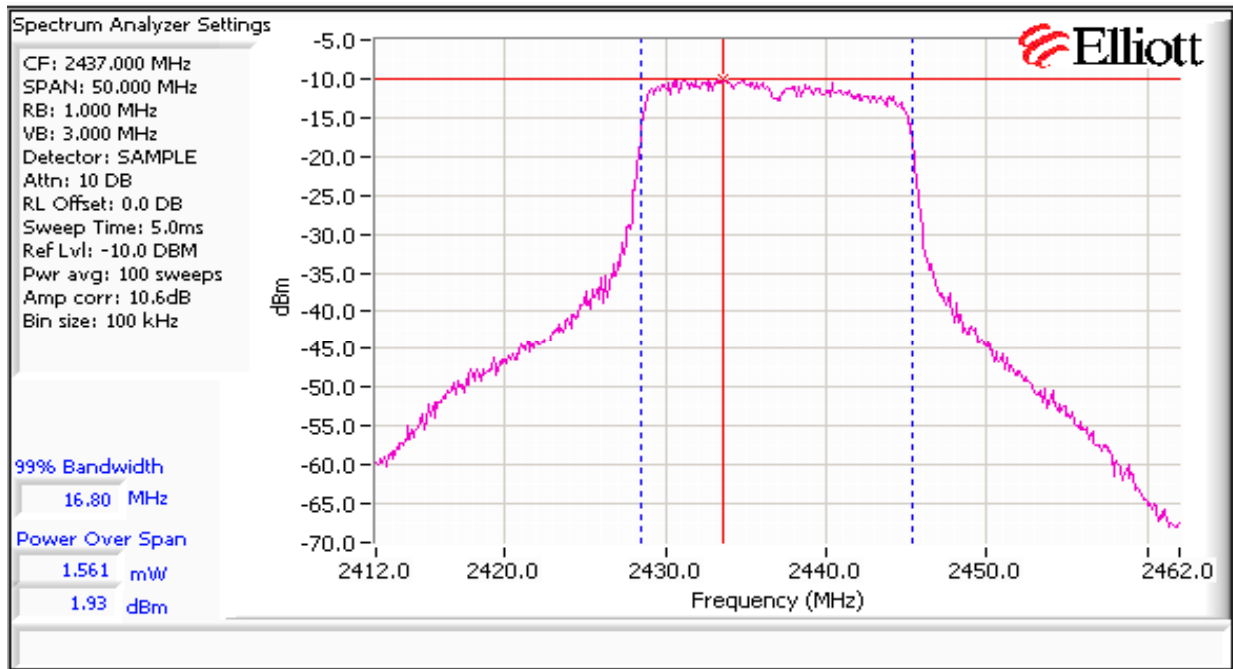

Client: Ubiquiti Networks	Job Number: J85169
Model: mPort-S (Serial Port Version)	T-Log Number: T85772
	Account Manager: Susan Pelzl
Contact: Jennifer Sanchez	
Standard: FCC 15.247/EN 300 328	Class: N/A

802.11n20

Power Setting ²	Frequency (MHz)	Output Power		Antenna Gain (dBi)	Result	EIRP ^{Note 2}		Output Power	
		(dBm) ¹	mW			dBm	W	(dBm) ³	mW
9.0	2412	3.4	2.2	4.0	Pass	7.4	0.005		
10.0	2437	4.4	2.7	4.0	Pass	8.4	0.007		
8.0	2462	-4.4	0.4	4.0	Pass	-0.4	0.001		

- Note 1: Output power measured using a spectrum analyzer (see plots below) with RBW=1MHz, VB=3 MHz, sample detector, power averaging on (transmitted signal was not continuous but the ESI analyzer was configured with a gated sweep such that the analyzer was only sweeping when the device was transmitting) and power integration over 50 MHz (option #2, method 1 in KDB 558074, equivalent to method 1 of DA-02-2138A1 for U-NII devices). Spurious limit becomes -30dBc.
- Note 2: Power setting - the software power setting used during testing, included for reference only.

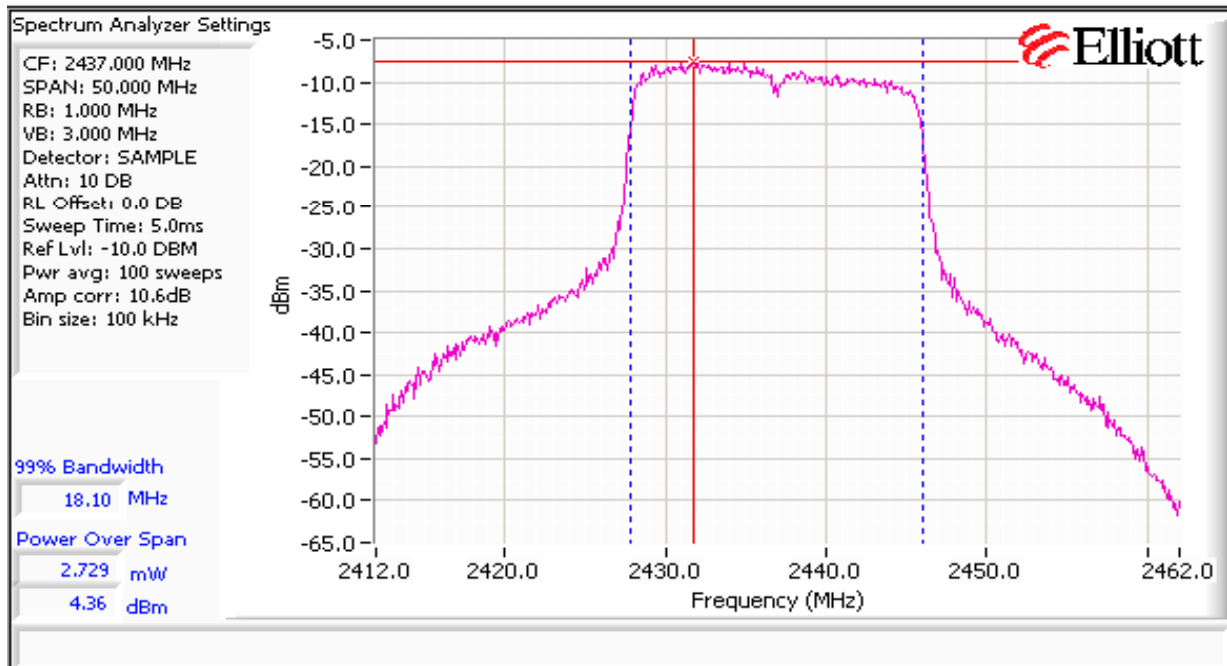



EMC Test Data

Client:	Ubiquiti Networks	Job Number:	J85169
Product:	mPort-S (Serial Port Version)	T-Log Number:	T85772
		Account Manager:	Susan Pelzl
Contact:	Jennifer Sanchez		
Standard:	FCC 15.247/EN 300 328	Class:	N/A

RSS 210 and FCC 15.247 (DTS) Antenna Port Measurements PSD, Bandwidth and Spurious Emissions

Test Specific Details

Objective: The objective of this test session is to perform final qualification testing of the EUT with respect to the specification listed above.

Date of Test: 5/22/2012
 Test Engineer: John Caizzi
 Test Location: Fremont Chamber #4

Config. Used: 1
 Config Change: None
 EUT Voltage: 24 VDC PoE

General Test Configuration

The EUT was connected to the spectrum analyzer or power meter via a suitable attenuator. All measurements were made on a single chain.

All measurements have been corrected to allow for the external attenuators used.

All measurements made on the internal antenna sample, which measured about 6 dB higher output power than the external antenna sample. The settings were the higher of the internal & external antenna settings.

Ambient Conditions:

Temperature: 23 °C
 Rel. Humidity: 33 %

Summary of Results

Run #	Test Performed	Limit	Pass / Fail	Result / Margin
2	Power spectral density (PSD)	15.247(d)	Pass	g: -13.4 dBm/3kHz n20: -14.2 dBm/3kHz
3	Minimum 6dB Bandwidth	15.247(a)	Pass	g: 16.07 MHz n20: 17.43 MHz
3	99% Bandwidth	RSS GEN	-	g: 17.0 MHz n20: 18.1 MHz
4	Spurious emissions	15.247(b)	Pass	All emissions < -30 dBc

Modifications Made During Testing

No modifications were made to the EUT during testing

Deviations From The Standard

No deviations were made from the requirements of the standard.



EMC Test Data

Client: Ubiquiti Networks	Job Number: J85169
Product: mPort-S (Serial Port Version)	T-Log Number: T85772
	Account Manager: Susan Pelzl
Contact: Jennifer Sanchez	
Standard: FCC 15.247/EN 300 328	Class: N/A

Run #2: Power spectral Density

802.11g

Power Setting	Frequency (MHz)	PSD	Limit dBm/3kHz	Result
		(dBm/3kHz) ^{Note 1}		
10.0	2412	-13.4	8.0	Pass
11.0	2437	-13.4	8.0	Pass
8.0	2462	-14.6	8.0	Pass

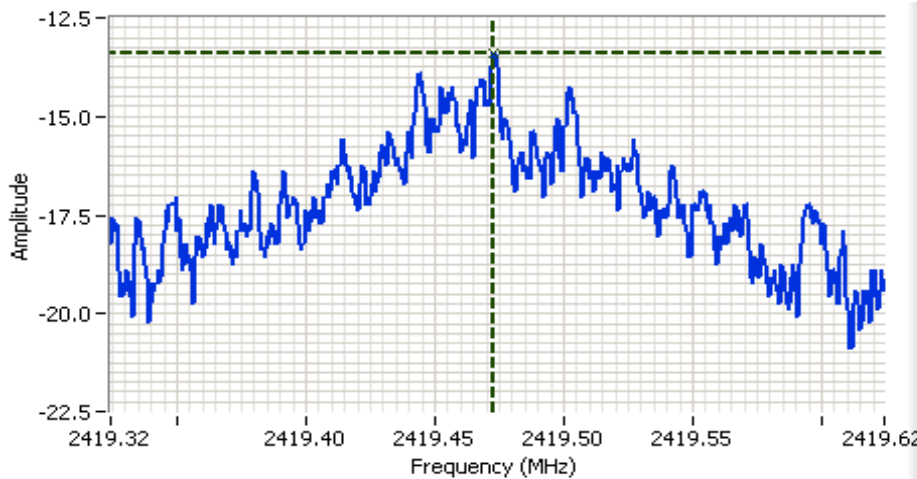

Analyzer Settings

HP8563E
 CF: 2419.474 MHz
 SPAN: 300 kHz
 RB: 3.00 kHz
 VB: 10.0 kHz
 Detector: POS
 Attn: 10 DB
 RL Offset: 11.0 DB
 Sweep Time: 60.0s
 Ref Lvl: 10.6 DBM

Comments

PSD 802.11g

Cursor 1 2419.4727 -13.40

0.0000 0.00



Client: Ubiquiti Networks	Job Number: J85169
Product: mPort-S (Serial Port Version)	T-Log Number: T85772
	Account Manager: Susan Pelzl
Contact: Jennifer Sanchez	
Standard: FCC 15.247/EN 300 328	Class: N/A

802.11n20

Power Setting	Frequency (MHz)	PSD	Limit dBm/3kHz	Result
		(dBm/3kHz) ^{Note 1}		
9.0	2412	-14.9	8.0	Pass
10.0	2437	-14.2	8.0	Pass
8.0	2462	-14.2	8.0	Pass

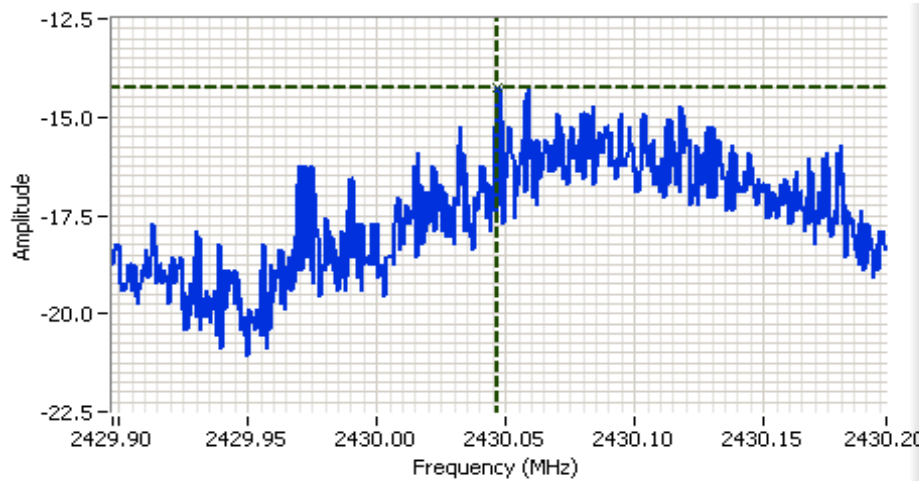

Analyzer Settings

HP8563E
 CF: 2430.047 MHz
 SPAN: 300 kHz
 RB: 3.00 kHz
 VB: 10.0 kHz
 Detector: POS
 Attn: 10 DB
 RL Offset: 11.0 DB
 Sweep Time: 60.0s
 Ref Lvl: 10.6 DBM

Comments

802.11n20 PSD

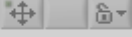
Cursor 1 2430.0470 -14.23 
 0.0000 0.00 



Note 1: Power spectral density measured using RB=3 kHz, VB=10kHz, analyzer with peak detector and with a sweep time set to ensure a dwell time of at least 1 second per 3kHz. The measurement is made at the frequency of PPSD determined from preliminary scans using RB=3kHz using multiple sweeps at a faster rate over the 6dB bandwidth of the signal.

Client: Ubiquiti Networks	Job Number: J85169
Product: mPort-S (Serial Port Version)	T-Log Number: T85772
	Account Manager: Susan Pelzl
Contact: Jennifer Sanchez	
Standard: FCC 15.247/EN 300 328	Class: N/A

Run #3: Signal Bandwidth

802.11g

Power Setting	Frequency (MHz)	Resolution Bandwidth	Bandwidth (MHz)	
			6dB	99%
10	2412	100 kHz	16.233	16.9
11	2437	100 kHz	16.067	17.0
8	2462	100 kHz	16.567	17.0

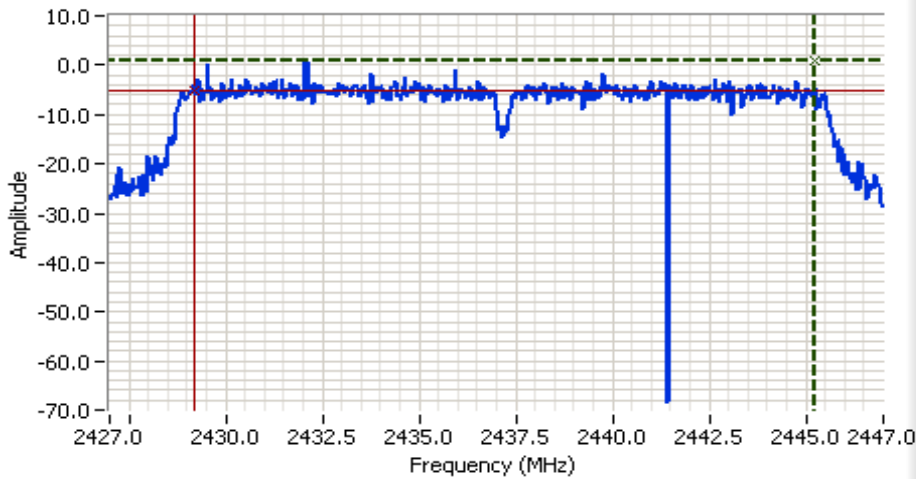

Analyzer Settings

HP8563E
 CF: 2437.000 MHz
 SPAN: 20.000 MHz
 RB: 100 kHz
 VB: 300 kHz
 Detector: POS
 Attn: 10 DB
 RL Offset: 11.0 DB
 Sweep Time: 50.0ms
 Ref Lvl: 10.6 DBM

Comments

6dB BW: 16.067 MHz
 802.11g

Cursor 1	2445.2333	0.93		Delta Freq.	16.067
Cursor 2	2429.1667	-5.07		Delta Amplitude	6.00

Client: Ubiquiti Networks	Job Number: J85169
Product: mPort-S (Serial Port Version)	T-Log Number: T85772
	Account Manager: Susan Pelzl
Contact: Jennifer Sanchez	
Standard: FCC 15.247/EN 300 328	Class: N/A

802.11n20

Power Setting	Frequency (MHz)	Resolution Bandwidth	Bandwidth (MHz)	
			6dB	99%
9	2412	100 kHz	17.433	18.1
10	2437	100 kHz	17.633	18.1
8	2462	100 kHz	17.600	18.1

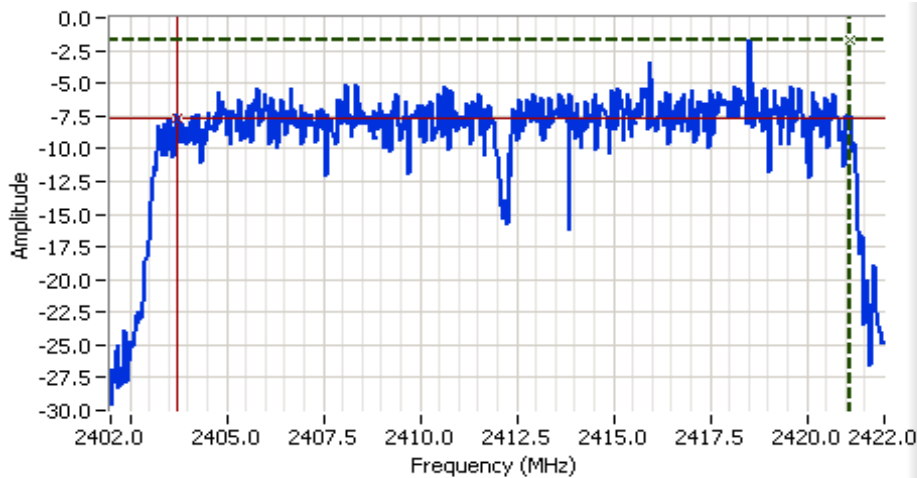

Analyzer Settings

HP8563E
 CF: 2412.000 MHz
 SPAN: 20.000 MHz
 RB: 100 kHz
 VB: 300 kHz
 Detector: POS
 Attn: 10 DB
 RL Offset: 11.0 DB
 Sweep Time: 50.0ms
 Ref Lvl: 10.6 DBM

Comments

6dB BW: 17.433 MHz
 802.11n20

Cursor 1	2421.1333	-1.73		Delta Freq.	17.433
Cursor 2	2403.7000	-7.73		Delta Amplitude	6.00



Note 1: 99% bandwidth measured in accordance with RSS GEN, with RB > 1% of the span and VB > 3xRB

Client: Ubiquiti Networks	Job Number: J85169
Product: mPort-S (Serial Port Version)	T-Log Number: T85772
	Account Manager: Susan Pelzl
Contact: Jennifer Sanchez	
Standard: FCC 15.247/EN 300 328	Class: N/A

Run #4: Out of Band Spurious Emissions

802.11g

Frequency (MHz)	Limit	Result
2412	-30dBc	Pass
2437	-30dBc	Pass
2462	-30dBc	Pass

802.11n20

Frequency (MHz)	Limit	Result
2412	-30dBc	Pass
2437	-30dBc	Pass
2462	-30dBc	Pass

802.11g

Plots for low channel, power setting = 10.0

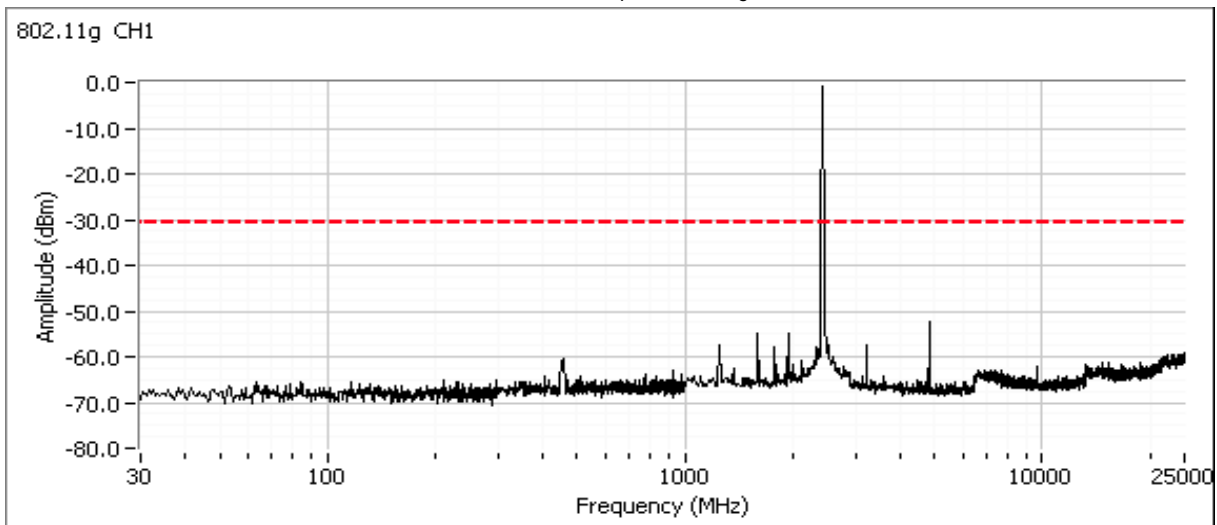

Client: Ubiquiti Networks	Job Number: J85169
Product: mPort-S (Serial Port Version)	T-Log Number: T85772
	Account Manager: Susan Pelzl
Contact: Jennifer Sanchez	
Standard: FCC 15.247/EN 300 328	Class: N/A

Additional plot showing compliance with -30dBc limit from 2390 MHz to 2400 MHz. Radiated measurements used to show compliance with the limits in the restricted band below 2390 MHz.

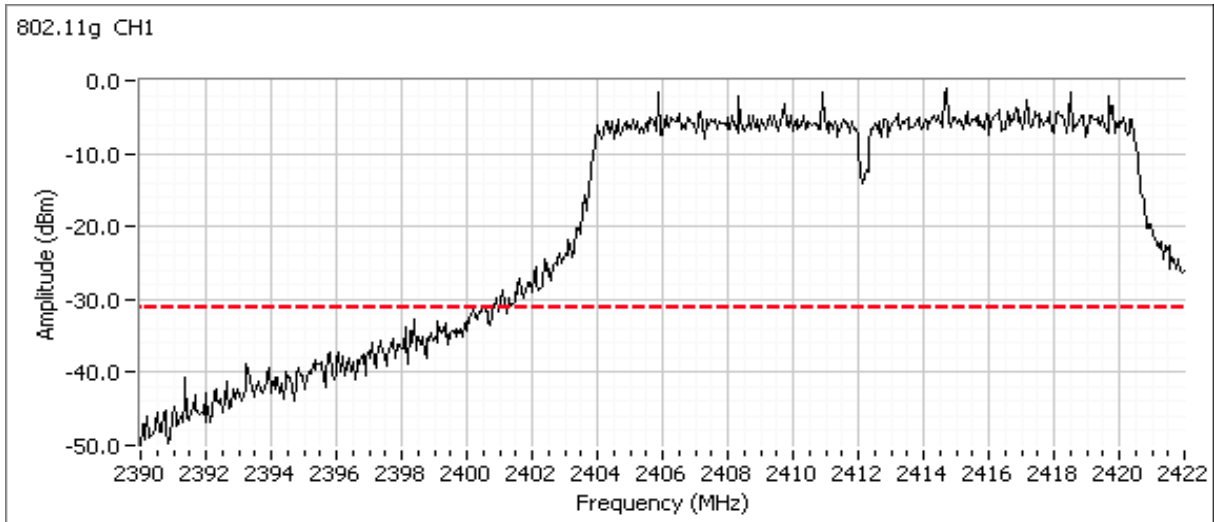

Plots for center channel, power setting = 11.0

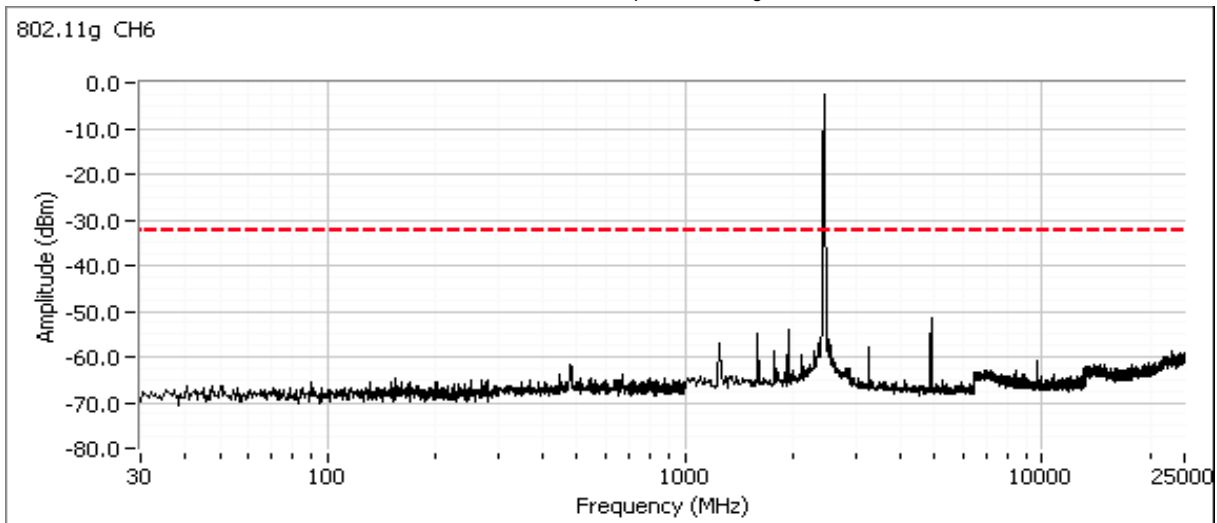

Client: Ubiquiti Networks	Job Number: J85169
Product: mPort-S (Serial Port Version)	T-Log Number: T85772
	Account Manager: Susan Pelzl
Contact: Jennifer Sanchez	
Standard: FCC 15.247/EN 300 328	Class: N/A

Plots for high channel, power setting = 13.0

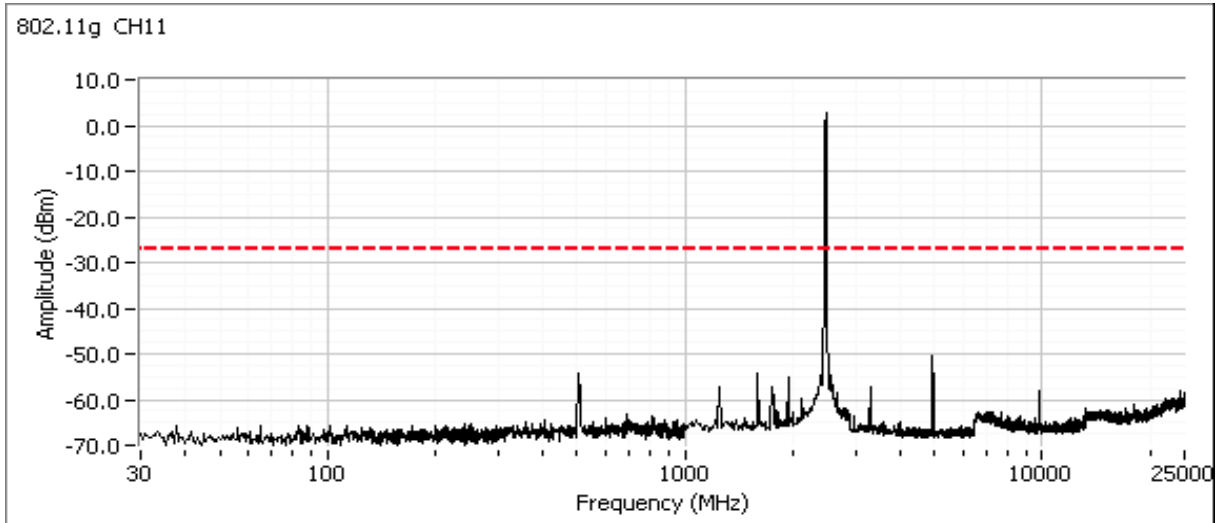

Client: Ubiquiti Networks	Job Number: J85169
Product: mPort-S (Serial Port Version)	T-Log Number: T85772
	Account Manager: Susan Pelzl
Contact: Jennifer Sanchez	
Standard: FCC 15.247/EN 300 328	Class: N/A

802.11n20

Plots for low channel, power setting = 9.0

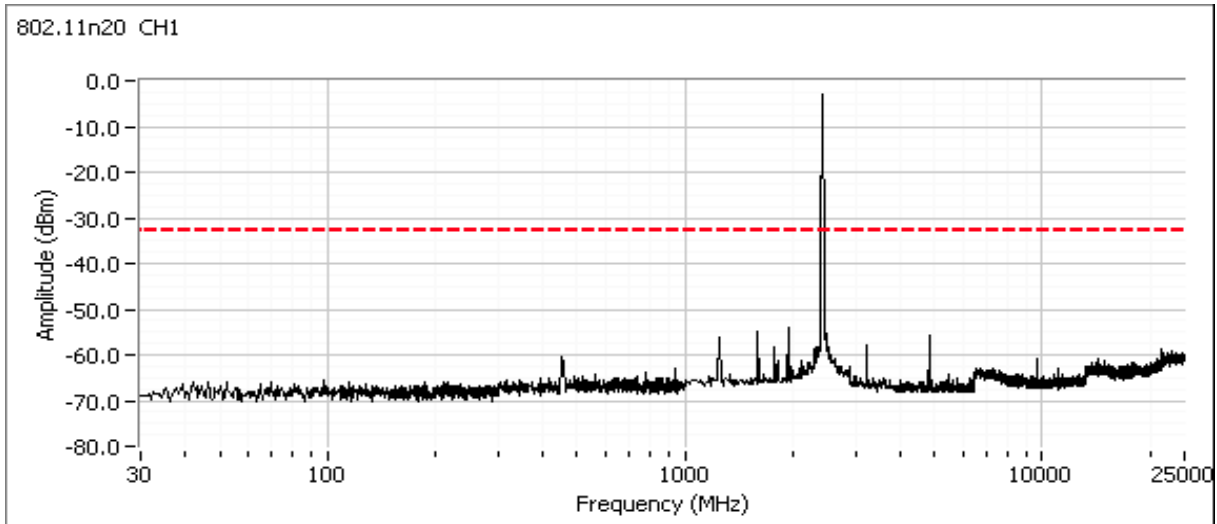

Additional plot showing compliance with -30dBc limit from 2390 MHz to 2400 MHz. Radiated measurements used to show compliance with the limits in the restricted band below 2390 MHz.

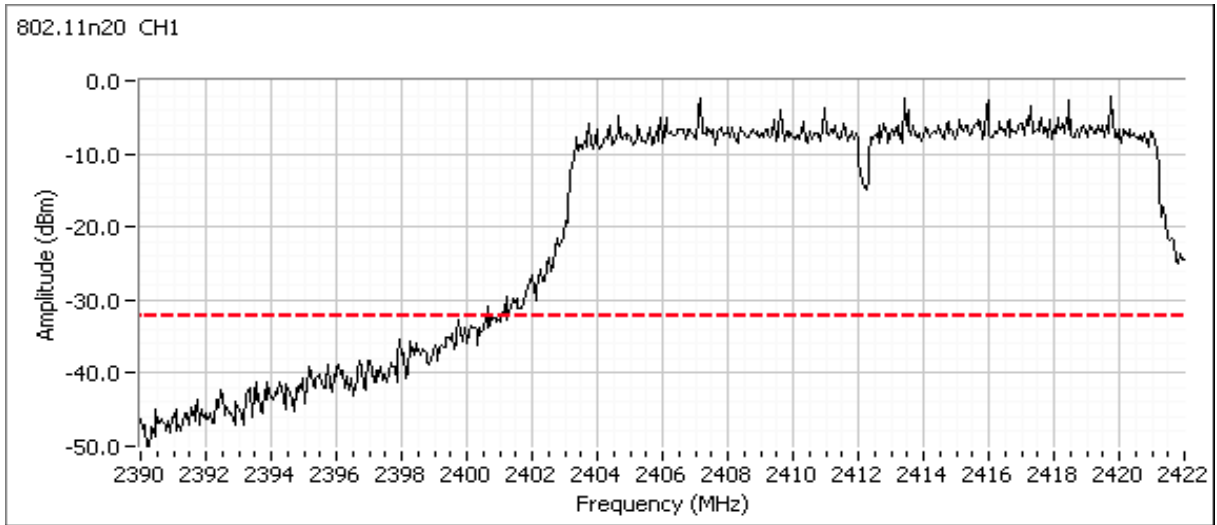

Client: Ubiquiti Networks	Job Number: J85169
Product: mPort-S (Serial Port Version)	T-Log Number: T85772
	Account Manager: Susan Pelzl
Contact: Jennifer Sanchez	
Standard: FCC 15.247/EN 300 328	Class: N/A

Plots for center channel, power setting = 10.0

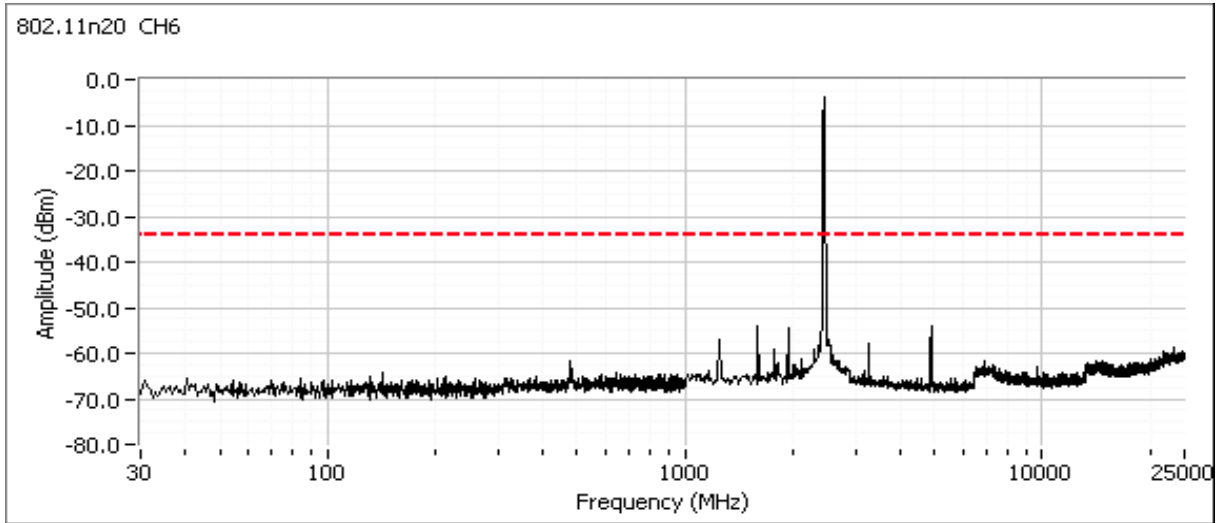

Plots for high channel, power setting = 8.0

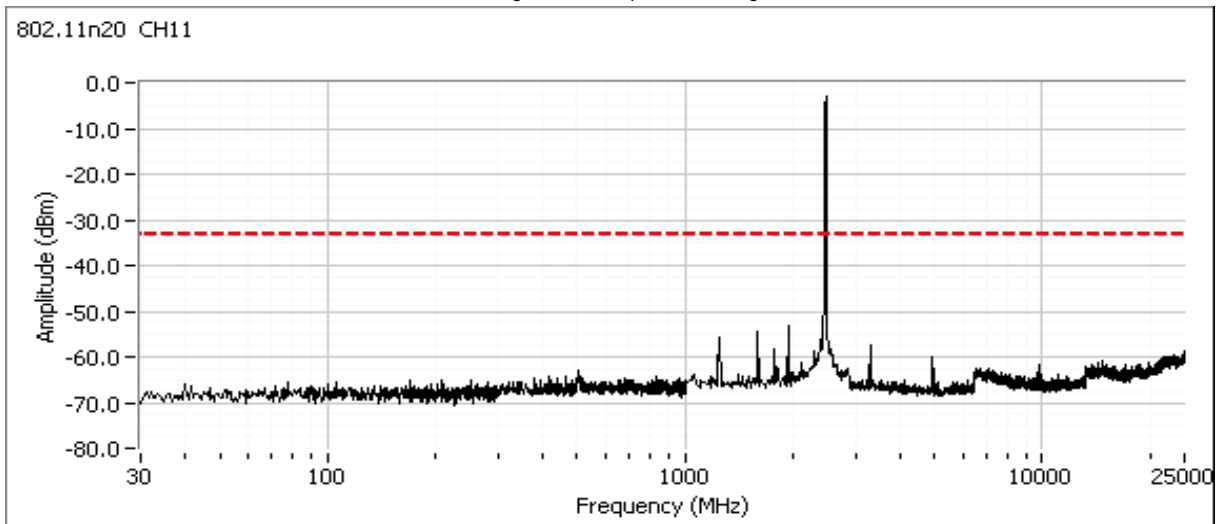



EMC Test Data

Client:	Ubiquiti Networks	Job Number:	J85169
Model:	MFi-VPM (mPort)	T-Log Number:	T85773
		Account Manager:	Susan Pelzl
Contact:	Jennifer Sanchez		-
Emissions Standard(s):	FCC 15B, EN 61326, EN 301 489-1/-17	Class:	B
Immunity Standard(s):	EN 61326, EN 301 489-1/-17	Environment:	Basic

EMC Test Data

For The

Ubiquiti Networks

Model

MFi-VPM (mPort)

Date of Last Test: 9/27/2012



EMC Test Data

Client: Ubiquiti Networks	Job Number: J85169
Model: MFi-VPM (mPort)	T-Log Number: T85773
	Account Manager: Susan Pelzl
Contact: Jennifer Sanchez	
Standard: FCC 15B, EN 61326, EN 301 489-1/-17	Class: B

Conducted Emissions

(Elliott Laboratories Fremont Facility, Semi-Anechoic Chamber)

Test Specific Details

Objective: The objective of this test session is to perform final qualification testing of the EUT with respect to the specification listed above.

Date of Test: 2/10/2012	Config. Used: 1
Test Engineer: William Kwong	Config Change: None
Test Location: Fremont Chamber #4	EUT Voltage: Refer to each run

General Test Configuration

For tabletop equipment, the EUT was located on a wooden table inside the semi-anechoic chamber, 40 cm from a vertical coupling plane and 80cm from the LISN. A second LISN was used for all local support equipment. Remote support equipment was located outside of the semi-anechoic chamber. Any cables running to remote support equipment were routed through metal conduit and when possible passed through a ferrite clamp upon exiting the chamber.

Ambient Conditions: Temperature: 20-21 °C
 Rel. Humidity: 30-32 %

Summary of Results

Run #	Test Performed	Limit	Result	Margin
1	CE, AC Power, 230V/50Hz	Class B	Pass	41.0 dBµV @ 0.350 MHz (-8.0 dB)
2	CE, AC Power, 120V/60Hz	Class B	Pass	36.4 dBµV @ 0.350 MHz (-12.6 dB)

Modifications Made During Testing

No modifications were made to the EUT during testing

Deviations From The Standard

No deviations were made from the requirements of the standard.

Client: Ubiquiti Networks	Job Number: J85169
Model: MFi-VPM (mPort)	T-Log Number: T85773
Contact: Jennifer Sanchez	Account Manager: Susan Pelzl
Standard: FCC 15B, EN 61326, EN 301 489-1/-17	Class: B

Run #1: AC Power Port Conducted Emissions, 0.15 - 30MHz, 230V/50Hz

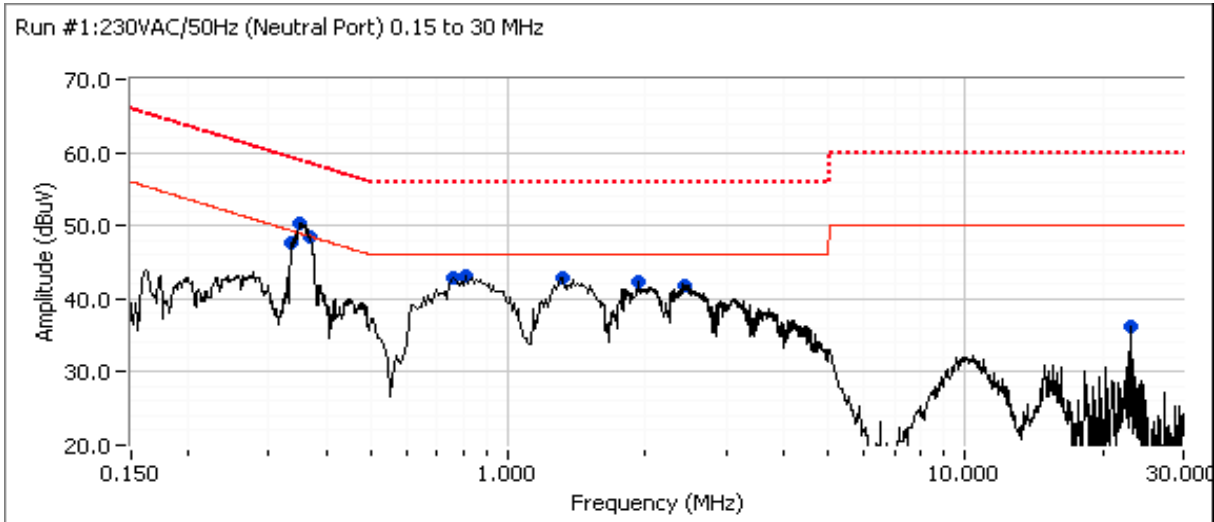
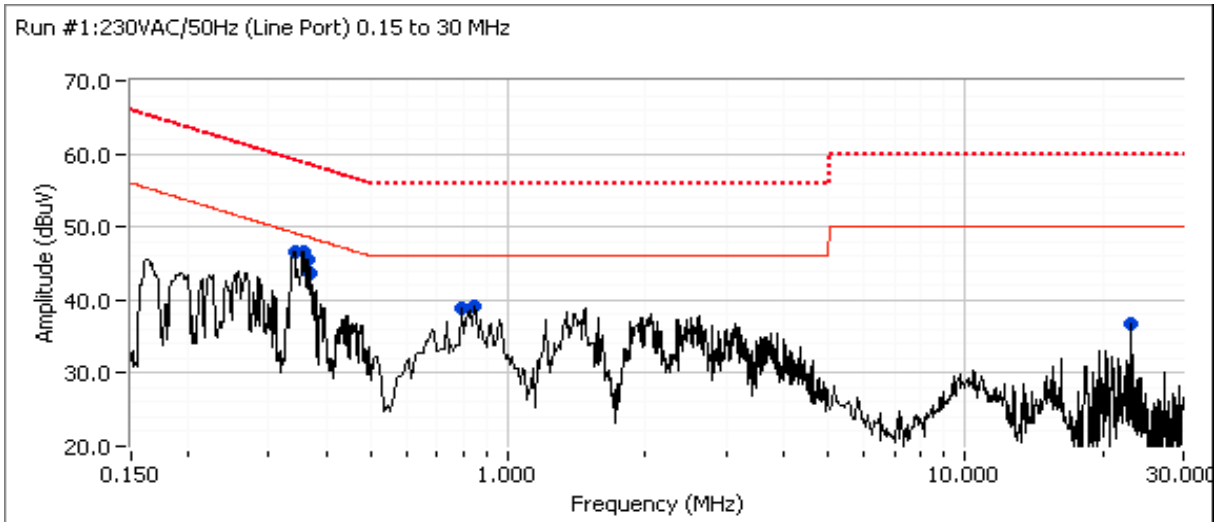



EMC Test Data

Client: Ubiquiti Networks	Job Number: J85169
Model: MFi-VPM (mPort)	T-Log Number: T85773
	Account Manager: Susan Pelzl
Contact: Jennifer Sanchez	
Standard: FCC 15B, EN 61326, EN 301 489-1/-17	Class: B

Preliminary peak readings captured during pre-scan (peak readings vs. average limit)

Frequency MHz	Level dB μ V	AC Line	Class B		Detector QP/Ave	Comments
			Limit	Margin		
0.343	46.7	Line 1	49.2	-2.5	Peak	
0.355	46.7	Line 1	48.8	-2.1	Peak	
0.364	45.5	Line 1	48.6	-3.1	Peak	
0.371	43.8	Line 1	48.5	-4.7	Peak	
0.797	39.0	Line 1	46.0	-7.0	Peak	
0.832	39.1	Line 1	46.0	-6.9	Peak	
23.129	36.7	Line 1	50.0	-13.3	Peak	
0.336	47.7	Neutral	49.3	-1.6	Peak	
0.350	50.4	Neutral	48.9	1.5	Peak	
0.369	48.4	Neutral	48.5	-0.1	Peak	
0.779	43.0	Neutral	46.0	-3.0	Peak	
0.815	43.2	Neutral	46.0	-2.8	Peak	
1.293	43.0	Neutral	46.0	-3.0	Peak	
1.926	42.3	Neutral	46.0	-3.7	Peak	
2.452	41.9	Neutral	46.0	-4.1	Peak	
23.129	36.2	Neutral	50.0	-13.8	Peak	



EMC Test Data

Client: Ubiquiti Networks	Job Number: J85169
Model: MFi-VPM (mPort)	T-Log Number: T85773
	Account Manager: Susan Pelzl
Contact: Jennifer Sanchez	
Standard: FCC 15B, EN 61326, EN 301 489-1/-17	Class: B

Final quasi-peak and average readings

Frequency MHz	Level dB μ V	AC Line	Class B		Detector QP/Ave	Comments
			Limit	Margin		
0.350	41.0	Neutral	49.0	-8.0	AVG	AVG (0.10s)
0.350	49.9	Neutral	59.0	-9.1	QP	QP (1.00s)
0.369	39.2	Neutral	48.5	-9.3	AVG	AVG (0.10s)
0.369	47.4	Neutral	58.5	-11.1	QP	QP (1.00s)
0.815	34.3	Neutral	46.0	-11.7	AVG	AVG (0.10s)
0.336	36.6	Neutral	49.3	-12.7	AVG	AVG (0.10s)
1.926	33.0	Neutral	46.0	-13.0	AVG	AVG (0.10s)
0.779	32.8	Neutral	46.0	-13.2	AVG	AVG (0.10s)
0.336	45.9	Neutral	59.3	-13.4	QP	QP (1.00s)
0.815	42.3	Neutral	56.0	-13.7	QP	QP (1.00s)
0.779	42.1	Neutral	56.0	-13.9	QP	QP (1.00s)
1.293	31.9	Neutral	46.0	-14.1	AVG	AVG (0.10s)
2.452	31.8	Neutral	46.0	-14.2	AVG	AVG (0.10s)
0.354	34.1	Line 1	48.9	-14.8	AVG	AVG (0.10s)
0.364	33.5	Line 1	48.6	-15.1	AVG	AVG (0.10s)
0.354	43.8	Line 1	58.9	-15.1	QP	QP (1.00s)
1.926	40.6	Neutral	56.0	-15.4	QP	QP (1.00s)
1.293	40.3	Neutral	56.0	-15.7	QP	QP (1.00s)
2.452	40.2	Neutral	56.0	-15.8	QP	QP (1.00s)
0.364	42.6	Line 1	58.6	-16.0	QP	QP (1.00s)
23.129	33.3	Line 1	50.0	-16.7	AVG	AVG (0.10s)
0.343	42.4	Line 1	59.1	-16.7	QP	QP (1.00s)
0.343	32.1	Line 1	49.1	-17.0	AVG	AVG (0.10s)
23.129	32.4	Neutral	50.0	-17.6	AVG	AVG (0.10s)
0.371	30.8	Line 1	48.5	-17.7	AVG	AVG (0.10s)
0.371	40.4	Line 1	58.5	-18.1	QP	QP (1.00s)
0.797	27.1	Line 1	46.0	-18.9	AVG	AVG (0.10s)
0.832	26.8	Line 1	46.0	-19.2	AVG	AVG (0.10s)
0.832	36.1	Line 1	56.0	-19.9	QP	QP (1.00s)
0.797	35.6	Line 1	56.0	-20.4	QP	QP (1.00s)
23.129	38.0	Line 1	60.0	-22.0	QP	QP (1.00s)
23.129	36.5	Neutral	60.0	-23.5	QP	QP (1.00s)

Client: Ubiquiti Networks	Job Number: J85169
Model: MFi-VPM (mPort)	T-Log Number: T85773
Contact: Jennifer Sanchez	Account Manager: Susan Pelzl
Standard: FCC 15B, EN 61326, EN 301 489-1/-17	Class: B

Run #2: AC Power Port Conducted Emissions, 0.15 - 30MHz, 120V/60Hz

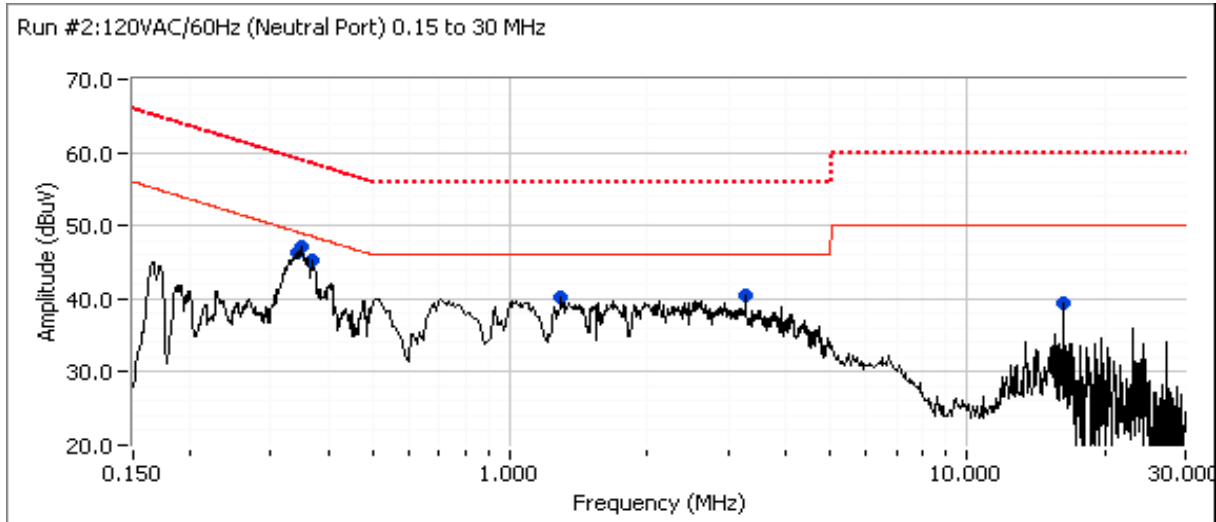
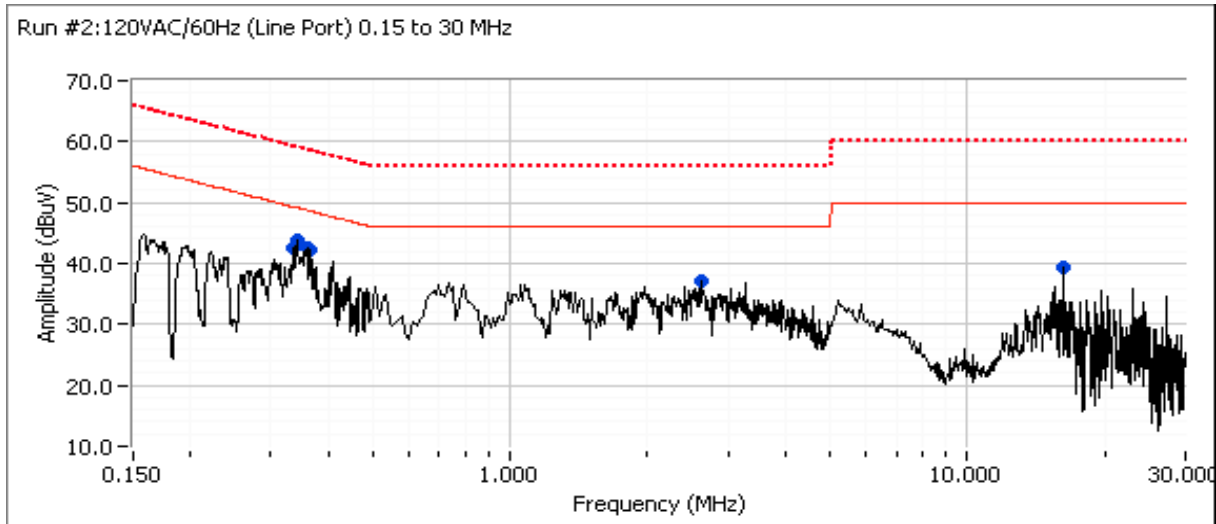



EMC Test Data

Client: Ubiquiti Networks	Job Number: J85169
Model: MFi-VPM (mPort)	T-Log Number: T85773
	Account Manager: Susan Pelzl
Contact: Jennifer Sanchez	
Standard: FCC 15B, EN 61326, EN 301 489-1/-17	Class: B

Preliminary peak readings captured during pre-scan (peak readings vs. average limit)

Frequency MHz	Level dB μ V	AC Line	Class B		Detector QP/Ave	Comments
			Limit	Margin		
0.335	42.6	Line 1	49.3	-6.7	Peak	
0.342	43.8	Line 1	49.2	-5.4	Peak	
0.359	42.4	Line 1	48.7	-6.3	Peak	
0.366	42.2	Line 1	48.6	-6.4	Peak	
2.615	37.2	Line 1	46.0	-8.8	Peak	
16.228	39.5	Line 1	50.0	-10.5	Peak	
0.344	46.4	Neutral	49.1	-2.7	Peak	
0.350	47.1	Neutral	48.9	-1.8	Peak	
0.368	45.3	Neutral	48.5	-3.2	Peak	
1.307	40.1	Neutral	46.0	-5.9	Peak	
3.267	40.5	Neutral	46.0	-5.5	Peak	
16.229	39.5	Neutral	50.0	-10.5	Peak	



EMC Test Data

Client: Ubiquiti Networks	Job Number: J85169
Model: MFi-VPM (mPort)	T-Log Number: T85773
	Account Manager: Susan Pelzl
Contact: Jennifer Sanchez	
Standard: FCC 15B, EN 61326, EN 301 489-1/-17	Class: B

Final quasi-peak and average readings

Frequency MHz	Level dB μ V	AC Line	Class B		Detector QP/Ave	Comments
			Limit	Margin		
0.350	36.4	Neutral	49.0	-12.6	AVG	AVG (0.10s)
0.350	46.1	Neutral	59.0	-12.9	QP	QP (1.00s)
0.344	36.0	Neutral	49.1	-13.1	AVG	AVG (0.10s)
0.344	45.6	Neutral	59.1	-13.5	QP	QP (1.00s)
0.368	34.9	Neutral	48.5	-13.6	AVG	AVG (0.10s)
0.368	44.5	Neutral	58.5	-14.0	QP	QP (1.00s)
16.228	35.9	Line 1	50.0	-14.1	AVG	AVG (0.10s)
16.229	35.9	Neutral	50.0	-14.1	AVG	AVG (0.10s)
3.267	29.8	Neutral	46.0	-16.2	AVG	AVG (0.10s)
1.307	29.3	Neutral	46.0	-16.7	AVG	AVG (0.10s)
2.615	28.2	Line 1	46.0	-17.8	AVG	AVG (0.10s)
0.359	40.9	Line 1	58.8	-17.9	QP	QP (1.00s)
3.267	37.9	Neutral	56.0	-18.1	QP	QP (1.00s)
0.359	30.6	Line 1	48.8	-18.2	AVG	AVG (0.10s)
0.366	40.1	Line 1	58.6	-18.5	QP	QP (1.00s)
1.307	37.5	Neutral	56.0	-18.5	QP	QP (1.00s)
0.335	40.6	Line 1	59.3	-18.7	QP	QP (1.00s)
0.342	40.5	Line 1	59.2	-18.7	QP	QP (1.00s)
0.366	29.0	Line 1	48.6	-19.6	AVG	AVG (0.10s)
0.342	29.3	Line 1	49.2	-19.9	AVG	AVG (0.10s)
0.335	28.6	Line 1	49.3	-20.7	AVG	AVG (0.10s)
16.228	39.2	Line 1	60.0	-20.8	QP	QP (1.00s)
16.229	38.7	Neutral	60.0	-21.3	QP	QP (1.00s)
2.615	34.5	Line 1	56.0	-21.5	QP	QP (1.00s)

End of Report

This page is intentionally blank and marks the last page of this test report.