



FCC RADIO TEST REPORT

Applicant : Ubiquiti Inc.
Address : 685 Third Avenue, New York, New York 10017, USA
Equipment : UniFi Protect G4 Doorbell Pro
Model No. : UVC-G4 Doorbell Pro
Trade Name : UBIQUITI
FCC ID. : SWX-UVCG4DP

I HEREBY CERTIFY THAT :

The sample was received on May. 10, 2021 and the testing was completed on Jul. 03, 2021 at Cerpess Technology Corp. The test result refers exclusively to the test presented test model / sample. Without written approval of Cerpess Technology Corp., the test report shall not be reproduced except in full.

Approved by:

Mark Liao / Supervisor

Laboratory Accreditation:

Cerpess Technology Corporation Test Laboratory





CONTENTS

- 1. **Summary of Test Procedure and Test Results**.....5
 - 1.1 Applicable Standards5
- 2. **Test Configuration of Equipment under Test**.....6
 - 2.1 Feature of Equipment under Test.....6
 - 2.2 Carrier Frequency of Channes.....7
 - 2.3 Test Mode & Test Software8
 - 2.4 Description of Test System.....9
 - 2.5 General Information of Test.....10
 - 2.6 Measurement Uncertainty10
- 3. **Test Equipment and Ancillaries Used for Tests**.....11
- 4. **Antenna Requirements**.....12
 - 4.1 Standard Applicable12
 - 4.2 Antenna Construction and Directional Gain.....12
- 5. **Test of AC Power Line Conducted Emission**13
 - 5.1 Test Limit13
 - 5.2 Test Procedures13
 - 5.3 Typical Test Setup14
 - 5.4 Test Result and Data15
 - 5.5 Test Photographs17
- 6. **Test of Radiated Spurious Emission**.....18
 - 6.1 Test Limit18
 - 6.2 Test Procedures.....18
 - 6.3 Typical Test Setup19
 - 6.4 Test Result and Data (9kHz ~ 30MHz).....20
 - 6.5 Test Result and Data (30MHz ~ 1GHz).....20
 - 6.6 Test Result and Data (1GHz ~ 25GHz).....22
 - 6.7 Restricted Bands of Operation34
 - 6.8 Test Photographs (30MHz ~ 1GHz)35
 - 6.9 Test Photographs (1GHz ~ 25GHz)36
- 7. **Test of Conducted Spurious Emission**38
 - 7.1 Test Limit38
 - 7.2 Test Procedure38
 - 7.3 Test Setup Layout38
 - 7.4 Test Result and Data38
- 8. **20dB Bandwidth Measurement Data**.....46
 - 8.1 Test Limit46
 - 8.2 Test Procedures46
 - 8.3 Test Setup Layout46
 - 8.4 Test Result and Data46
- 9. **Frequencies Separation**49
 - 9.1 Test Limit49
 - 9.2 Test Procedures49



- 9.3 Test Setup Layout 49
- 9.4 Test Result and Data 49
- 10. Dwell Time on each channel 52**
 - 10.1 Test Limit 52
 - 10.2 Test Procedures 52
 - 10.3 Test Setup Layout 52
 - 10.4 Test Result and Data 52
- 11. Number of Hopping Channels 55**
 - 11.1 Test Limit 55
 - 11.2 Test Procedures 55
 - 11.3 Test Setup Layout 55
 - 11.4 Test Result and Data 55
- 12. Maximum Peak Output Power 57**
 - 12.1 Test Limit 57
 - 12.2 Test Procedures 57
 - 12.3 Test Setup Layout 57
 - 12.4 Test Result and Data 58
- 13. Radio Frequency Exposure 59**
 - 13.1 EUT Specification 59
 - 13.2 Test Results 59
 - 13.3 Calculation 60
 - 13.4 Maximum Permissible Exposure 61



1. Summary of Test Procedure and Test Results

1.1 Applicable Standards

ANSI C63.10:2013

FCC Rules and Regulations Part 15 Subpart C §15.247

FCC Rule	Description of Test	Result
15.203	. Antenna Requirement	PASS
15.207	. AC Power Line Conducted Emission	PASS
15.209 15.205	. Radiated Spurious Emission	PASS
15.247(d)	. Conducted Spurious Emission	PASS
15.247(a)(1)	. Channel Carrier Frequencies Separation	PASS
15.247(a)(1)	. 20dB Bandwidth	PASS
15.247(a)(1)	. Dwell Time	PASS
15.247(b)	. Number of Hopping Channels	PASS
15.247(b)	. Peak Output Power Measurement Data	PASS

* The lab has reduced the uncertainty risk factor from test equipment, environment and staff technicians which according to the standard on contract. Therefore, the test result will only be determined by standard requirement.

*This EUT has been also tested and compiled with the requirement of FCC Part 15, Subpart B, recorded in a separate test report(21050068-TEFV01).



2. Test Configuration of Equipment under Test

2.1 Feature of Equipment under Test

Frequency Range	NFC: 13.553MHz~13.567MHz BT / BLE: 2402MHz~2480MHz 802.11b/g/n: 2412MHz~2462MHzMHz 802.11a/n/ac: 5180-5240MHz, 5260-5320MHz, 5500-5720MHz, 5745-5825MHz
Modulation Type	NFC: ASK BT: GFSK, $\pi/4$ -DQPSK, 8DPSK BLE: GFSK WLAN: 2.4GHz: 802.11b: CCK, DQPSK, DBPSK 802.11g/n: BPSK, QPSK, 16QAM, 64QAM 5GHz: 802.11n/a: BPSK, QPSK, 16QAM, 64QAM 802.11ac: BPSK, QPSK, 16QAM, 64QAM, 256QAM
Modulation Technology	DSSS, OFDM, FHSS, DTS
Data Rate	BT: GFSK: 1Mbps, $\pi/4$ -DQPSK: 2Mbps, 8DPSK: 3Mbps BLE: GFSK: 1Mbps, GFSK: 2Mbps WLAN: 2.4GHz: 802.11b: 1, 2, 5.5, 11Mbps 802.11g: 6, 9, 12, 18, 24, 36, 48, 54Mbps 802.11n: MCS0 – MCS7, HT20/40 5GHz: 802.11a: 6, 9, 12, 18, 24, 36, 48, 54Mbps 802.11n: MCS0 – MCS7, HT20/40 802.11ac: MCS0 – MCS9, VHT20/40/80
Antenna Type	Internal Antenna
Antenna Gain	For NFC: 13.553MHz~13.567MHz: 0.00dBi For BT / BLE: 2402MHz~2480MHz: 2.00dBi For WLAN: 2412MHz~2462MHz: 2.00dBi 5180-5240 MHz: 4.00dBi 5260-5320MHz: 4.00dBi 5500-5720MHz: 4.00dBi 5745-5825MHz: 4.00dBi
Firmware Number	4.37.45.67-fcddb.g.a12730a.210428.0858

Note:

1. EUT support TPC Function.
2. WLAN 5GHz and BT can simultaneously transmission.
3. EUT supports DFS Client Mode, without radar detection.
4. EUT support indoor / outdoor function.
5. For more details, please refer to the User's manual of the EUT.



2.2 Carrier Frequency of Channes

Channel	Frequency (MHz)	Channel	Frequency (MHz)	Channel	Frequency (MHz)	Channel	Frequency (MHz)
*00	2402	20	2422	40	2442	60	2462
01	2403	21	2423	41	2443	61	2463
02	2404	22	2424	42	2444	62	2464
03	2405	23	2425	43	2445	63	2465
04	2406	24	2426	44	2446	64	2466
05	2407	25	2427	45	2447	65	2467
06	2408	26	2428	46	2448	66	2468
07	2409	27	2429	47	2449	67	2469
08	2410	28	2430	48	2450	68	2470
09	2411	29	2431	49	2451	69	2471
10	2412	30	2432	50	2452	70	2472
11	2413	31	2433	51	2453	71	2473
12	2414	32	2434	52	2454	72	2474
13	2415	33	2435	53	2455	73	2475
14	2416	34	2436	54	2456	74	2476
15	2417	35	2437	55	2457	75	2477
16	2418	36	2438	56	2458	76	2478
17	2419	37	2439	57	2459	77	2479
18	2420	38	2440	58	2460	*78	2480
19	2421	*39	2441	59	2461	---	---

Note: Channels remarked * are selected to perform test.



2.3 Test Mode & Test Software

- a. During testing, the interface cables and equipment positions were varied according to ANSI C63.10
- b. The complete test system included Notebook and EUT for RF test.
- c. An executive program, " hcitool command" under Windows OS system was executed to transmit and receive data via Bluetooth.
- d. The following test modes were performed for the test:

Conducted Emissions from the AC mains power ports	
Test Mode	Operating Description
1	GFSK (1Mbps)
2	$\pi/4$ -DQPSK (2Mbps)
3	8DPSK (3Mbps)
caused "Test Mode 1" generated the worst case, it was reported as the final data.	
Radiation Emissions (9KHz ~30MHz & 30MHz ~ 1GHz)	
Test Mode	Operating Description
1	GFSK (1Mbps)
2	$\pi/4$ -DQPSK (2Mbps)
3	8DPSK (3Mbps)
caused "Test Mode 1" generated the worst case, it was reported as the final data.	
Radiation Emissions (1GHz ~ 25GHz)	
Test Mode	Operating Description
1	GFSK (1Mbps)
2	$\pi/4$ -DQPSK (2Mbps)
3	8DPSK (3Mbps)
caused "Test Mode 1, 3" generated the worst case, they were reported as the final data.	

Modulation Type	TX CONFIGURATION
GFSK	1TX
$\pi/4$ -DQPSK	1TX
8DPSK	1TX



2.4 Description of Test System

RF Conducted				
Equipment	Brand	Model	Serial No	Power cord/Length/Type
Transformer	N/A	2420	E345173	N/A

Radiated Emissions				
Equipment	Brand	Model	Serial No	Power cord/Length/Type
Transformer	N/A	2420	E345173	N/A

AC Power Line Conducted Emission				
Equipment	Brand	Model	Serial No	Power cord/Length/Type
Transformer	N/A	2420	E345173	N/A



2.5 General Information of Test

Test Site	Cerpass Technology Corporation Test Laboratory Address: No.10, Ln. 2, Lianfu St., Luzhu Dist., Taoyuan City 33848, Taiwan (R.O.C.) Tel:+886-3-3226-888 Fax:+886-3-3226-881	
	FCC	TW1439, TW1079
	IC	4934E-1, 4934E-2
	VCCI	T-2205 for Telecommunication test C-4663 for Conducted emission test R-4218 for Radiated emission test G-10812, G-10813 for radiated disturbance above 1GHz
Frequency Range Investigated:	Conducted: from 150kHz to 30 MHz Radiation: from 30 MHz to 25,000MHz	
Test Distance:	The test distance of radiated emission from antenna to EUT is 3 M.	

Test Item	Test Site	Test Period	Environmental Conditions	Tested By
RF Conducted	RFCON01-NK	2021/05/29~2021/05/31	26~28°C / 42~45%	Nick Guan
Radiated Emissions	3M02-NK	2021/05/28~2021/07/01	23~25.6°C / 42~43%	Nick Guan
AC Power Line Conducted Emission	CON01-NK	2021/07/03	26°C / 54%	Dian Chen

2.6 Measurement Uncertainty

Measurement Item	Uncertainty
AC Power Line Conduction(150K~30MHz)	±3.63dB
Radiated Spurious Emission(9KHz~30MHz)	±3.4dB
Radiated Spurious Emission(30MHz~1GHz)	±5.6dB
Radiated Spurious Emission(1GHz~25GHz)	±6.6dB
Conducted Spurious Emission	±1.8dB
6dB Bandwidth	±4.4%
20dB Bandwidth	±4.4%
Occupied Bandwidth	±4.4%
Peak Output Power(Conducted Power Meter)	±1.1dB
Dwell Time / Deactivation Time	±1.2%
Power Spectral Density	±1.8dB
Duty Cycle	±1.2%



3. Test Equipment and Ancillaries Used for Tests

Test Item	Radiated Emissions				
Test Site	Semi Anechoic Room(3M02-NK)				
Instrument	Manufacturer	Model No	Serial No	Calibration Date	Valid Date
Bilog Antenna	Schwarzbeck	VULB9168	369	2021/04/26	2022/04/25
Active Loop Antenna	EMCO	6507	40855	2020/05/21	2021/05/20
Active Loop Antenna	EMCO	6507	40855	2021/06/10	2022/06/09
Horn Antenna	EMCO	3115	31601	2020/10/16	2021/10/15
Horn Antenna	EMCO	3116	31974	2020/09/24	2021/09/23
EMI Receiver	ROHDE & SCHWARZ	ESCI	101200	2020/09/11	2021/09/10
Spectrum Analyzer	ROHDE & SCHWARZ	FSV 40-N	102151	2020/08/03	2021/08/02
Preamplifier	EM Electronics corp.	EM330	60658	2020/10/20	2021/10/19
Preamplifier	EM Electronics corp.	EM330	60660	2021/03/18	2022/03/17
Preamplifier	Agilent	8449B	3008A01954	2021/03/22	2022/03/21
Preamplifier	EMC INSTRUMENTS	EMC184045	980065	2020/11/06	2021/11/05
Bluetooth Tester	ROHDE & SCHWARZ	CBT	101133	2021/04/19	2022/04/18
Cable-3in1(30M-1G)	HARBOUR INDUSTRIES	LL142	CCE1315	2021/04/12	2022/04/11
Cable-0.5m(1G-18G)	EMEC	EM104-SMSM-0.5M	CCE1354	2021/05/06	2022/05/05
Cable-3m(1G-18G)	EMEC	EM104-SMSM-3M	CCE1355	2021/05/06	2022/05/05
Cable-8m(1G-18G)	EMEC	EM104-SMSM-8M	CCE1356	2021/05/06	2022/05/05
Cable-0.5m(30M-40G)	HUBER SUHNER	SUCOFLEX 102	28420/2	2021/04/03	2022/04/02
Cable-3m(30M-40G)	HUBER SUHNER	SUCOFLEX 102	MY2608/2	2021/04/09	2022/04/08
Cable-0.5m(1G-40G)	Rapidtek	40GHZ 50CM	38MS-38MS50314	2021/04/08	2022/04/07
Cable-6m(9k~300M)	NA	EMC5D-BM-BM-6	130605	2020/09/18	2021/09/17
E3	AUDIX	v8.2014-8-6	RK-000529	NA	NA

Test Item	RF Conducted				
Test Site	RFCON01-NK				
Instrument	Manufacturer	Model No	Serial No	Calibration Date	Valid Date
Spectrum Analyzer	ROHDE & SCHWARZ	FSV 40-N	102151	2020/08/03	2021/08/02
Bluetooth Tester	ROHDE & SCHWARZ	CBT	101133	2021/04/19	2022/04/18
CAX Signal Analyzer	KEYSIGHT	N9000B	MY57100339	2020/12/25	2021/12/24
Attenuator	KEYSIGHT	8491B	MY39250703	2021/04/09	2022/04/08
TEMP & HUMI CHAMBER	T-MACHINE	TMJ-9712	T-12-040111	2020/08/25	2021/08/24
Power Meter	Anritsu	ML2495A	1224005	2021/04/14	2022/04/13
Power Sensor	Anritsu	MA2411B	1207295	2021/04/14	2022/04/13

Test Item	AC Power Line Conducted Emission				
Test Site	CON01-NK				
Instrument	Manufacturer	Model No	Serial No	Calibration Date	Valid Date
EMI Receiver	ROHDE & SCHWARZ	ESCI	100821	2020/09/11	2021/09/10
Line Impedance Stabilization Network	Schwarzbeck	NSLK 8127	8127-516	2020/09/26	2021/09/25
Pulse Limiter	ROHDE & SCHWARZ	ESH3-Z2	101933	2020/09/17	2021/09/16
Cable-6m(9k~300M)	NA	EMC5D-BM-BM-6	130605	2020/09/18	2021/09/17
E3	AUDIX	v8.2014-8-6	RK-000531	NA	NA



4. Antenna Requirements

4.1 Standard Applicable

For intentional device, according to FCC 47 CFR Section 15.203, an intentional radiator shall be designed to ensure that no antenna other than that furnished by the responsible party shall be used with the device.

And according to FCC 47 CFR Section 15.247 (b), if transmitting antennas of directional gain greater than 6dBi are used, the power shall be reduced by the amount in dB that the directional gain of the antenna exceeds 6dBi.

4.2 Antenna Construction and Directional Gain

Antenna Type	Internal Antenna
Antenna Gain	2.00 dBi



5. Test of AC Power Line Conducted Emission

5.1 Test Limit

Conducted Emissions were measured from 150 kHz to 30 MHz with a bandwidth of 9 KHz, according to the methods defined in ANSI C63.4-2014. The EUT was placed on a nonmetallic stand in a shielded room 0.8 meters above the ground plane. The interface cables and equipment positioning were varied within limits of reasonable applications to determine the position produced maximum conducted emissions.

Frequency (MHz)	Quasi Peak (dB μ V)	Average (dB μ V)
0.15 – 0.5	66-56*	56-46*
0.5 – 5.0	56	46
5.0 – 30.0	60	50

*Decreases with the logarithm of the frequency.

5.2 Test Procedures

- a. The EUT was placed 0.4 meter from the conducting wall of the shielding room was kept at least 80 centimeters from any other grounded conducting surface.
- b. Connect EUT to the power mains through a line impedance stabilization network (LISN).
- c. All the support units are connecting to the other LISN.
- d. The LISN provides 50 ohm coupling impedance for the measuring instrument.
- e. The FCC states that a 50 ohm, 50 micro-Henry LISN should be used.
- f. Both sides of AC line were checked for maximum conducted interference.
- g. The frequency range from 150 kHz to 30 MHz was searched.
- h. Set the test-receiver system to Peak Detect Function and Specified Bandwidth with Maximum Hold Mode.



5.3 Typical Test Setup

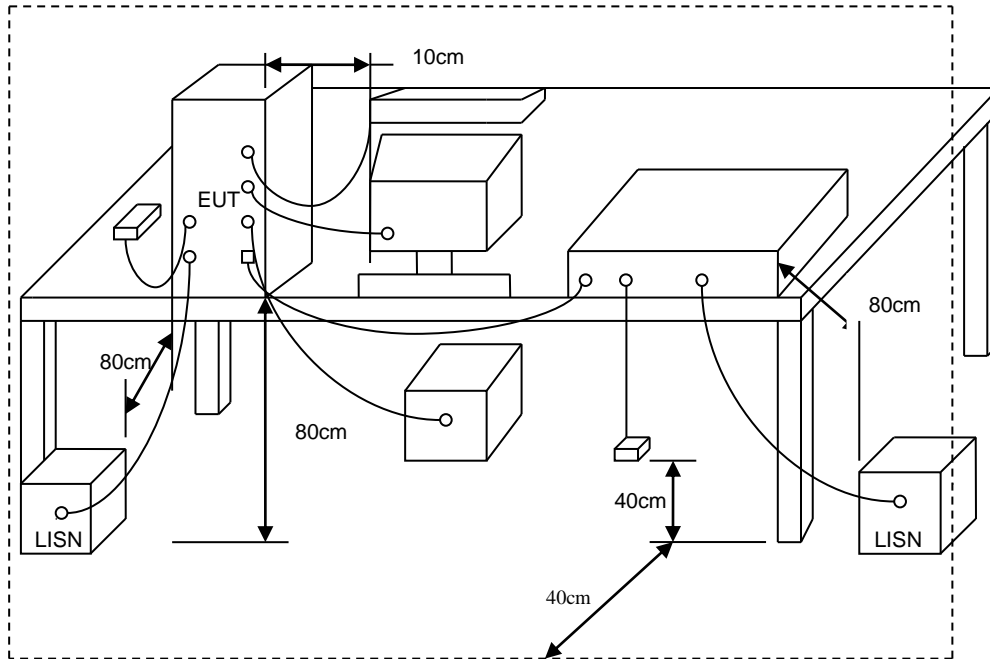



5.4 Test Result and Data

Power	: AC 120V / 60Hz	Pol/Phase	: LINE
Test Mode	: Mode 1		

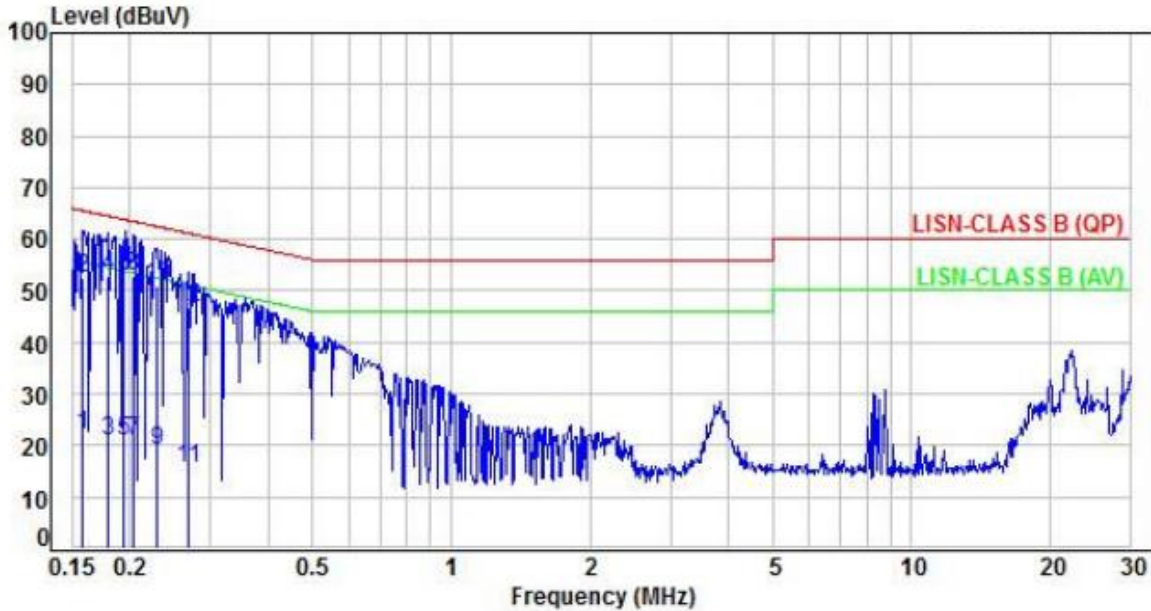

No.	Frequency (MHz)	Factor (dB)	Reading (dBuV)	Level (dBuV)	Limit (dBuV)	Margin (dB)	Detector	P/F
1	0.16	9.96	12.04	22.00	55.56	-33.56	Average	P
2	0.16	9.96	42.48	52.44	65.56	-13.12	QP	P
3	0.18	9.96	10.79	20.75	54.50	-33.75	Average	P
4	0.18	9.96	43.04	53.00	64.50	-11.50	QP	P
5	0.19	9.96	10.89	20.85	53.83	-32.98	Average	P
6	0.19	9.96	42.87	52.83	63.83	-11.00	QP	P
7	0.20	9.96	10.86	20.82	53.45	-32.63	Average	P
8	0.20	9.96	42.82	52.78	63.45	-10.67	QP	P
9	0.23	9.96	8.88	18.84	52.48	-33.64	Average	P
10	0.23	9.96	40.86	50.82	62.48	-11.66	QP	P
11	0.27	9.96	5.65	15.61	51.20	-35.59	Average	P
12	0.27	9.96	36.89	46.85	61.20	-14.35	QP	P

Note: Level=Reading+Factor
 Margin=Level-Limit
 Factor=(LISN or ISN or Current Probe)Factor + Cable Loss



Power	: AC 120V / 60Hz	Pol/Phase	: NEUTRAL
Test Mode	: Mode 1		:

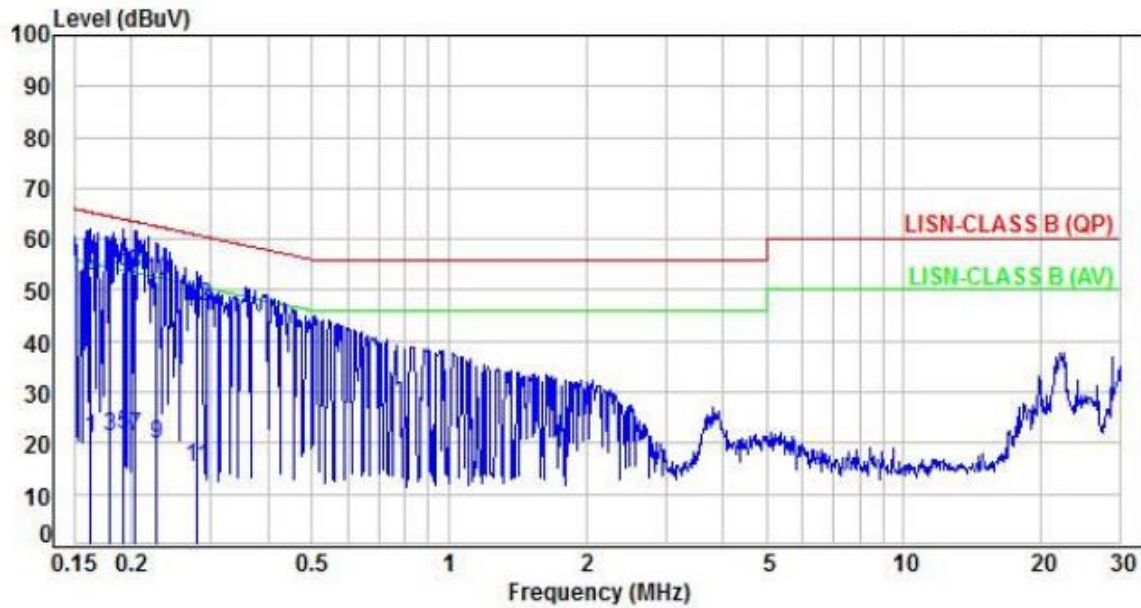

No.	Frequency (MHz)	Factor (dB)	Reading (dBuV)	Level (dBuV)	Limit (dBuV)	Margin (dB)	Detector	P/F
1	0.16	9.97	10.95	20.92	55.34	-34.42	Average	P
2	0.16	9.97	42.80	52.77	65.34	-12.57	QP	P
3	0.18	9.97	11.43	21.40	54.48	-33.08	Average	P
4	0.18	9.97	43.34	53.31	64.48	-11.17	QP	P
5	0.19	9.97	11.84	21.81	53.93	-32.12	Average	P
6	0.19	9.97	43.65	53.62	63.93	-10.31	QP	P
7	0.20	9.97	11.29	21.26	53.45	-32.19	Average	P
8	0.20	9.97	43.22	53.19	63.45	-10.26	QP	P
9	0.23	9.97	9.73	19.70	52.57	-32.87	Average	P
10	0.23	9.97	41.86	51.83	62.57	-10.74	QP	P
11	0.28	9.97	5.20	15.17	50.85	-35.68	Average	P
12	0.28	9.97	36.67	46.64	60.85	-14.21	QP	P

Note: Level=Reading+Factor
 Margin=Level-Limit
 Factor=(LISN or ISN or Current Probe)Factor + Cable Loss



6. Test of Radiated Spurious Emission

6.1 Test Limit

In any 100kHz bandwidth outside the frequency band in which the spread spectrum or digitally modulated intentional radiator is operating, the radio frequency power that is produced by the intentional radiator shall be at least 20dB below that in the 100kHz bandwidth within the band that contains the highest level of the desired power, based on either an RF conducted or a radiated measurement. If the transmitter measurement is based on the maximum conducted output power, the attenuation required under this paragraph shall be 30dB instead of 20dB. In addition, radiated emissions which fall in section 15.205(a) the restricted bands must also comply with the radiated emission limit specified in section 15.209(a).

Frequency (MHz)	Field Strength (microvolt/meter)	Measurement Distance (meters)
0.009 ~ 0.490	2400/F(kHz)	300
0.490 ~ 1.705	24000/F(kHz)	30
1.705 ~ 30.0	30	30
30 ~ 88	100	3
88 ~ 216	150	3
216 ~ 960	200	3
Above 960	500	3

6.2 Test Procedures

- The EUT was placed on a rotatable table top 0.8 meter above ground.
- The EUT was set 3 meters from the interference receiving antenna which was mounted on the top of a variable height antenna tower.
- The table was rotated 360 degrees to determine the position of the highest radiation.
- The antenna is a broadband antenna and its height is varied between one meter and four meters above ground to find the maximum value of the field strength both horizontal polarization and vertical polarization of the antenna are set to make the measurement.
- For each suspected emission the EUT was arranged to its worst case and then tune the antenna tower (from 1 M to 4 M) and turn table (from 0 degree to 360 degrees) to find the maximum reading.
- Set the test-receiver system to Peak or CISPR quasi-peak Detect Function and specified bandwidth with Maximum Hold Mode.
- If the emission level of the EUT in peak mode was 3 dB lower than the limit specified, then testing will be stopped and peak values of EUT will be reported, otherwise, the emissions which do not have 3 dB margin will be repeated one by one using the quasi-peak method and reported.
- For testing above 1GHz, the emission level of the EUT in peak mode was 20dB lower than average limit (that means the emission level in peak mode also complies with the limit in average mode), then testing will be stopped and peak values of EUT will be reported, otherwise, the emissions will be measured in average mode again and reported.
- "Cone of radiation" has been considered to be 3dB bandwidth of the measurement antenna.

Note: The supporting fixture shall permit orientation of the EUT in each of three orthogonal axis positions such that emissions from the EUT are maximized.
(Y -AXIS is the worst.)



6.3 Typical Test Setup

Below 30MHz test setup

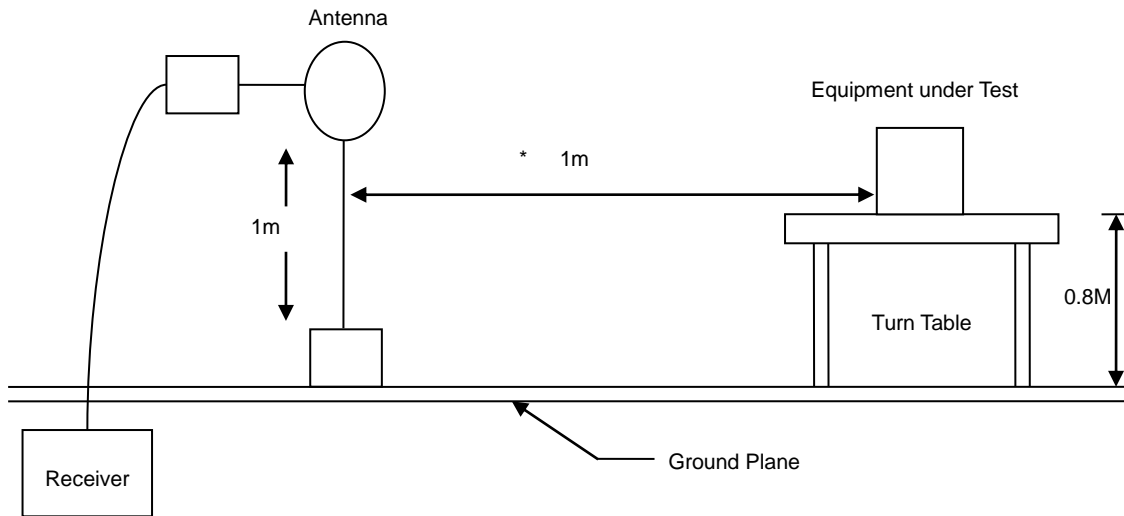

30MHz- 1GHz Test Setup

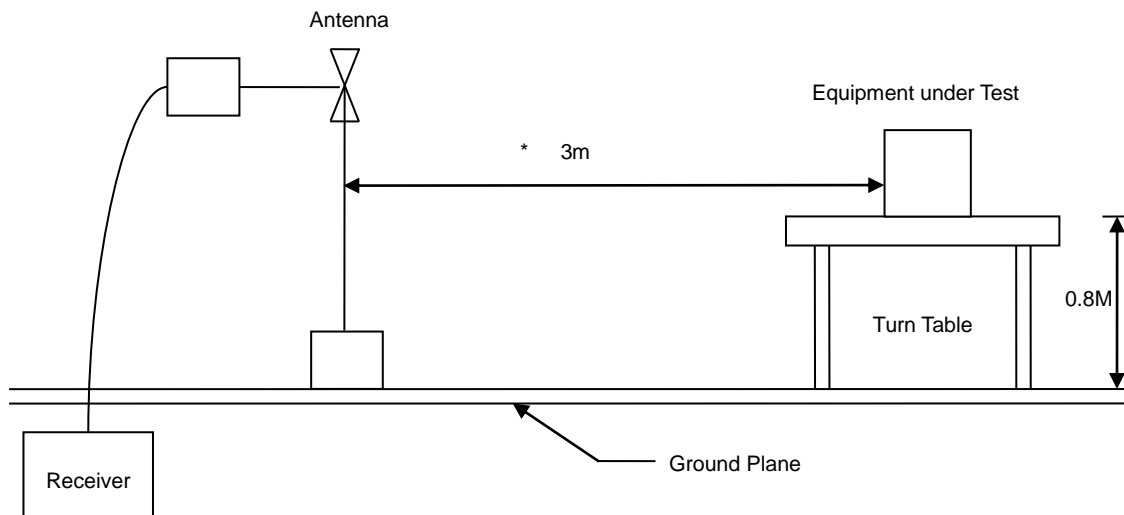

Above 1GHz Test Setup

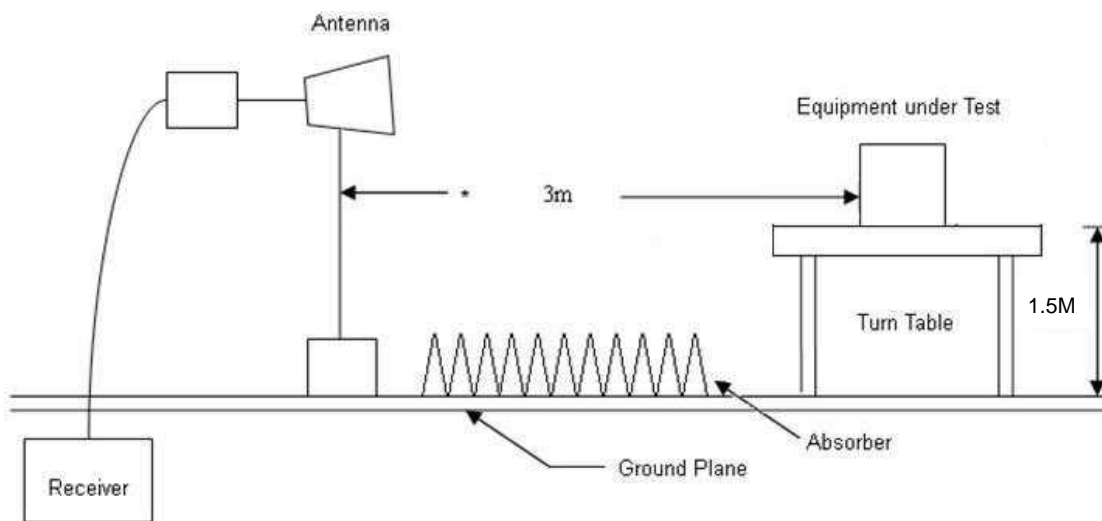



6.4 Test Result and Data (9kHz ~ 30MHz)

The 9kHz-30MHz spurious emission is under limit 20dB more.

6.5 Test Result and Data (30MHz ~ 1GHz)

Power	: AC 120V / 60Hz	Pol/Phase	: VERTICAL
Test Mode	: Mode 1		:

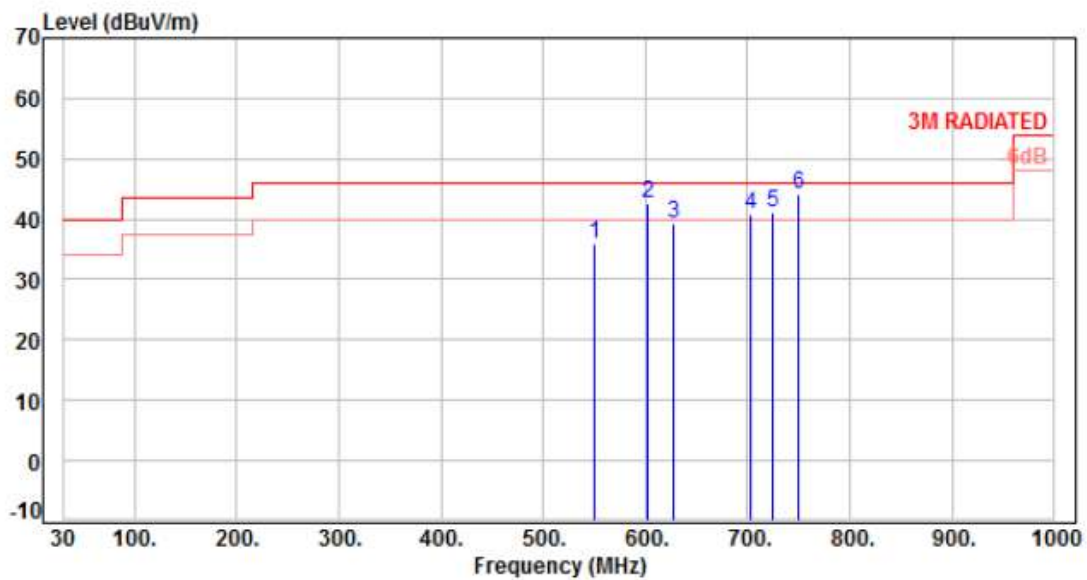

No.	Frequency (MHz)	Factor (dB)	Reading (dBuV)	Level (dBuV/m)	Limit (dBuV/m)	Margin (dB)	Detector	Height (cm)	Azimuth (deg)	P/F
1	550.13	-3.69	39.48	35.79	46.00	-10.21	Peak	400	360	P
2	602.64	-2.56	45.32	42.76	46.00	-3.24	Peak	400	360	P
3	627.32	-2.07	41.21	39.14	46.00	-6.86	Peak	400	360	P
4	703.21	-1.08	41.78	40.70	46.00	-5.30	Peak	400	360	P
5	725.31	-0.90	41.96	41.06	46.00	-4.94	Peak	400	360	P
6	749.32	-0.24	44.31	44.07	46.00	-1.93	QP	125	356	P

Note: Level=Reading+Factor
Margin=Level-Limit
Factor=Antenna Factor + cable loss - Amplifier Factor



Power	: AC 120V / 60Hz	Pol/Phase	: HORIZONTAL
Test Mode	: Mode 1		:

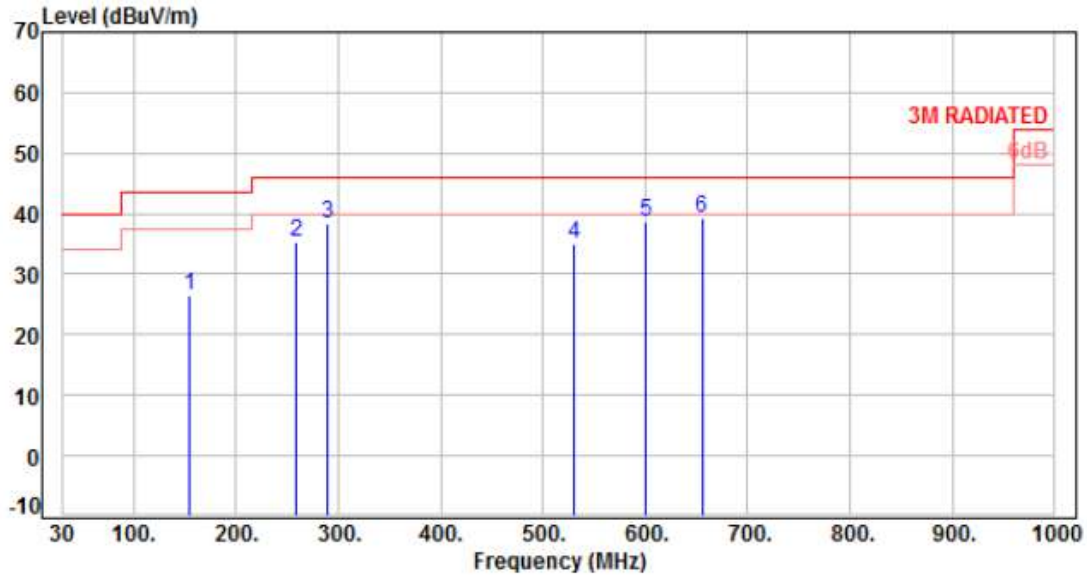

No.	Frequency (MHz)	Factor (dB)	Reading (dBuV)	Level (dBuV/m)	Limit (dBuV/m)	Margin (dB)	Detector	Height (cm)	Azimuth (deg)	P/F
1	154.32	-10.85	37.24	26.39	43.50	-17.11	Peak	400	360	P
2	259.35	-11.19	46.52	35.33	46.00	-10.67	Peak	400	360	P
3	289.33	-9.96	48.42	38.46	46.00	-7.54	Peak	400	360	P
4	531.13	-4.16	39.06	34.90	46.00	-11.10	Peak	400	360	P
5	600.80	-2.60	41.23	38.63	46.00	-7.37	Peak	400	360	P
6	655.32	-1.82	41.11	39.29	46.00	-6.71	Peak	400	360	P

Note: Level=Reading+Factor
Margin=Level-Limit
Factor=Antenna Factor + cable loss - Amplifier Factor



6.6 Test Result and Data (1GHz ~ 25GHz)

Power	: AC 120V / 60Hz	Pol/Phase	: VERTICAL
Test Mode	: Mode 1, CH00		:

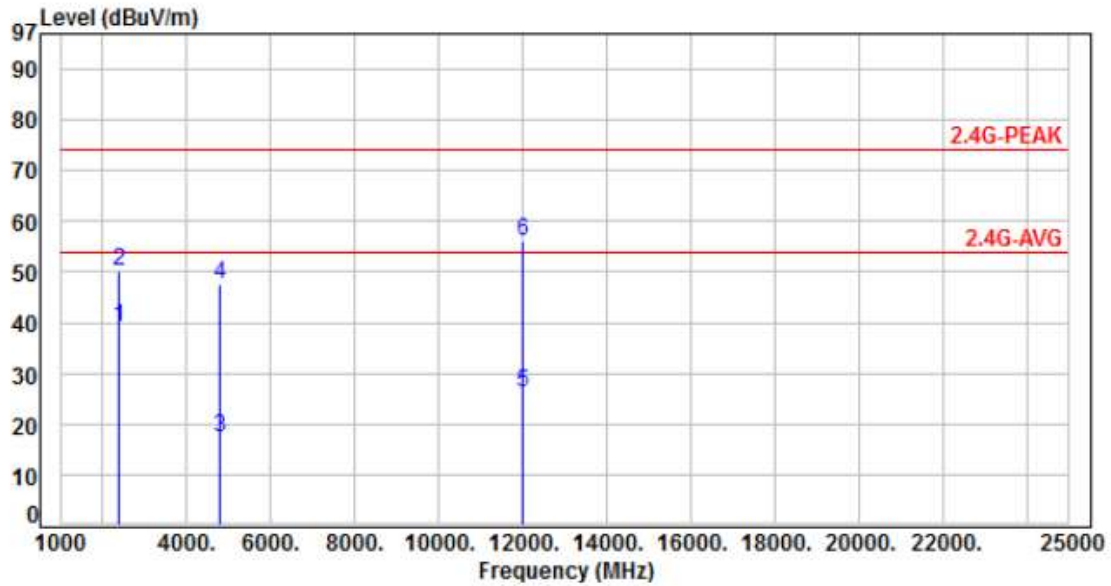

No.	Frequency (MHz)	Factor (dB)	Reading (dBuV)	Level (dBuV/m)	Limit (dBuV/m)	Margin (dB)	Detector	Height (cm)	Azimuth (deg)	P/F
1	2390.00	-3.62	42.73	39.11	54.00	-14.89	Average	127	250	P
2	2390.00	-3.62	53.93	50.31	74.00	-23.69	Peak	127	250	P
3	4804.00	3.66	13.75	17.41	54.00	-36.59	Average	264	344	P
4	4804.00	3.66	43.85	47.51	74.00	-26.49	Peak	264	344	P
5	12010.00	13.39	12.68	26.07	54.00	-27.93	Average	100	297	P
6	12010.00	13.39	42.78	56.17	74.00	-17.83	Peak	100	297	P

Note: Level=Reading+Factor
Margin=Level-Limit
Factor=Antenna Factor + cable loss - Amplifier Factor



Power	: AC 120V / 60Hz	Pol/Phase	: HORIZONTAL
Test Mode	: Mode 1, CH00		

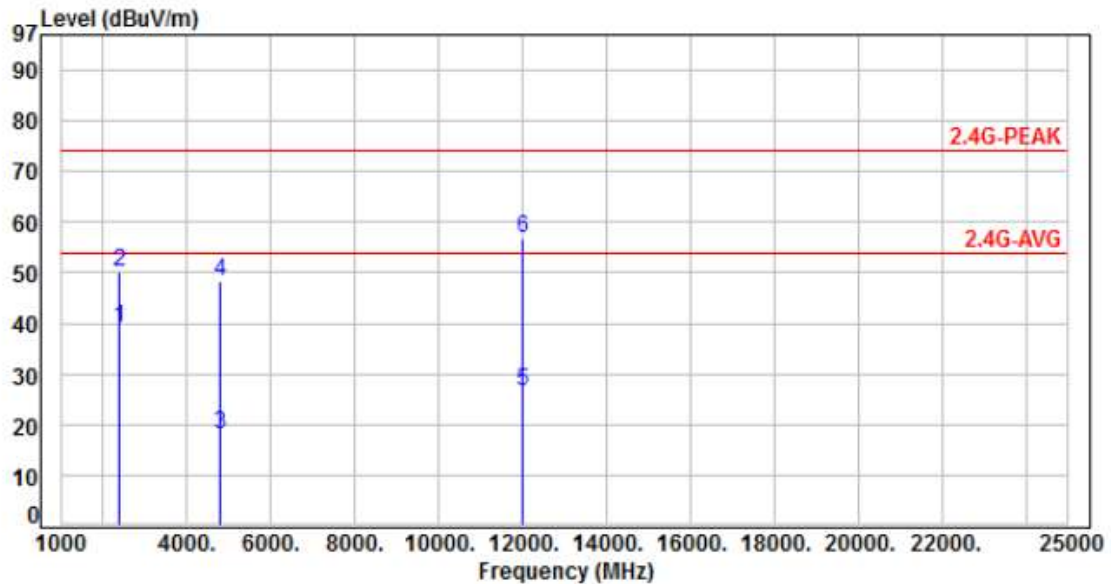

No.	Frequency (MHz)	Factor (dB)	Reading (dBuV)	Level (dBuV/m)	Limit (dBuV/m)	Margin (dB)	Detector	Height (cm)	Azimuth (deg)	P/F
1	2390.00	-3.62	42.61	38.99	54.00	-15.01	Average	226	169	P
2	2390.00	-3.62	53.84	50.22	74.00	-23.78	Peak	226	169	P
3	4804.00	3.66	14.55	18.21	54.00	-35.79	Average	100	351	P
4	4804.00	3.66	44.65	48.31	74.00	-25.69	Peak	100	351	P
5	12010.00	13.39	13.22	26.61	54.00	-27.39	Average	100	173	P
6	12010.00	13.39	43.32	56.71	74.00	-17.29	Peak	100	173	P

Note: Level=Reading+Factor
 Margin=Level-Limit
 Factor=Antenna Factor + cable loss - Amplifier Factor



Power	: AC 120V / 60Hz	Pol/Phase	: VERTICAL
Test Mode	: Mode 1, CH39		:

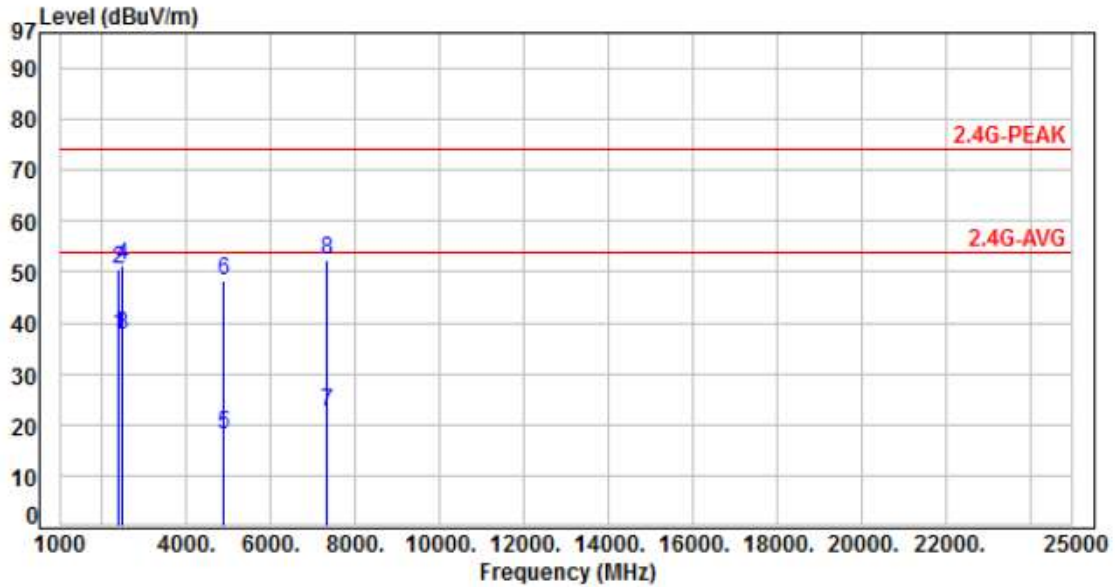

No.	Frequency (MHz)	Factor (dB)	Reading (dBuV)	Level (dBuV/m)	Limit (dBuV/m)	Margin (dB)	Detector	Height (cm)	Azimuth (deg)	P/F
1	2390.00	-3.62	41.20	37.58	54.00	-16.42	Average	361	14	P
2	2390.00	-3.62	54.14	50.52	74.00	-23.48	Peak	361	14	P
3	2483.50	-3.40	41.07	37.67	54.00	-16.33	Average	361	14	P
4	2483.50	-3.40	54.69	51.29	74.00	-22.71	Peak	361	14	P
5	4882.00	3.91	14.30	18.21	54.00	-35.79	Average	100	334	P
6	4882.00	3.91	44.40	48.31	74.00	-25.69	Peak	100	334	P
7	7323.00	8.52	13.84	22.36	54.00	-31.64	Average	100	291	P
8	7323.00	8.52	43.94	52.46	74.00	-21.54	Peak	100	291	P

Note: Level=Reading+Factor
 Margin=Level-Limit
 Factor=Antenna Factor + cable loss - Amplifier Factor



Power	: AC 120V / 60Hz	Pol/Phase	: HORIZONTAL
Test Mode	: Mode 1, CH39		:

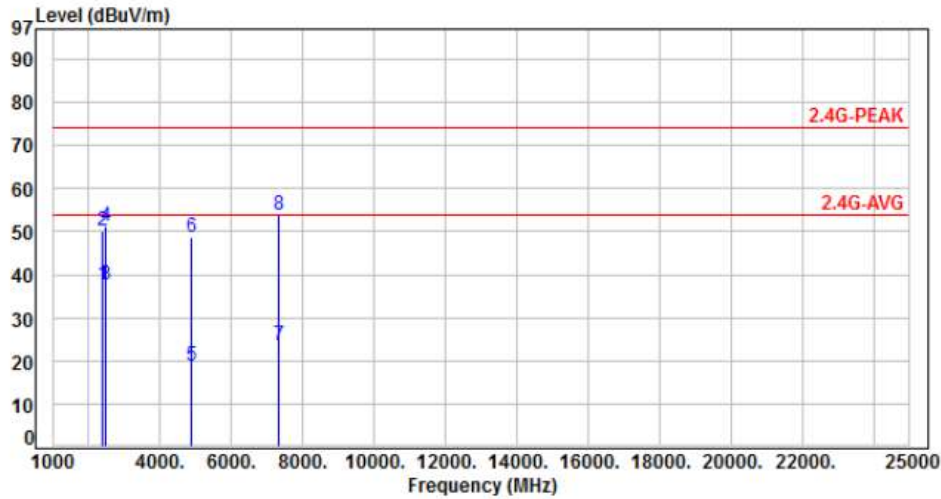

No.	Frequency (MHz)	Factor (dB)	Reading (dBuV)	Level (dBuV/m)	Limit (dBuV/m)	Margin (dB)	Detector	Height (cm)	Azimuth (deg)	P/F
1	2390.00	-3.62	41.14	37.52	54.00	-16.48	Average	400	227	P
2	2390.00	-3.62	53.76	50.14	74.00	-23.86	Peak	400	227	P
3	2483.50	-3.40	41.08	37.68	54.00	-16.32	Average	400	227	P
4	2483.50	-3.40	54.58	51.18	74.00	-22.82	Peak	400	227	P
5	4882.00	3.91	14.73	18.64	54.00	-35.36	Average	242	342	P
6	4882.00	3.91	44.83	48.74	74.00	-25.26	Peak	242	342	P
7	7323.00	8.52	15.20	23.72	54.00	-30.28	Average	172	267	P
8	7323.00	8.52	45.30	53.82	74.00	-20.18	Peak	172	267	P

Note: Level=Reading+Factor
 Margin=Level-Limit
 Factor=Antenna Factor + cable loss - Amplifier Factor



Power	: AC 120V / 60Hz	Pol/Phase	: VERTICAL
Test Mode	: Mode 1, CH78		:

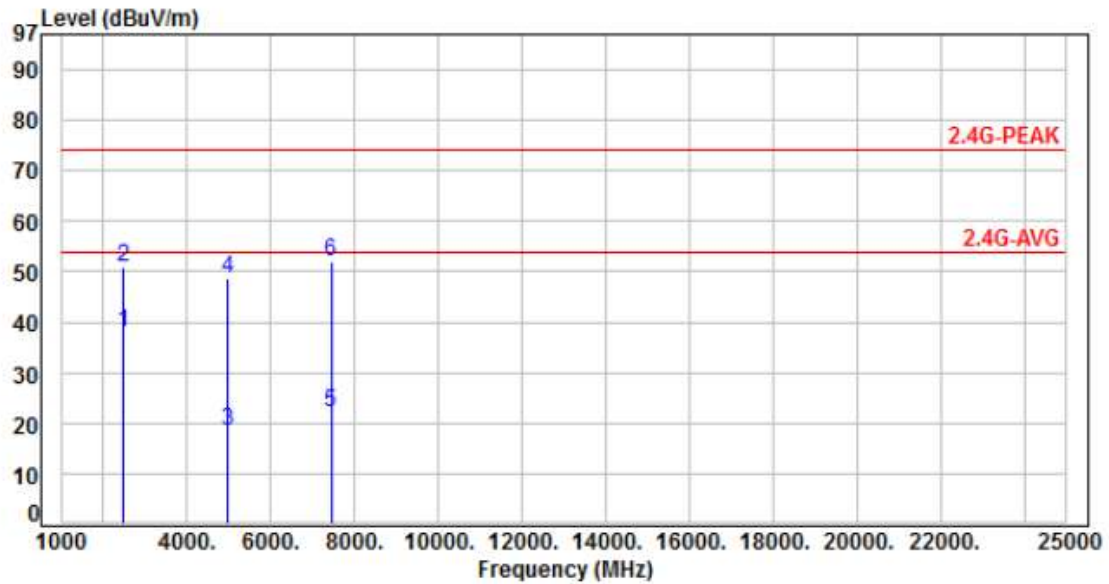

No.	Frequency (MHz)	Factor (dB)	Reading (dBuV)	Level (dBuV/m)	Limit (dBuV/m)	Margin (dB)	Detector	Height (cm)	Azimuth (deg)	P/F
1	2483.50	-3.40	41.34	37.94	54.00	-16.06	Average	385	7	P
2	2483.50	-3.40	54.26	50.86	74.00	-23.14	Peak	385	7	P
3	4960.00	4.27	14.13	18.40	54.00	-35.60	Average	100	341	P
4	4960.00	4.27	44.23	48.50	74.00	-25.50	Peak	100	341	P
5	7440.00	8.61	13.46	22.07	54.00	-31.93	Average	100	287	P
6	7440.00	8.61	43.56	52.17	74.00	-21.83	Peak	100	287	P

Note: Level=Reading+Factor
 Margin=Level-Limit
 Factor=Antenna Factor + cable loss - Amplifier Factor



Power	: AC 120V / 60Hz	Pol/Phase	: HORIZONTAL
Test Mode	: Mode 1, CH78		

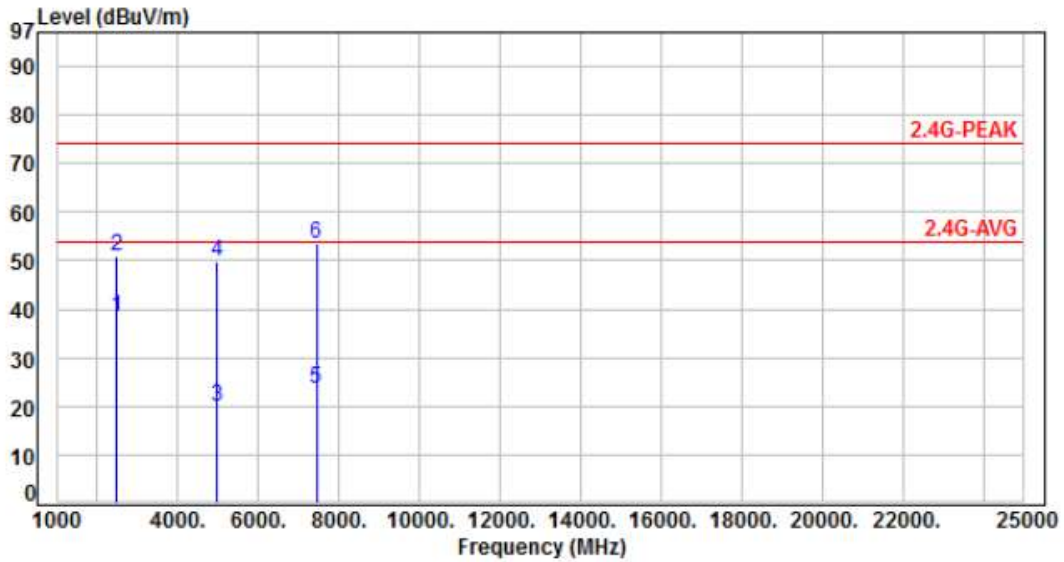

No.	Frequency (MHz)	Factor (dB)	Reading (dBuV)	Level (dBuV/m)	Limit (dBuV/m)	Margin (dB)	Detector	Height (cm)	Azimuth (deg)	P/F
1	2483.50	-3.40	41.58	38.18	54.00	-15.82	Average	285	224	P
2	2483.50	-3.40	54.48	51.08	74.00	-22.92	Peak	285	224	P
3	4960.00	4.27	15.56	19.83	54.00	-34.17	Average	152	351	P
4	4960.00	4.27	45.66	49.93	74.00	-24.07	Peak	152	351	P
5	7440.00	8.61	14.84	23.45	54.00	-30.55	Average	152	269	P
6	7440.00	8.61	44.94	53.55	74.00	-20.45	Peak	152	269	P

Note: Level=Reading+Factor

Margin=Level-Limit

Factor=Antenna Factor + cable loss - Amplifier Factor



Power	: AC 120V / 60Hz	Pol/Phase	: VERTICAL
Test Mode	: Mode 3, CH00		:

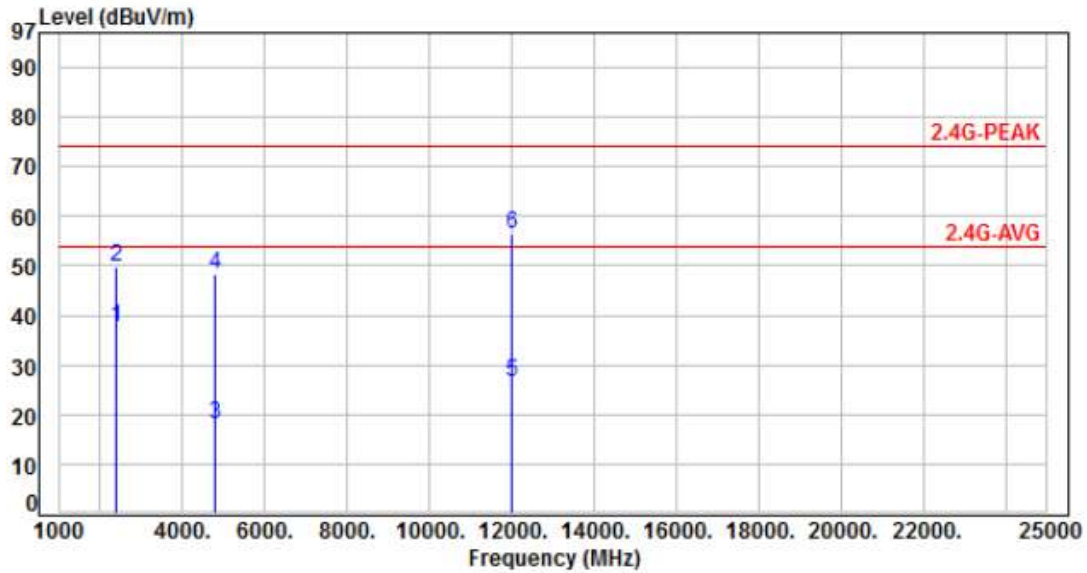

No.	Frequency (MHz)	Factor (dB)	Reading (dBuV)	Level (dBuV/m)	Limit (dBuV/m)	Margin (dB)	Detector	Height (cm)	Azimuth (deg)	P/F
1	2390.00	-3.62	41.19	37.57	54.00	-16.43	Average	126	246	P
2	2390.00	-3.62	53.23	49.61	74.00	-24.39	Peak	126	246	P
3	4804.00	3.66	14.58	18.24	54.00	-35.76	Average	100	348	P
4	4804.00	3.66	44.68	48.34	74.00	-25.66	Peak	100	348	P
5	12010.00	13.39	13.12	26.51	54.00	-27.49	Average	100	247	P
6	12010.00	13.39	43.22	56.61	74.00	-17.39	Peak	100	247	P

Note: Level=Reading+Factor
 Margin=Level-Limit
 Factor=Antenna Factor + cable loss - Amplifier Factor



Power	: AC 120V / 60Hz	Pol/Phase	: HORIZONTAL
Test Mode	: Mode 3, CH00		:

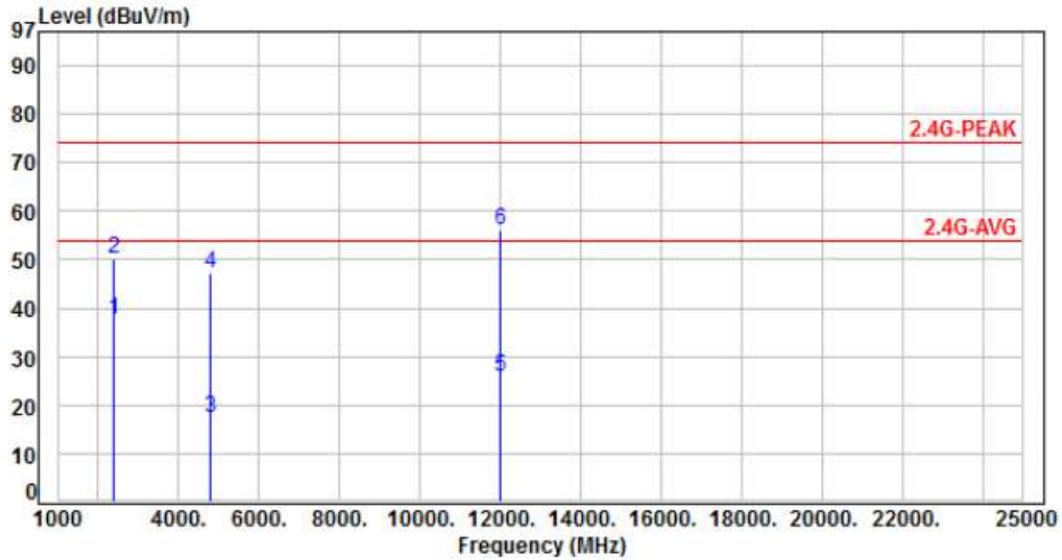

No.	Frequency (MHz)	Factor (dB)	Reading (dBuV)	Level (dBuV/m)	Limit (dBuV/m)	Margin (dB)	Detector	Height (cm)	Azimuth (deg)	P/F
1	2390.00	-3.62	41.13	37.51	54.00	-16.49	Average	117	222	P
2	2390.00	-3.62	53.67	50.05	74.00	-23.95	Peak	117	222	P
3	4804.00	3.66	13.56	17.22	54.00	-36.78	Average	100	7	P
4	4804.00	3.66	43.66	47.32	74.00	-26.68	Peak	100	7	P
5	12010.00	13.39	12.52	25.91	54.00	-28.09	Average	100	187	P
6	12010.00	13.39	42.62	56.01	74.00	-17.99	Peak	100	187	P

Note: Level=Reading+Factor
 Margin=Level-Limit
 Factor=Antenna Factor + cable loss - Amplifier Factor



Power	: AC 120V / 60Hz	Pol/Phase	: VERTICAL
Test Mode	: Mode 3, CH39		:

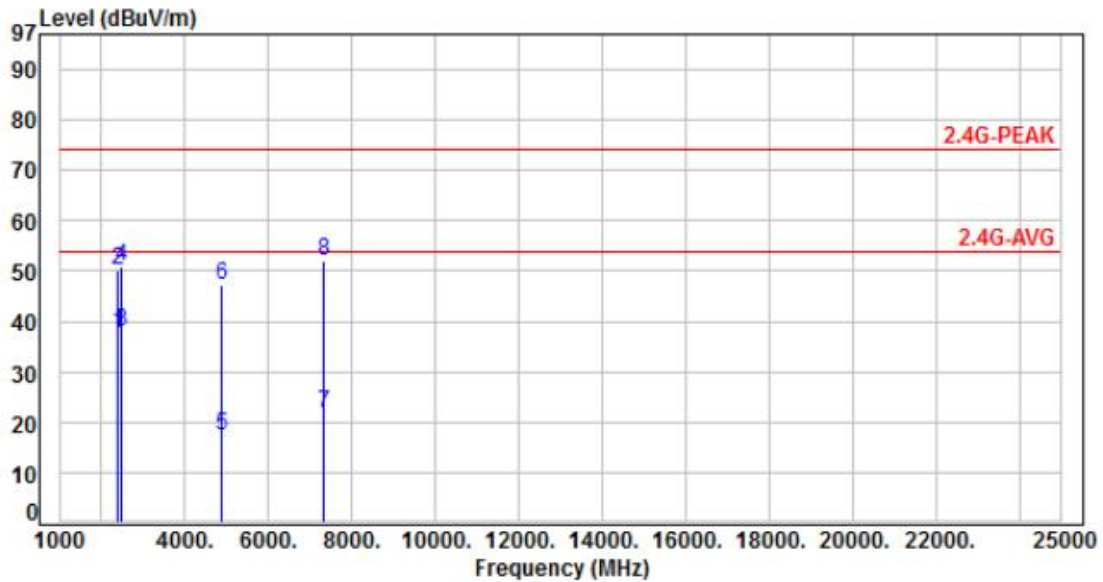

No.	Frequency (MHz)	Factor (dB)	Reading (dBuV)	Level (dBuV/m)	Limit (dBuV/m)	Margin (dB)	Detector	Height (cm)	Azimuth (deg)	P/F
1	2390.00	-3.62	41.06	37.44	54.00	-16.56	Average	355	22	P
2	2390.00	-3.62	53.96	50.34	74.00	-23.66	Peak	355	22	P
3	2483.50	-3.40	41.33	37.93	54.00	-16.07	Average	355	22	P
4	2483.50	-3.40	54.23	50.83	74.00	-23.17	Peak	355	22	P
5	4882.00	3.91	13.25	17.16	54.00	-36.84	Average	100	4	P
6	4882.00	3.91	43.35	47.26	74.00	-26.74	Peak	100	4	P
7	7323.00	8.52	13.41	21.93	54.00	-32.07	Average	100	76	P
8	7323.00	8.52	43.51	52.03	74.00	-21.97	Peak	100	76	P

Note: Level=Reading+Factor
 Margin=Level-Limit
 Factor=Antenna Factor + cable loss - Amplifier Factor



Power	: AC 120V / 60Hz	Pol/Phase	: HORIZONTAL
Test Mode	: Mode 3, CH39		:

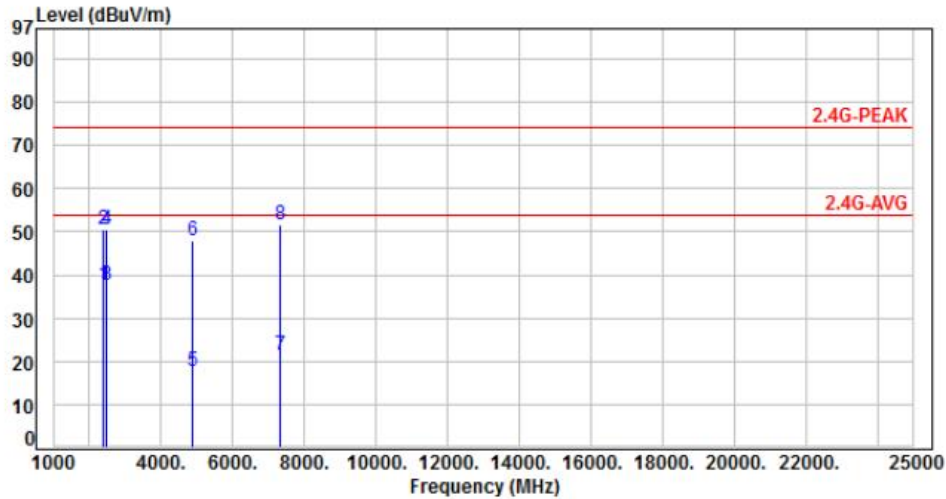

No.	Frequency (MHz)	Factor (dB)	Reading (dBuV)	Level (dBuV/m)	Limit (dBuV/m)	Margin (dB)	Detector	Height (cm)	Azimuth (deg)	P/F
1	2390.00	-3.62	41.16	37.54	54.00	-16.46	Average	100	225	P
2	2390.00	-3.62	54.32	50.70	74.00	-23.30	Peak	100	225	P
3	2483.50	-3.40	41.05	37.65	54.00	-16.35	Average	100	225	P
4	2483.50	-3.40	53.92	50.52	74.00	-23.48	Peak	100	225	P
5	4882.00	3.91	13.77	17.68	54.00	-36.32	Average	100	350	P
6	4882.00	3.91	43.87	47.78	74.00	-26.22	Peak	100	350	P
7	7323.00	8.52	12.87	21.39	54.00	-32.61	Average	100	276	P
8	7323.00	8.52	42.97	51.49	74.00	-22.51	Peak	100	276	P

Note: Level=Reading+Factor
 Margin=Level-Limit
 Factor=Antenna Factor + cable loss - Amplifier Factor



Power	: AC 120V / 60Hz	Pol/Phase	: VERTICAL
Test Mode	: Mode 3, CH78		:

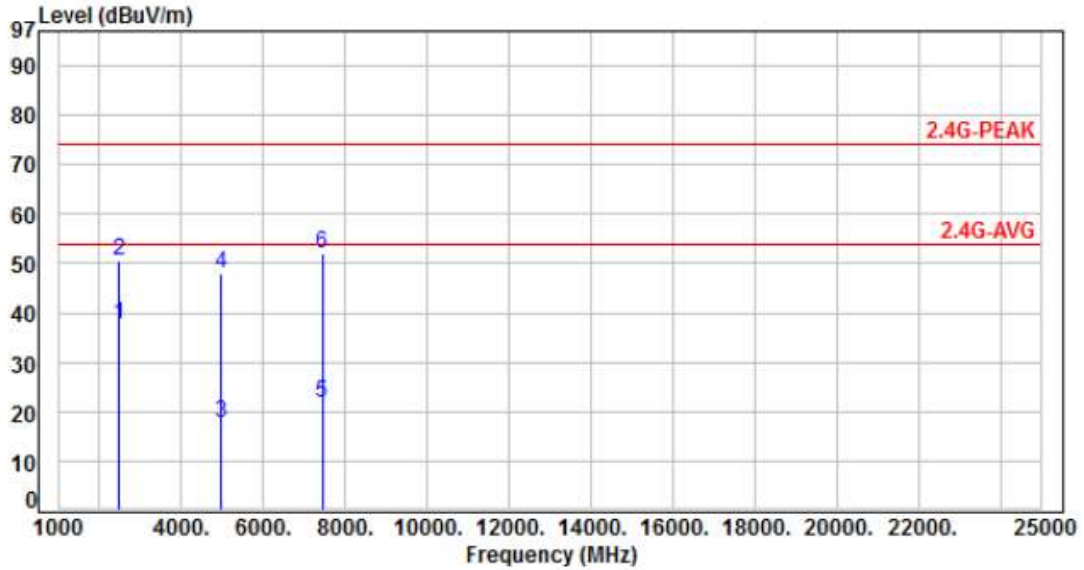

No.	Frequency (MHz)	Factor (dB)	Reading (dBuV)	Level (dBuV/m)	Limit (dBuV/m)	Margin (dB)	Detector	Height (cm)	Azimuth (deg)	P/F
1	2483.50	-3.40	41.20	37.80	54.00	-16.20	Average	143	38	P
2	2483.50	-3.40	53.77	50.37	74.00	-23.63	Peak	143	38	P
3	4960.00	4.27	13.44	17.71	54.00	-36.29	Average	100	97	P
4	4960.00	4.27	43.54	47.81	74.00	-26.19	Peak	100	97	P
5	7440.00	8.61	13.24	21.85	54.00	-32.15	Average	100	67	P
6	7440.00	8.61	43.34	51.95	74.00	-22.05	Peak	100	67	P

Note: Level=Reading+Factor
Margin=Level-Limit
Factor=Antenna Factor + cable loss - Amplifier Factor



Power	: AC 120V / 60Hz	Pol/Phase	: HORIZONTAL
Test Mode	: Mode 3, CH78		:

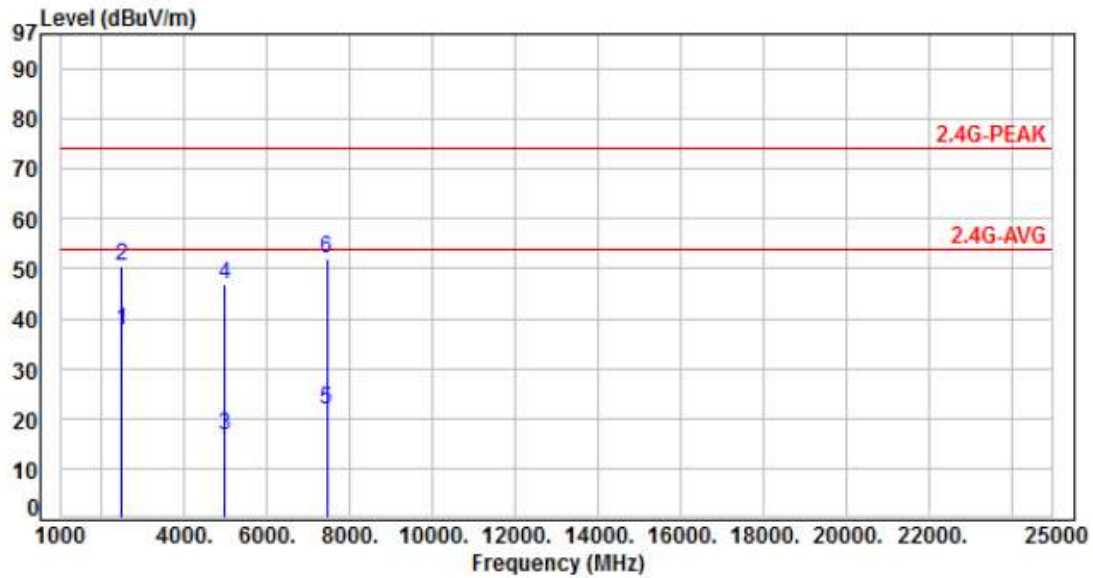

No.	Frequency (MHz)	Factor (dB)	Reading (dBuV)	Level (dBuV/m)	Limit (dBuV/m)	Margin (dB)	Detector	Height (cm)	Azimuth (deg)	P/F
1	2483.50	-3.40	41.14	37.74	54.00	-16.26	Average	100	114	P
2	2483.50	-3.40	53.75	50.35	74.00	-23.65	Peak	100	114	P
3	4960.00	4.27	12.43	16.70	54.00	-37.30	Average	100	167	P
4	4960.00	4.27	42.53	46.80	74.00	-27.20	Peak	100	167	P
5	7440.00	8.61	13.29	21.90	54.00	-32.10	Average	141	255	P
6	7440.00	8.61	43.39	52.00	74.00	-22.00	Peak	141	255	P

Note: Level=Reading+Factor
 Margin=Level-Limit
 Factor=Antenna Factor + cable loss - Amplifier Factor



6.7 Restricted Bands of Operation

Only spurious emissions are permitted in any of the frequency bands listed below:

MHz	MHz	MHz	GHz
0.09000 – 0.11000	16.42000 – 16.42300	399.9 – 410.0	4.500 – 5.250
0.49500 – 0.505**	16.69475 – 16.69525	608.0 – 614.0	5.350 – 5.460
2.17350 – 2.19050	16.80425 – 16.80475	960.0 – 1240.0	7.250 – 7.750
4.12500 – 4.12800	25.50000 – 25.67000	1300.0 – 1427.0	8.025 – 8.500
4.17725 – 4.17775	37.50000 – 38.25000	1435.0 – 1626.5	9.000 – 9.200
4.20725 – 4.20775	73.00000 – 74.60000	1645.5 – 1646.5	9.300 – 9.500
6.21500 – 6.21800	74.80000 – 75.20000	1660.0 – 1710.0	10.600 – 12.700
6.26775 – 6.26825	108.00000 – 121.94000	1718.8 – 1722.2	13.250 – 13.400
6.31175 – 6.31225	123.00000 – 138.00000	2200.0 – 2300.0	14.470 – 14.500
8.29100 – 8.29400	149.90000 – 150.05000	2310.0 – 2390.0	15.350 – 16.200
8.36200 – 8.36600	156.52475 – 156.52525	2483.5 – 2500.0	17.700 – 21.400
8.37625 – 8.38675	156.70000 – 156.90000	2655.0 – 2900.0	22.010 – 23.120
8.41425 – 8.41475	162.01250 – 167.17000	3260.0 – 3267.0	23.600 – 24.000
12.29000 – 12.29300	167.72000 – 173.20000	3332.0 – 3339.0	31.200 – 31.800
12.51975 – 12.52025	240.00000 – 285.00000	3345.8 – 3358.0	36.430 – 36.500
12.57675 – 12.57725	322.00000 – 335.40000	3600.0 – 4400.0	Above 38.6
13.36000 – 13.41000			

** : Until February 1, 1999, this restricted band shall be 0.490-0.510 MHz



7. Test of Conducted Spurious Emission

7.1 Test Limit

Below -20dB of the highest emission level of operating band (in 100kHz Resolution Bandwidth).

7.2 Test Procedure

- a. The transmitter output was connected to the spectrum analyzer via a low loss cable.
- b. Set RBW of spectrum analyzer to 100 KHz and VBW of spectrum analyzer to 300 KHz with convenient frequency span including 100 KHz bandwidth from band edge.
- c. The band edges was measured and recorded.

7.3 Test Setup Layout

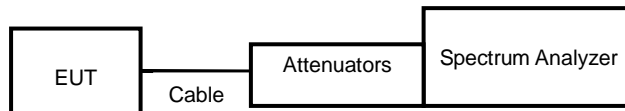

7.4 Test Result and Data

Note: Test plots refer to the following pages.



Modulation Type: GFSK (1Mbps)
Channel: 00

Modulation Type: GFSK (1Mbps)
Channel: 39

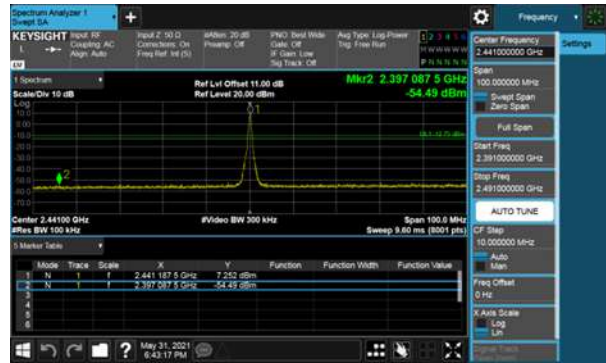



Modulation Type: GFSK (1Mbps)
Channel: 78



Modulation Type: $\pi/4$ -DQPSK (2Mbps)
Channel: 00

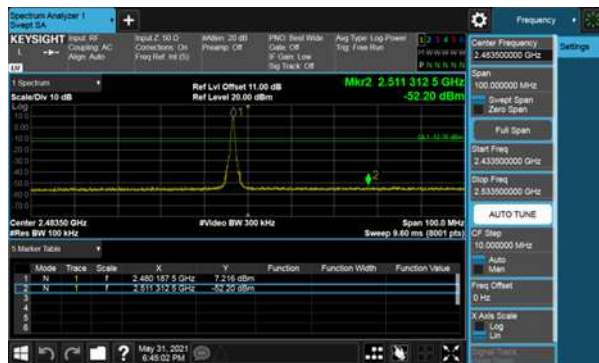



Modulation Type: $\pi/4$ -DQPSK (2Mbps)
Channel: 39

Modulation Type: $\pi/4$ -DQPSK (2Mbps)
Channel: 78





Modulation Type: 8DPSK (3Mbps)
Channel: 00

Modulation Type: 8DPSK (3Mbps)
Channel: 39

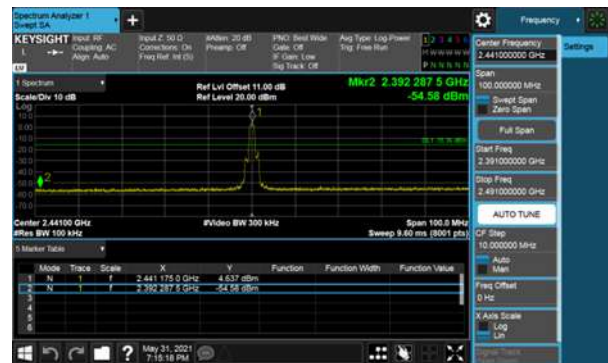
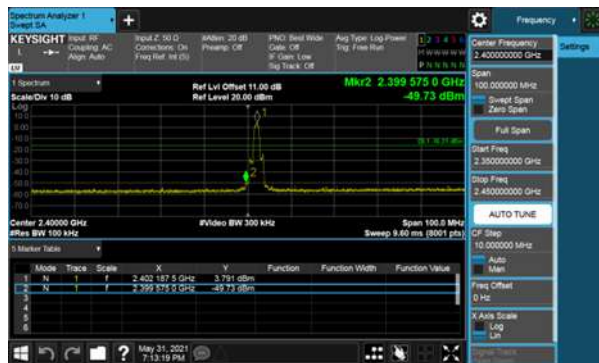



Modulation Type: 8DPSK (3Mbps)
Channel: 78





Hopping Mode: Modulation Type: GFSK



Modulation Type: $\pi/4$ -DQPSK





Modulation Type: 8DPSK

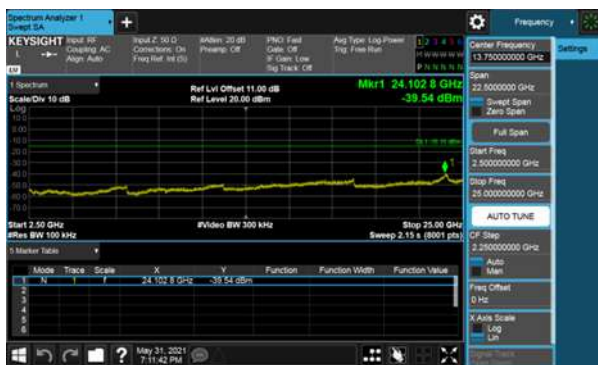



8. 20dB Bandwidth Measurement Data

8.1 Test Limit

Frequency hopping systems shall have hopping channel carrier frequencies separated by a minimum of 25 kHz or the 20 dB bandwidth of the hopping channel, whichever is greater. Alternatively, frequency hopping systems operating in the 2400–2483.5 MHz band may have hopping channel carrier frequencies that are separated by 25 kHz or two-thirds of the 20 dB bandwidth of the hopping channel, whichever is greater, provided the systems operate with an output power no greater than 125 mW.

8.2 Test Procedures

- a. The transmitter output was connected to the spectrum analyzer.
- b. Set RBW of spectrum analyzer to 1~5% of the 20Db bandwidth and VBW to approximately three time RBW..
- c. The 20 dB bandwidth is defined as the total spectrum the power of which is higher than peak power minus 20 dB.

8.3 Test Setup Layout

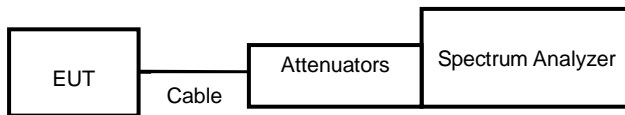

8.4 Test Result and Data

Modulation Type	Channel	Frequency (MHz)	20dB Bandwidth (MHz)	2/3 20dB Bandwidth (MHz)
GFSK	0	2402	1.030	0.687
	39	2441	1.108	0.739
	78	2480	1.029	0.686
π/4-DQPSK	0	2402	1.359	0.906
	39	2441	1.361	0.907
	78	2480	1.362	0.908
8DPSK	0	2402	1.318	0.879
	39	2441	1.316	0.877
	78	2480	1.320	0.880



Modulation Type: GFSK (1Mbps)
Channel: 00

Modulation Type: $\pi/4$ -DQPSK (2Mbps)
Channel: 00



CH39

CH39



CH78

CH78





Modulation Type: 8DPSK (3Mbps)
Channel: 00



CH39



CH78





9. Frequencies Separation

9.1 Test Limit

Frequency hopping systems shall have hopping channel carrier frequencies separated by a minimum of 25 kHz or the 20 dB bandwidth of the hopping channel, whichever is greater.

9.2 Test Procedures

- a. The transmitter output was connected to the spectrum analyzer.
- b. Set RBW of spectrum analyzer to 100 KHz and VBW to 300 KHz. or (30 KHz and VBW to 100 KHz.)
- c. By using the MaxHold function record the separation of two adjacent channels.
- d. Measure the frequency difference of these two adjacent channels.

9.3 Test Setup Layout

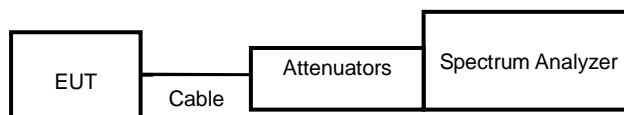

9.4 Test Result and Data

Modulation Type	Channel	Frequency (MHz)	Channel Separation (MHz)	Limit (MHz)
GFSK	0	2402	1.002	0.687
	39	2441	1.002	0.739
	78	2480	1.002	0.686
$\pi/4$ -DQPSK	0	2402	1.002	0.906
	39	2441	1.002	0.907
	78	2480	1.002	0.908
8DPSK	0	2402	1.002	0.879
	39	2441	1.002	0.877
	78	2480	1.002	0.880



Modulation Type: GFSK (1Mbps)
Channel: 00

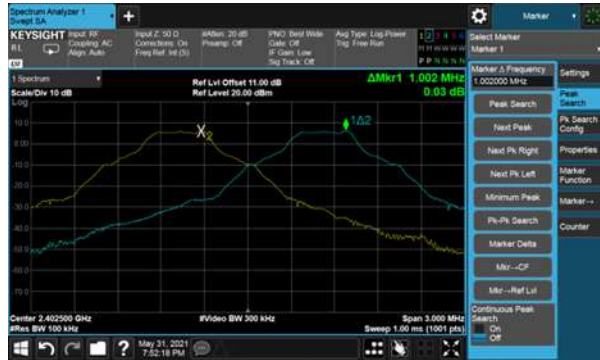

Modulation Type: $\pi/4$ -DQPSK (2Mbps)
Channel: 00

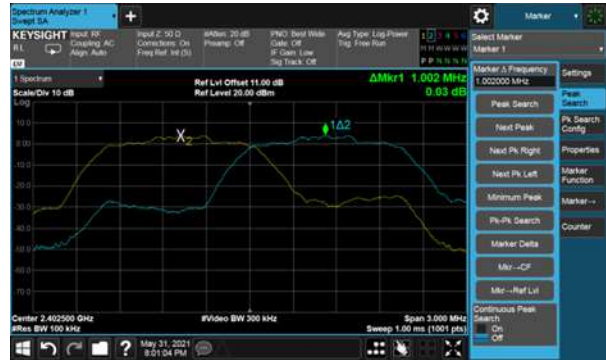

CH39

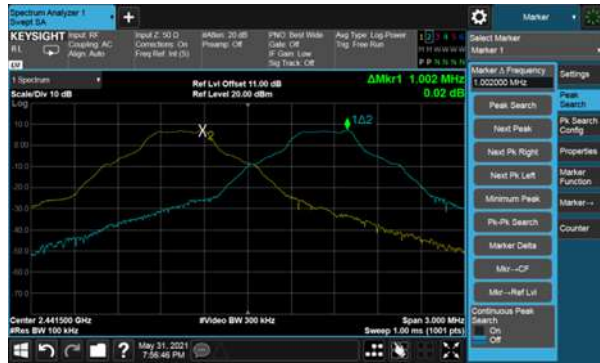

CH39



CH78

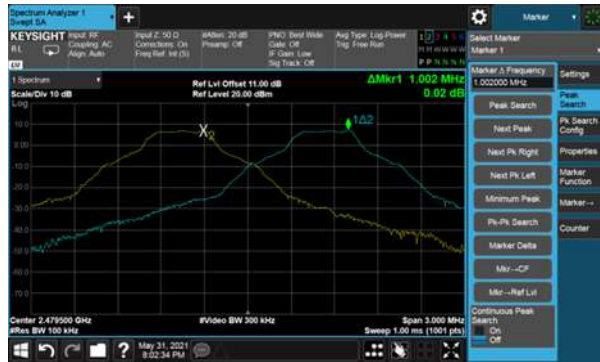

CH78





Modulation Type: 8DPSK (3Mbps)
Channel: 00



CH39

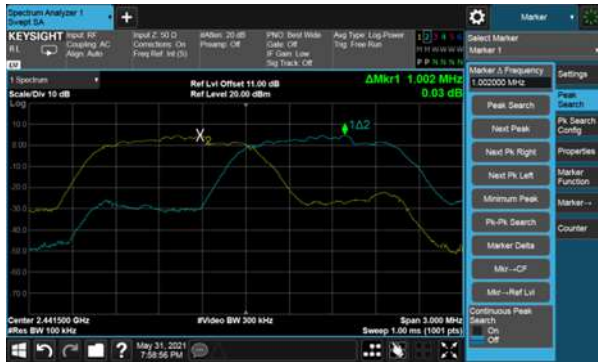

CH78

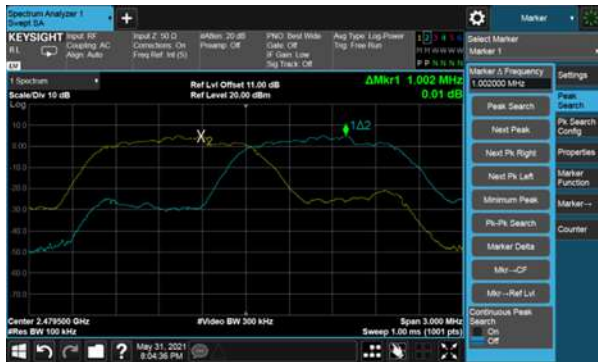



10. Dwell Time on each channel

10.1 Test Limit

The average time of occupancy on any channel shall not be greater than 0.4 seconds within a period of 0.4 seconds multiplied by the number of hopping channels employed.

10.2 Test Procedures

1. The transmitter output was connected to the spectrum analyzer.
2. Adjust the center frequency to measure frequency, then set zero span mode.
2. Set RBW of spectrum analyzer to 1 MHz and VBW to 1 MHz.
4. Measure the time duration of one transmission on the measured frequency.

10.3 Test Setup Layout

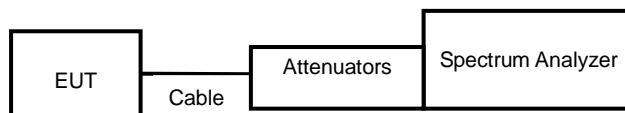

10.4 Test Result and Data

Modulation Type	Frequency (MHz)	Length of transmission time (ms)	Number of transmission in a 31.6 (79 Hopping*0.4)	Dwell Time (ms)	Limit (ms)
GFSK-DH1	2402	0.405	320.00	129.60	400
GFSK-DH3	2402	1.672	160.00	267.52	400
GFSK-DH5	2402	2.920	106.67	311.47	400
$\pi/4$ -DQPSK-DH1	2402	0.415	320.00	132.80	400
$\pi/4$ -DQPSK-DH3	2402	1.665	160.00	266.40	400
$\pi/4$ -DQPSK-DH5	2402	2.930	106.67	312.53	400
8DPSK-DH1	2402	0.410	320.00	131.20	400
8DPSK-DH3	2402	1.672	160.00	267.52	400
8DPSK-DH5	2402	2.920	106.67	311.47	400

Modulation Type	Frequency (MHz)	Length of transmission time (ms)	Number of transmission in a 8 (20 Hopping*0.4)	Dwell Time (ms)	Limit (ms)
AFH-DH1	2402-2421	0.405	160.00	64.80	400
AFH-DH3	2402-2421	1.672	80.00	133.76	400
AFH-DH5	2402-2421	2.920	53.33	155.72	400



Modulation Type: GFSK (1Mbps)
Channel: 00

Modulation Type: $\pi/4$ -DQPSK (2Mbps)
Channel: 00

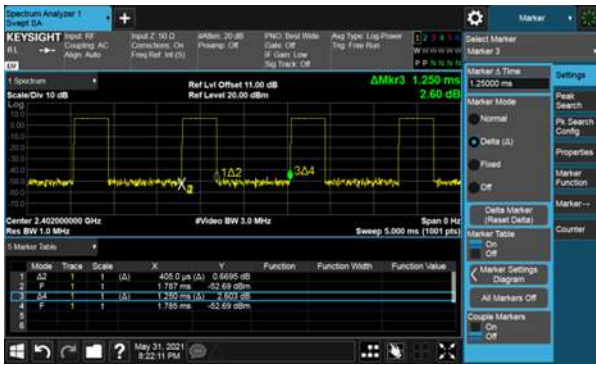

CH39

CH39



CH78

CH78





Modulation Type: 8DPSK (3Mbps)
Channel: 00

Modulation Type: AFH (DH1)

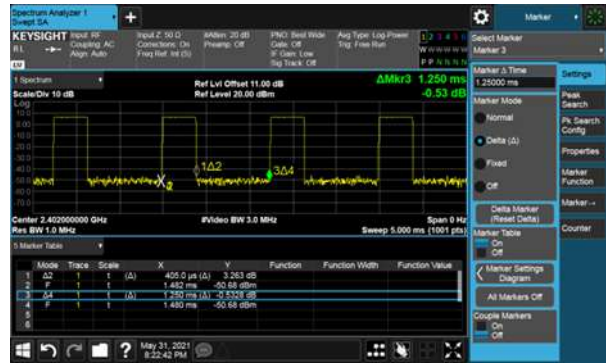
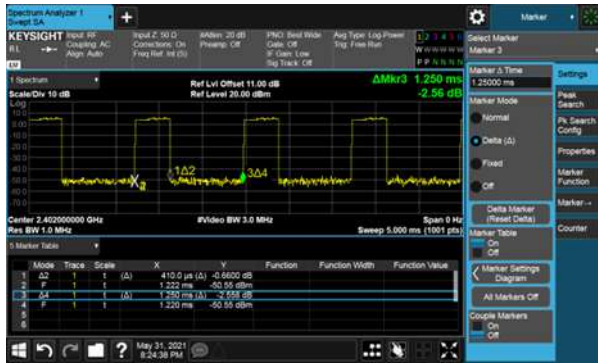

CH39

Modulation Type: AFH (DH3)

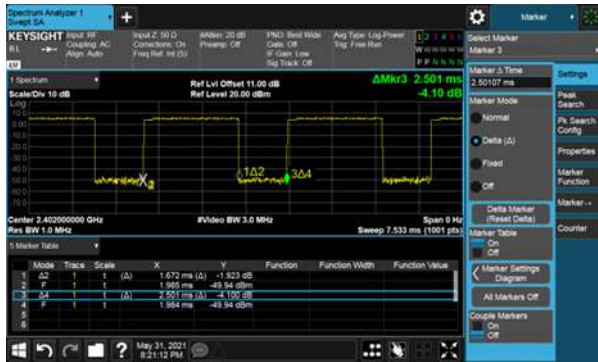

CH78

Modulation Type: AFH (DH5)





11. Number of Hopping Channels

11.1 Test Limit

Frequency hopping systems in the 2400 ~ 2483.5 MHz band shall use at least 15 channels.

11.2 Test Procedures

- a. The transmitter output was connected to the spectrum analyzer.
- b. 2. Set RBW of spectrum analyzer to 100 KHz and VBW to 300 KHz.
- c. 3. Set the MaxHold function, and then keep the EUT in hopping mode. Record all the signals from each channel until each one has been record.

11.3 Test Setup Layout

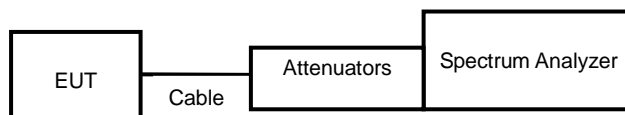

11.4 Test Result and Data

Modulation Type	Hopping Channels
GFSK	79
$\pi/4$ -DQPSK	79
8DPSK	79



Modulation Type: GFSK (1Mbps)



Modulation Type: $\pi/4$ -DQPSK (2Mbps)



Modulation Type: 8DPSK (3Mbps)





12. Maximum Peak Output Power

12.1 Test Limit

The Maximum Peak Output Power Measurement is 30dBm.

12.2 Test Procedures

The antenna port(RF output)of the EUT was connected to the input(RF input)of a power meter. Power was read directly from the meter and cable loss connection was added to the reading to obtain power at the EUT antenna terminal. The EUT Output Power was set to maximum to produce the worse case test result.

12.3 Test Setup Layout

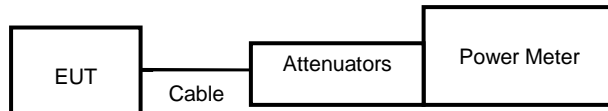

**12.4 Test Result and Data**

Modulation Type	Setting	Channel	Frequency (MHz)	PK Output Power (dBm)	PK Output Power (mW)
GFSK	Default	0	2402	5.81	3.811
	Default	39	2441	6.71	4.688
	Default	78	2480	6.69	4.667
$\pi/4$ -DQPSK	Default	0	2402	5.55	3.589
	Default	39	2441	6.14	4.111
	Default	78	2480	6.19	4.159
8DPSK	Default	0	2402	5.45	3.508
	Default	39	2441	6.30	4.266
	Default	78	2480	6.36	4.325

Modulation Type	Setting	Channel	Frequency (MHz)	AV Output Power (dBm)	AV Output Power (mW)
GFSK	Default	0	2402	5.70	3.715
	Default	39	2441	6.63	4.603
	Default	78	2480	6.60	4.571
$\pi/4$ -DQPSK	Default	0	2402	3.60	2.291
	Default	39	2441	4.25	2.661
	Default	78	2480	4.39	2.748
8DPSK	Default	0	2402	3.22	2.099
	Default	39	2441	4.21	2.636
	Default	78	2480	4.36	2.729

*Note: Average power is for reference only.

AFH Mode

Modulation Type	Setting	Channel	Frequency (MHz)	PK Output Power (dBm)	PK Output Power (mW)
GFSK	Default	0-19	2402-2421	6.26	4.227
$\pi/4$ -DQPSK	Default	0-19	2402-2421	4.05	2.541
8DPSK	Default	0-19	2402-2421	4.03	2.529

AFH Mode

Modulation Type	Setting	Channel	Frequency (MHz)	AV Output Power (dBm)	AV Output Power (mW)
GFSK	Default	0-19	2402-2421	6.16	4.130
$\pi/4$ -DQPSK	Default	0-19	2402-2421	3.81	2.404
8DPSK	Default	0-19	2402-2421	3.80	2.399

*Note: Average power is for reference only.