



FCC RADIO TEST REPORT

Applicant : Ubiquiti Inc.
Address : 685 Third Avenue, New York, New York 10017,
USA
Equipment : UniFi Talk Phone Touch Max
Model No. : UTP-TouchMax, UTP-TouchMax-White
Trade Name : UBIQUITI
FCC ID : SWX-UTPTM

I HEREBY CERTIFY THAT :

The sample was received on May. 27, 2021 and the testing was completed on Mar. 07, 2022 at CerpPASS Technology Corp. The test result refers exclusively to the test presented test model / sample. Without written approval of CerpPASS Technology Corp., the test report shall not be reproduced except in full.

Approved by:

Mark Liao / Supervisor

Laboratory Accreditation:

CerpPASS Technology Corporation Test Laboratory





CONTENTS

- 1. Summary of Test Procedure and Test Results 5
 - 1.1. Applicable Standards5
- 2. Test Configuration of Equipment under Test 6
 - 2.1. Feature of Equipment under Test.....6
 - 2.2. Carrier Frequency of Channels 7
 - 2.3. Test Mode and Test Software9
 - 2.4. Description of Test System..... 10
 - 2.5. General Information of Test..... 11
 - 2.6. Measurement Uncertainty 11
- 3. Test Equipment and Ancillaries Used for Tests 12
- 4. Antenna Requirements 14
 - 4.1. Standard Applicable 14
 - 4.2. Antenna Construction and Directional Gain..... 14
- 5. Test of AC Power Line Conducted Emission 15
 - 5.1. Test Limit 15
 - 5.2. Test Procedures 15
 - 5.3. Typical Test Setup 16
 - 5.4. Test Result and Data 17
 - 5.5. Test Photographs 19
- 6. Test of Spurious Emission (Radiated) 20
 - 6.1. Test Limit 20
 - 6.2. Test Procedures 21
 - 6.3. Typical Test Setup 22
 - 6.4. Test Result and Data (9kHz ~ 30MHz)..... 23
 - 6.5. Test Result and Data (30MHz ~ 1GHz)..... 23
 - 6.6. Test Result and Data (1GHz ~ 40GHz)..... 25
 - 6.7. Restricted Bands of Operation 109
 - 6.8. Test Photographs (30MHz ~ 1GHz) 110
 - 6.9. Test Photographs (1GHz ~ 40GHz) 111
- 7. On Time, Duty Cycle and Measurement methods 113
 - 7.1. Test Limit 113
 - 7.2. Test Procedure 113
 - 7.3. Test Setup Layout 113
 - 7.4. Test Result and Data 113
 - 7.5. Measurement Methods 113
- 8. 6dB Bandwidth & 99% Occupied Bandwidth 115
 - 8.1. Test Limit 115
 - 8.2. Test Procedure 115
 - 8.3. Test Setup Layout 115
 - 8.4. Test Result and Data 116
- 9. 26dB Bandwidth & 99% Occupied Bandwidth 121
 - 9.1. Test Limit 121



- 9.2. Test Procedure 121
- 9.3. Test Setup Layout 121
- 9.4. Test Result and Data 122
- 10. Average Power..... 142
 - 10.1. Test Limit 142
 - 10.2. Test Procedure 143
 - 10.3. Test Setup Layout 143
 - 10.4. Test Result and Data 144
- 11. Power Spectral Density 150
 - 11.1. Test Limit 150
 - 11.2. Test Procedure 150
 - 11.3. Test Setup Layout 150
 - 11.4. Test Result and Data 151
- 12. Radio Frequency Exposure 162
 - 12.1. Applicable Standards 162
 - 12.2. EUT Specification 162
 - 12.3. Test Results 162
 - 12.4. Calculation..... 163
 - 12.5. Maximum Permissible Exposure 164



History of this test report

Report No.	Issued Date	Description
21050188-TRFCC05	Mar. 07, 2022	Original



1. Summary of Test Procedure and Test Results

1.1. Applicable Standards

ANSI C63.10:2013

FCC Rules and Regulations Part 15 Subpart E §15.407

KDB 789033

FCC Rule	Description of Test	Result
15.203	Antenna Requirement	PASS
15.207(a)	AC Power Line Conducted Emission	PASS
15.407(b) 15.209	Radiated Spurious Emission	PASS
15.407(a)	26 dB & Occupied Bandwidth	PASS
15.407	6 dB Bandwidth	PASS
15.407 (a) & (a)(3)	Average Power	PASS
15.407(a)	Power Spectral Density	PASS
2.1091	Radio Frequency Exposure	PASS

*The lab has reduced the uncertainty risk factor from test equipment, environment and staff technicians which according to the standard on contract. Therefore, the test result will only be determined by standard requirement.

*This EUT has been also tested and compiled with the requirement of FCC Part 15, Subpart B, recorded in a separate test report(21050188-TEFV01).

After engineering evaluation, the test results can refer to original report number:
TEFE1912016.



2. Test Configuration of Equipment under Test

2.1. Feature of Equipment under Test

Frequency Range	NFC: 13.553MHz~13.567MHz BT / BLE: 2400-2483.5MHz 802.11b/g/n: 2400-2483.5MHz 802.11a/n/ac: 5150-5250MHz, 5250-5350MHz, 5470-5725MHz, 5725-5850MHz
Modulation Type	NFC : ASK BT: GFSK, $\pi/4$ -DQPSK, 8DPSK BLE: GFSK 802.11b: CCK, DQPSK, DBPSK 802.11g/n/a: BPSK, QPSK, 16QAM, 64QAM 802.11ac: BPSK, QPSK, 16QAM, 64QAM, 256QAM
Modulation Technology	DSSS, OFDM, FHSS, DTS
Data Rate	BT: GFSK: 1Mbps, $\pi/4$ -DQPSK: 2Mbps, 8DPSK: 3Mbps BLE: GFSK: 1Mbps WLAN: 802.11b: 1, 2, 5.5, 11Mbps 802.11g: 6, 9, 12, 18, 24, 36, 48, 54Mbps 802.11n: MCS0 – MCS7, HT20/40 802.11a: 6, 9, 12, 18, 24, 36, 48, 54Mbps 802.11ac: MCS0 – MCS9, VHT20/40/80
Antenna Type	For NFC: Loop Antenna For BT&WLAN: Internal Antenna
Antenna Gain	For NFC: 13.553MHz~13.567MHz: 0dBi For BT/BLE:2400-2480MHz: 0dBi For WLAN: 2400-2483.5MHz: 2dBi 5150-5850MHz: 4.5dBi
Type-C Adapter	Brand: UBIQUITI Model: E015-1G050300VU

Note:

1. EUT supports DFS Client Mode
2. For more details, please refer to the User's manual of the EUT.

Difference description:

Model No.	Remark
UTP-TouchMax	Black enclosure.
UTP-TouchMax-White	White enclosure.



2.2. Carrier Frequency of Channels

Band: 5150MHz-5250MHz

802.11a, 802.11n HT20, 802.11ac VHT20

Channel	Frequency(MHz)	Channel	Frequency(MHz)
*36	5180	44	5220
*40	5200	*48	5240

802.11n HT40, 802.11ac VHT40

Channel	Frequency(MHz)	Channel	Frequency(MHz)
*38	5190	*46	5230

802.11ac VHT80

Channel	Frequency(MHz)
*42	5210

Band: 5250MHz -5350MHz

802.11a, 802.11n HT20, 802.11ac VHT20

Channel	Frequency(MHz)	Channel	Frequency(MHz)
*52	5260	*60	5300
56	5280	*64	5320

802.11n HT40, 802.11ac VHT40

Channel	Frequency(MHz)	Channel	Frequency(MHz)
*54	5270	*62	5310

802.11ac VHT80

Channel	Frequency(MHz)
*58	5290

Band: 5470MHz -5725MHz

802.11a, 802.11n HT20, 802.11ac VHT20

Channel	Frequency(MHz)	Channel	Frequency(MHz)
*100	5500	124	5620
104	5520	128	5640
108	5540	132	5660
112	5560	136	5680
116	5580	*140	5700
*120	5600		

802.11n HT40, 802.11ac VHT40

Channel	Frequency(MHz)	Channel	Frequency(MHz)
*102	5510	126	5630
110	5550	*134	5670
*118	5590		

802.11ac VHT80

Channel	Frequency(MHz)	Channel	Frequency(MHz)
*106	5530	*122	5610



Band 3: Straddle Channel

802.11a, 802.11n HT 20, 802.11ac VHT20

Channel	Frequency(MHz)
*144	5720

802.11n HT40, 802.11ac VHT40

Channel	Frequency(MHz)
*142	5710

802.11ac VHT80

Channel	Frequency(MHz)
*138	5690

Band: 5725MHz -5850MHz

802.11a, 802.11n HT20, 802.11ac VHT20

Channel	Frequency(MHz)	Channel	Frequency(MHz)
*149	5745	161	5805
153	5765	*165	5825
*157	5785		

802.11n HT40, 802.11ac VHT40

Channel	Frequency(MHz)	Channel	Frequency(MHz)
*151	5755	*159	5795

802.11ac VHT80

Channel	Frequency(MHz)
*155	5775

Note: Channels remarked * are selected to perform test.



2.3. Test Mode and Test Software

- a. During testing, the interface cables and equipment positions were varied according to ANSI C63.10.
- b. The complete test system included remote workstation and EUT for RF test. The remote workstation included Notebook.
- c. An executive program, " QRCT ver. 4.0.00129.0" under Windows OS system was executed to transmit and receive data via WLAN.
- d. The following test modes were performed for the test:

Conducted Emissions from the AC mains power ports	
Test Mode	Operating Description
1	802.11a (6Mbps)
2	802.11ac VHT20 (6.5Mbps)
3	802.11ac VHT40 (13.5Mbps)
4	802.11ac VHT80 (29.3Mbps)
caused "Test Mode 2" generated the worst case, it was reported as the final data.	
Radiation Emissions (30MHz ~ 1GHz)	
Test Mode	Operating Description
1	802.11a (6Mbps)
2	802.11ac VHT20 (6.5Mbps)
3	802.11ac VHT40 (13.5Mbps)
4	802.11ac VHT80 (29.3Mbps)
caused "Test Mode 2" generated the worst case, it was reported as the final data.	
Radiation Emissions (1GHz ~ 40GHz)	
Test Mode	Operating Description
1	802.11a (6Mbps)
2	802.11ac VHT20 (6.5Mbps)
3	802.11ac VHT40 (13.5Mbps)
4	802.11ac VHT80 (29.3Mbps)
caused "Test Mode 1~4" generated the worst case, they were reported as the final data.	

Modulation Type	TX CONFIGURATION
802.11a	1TX
802.11n HT20	1TX
802.11n HT40	1TX
802.11ac VHT20	1TX
802.11ac VHT40	1TX
802.11ac VHT80	1TX



2.4. Description of Test System

RF Conducted				
Equipment	Brand	Model	Length/Type	Power cord/Length/Type
Notebook	ASUS	P2430U	N/A	Adapter / 1.8m / NS
RJ45 Cable	N/A	N/A	1.2m / NS	N/A
USB TYPE-C	N/A	N/A	1m / NS	N/A
POE	UBIQUITI	GP-H480-050G	N/A	0.6m / NS
Radiated Emissions				
Equipment	Brand	Model	Length/Type	Power cord/Length/Type
Notebook	ASUS	P2430U	N/A	Adapter / 1.8m / NS
RJ45 Cable	N/A	N/A	15m / NS	N/A
USB TYPE-C	N/A	N/A	1m / NS	N/A
POE	UBIQUITI	GP-H480-050G	N/A	0.6m / NS
AC Power Line Conducted Emission				
Equipment	Brand	Model	Length/Type	Power cord/Length/Type
Notebook	ASUS	P2430U	N/A	Adapter / 1.8m / NS
RJ45 Cable	N/A	N/A	1.2m / NS	N/A
USB TYPE-C	N/A	N/A	1m / NS	N/A
POE	UBIQUITI	GP-H480-050G	N/A	0.6m / NS



2.5. General Information of Test

Test Site	Cerpass Technology Corporation Test Laboratory Address: No.10, Ln. 2, Lianfu St., Luzhu Dist., Taoyuan City 33848, Taiwan (R.O.C.) Tel:+886-3-3226-888 Fax:+886-3-3226-881	
	FCC	TW1439, TW1079
	IC	4934E-1, 4934E-2
	VCCI	T-2205 for Telecommunication test C-4663 for Conducted emission test R-4218 for Radiated emission test G-10812, G-10813 for radiated disturbance above 1GHz
Frequency Range Investigated:	Conducted: from 150kHz to 30 MHz Radiation: from 30 MHz to 40,000MHz	
Test Distance:	The test distance of radiated emission from antenna to EUT is 3 M.	

Test Item	Test Site	Finish Date	Environmental Conditions	Tested By
RF Conducted	RFCON01-NK	2019/12/30	22°C / 63%	Nick Guan
Radiated Emissions	3M02-NK	2020/03/27	22°C / 50%	Vic Yeh
AC Power Line Conducted Emission	CON01-NK	2020/03/25	25°C / 49%	Leon Huang

2.6. Measurement Uncertainty

ISO/IEC 17025 requires that an estimate of the measurement uncertainties associated with the emissions test results be included in the report. The measurement uncertainties given below are based on a 95% confidence level (based on a coverage factor (k=2))

Measurement Item	Uncertainty
AC Power Line Conduction(150K~30MHz)	±1.60dB
Radiated Spurious Emission(9KHz~30MHz)	±3.405dB
Radiated Spurious Emission(30MHz~1GHz)	±5.326dB
Radiated Spurious Emission(1GHz~40GHz)	±5.011dB
6dB Bandwidth	±4.407%
26dB Bandwidth	±4.459%
Occupied Bandwidth	±4.403%
Peak Output Power(Conducted Power Meter)	±1.31dB
Power Spectral Density	±2.106dB
Duty Cycle	±0.17%
Frequency Stability	±156.543Hz



3. Test Equipment and Ancillaries Used for Tests

Test Item	Radiated Emissions				
Test Site	Semi Anechoic Room(3M02-NK)				
Instrument	Manufacturer	Model No	Serial No	Calibration Date	Valid Date
Bilog Antenna	Schwarzbeck	VULB9168	275	2019/09/24	2020/09/23
Bilog Antenna	Schwarzbeck	VULB9168	369	2019/03/29	2020/03/28
Active Loop Antenna	EMCO	6507	40855	2019/05/24	2020/05/23
Horn Antenna	EMCO	3115	31589	2019/04/01	2020/03/31
Horn Antenna	EMCO	3116	31974	2019/09/17	2020/09/16
EMI Receiver	ROHDE & SCHWARZ	ESCI	101423	2019/05/14	2020/05/13
Spectrum Analyzer	ROHDE & SCHWARZ	FSP 40	100219	2019/07/22	2020/07/21
Spectrum Analyzer	ROHDE & SCHWARZ	FSV 40-N	102151	2019/08/02	2020/08/01
Preamplifier	EM Electronics corp.	EM330	60660	2020/03/16	2021/03/15
Preamplifier	EMC INSTRUMENTS	EMC051845SE	980333	2019/09/20	2020/09/19
Preamplifier	Agilent	8449B	3008A01954	2020/03/16	2021/03/15
Preamplifier	EMC INSTRUMENTS	EMC184045	980065	2019/11/07	2020/11/06
Bluetooth Tester	ROHDE & SCHWARZ	CBT	101133	2019/04/07	2020/04/06
Cable-3in1(30M-1G)	HARBOUR INDUSTRIES	LL142	CCE1315	2019/04/09	2020/04/08
Cable-3in1(30M-1G)	HARBOUR INDUSTRIES	LL142	CCE1316	2019/09/20	2020/09/19
Cable-0.5m(1G-40G)	HUBER SUHNER	SUCOFLEX 100	805443/4	2019/05/20	2020/05/19
Cable-3m(1G-40G)	HUBER SUHNER	SUCOFLEX 100	805796/4	2019/05/20	2020/05/19
Cable-8m(1G-40G)	HUBER SUHNER	SUCOFLEX 100	805795/4	2019/05/20	2020/05/19
E3	AUDIX	v8.2014-8-6	RK-000529	NA	NA

Test Item	RF Conducted				
Test Site	RFCON01-NK				
Instrument	Manufacturer	Model No	Serial No	Calibration Date	Valid Date
Spectrum Analyzer	ROHDE & SCHWARZ	FSP 40	100219	2019/07/22	2020/07/21
Spectrum Analyzer	ROHDE & SCHWARZ	FSV 40-N	102151	2019/08/02	2020/08/01
Bluetooth Tester	ROHDE & SCHWARZ	CBT	101133	2019/04/07	2020/04/06
CAX Signal Analyzer	KEYSIGHT	N9000B	MY57100339	2019/11/25	2020/11/24
Attenuator	KEYSIGHT	8491B	MY39250703	2019/09/12	2020/09/11
TEMP & HUMI CHAMBER	T-MACHINE	TMJ-9712	T-12-040111	2019/08/28	2020/08/27
Power Meter	Anritsu	ML2495A	1224005	2019/04/11	2020/04/10
Power Sensor	Anritsu	MA2411B	1207295	2019/04/09	2020/04/08



Test Item	AC Power Line Conducted Emission				
Test Site	CON01-NK				
Instrument	Manufacturer	Model No	Serial No	Calibration Date	Valid Date
EMI Receiver	ROHDE & SCHWARZ	ESCI	100821	2019/09/16	2020/09/15
Line Impedance Stabilization Network	Schwarzbeck	NSLK 8127	8127-568	2020/03/12	2021/03/11
Pulse Limiter	ROHDE & SCHWARZ	ESH3-Z2	101934	2020/03/11	2021/03/10
Cable-6m(9k~300M)	NA	EMC5D-BM-BM-6	130606	2020/03/11	2021/03/10
E3	AUDIX	v8.2014-8-6	RK-000531	NA	NA



4. Antenna Requirements

4.1. Standard Applicable

For intentional device, according to FCC 47 CFR Section 15.203, an intentional radiator shall be designed to ensure that no antenna other than that furnished by the responsible party shall be used with the device.

And according to FCC 47 CFR Section 15.407 (a), if transmitting antennas of directional gain greater than 6dBi are used, the power shall be reduced by the amount in dB that the directional gain of the antenna exceeds 6dBi.

4.2. Antenna Construction and Directional Gain

Antenna Type	Internal Antenna
Antenna Gain	2400MHz-2483.5MHz: 2 dBi 5150MHz-5250MHz: 4.5 dBi 5250MHz-5350MHz: 4.5 dBi 5470MHz-5725MHz: 4.5 dBi 5725MHz-5850MHz: 4.5 dBi



5. Test of AC Power Line Conducted Emission

5.1. Test Limit

Conducted Emissions were measured from 150 kHz to 30 MHz with a bandwidth of 9 KHz, according to the methods defined in ANSI C63.10-2013. The EUT was placed on a nonmetallic stand in a shielded room 0.8 meters above the ground plane. The interface cables and equipment positioning were varied within limits of reasonable applications to determine the position produced maximum conducted emissions.

Frequency (MHz)	Quasi Peak (dB μ V)	Average (dB μ V)
0.15 – 0.5	66-56*	56-46*
0.5 – 5.0	56	46
5.0 – 30.0	60	50

*Decreases with the logarithm of the frequency.

5.2. Test Procedures

- The EUT was placed 0.4 meter from the conducting wall of the shielding room was kept at least 80 centimeters from any other grounded conducting surface.
- Connect EUT to the power mains through a line impedance stabilization network (LISN).
- All the support units are connecting to the other LISN.
- The LISN provides 50 ohm coupling impedance for the measuring instrument.
- The FCC states that a 50 ohm, 50 micro-Henry LISN should be used.
- Both sides of AC line were checked for maximum conducted interference.
- The frequency range from 150 kHz to 30 MHz was searched.
- Set the test-receiver system to Peak Detect Function and Specified Bandwidth with Maximum Hold Mode.



5.3. Typical Test Setup

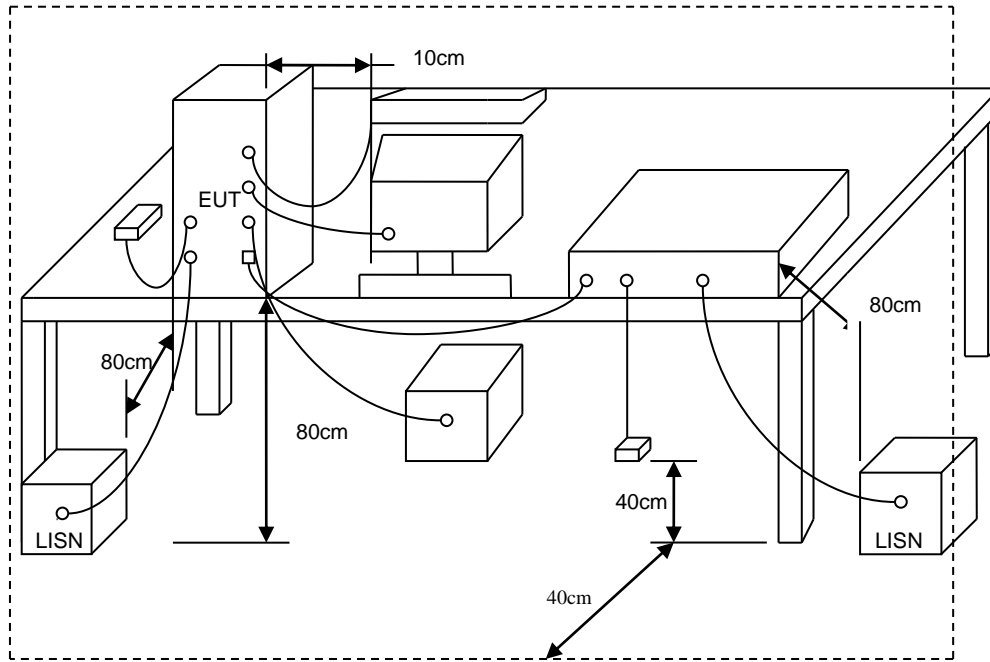



5.4. Test Result and Data

Power	: AC 120V / 60Hz	Pol/Phase	: LINE
Test Mode	: Mode 2, CH165		:

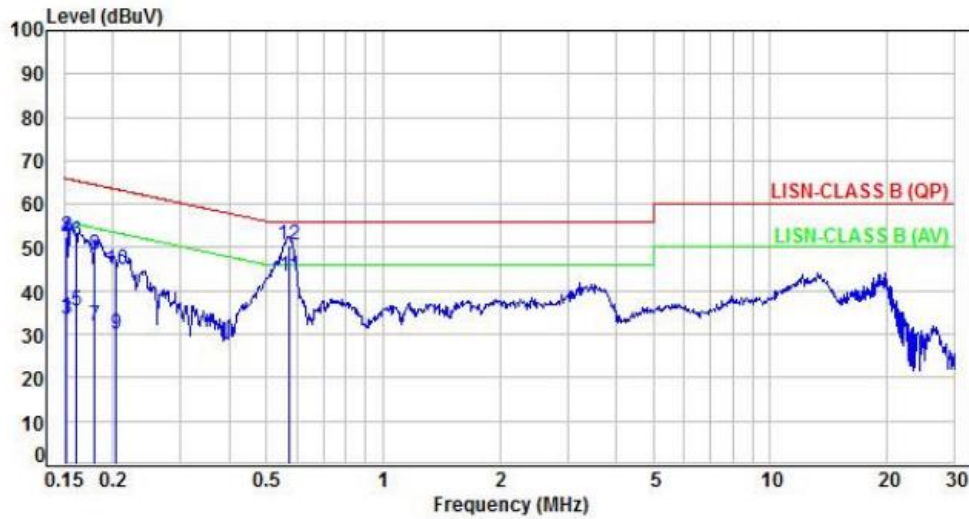

No.	Frequency (MHz)	Factor (dB)	Reading (dBUV)	Level (dBUV)	Limit (dBUV)	Margin (dB)	Detector	P/F
1	0.15	9.92	23.78	33.70	55.93	-22.23	Average	P
2	0.15	9.92	42.37	52.29	65.93	-13.64	QP	P
3	0.15	9.92	23.39	33.31	55.92	-22.61	Average	P
4	0.15	9.92	42.08	52.00	65.92	-13.92	QP	P
5	0.16	9.92	25.58	35.50	55.44	-19.94	Average	P
6	0.16	9.92	41.54	51.46	65.44	-13.98	QP	P
7	0.18	9.92	22.11	32.03	54.52	-22.49	Average	P
8	0.18	9.92	38.21	48.13	64.52	-16.39	QP	P
9	0.20	9.92	20.26	30.18	53.43	-23.25	Average	P
10	0.20	9.92	34.81	44.73	63.43	-18.70	QP	P
11	0.57	9.95	33.53	43.48	46.00	-2.52	Average	P
12	0.57	9.95	40.75	50.70	56.00	-5.30	QP	P

Note: Level=Reading+Factor
Margin=Level-Limit
Factor=(LISN or ISN or Current Probe)Factor + Cable Loss



Power	: AC 120V / 60Hz	Pol/Phase	: NEUTRAL
Test Mode	: Mode 2, CH165		

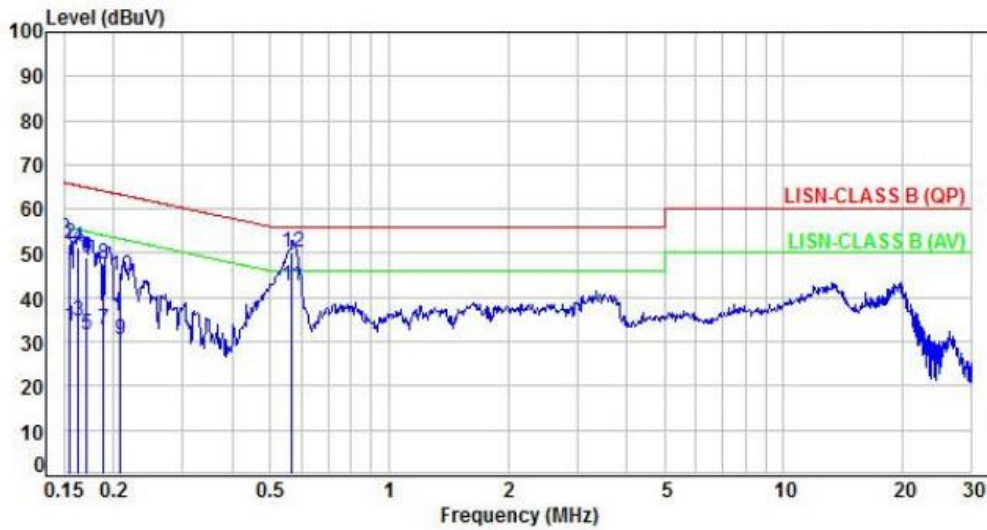

No.	Frequency (MHz)	Factor (dB)	Reading (dBuV)	Level (dBuV)	Limit (dBuV)	Margin (dB)	Detector	P/F
1	0.15	9.95	23.59	33.54	55.77	-22.23	Average	P
2	0.15	9.95	42.03	51.98	65.77	-13.79	QP	P
3	0.16	9.95	24.75	34.70	55.29	-20.59	Average	P
4	0.16	9.95	41.24	51.19	65.29	-14.10	QP	P
5	0.17	9.95	21.71	31.66	54.95	-23.29	Average	P
6	0.17	9.95	39.12	49.07	64.95	-15.88	QP	P
7	0.19	9.95	22.93	32.88	54.12	-21.24	Average	P
8	0.19	9.95	37.46	47.41	64.12	-16.71	QP	P
9	0.21	9.95	20.56	30.51	53.31	-22.80	Average	P
10	0.21	9.95	34.80	44.75	63.31	-18.56	QP	P
11	0.56	9.96	32.72	42.68	46.00	-3.32	Average	P
12	0.56	9.96	40.04	50.00	56.00	-6.00	QP	P

Note: Level=Reading+Factor
Margin=Level-Limit
Factor=(LISN or ISN or Current Probe)Factor + Cable Loss



6. Test of Spurious Emission (Radiated)

6.1. Test Limit

Undesirable emission limits. Except as shown in paragraph (b)(7) of this section, the maximum emissions outside of the frequency bands of operation shall be attenuated in accordance with the following limits:

- (1) For transmitters operating in the 5.15-5.25 GHz band: All emissions outside of the 5.15-5.35 GHz band shall not exceed an e.i.r.p. of -27 dBm/MHz.
- (2) For transmitters operating in the 5.25-5.35 GHz band: All emissions outside of the 5.15-5.35 GHz band shall not exceed an e.i.r.p. of -27 dBm/MHz.
- (3) For transmitters operating in the 5.47-5.725 GHz band: All emissions outside of the 5.47-5.725 GHz band shall not exceed an e.i.r.p. of -27 dBm/MHz.
- (4) For transmitters operating in the 5.725-5.85 GHz band:
All emissions shall be limited to a level of -27 dBm/MHz at 75 MHz or more above or below the band edge increasing linearly to 10 dBm/MHz at 25 MHz above or below the band edge, and from 25MHz above or below the band edge increasing linearly to a level of 15.6 dBm/MHz at 5 MHz above or below the band edge, and from 5 MHz above or below the band edge increasing linearly to a level of 27dBm/MHz at the band edge.
- (5) The emission measurements shall be performed using a minimum resolution bandwidth of 1 MHz. A lower resolution bandwidth may be employed near the band edge, when necessary, provided the measured energy is integrated to show the total power over 1 MHz.
- (6) Unwanted emissions below 1 GHz must comply with the general field strength limits set forth in §15.209. Further, any U-NII devices using an AC power line are required to comply also with the conducted limits set forth in §15.207.
- (7) The provisions of §15.205 apply to intentional radiators operating under this section.
- (8) When measuring the emission limits, the nominal carrier frequency shall be adjusted as close to the upper and lower frequency band edges as the design of the equipment permits.



6.2. Test Procedures

- a. The EUT was placed on a rotatable table top 0.8 meter above ground.
- b. The EUT was set 3 meters from the interference receiving antenna which was mounted on the top of a variable height antenna tower.
- c. The table was rotated 360 degrees to determine the position of the highest radiation.
- d. The antenna is a broadband antenna and its height is varied between one meter and four meters above ground to find the maximum value of the field strength both horizontal polarization and vertical polarization of the antenna are set to make the measurement.
- e. For each suspected emission the EUT was arranged to its worst case and then tune the antenna tower (from 1 M to 4 M) and turn table (from 0 degree to 360 degrees) to find the maximum reading.
- f. Set the test-receiver system to Peak or CISPR quasi-peak Detect Function and specified bandwidth with Maximum Hold Mode.
- g. If the emission level of the EUT in peak mode was 3 dB lower than the limit specified, then testing will be stopped and peak values of EUT will be reported, otherwise, the emissions which do not have 3 dB margin will be repeated one by one using the quasi-peak method and reported.
- h. For testing above 1GHz, the emission level of the EUT in peak mode was 20dB lower than average limit (that means the emission level in peak mode also complies with the limit in average mode), then testing will be stopped and peak values of EUT will be reported, otherwise, the emissions will be measured in average mode again and reported.
- i. "Cone of radiation" has been considered to be 3dB bandwidth of the measurement antenna.

Note:

1. The supporting fixture shall permit orientation of the EUT in each of three orthogonal axis positions such that emissions from the EUT are maximized.
(X-AXIS is the worst.)



6.3. Typical Test Setup

Below 30MHz test setup

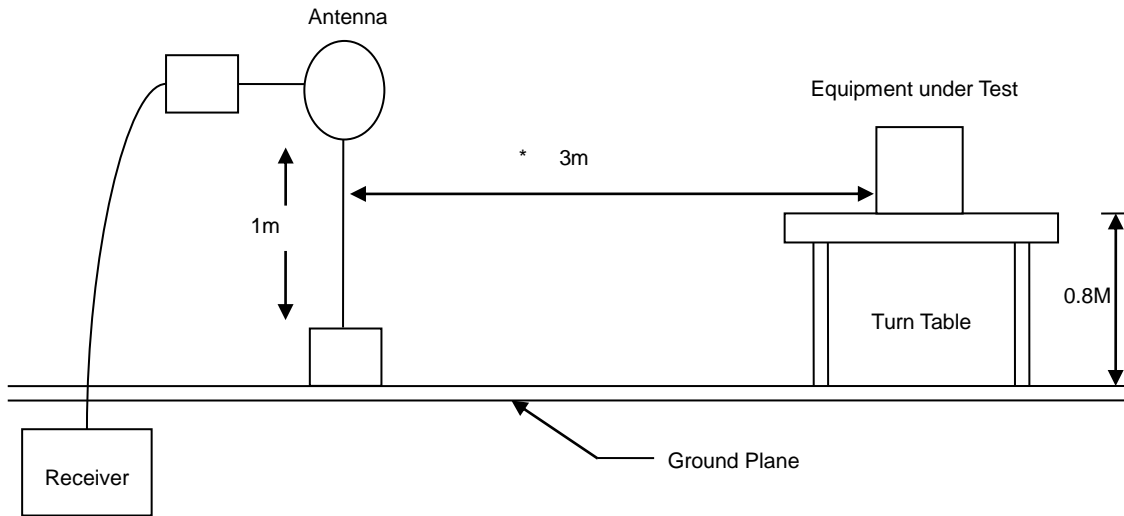

30MHz- 1GHz Test Setup

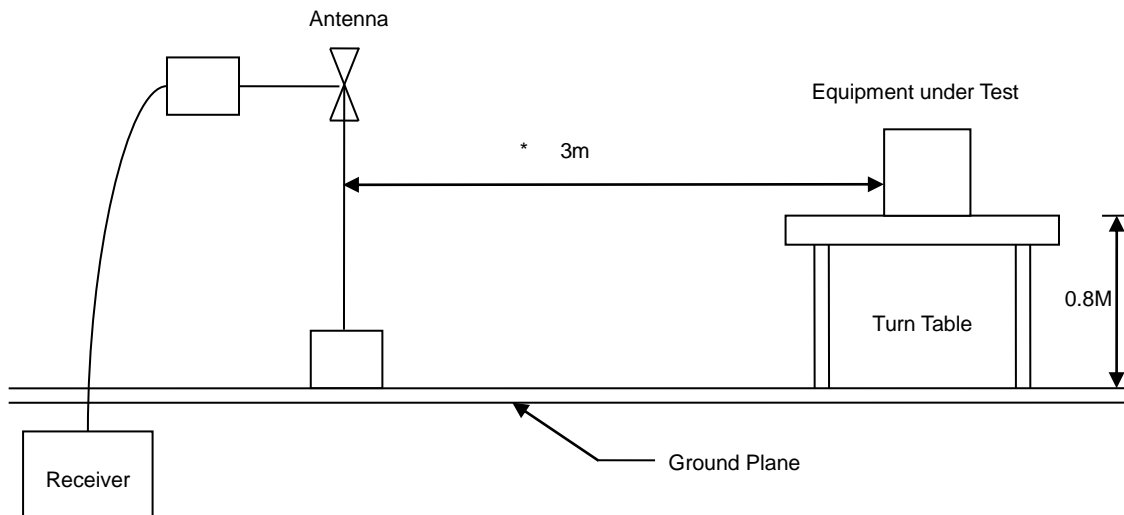

Above 1GHz Test Setup

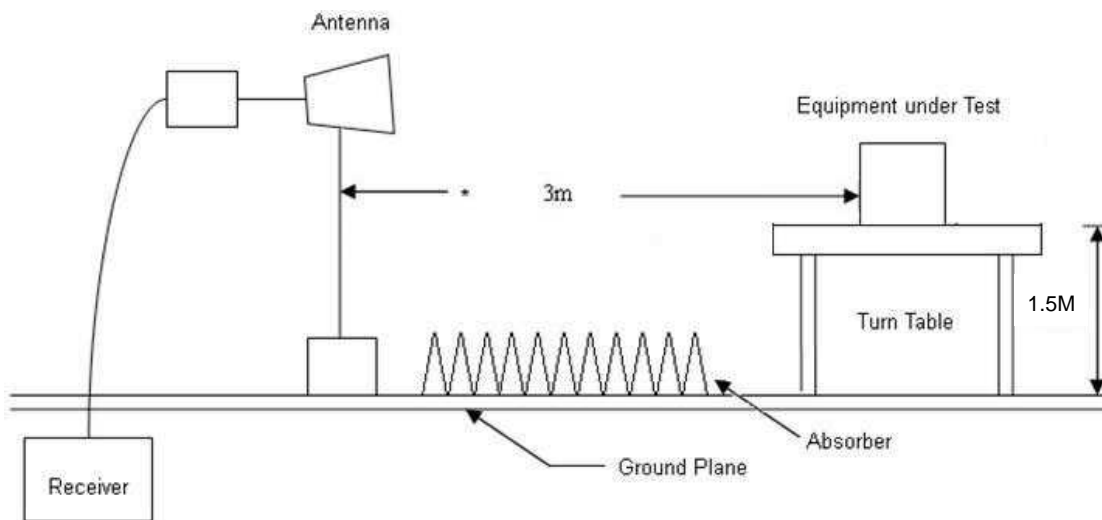



6.4. Test Result and Data (9kHz ~ 30MHz)

The 9kHz - 30MHz spurious emission is under limit 20dB more.

6.5. Test Result and Data (30MHz ~ 1GHz)

Power	: AC 120V / 60Hz	Pol/Phase	: VERTICAL
Test Mode	: Mode 2, CH165		:

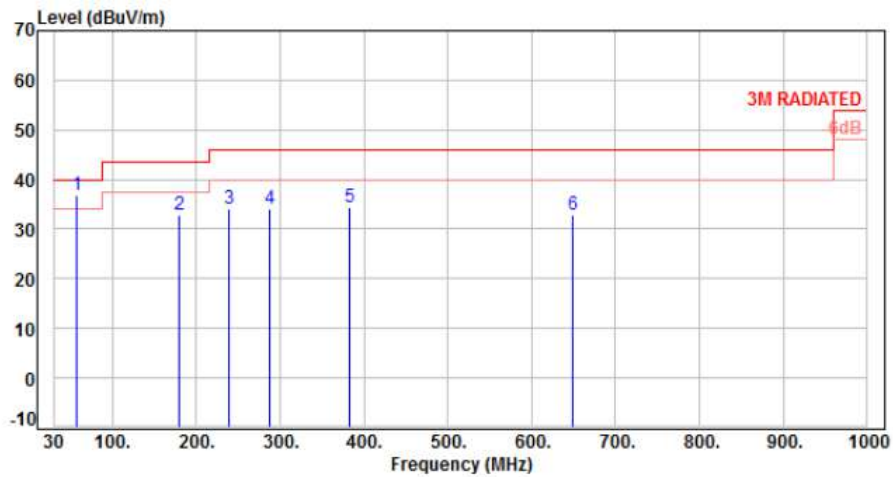

No.	Frequency (MHz)	Factor (dB)	Reading (dBUV)	Level (dBUV/m)	Limit (dBUV/m)	Margin (dB)	Detector	Height (cm)	Azimuth (deg)	P/F
1	57.16	-9.19	45.97	36.78	40.00	-3.22	QP	100	0	P
2	179.38	-10.52	43.39	32.87	43.50	-10.63	Peak	100	0	P
3	239.52	-10.46	44.41	33.95	46.00	-12.05	Peak	100	0	P
4	288.02	-8.55	42.62	34.07	46.00	-11.93	Peak	100	0	P
5	383.08	-5.86	40.35	34.49	46.00	-11.51	Peak	100	0	P
6	648.86	-0.37	33.17	32.80	46.00	-13.20	Peak	100	0	P

Note: Level=Reading+Factor
Margin=Level-Limit
Factor=Antenna Factor + cable loss - Amplifier Factor



Power	: AC 120V / 60Hz	Pol/Phase	: HORIZONTAL
Test Mode	: Mode 2, CH165		:

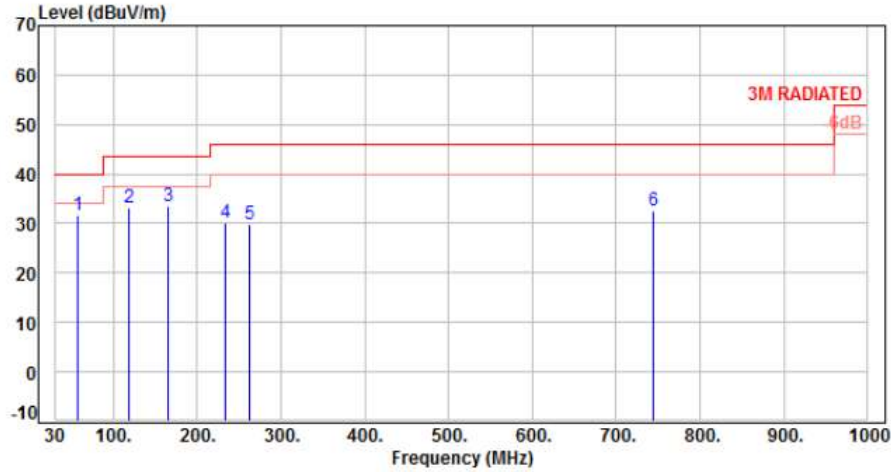

No.	Frequency (MHz)	Factor (dB)	Reading (dBuV)	Level (dBuV/m)	Limit (dBuV/m)	Margin (dB)	Detector	Height (cm)	Azimuth (deg)	P/F
1	57.16	-9.19	40.99	31.80	40.00	-8.20	Peak	100	0	P
2	119.24	-11.90	45.14	33.24	43.50	-10.26	Peak	100	0	P
3	165.80	-9.29	42.84	33.55	43.50	-9.95	Peak	100	0	P
4	233.70	-10.96	40.99	30.03	46.00	-15.97	Peak	100	0	P
5	262.80	-9.51	39.38	29.87	46.00	-16.13	Peak	100	0	P
6	743.92	1.25	31.22	32.47	46.00	-13.53	Peak	100	0	P

Note: Level=Reading+Factor
 Margin=Level-Limit
 Factor=Antenna Factor + cable loss - Amplifier Factor



6.6. Test Result and Data (1GHz ~ 40GHz)

Power	: AC 120V / 60Hz	Pol/Phase	: VERTICAL
Test Mode	: Mode 1, Band 1, CH36		:

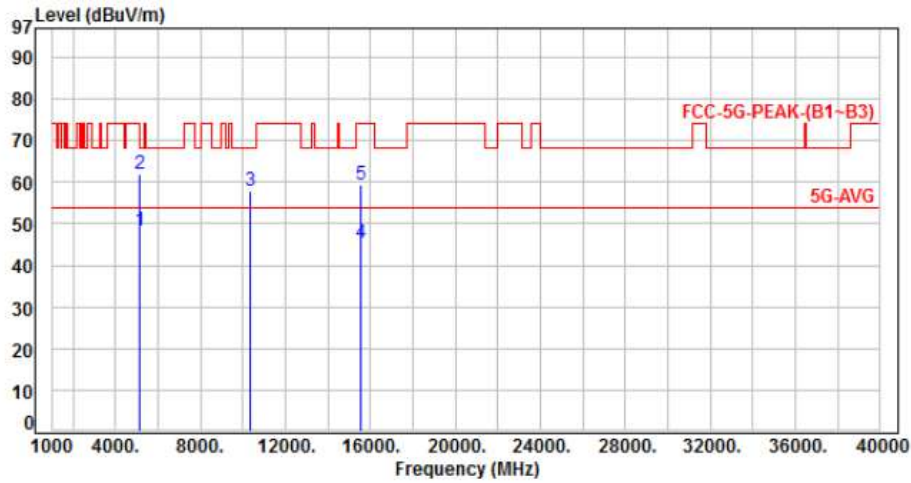

No.	Frequency (MHz)	Factor (dB)	Reading (dBuV)	Level (dBuV/m)	Limit (dBuV/m)	Margin (dB)	Detector	Height (cm)	Azimuth (deg)	P/F
1	5150.00	4.73	43.63	48.36	54.00	-5.64	Average	166	114	P
2	5150.00	4.73	57.40	62.13	74.00	-11.87	Peak	166	114	P
3	10360.00	11.43	46.42	57.85	68.20	-10.35	Peak	306	166	P
4	15540.00	14.27	31.16	45.43	54.00	-8.57	Average	100	225	P
5	15540.00	14.27	45.16	59.43	74.00	-14.57	Peak	100	225	P

Note: Level=Reading+Factor
 Margin=Level-Limit
 Factor=Antenna Factor + cable loss - Amplifier Factor



Power	: AC 120V / 60Hz	Pol/Phase	: HORIZONTAL
Test Mode	: Mode 1, Band 1, CH36		:

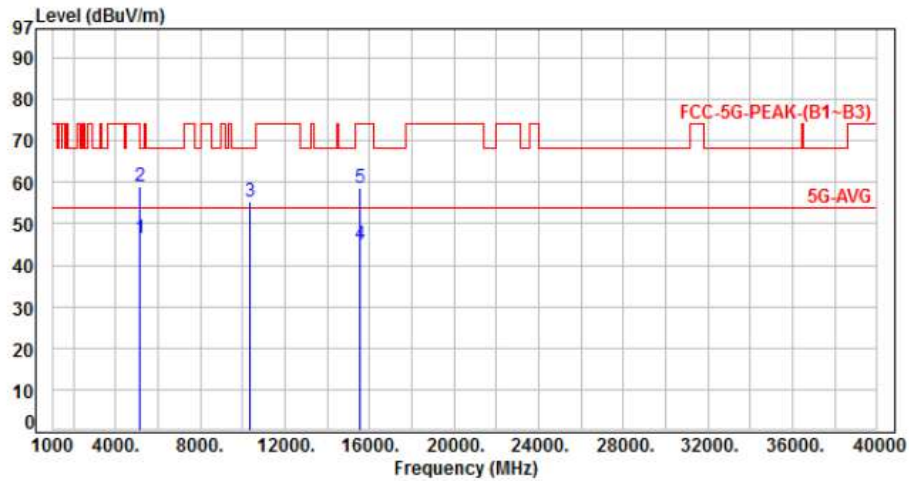

No.	Frequency (MHz)	Factor (dB)	Reading (dBuV)	Level (dBuV/m)	Limit (dBuV/m)	Margin (dB)	Detector	Height (cm)	Azimuth (deg)	P/F
1	5150.00	4.73	41.83	46.56	54.00	-7.44	Average	100	48	P
2	5150.00	4.73	54.37	59.10	74.00	-14.90	Peak	100	48	P
3	10360.00	11.43	44.05	55.48	68.20	-12.72	Peak	100	220	P
4	15540.00	14.27	30.89	45.16	54.00	-8.84	Average	100	312	P
5	15540.00	14.27	44.43	58.70	74.00	-15.30	Peak	100	312	P

Note: Level=Reading+Factor
Margin=Level-Limit
Factor=Antenna Factor + cable loss - Amplifier Factor



Power	: AC 120V / 60Hz	Pol/Phase	: VERTICAL
Test Mode	: Mode 1, Band 1, CH40		:

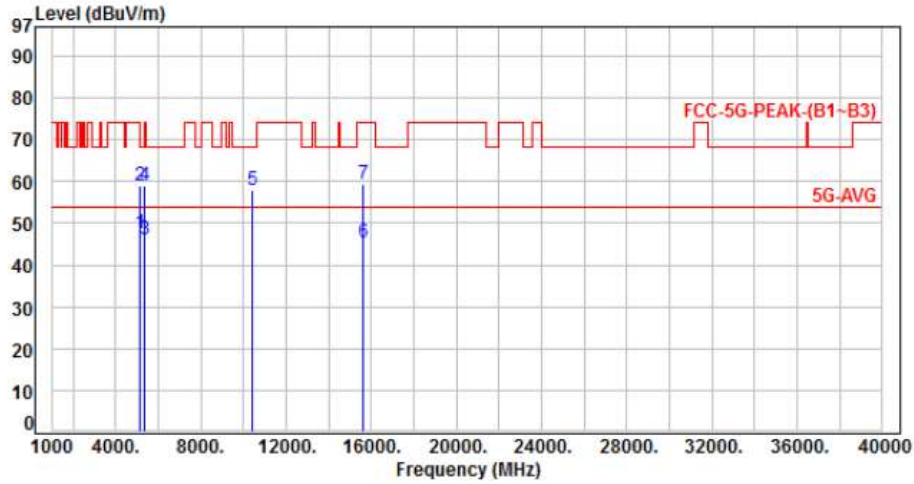

No.	Frequency (MHz)	Factor (dB)	Reading (dBuV)	Level (dBuV/m)	Limit (dBuV/m)	Margin (dB)	Detector	Height (cm)	Azimuth (deg)	P/F
1	5150.00	4.73	42.74	47.47	54.00	-6.53	Average	168	120	P
2	5150.00	4.73	54.38	59.11	74.00	-14.89	Peak	168	120	P
3	5350.00	5.07	41.08	46.15	54.00	-7.85	Average	168	120	P
4	5350.00	5.07	54.07	59.14	74.00	-14.86	Peak	168	120	P
5	10400.00	11.45	46.57	58.02	68.20	-10.18	Peak	304	165	P
6	15600.00	13.88	31.34	45.22	54.00	-8.78	Average	100	228	P
7	15600.00	13.88	45.38	59.26	74.00	-14.74	Peak	100	228	P

Note: Level=Reading+Factor
Margin=Level-Limit
Factor=Antenna Factor + cable loss - Amplifier Factor



Power	: AC 120V / 60Hz	Pol/Phase	: HORIZONTAL
Test Mode	: Mode 1, Band 1, CH40		:

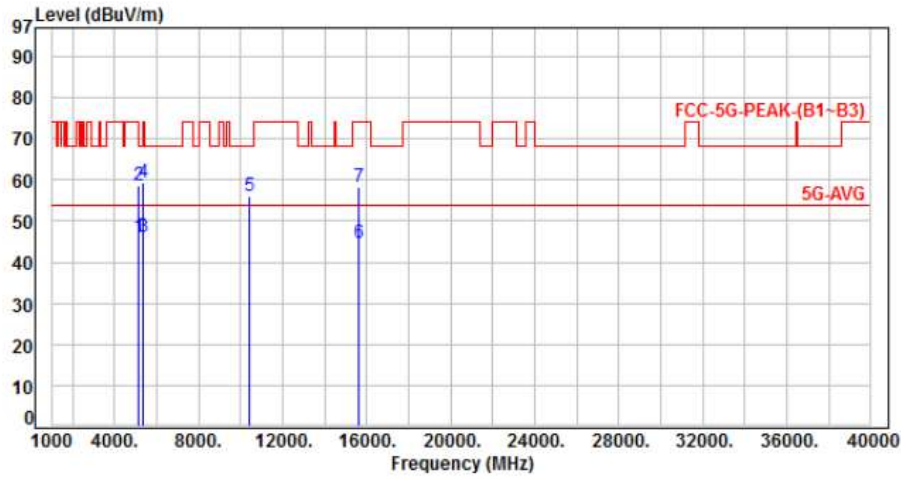

No.	Frequency (MHz)	Factor (dB)	Reading (dBuV)	Level (dBuV/m)	Limit (dBuV/m)	Margin (dB)	Detector	Height (cm)	Azimuth (deg)	P/F
1	5150.00	4.73	41.45	46.18	54.00	-7.82	Average	100	46	P
2	5150.00	4.73	53.78	58.51	74.00	-15.49	Peak	100	46	P
3	5350.00	5.07	40.95	46.02	54.00	-7.98	Average	100	46	P
4	5350.00	5.07	54.30	59.37	74.00	-14.63	Peak	100	46	P
5	10400.00	11.45	44.47	55.92	68.20	-12.28	Peak	100	215	P
6	15600.00	13.88	30.75	44.63	54.00	-9.37	Average	100	308	P
7	15600.00	13.88	44.32	58.20	74.00	-15.80	Peak	100	308	P

Note: Level=Reading+Factor
 Margin=Level-Limit
 Factor=Antenna Factor + cable loss - Amplifier Factor



Power	: AC 120V / 60Hz	Pol/Phase	: VERTICAL
Test Mode	: Mode 1, Band 1, CH48		:

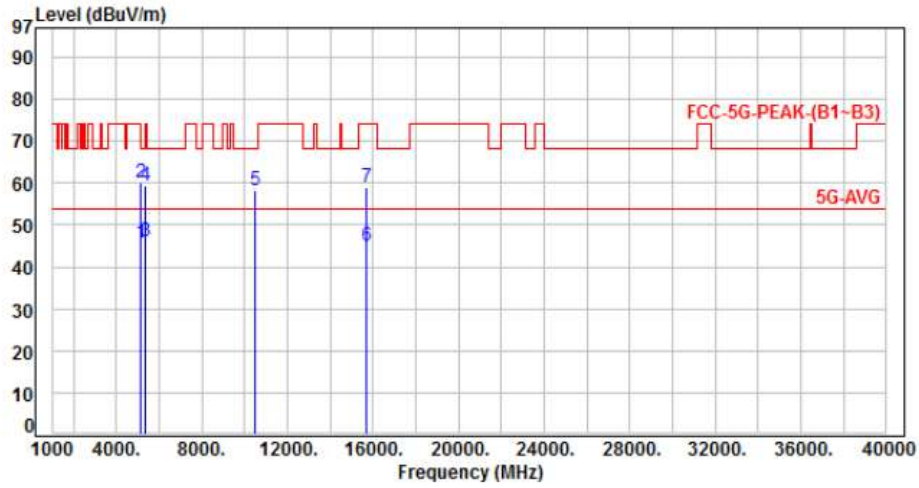

No.	Frequency (MHz)	Factor (dB)	Reading (dBuV)	Level (dBuV/m)	Limit (dBuV/m)	Margin (dB)	Detector	Height (cm)	Azimuth (deg)	P/F
1	5150.00	4.73	40.89	45.62	54.00	-8.38	Average	170	122	P
2	5150.00	4.73	55.21	59.94	74.00	-14.06	Peak	170	122	P
3	5350.00	5.07	40.95	46.02	54.00	-7.98	Average	170	122	P
4	5350.00	5.07	54.35	59.42	74.00	-14.58	Peak	170	122	P
5	10480.00	11.65	46.77	58.42	68.20	-9.78	Peak	303	165	P
6	15720.00	13.60	31.32	44.92	54.00	-9.08	Average	100	222	P
7	15720.00	13.60	45.42	59.02	74.00	-14.98	Peak	100	222	P

Note: Level=Reading+Factor
 Margin=Level-Limit
 Factor=Antenna Factor + cable loss - Amplifier Factor



Power	: AC 120V / 60Hz	Pol/Phase	: HORIZONTAL
Test Mode	: Mode 1, Band 1, CH48		:

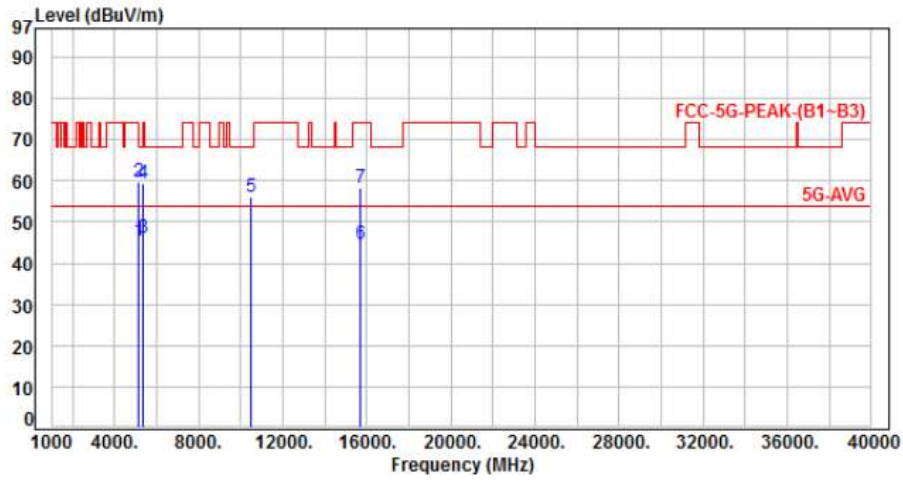

No.	Frequency (MHz)	Factor (dB)	Reading (dBuV)	Level (dBuV/m)	Limit (dBuV/m)	Margin (dB)	Detector	Height (cm)	Azimuth (deg)	P/F
1	5150.00	4.73	40.61	45.34	54.00	-8.66	Average	100	45	P
2	5150.00	4.73	54.92	59.65	74.00	-14.35	Peak	100	45	P
3	5350.00	5.07	40.92	45.99	54.00	-8.01	Average	100	45	P
4	5350.00	5.07	54.14	59.21	74.00	-14.79	Peak	100	45	P
5	10480.00	11.65	44.25	55.90	68.20	-12.30	Peak	100	215	P
6	15720.00	13.60	30.94	44.54	54.00	-9.46	Average	100	223	P
7	15720.00	13.60	44.58	58.18	74.00	-15.82	Peak	100	223	P

Note: Level=Reading+Factor
 Margin=Level-Limit
 Factor=Antenna Factor + cable loss - Amplifier Factor



Power	: AC 120V / 60Hz	Pol/Phase	: VERTICAL
Test Mode	: Mode 2, Band 1, CH36		:

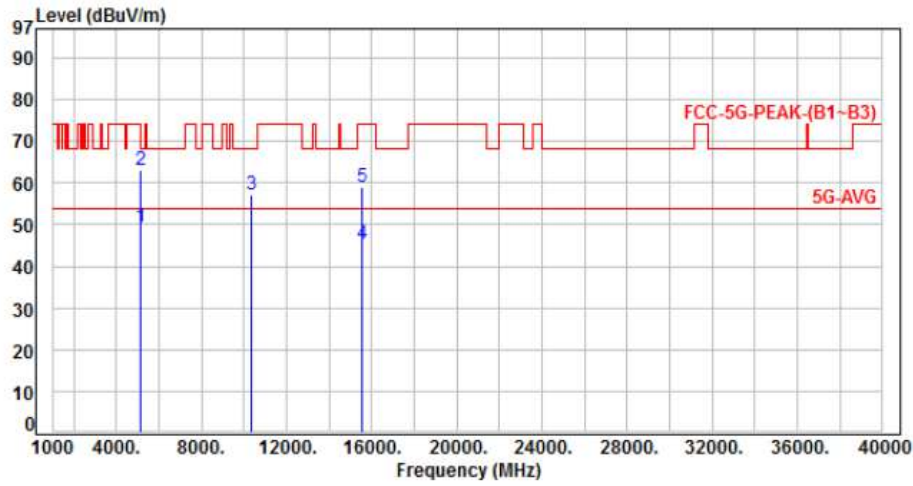

No.	Frequency (MHz)	Factor (dB)	Reading (dBuV)	Level (dBuV/m)	Limit (dBuV/m)	Margin (dB)	Detector	Height (cm)	Azimuth (deg)	P/F
1	5150.00	4.73	44.58	49.31	54.00	-4.69	Average	158	115	P
2	5150.00	4.73	58.25	62.98	74.00	-11.02	Peak	158	115	P
3	10360.00	11.43	45.60	57.03	68.20	-11.17	Peak	305	165	P
4	15540.00	14.27	31.06	45.33	54.00	-8.67	Average	100	220	P
5	15540.00	14.27	44.66	58.93	74.00	-15.07	Peak	100	220	P

Note: Level=Reading+Factor
Margin=Level-Limit
Factor=Antenna Factor + cable loss - Amplifier Factor



Power	: AC 120V / 60Hz	Pol/Phase	: HORIZONTAL
Test Mode	: Mode 2, Band 1, CH36		:

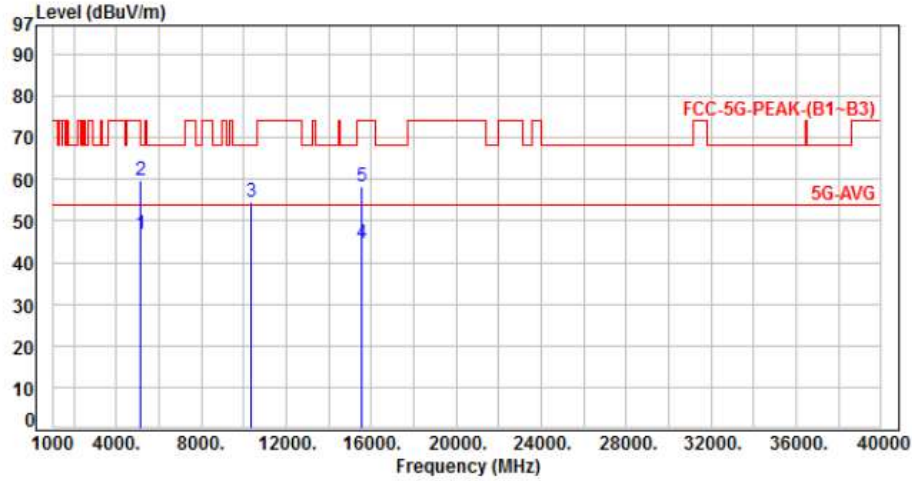

No.	Frequency (MHz)	Factor (dB)	Reading (dBuV)	Level (dBuV/m)	Limit (dBuV/m)	Margin (dB)	Detector	Height (cm)	Azimuth (deg)	P/F
1	5150.00	4.73	42.17	46.90	54.00	-7.10	Average	100	45	P
2	5150.00	4.73	55.14	59.87	74.00	-14.13	Peak	100	45	P
3	10360.00	11.43	43.34	54.77	68.20	-13.43	Peak	100	216	P
4	15540.00	14.27	30.42	44.69	54.00	-9.31	Average	100	306	P
5	15540.00	14.27	43.97	58.24	74.00	-15.76	Peak	100	306	P

Note: Level=Reading+Factor
Margin=Level-Limit
Factor=Antenna Factor + cable loss - Amplifier Factor



Power	: AC 120V / 60Hz	Pol/Phase	: VERTICAL
Test Mode	: Mode 2, Band 1, CH40		

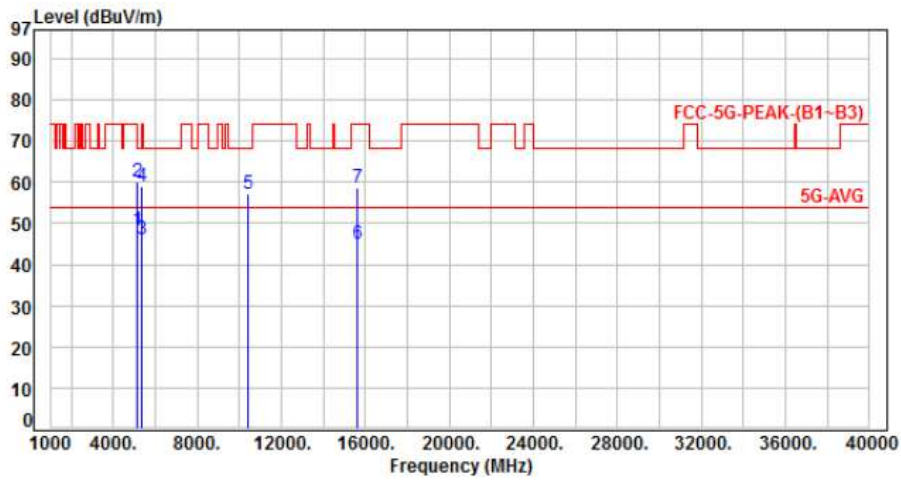

No.	Frequency (MHz)	Factor (dB)	Reading (dBuV)	Level (dBuV/m)	Limit (dBuV/m)	Margin (dB)	Detector	Height (cm)	Azimuth (deg)	P/F
1	5150.00	4.73	43.47	48.20	54.00	-5.80	Average	162	114	P
2	5150.00	4.73	55.45	60.18	74.00	-13.82	Peak	162	114	P
3	5350.00	5.07	41.09	46.16	54.00	-7.84	Average	162	114	P
4	5350.00	5.07	54.12	59.19	74.00	-14.81	Peak	162	114	P
5	10400.00	11.45	45.82	57.27	68.20	-10.93	Peak	306	164	P
6	15600.00	13.88	31.26	45.14	54.00	-8.86	Average	100	225	P
7	15600.00	13.88	44.89	58.77	74.00	-15.23	Peak	100	225	P

Note: Level=Reading+Factor
 Margin=Level-Limit
 Factor=Antenna Factor + cable loss - Amplifier Factor



Power	: AC 120V / 60Hz	Pol/Phase	: HORIZONTAL
Test Mode	: Mode 2, Band 1, CH40		:

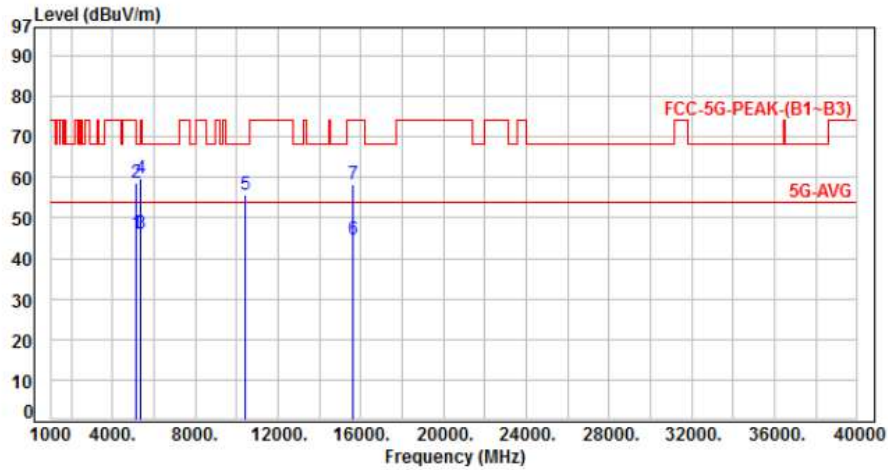

No.	Frequency (MHz)	Factor (dB)	Reading (dBuV)	Level (dBuV/m)	Limit (dBuV/m)	Margin (dB)	Detector	Height (cm)	Azimuth (deg)	P/F
1	5150.00	4.73	41.54	46.27	54.00	-7.73	Average	100	47	P
2	5150.00	4.73	54.05	58.78	74.00	-15.22	Peak	100	47	P
3	5350.00	5.07	40.92	45.99	54.00	-8.01	Average	100	47	P
4	5350.00	5.07	54.70	59.77	74.00	-14.23	Peak	100	47	P
5	10400.00	11.45	44.16	55.61	68.20	-12.59	Peak	100	205	P
6	15600.00	13.88	30.62	44.50	54.00	-9.50	Average	100	311	P
7	15600.00	13.88	44.28	58.16	74.00	-15.84	Peak	100	311	P

Note: Level=Reading+Factor
 Margin=Level-Limit
 Factor=Antenna Factor + cable loss - Amplifier Factor



Power	: AC 120V / 60Hz	Pol/Phase	: VERTICAL
Test Mode	: Mode 2, Band 1, CH48		:

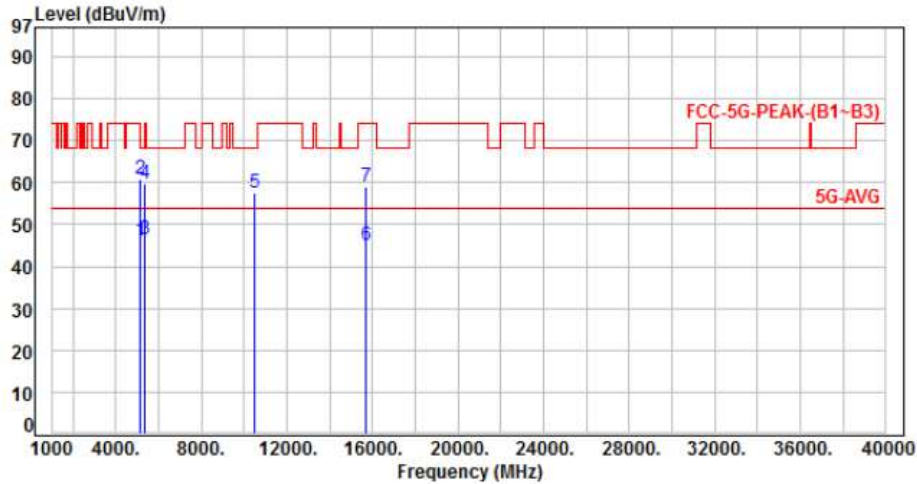

No.	Frequency (MHz)	Factor (dB)	Reading (dBuV)	Level (dBuV/m)	Limit (dBuV/m)	Margin (dB)	Detector	Height (cm)	Azimuth (deg)	P/F
1	5150.00	4.73	41.48	46.21	54.00	-7.79	Average	168	124	P
2	5150.00	4.73	56.18	60.91	74.00	-13.09	Peak	168	124	P
3	5350.00	5.07	41.26	46.33	54.00	-7.67	Average	168	124	P
4	5350.00	5.07	54.82	59.89	74.00	-14.11	Peak	168	124	P
5	10480.00	11.65	45.92	57.57	68.20	-10.63	Peak	306	163	P
6	15720.00	13.60	31.22	44.82	54.00	-9.18	Average	100	216	P
7	15720.00	13.60	45.29	58.89	74.00	-15.11	Peak	100	216	P

Note: Level=Reading+Factor
Margin=Level-Limit
Factor=Antenna Factor + cable loss - Amplifier Factor



Power	: AC 120V / 60Hz	Pol/Phase	: HORIZONTAL
Test Mode	: Mode 2, Band 1, CH48		:

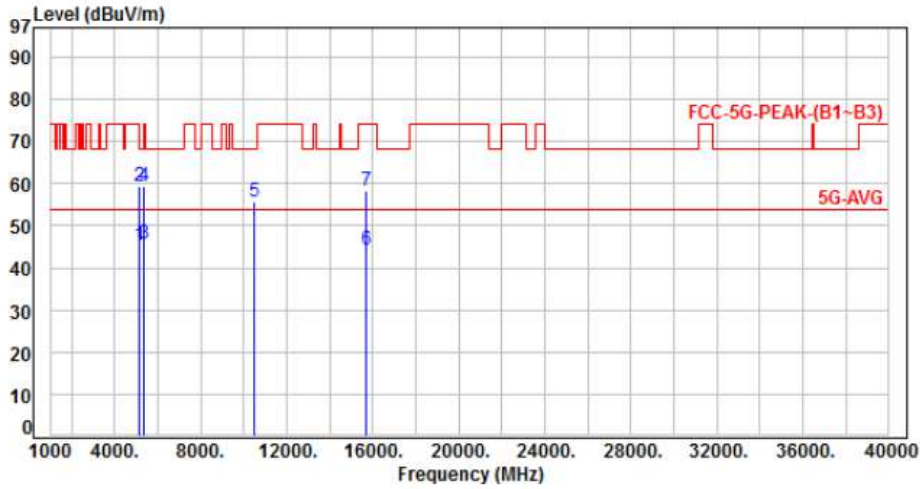

No.	Frequency (MHz)	Factor (dB)	Reading (dBUV)	Level (dBUV/m)	Limit (dBUV/m)	Margin (dB)	Detector	Height (cm)	Azimuth (deg)	P/F
1	5150.00	4.73	40.52	45.25	54.00	-8.75	Average	100	47	P
2	5150.00	4.73	54.76	59.49	74.00	-14.51	Peak	100	47	P
3	5350.00	5.07	40.74	45.81	54.00	-8.19	Average	100	47	P
4	5350.00	5.07	54.29	59.36	74.00	-14.64	Peak	100	47	P
5	10480.00	11.65	44.19	55.84	68.20	-12.36	Peak	100	219	P
6	15720.00	13.60	30.77	44.37	54.00	-9.63	Average	100	228	P
7	15720.00	13.60	44.51	58.11	74.00	-15.89	Peak	100	228	P

Note: Level=Reading+Factor
 Margin=Level-Limit
 Factor=Antenna Factor + cable loss - Amplifier Factor



Power	: AC 120V / 60Hz	Pol/Phase	: VERTICAL
Test Mode	: Mode 3, Band 1, CH38		:

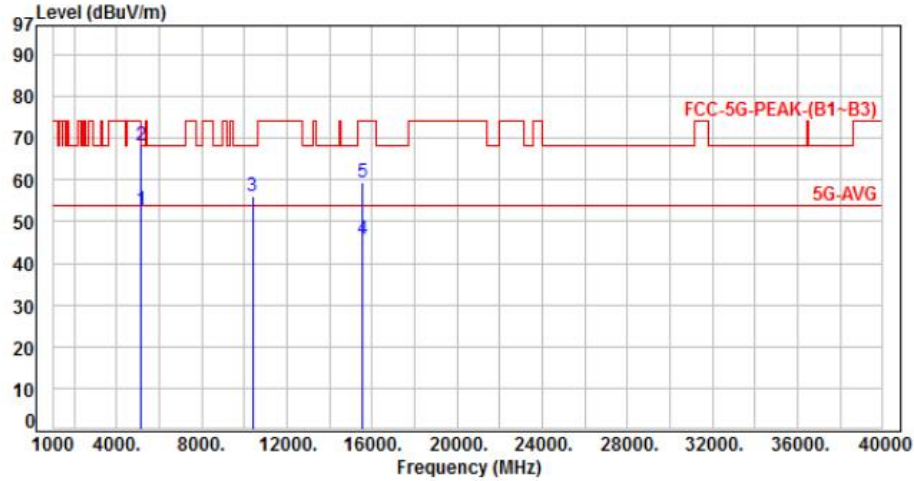

No.	Frequency (MHz)	Factor (dB)	Reading (dBuV)	Level (dBuV/m)	Limit (dBuV/m)	Margin (dB)	Detector	Height (cm)	Azimuth (deg)	P/F
1	5150.00	4.73	48.12	52.85	54.00	-1.15	Average	162	114	P
2	5150.00	4.73	63.54	68.27	74.00	-5.73	Peak	162	114	P
3	10380.00	11.44	44.62	56.06	68.20	-12.14	Peak	312	165	P
4	15540.00	14.27	31.33	45.60	54.00	-8.40	Average	100	330	P
5	15540.00	14.27	45.08	59.35	74.00	-14.65	Peak	100	330	P

Note: Level=Reading+Factor
Margin=Level-Limit
Factor=Antenna Factor + cable loss - Amplifier Factor



Power	: AC 120V / 60Hz	Pol/Phase	: HORIZONTAL
Test Mode	: Mode 3, Band 1, CH38		:

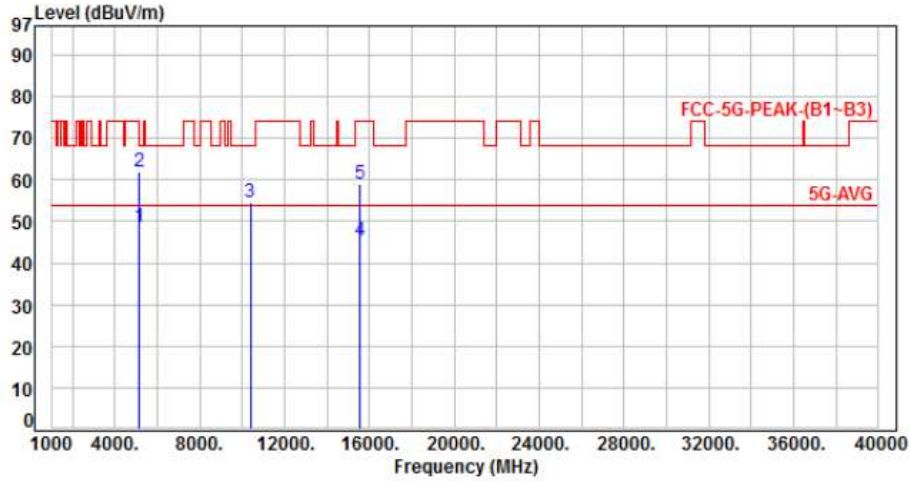

No.	Frequency (MHz)	Factor (dB)	Reading (dBuV)	Level (dBuV/m)	Limit (dBuV/m)	Margin (dB)	Detector	Height (cm)	Azimuth (deg)	P/F
1	5150.00	4.73	43.82	48.55	54.00	-5.45	Average	100	45	P
2	5150.00	4.73	57.22	61.95	74.00	-12.05	Peak	100	45	P
3	10380.00	11.44	43.23	54.67	68.20	-13.53	Peak	100	146	P
4	15540.00	14.27	31.27	45.54	54.00	-8.46	Average	100	323	P
5	15540.00	14.27	44.61	58.88	74.00	-15.12	Peak	100	323	P

Note: Level=Reading+Factor
 Margin=Level-Limit
 Factor=Antenna Factor + cable loss - Amplifier Factor



Power	: AC 120V / 60Hz	Pol/Phase	: VERTICAL
Test Mode	: Mode 3, Band 1, CH46		:

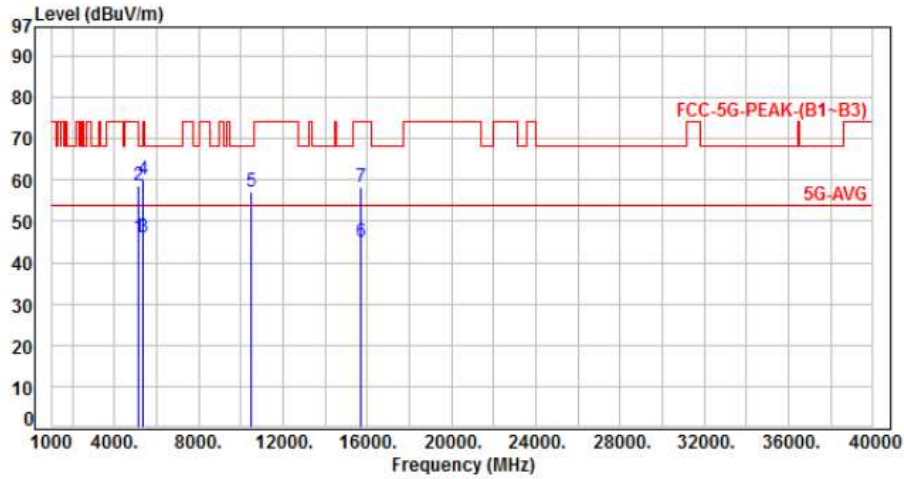

No.	Frequency (MHz)	Factor (dB)	Reading (dBuV)	Level (dBuV/m)	Limit (dBuV/m)	Margin (dB)	Detector	Height (cm)	Azimuth (deg)	P/F
1	5150.00	4.73	41.26	45.99	54.00	-8.01	Average	160	118	P
2	5150.00	4.73	54.05	58.78	74.00	-15.22	Peak	160	118	P
3	5350.00	5.07	40.90	45.97	54.00	-8.03	Average	160	118	P
4	5350.00	5.07	55.12	60.19	74.00	-13.81	Peak	160	118	P
5	10460.00	11.60	45.46	57.06	68.20	-11.14	Peak	307	168	P
6	15690.00	13.64	31.19	44.83	54.00	-9.17	Average	100	226	P
7	15690.00	13.64	44.53	58.17	74.00	-15.83	Peak	100	226	P

Note: Level=Reading+Factor
 Margin=Level-Limit
 Factor=Antenna Factor + cable loss - Amplifier Factor



Power	: AC 120V / 60Hz	Pol/Phase	: HORIZONTAL
Test Mode	: Mode 3, Band 1, CH46		:

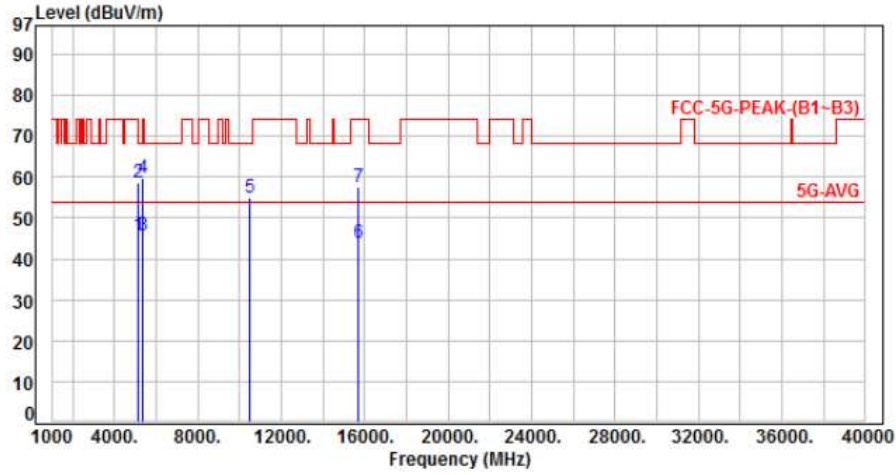

No.	Frequency (MHz)	Factor (dB)	Reading (dBuV)	Level (dBuV/m)	Limit (dBuV/m)	Margin (dB)	Detector	Height (cm)	Azimuth (deg)	P/F
1	5150.00	4.73	40.97	45.70	54.00	-8.30	Average	100	47	P
2	5150.00	4.73	53.90	58.63	74.00	-15.37	Peak	100	47	P
3	5350.00	5.07	40.80	45.87	54.00	-8.13	Average	100	47	P
4	5350.00	5.07	54.80	59.87	74.00	-14.13	Peak	100	47	P
5	10460.00	11.60	43.51	55.11	68.20	-13.09	Peak	100	221	P
6	15690.00	13.64	30.29	43.93	54.00	-10.07	Average	100	310	P
7	15690.00	13.64	43.81	57.45	74.00	-16.55	Peak	100	310	P

Note: Level=Reading+Factor
 Margin=Level-Limit
 Factor=Antenna Factor + cable loss - Amplifier Factor



Power	: AC 120V / 60Hz	Pol/Phase	: VERTICAL
Test Mode	: Mode 4, Band 1, CH42		:

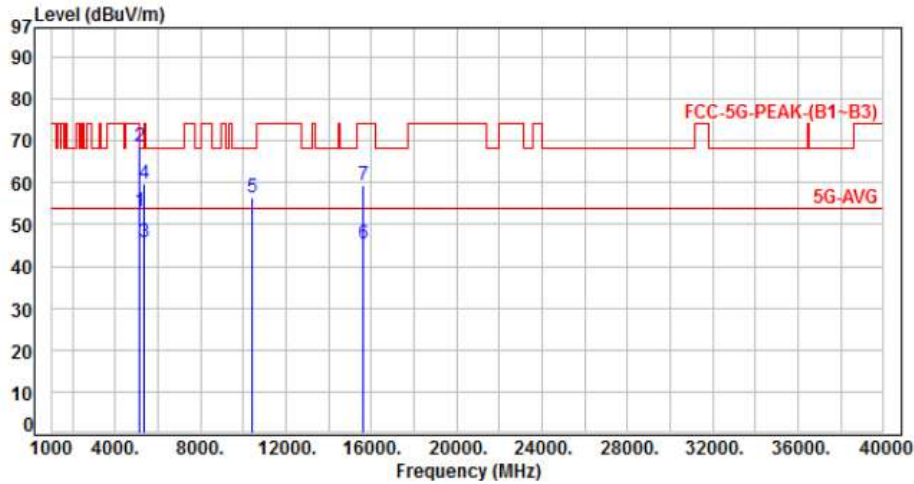

No.	Frequency (MHz)	Factor (dB)	Reading (dBuV)	Level (dBuV/m)	Limit (dBuV/m)	Margin (dB)	Detector	Height (cm)	Azimuth (deg)	P/F
1	5150.00	4.73	48.26	52.99	54.00	-1.01	Average	161	116	P
2	5150.00	4.73	63.80	68.53	74.00	-5.47	Peak	161	116	P
3	5350.00	5.07	40.65	45.72	54.00	-8.28	Average	161	116	P
4	5350.00	5.07	54.70	59.77	74.00	-14.23	Peak	161	116	P
5	10420.00	11.49	45.12	56.61	68.20	-11.59	Peak	309	168	P
6	15630.00	13.80	31.46	45.26	54.00	-8.74	Average	100	326	P
7	15630.00	13.80	45.52	59.32	74.00	-14.68	Peak	100	326	P

Note: Level=Reading+Factor
Margin=Level-Limit
Factor=Antenna Factor + cable loss - Amplifier Factor



Power	: AC 120V / 60Hz	Pol/Phase	: HORIZONTAL
Test Mode	: Mode 4, Band 1, CH42		:

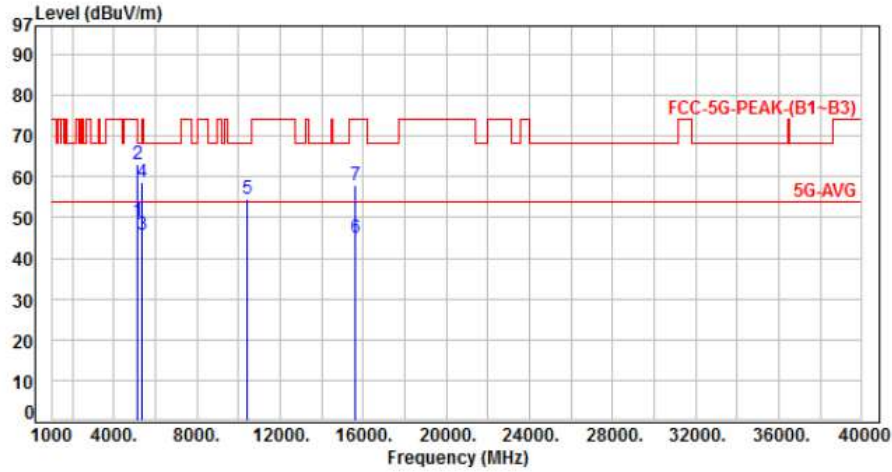

No.	Frequency (MHz)	Factor (dB)	Reading (dBuV)	Level (dBuV/m)	Limit (dBuV/m)	Margin (dB)	Detector	Height (cm)	Azimuth (deg)	P/F
1	5150.00	4.73	44.30	49.03	54.00	-4.97	Average	100	45	P
2	5150.00	4.73	58.50	63.23	74.00	-10.77	Peak	100	45	P
3	5350.00	5.07	40.50	45.57	54.00	-8.43	Average	100	45	P
4	5350.00	5.07	53.40	58.47	74.00	-15.53	Peak	100	45	P
5	10420.00	11.49	43.10	54.59	68.20	-13.61	Peak	100	155	P
6	15630.00	13.80	31.09	44.89	54.00	-9.11	Average	100	318	P
7	15630.00	13.80	44.20	58.00	74.00	-16.00	Peak	100	318	P

Note: Level=Reading+Factor
 Margin=Level-Limit
 Factor=Antenna Factor + cable loss - Amplifier Factor



Power	: AC 120V / 60Hz	Pol/Phase	: VERTICAL
Test Mode	: Mode 1, Band 2, CH52		:

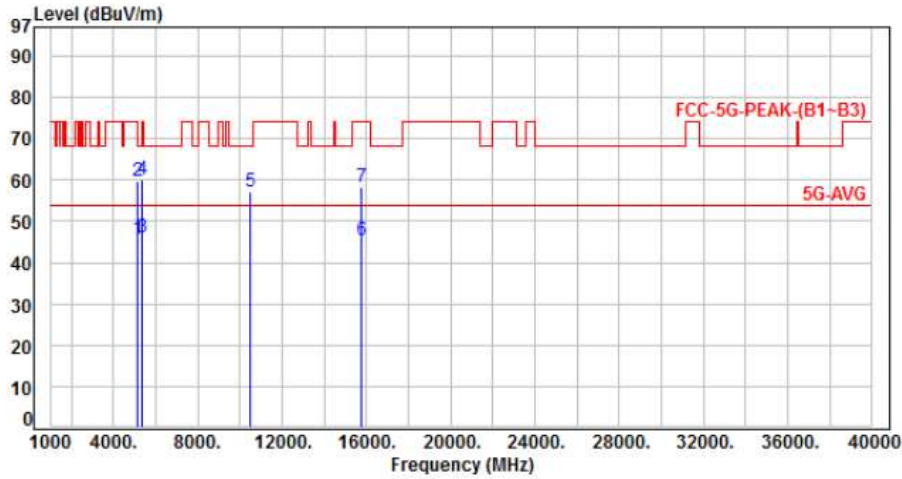

No.	Frequency (MHz)	Factor (dB)	Reading (dBuV)	Level (dBuV/m)	Limit (dBuV/m)	Margin (dB)	Detector	Height (cm)	Azimuth (deg)	P/F
1	5150.00	4.73	40.95	45.68	54.00	-8.32	Average	146	118	P
2	5150.00	4.73	55.12	59.85	74.00	-14.15	Peak	146	118	P
3	5350.00	5.07	40.89	45.96	54.00	-8.04	Average	146	118	P
4	5350.00	5.07	55.01	60.08	74.00	-13.92	Peak	146	118	P
5	10520.00	11.74	45.38	57.12	68.20	-11.08	Peak	323	170	P
6	15780.00	13.57	31.89	45.46	54.00	-8.54	Average	100	235	P
7	15780.00	13.57	44.85	58.42	74.00	-15.58	Peak	100	235	P

Note: Level=Reading+Factor
 Margin=Level-Limit
 Factor=Antenna Factor + cable loss - Amplifier Factor



Power	: AC 120V / 60Hz	Pol/Phase	: HORIZONTAL
Test Mode	: Mode 1, Band 2, CH52		:

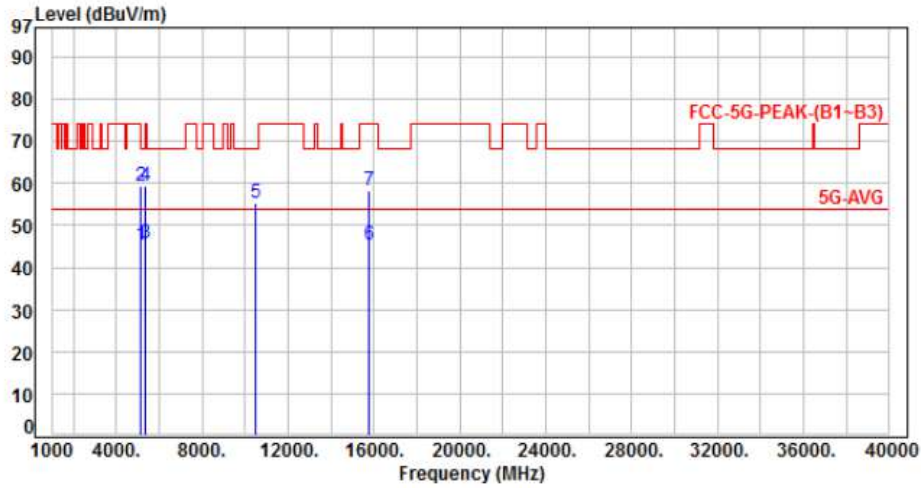

No.	Frequency (MHz)	Factor (dB)	Reading (dBuV)	Level (dBuV/m)	Limit (dBuV/m)	Margin (dB)	Detector	Height (cm)	Azimuth (deg)	P/F
1	5150.00	4.73	40.78	45.51	54.00	-8.49	Average	100	45	P
2	5150.00	4.73	54.50	59.23	74.00	-14.77	Peak	100	45	P
3	5350.00	5.07	40.52	45.59	54.00	-8.41	Average	100	45	P
4	5350.00	5.07	54.36	59.43	74.00	-14.57	Peak	100	45	P
5	10520.00	11.74	43.51	55.25	68.20	-12.95	Peak	100	216	P
6	15780.00	13.57	31.80	45.37	54.00	-8.63	Average	100	302	P
7	15780.00	13.57	44.80	58.37	74.00	-15.63	Peak	100	302	P

Note: Level=Reading+Factor
Margin=Level-Limit
Factor=Antenna Factor + cable loss - Amplifier Factor



Power	: AC 120V / 60Hz	Pol/Phase	: VERTICAL
Test Mode	: Mode 1, Band 2, CH60		:

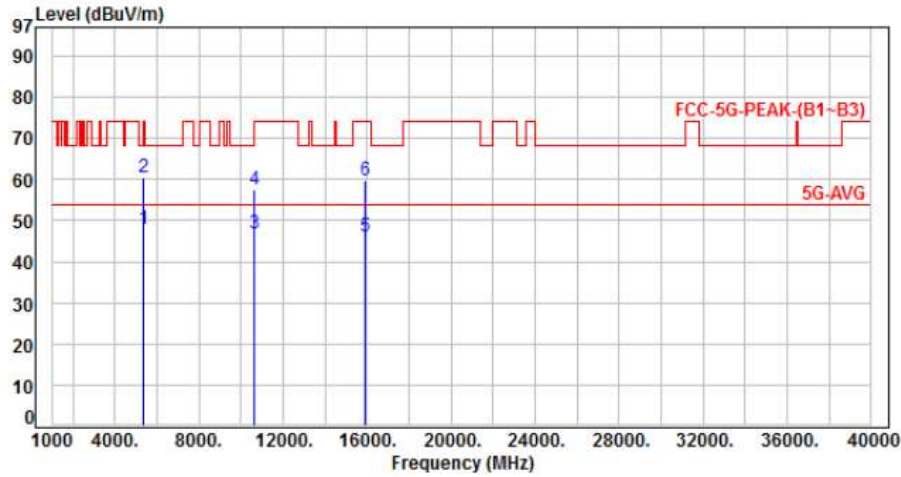

No.	Frequency (MHz)	Factor (dB)	Reading (dBuV)	Level (dBuV/m)	Limit (dBuV/m)	Margin (dB)	Detector	Height (cm)	Azimuth (deg)	P/F
1	5350.00	5.07	42.76	47.83	54.00	-6.17	Average	155	122	P
2	5350.00	5.07	55.50	60.57	74.00	-13.43	Peak	155	122	P
3	10600.00	11.91	35.01	46.92	54.00	-7.08	Average	354	185	P
4	10600.00	11.91	45.55	57.46	74.00	-16.54	Peak	354	185	P
5	15900.00	13.59	32.46	46.05	54.00	-7.95	Average	100	242	P
6	15900.00	13.59	46.03	59.62	74.00	-14.38	Peak	100	242	P

Note: Level=Reading+Factor
 Margin=Level-Limit
 Factor=Antenna Factor + cable loss - Amplifier Factor



Power	: AC 120V / 60Hz	Pol/Phase	: HORIZONTAL
Test Mode	: Mode 1, Band 2, CH60		:

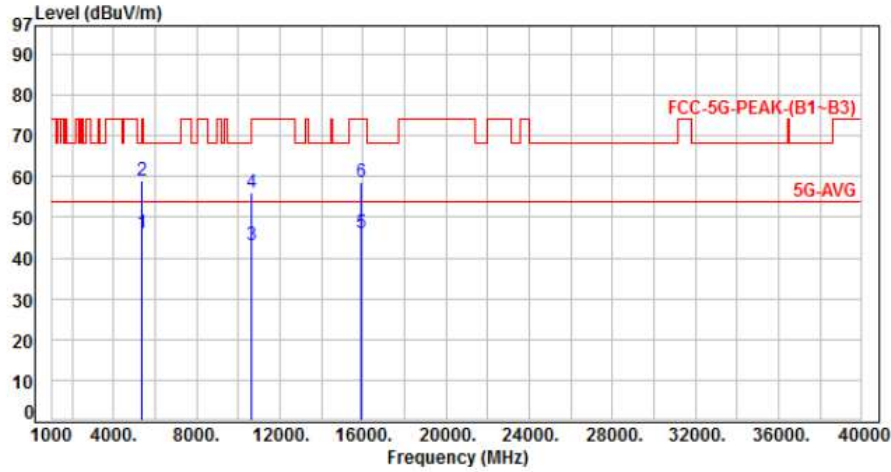

No.	Frequency (MHz)	Factor (dB)	Reading (dBuV)	Level (dBuV/m)	Limit (dBuV/m)	Margin (dB)	Detector	Height (cm)	Azimuth (deg)	P/F
1	5350.00	5.07	41.08	46.15	54.00	-7.85	Average	100	48	P
2	5350.00	5.07	54.10	59.17	74.00	-14.83	Peak	100	48	P
3	10600.00	11.91	31.19	43.10	54.00	-10.90	Average	100	182	P
4	10600.00	11.91	43.98	55.89	74.00	-18.11	Peak	100	182	P
5	15900.00	13.59	32.41	46.00	54.00	-8.00	Average	100	316	P
6	15900.00	13.59	44.90	58.49	74.00	-15.51	Peak	100	316	P

Note: Level=Reading+Factor
Margin=Level-Limit
Factor=Antenna Factor + cable loss - Amplifier Factor



Power	: AC 120V / 60Hz	Pol/Phase	: VERTICAL
Test Mode	: Mode 1, Band 2, CH64		:

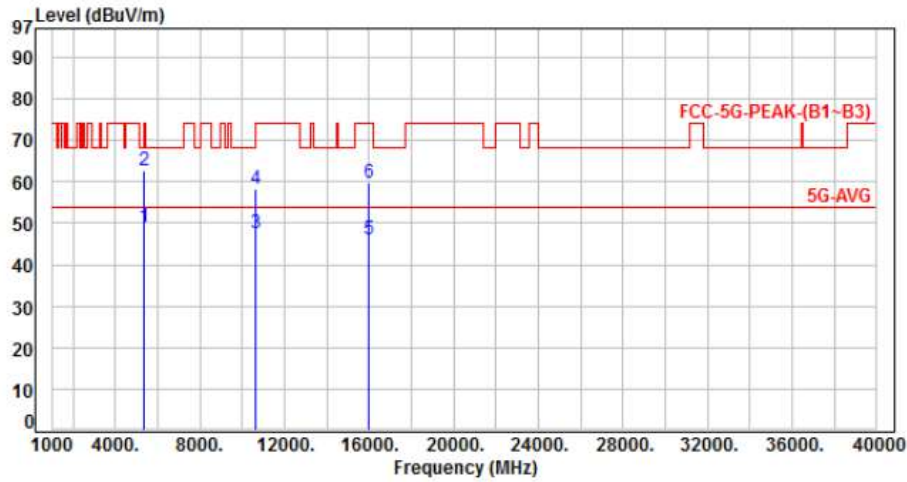

No.	Frequency (MHz)	Factor (dB)	Reading (dBuV)	Level (dBuV/m)	Limit (dBuV/m)	Margin (dB)	Detector	Height (cm)	Azimuth (deg)	P/F
1	5350.00	5.07	44.12	49.19	54.00	-4.81	Average	158	121	P
2	5350.00	5.07	57.58	62.65	74.00	-11.35	Peak	158	121	P
3	10640.00	11.98	35.61	47.59	54.00	-6.41	Average	350	182	P
4	10640.00	11.98	46.42	58.40	74.00	-15.60	Peak	350	182	P
5	15960.00	13.44	32.62	46.06	54.00	-7.94	Average	100	252	P
6	15960.00	13.44	46.37	59.81	74.00	-14.19	Peak	100	252	P

Note: Level=Reading+Factor
 Margin=Level-Limit
 Factor=Antenna Factor + cable loss - Amplifier Factor



Power	: AC 120V / 60Hz	Pol/Phase	: HORIZONTAL
Test Mode	: Mode 1, Band 2, CH64		:

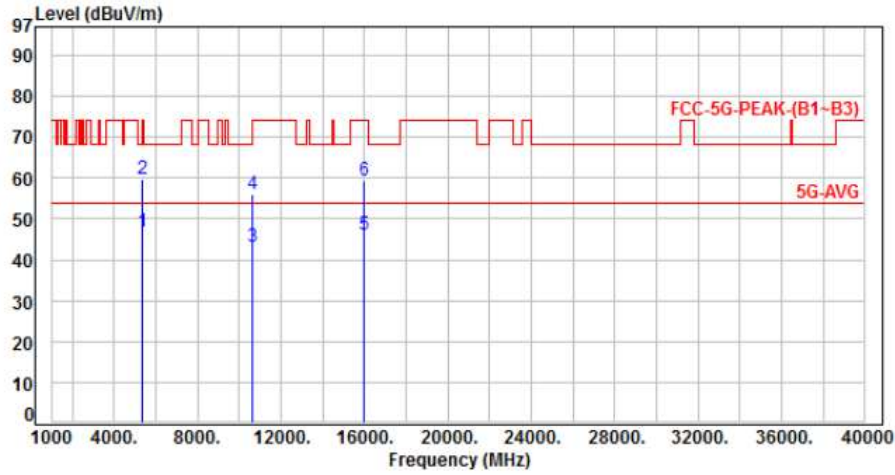

No.	Frequency (MHz)	Factor (dB)	Reading (dBuV)	Level (dBuV/m)	Limit (dBuV/m)	Margin (dB)	Detector	Height (cm)	Azimuth (deg)	P/F
1	5350.00	5.07	41.60	46.67	54.00	-7.33	Average	100	44	P
2	5350.00	5.07	54.50	59.57	74.00	-14.43	Peak	100	44	P
3	10640.00	11.98	31.29	43.27	54.00	-10.73	Average	100	179	P
4	10640.00	11.98	44.08	56.06	74.00	-17.94	Peak	100	179	P
5	15960.00	13.44	32.49	45.93	54.00	-8.07	Average	100	311	P
6	15960.00	13.44	45.93	59.37	74.00	-14.63	Peak	100	311	P

Note: Level=Reading+Factor
 Margin=Level-Limit
 Factor=Antenna Factor + cable loss - Amplifier Factor



Power	: AC 120V / 60Hz	Pol/Phase	: VERTICAL
Test Mode	: Mode 2, Band 2, CH52		:

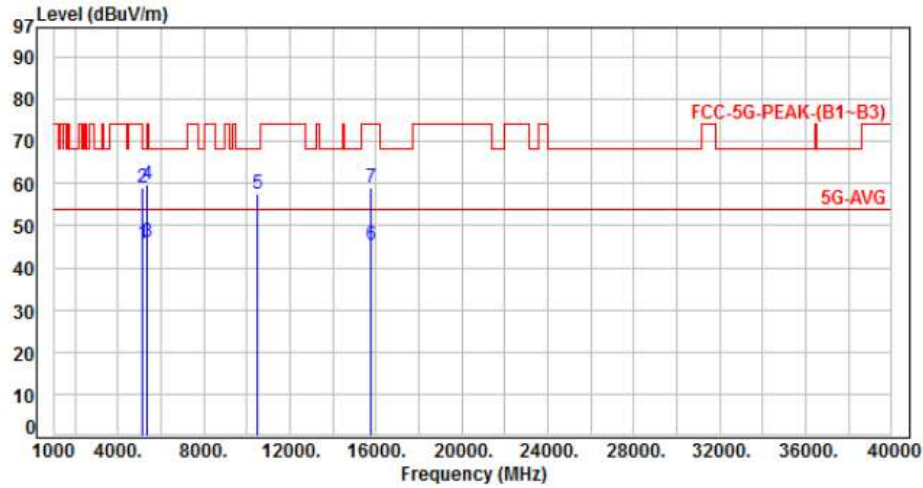

No.	Frequency (MHz)	Factor (dB)	Reading (dBuV)	Level (dBuV/m)	Limit (dBuV/m)	Margin (dB)	Detector	Height (cm)	Azimuth (deg)	P/F
1	5150.00	4.73	40.82	45.55	54.00	-8.45	Average	147	119	P
2	5150.00	4.73	54.45	59.18	74.00	-14.82	Peak	147	119	P
3	5350.00	5.07	40.96	46.03	54.00	-7.97	Average	147	119	P
4	5350.00	5.07	54.78	59.85	74.00	-14.15	Peak	147	119	P
5	10520.00	11.74	45.65	57.39	68.20	-10.81	Peak	324	169	P
6	15780.00	13.57	31.96	45.53	54.00	-8.47	Average	100	231	P
7	15780.00	13.57	45.55	59.12	74.00	-14.88	Peak	100	231	P

Note: Level=Reading+Factor
 Margin=Level-Limit
 Factor=Antenna Factor + cable loss - Amplifier Factor



Power	: AC 120V / 60Hz	Pol/Phase	: HORIZONTAL
Test Mode	: Mode 2, Band 2, CH52		:

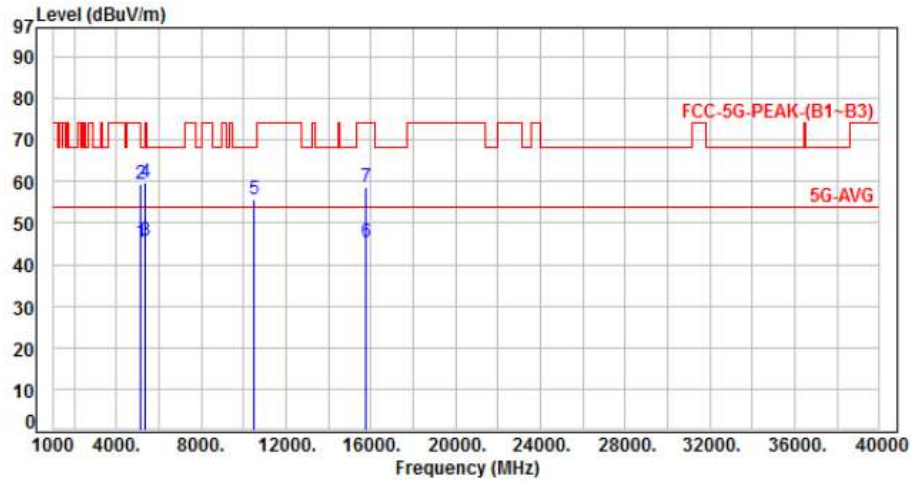

No.	Frequency (MHz)	Factor (dB)	Reading (dBuV)	Level (dBuV/m)	Limit (dBuV/m)	Margin (dB)	Detector	Height (cm)	Azimuth (deg)	P/F
1	5150.00	4.73	40.62	45.35	54.00	-8.65	Average	100	48	P
2	5150.00	4.73	54.71	59.44	74.00	-14.56	Peak	100	48	P
3	5350.00	5.07	40.62	45.69	54.00	-8.31	Average	100	48	P
4	5350.00	5.07	54.62	59.69	74.00	-14.31	Peak	100	48	P
5	10520.00	11.74	43.95	55.69	68.20	-12.51	Peak	100	222	P
6	15780.00	13.57	31.71	45.28	54.00	-8.72	Average	100	213	P
7	15780.00	13.57	45.16	58.73	74.00	-15.27	Peak	100	213	P

Note: Level=Reading+Factor
 Margin=Level-Limit
 Factor=Antenna Factor + cable loss - Amplifier Factor



Power	: AC 120V / 60Hz	Pol/Phase	: VERTICAL
Test Mode	: Mode 2, Band 2, CH60		

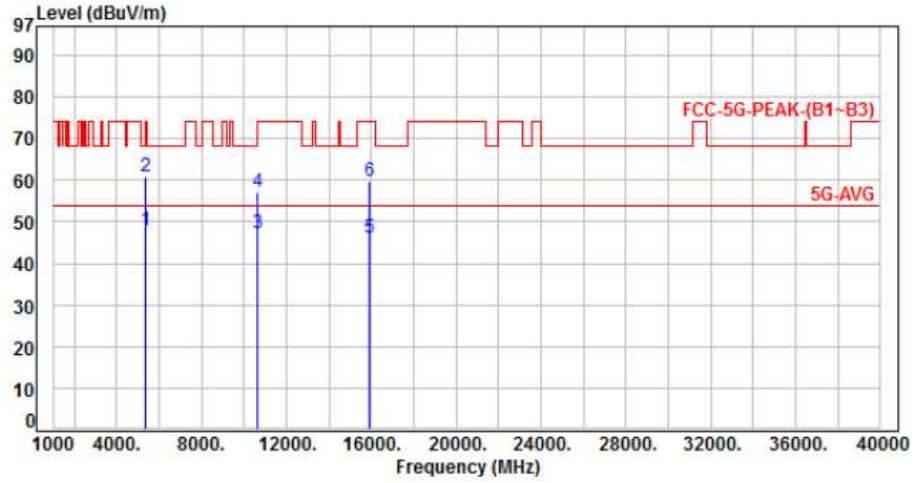

No.	Frequency (MHz)	Factor (dB)	Reading (dBuV)	Level (dBuV/m)	Limit (dBuV/m)	Margin (dB)	Detector	Height (cm)	Azimuth (deg)	P/F
1	5350.00	5.07	42.95	48.02	54.00	-5.98	Average	157	125	P
2	5350.00	5.07	55.84	60.91	74.00	-13.09	Peak	157	125	P
3	10600.00	11.91	35.33	47.24	54.00	-6.76	Average	361	183	P
4	10600.00	11.91	45.39	57.30	74.00	-16.70	Peak	361	183	P
5	15900.00	13.59	32.36	45.95	54.00	-8.05	Average	100	248	P
6	15900.00	13.59	46.27	59.86	74.00	-14.14	Peak	100	248	P

Note: Level=Reading+Factor
Margin=Level-Limit
Factor=Antenna Factor + cable loss - Amplifier Factor



Power	: AC 120V / 60Hz	Pol/Phase	: HORIZONTAL
Test Mode	: Mode 2, Band 2, CH60		:

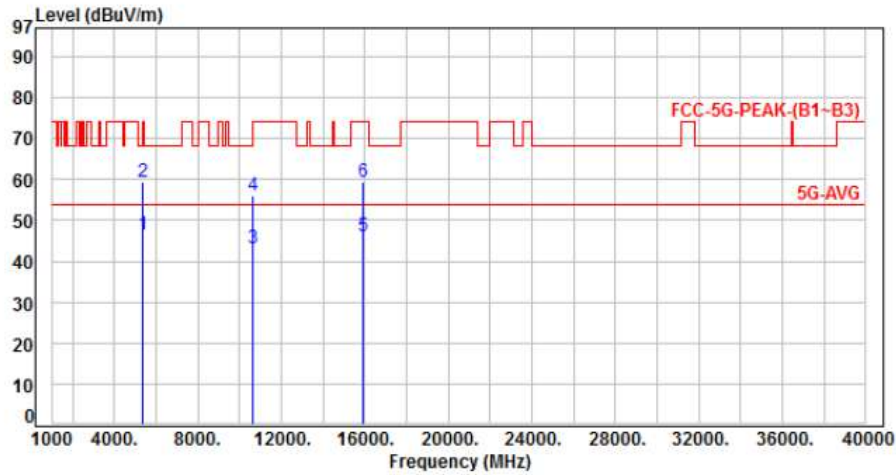

No.	Frequency (MHz)	Factor (dB)	Reading (dBuV)	Level (dBuV/m)	Limit (dBuV/m)	Margin (dB)	Detector	Height (cm)	Azimuth (deg)	P/F
1	5350.00	5.07	41.26	46.33	54.00	-7.67	Average	100	45	P
2	5350.00	5.07	54.39	59.46	74.00	-14.54	Peak	100	45	P
3	10600.00	11.91	31.34	43.25	54.00	-10.75	Average	100	178	P
4	10600.00	11.91	44.28	56.19	74.00	-17.81	Peak	100	178	P
5	15900.00	13.59	32.53	46.12	54.00	-7.88	Average	100	323	P
6	15900.00	13.59	45.75	59.34	74.00	-14.66	Peak	100	323	P

Note: Level=Reading+Factor
Margin=Level-Limit
Factor=Antenna Factor + cable loss - Amplifier Factor



Power	: AC 120V / 60Hz	Pol/Phase	: VERTICAL
Test Mode	: Mode 2, Band 2, CH64		:

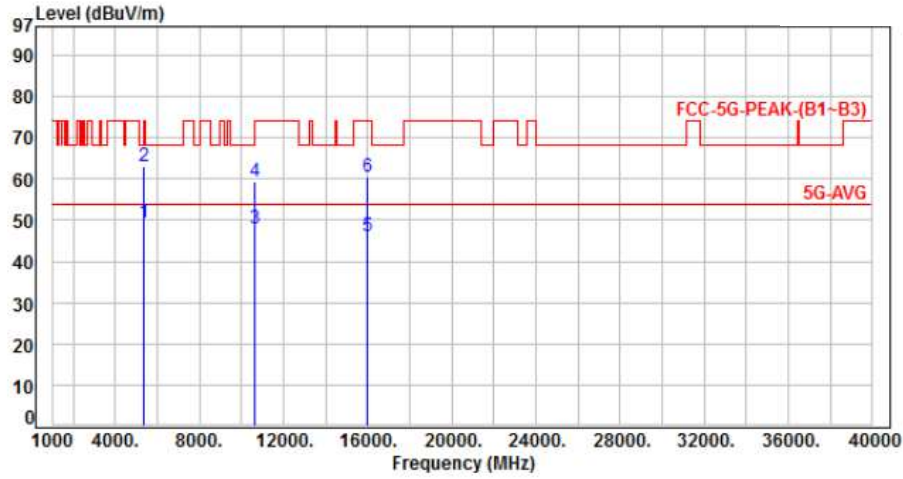

No.	Frequency (MHz)	Factor (dB)	Reading (dBuV)	Level (dBuV/m)	Limit (dBuV/m)	Margin (dB)	Detector	Height (cm)	Azimuth (deg)	P/F
1	5350.00	5.07	44.46	49.53	54.00	-4.47	Average	160	122	P
2	5350.00	5.07	57.94	63.01	74.00	-10.99	Peak	160	122	P
3	10640.00	11.98	35.91	47.89	54.00	-6.11	Average	355	180	P
4	10640.00	11.98	47.30	59.28	74.00	-14.72	Peak	355	180	P
5	15960.00	13.44	32.78	46.22	54.00	-7.78	Average	100	249	P
6	15960.00	13.44	47.15	60.59	74.00	-13.41	Peak	100	249	P

Note: Level=Reading+Factor
 Margin=Level-Limit
 Factor=Antenna Factor + cable loss - Amplifier Factor



Power	: AC 120V / 60Hz	Pol/Phase	: HORIZONTAL
Test Mode	: Mode 2, Band 2, CH64		:

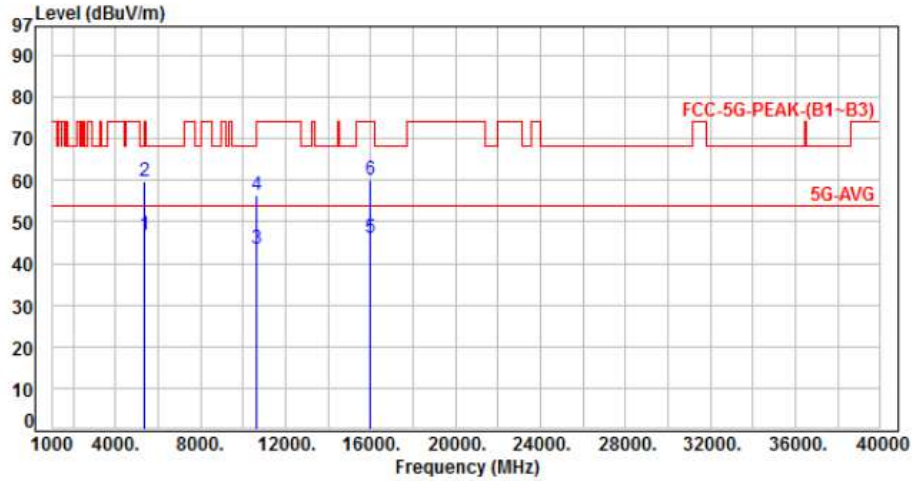

No.	Frequency (MHz)	Factor (dB)	Reading (dBuV)	Level (dBuV/m)	Limit (dBuV/m)	Margin (dB)	Detector	Height (cm)	Azimuth (deg)	P/F
1	5350.00	5.07	41.69	46.76	54.00	-7.24	Average	100	46	P
2	5350.00	5.07	54.85	59.92	74.00	-14.08	Peak	100	46	P
3	10640.00	11.98	31.42	43.40	54.00	-10.60	Average	100	183	P
4	10640.00	11.98	44.35	56.33	74.00	-17.67	Peak	100	183	P
5	15960.00	13.44	32.52	45.96	54.00	-8.04	Average	100	304	P
6	15960.00	13.44	46.61	60.05	74.00	-13.95	Peak	100	304	P

Note: Level=Reading+Factor
Margin=Level-Limit
Factor=Antenna Factor + cable loss - Amplifier Factor



Power	: AC 120V / 60Hz	Pol/Phase	: VERTICAL
Test Mode	: Mode 3, Band 2, CH54		:

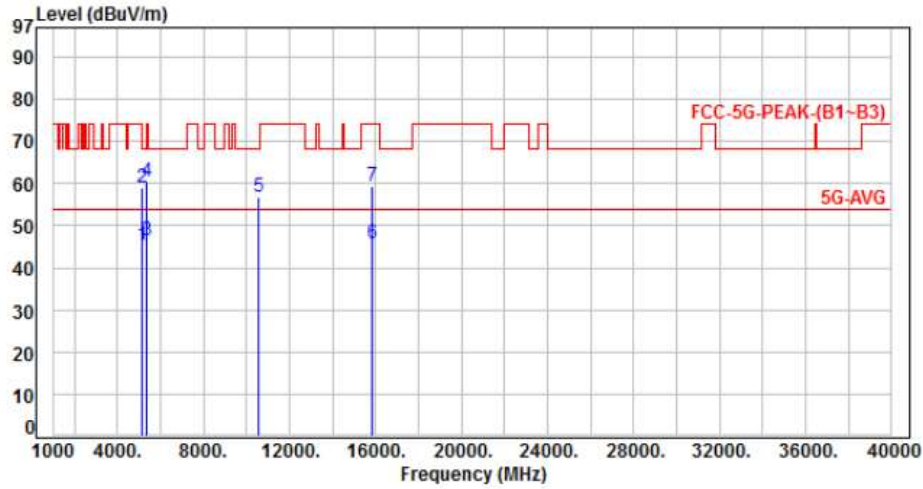

No.	Frequency (MHz)	Factor (dB)	Reading (dBuV)	Level (dBuV/m)	Limit (dBuV/m)	Margin (dB)	Detector	Height (cm)	Azimuth (deg)	P/F
1	5150.00	4.73	40.75	45.48	54.00	-8.52	Average	152	124	P
2	5150.00	4.73	54.24	58.97	74.00	-15.03	Peak	152	124	P
3	5350.00	5.07	41.53	46.60	54.00	-7.40	Average	152	124	P
4	5350.00	5.07	55.45	60.52	74.00	-13.48	Peak	152	124	P
5	10540.00	11.78	45.13	56.91	68.20	-11.29	Peak	366	181	P
6	15810.00	13.56	32.32	45.88	54.00	-8.12	Average	100	224	P
7	15810.00	13.56	45.68	59.24	74.00	-14.76	Peak	100	224	P

Note: Level=Reading+Factor
Margin=Level-Limit
Factor=Antenna Factor + cable loss - Amplifier Factor



Power	: AC 120V / 60Hz	Pol/Phase	: HORIZONTAL
Test Mode	: Mode 3, Band 2, CH54		:

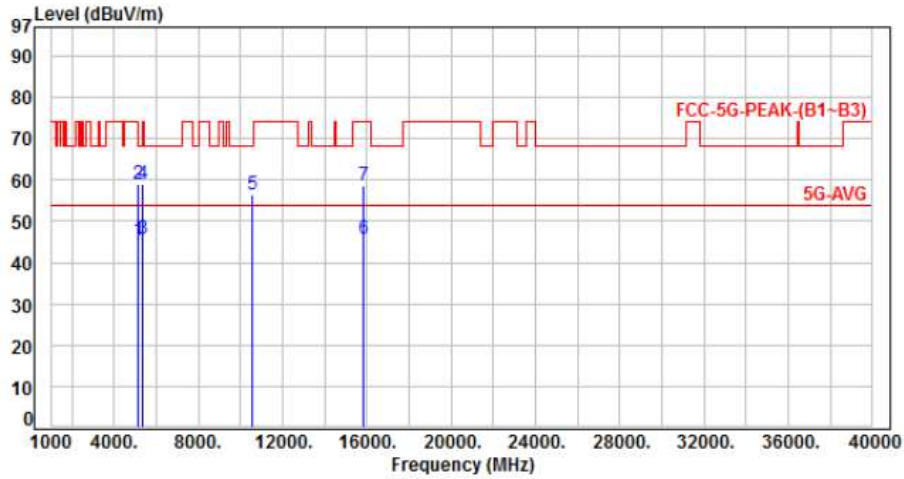

No.	Frequency (MHz)	Factor (dB)	Reading (dBuV)	Level (dBuV/m)	Limit (dBuV/m)	Margin (dB)	Detector	Height (cm)	Azimuth (deg)	P/F
1	5150.00	4.73	40.73	45.46	54.00	-8.54	Average	100	46	P
2	5150.00	4.73	54.11	58.84	74.00	-15.16	Peak	100	46	P
3	5350.00	5.07	40.85	45.92	54.00	-8.08	Average	100	46	P
4	5350.00	5.07	53.96	59.03	74.00	-14.97	Peak	100	46	P
5	10540.00	11.78	44.62	56.40	68.20	-11.80	Peak	100	225	P
6	15810.00	13.56	32.24	45.80	54.00	-8.20	Average	100	231	P
7	15810.00	13.56	45.26	58.82	74.00	-15.18	Peak	100	231	P

Note: Level=Reading+Factor
 Margin=Level-Limit
 Factor=Antenna Factor + cable loss - Amplifier Factor



Power	: AC 120V / 60Hz	Pol/Phase	: VERTICAL
Test Mode	: Mode 3, Band 2, CH62		:

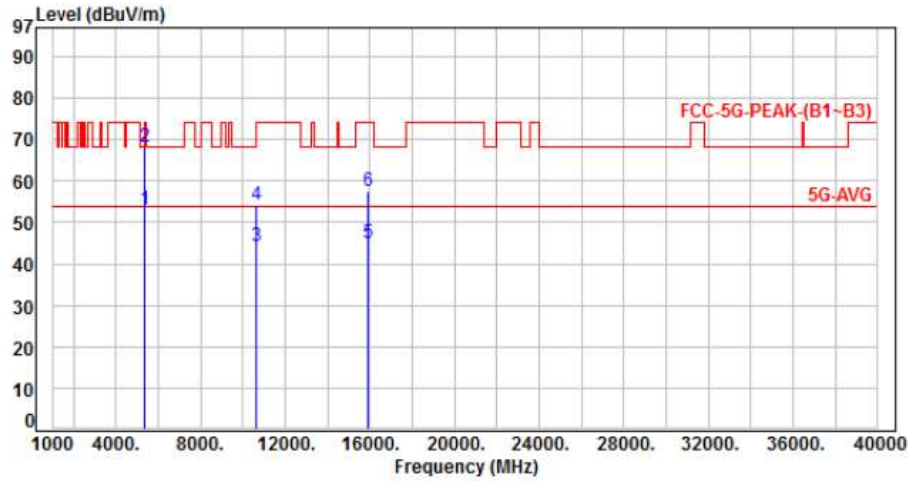

No.	Frequency (MHz)	Factor (dB)	Reading (dBuV)	Level (dBuV/m)	Limit (dBuV/m)	Margin (dB)	Detector	Height (cm)	Azimuth (deg)	P/F
1	5350.00	5.07	47.90	52.97	54.00	-1.03	Average	161	122	P
2	5350.00	5.07	63.30	68.37	74.00	-5.63	Peak	161	122	P
3	10620.00	11.95	32.44	44.39	54.00	-9.61	Average	344	183	P
4	10620.00	11.95	42.31	54.26	74.00	-19.74	Peak	344	183	P
5	15930.00	13.52	31.31	44.83	54.00	-9.17	Average	100	238	P
6	15930.00	13.52	44.10	57.62	74.00	-16.38	Peak	100	238	P

Note: Level=Reading+Factor
Margin=Level-Limit
Factor=Antenna Factor + cable loss - Amplifier Factor



Power	: AC 120V / 60Hz	Pol/Phase	: HORIZONTAL
Test Mode	: Mode 3, Band 2, CH62		:

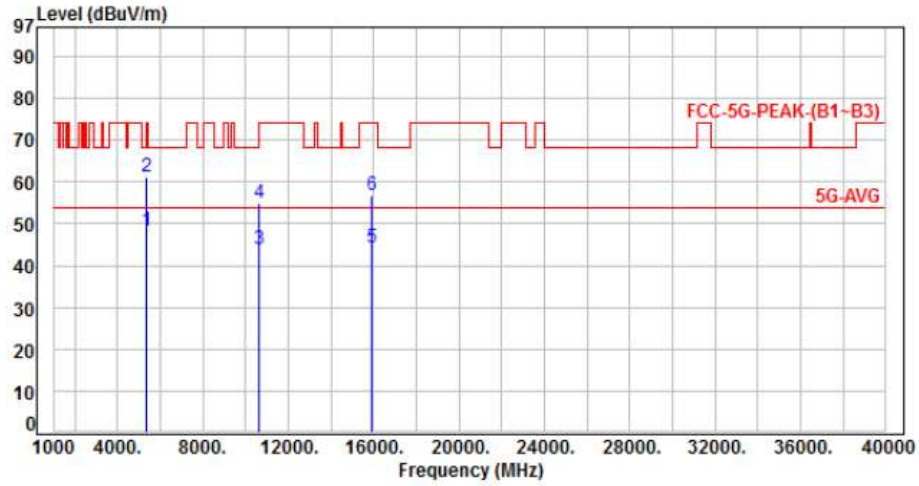

No.	Frequency (MHz)	Factor (dB)	Reading (dBuV)	Level (dBuV/m)	Limit (dBuV/m)	Margin (dB)	Detector	Height (cm)	Azimuth (deg)	P/F
1	5350.00	5.07	43.32	48.39	54.00	-5.61	Average	100	46	P
2	5350.00	5.07	56.07	61.14	74.00	-12.86	Peak	100	46	P
3	10620.00	11.95	31.85	43.80	54.00	-10.20	Average	100	155	P
4	10620.00	11.95	43.12	55.07	74.00	-18.93	Peak	100	155	P
5	15930.00	13.52	30.74	44.26	54.00	-9.74	Average	100	318	P
6	15930.00	13.52	43.28	56.80	74.00	-17.20	Peak	100	318	P

Note: Level=Reading+Factor
Margin=Level-Limit
Factor=Antenna Factor + cable loss - Amplifier Factor



Power	: AC 120V / 60Hz	Pol/Phase	: VERTICAL
Test Mode	: Mode 4, Band 2, CH58		:

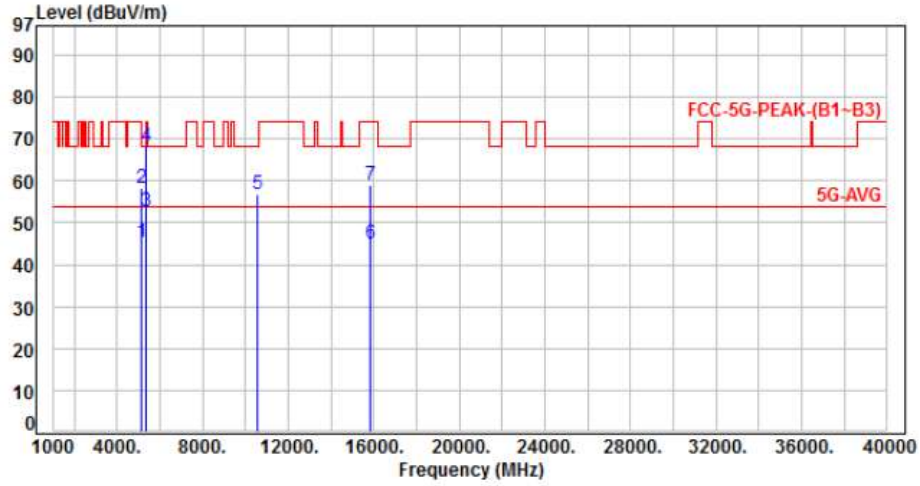

No.	Frequency (MHz)	Factor (dB)	Reading (dBuV)	Level (dBuV/m)	Limit (dBuV/m)	Margin (dB)	Detector	Height (cm)	Azimuth (deg)	P/F
1	5150.00	4.73	40.80	45.53	54.00	-8.47	Average	158	123	P
2	5150.00	4.73	53.60	58.33	74.00	-15.67	Peak	158	123	P
3	5350.00	5.07	47.85	52.92	54.00	-1.08	Average	158	123	P
4	5350.00	5.07	63.10	68.17	74.00	-5.83	Peak	158	123	P
5	10580.00	11.86	44.96	56.82	68.20	-11.38	Peak	306	166	P
6	15870.00	13.58	31.32	44.90	54.00	-9.10	Average	100	339	P
7	15870.00	13.58	45.41	58.99	74.00	-15.01	Peak	100	339	P

Note: Level=Reading+Factor
 Margin=Level-Limit
 Factor=Antenna Factor + cable loss - Amplifier Factor



Power	: AC 120V / 60Hz	Pol/Phase	: HORIZONTAL
Test Mode	: Mode 4, Band 2, CH58		:

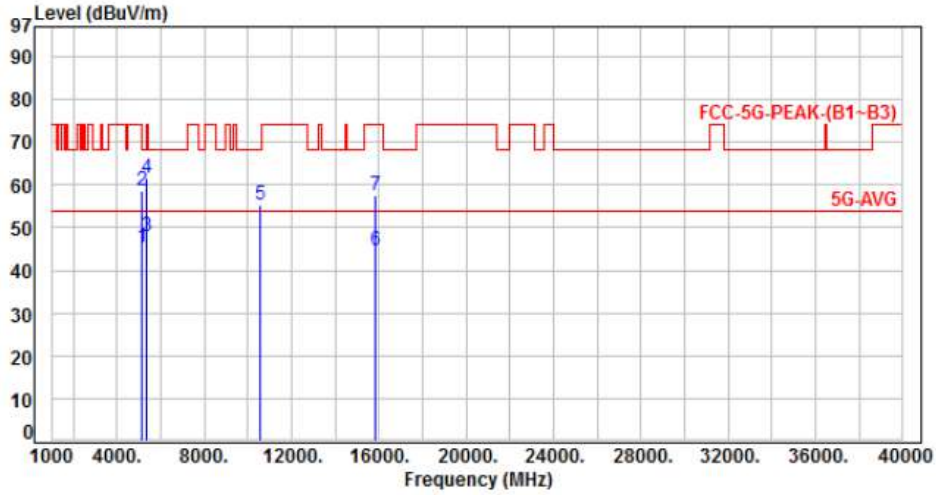

No.	Frequency (MHz)	Factor (dB)	Reading (dBuV)	Level (dBuV/m)	Limit (dBuV/m)	Margin (dB)	Detector	Height (cm)	Azimuth (deg)	P/F
1	5150.00	4.73	40.75	45.48	54.00	-8.52	Average	100	45	P
2	5150.00	4.73	54.00	58.73	74.00	-15.27	Peak	100	45	P
3	5350.00	5.07	42.90	47.97	54.00	-6.03	Average	100	45	P
4	5350.00	5.07	56.45	61.52	74.00	-12.48	Peak	100	45	P
5	10580.00	11.86	43.28	55.14	68.20	-13.06	Peak	100	159	P
6	15870.00	13.58	30.91	44.49	54.00	-9.51	Average	100	323	P
7	15870.00	13.58	43.85	57.43	74.00	-16.57	Peak	100	323	P

Note: Level=Reading+Factor
Margin=Level-Limit
Factor=Antenna Factor + cable loss - Amplifier Factor



Power	: AC 120V / 60Hz	Pol/Phase	: VERTICAL
Test Mode	: Mode 1, Band 3, CH100		:

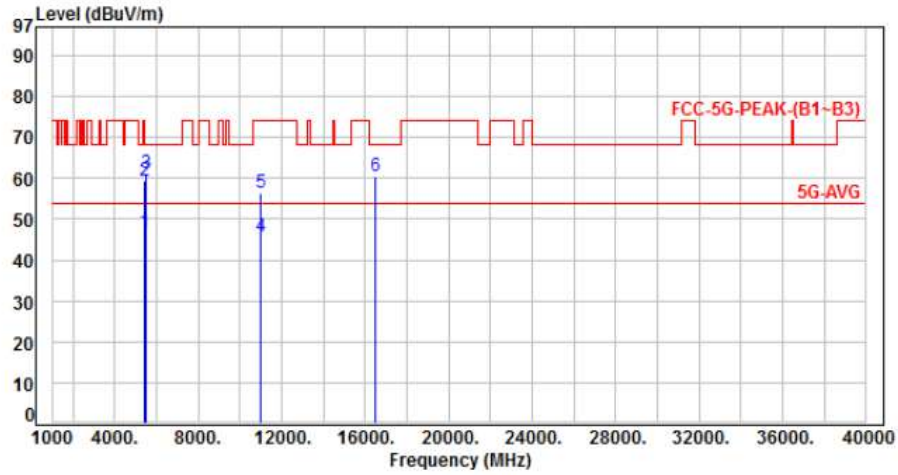

No.	Frequency (MHz)	Factor (dB)	Reading (dBuV)	Level (dBuV/m)	Limit (dBuV/m)	Margin (dB)	Detector	Height (cm)	Azimuth (deg)	P/F
1	5460.00	5.33	41.57	46.90	54.00	-7.10	Average	140	117	P
2	5460.00	5.33	54.01	59.34	74.00	-14.66	Peak	140	117	P
3	5470.00	5.31	55.75	61.06	68.20	-7.14	Peak	140	117	P
4	11000.00	12.51	33.36	45.87	54.00	-8.13	Average	295	147	P
5	11000.00	12.51	43.95	56.46	74.00	-17.54	Peak	295	147	P
6	16500.00	15.08	45.51	60.59	68.20	-7.61	Peak	100	311	P

Note: Level=Reading+Factor
 Margin=Level-Limit
 Factor=Antenna Factor + cable loss - Amplifier Factor



Power	: AC 120V / 60Hz	Pol/Phase	: HORIZONTAL
Test Mode	: Mode 1, Band 3, CH100		:

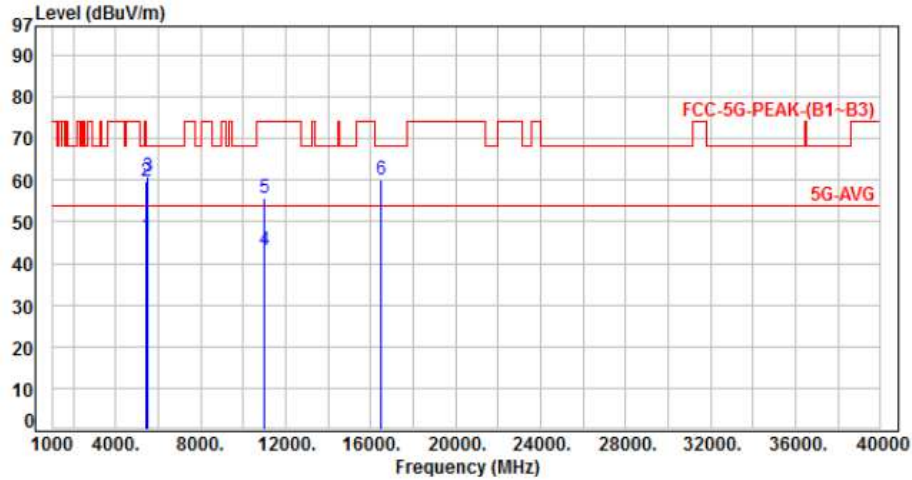

No.	Frequency (MHz)	Factor (dB)	Reading (dBuV)	Level (dBuV/m)	Limit (dBuV/m)	Margin (dB)	Detector	Height (cm)	Azimuth (deg)	P/F
1	5460.00	5.33	41.04	46.37	54.00	-7.63	Average	100	87	P
2	5460.00	5.33	54.29	59.62	74.00	-14.38	Peak	100	87	P
3	5470.00	5.31	55.50	60.81	68.20	-7.39	Peak	100	87	P
4	11000.00	12.51	30.80	43.31	54.00	-10.69	Average	100	148	P
5	11000.00	12.51	43.16	55.67	74.00	-18.33	Peak	100	148	P
6	16500.00	15.08	45.15	60.23	68.20	-7.97	Peak	100	314	P

Note: Level=Reading+Factor
Margin=Level-Limit
Factor=Antenna Factor + cable loss - Amplifier Factor



Power	: AC 120V / 60Hz	Pol/Phase	: VERTICAL
Test Mode	: Mode 1, Band 3, CH120		:

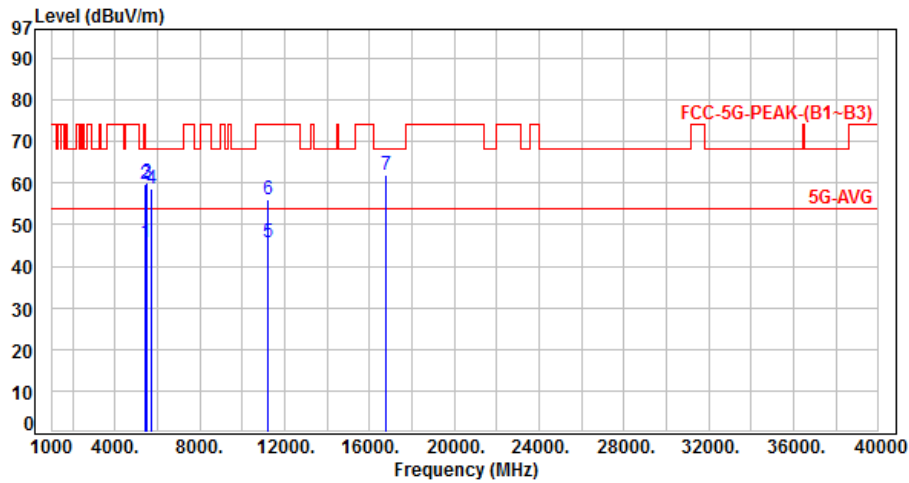

No.	Frequency (MHz)	Factor (dB)	Reading (dBuV)	Level (dBuV/m)	Limit (dBuV/m)	Margin (dB)	Detector	Height (cm)	Azimuth (deg)	P/F
1	5460.00	5.33	40.39	45.72	54.00	-8.28	Average	170	112	P
2	5460.00	5.33	54.39	59.72	74.00	-14.28	Peak	170	112	P
3	5470.00	5.31	54.95	60.26	68.20	-7.94	Peak	170	112	P
4	5725.00	5.19	53.33	58.52	68.20	-9.68	Peak	170	112	P
5	11200.00	12.72	33.19	45.91	54.00	-8.09	Average	351	148	P
6	11200.00	12.72	43.39	56.11	74.00	-17.89	Peak	351	148	P
7	16800.00	16.99	44.92	61.91	68.20	-6.29	Peak	100	320	P

Note: Level=Reading+Factor
 Margin=Level-Limit
 Factor=Antenna Factor + cable loss - Amplifier Factor



Power	: AC 120V / 60Hz	Pol/Phase	: HORIZONTAL
Test Mode	: Mode 1, Band 3, CH120		:

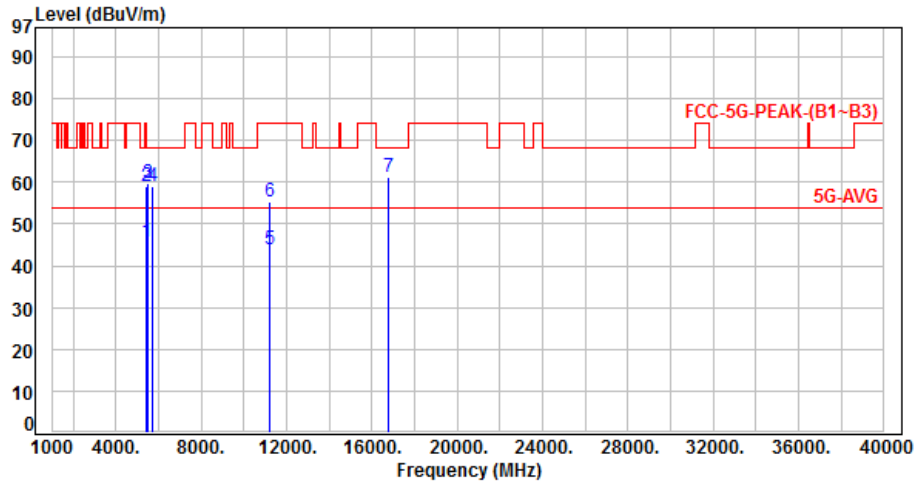

No.	Frequency (MHz)	Factor (dB)	Reading (dBuV)	Level (dBuV/m)	Limit (dBuV/m)	Margin (dB)	Detector	Height (cm)	Azimuth (deg)	P/F
1	5460.00	5.33	40.31	45.64	54.00	-8.36	Average	100	82	P
2	5460.00	5.33	53.75	59.08	74.00	-14.92	Peak	100	82	P
3	5470.00	5.31	54.26	59.57	68.20	-8.63	Peak	100	82	P
4	5725.00	5.19	53.81	59.00	68.20	-9.20	Peak	100	82	P
5	11200.00	12.72	31.05	43.77	54.00	-10.23	Average	100	128	P
6	11200.00	12.72	42.59	55.31	74.00	-18.69	Peak	100	128	P
7	16800.00	16.99	44.32	61.31	68.20	-6.89	Peak	100	302	P

Note: Level=Reading+Factor
 Margin=Level-Limit
 Factor=Antenna Factor + cable loss - Amplifier Factor



Power	: AC 120V / 60Hz	Pol/Phase	: VERTICAL
Test Mode	: Mode 1, Band 3, CH140		:

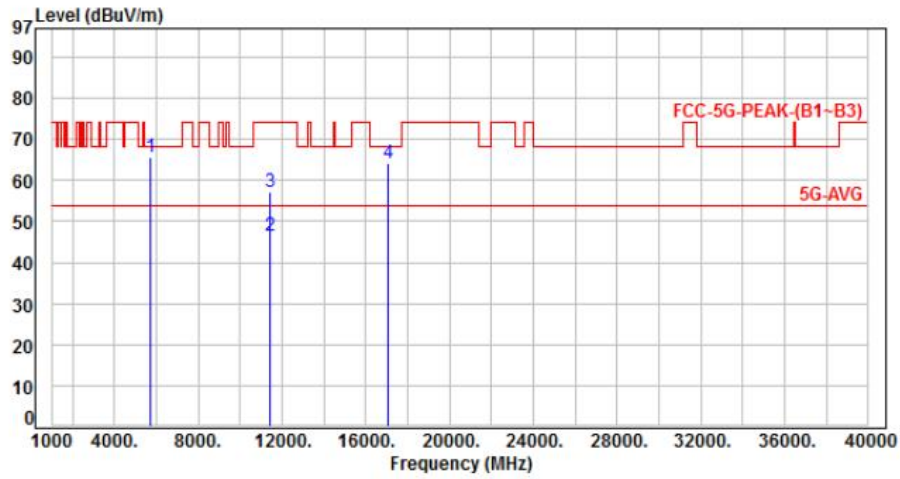

No.	Frequency (MHz)	Factor (dB)	Reading (dBuV)	Level (dBuV/m)	Limit (dBuV/m)	Margin (dB)	Detector	Height (cm)	Azimuth (deg)	P/F
1	5725.00	5.19	60.46	65.65	68.20	-2.55	Peak	189	114	P
2	11400.00	13.02	33.42	46.44	54.00	-7.56	Average	302	148	P
3	11400.00	13.02	44.11	57.13	74.00	-16.87	Peak	302	148	P
4	17100.00	18.43	45.66	64.09	68.20	-4.11	Peak	100	314	P

Note: Level=Reading+Factor
Margin=Level-Limit
Factor=Antenna Factor + cable loss - Amplifier Factor



Power	: AC 120V / 60Hz	Pol/Phase	: HORIZONTAL
Test Mode	: Mode 1, Band 3, CH140		:

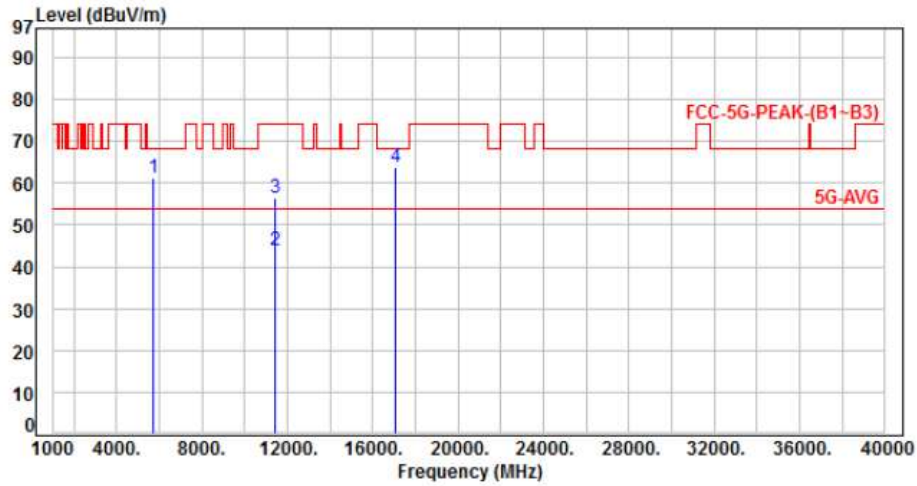

No.	Frequency (MHz)	Factor (dB)	Reading (dBuV)	Level (dBuV/m)	Limit (dBuV/m)	Margin (dB)	Detector	Height (cm)	Azimuth (deg)	P/F
1	5725.00	5.19	56.04	61.23	68.20	-6.97	Peak	120	94	P
2	11400.00	13.02	30.72	43.74	54.00	-10.26	Average	100	152	P
3	11400.00	13.02	43.26	56.28	74.00	-17.72	Peak	100	152	P
4	17100.00	18.43	45.36	63.79	68.20	-4.41	Peak	100	324	P

Note: Level=Reading+Factor
 Margin=Level-Limit
 Factor=Antenna Factor + cable loss - Amplifier Factor



Power	: AC 120V / 60Hz	Pol/Phase	: VERTICAL
Test Mode	: Mode 2, Band 3, CH100		:

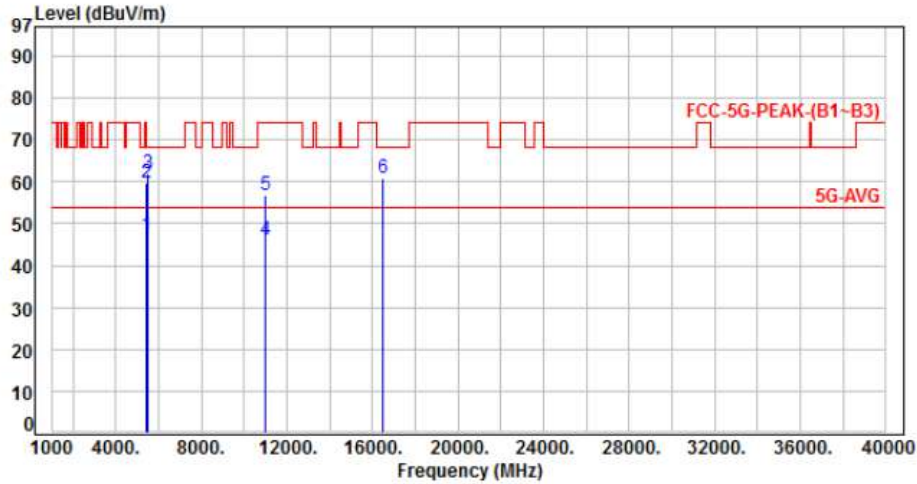

No.	Frequency (MHz)	Factor (dB)	Reading (dBuV)	Level (dBuV/m)	Limit (dBuV/m)	Margin (dB)	Detector	Height (cm)	Azimuth (deg)	P/F
1	5460.00	5.33	41.94	47.27	54.00	-6.73	Average	134	123	P
2	5460.00	5.33	54.41	59.74	74.00	-14.26	Peak	134	123	P
3	5470.00	5.31	56.60	61.91	68.20	-6.29	Peak	134	123	P
4	11000.00	12.51	33.49	46.00	54.00	-8.00	Average	293	149	P
5	11000.00	12.51	44.46	56.97	74.00	-17.03	Peak	293	149	P
6	16500.00	15.08	45.95	61.03	68.20	-7.17	Peak	100	308	P

Note: Level=Reading+Factor
 Margin=Level-Limit
 Factor=Antenna Factor + cable loss - Amplifier Factor



Power	: AC 120V / 60Hz	Pol/Phase	: HORIZONTAL
Test Mode	: Mode 2, Band 3, CH100		:

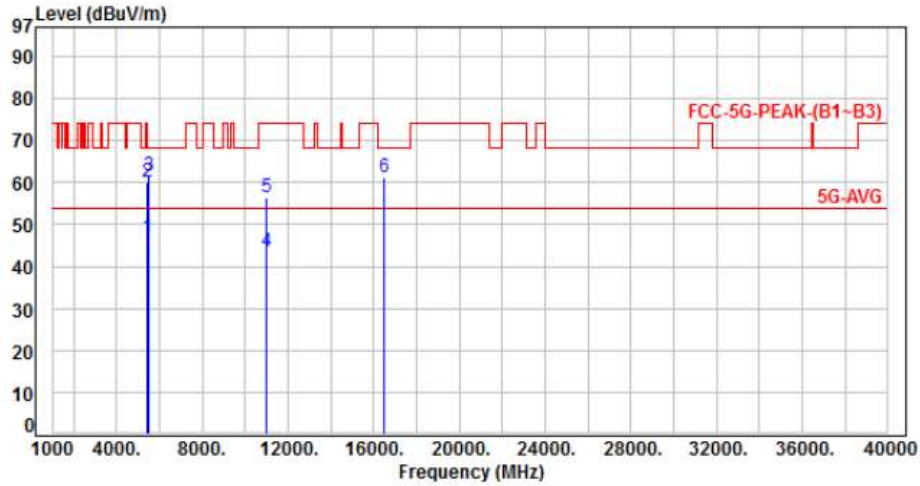

No.	Frequency (MHz)	Factor (dB)	Reading (dBuV)	Level (dBuV/m)	Limit (dBuV/m)	Margin (dB)	Detector	Height (cm)	Azimuth (deg)	P/F
1	5460.00	5.33	41.38	46.71	54.00	-7.29	Average	100	85	P
2	5460.00	5.33	54.85	60.18	74.00	-13.82	Peak	100	85	P
3	5470.00	5.31	56.28	61.59	68.20	-6.61	Peak	100	85	P
4	11000.00	12.51	30.95	43.46	54.00	-10.54	Average	100	146	P
5	11000.00	12.51	43.88	56.39	74.00	-17.61	Peak	100	146	P
6	16500.00	15.08	46.08	61.16	68.20	-7.04	Peak	100	318	P

Note: Level=Reading+Factor
 Margin=Level-Limit
 Factor=Antenna Factor + cable loss - Amplifier Factor



Power	: AC 120V / 60Hz	Pol/Phase	: VERTICAL
Test Mode	: Mode 2, Band 3, CH120		

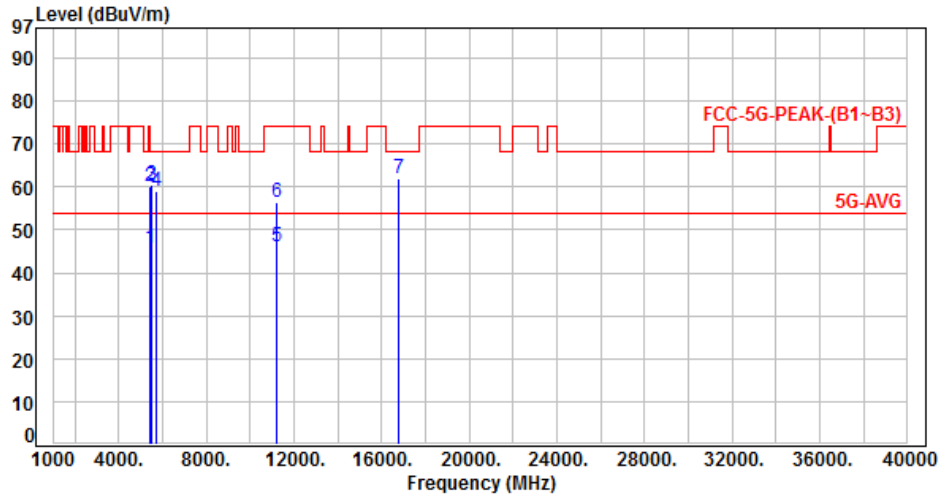

No.	Frequency (MHz)	Factor (dB)	Reading (dBuV)	Level (dBuV/m)	Limit (dBuV/m)	Margin (dB)	Detector	Height (cm)	Azimuth (deg)	P/F
1	5460.00	5.33	40.57	45.90	54.00	-8.10	Average	166	114	P
2	5460.00	5.33	54.81	60.14	74.00	-13.86	Peak	166	114	P
3	5470.00	5.31	55.28	60.59	68.20	-7.61	Peak	166	114	P
4	5725.00	5.19	53.92	59.11	68.20	-9.09	Peak	166	114	P
5	11200.00	12.72	33.35	46.07	54.00	-7.93	Average	355	145	P
6	11200.00	12.72	43.85	56.57	74.00	-17.43	Peak	355	145	P
7	16800.00	16.99	45.08	62.07	68.20	-6.13	Peak	100	331	P

Note: Level=Reading+Factor
 Margin=Level-Limit
 Factor=Antenna Factor + cable loss - Amplifier Factor



Power	: AC 120V / 60Hz	Pol/Phase	: HORIZONTAL
Test Mode	: Mode 2, Band 3, CH120		:

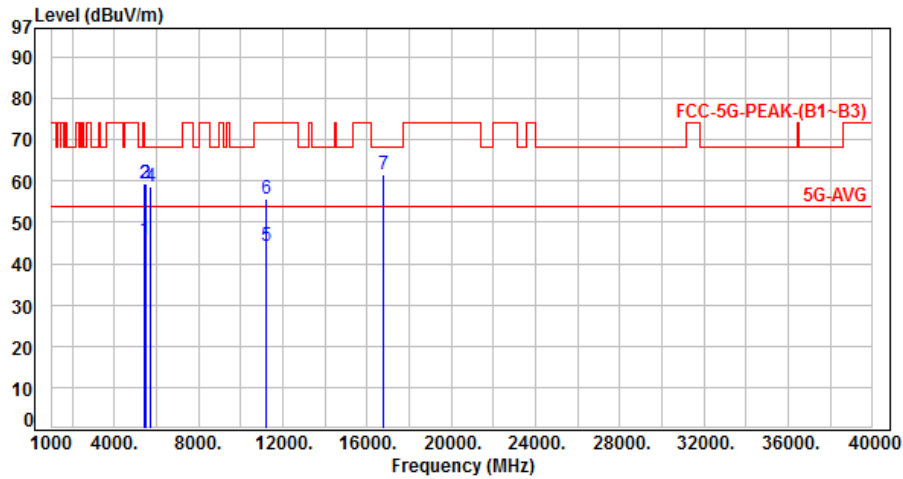

No.	Frequency (MHz)	Factor (dB)	Reading (dBuV)	Level (dBuV/m)	Limit (dBuV/m)	Margin (dB)	Detector	Height (cm)	Azimuth (deg)	P/F
1	5460.00	5.33	40.44	45.77	54.00	-8.23	Average	100	84	P
2	5460.00	5.33	53.96	59.29	74.00	-14.71	Peak	100	84	P
3	5470.00	5.31	54.16	59.47	68.20	-8.73	Peak	100	84	P
4	5725.00	5.19	53.38	58.57	68.20	-9.63	Peak	100	84	P
5	11200.00	12.72	31.38	44.10	54.00	-9.90	Average	100	131	P
6	11200.00	12.72	42.91	55.63	74.00	-18.37	Peak	100	131	P
7	16800.00	16.99	44.75	61.74	68.20	-6.46	Peak	100	311	P

Note: Level=Reading+Factor
 Margin=Level-Limit
 Factor=Antenna Factor + cable loss - Amplifier Factor



Power	: AC 120V / 60Hz	Pol/Phase	: VERTICAL
Test Mode	: Mode 2, Band 3, CH140		:

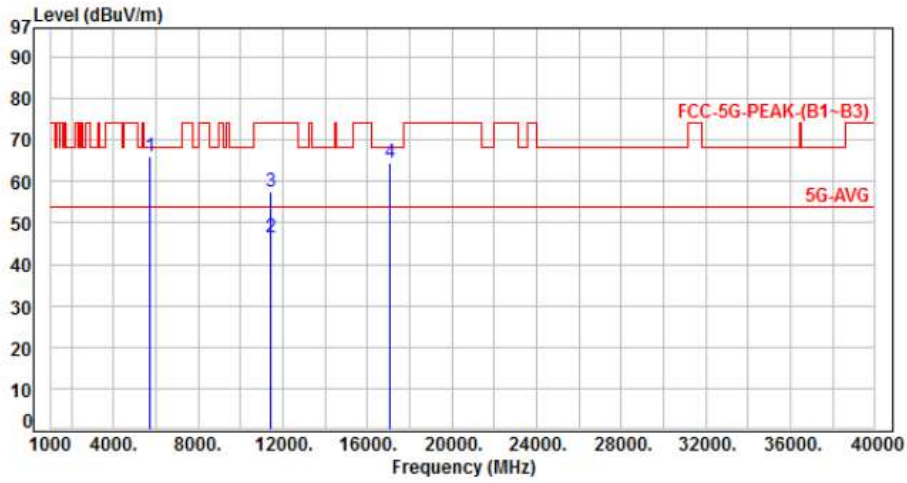

No.	Frequency (MHz)	Factor (dB)	Reading (dBuV)	Level (dBuV/m)	Limit (dBuV/m)	Margin (dB)	Detector	Height (cm)	Azimuth (deg)	P/F
1	5725.00	5.19	60.76	65.95	68.20	-2.25	Peak	186	113	P
2	11400.00	13.02	33.58	46.60	54.00	-7.40	Average	306	145	P
3	11400.00	13.02	44.62	57.64	74.00	-16.36	Peak	306	145	P
4	17100.00	18.43	45.95	64.38	68.20	-3.82	Peak	100	311	P

Note: Level=Reading+Factor
Margin=Level-Limit
Factor=Antenna Factor + cable loss - Amplifier Factor



Power	: AC 120V / 60Hz	Pol/Phase	: HORIZONTAL
Test Mode	: Mode 2, Band 3, CH140		:

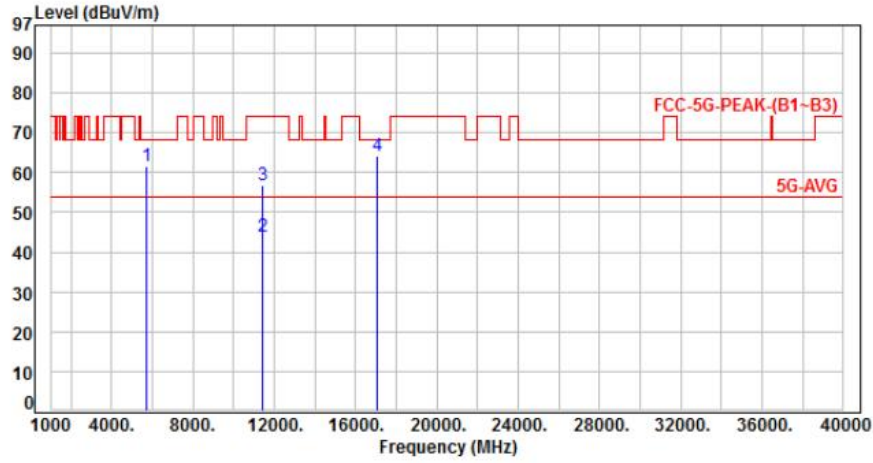

No.	Frequency (MHz)	Factor (dB)	Reading (dBUV)	Level (dBUV/m)	Limit (dBUV/m)	Margin (dB)	Detector	Height (cm)	Azimuth (deg)	P/F
1	5725.00	5.19	56.37	61.56	68.20	-6.64	Peak	116	94	P
2	11400.00	13.02	30.96	43.98	54.00	-10.02	Average	100	150	P
3	11400.00	13.02	43.92	56.94	74.00	-17.06	Peak	100	150	P
4	17100.00	18.43	45.77	64.20	68.20	-4.00	Peak	100	322	P

Note: Level=Reading+Factor
Margin=Level-Limit
Factor=Antenna Factor + cable loss - Amplifier Factor



Power	: AC 120V / 60Hz	Pol/Phase	: VERTICAL
Test Mode	: Mode 3, Band 3, CH102		:

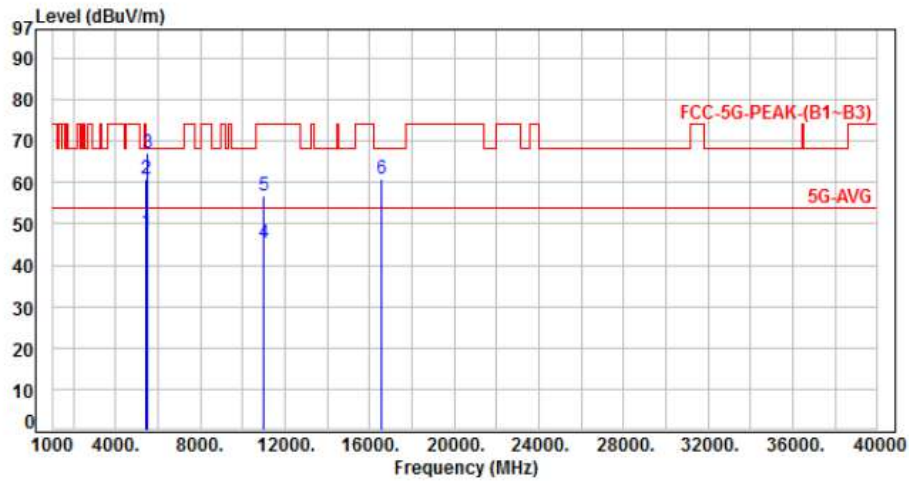

No.	Frequency (MHz)	Factor (dB)	Reading (dBuV)	Level (dBuV/m)	Limit (dBuV/m)	Margin (dB)	Detector	Height (cm)	Azimuth (deg)	P/F
1	5460.00	5.33	42.64	47.97	54.00	-6.03	Average	140	125	P
2	5460.00	5.33	55.49	60.82	74.00	-13.18	Peak	140	125	P
3	5470.00	5.31	61.89	67.20	68.20	-1.00	Peak	140	125	P
4	11020.00	12.54	32.86	45.40	54.00	-8.60	Average	272	138	P
5	11020.00	12.54	44.08	56.62	74.00	-17.38	Peak	272	138	P
6	16530.00	15.26	45.61	60.87	68.20	-7.33	Peak	100	322	P

Note: Level=Reading+Factor
 Margin=Level-Limit
 Factor=Antenna Factor + cable loss - Amplifier Factor



Power	: AC 120V / 60Hz	Pol/Phase	: HORIZONTAL
Test Mode	: Mode 3, Band 3, CH102		:

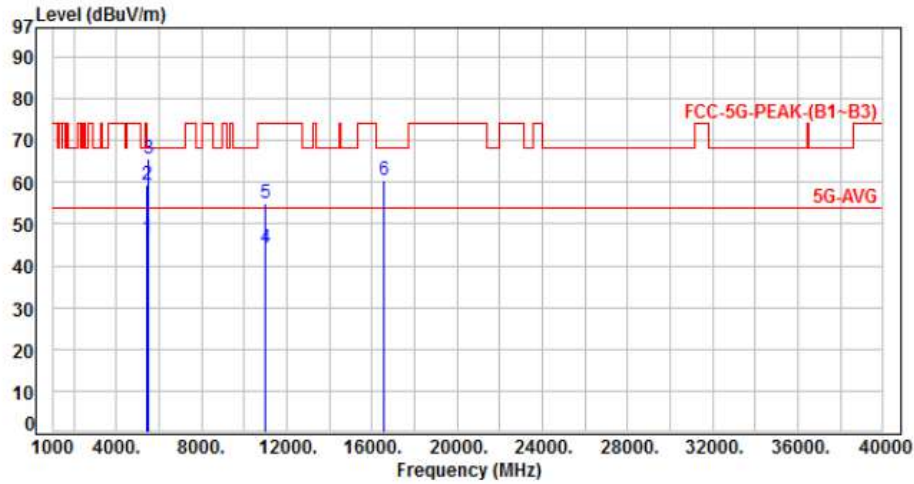

No.	Frequency (MHz)	Factor (dB)	Reading (dBuV)	Level (dBuV/m)	Limit (dBuV/m)	Margin (dB)	Detector	Height (cm)	Azimuth (deg)	P/F
1	5460.00	5.33	41.25	46.58	54.00	-7.42	Average	132	89	P
2	5460.00	5.33	54.04	59.37	74.00	-14.63	Peak	132	89	P
3	5470.00	5.31	60.21	65.52	68.20	-2.68	Peak	132	89	P
4	11020.00	12.54	31.65	44.19	54.00	-9.81	Average	100	112	P
5	11020.00	12.54	42.48	55.02	74.00	-18.98	Peak	100	112	P
6	16530.00	15.26	45.34	60.60	68.20	-7.60	Peak	100	307	P

Note: Level=Reading+Factor
 Margin=Level-Limit
 Factor=Antenna Factor + cable loss - Amplifier Factor



Power	: AC 120V / 60Hz	Pol/Phase	: VERTICAL
Test Mode	: Mode 3, Band 3, CH118		:

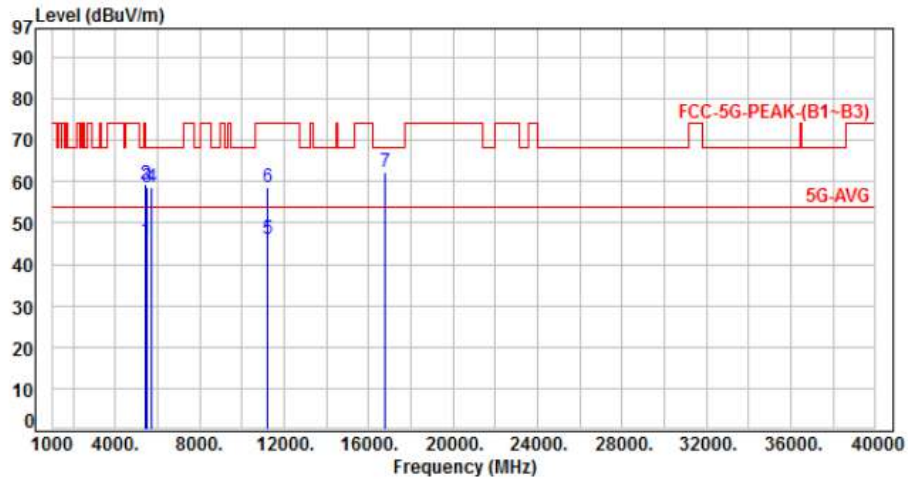

No.	Frequency (MHz)	Factor (dB)	Reading (dBuV)	Level (dBuV/m)	Limit (dBuV/m)	Margin (dB)	Detector	Height (cm)	Azimuth (deg)	P/F
1	5460.00	5.33	40.34	45.67	54.00	-8.33	Average	196	110	P
2	5460.00	5.33	54.14	59.47	74.00	-14.53	Peak	196	110	P
3	5470.00	5.31	53.40	58.71	68.20	-9.49	Peak	196	110	P
4	5725.00	5.19	53.57	58.76	68.20	-9.44	Peak	196	110	P
5	11180.00	12.71	33.54	46.25	54.00	-7.75	Average	305	151	P
6	11180.00	12.71	46.08	58.79	74.00	-15.21	Peak	305	151	P
7	16770.00	16.72	45.53	62.25	68.20	-5.95	Peak	100	314	P

Note: Level=Reading+Factor
 Margin=Level-Limit
 Factor=Antenna Factor + cable loss - Amplifier Factor



Power	: AC 120V / 60Hz	Pol/Phase	: HORIZONTAL
Test Mode	: Mode 3, Band 3, CH118		:

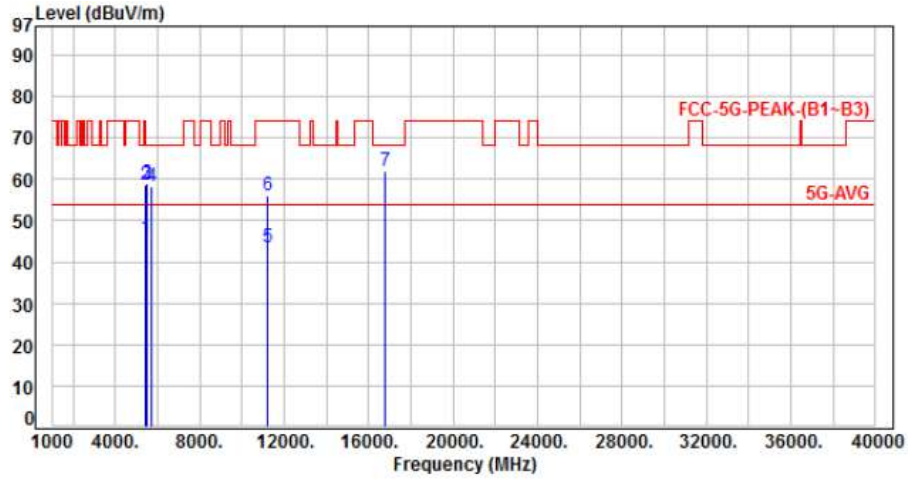

No.	Frequency (MHz)	Factor (dB)	Reading (dBuV)	Level (dBuV/m)	Limit (dBuV/m)	Margin (dB)	Detector	Height (cm)	Azimuth (deg)	P/F
1	5460.00	5.33	40.27	45.60	54.00	-8.40	Average	124	88	P
2	5460.00	5.33	53.21	58.54	74.00	-15.46	Peak	124	88	P
3	5470.00	5.31	53.69	59.00	68.20	-9.20	Peak	124	88	P
4	5725.00	5.19	53.17	58.36	68.20	-9.84	Peak	124	88	P
5	11180.00	12.71	30.83	43.54	54.00	-10.46	Average	100	148	P
6	11180.00	12.71	43.49	56.20	74.00	-17.80	Peak	100	148	P
7	16770.00	16.72	45.29	62.01	68.20	-6.19	Peak	100	332	P

Note: Level=Reading+Factor
 Margin=Level-Limit
 Factor=Antenna Factor + cable loss - Amplifier Factor



Power	: AC 120V / 60Hz	Pol/Phase	: VERTICAL
Test Mode	: Mode 3, Band 3, CH134		:

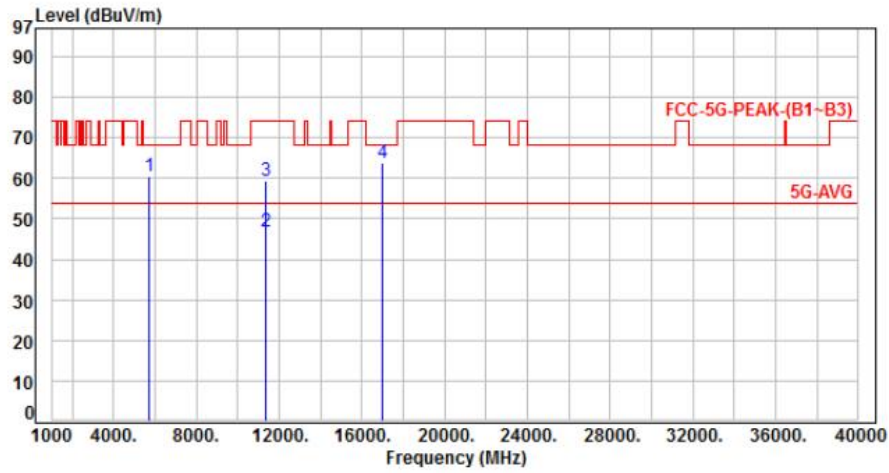

No.	Frequency (MHz)	Factor (dB)	Reading (dBuV)	Level (dBuV/m)	Limit (dBuV/m)	Margin (dB)	Detector	Height (cm)	Azimuth (deg)	P/F
1	5725.00	5.19	55.38	60.57	68.20	-7.63	Peak	164	77	P
2	11340.00	12.86	33.95	46.81	54.00	-7.19	Average	303	154	P
3	11340.00	12.86	46.53	59.39	74.00	-14.61	Peak	303	154	P
4	17010.00	18.13	45.66	63.79	68.20	-4.41	Peak	100	305	P

Note: Level=Reading+Factor
Margin=Level-Limit
Factor=Antenna Factor + cable loss - Amplifier Factor



Power	: AC 120V / 60Hz	Pol/Phase	: HORIZONTAL
Test Mode	: Mode 3, Band 3, CH134		:

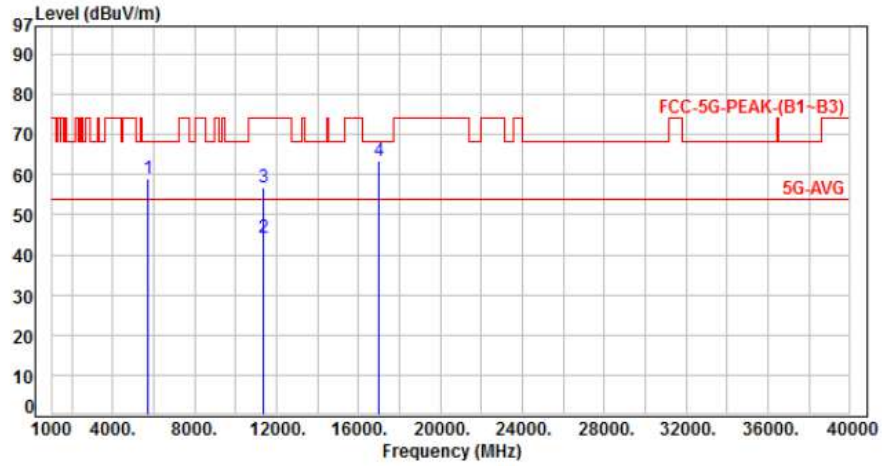

No.	Frequency (MHz)	Factor (dB)	Reading (dBuV)	Level (dBuV/m)	Limit (dBuV/m)	Margin (dB)	Detector	Height (cm)	Azimuth (deg)	P/F
1	5725.00	5.19	53.91	59.10	68.20	-9.10	Peak	120	92	P
2	11340.00	12.86	31.27	44.13	54.00	-9.87	Average	100	156	P
3	11340.00	12.86	43.89	56.75	74.00	-17.25	Peak	100	156	P
4	17010.00	18.13	45.48	63.61	68.20	-4.59	Peak	100	319	P

Note: Level=Reading+Factor
Margin=Level-Limit
Factor=Antenna Factor + cable loss - Amplifier Factor



Power	: AC 120V / 60Hz	Pol/Phase	: VERTICAL
Test Mode	: Mode 4, Band 3, CH106		:

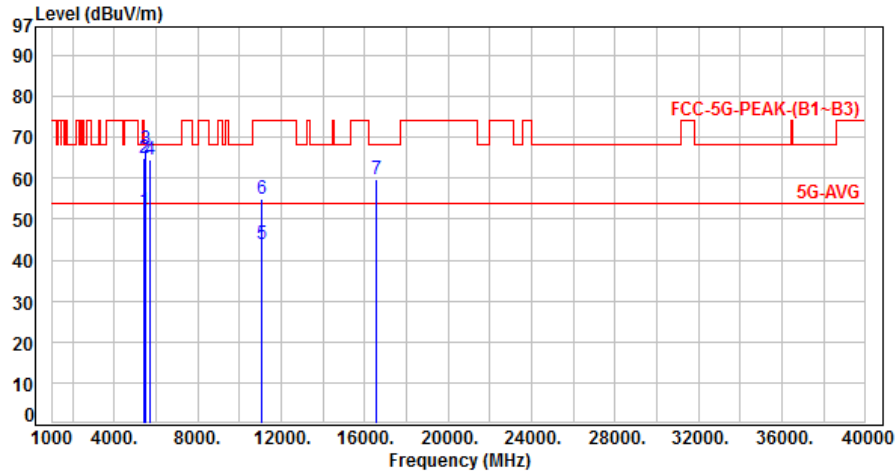

No.	Frequency (MHz)	Factor (dB)	Reading (dBuV)	Level (dBuV/m)	Limit (dBuV/m)	Margin (dB)	Detector	Height (cm)	Azimuth (deg)	P/F
1	5460.00	5.33	46.73	52.06	54.00	-1.94	Average	126	125	P
2	5460.00	5.33	59.47	64.80	74.00	-9.20	Peak	126	125	P
3	5470.00	5.31	61.86	67.17	68.20	-1.03	Peak	126	125	P
4	5725.00	5.19	59.22	64.41	68.20	-3.79	Peak	126	125	P
5	11060.00	12.60	31.26	43.86	54.00	-10.14	Average	270	140	P
6	11060.00	12.60	42.39	54.99	74.00	-19.01	Peak	270	140	P
7	16590.00	15.62	44.28	59.90	68.20	-8.30	Peak	100	318	P

Note: Level=Reading+Factor
 Margin=Level-Limit
 Factor=Antenna Factor + cable loss - Amplifier Factor