



FCC RADIO TEST REPORT

Applicant : Ubiquiti Inc.
Address : 685 Third Avenue, New York, New York 10017 USA
Equipment : UniFi Network Power Strip
Model No. : USP-Strip
Trade Name : UBIQUITI
FCC ID. : SWX-USPS

I HEREBY CERTIFY THAT :

The sample was received on Mar. 30, 2020 and the testing was completed on Jun. 24, 2020 at CerpPASS Technology Corp. The test result refers exclusively to the test presented test model / sample. Without written approval of CerpPASS Technology Corp., the test report shall not be reproduced except in full.

Approved by:

Laboratory Accreditation:

CerpPASS Technology Corporation Test Laboratory





Contents

1. Summary of Test Procedure and Test Results.....	5
1.1 Applicable Standards	5
2. Test Configuration of Equipment under Test	6
2.1 Feature of Equipment.....	6
2.2 Carrier Frequency of Channels.....	6
2.3 Test Mode and Test Software.....	7
2.4 Description of Test System.....	7
2.5 General Information of Test.....	8
2.6 Measurement Uncertainty	8
3. Test Equipment and Ancillaries Used for Tests	9
4. Antenna Requirements.....	11
4.1 Antenna Construction and Directional Gain.....	11
5. Test of AC Power Line Conducted Emission	12
5.1 Test Limit	12
5.2 Test Procedures	12
5.3 Typical Test Setup	13
5.4 Test Result and Data.....	14
5.5 Test Photographs	16
6. Test of Radiated Spurious Emission.....	17
6.1 Test Limit	17
6.2 Test Procedures	17
6.3 Typical Test Setup	18
6.4 Test Result and Data (9KHz ~ 30MHz)	19
6.5 Test Result and Data (30MHz ~ 1GHz).....	19
6.6 Test Result and Data (1GHz ~ 25GHz).....	21
6.7 Restricted Bands of Operation	39
6.8 Test Photographs (30MHz ~ 1GHz).....	40
6.9 Test Photographs (1GHz ~ 25GHz).....	41
7. Test of Conducted Spurious Emission	43
7.1 Test Limit	43
7.2 Test Procedure	43
7.3 Test Setup Layout	43
7.4 Test Result and Data.....	43
8. On Time, Duty Cycle and Measurement methods	50
8.1 Test Limit	50
8.2 Test Procedure	50
8.3 Test Setup Layout	50
8.4 Test Result and Data.....	50
9. 6dB Bandwidth Measurement Data	52
9.1 Test Limit	52
9.2 Test Procedures	52
9.3 Test Setup Layout	52



9.4 Test Result and Data 52

10. Maximum Peak and Average Output Power 55

10.1 Test Limit 55

10.2 Test Procedures 55

10.3 Test Setup Layout 55

10.4 Test Result and Data 56

11. Power Spectral Density 57

11.1 Test Limit 57

11.2 Test Procedures 57

11.3 Test Setup Layout 57

11.4 Test Result and Data 57

12. Radio Frequency Exposure 60

12.1 Applicable Standards 60

12.2 EUT Specification 60

12.3 Test Results 61

12.4 Calculation 61

12.5 Maximum Permissible Exposure 62



1. Summary of Test Procedure and Test Results

1.1 Applicable Standards

ANSI C63.10:2013

FCC Rules and Regulations Part 15 Subpart C §15.247

FCC Rule	Description of Test	Result
15.203	. Antenna Requirement	PASS
15.207	. AC Power Line Conducted Emission	PASS
15.209 15.205	. Radiated Spurious Emission	PASS
15.247(d)	. Conducted Spurious Emission	PASS
15.247(a)(2)	. 6dB Bandwidth	PASS
15.247(b)	. Maximum Peak and Average Output Power	PASS
15.247(e)	. Power Spectral Density	PASS
2.1091	. Radio Frequency Exposure	PASS

*The lab has reduced the uncertainty risk factor from test equipment, environment and staff technicians which according to the standard on contract. Therefore, the test result will only be determined by standard requirement.

*This EUT has been also tested and compiled with the requirement of FCC Part 15, Subpart B, recorded in a separate test report(TEFD2003325).



2. Test Configuration of Equipment under Test

2.1 Feature of Equipment

Frequency Range	802.11b/g/n: 2412-2462MHz
Modulation Type	802.11b: CCK, DQPSK, DBPSK 802.11g/n: BPSK, QPSK, 16QAM, 64QAM
Modulation Technology	DSSS, OFDM
Data Rate	802.11b: 1, 2, 5.5, 11Mbps 802.11g: 6, 9, 12, 18, 24, 36, 48, 54Mbps 802.11n: MCS0 – MCS7, HT20
Antenna Type	PCB Antenna
Antenna Gain	2412-2462MHz: 0dBi

Note: For more details, please refer to the User's manual of the EUT.

2.2 Carrier Frequency of Channels

802.11b, 802.11g, 802.11n HT20 (2412MHz~2462MHz)

Channel	Frequency(MHz)	Channel	Frequency(MHz)
*01	2412	07	2442
02	2417	08	2447
03	2422	09	2452
04	2427	10	2457
05	2432	*11	2462
*06	2437	---	---

Note: Channels remarked * are selected to perform test.



2.3 Test Mode and Test Software

- a. During testing, the interface cables and equipment positions were varied according to ANSI C63.10.
- b. The complete test system included Remote workstation and EUT for RF test. The Remote workstation included Notebook.
- c. An executive program, " EspRFtestTool ver.2.0" under Windows OS system was executed to transmit and receive data via WLAN.
- d. The following test modes were performed for the test:

Conducted Emissions from the AC mains power ports	
Test Mode	Operating Description
1	802.11b (1Mbps)
2	802.11g (6Mbps)
3	802.11n HT20 (6.5Mbps)
caused "Test Mode 2" generated the worst case, it was reported as the final data.	
Radiation Emissions (30MHz ~ 1GHz)	
Test Mode	Operating Description
1	802.11b (1Mbps)
2	802.11g (6Mbps)
3	802.11n HT20 (6.5Mbps)
caused "Test Mode 2" generated the worst case, it was reported as the final data.	
Radiation Emissions (1GHz ~ 25GHz)	
Test Mode	Operating Description
1	802.11b (1Mbps)
2	802.11g (6Mbps)
3	802.11n HT20 (6.5Mbps)
caused "Test Mode 1~3" generated the worst case, they were reported as the final data.	

2.4 Description of Test System

N/A



2.5 General Information of Test

Test Site	CerpPASS Technology Corporation Test Laboratory Address: No.10, Ln. 2, Lianfu St., Luzhu Dist., Taoyuan City 33848, Taiwan (R.O.C.) Tel:+886-3-3226-888 Fax:+886-3-3226-881	
	FCC	TW1079, TW1439
	IC	4934E-1, 4934E-2
	VCCI	T-2205 for Telecommunication test C-4663 for Conducted emission test R-4218 for Radiated emission test G-10812, G-10813 for radiated disturbance above 1GHz
Frequency Range Investigated:	Conducted: from 150kHz to 30 MHz Radiation: from 30 MHz to 25,000MHz	
Test Distance:	The test distance of radiated emission from antenna to EUT is 3 M.	

Test Item	Test Site	Finish Date	Environmental Conditions	Tested By
RF Conducted	RFCON01-NK	2020/06/24	24°C / 61%	Vic Yeh
Radiated Emissions	3M02-NK	2020/06/23	25°C / 42%	Vic Yeh
AC Power Line Conducted Emission	CON01-NK	2020/06/23	20°C / 49%	Leon Huang

2.6 Measurement Uncertainty

Measurement Item	Uncertainty
AC Power Line Conduction(150K~30MHz)	±1.60dB
Radiated Spurious Emission(9KHz~30MHz)	±3.404dB
Radiated Spurious Emission(30MHz~1GHz)	±5.686dB
Radiated Spurious Emission(1GHz~25GHz)	±6.597dB
Conducted Spurious Emission	±2.022dB
6dB Bandwidth	±4.482%
20dB Bandwidth	±4.40%
Occupied Bandwidth	±4.40%
Peak Output Power(Conducted Power Meter)	±1.02dB
Dwell Time	±3.49%
Power Spectral Density	±1.963dB
Duty Cycle	±3.47%



3. Test Equipment and Ancillaries Used for Tests

Test Item	Radiated Emissions				
Test Site	Semi Anechoic Room(3M02-NK)				
Instrument	Manufacturer	Model No	Serial No	Calibration Date	Valid Date
Bilog Antenna	Schwarzbeck	VULB9168	275	2019/09/24	2020/09/23
Active Loop Antenna	EMCO	6507	40855	2020/05/21	2021/05/20
Horn Antenna	EMCO	3115	31589	2020/03/26	2021/03/25
Horn Antenna	EMCO	3116	31974	2019/09/17	2020/09/16
EMI Receiver	ROHDE & SCHWARZ	ESCI	100821	2019/09/16	2020/09/15
Spectrum Analyzer	ROHDE & SCHWARZ	FSV 40-N	102151	2019/08/02	2020/08/01
Preamplifier	EM Electronics corp.	EM330	60660	2020/03/16	2021/03/15
Preamplifier	EMC INSTRUMENTS	EMC051845SE	980333	2019/09/20	2020/09/19
Preamplifier	Agilent	8449B	3008A01954	2020/03/16	2021/03/15
Preamplifier	EMC INSTRUMENTS	EMC184045	980065	2019/11/07	2020/11/06
Bluetooth Tester	ROHDE & SCHWARZ	CBT	101133	2020/04/07	2021/04/06
Cable-3in1(30M-1G)	HARBOUR INDUSTRIES	LL142	CCE1316	2019/09/20	2020/09/19
Cable-0.5m(1G-18G)	HUBER SUHNER	SUCOFLEX 100	805443/4	2020/05/27	2021/05/26
Cable-3m(1G-18G)	HUBER SUHNER	SUCOFLEX 100	805796/4	2020/05/27	2021/05/26
Cable-8m(1G-18G)	HUBER SUHNER	SUCOFLEX 100	805795/4	2020/05/27	2021/05/26
Cable-0.5m(30M-40G)	HUBER SUHNER	SUCOFLEX 102	28420/2	2020/04/01	2021/03/31
Cable-3m(30M-40G)	HUBER SUHNER	SUCOFLEX 102	MY2608/2	2020/04/01	2021/03/31
Cable-0.5m(1G-40G)	Rapidtek	40GHZ 50CM	38MS-38MS50 314	2020/04/09	2021/04/08
E3	AUDIX	v8.2014-8-6	RK-000529	NA	NA

Test Item	RF Conducted				
Test Site	RFCON01-NK				
Instrument	Manufacturer	Model No	Serial No	Calibration Date	Valid Date
Spectrum Analyzer	ROHDE & SCHWARZ	FSP 40	100219	2019/07/22	2020/07/21
Spectrum Analyzer	ROHDE & SCHWARZ	FSV 40-N	102151	2019/08/02	2020/08/01
Bluetooth Tester	ROHDE & SCHWARZ	CBT	101133	2020/04/07	2021/04/06
CAX Signal Analyzer	KEYSIGHT	N9000B	MY57100339	2019/11/25	2020/11/24
Attenuator	KEYSIGHT	8491B	MY39250703	2020/04/17	2021/04/16
TEMP & HUMIDITY CHAMBER	T-MACHINE	TMJ-9712	T-12-040111	2019/08/28	2020/08/27
Power Meter	Anritsu	ML2495A	1224005	2020/04/17	2021/04/16
Power Sensor	Anritsu	MA2411B	1207295	2020/04/17	2021/04/16



Test Item	AC Power Line Conducted Emission				
Test Site	CON01-NK				
Instrument	Manufacturer	Model No	Serial No	Calibration Date	Valid Date
EMI Receiver	ROHDE & SCHWARZ	ESCI	100821	2019/09/16	2020/09/15
Line Impedance Stabilization Network	Schwarzbeck	NSLK 8127	8127-516	2019/09/19	2020/09/18
Pulse Limiter	ROHDE & SCHWARZ	ESH3-Z2	101933	2019/09/11	2020/09/10
Cable-6m(9k~300M)	NA	EMC5D-BM-BM-6	130605	2019/09/11	2020/09/10
E3	AUDIX	v8.2014-8-6	RK-000531	NA	NA



4. Antenna Requirements

4.1 Antenna Construction and Directional Gain

Antenna Type	PCB Antenna
Antenna Gain	2412MHz-2462MHz: 0dBi



5. Test of AC Power Line Conducted Emission

5.1 Test Limit

Conducted Emissions were measured from 150 kHz to 30 MHz with a bandwidth of 9 KHz, according to the methods defined in ANSI C63.4-2014. The EUT was placed on a nonmetallic stand in a shielded room 0.8 meters above the ground plane. The interface cables and equipment positioning were varied within limits of reasonable applications to determine the position produced maximum conducted emissions.

Frequency (MHz)	Quasi Peak (dB μ V)	Average (dB μ V)
0.15 – 0.5	66-56*	56-46*
0.5 – 5.0	56	46
5.0 – 30.0	60	50

*Decreases with the logarithm of the frequency.

5.2 Test Procedures

- a. The EUT was placed 0.4 meter from the conducting wall of the shielding room was kept at least 80 centimeters from any other grounded conducting surface.
- b. Connect EUT to the power mains through a line impedance stabilization network (LISN).
- c. All the support units are connecting to the other LISN.
- d. The LISN provides 50 ohm coupling impedance for the measuring instrument.
- e. The FCC states that a 50 ohm, 50 micro-Henry LISN should be used.
- f. Both sides of AC line were checked for maximum conducted interference.
- g. The frequency range from 150 kHz to 30 MHz was searched.
- h. Set the test-receiver system to Peak Detect Function and Specified Bandwidth with Maximum Hold Mode.



5.3 Typical Test Setup

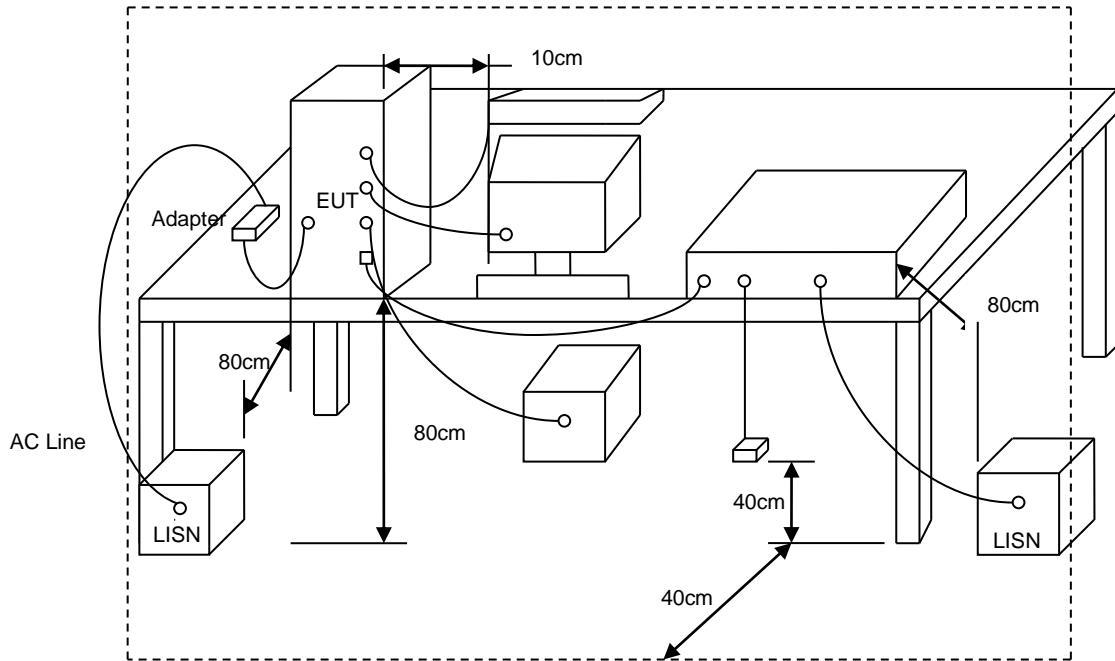



5.4 Test Result and Data

Power	: AC 120V / 60Hz	Pol/Phase	: LINE
Test Mode	: Mode 2		:

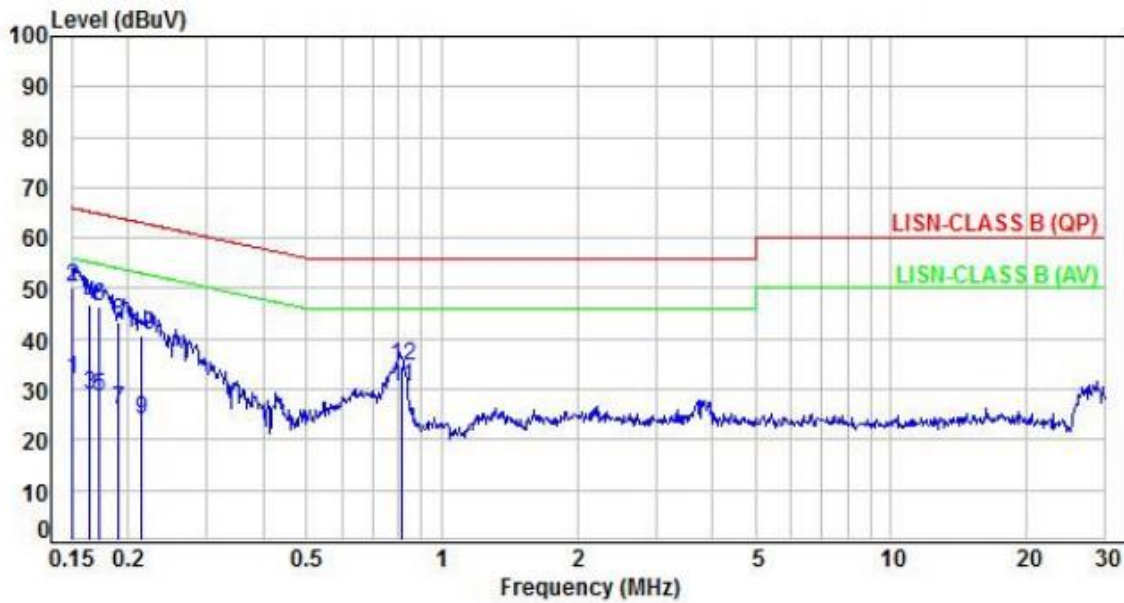

No.	Frequency (MHz)	Factor (dB)	Reading (dBuV)	Level (dBuV)	Limit (dBuV)	Margin (dB)	Detector	P/F
1	0.15	9.92	21.88	31.80	55.97	-24.17	Average	P
2	0.15	9.92	40.23	50.15	65.97	-15.82	QP	P
3	0.16	9.92	18.81	28.73	55.21	-26.48	Average	P
4	0.16	9.92	36.93	46.85	65.21	-18.36	QP	P
5	0.17	9.92	18.45	28.37	54.83	-26.46	Average	P
6	0.17	9.92	36.50	46.42	64.83	-18.41	QP	P
7	0.19	9.92	15.78	25.70	54.02	-28.32	Average	P
8	0.19	9.92	33.25	43.17	64.02	-20.85	QP	P
9	0.21	9.92	14.13	24.05	53.02	-28.97	Average	P
10	0.21	9.92	30.64	40.56	63.02	-22.46	QP	P
11	0.81	9.97	20.43	30.40	46.00	-15.60	Average	P
12	0.81	9.97	24.51	34.48	56.00	-21.52	QP	P

Note: Level=Reading+Factor
 Margin=Level-Limit
 Factor=(LISN or ISN or Current Probe)Factor + Cable Loss



Power	: AC 120V / 60Hz	Pol/Phase	: NEUTRAL
Test Mode	: Mode 2		

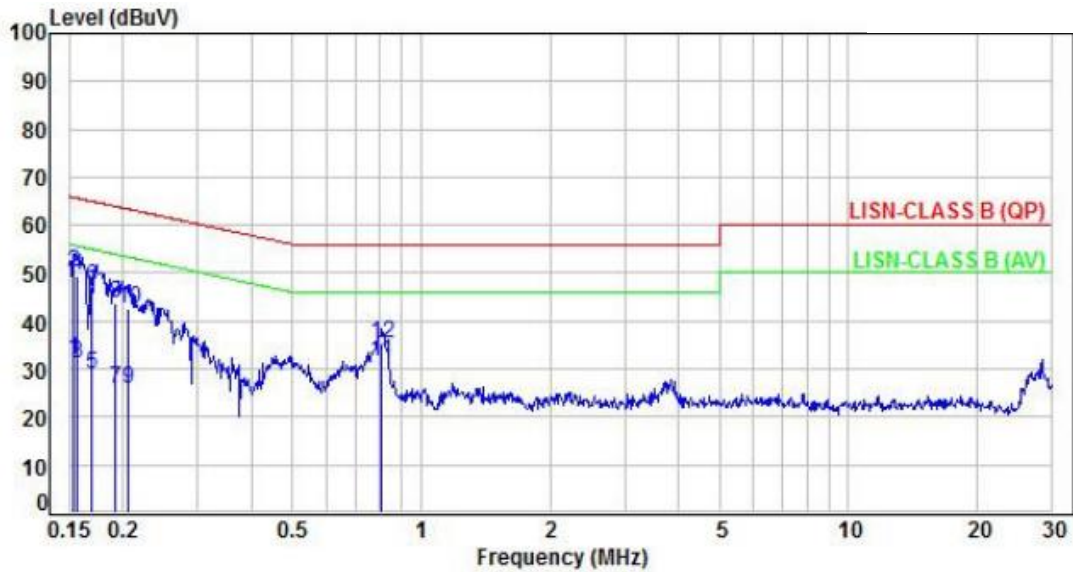

No.	Frequency (MHz)	Factor (dB)	Reading (dBuV)	Level (dBuV)	Limit (dBuV)	Margin (dB)	Detector	P/F
1	0.15	9.95	22.07	32.02	55.80	-23.78	Average	P
2	0.15	9.95	40.39	50.34	65.80	-15.46	QP	P
3	0.16	9.95	21.13	31.08	55.66	-24.58	Average	P
4	0.16	9.95	39.43	49.38	65.66	-16.28	QP	P
5	0.17	9.95	18.86	28.81	54.98	-26.17	Average	P
6	0.17	9.95	37.13	47.08	64.98	-17.90	QP	P
7	0.19	9.95	16.01	25.96	53.96	-28.00	Average	P
8	0.19	9.95	33.78	43.73	63.96	-20.23	QP	P
9	0.21	9.95	16.03	25.98	53.35	-27.37	Average	P
10	0.21	9.95	32.67	42.62	63.35	-20.73	QP	P
11	0.81	9.98	21.40	31.38	46.00	-14.62	Average	P
12	0.81	9.98	25.50	35.48	56.00	-20.52	QP	P

Note: Level=Reading+Factor
 Margin=Level-Limit
 Factor=(LISN or ISN or Current Probe)Factor + Cable Loss



6. Test of Radiated Spurious Emission

6.1 Test Limit

In any 100kHz bandwidth outside the frequency band in which the spread spectrum or digitally modulated intentional radiator is operating, the radio frequency power that is produced by the intentional radiator shall be at least 20dB below that in the 100kHz bandwidth within the band that contains the highest level of the desired power, based on either an RF conducted or a radiated measurement. If the transmitter measurement is based on the maximum conducted output power, the attenuation required under this paragraph shall be 30dB instead of 20dB. In addition, radiated emissions which fall in section 15.205(a) the restricted bands must also comply with the radiated emission limit specified in section 15.209(a).

Frequency (MHz)	Field Strength (microvolt/meter)	Measurement Distance (meters)
0.009 ~ 0.490	2400/F(kHz)	300
0.490 ~ 1.705	24000/F(kHz)	30
1.705 ~ 30.0	30	30
30 ~ 88	100	3
88 ~ 216	150	3
216 ~ 960	200	3
Above 960	500	3

6.2 Test Procedures

- The EUT was placed on a rotatable table top 0.8 meter above ground.
- The EUT was set 3 meters from the interference receiving antenna which was mounted on the top of a variable height antenna tower.
- The table was rotated 360 degrees to determine the position of the highest radiation.
- The antenna is a broadband antenna and its height is varied between one meter and four meters above ground to find the maximum value of the field strength both horizontal polarization and vertical polarization of the antenna are set to make the measurement.
- For each suspected emission the EUT was arranged to its worst case and then tune the antenna tower (from 1 M to 4 M) and turn table (from 0 degree to 360 degrees) to find the maximum reading.
- Set the test-receiver system to Peak or CISPR quasi-peak Detect Function and specified bandwidth with Maximum Hold Mode.
- If the emission level of the EUT in peak mode was 3 dB lower than the limit specified, then testing will be stopped and peak values of EUT will be reported, otherwise, the emissions which do not have 3 dB margin will be repeated one by one using the quasi-peak method and reported.
- For testing above 1GHz, the emission level of the EUT in peak mode was 20dB lower than average limit (that means the emission level in peak mode also complies with the limit in average mode), then testing will be stopped and peak values of EUT will be reported, otherwise, the emissions will be measured in average mode again and reported.
- "Cone of radiation" has been considered to be 3dB bandwidth of the measurement antenna.



6.3 Typical Test Setup

Below 30MHz test setup

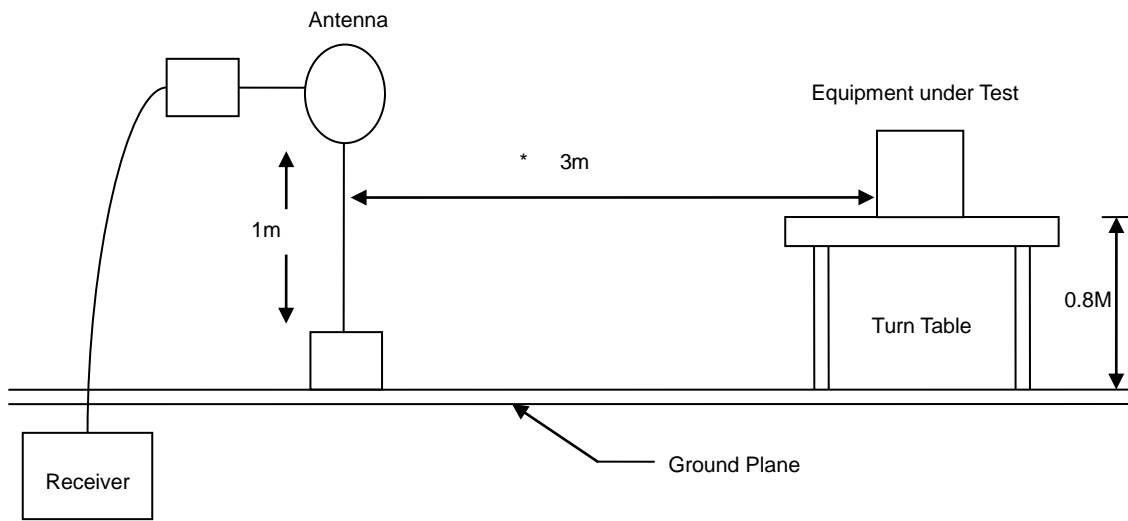

30MHz- 1GHz Test Setup

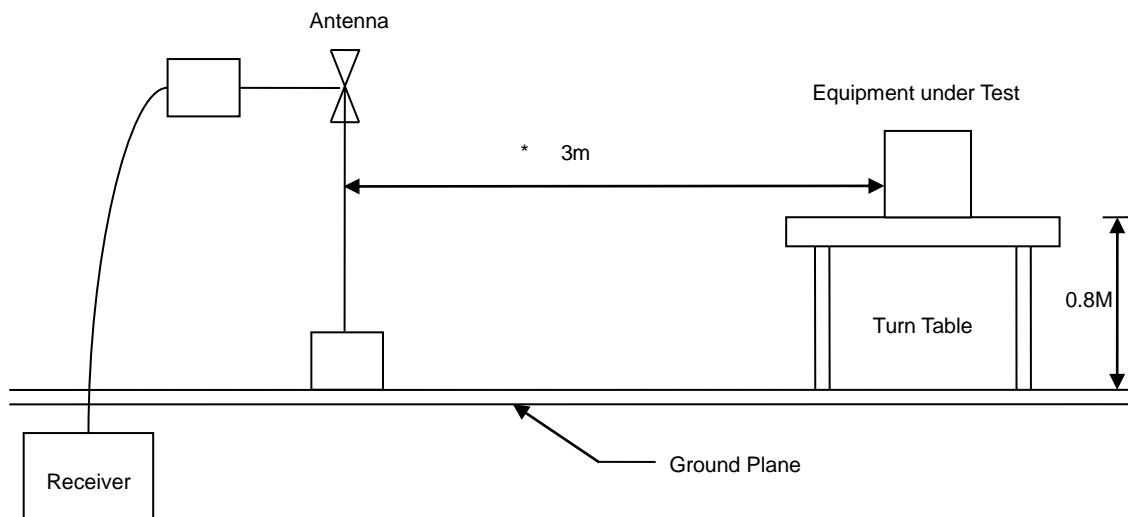

Above 1GHz Test Setup

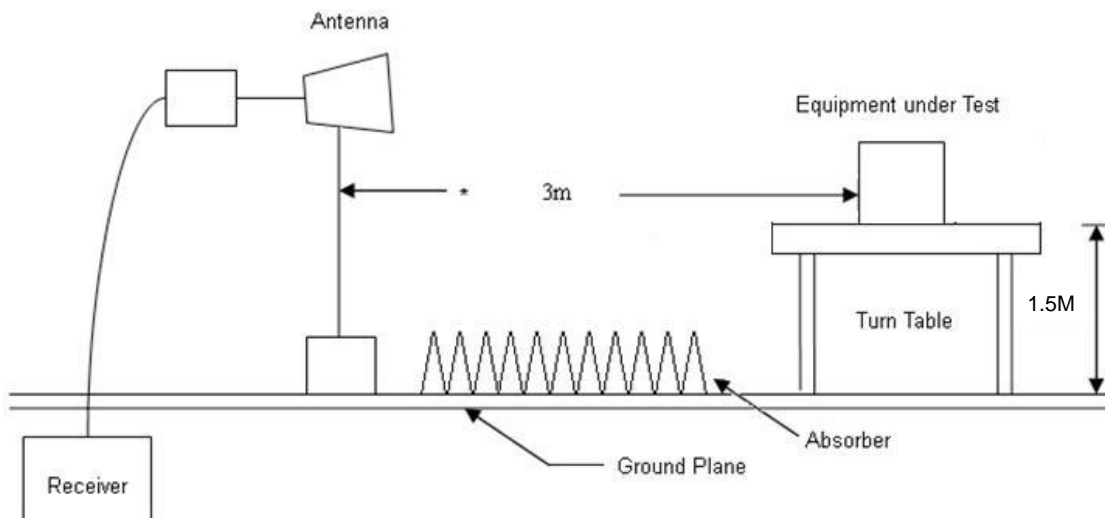



6.4 Test Result and Data (9KHz ~ 30MHz)

The 9kHz - 30MHz spurious emission is under limit 20dB more.

6.5 Test Result and Data (30MHz ~ 1GHz)

Power	: AC 120V / 60Hz	Pol/Phase	: VERTICAL
Test Mode	: Mode 2		:

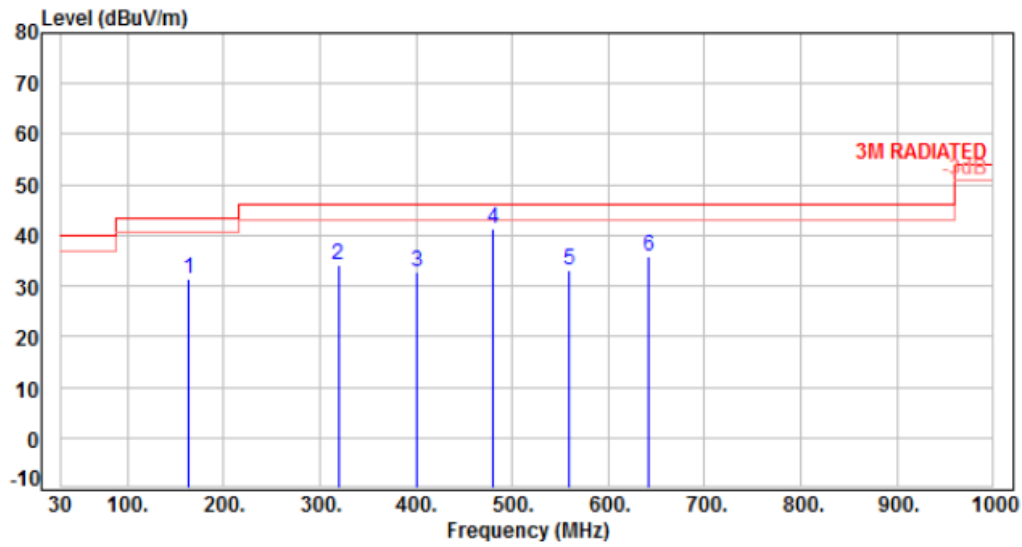

No.	Frequency (MHz)	Factor (dB)	Reading (dBuV)	Level (dBuV/m)	Limit (dBuV/m)	Margin (dB)	Detector	Height (cm)	Azimuth (deg)	P/F
1	163.86	-9.56	41.01	31.45	43.50	-12.05	Peak	100	0	P
2	319.06	-8.15	42.19	34.04	46.00	-11.96	Peak	100	0	P
3	400.54	-5.93	38.56	32.63	46.00	-13.37	Peak	100	0	P
4	480.08	-4.27	45.62	41.35	46.00	-4.65	Peak	100	0	P
5	559.62	-2.71	35.83	33.12	46.00	-12.88	Peak	100	0	P
6	641.10	-1.11	36.80	35.69	46.00	-10.31	Peak	100	0	P

Note: Level=Reading+Factor
Margin=Level-Limit
Factor=Antenna Factor + cable loss - Amplifier Factor



Power	: AC 120V / 60Hz	Pol/Phase	: HORIZONTAL
Test Mode	: Mode 2		:

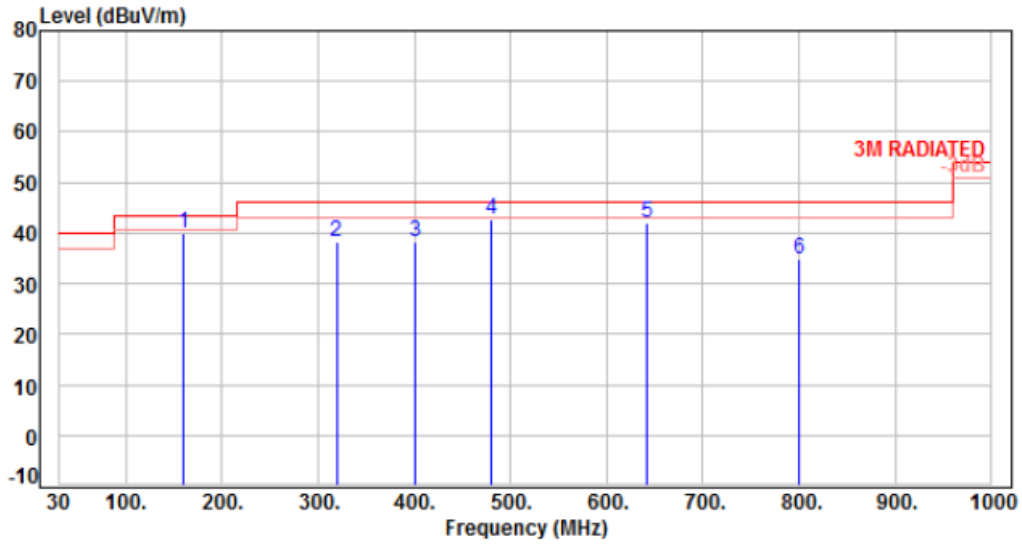

No.	Frequency (MHz)	Factor (dB)	Reading (dBuV)	Level (dBuV/m)	Limit (dBuV/m)	Margin (dB)	Detector	Height (cm)	Azimuth (deg)	P/F
1	159.98	-9.58	49.43	39.85	43.50	-3.65	Peak	100	0	P
2	319.06	-8.15	46.40	38.25	46.00	-7.75	Peak	100	0	P
3	400.54	-5.93	44.09	38.16	46.00	-7.84	Peak	100	0	P
4	480.08	-4.27	46.86	42.59	46.00	-3.41	Peak	100	0	P
5	641.10	-1.11	43.20	42.09	46.00	-3.91	Peak	100	0	P
6	800.18	1.28	33.58	34.86	46.00	-11.14	Peak	100	0	P

Note: Level=Reading+Factor
 Margin=Level-Limit
 Factor=Antenna Factor + cable loss - Amplifier Factor



6.6 Test Result and Data (1GHz ~ 25GHz)

Power	: AC 120V / 60Hz	Pol/Phase	: VERTICAL
Test Mode	: Mode 1, CH01		:

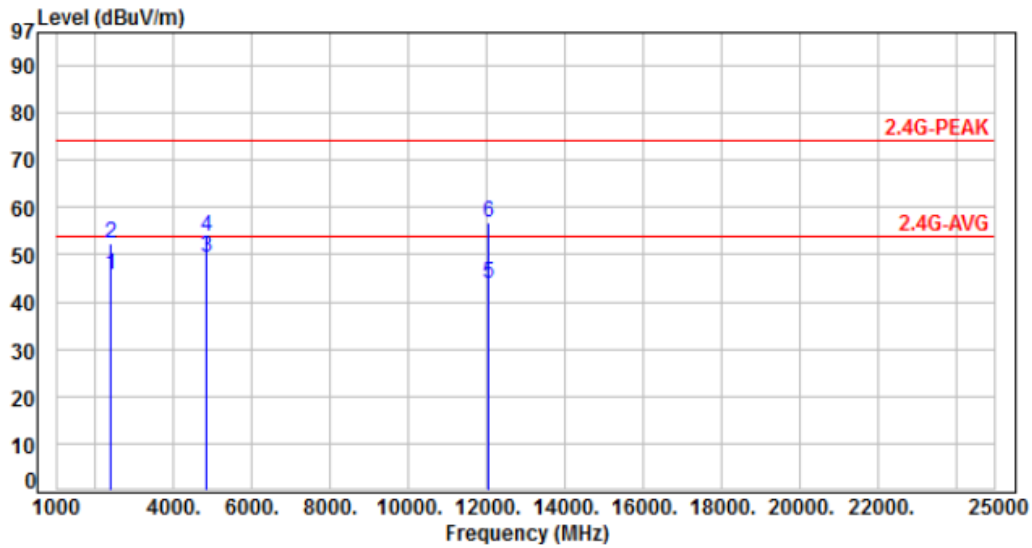

No.	Frequency (MHz)	Factor (dB)	Reading (dBuV)	Level (dBuV/m)	Limit (dBuV/m)	Margin (dB)	Detector	Height (cm)	Azimuth (deg)	P/F
1	2390.00	-2.89	48.46	45.57	54.00	-8.43	Average	100	55	P
2	2390.00	-2.89	55.34	52.45	74.00	-21.55	Peak	100	55	P
3	4824.00	4.88	44.63	49.51	54.00	-4.49	Average	100	109	P
4	4824.00	4.88	48.79	53.67	74.00	-20.33	Peak	100	109	P
5	12060.00	14.80	29.10	43.90	54.00	-10.10	Average	100	208	P
6	12060.00	14.80	41.88	56.68	74.00	-17.32	Peak	100	208	P

Note: Level=Reading+Factor
 Margin=Level-Limit
 Factor=Antenna Factor + cable loss - Amplifier Factor



Power	: AC 120V / 60Hz	Pol/Phase	: HORIZONTAL
Test Mode	: Mode 1, CH01		:

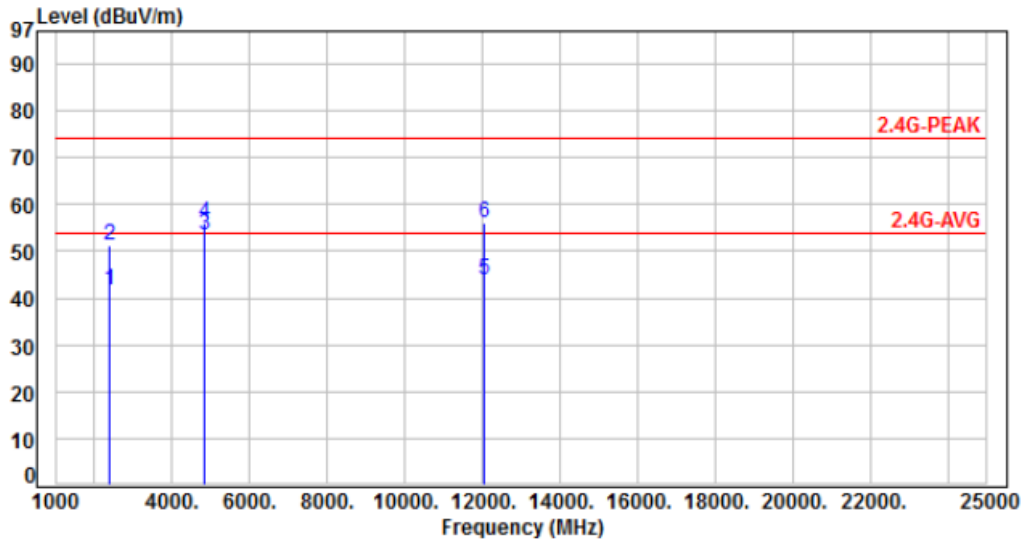

No.	Frequency (MHz)	Factor (dB)	Reading (dBuV)	Level (dBuV/m)	Limit (dBuV/m)	Margin (dB)	Detector	Height (cm)	Azimuth (deg)	P/F
1	2390.00	-2.89	44.45	41.56	54.00	-12.44	Average	100	41	P
2	2390.00	-2.89	54.29	51.40	74.00	-22.60	Peak	100	41	P
3	4824.00	4.88	48.50	53.38	54.00	-0.62	Average	100	55	P
4	4824.00	4.88	51.36	56.24	74.00	-17.76	Peak	100	55	P
5	12060.00	14.80	29.06	43.86	54.00	-10.14	Average	100	96	P
6	12060.00	14.80	41.36	56.16	74.00	-17.84	Peak	100	96	P

Note: Level=Reading+Factor
 Margin=Level-Limit
 Factor=Antenna Factor + cable loss - Amplifier Factor



Power	: AC 120V / 60Hz	Pol/Phase	: VERTICAL
Test Mode	: Mode 1, CH06		:

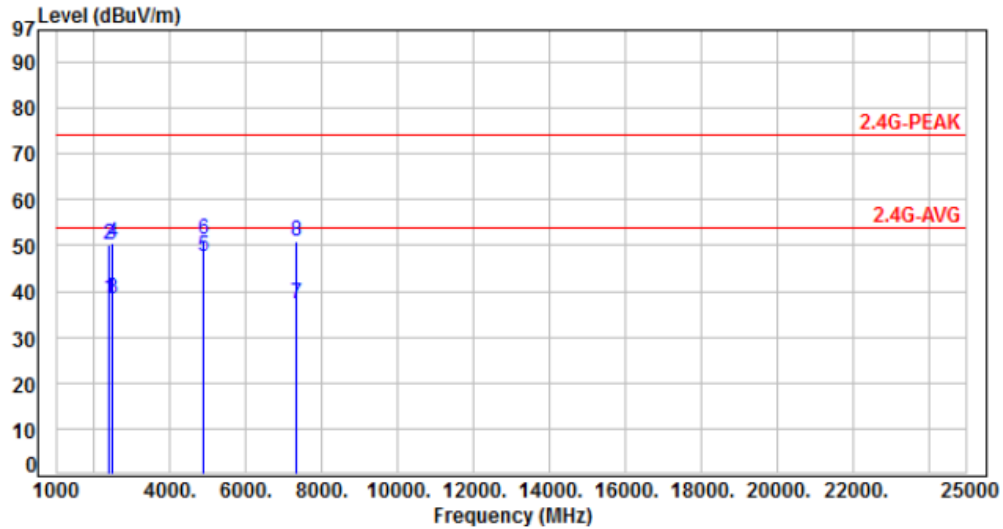

No.	Frequency (MHz)	Factor (dB)	Reading (dBuV)	Level (dBuV/m)	Limit (dBuV/m)	Margin (dB)	Detector	Height (cm)	Azimuth (deg)	P/F
1	2390.00	-2.89	41.18	38.29	54.00	-15.71	Average	100	56	P
2	2390.00	-2.89	53.04	50.15	74.00	-23.85	Peak	100	56	P
3	2483.50	-2.69	41.04	38.35	54.00	-15.65	Average	100	56	P
4	2483.50	-2.69	53.13	50.44	74.00	-23.56	Peak	100	56	P
5	4874.00	5.09	42.50	47.59	54.00	-6.41	Average	100	104	P
6	4874.00	5.09	46.24	51.33	74.00	-22.67	Peak	100	104	P
7	7311.00	10.01	27.15	37.16	54.00	-16.84	Average	100	169	P
8	7311.00	10.01	40.77	50.78	74.00	-23.22	Peak	100	169	P

Note: Level=Reading+Factor
 Margin=Level-Limit
 Factor=Antenna Factor + cable loss - Amplifier Factor



Power	: AC 120V / 60Hz	Pol/Phase	: HORIZONTAL
Test Mode	: Mode 1, CH06		:

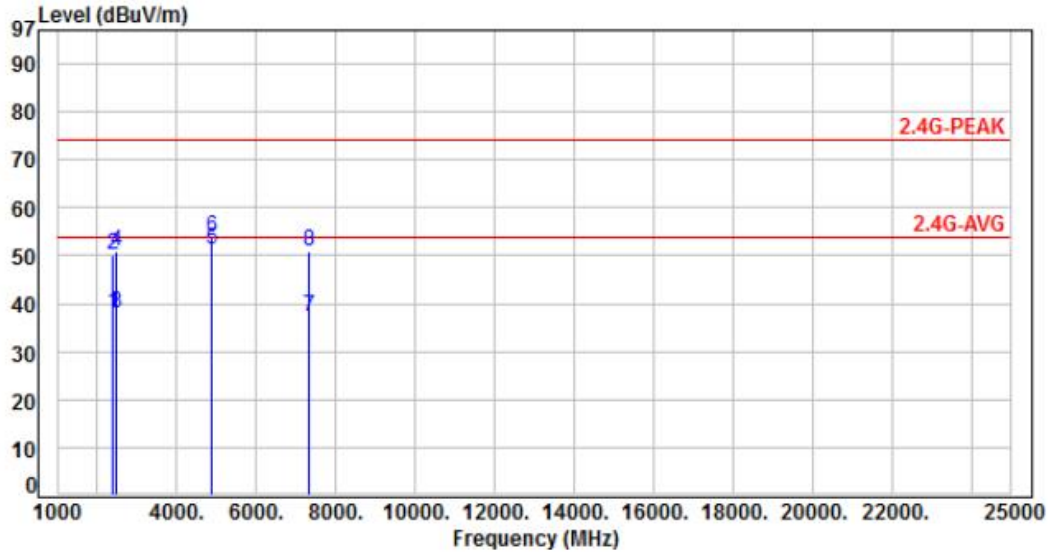

No.	Frequency (MHz)	Factor (dB)	Reading (dBuV)	Level (dBuV/m)	Limit (dBuV/m)	Margin (dB)	Detector	Height (cm)	Azimuth (deg)	P/F
1	2390.00	-2.89	40.87	37.98	54.00	-16.02	Average	100	40	P
2	2390.00	-2.89	52.96	50.07	74.00	-23.93	Peak	100	40	P
3	2483.50	-2.69	40.75	38.06	54.00	-15.94	Average	100	40	P
4	2483.50	-2.69	53.59	50.90	74.00	-23.10	Peak	100	40	P
5	4874.00	5.09	46.10	51.19	54.00	-2.81	Average	100	56	P
6	4874.00	5.09	48.88	53.97	74.00	-20.03	Peak	100	56	P
7	7311.00	10.01	27.19	37.20	54.00	-16.80	Average	100	311	P
8	7311.00	10.01	40.70	50.71	74.00	-23.29	Peak	100	311	P

Note: Level=Reading+Factor
 Margin=Level-Limit
 Factor=Antenna Factor + cable loss - Amplifier Factor



Power	: AC 120V / 60Hz	Pol/Phase	: VERTICAL
Test Mode	: Mode 1, CH11		:

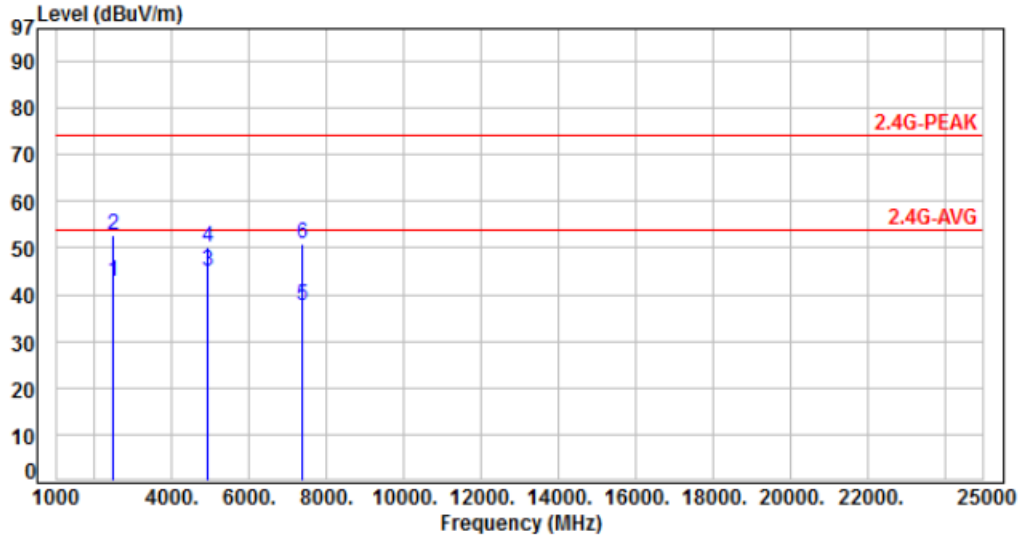

No.	Frequency (MHz)	Factor (dB)	Reading (dBuV)	Level (dBuV/m)	Limit (dBuV/m)	Margin (dB)	Detector	Height (cm)	Azimuth (deg)	P/F
1	2483.50	-2.69	45.38	42.69	54.00	-11.31	Average	100	43	P
2	2483.50	-2.69	55.47	52.78	74.00	-21.22	Peak	100	43	P
3	4924.00	5.30	39.59	44.89	54.00	-9.11	Average	100	68	P
4	4924.00	5.30	44.97	50.27	74.00	-23.73	Peak	100	68	P
5	7386.00	10.14	27.55	37.69	54.00	-16.31	Average	100	165	P
6	7386.00	10.14	40.59	50.73	74.00	-23.27	Peak	100	165	P

Note: Level=Reading+Factor
 Margin=Level-Limit
 Factor=Antenna Factor + cable loss - Amplifier Factor



Power	: AC 120V / 60HZ	Pol/Phase	: HORIZONTAL
Test Mode	: Mode 1, CH11		:

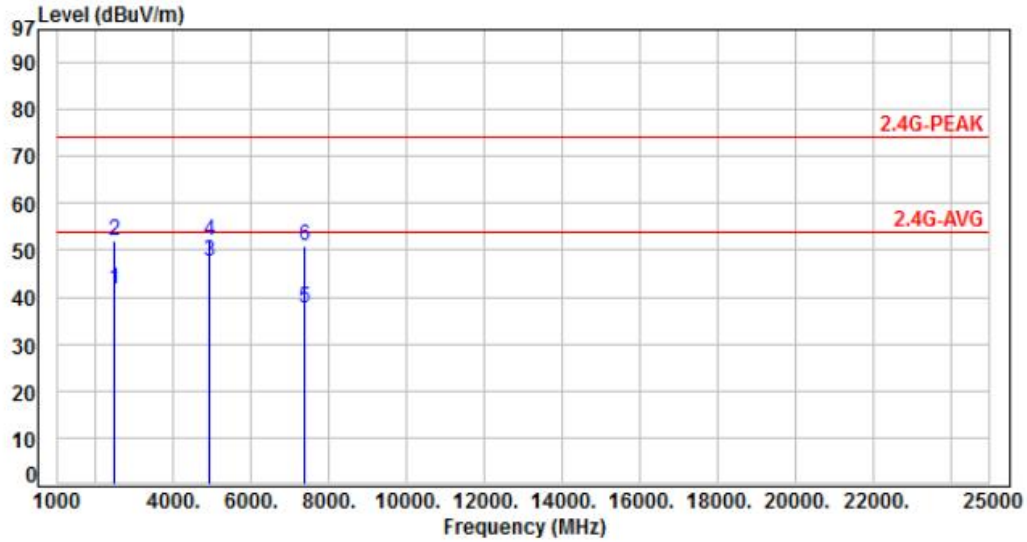

No.	Frequency (MHz)	Factor (dB)	Reading (dBuV)	Level (dBuV/m)	Limit (dBuV/m)	Margin (dB)	Detector	Height (cm)	Azimuth (deg)	P/F
1	2483.50	-2.69	44.20	41.51	54.00	-12.49	Average	100	54	P
2	2483.50	-2.69	54.64	51.95	74.00	-22.05	Peak	100	54	P
3	4924.00	5.30	42.29	47.59	54.00	-6.41	Average	100	55	P
4	4924.00	5.30	46.81	52.11	74.00	-21.89	Peak	100	55	P
5	7386.00	10.14	27.60	37.74	54.00	-16.26	Average	100	174	P
6	7386.00	10.14	40.89	51.03	74.00	-22.97	Peak	100	174	P

Note: Level=Reading+Factor
 Margin=Level-Limit
 Factor=Antenna Factor + cable loss - Amplifier Factor



Power	: AC 120V / 60HZ	Pol/Phase	: VERTICAL
Test Mode	: Mode 2, CH01		:

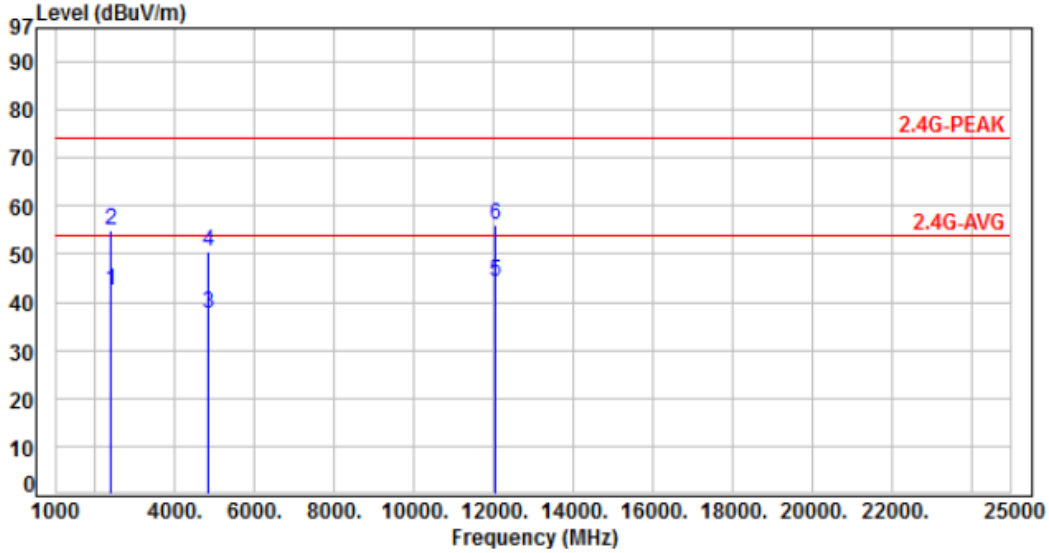

No.	Frequency (MHz)	Factor (dB)	Reading (dBuV)	Level (dBuV/m)	Limit (dBuV/m)	Margin (dB)	Detector	Height (cm)	Azimuth (deg)	P/F
1	2390.00	-2.89	45.35	42.46	54.00	-11.54	Average	100	43	P
2	2390.00	-2.89	57.75	54.86	74.00	-19.14	Peak	100	43	P
3	4824.00	4.88	32.85	37.73	54.00	-16.27	Average	100	66	P
4	4824.00	4.88	45.48	50.36	74.00	-23.64	Peak	100	66	P
5	12060.00	14.80	29.40	44.20	54.00	-9.80	Average	100	217	P
6	12060.00	14.80	41.40	56.20	74.00	-17.80	Peak	100	217	P

Note: Level=Reading+Factor
 Margin=Level-Limit
 Factor=Antenna Factor + cable loss - Amplifier Factor



Power	: AC 120V / 60HZ	Pol/Phase	: HORIZONTAL
Test Mode	: Mode 2, CH01		:

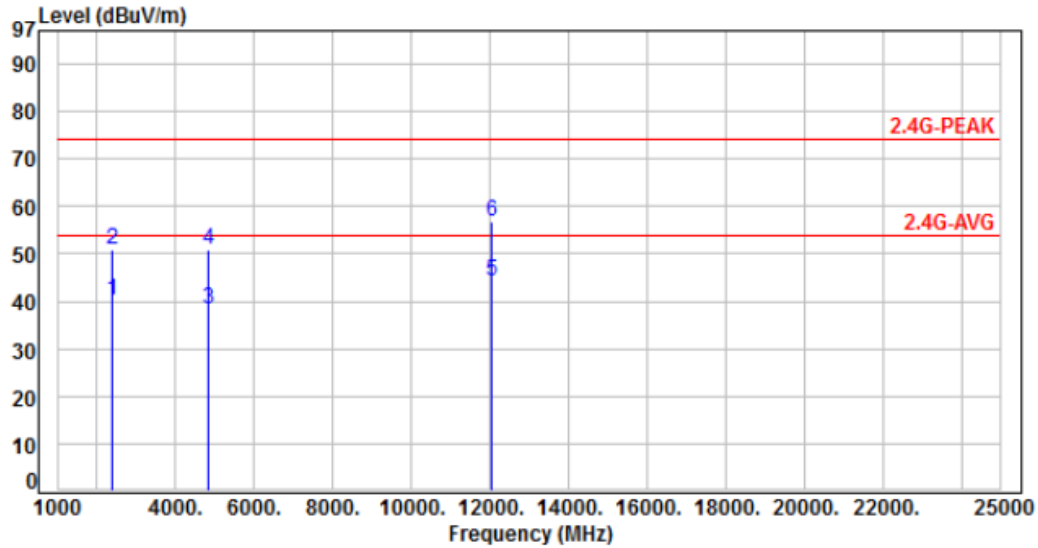

No.	Frequency (MHz)	Factor (dB)	Reading (dBuV)	Level (dBuV/m)	Limit (dBuV/m)	Margin (dB)	Detector	Height (cm)	Azimuth (deg)	P/F
1	2390.00	-2.89	42.96	40.07	54.00	-13.93	Average	100	55	P
2	2390.00	-2.89	53.96	51.07	74.00	-22.93	Peak	100	55	P
3	4824.00	4.88	33.57	38.45	54.00	-15.55	Average	100	216	P
4	4824.00	4.88	46.20	51.08	74.00	-22.92	Peak	100	216	P
5	12060.00	14.80	29.64	44.44	54.00	-9.56	Average	100	106	P
6	12060.00	14.80	41.89	56.69	74.00	-17.31	Peak	100	106	P

Note: Level=Reading+Factor
Margin=Level-Limit
Factor=Antenna Factor + cable loss - Amplifier Factor



Power	: AC 120V / 60HZ	Pol/Phase	: VERTICAL
Test Mode	: Mode 2, CH06		:

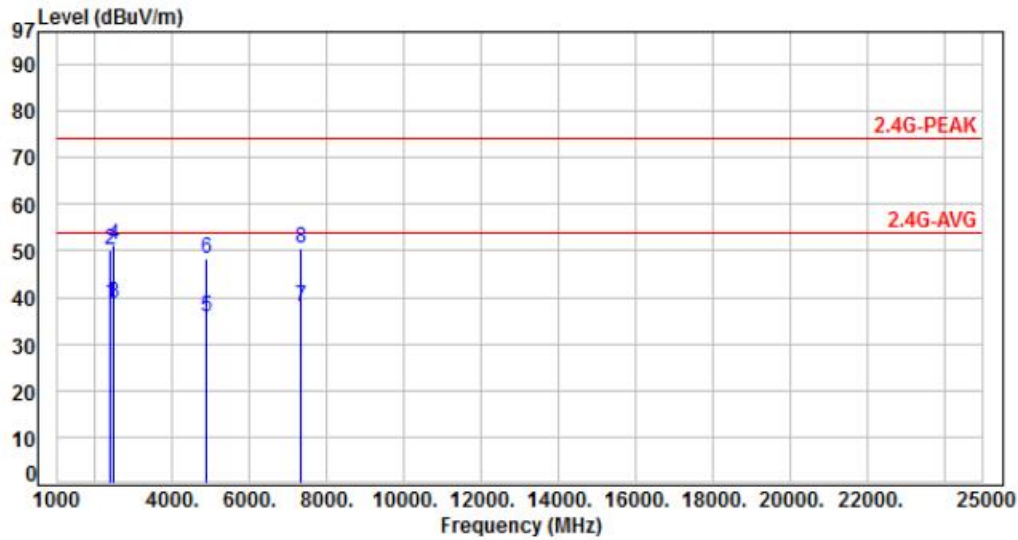

No.	Frequency (MHz)	Factor (dB)	Reading (dBUV)	Level (dBUV/m)	Limit (dBUV/m)	Margin (dB)	Detector	Height (cm)	Azimuth (deg)	P/F
1	2390.00	-2.89	41.58	38.69	54.00	-15.31	Average	100	55	P
2	2390.00	-2.89	52.91	50.02	74.00	-23.98	Peak	100	55	P
3	2483.50	-2.69	41.47	38.78	54.00	-15.22	Average	100	55	P
4	2483.50	-2.69	53.82	51.13	74.00	-22.87	Peak	100	55	P
5	4874.00	5.09	30.80	35.89	54.00	-18.11	Average	100	66	P
6	4874.00	5.09	43.23	48.32	74.00	-25.68	Peak	100	66	P
7	7311.00	10.01	28.14	38.15	54.00	-15.85	Average	100	171	P
8	7311.00	10.01	40.56	50.57	74.00	-23.43	Peak	100	171	P

Note: Level=Reading+Factor
 Margin=Level-Limit
 Factor=Antenna Factor + cable loss - Amplifier Factor



Power	: AC 120V / 60HZ	Pol/Phase	: HORIZONTAL
Test Mode	: Mode 2, CH06		:

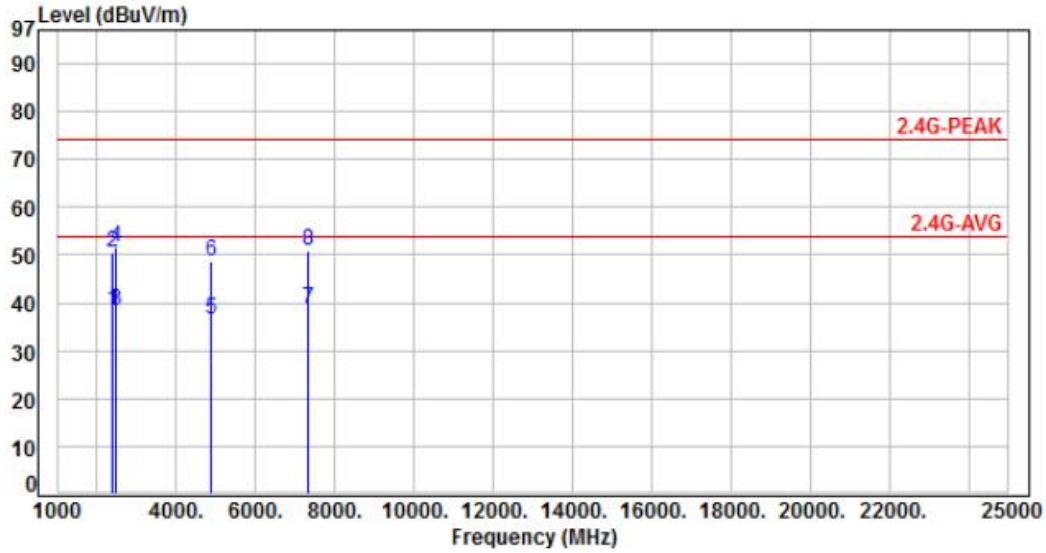

No.	Frequency (MHz)	Factor (dB)	Reading (dBuV)	Level (dBuV/m)	Limit (dBuV/m)	Margin (dB)	Detector	Height (cm)	Azimuth (deg)	P/F
1	2390.00	-2.89	41.38	38.49	54.00	-15.51	Average	100	58	P
2	2390.00	-2.89	53.24	50.35	74.00	-23.65	Peak	100	58	P
3	2483.50	-2.69	41.21	38.52	54.00	-15.48	Average	100	58	P
4	2483.50	-2.69	54.31	51.62	74.00	-22.38	Peak	100	58	P
5	4874.00	5.09	31.41	36.50	54.00	-17.50	Average	100	61	P
6	4874.00	5.09	43.76	48.85	74.00	-25.15	Peak	100	61	P
7	7311.00	10.01	28.54	38.55	54.00	-15.45	Average	100	296	P
8	7311.00	10.01	40.74	50.75	74.00	-23.25	Peak	100	296	P

Note: Level=Reading+Factor
 Margin=Level-Limit
 Factor=Antenna Factor + cable loss - Amplifier Factor



Power	: AC 120V / 60HZ	Pol/Phase	: VERTICAL
Test Mode	: Mode 2, CH11		:

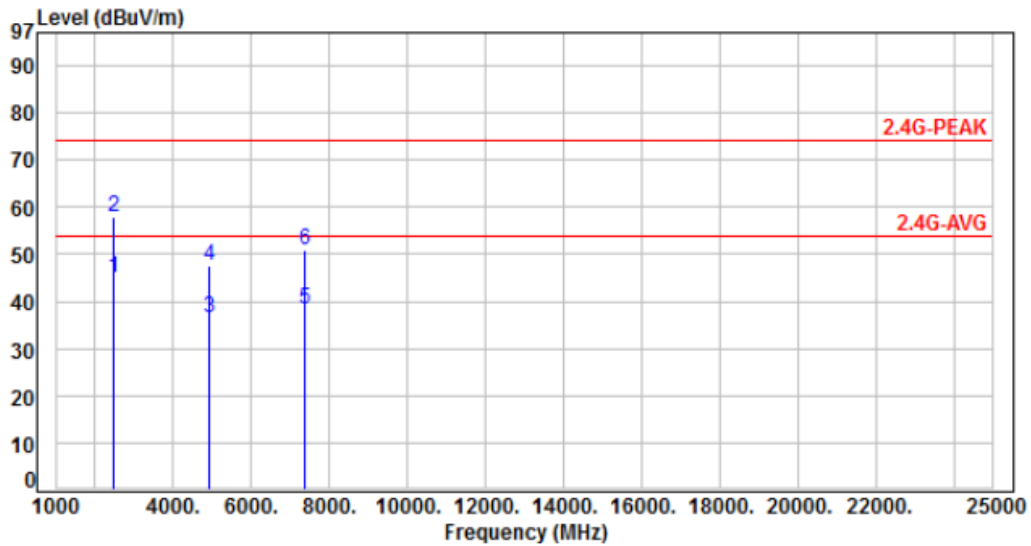

No.	Frequency (MHz)	Factor (dB)	Reading (dBuV)	Level (dBuV/m)	Limit (dBuV/m)	Margin (dB)	Detector	Height (cm)	Azimuth (deg)	P/F
1	2483.50	-2.69	47.54	44.85	54.00	-9.15	Average	100	58	P
2	2483.50	-2.69	60.76	58.07	74.00	-15.93	Peak	100	58	P
3	4924.00	5.30	31.19	36.49	54.00	-17.51	Average	100	66	P
4	4924.00	5.30	42.34	47.64	74.00	-26.36	Peak	100	66	P
5	7386.00	10.14	28.27	38.41	54.00	-15.59	Average	100	174	P
6	7386.00	10.14	40.67	50.81	74.00	-23.19	Peak	100	174	P

Note: Level=Reading+Factor
 Margin=Level-Limit
 Factor=Antenna Factor + cable loss - Amplifier Factor



Power	: AC 120V / 60HZ	Pol/Phase	: HORIZONTAL
Test Mode	: Mode 2, CH11		:

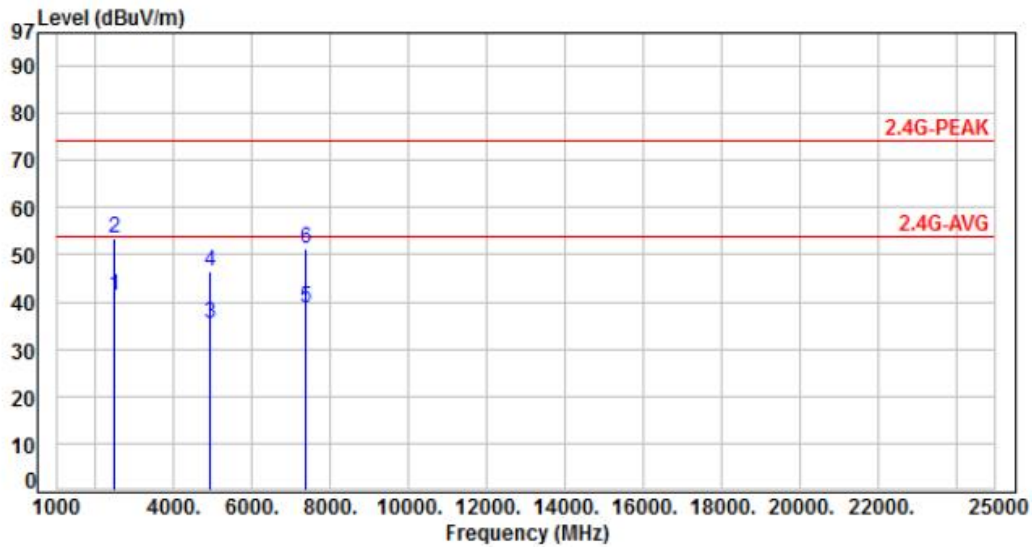

No.	Frequency (MHz)	Factor (dB)	Reading (dBuV)	Level (dBuV/m)	Limit (dBuV/m)	Margin (dB)	Detector	Height (cm)	Azimuth (deg)	P/F
1	2483.50	-2.69	44.18	41.49	54.00	-12.51	Average	100	58	P
2	2483.50	-2.69	56.25	53.56	74.00	-20.44	Peak	100	58	P
3	4924.00	5.30	30.19	35.49	54.00	-18.51	Average	100	63	P
4	4924.00	5.30	41.22	46.52	74.00	-27.48	Peak	100	63	P
5	7386.00	10.14	28.47	38.61	54.00	-15.39	Average	100	296	P
6	7386.00	10.14	40.97	51.11	74.00	-22.89	Peak	100	296	P

Note: Level=Reading+Factor
Margin=Level-Limit
Factor=Antenna Factor + cable loss - Amplifier Factor



Power	: AC 120V / 60HZ	Pol/Phase	: VERTICAL
Test Mode	: Mode 3, CH01		:

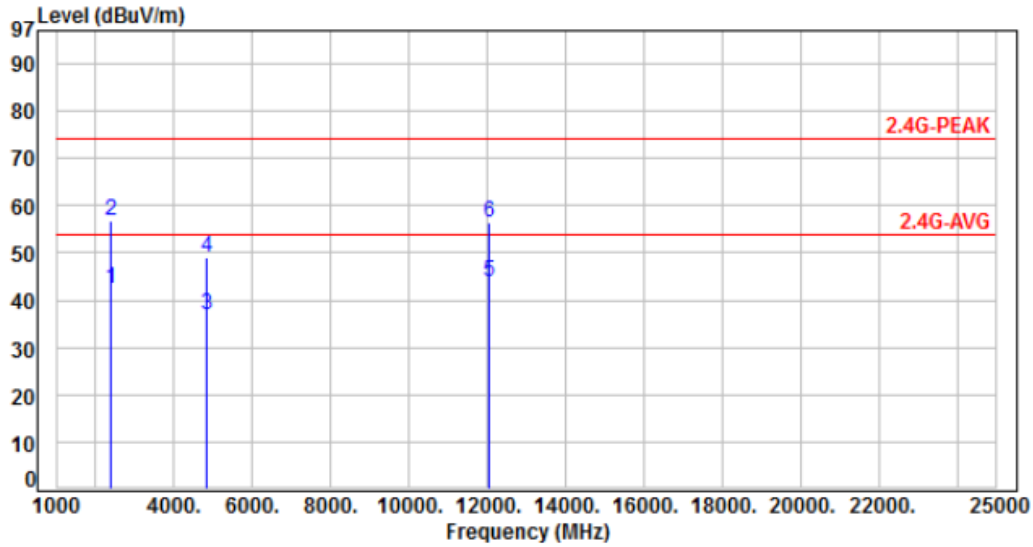

No.	Frequency (MHz)	Factor (dB)	Reading (dBuV)	Level (dBuV/m)	Limit (dBuV/m)	Margin (dB)	Detector	Height (cm)	Azimuth (deg)	P/F
1	2390.00	-2.89	45.41	42.52	54.00	-11.48	Average	100	53	P
2	2390.00	-2.89	59.59	56.70	74.00	-17.30	Peak	100	53	P
3	4824.00	4.88	32.05	36.93	54.00	-17.07	Average	100	65	P
4	4824.00	4.88	44.23	49.11	74.00	-24.89	Peak	100	65	P
5	12060.00	14.80	28.99	43.79	54.00	-10.21	Average	100	220	P
6	12060.00	14.80	41.80	56.60	74.00	-17.40	Peak	100	220	P

Note: Level=Reading+Factor
 Margin=Level-Limit
 Factor=Antenna Factor + cable loss - Amplifier Factor



Power	: AC 120V / 60HZ	Pol/Phase	: HORIZONTAL
Test Mode	: Mode 3, CH01		:

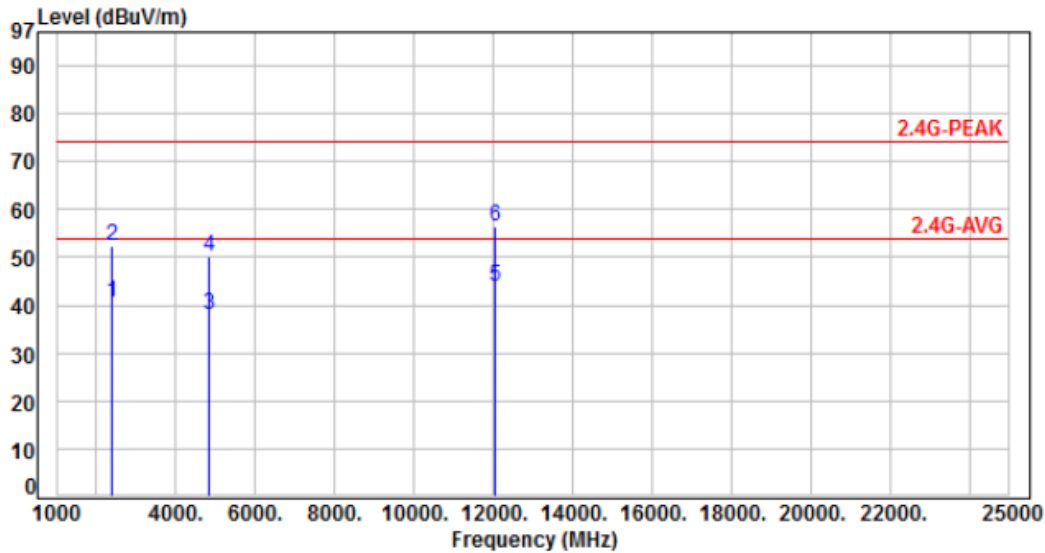

No.	Frequency (MHz)	Factor (dB)	Reading (dBuV)	Level (dBuV/m)	Limit (dBuV/m)	Margin (dB)	Detector	Height (cm)	Azimuth (deg)	P/F
1	2390.00	-2.89	43.54	40.65	54.00	-13.35	Average	100	41	P
2	2390.00	-2.89	55.26	52.37	74.00	-21.63	Peak	100	41	P
3	4824.00	4.88	33.05	37.93	54.00	-16.07	Average	100	176	P
4	4824.00	4.88	45.20	50.08	74.00	-23.92	Peak	100	176	P
5	12060.00	14.80	29.25	44.05	54.00	-9.95	Average	100	101	P
6	12060.00	14.80	41.70	56.50	74.00	-17.50	Peak	100	101	P

Note: Level=Reading+Factor
 Margin=Level-Limit
 Factor=Antenna Factor + cable loss - Amplifier Factor



Power	: AC 120V / 60HZ	Pol/Phase	: VERTICAL
Test Mode	: Mode 3, CH06		:

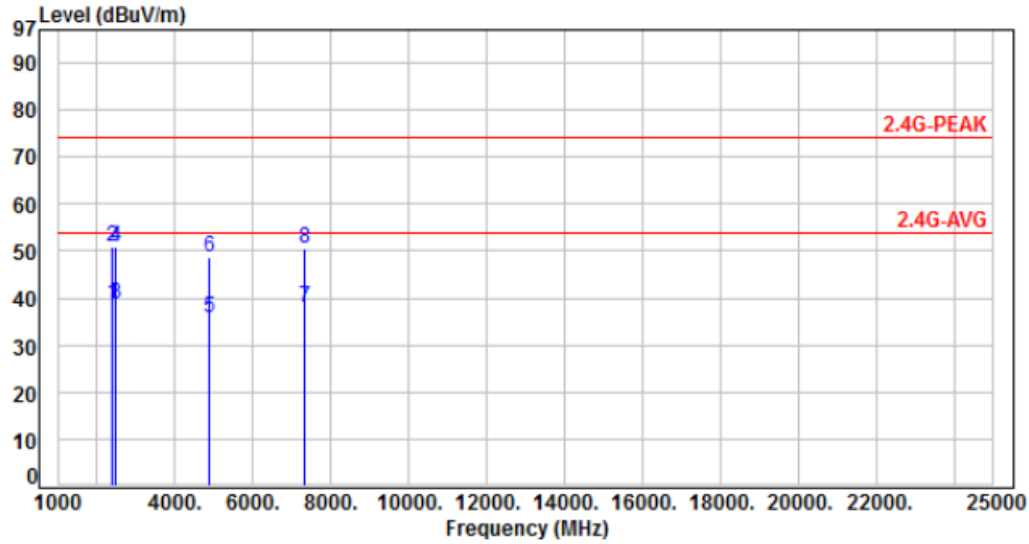

No.	Frequency (MHz)	Factor (dB)	Reading (dBuV)	Level (dBuV/m)	Limit (dBuV/m)	Margin (dB)	Detector	Height (cm)	Azimuth (deg)	P/F
1	2390.00	-2.89	41.59	38.70	54.00	-15.30	Average	100	54	P
2	2390.00	-2.89	53.65	50.76	74.00	-23.24	Peak	100	54	P
3	2483.50	-2.69	41.28	38.59	54.00	-15.41	Average	100	54	P
4	2483.50	-2.69	53.44	50.75	74.00	-23.25	Peak	100	54	P
5	4874.00	5.09	30.62	35.71	54.00	-18.29	Average	100	65	P
6	4874.00	5.09	43.48	48.57	74.00	-25.43	Peak	100	65	P
7	7311.00	10.01	28.11	38.12	54.00	-15.88	Average	100	175	P
8	7311.00	10.01	40.60	50.61	74.00	-23.39	Peak	100	175	P

Note: Level=Reading+Factor
 Margin=Level-Limit
 Factor=Antenna Factor + cable loss - Amplifier Factor



Power	: AC 120V / 60HZ	Pol/Phase	: HORIZONTAL
Test Mode	: Mode 3, CH06		:

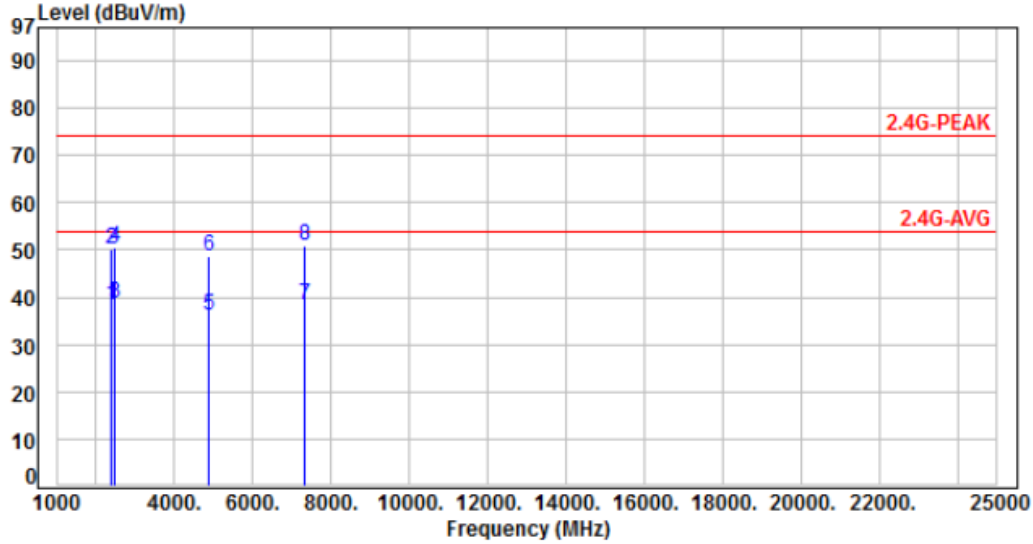

No.	Frequency (MHz)	Factor (dB)	Reading (dBuV)	Level (dBuV/m)	Limit (dBuV/m)	Margin (dB)	Detector	Height (cm)	Azimuth (deg)	P/F
1	2390.00	-2.89	41.22	38.33	54.00	-15.67	Average	100	41	P
2	2390.00	-2.89	53.04	50.15	74.00	-23.85	Peak	100	41	P
3	2483.50	-2.69	41.57	38.88	54.00	-15.12	Average	100	41	P
4	2483.50	-2.69	53.13	50.44	74.00	-23.56	Peak	100	41	P
5	4874.00	5.09	31.06	36.15	54.00	-17.85	Average	100	59	P
6	4874.00	5.09	43.69	48.78	74.00	-25.22	Peak	100	59	P
7	7311.00	10.01	28.23	38.24	54.00	-15.76	Average	100	295	P
8	7311.00	10.01	40.90	50.91	74.00	-23.09	Peak	100	295	P

Note: Level=Reading+Factor
 Margin=Level-Limit
 Factor=Antenna Factor + cable loss - Amplifier Factor



Power	: AC 120V / 60HZ	Pol/Phase	: VERTICAL
Test Mode	: Mode 3, CH11		:

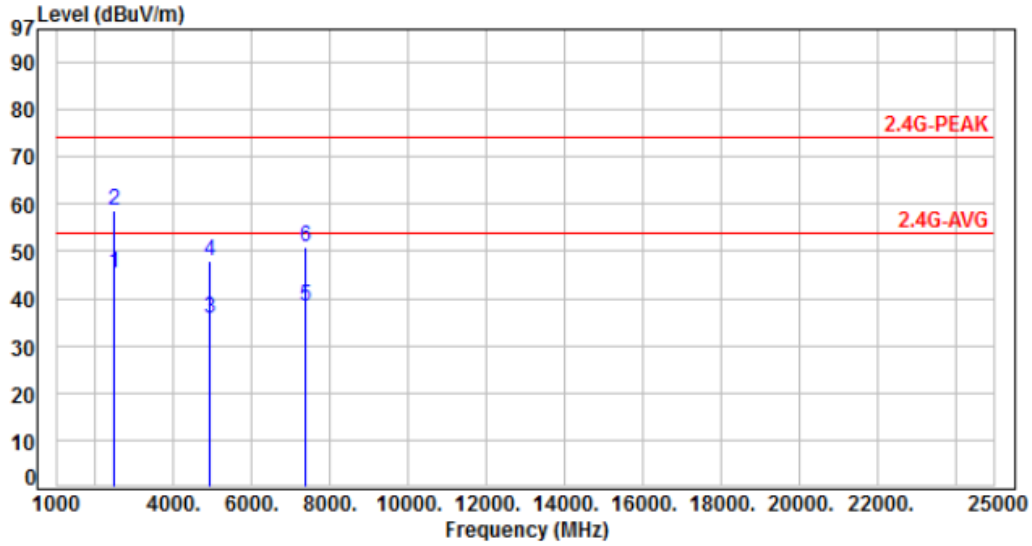

No.	Frequency (MHz)	Factor (dB)	Reading (dBuV)	Level (dBuV/m)	Limit (dBuV/m)	Margin (dB)	Detector	Height (cm)	Azimuth (deg)	P/F
1	2483.50	-2.69	47.87	45.18	54.00	-8.82	Average	100	59	P
2	2483.50	-2.69	61.18	58.49	74.00	-15.51	Peak	100	59	P
3	4924.00	5.30	30.60	35.90	54.00	-18.10	Average	100	68	P
4	4924.00	5.30	42.49	47.79	74.00	-26.21	Peak	100	68	P
5	7386.00	10.14	28.18	38.32	54.00	-15.68	Average	100	171	P
6	7386.00	10.14	40.58	50.72	74.00	-23.28	Peak	100	171	P

Note: Level=Reading+Factor
 Margin=Level-Limit
 Factor=Antenna Factor + cable loss - Amplifier Factor



Power	: AC 120V / 60HZ	Pol/Phase	: HORIZONTAL
Test Mode	: Mode 3, CH11		:

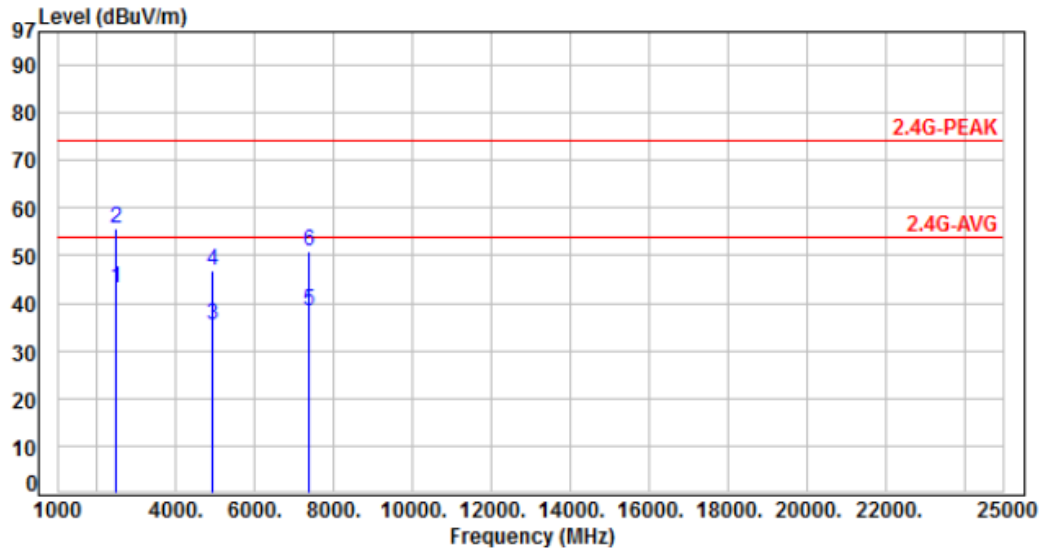

No.	Frequency (MHz)	Factor (dB)	Reading (dBuV)	Level (dBuV/m)	Limit (dBuV/m)	Margin (dB)	Detector	Height (cm)	Azimuth (deg)	P/F
1	2483.50	-2.69	45.94	43.25	54.00	-10.75	Average	100	45	P
2	2483.50	-2.69	58.22	55.53	74.00	-18.47	Peak	100	45	P
3	4924.00	5.30	30.04	35.34	54.00	-18.66	Average	100	61	P
4	4924.00	5.30	41.38	46.68	74.00	-27.32	Peak	100	61	P
5	7386.00	10.14	28.28	38.42	54.00	-15.58	Average	100	300	P
6	7386.00	10.14	40.71	50.85	74.00	-23.15	Peak	100	300	P

Note: Level=Reading+Factor
 Margin=Level-Limit
 Factor=Antenna Factor + cable loss - Amplifier Factor



6.7 Restricted Bands of Operation

Only spurious emissions are permitted in any of the frequency bands listed below:

MHz	MHz	MHz	GHz
0.09000 – 0.11000	16.42000 – 16.42300	399.9 – 410.0	4.500 – 5.250
0.49500 – 0.505**	16.69475 – 16.69525	608.0 – 614.0	5.350 – 5.460
2.17350 – 2.19050	16.80425 – 16.80475	960.0 – 1240.0	7.250 – 7.750
4.12500 – 4.12800	25.50000 – 25.67000	1300.0 – 1427.0	8.025 – 8.500
4.17725 – 4.17775	37.50000 – 38.25000	1435.0 – 1626.5	9.000 – 9.200
4.20725 – 4.20775	73.00000 – 74.60000	1645.5 – 1646.5	9.300 – 9.500
6.21500 – 6.21800	74.80000 – 75.20000	1660.0 – 1710.0	10.600 – 12.700
6.26775 – 6.26825	108.00000 – 121.94000	1718.8 – 1722.2	13.250 – 13.400
6.31175 – 6.31225	123.00000 – 138.00000	2200.0 – 2300.0	14.470 – 14.500
8.29100 – 8.29400	149.90000 – 150.05000	2310.0 – 2390.0	15.350 – 16.200
8.36200 – 8.36600	156.52475 – 156.52525	2483.5 – 2500.0	17.700 – 21.400
8.37625 – 8.38675	156.70000 – 156.90000	2655.0 – 2900.0	22.010 – 23.120
8.41425 – 8.41475	162.01250 – 167.17000	3260.0 – 3267.0	23.600 – 24.000
12.29000 – 12.29300	167.72000 – 173.20000	3332.0 – 3339.0	31.200 – 31.800
12.51975 – 12.52025	240.00000 – 285.00000	3345.8 – 3358.0	36.430 – 36.500
12.57675 – 12.57725	322.00000 – 335.40000	3600.0 – 4400.0	Above 38.6
13.36000 – 13.41000			

** : Until February 1, 1999, this restricted band shall be 0.490-0.510 MHz



7. Test of Conducted Spurious Emission

7.1 Test Limit

Below -20dB of the highest emission level of operating band (In 100 kHz Resolution Bandwidth)

7.2 Test Procedure

- a. The transmitter output was connected to the spectrum analyzer via a low loss cable.
- b. Set RBW of spectrum analyzer to 100 KHz and VBW of spectrum analyzer to 300 KHz with convenient frequency span including 100 KHz bandwidth from band edge.
- c. Peak conducted output power measured within any 100 kHz outside the authorized frequency band shall be attenuated by at least 20dB relative to the maximum measured in-band peak PSD level.
- d. The band edges was measured and recorded.

7.3 Test Setup Layout

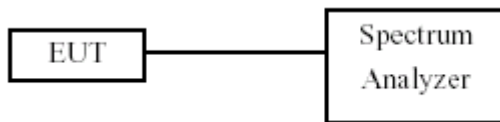

7.4 Test Result and Data

Note: Test plots refers to the following pages.



Modulation Type: 802.11b, CH 01

Modulation Type: 802.11b, CH 06

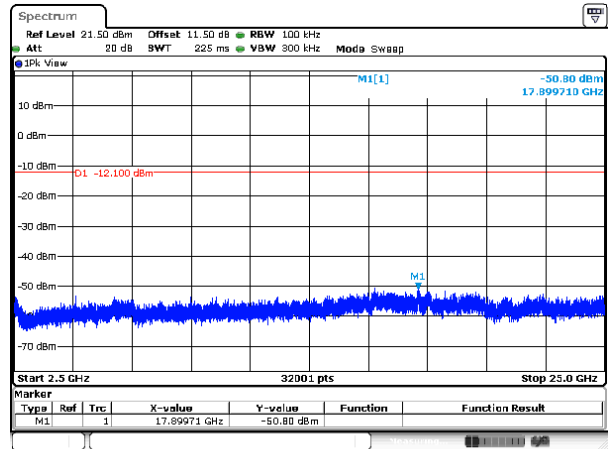
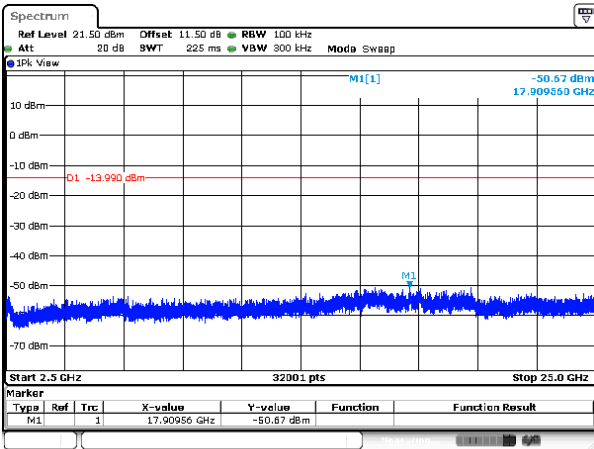
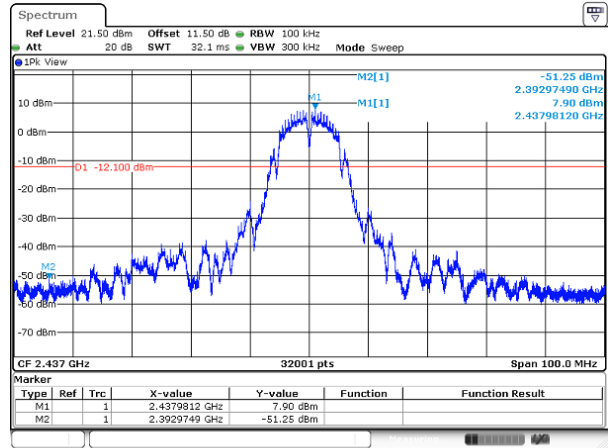
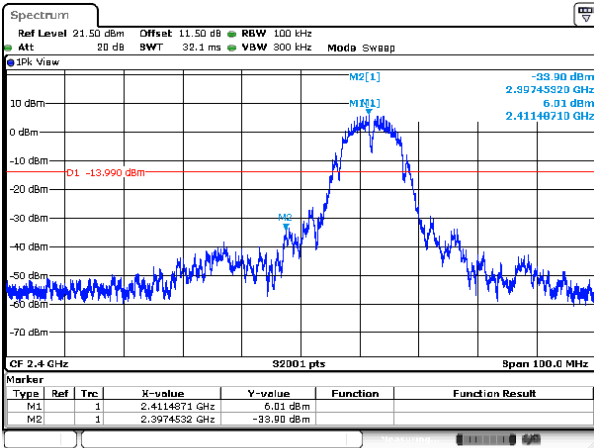
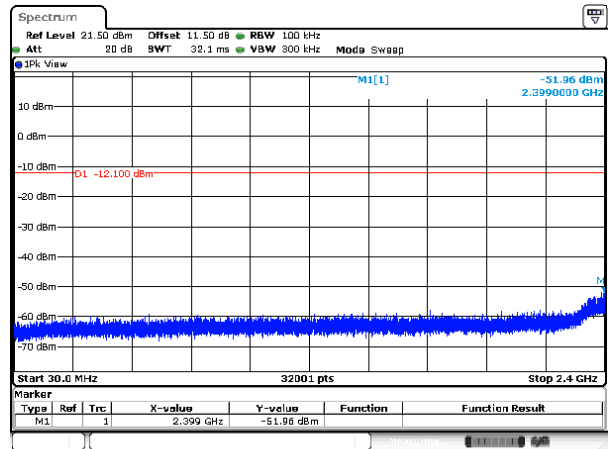
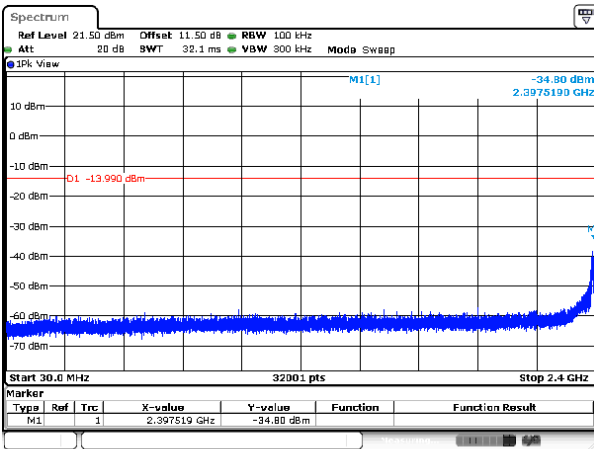



Modulation Type: 802.11b, CH 11

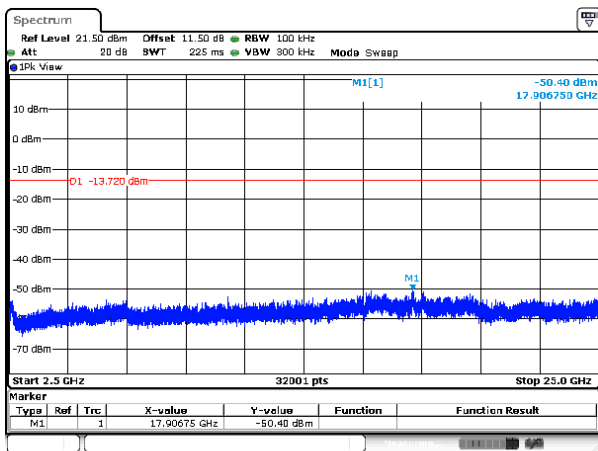
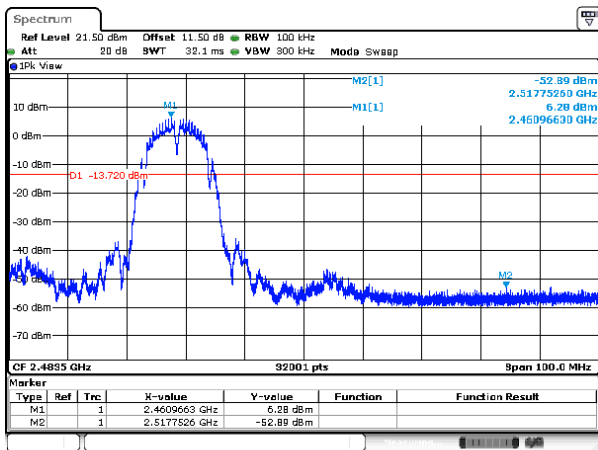
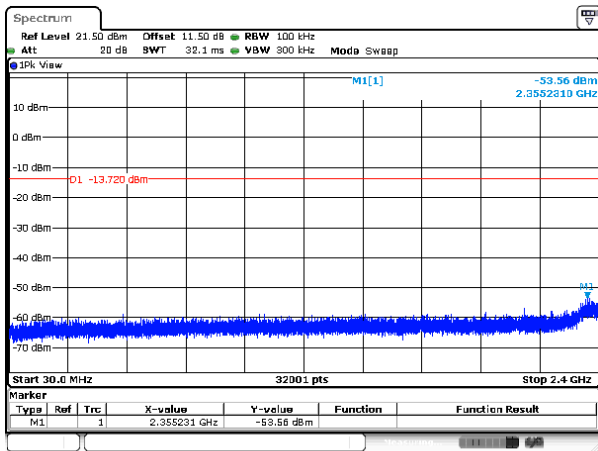



Modulation Type: 802.11g, CH 01

Modulation Type: 802.11g, CH 06

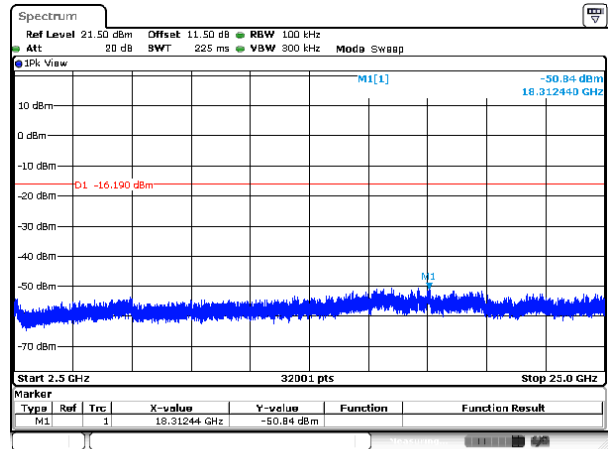
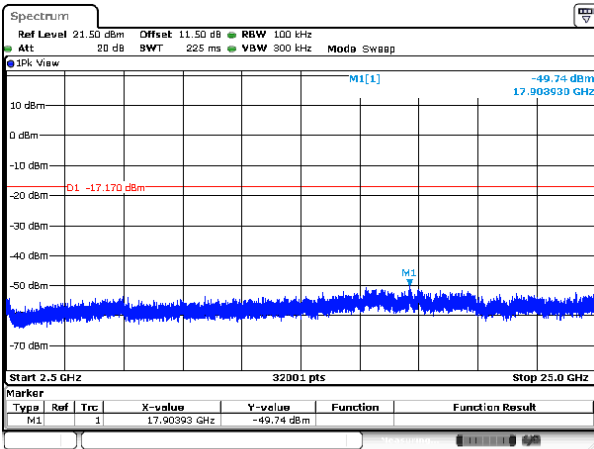
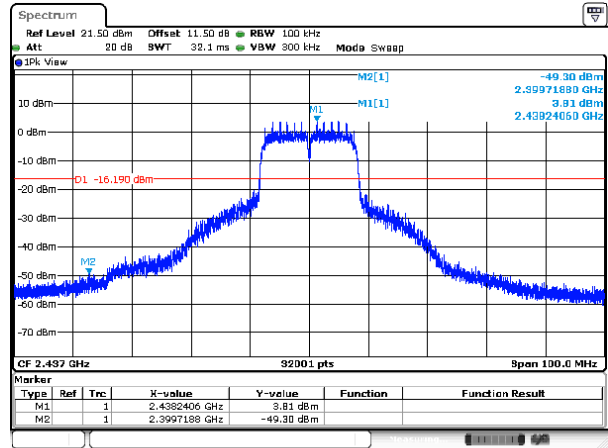
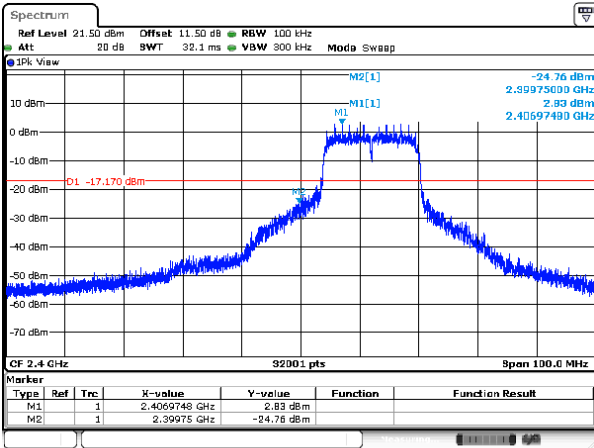
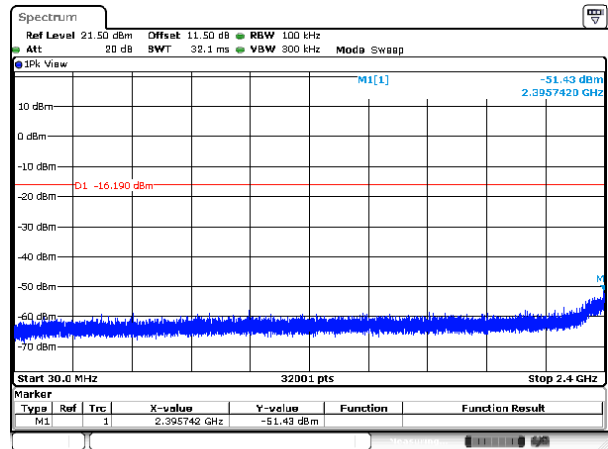
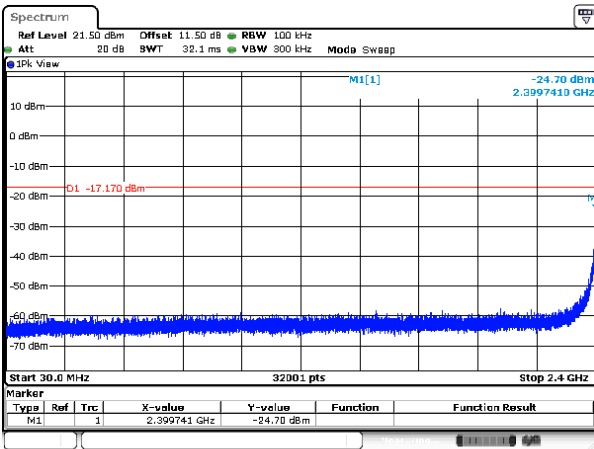



Modulation Type: 802.11g, CH 11

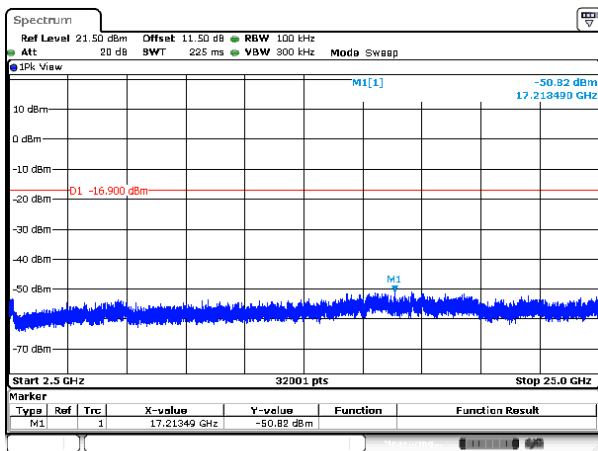
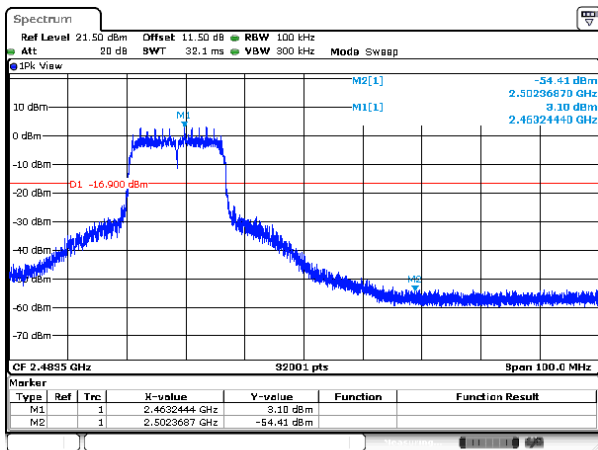
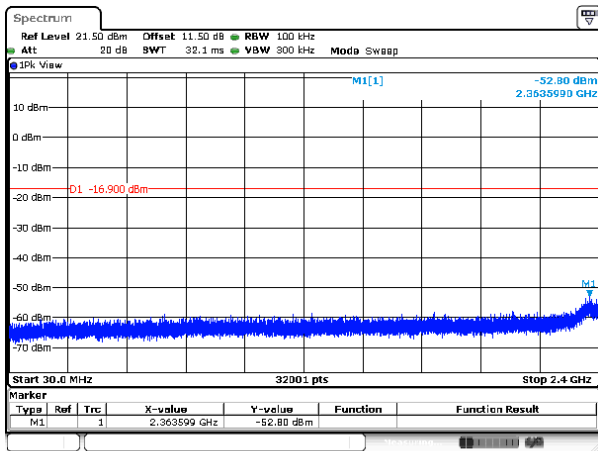



Modulation Type: 802.11n HT20, CH01

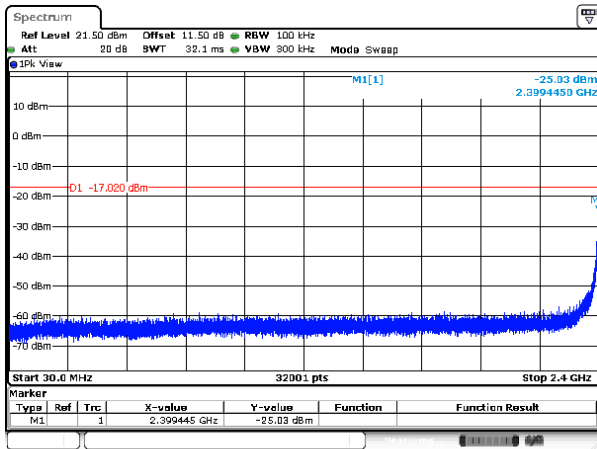

Modulation Type: 802.11n HT20, CH06

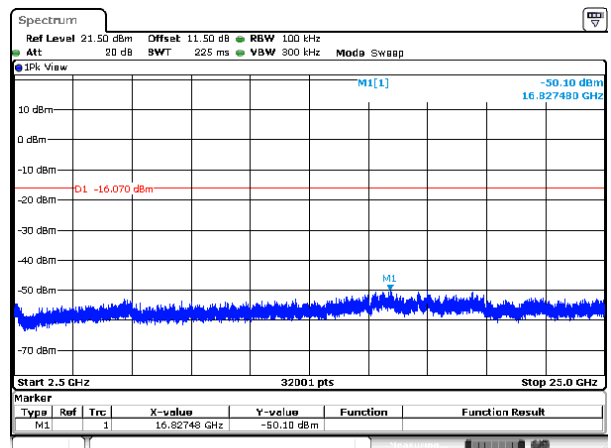
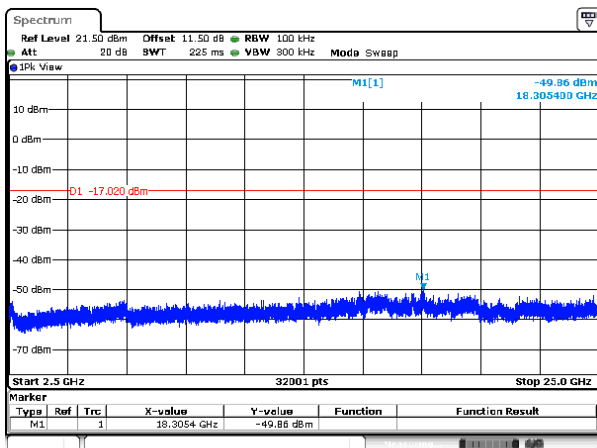
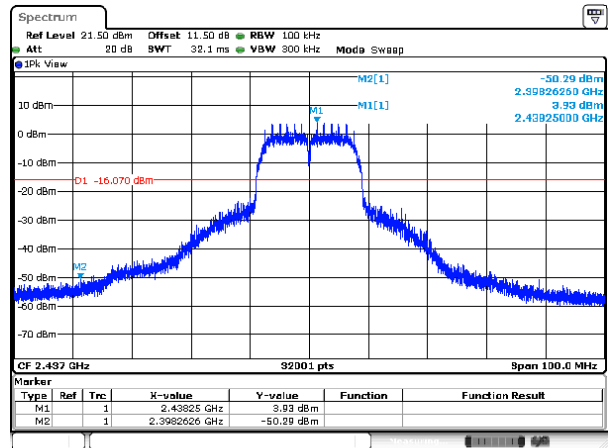
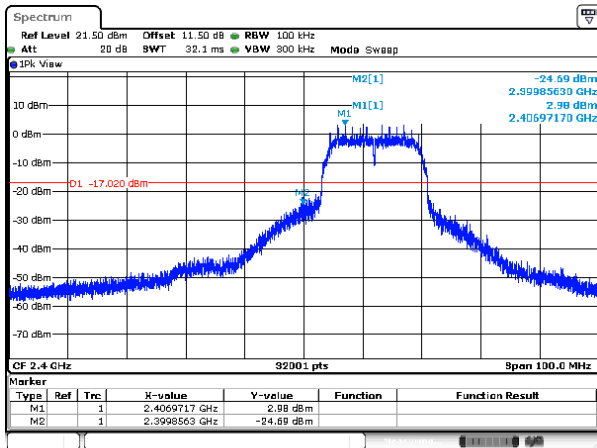
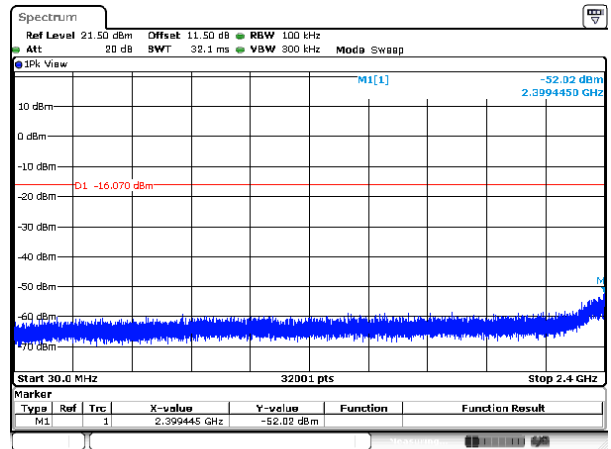



Modulation Type: 802.11n HT20, CH11

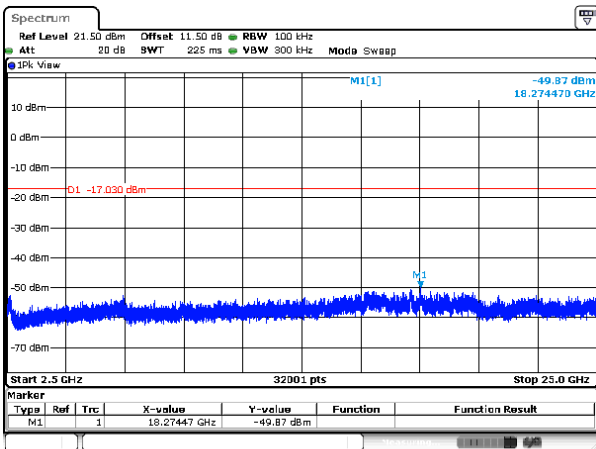
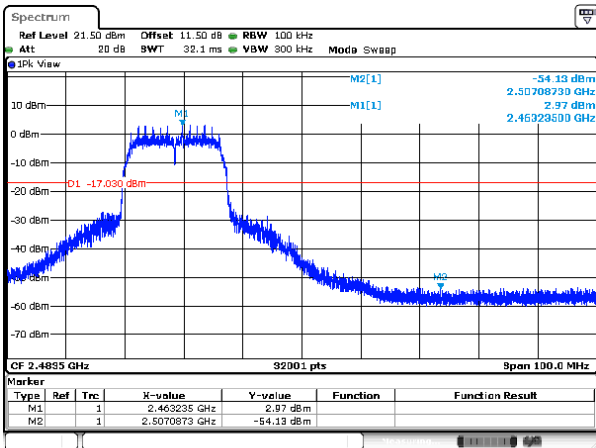
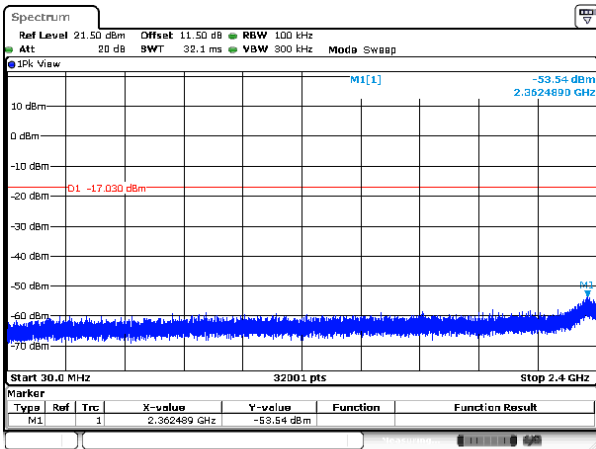



8. On Time, Duty Cycle and Measurement methods

8.1 Test Limit

None; for reporting purposes only.

8.2 Test Procedure

Zero-Span Spectrum Analyzer Method.

8.3 Test Setup Layout

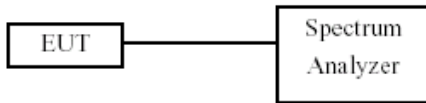

8.4 Test Result and Data

Modulation Type	On Time (ms)	Period Time (ms)	Duty Cycle (%)
11b,1M	4.23	4.72	89.69%
11g,6M	0.70	0.80	87.64%
11n HT20	0.66	0.76	87.40%



Modulation Type: 802.11b(1Mbps)

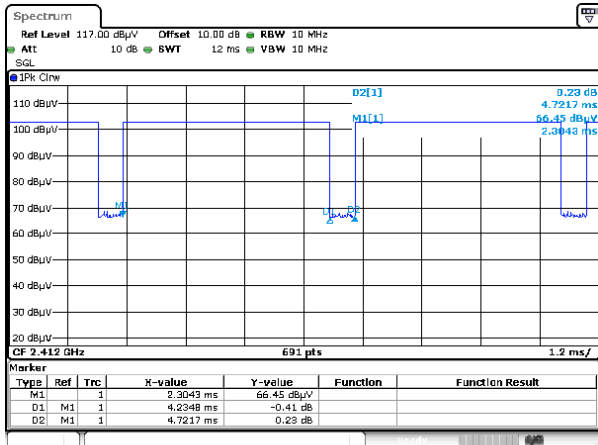

Modulation Type: 802.11g(6Mbps)

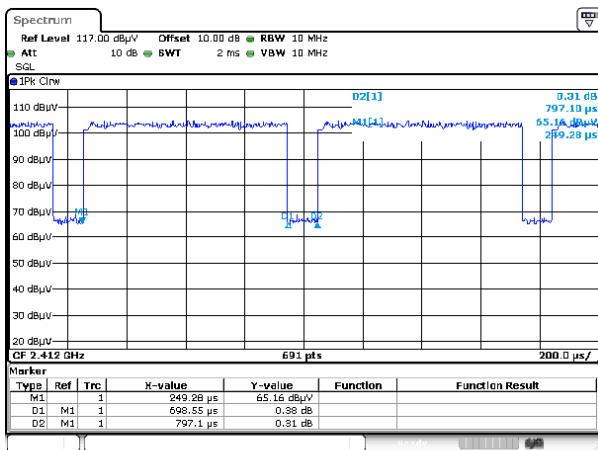

Modulation Type: 802.11n HT20(6.5Mbps)

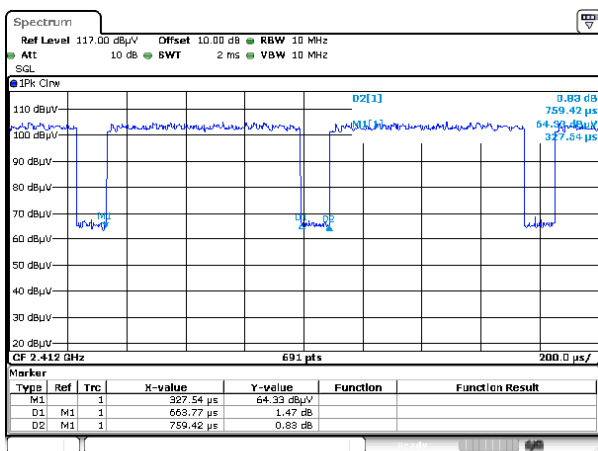



9. 6dB Bandwidth Measurement Data

9.1 Test Limit

The minimum of 6dB Bandwidth Measurement is 0.5 MHz.

9.2 Test Procedures

- a. The transmitter output was connected to the spectrum analyzer.
- b. Set RBW of spectrum analyzer to 100 KHz and VBW to 300 KHz.
- c. The 6 dB bandwidth is defined as the total spectrum the power of which is higher than peak power minus 6 dB.
- d. The 6dB Bandwidth was measured and recorded.

9.3 Test Setup Layout

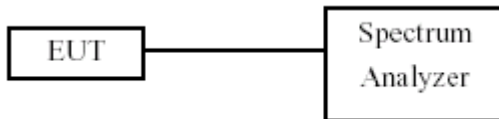

9.4 Test Result and Data

Modulation Type	Channel	Frequency (MHz)	6dB Bandwidth (MHz)	Limit (MHz)
			ANT A	
11b	1	2412	9.03	0.5
	6	2437	9.03	0.5
	11	2462	9.03	0.5
11g	1	2412	15.07	0.5
	6	2437	15.11	0.5
	11	2462	15.11	0.5
11n HT20	1	2412	15.11	0.5
	6	2437	15.11	0.5
	11	2462	15.11	0.5



Modulation Type: 802.11b
CH01

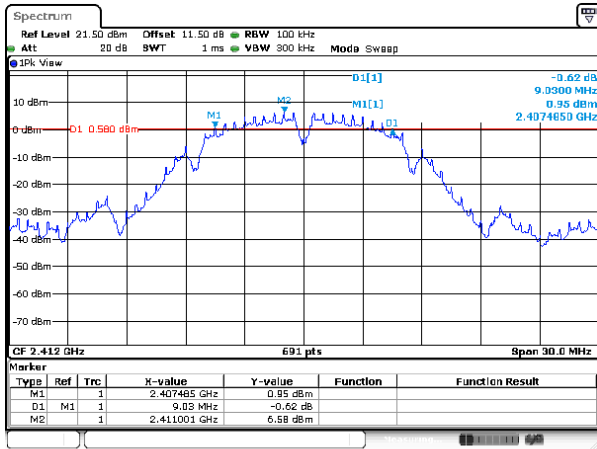

Modulation Type: 802.11g
CH01

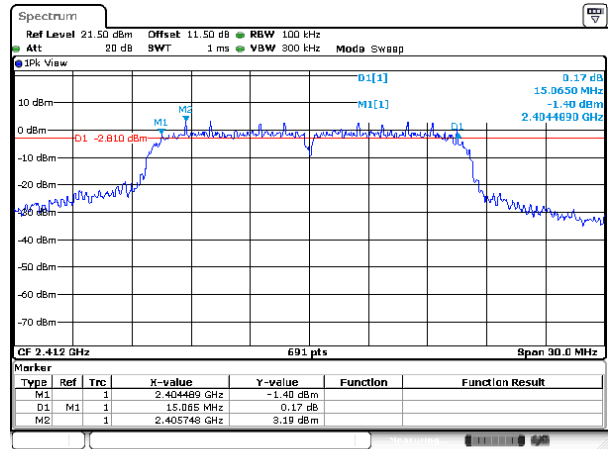

CH06

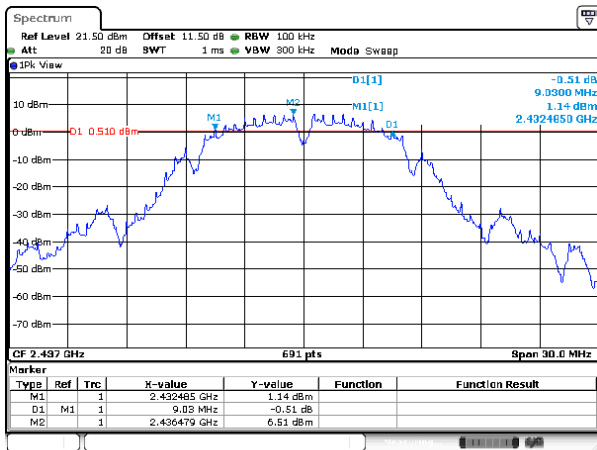

CH06

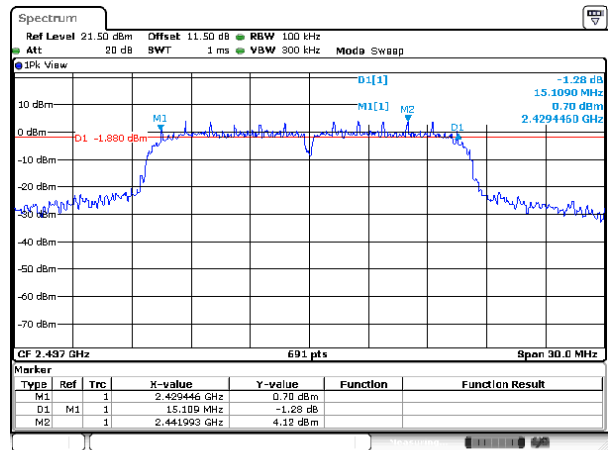

CH11

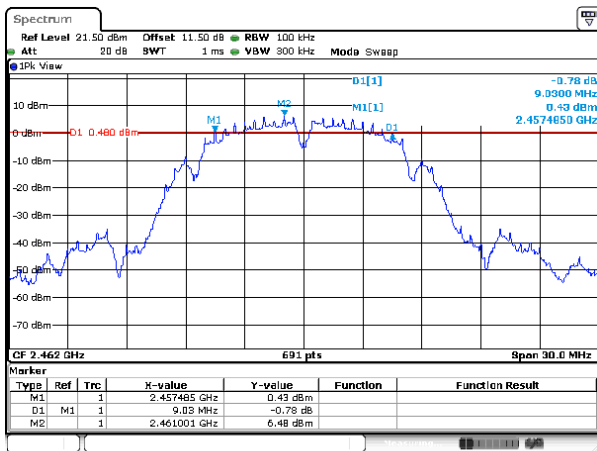

CH11

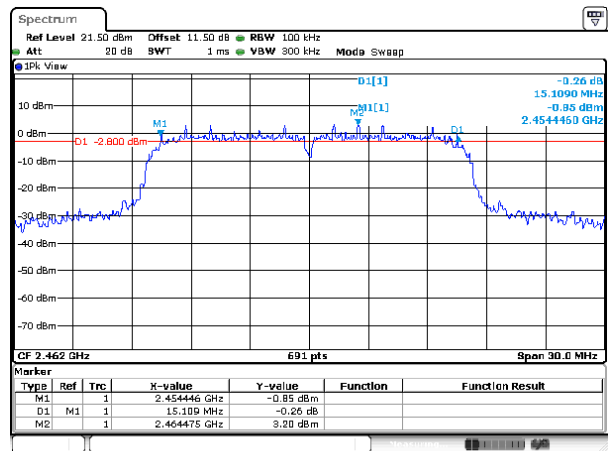



Modulation Type: 802.11n HT20
CH01

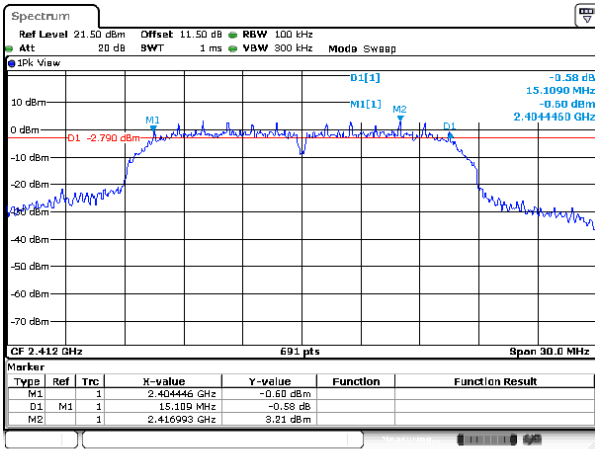

CH06

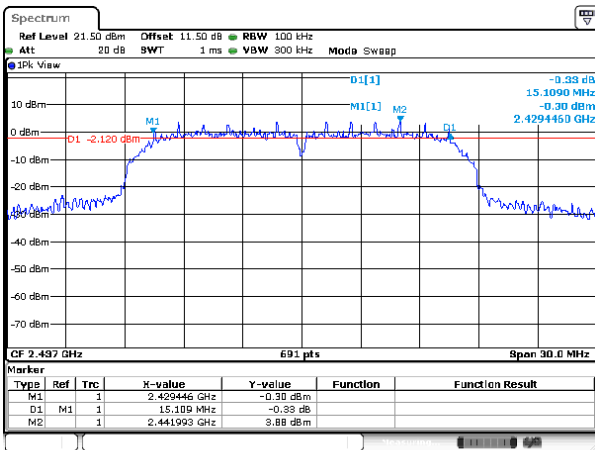

CH11

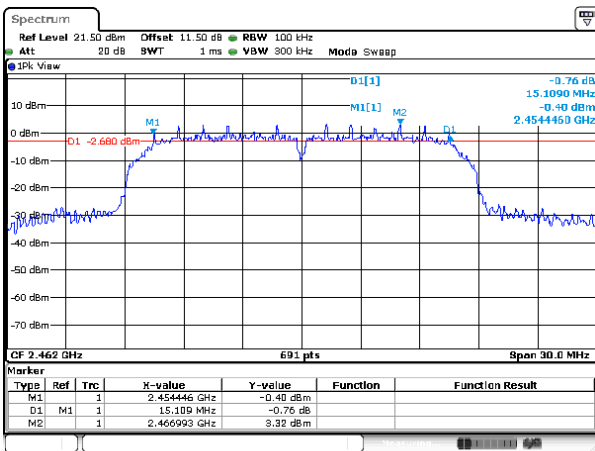



10. Maximum Peak and Average Output Power

10.1 Test Limit

The Maximum Peak Output Power Measurement is 30dBm.

If transmitting antennas of directional gain greater than 6 dBi are used, the peak output power shall be reduced by the amount in dB that the directional gain of the antenna exceeds 6 dBi

10.2 Test Procedures

The antenna port (RF output) of the EUT was connected to the input (RF input) of a power meter. Power was read directly from the meter and cable loss connection was added to the reading to obtain power at the EUT antenna terminal. The EUT Output Power was set to maximum to produce the worse case test result.

10.3 Test Setup Layout

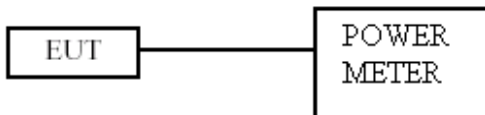



10.4 Test Result and Data

Setting	Modulation Mode	Channel	Frequency (MHz)	Conducted(peak) output power (dBm)	Total PK power (dBm)	Total PK power (mW)	Power Limit (dBm)
				ANT A			
0	11b	1	2412	17.79	17.79	60.117	30.00
0		6	2437	18.54	18.54	71.450	30.00
0		11	2462	18.24	18.24	66.681	30.00
0	11g	1	2412	19.51	19.51	89.331	30.00
0		6	2437	20.56	20.56	113.763	30.00
0		11	2462	20.32	20.32	107.647	30.00
0	11n HT20	1	2412	19.32	19.32	85.507	30.00
0		6	2437	20.36	20.36	108.643	30.00
0		11	2462	20.13	20.13	103.039	30.00

Power Set	Modulation Mode	Channel	Frequency (MHz)	Conducted(average) output power (dBm)	Total AV power (dBm)	Total AV power (mW)	Power Limit (dBm)
				ANT A			
0	11b	1	2412	14.68	14.68	29.376	NA
0		6	2437	15.46	15.46	35.156	NA
0		11	2462	14.92	14.92	31.046	NA
0	11g	1	2412	14.03	14.03	25.293	NA
0		6	2437	14.85	14.85	30.549	NA
0		11	2462	14.14	14.14	25.942	NA
0	11n HT20	1	2412	13.95	13.95	24.831	NA
0		6	2437	14.83	14.83	30.409	NA
0		11	2462	14.02	14.02	25.235	NA

*Average power is for reference only.



11. Power Spectral Density

11.1 Test Limit

The Maximum of Power Spectral Density Measurement is 8dBm.

If transmitting antennas of directional gain greater than 6 dBi are used, the power spectral density shall be reduced by the amount in dB that the directional gain of the antenna exceeds 6 dBi

11.2 Test Procedures

- a. The transmitter output was connected to spectrum analyzer.
- b. The spectrum analyzer’s resolution bandwidth were set at 3kHz RBW and 10KHz VBW as that of the fundamental frequency. Set the sweep time=auto couple.
- c. The power spectral density was measured and recorded.

11.3 Test Setup Layout

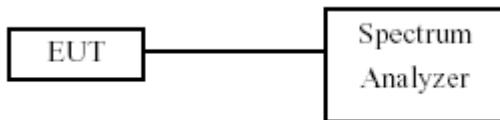

11.4 Test Result and Data

Modulation Type	Channel	Frequency (MHz)	Maximum Power Density of 3KHz Bandwidth(dBm)	Sum chain (dBm)	Duty Cycle CF(dB)	Total PSD (dBm)	Limit (dBm)
			ANT A				
11b	1	2412	-9.16	-9.16	0.00	-9.16	8.00
	6	2437	-7.83	-7.83	0.00	-7.83	8.00
	11	2462	-8.4	-8.40	0.00	-8.40	8.00
11g	1	2412	-11.13	-11.13	0.00	-11.13	8.00
	6	2437	-10.3	-10.30	0.00	-10.30	8.00
	11	2462	-10.89	-10.89	0.00	-10.89	8.00
11n HT20	1	2412	-11.53	-11.53	0.00	-11.53	8.00
	6	2437	-10.56	-10.56	0.00	-10.56	8.00
	11	2462	-11.17	-11.17	0.00	-11.17	8.00



Modulation Type: 802.11b
CH01

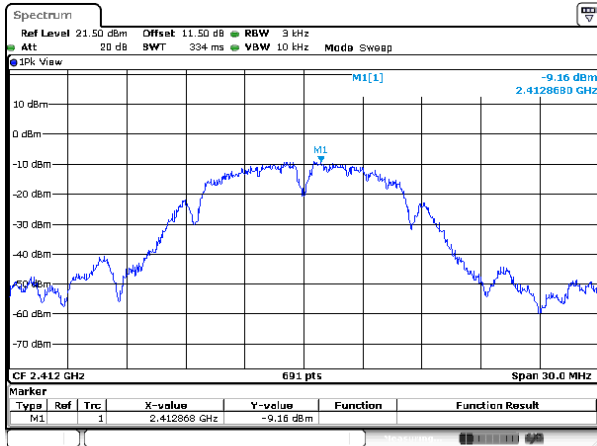

Modulation Type: 802.11g
CH01

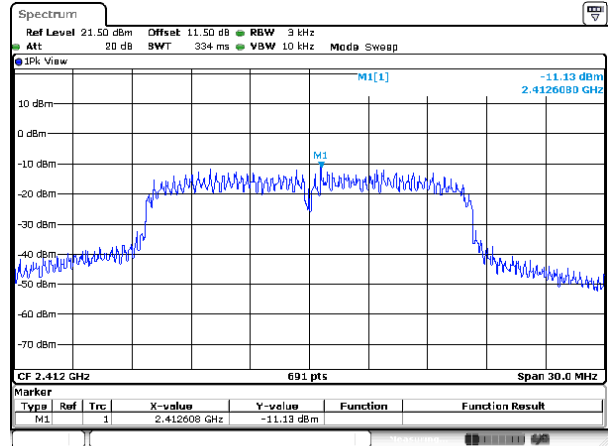

CH06

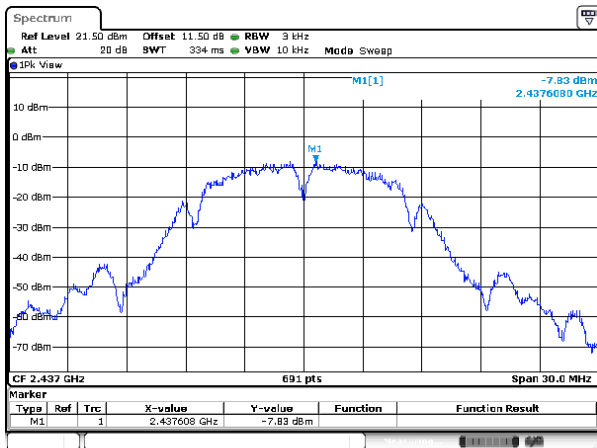

CH06

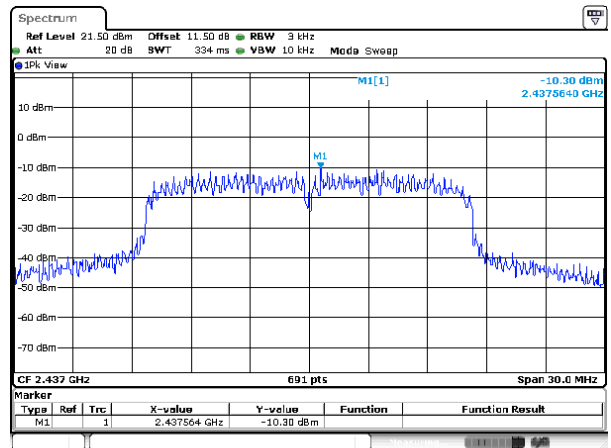

CH11

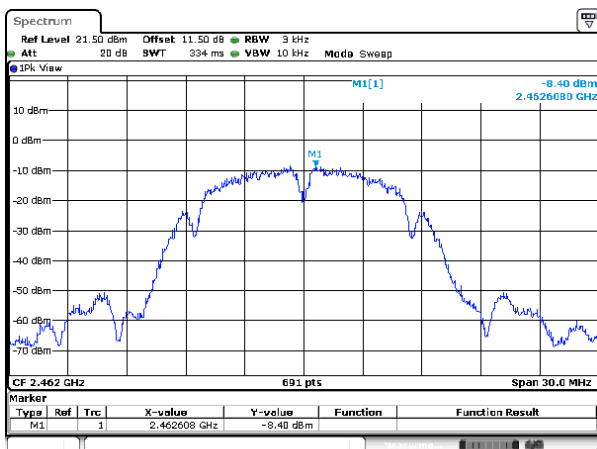

CH11

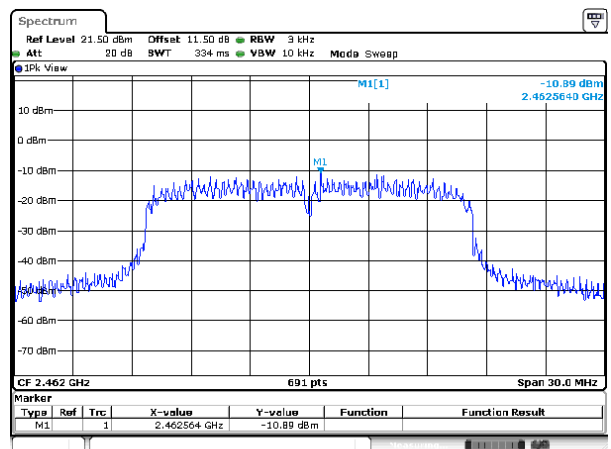



Modulation Type: 802.11n HT20
CH01

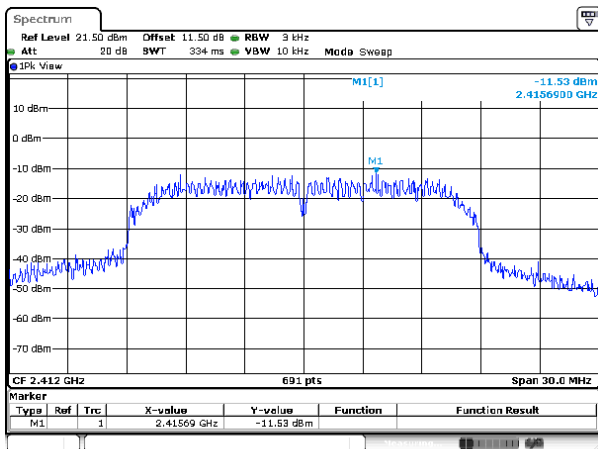

CH06

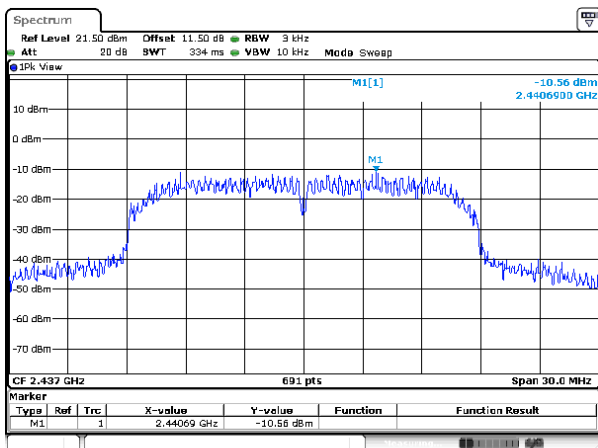

CH11

