



FCC RADIO TEST REPORT

Applicant : Ubiquiti Inc.
Address : 685 Third Avenue, New York, New York 10017
USA
Equipment : UNMS R Pro
Model No. : UNMS-R-Pro
Trade Name : UBIQUITI
FCC ID : SWX-UNMSRP

I HEREBY CERTIFY THAT :

The sample was received on Jul. 06, 2020 and the testing was completed on Aug. 11, 2020 at CerpPASS Technology Corp. The test result refers exclusively to the test presented test model / sample. Without written approval of CerpPASS Technology Corp., the test report shall not be reproduced except in full.

Approved by:

Mark Liao / Supervisor

Laboratory Accreditation:

CerpPASS Technology Corporation Test Laboratory





Contents

| | |
|---|-----------|
| 1. Summary of Test Procedure and Test Results..... | 5 |
| 1.1 Applicable Standards | 5 |
| 2. Test Configuration of Equipment under Test..... | 6 |
| 2.1 Feature of Equipment under Test..... | 6 |
| 2.2 Carrier Frequency of Channels..... | 6 |
| 2.3 Test Mode and Test Software..... | 7 |
| 2.4 Description of Test System..... | 7 |
| 2.5 General Information of Test..... | 8 |
| 2.6 Measurement Uncertainty | 8 |
| 3. Test Equipment and Ancillaries Used for Tests | 9 |
| 4. Antenna Requirements..... | 11 |
| 4.1 Standard Applicable | 11 |
| 4.2 Antenna Construction and Directional Gain..... | 11 |
| 5. Test of AC Power Line Conducted Emission | 12 |
| 5.1 Test Limit | 12 |
| 5.2 Test Procedures | 12 |
| 5.3 Typical Test Setup | 13 |
| 5.4 Test Result and Data | 14 |
| 5.5 Test Photographs | 16 |
| 6. Test of Spurious Emission (Radiated) | 17 |
| 6.1 Test Limit | 17 |
| 6.2 Test Procedures | 17 |
| 6.3 Typical Test Setup | 18 |
| 6.4 Test Result and Data (9kHz ~ 30MHz)..... | 19 |
| 6.5 Test Result and Data (30MHz ~ 1GHz)..... | 19 |
| 6.6 Test Result and Data (1GHz ~ 25GHz)..... | 21 |
| 6.7 Restricted Bands of Operation | 27 |
| 6.8 Test Photographs (30MHz ~ 1GHz)..... | 28 |
| 6.9 Test Photographs (1GHz ~ 25GHz)..... | 29 |
| 7. Test of Spurious Emission (Conducted)..... | 31 |
| 7.1 Test Limit | 31 |
| 7.2 Test Procedure | 31 |
| 7.3 Test Setup Layout | 31 |
| 7.4 Test Result and Data | 31 |
| 8. On Time, Duty Cycle and Measurement methods | 34 |
| 8.1 Test Limit | 34 |
| 8.2 Test Procedure | 34 |
| 8.3 Test Setup Layout | 34 |
| 8.4 Test Result and Data | 34 |
| 9. 6dB Bandwidth Measurement Data | 36 |
| 9.1 Test Limit | 36 |



9.2 Test Procedures 36

9.3 Test Setup Layout 36

9.4 Test Result and Data 36

10. Maximum Peak and Average Output Power 38

10.1 Test Limit 38

10.2 Test Procedures 38

10.3 Test Setup Layout 38

10.4 Test Result and Data 38

11. Power Spectral Density 39

11.1 Test Limit 39

11.2 Test Procedures 39

11.3 Test Setup Layout 39

11.4 Test Result and Data 39

12. Radio Frequency Exposure 41

12.1 Applicable Standards 41

12.2 EUT Specification 41

12.3 Test Results 42

12.4 Calculation 42

12.5 Maximum Permissible Exposure 43



History of this test report

| Report No. | Issue Date | Description |
|-------------|---------------|-------------|
| TEFQ2007055 | Aug. 26, 2020 | Original |
| | | |
| | | |
| | | |
| | | |
| | | |
| | | |
| | | |
| | | |
| | | |
| | | |
| | | |
| | | |
| | | |
| | | |



1. Summary of Test Procedure and Test Results

1.1 Applicable Standards

ANSI C63.10:2013

FCC Rules and Regulations Part 15 Subpart C §15.247

| FCC Rule | Description of Test | Result |
|------------------|----------------------------------|--------|
| 15.203 | Antenna Requirement | PASS |
| 15.207 | AC Power Line Conducted Emission | PASS |
| 15.209 15.205 | Radiated Spurious Emission | PASS |
| 15.247(d) | Conducted Spurious Emission | PASS |
| 15.247(a)(2) | 6dB Bandwidth | PASS |
| 15.247(b) | Maximum Peak Output Power | PASS |
| 15.247(e) | Power Spectral Density | PASS |

*The lab has reduced the uncertainty risk factor from test equipment, environment and staff technicians which according to the standard on contract. Therefore, the test result will only be determined by standard requirement.

*This EUT has been also tested and compiled with the requirement of FCC Part 15, Subpart B, recorded in a separate test report(TEFD2007055).



2. Test Configuration of Equipment under Test

2.1 Feature of Equipment under Test

| | |
|-----------------------|---|
| Frequency Range | 2402-2480MHz |
| Modulation Type | GFSK |
| Modulation Technology | DTS |
| Data Rate | GFSK: 1Mbps |
| Antenna Type | Internal Antenna |
| Antenna Gain | 2402-2480MHz: 0dBi |
| Adapter | Brand: SHENZHEN GOSPELL DIGITAL TECHNOLOGY CO.,LTD Model: GP306B-240-250 |

Note: For more details, please refer to the User's manual of the EUT.

2.2 Carrier Frequency of Channels

| Channel | Frequency (MHz) | Channel | Frequency (MHz) | Channel | Frequency (MHz) |
|------------|-----------------|------------|-----------------|------------|-----------------|
| *00 | 2402 | 14 | 2430 | 28 | 2458 |
| 01 | 2404 | 15 | 2432 | 29 | 2460 |
| 02 | 2406 | 16 | 2434 | 30 | 2462 |
| 03 | 2408 | 17 | 2436 | 31 | 2464 |
| 04 | 2410 | 18 | 2438 | 32 | 2466 |
| 05 | 2412 | *19 | 2440 | 33 | 2468 |
| 06 | 2414 | 20 | 2442 | 34 | 2470 |
| 07 | 2416 | 21 | 2444 | 35 | 2472 |
| 08 | 2418 | 22 | 2446 | 36 | 2474 |
| 09 | 2420 | 23 | 2448 | 37 | 2476 |
| 10 | 2422 | 24 | 2450 | 38 | 2478 |
| 11 | 2424 | 25 | 2452 | *39 | 2480 |
| 12 | 2426 | 26 | 2454 | -- | -- |
| 13 | 2428 | 27 | 2456 | -- | -- |

Note: Channels remarked * are selected to perform test.



2.3 Test Mode and Test Software

- a. During testing, the interface cables and equipment positions were varied according to ANSI C63.10.
- b. The complete test system included Notebook and EUT for RF test.
- c. An executive program, " hcitool command" under Windows OS system was executed to transmit and receive data via Bluetooth.
- d. The following test modes were performed for the test:

| Test Mode | Operating Description |
|-----------|-----------------------|
| 1 | GFSK (1Mbps) |

2.4 Description of Test System

| RF Conducted | | | | |
|----------------------------------|-------|--------|-------------|------------------------|
| Equipment | Brand | Model | Length/Type | Power cord/Length/Type |
| Notebook | ASUS | P2430U | N/A | Adapter / 1.8m / NS |
| RJ45 Cable | N/A | N/A | 1.2m / NS | N/A |
| Radiated Emissions | | | | |
| Equipment | Brand | Model | Length/Type | Power cord/Length/Type |
| Notebook | ASUS | P2430U | N/A | Adapter / 1.8m / NS |
| RJ45 Cable | N/A | N/A | 1.2m / NS | N/A |
| AC Power Line Conducted Emission | | | | |
| Equipment | Brand | Model | Length/Type | Power cord/Length/Type |
| Notebook | ASUS | P2430U | N/A | Adapter / 1.8m / NS |
| RJ45 Cable | N/A | N/A | 1.2m / NS | N/A |



2.5 General Information of Test

| | | |
|-------------------------------|---|--|
| Test Site | CerpPASS Technology Corporation Test Laboratory Address: No.10, Ln. 2, Lianfu St., Luzhu Dist., Taoyuan City 33848, Taiwan (R.O.C.) Tel:+886-3-3226-888 Fax:+886-3-3226-881 | |
| | FCC | TW1439, TW1079 |
| | IC | 4934E-1, 4934E-2 |
| | VCCI | T-2205 for Telecommunication test C-4663 for Conducted emission test R-4218 for Radiated emission test G-10812, G-10813 for radiated disturbance above 1GHz |
| Frequency Range Investigated: | Conducted: from 150kHz to 30 MHz Radiation: from 30 MHz to 25,000MHz | |
| Test Distance: | The test distance of radiated emission from antenna to EUT is 3 M. | |

| Test Item | Test Site | Finish Date | Environmental Conditions | Tested By |
|----------------------------------|------------|-------------|--------------------------|------------|
| RF Conducted | RFCON01-NK | 2020/07/22 | 23°C / 61% | Vic Yeh |
| Radiated Emissions | 3M02-NK | 2020/08/11 | 24°C / 43% | Leon Huang |
| AC Power Line Conducted Emission | CON01-NK | 2020/07/21 | 27°C / 52% | Leon Huang |

2.6 Measurement Uncertainty

| Measurement Item | Uncertainty |
|--|-------------|
| AC Power Line Conduction(150K~30MHz) | ±1.60dB |
| Radiated Spurious Emission(9KHz~30MHz) | ±3.404dB |
| Radiated Spurious Emission(30MHz~1GHz) | ±5.686dB |
| Radiated Spurious Emission(1GHz~25GHz) | ±6.597dB |
| Conducted Spurious Emission | ±2.022dB |
| 6dB Bandwidth | ±4.482% |
| 20dB Bandwidth | ±4.40% |
| Occupied Bandwidth | ±4.40% |
| Peak Output Power(Conducted Power Meter) | ±1.02dB |
| Dwell Time | ±3.49% |
| Power Spectral Density | ±1.963dB |
| Duty Cycle | ±3.47% |



3. Test Equipment and Ancillaries Used for Tests

| Test Item | Radiated Emissions | | | | |
|---------------------|-----------------------------|--------------|--------------------|------------------|------------|
| Test Site | Semi Anechoic Room(3M02-NK) | | | | |
| Instrument | Manufacturer | Model No | Serial No | Calibration Date | Valid Date |
| Bilog Antenna | Schwarzbeck | VULB9168 | 275 | 2019/09/24 | 2020/09/23 |
| Active Loop Antenna | EMCO | 6507 | 40855 | 2020/05/21 | 2021/05/20 |
| Horn Antenna | EMCO | 3115 | 31589 | 2020/03/26 | 2021/03/25 |
| Horn Anrenna | EMCO | 3116 | 31974 | 2019/09/17 | 2020/09/16 |
| EMI Receiver | ROHDE & SCHWARZ | ESCI | 100821 | 2019/09/16 | 2020/09/15 |
| Spectrum Analyzer | ROHDE & SCHWARZ | FSV 40-N | 102151 | 2020/08/03 | 2021/08/02 |
| Preamplifier | EM Electronics corp. | EM330 | 60660 | 2020/03/16 | 2021/03/15 |
| Preamplifier | EMC INSTRUMENTS | EMC051845SE | 980333 | 2019/09/20 | 2020/09/19 |
| Preamplifier | Agilent | 8449B | 3008A01954 | 2020/03/16 | 2021/03/15 |
| Preamplifier | EMC INSTRUMENTS | EMC184045 | 980065 | 2019/11/07 | 2020/11/06 |
| Bluetooth Tester | ROHDE & SCHWARZ | CBT | 101133 | 2020/04/07 | 2021/04/06 |
| Cable-3in1(30M-1G) | HARBOUR INDUSTRIES | LL142 | CCE1316 | 2019/09/20 | 2020/09/19 |
| Cable-0.5m(1G-18G) | HUBER SUHNER | SUCOFLEX 100 | 805443/4 | 2020/05/27 | 2021/05/26 |
| Cable-3m(1G-18G) | HUBER SUHNER | SUCOFLEX 100 | 805796/4 | 2020/05/27 | 2021/05/26 |
| Cable-8m(1G-18G) | HUBER SUHNER | SUCOFLEX 100 | 805795/4 | 2020/05/27 | 2021/05/26 |
| Cable-0.5m(30M-40G) | HUBER SUHNER | SUCOFLEX 102 | 28420/2 | 2020/04/01 | 2021/03/31 |
| Cable-3m(30M-40G) | HUBER SUHNER | SUCOFLEX 102 | MY2608/2 | 2020/04/01 | 2021/03/31 |
| Cable-0.5m(1G-40G) | Rapidtek | 40GHZ 50CM | 38MS-38MS50 314 | 2020/04/09 | 2021/04/08 |
| E3 | AUDIX | v8.2014-8-6 | RK-000529 | NA | NA |

| Test Item | RF Conducted | | | | |
|---------------------|-----------------|----------|-------------|------------------|------------|
| Test Site | RFCON01-NK | | | | |
| Instrument | Manufacturer | Model No | Serial No | Calibration Date | Valid Date |
| Spectrum Analyzer | ROHDE & SCHWARZ | FSV 40-N | 101329 | 2020/07/07 | 2021/07/06 |
| Bluetooth Tester | ROHDE & SCHWARZ | CBT | 101133 | 2020/04/07 | 2021/04/06 |
| CAX Signal Analyzer | KEYSIGHT | N9000B | MY57100339 | 2019/11/25 | 2020/11/24 |
| Attenuator | KEYSIGHT | 8491B | MY39250703 | 2020/04/17 | 2021/04/16 |
| TEMP & HUMI CHAMBER | T-MACHINE | TMJ-9712 | T-12-040111 | 2019/08/28 | 2020/08/27 |
| Power Meter | Anritsu | ML2495A | 1224005 | 2020/04/17 | 2021/04/16 |
| Power Sensor | Anritsu | MA2411B | 1207295 | 2020/04/17 | 2021/04/16 |
| Spectrum Analyzer | ROHDE & SCHWARZ | FSV 40-N | 101329 | 2020/07/07 | 2021/07/06 |



| | | | | | |
|--------------------------------------|----------------------------------|-----------------|------------------|-------------------------|-------------------|
| Test Item | AC Power Line Conducted Emission | | | | |
| Test Site | CON01-NK | | | | |
| Instrument | Manufacturer | Model No | Serial No | Calibration Date | Valid Date |
| EMI Receiver | ROHDE & SCHWARZ | ESCI | 100821 | 2019/09/16 | 2020/09/15 |
| Line Impedance Stabilization Network | Schwarzbeck | NSLK 8127 | 8127-516 | 2019/09/19 | 2020/09/18 |
| Pulse Limiter | ROHDE & SCHWARZ | ESH3-Z2 | 101933 | 2019/09/11 | 2020/09/10 |
| Cable-6m(9k~300M) | NA | EMC5D-BM-BM-6 | 130605 | 2019/09/11 | 2020/09/10 |
| E3 | AUDIX | v8.2014-8-6 | RK-000531 | NA | NA |



4. Antenna Requirements

4.1 Standard Applicable

For intentional device, according to FCC 47 CFR Section 15.203, an intentional radiator shall be designed to ensure that no antenna other than that furnished by the responsible party shall be used with the device.

And according to FCC 47 CFR Section 15.247 (b), if transmitting antennas of directional gain greater than 6dBi are used, the power shall be reduced by the amount in dB that the directional gain of the antenna exceeds 6dBi.

4.2 Antenna Construction and Directional Gain

| | |
|--------------|------------------|
| Antenna Type | Internal Antenna |
| Antenna Gain | 0 dBi |



5. Test of AC Power Line Conducted Emission

The power supply is DC source, so this item doesn't require testing.

5.1 Test Limit

Conducted Emissions were measured from 150 kHz to 30 MHz with a bandwidth of 9 KHz, according to the methods defined in ANSI C63.4-2014. The EUT was placed on a nonmetallic stand in a shielded room 0.8 meters above the ground plane. The interface cables and equipment positioning were varied within limits of reasonable applications to determine the position produced maximum conducted emissions.

| Frequency (MHz) | Quasi Peak (dB μ V) | Average (dB μ V) |
|-----------------|-------------------------|----------------------|
| 0.15 – 0.5 | 66-56* | 56-46* |
| 0.5 – 5.0 | 56 | 46 |
| 5.0 – 30.0 | 60 | 50 |

*Decreases with the logarithm of the frequency.

5.2 Test Procedures

- a. The EUT was placed 0.4 meter from the conducting wall of the shielding room was kept at least 80 centimeters from any other grounded conducting surface.
- b. Connect EUT to the power mains through a line impedance stabilization network (LISN).
- c. All the support units are connecting to the other LISN.
- d. The LISN provides 50 ohm coupling impedance for the measuring instrument.
- e. The FCC states that a 50 ohm, 50 micro-Henry LISN should be used.
- f. Both sides of AC line were checked for maximum conducted interference.
- g. The frequency range from 150 kHz to 30 MHz was searched.
- h. Set the test-receiver system to Peak Detect Function and Specified Bandwidth with Maximum Hold Mode.



5.3 Typical Test Setup

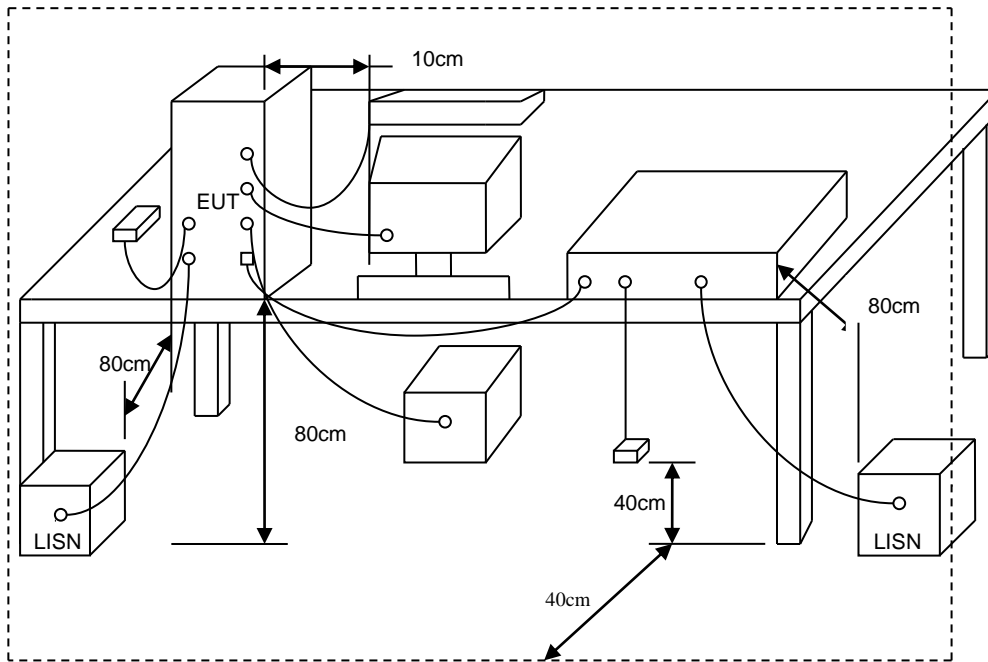



5.4 Test Result and Data

| | | | |
|-----------|------------------|-----------|--------|
| Power | : AC 120V / 60HZ | Pol/Phase | : LINE |
| Test Mode | : Mode 1 | | : |

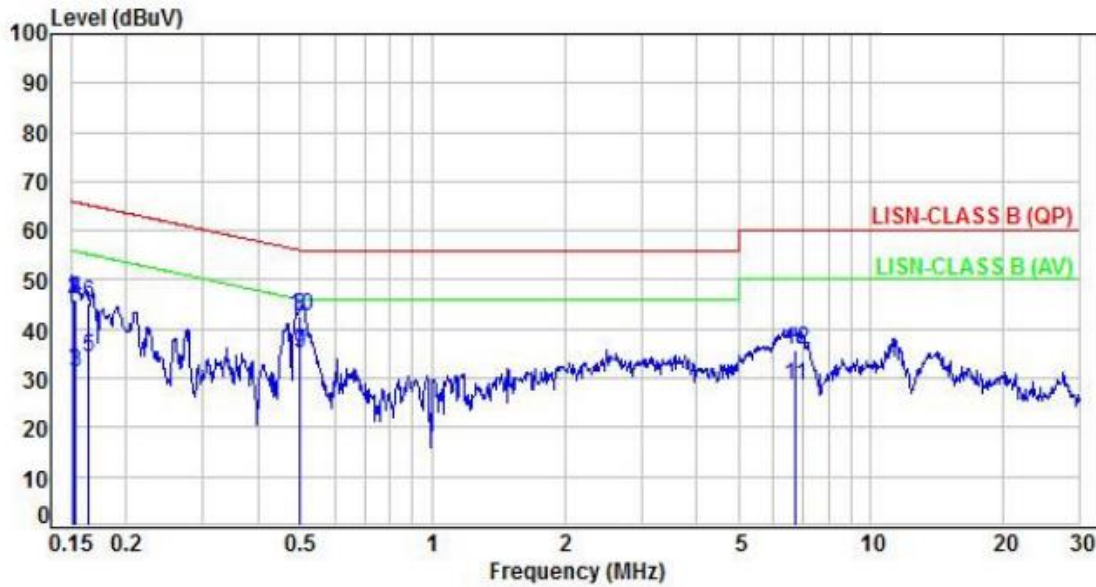

| No. | Frequency (MHz) | Factor (dB) | Reading (dBuV) | Level (dBuV) | Limit (dBuV) | Margin (dB) | Detector | P/F |
|-----|-----------------|-------------|----------------|--------------|--------------|-------------|----------|-----|
| 1 | 0.15 | 9.92 | 22.16 | 32.08 | 55.89 | -23.81 | Average | P |
| 2 | 0.15 | 9.92 | 36.01 | 45.93 | 65.89 | -19.96 | QP | P |
| 3 | 0.15 | 9.92 | 21.40 | 31.32 | 55.83 | -24.51 | Average | P |
| 4 | 0.15 | 9.92 | 35.96 | 45.88 | 65.83 | -19.95 | QP | P |
| 5 | 0.16 | 9.92 | 24.26 | 34.18 | 55.27 | -21.09 | Average | P |
| 6 | 0.16 | 9.92 | 35.24 | 45.16 | 65.27 | -20.11 | QP | P |
| 7 | 0.50 | 9.94 | 25.32 | 35.26 | 46.00 | -10.74 | Average | P |
| 8 | 0.50 | 9.94 | 32.60 | 42.54 | 56.00 | -13.46 | QP | P |
| 9 | 0.50 | 9.94 | 25.14 | 35.08 | 46.00 | -10.92 | Average | P |
| 10 | 0.50 | 9.94 | 32.56 | 42.50 | 56.00 | -13.50 | QP | P |
| 11 | 6.72 | 10.20 | 18.48 | 28.68 | 50.00 | -21.32 | Average | P |
| 12 | 6.72 | 10.20 | 25.70 | 35.90 | 60.00 | -24.10 | QP | P |

Note: Level=Reading+Factor
 Margin=Level-limit
 Factor=(LISN or ISN or Current Probe)Factor + Cable Loss



| | | | |
|-----------|------------------|-----------|-----------|
| Power | : AC 120V / 60HZ | Pol/Phase | : NEUTRAL |
| Test Mode | : Mode 1 | | : |

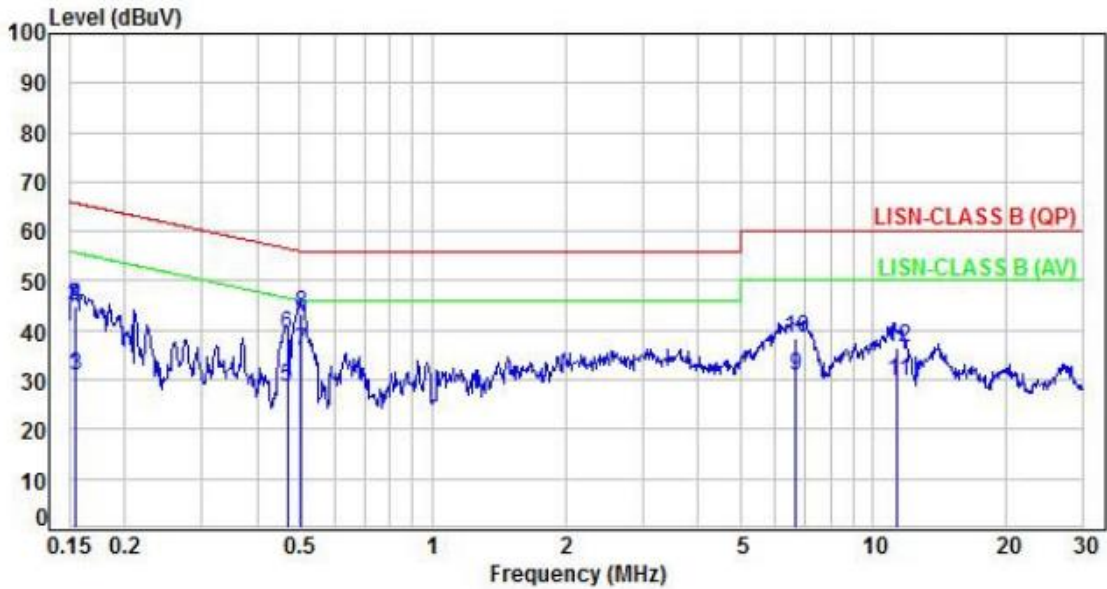

| No. | Frequency (MHz) | Factor (dB) | Reading (dBUV) | Level (dBUV) | Limit (dBUV) | Margin (dB) | Detector | P/F |
|-----|-----------------|-------------|----------------|--------------|--------------|-------------|----------|-----|
| 1 | 0.15 | 9.95 | 20.87 | 30.82 | 55.78 | -24.96 | Average | P |
| 2 | 0.15 | 9.95 | 35.10 | 45.05 | 65.78 | -20.73 | QP | P |
| 3 | 0.16 | 9.95 | 20.84 | 30.79 | 55.72 | -24.93 | Average | P |
| 4 | 0.16 | 9.95 | 34.94 | 44.89 | 65.72 | -20.83 | QP | P |
| 5 | 0.47 | 9.96 | 18.42 | 28.38 | 46.56 | -18.18 | Average | P |
| 6 | 0.47 | 9.96 | 29.11 | 39.07 | 56.56 | -17.49 | QP | P |
| 7 | 0.50 | 9.96 | 25.72 | 35.68 | 46.00 | -10.32 | Average | P |
| 8 | 0.50 | 9.96 | 33.50 | 43.46 | 56.00 | -12.54 | QP | P |
| 9 | 6.65 | 10.22 | 20.46 | 30.68 | 50.00 | -19.32 | Average | P |
| 10 | 6.65 | 10.22 | 28.18 | 38.40 | 60.00 | -21.60 | QP | P |
| 11 | 11.37 | 10.36 | 19.40 | 29.76 | 50.00 | -20.24 | Average | P |
| 12 | 11.37 | 10.36 | 25.98 | 36.34 | 60.00 | -23.66 | QP | P |

Note: Level=Reading+Factor
 Margin=Level-Limit
 Factor=(LISN or ISN or Current Probe)Factor + Cable Loss



6. Test of Spurious Emission (Radiated)

6.1 Test Limit

In any 100kHz bandwidth outside the frequency band in which the spread spectrum or digitally modulated intentional radiator is operating, the radio frequency power that is produced by the intentional radiator shall be at least 20dB below that in the 100kHz bandwidth within the band that contains the highest level of the desired power, based on either an RF conducted or a radiated measurement. If the transmitter measurement is based on the maximum conducted output power, the attenuation required under this paragraph shall be 30dB instead of 20dB. In addition, radiated emissions which fall in section 15.205(a) the restricted bands must also comply with the radiated emission limit specified in section 15.209(a).

| Frequency (MHz) | Field Strength (microvolt/meter) | Measurement Distance (meters) |
|-----------------|----------------------------------|-------------------------------|
| 0.009 ~ 0.490 | 2400/F(kHz) | 300 |
| 0.490 ~ 1.705 | 24000/F(kHz) | 30 |
| 1.705 ~ 30.0 | 30 | 30 |
| 30 ~ 88 | 100 | 3 |
| 88 ~ 216 | 150 | 3 |
| 216 ~ 960 | 200 | 3 |
| Above 960 | 500 | 3 |

6.2 Test Procedures

- a. The EUT was placed on a rotatable table top 0.8 meter above ground.
- b. The EUT was set 3 meters from the interference receiving antenna which was mounted on the top of a variable height antenna tower.
- c. The table was rotated 360 degrees to determine the position of the highest radiation.
- d. The antenna is a broadband antenna and its height is varied between one meter and four meters above ground to find the maximum value of the field strength both horizontal polarization and vertical polarization of the antenna are set to make the measurement.
- e. For each suspected emission the EUT was arranged to its worst case and then tune the antenna tower (from 1 M to 4 M) and turn table (from 0 degree to 360 degrees) to find the maximum reading.
- f. Set the test-receiver system to Peak or CISPR quasi-peak Detect Function and specified bandwidth with Maximum Hold Mode.
- g. If the emission level of the EUT in peak mode was 3 dB lower than the limit specified, then testing will be stopped and peak values of EUT will be reported, otherwise, the emissions which do not have 3 dB margin will be repeated one by one using the quasi-peak method and reported.
- h. For testing above 1GHz, the emission level of the EUT in peak mode was 20dB lower than average limit (that means the emission level in peak mode also complies with the limit in average mode), then testing will be stopped and peak values of EUT will be reported, otherwise, the emissions will be measured in average mode again and reported.
- i. "Cone of radiation" has been considered to be 3dB bandwidth of the measurement antenna.



6.3 Typical Test Setup

Below 30MHz test setup

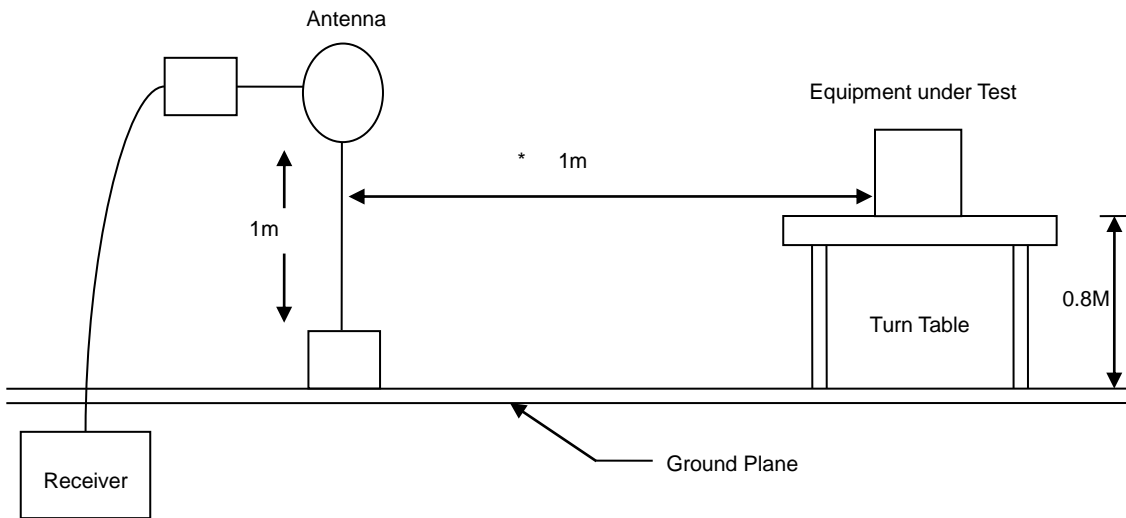

30MHz- 1GHz Test Setup

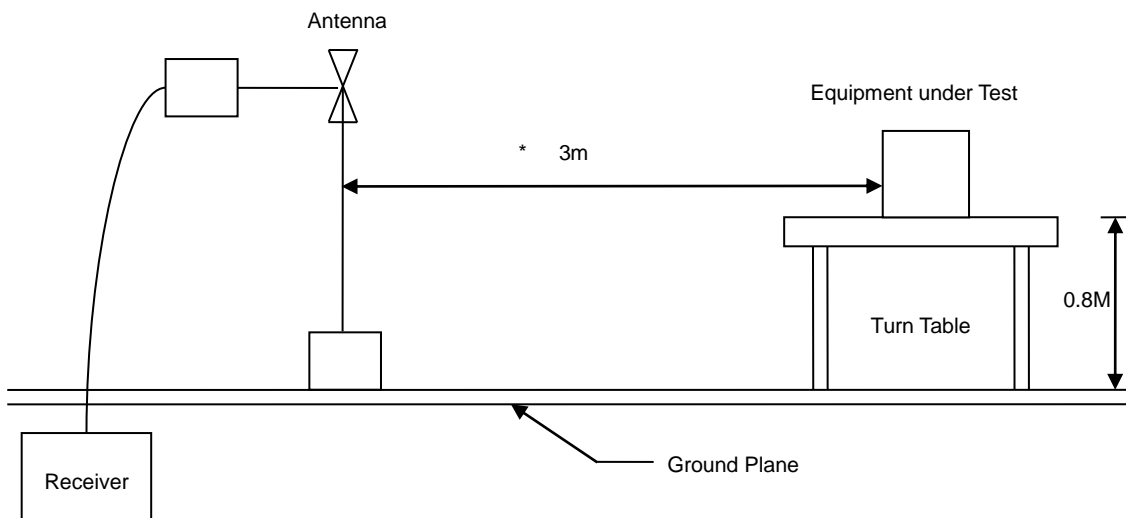

Above 1GHz Test Setup

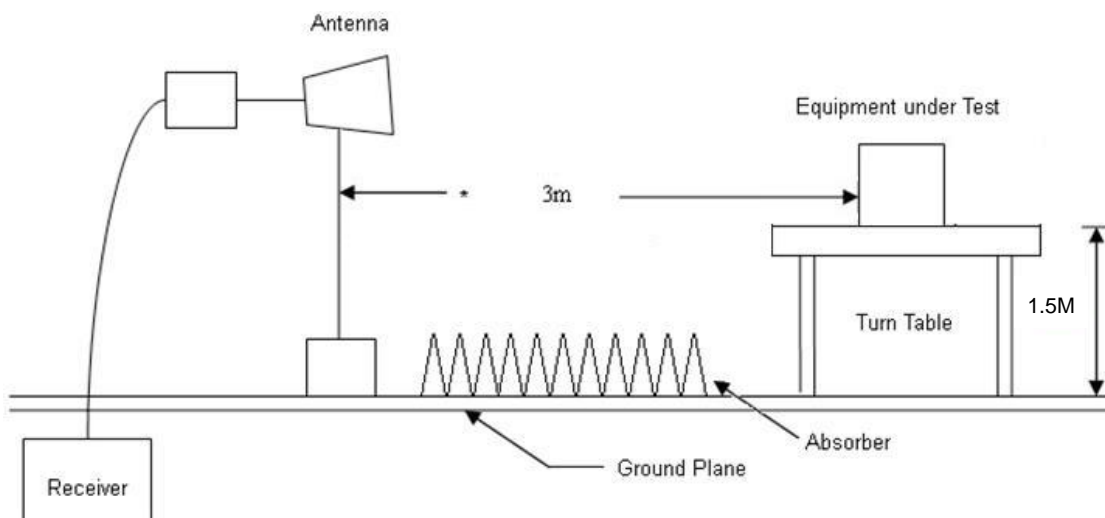



6.4 Test Result and Data (9kHz ~ 30MHz)

The 9kHz - 30MHz spurious emission is under limit 20dB more.

6.5 Test Result and Data (30MHz ~ 1GHz)

| | | | |
|-----------|------------------|-----------|------------|
| Power | : AC 120V / 60HZ | Pol/Phase | : VERTICAL |
| Test Mode | : Mode 1 | | : |

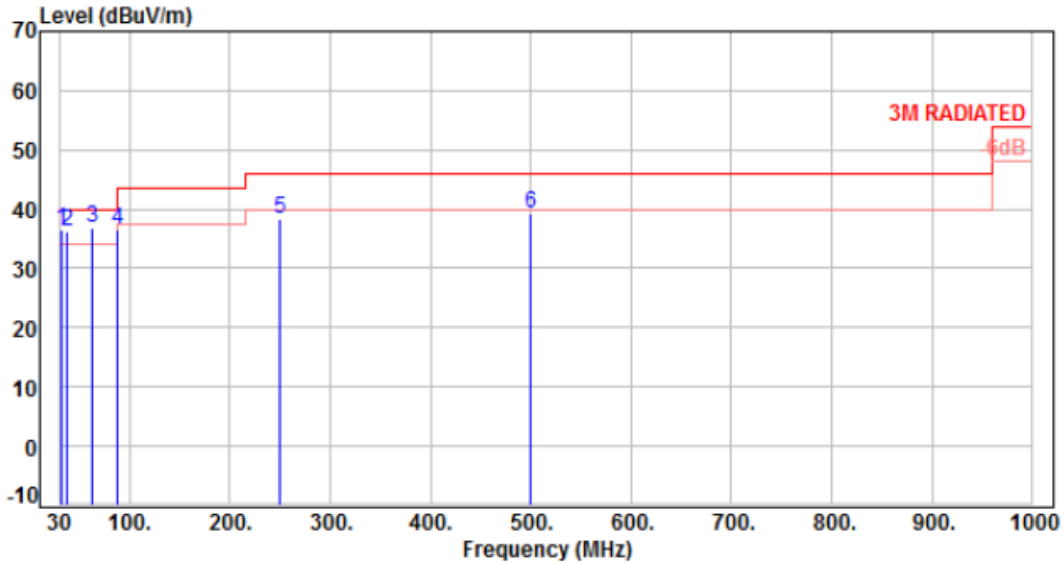

| No. | Frequency (MHz) | Factor (dB) | Reading (dBuV) | Level (dBuV/m) | Limit (dBuV/m) | Margin (dB) | Detector | Height (cm) | Azimuth (deg) | P/F |
|-----|-----------------|-------------|----------------|----------------|----------------|-------------|----------|-------------|---------------|-----|
| 1 | 31.60 | -10.50 | 46.90 | 36.40 | 40.00 | -3.60 | QP | 100 | 360 | P |
| 2 | 38.31 | -10.10 | 46.30 | 36.20 | 40.00 | -3.80 | QP | 100 | 320 | P |
| 3 | 62.01 | -10.14 | 46.85 | 36.71 | 40.00 | -3.29 | Peak | 400 | 0 | P |
| 4 | 88.20 | -15.24 | 51.75 | 36.51 | 43.50 | -6.99 | Peak | 400 | 0 | P |
| 5 | 250.19 | -10.41 | 48.92 | 38.51 | 46.00 | -7.49 | Peak | 400 | 0 | P |
| 6 | 500.45 | -3.90 | 43.07 | 39.17 | 46.00 | -6.83 | Peak | 400 | 0 | P |

Note: Level=Reading+Factor
 Margin=Level-Limit
 Factor=Antenna Factor + cable loss - Amplifier Factor



| | | | |
|-----------|------------------|-----------|--------------|
| Power | : AC 120V / 60HZ | Pol/Phase | : HORIZONTAL |
| Test Mode | : Mode 1 | | : |

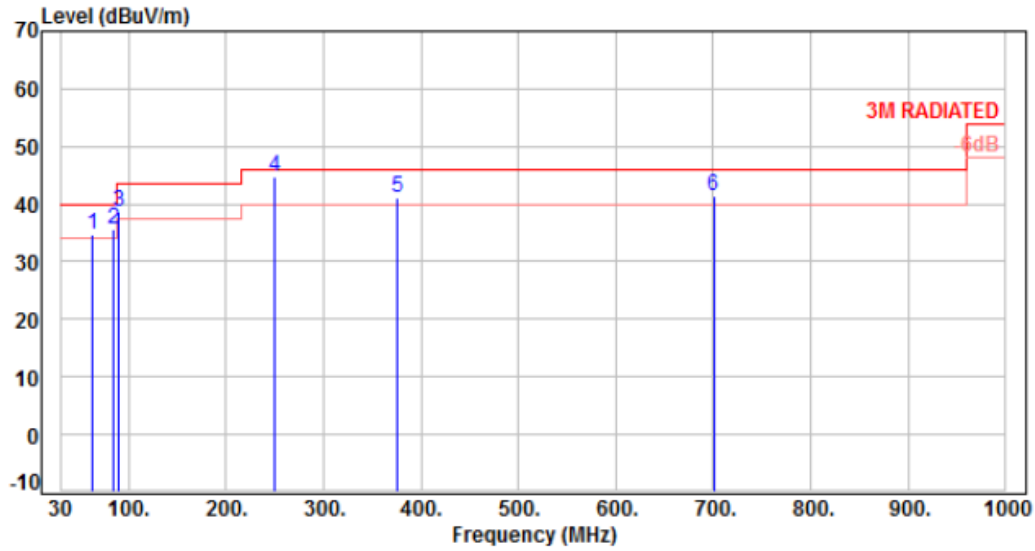

| No. | Frequency (MHz) | Factor (dB) | Reading (dBuV) | Level (dBuV/m) | Limit (dBuV/m) | Margin (dB) | Detector | Height (cm) | Azimuth (deg) | P/F |
|-----|-----------------|-------------|----------------|----------------|----------------|-------------|----------|-------------|---------------|-----|
| 1 | 62.01 | -10.14 | 44.91 | 34.77 | 40.00 | -5.23 | Peak | 400 | 0 | P |
| 2 | 84.32 | -14.66 | 50.30 | 35.64 | 40.00 | -4.36 | QP | 200 | 75 | P |
| 3 | 89.17 | -15.33 | 54.00 | 38.67 | 43.50 | -4.83 | Peak | 400 | 0 | P |
| 4 | 250.02 | -10.41 | 55.30 | 44.89 | 46.00 | -1.11 | QP | 100 | 165 | P |
| 5 | 375.32 | -6.51 | 47.52 | 41.01 | 46.00 | -4.99 | Peak | 400 | 0 | P |
| 6 | 700.27 | -0.28 | 41.78 | 41.50 | 46.00 | -4.50 | Peak | 400 | 0 | P |

Note: Level=Reading+Factor
 Margin=Level-Limit
 Factor=Antenna Factor + cable loss - Amplifier Factor



6.6 Test Result and Data (1GHz ~ 25GHz)

| | | | |
|-----------|------------------|-----------|------------|
| Power | : AC 120V / 60HZ | Pol/Phase | : VERTICAL |
| Test Mode | : Mode 1, CH00 | | |

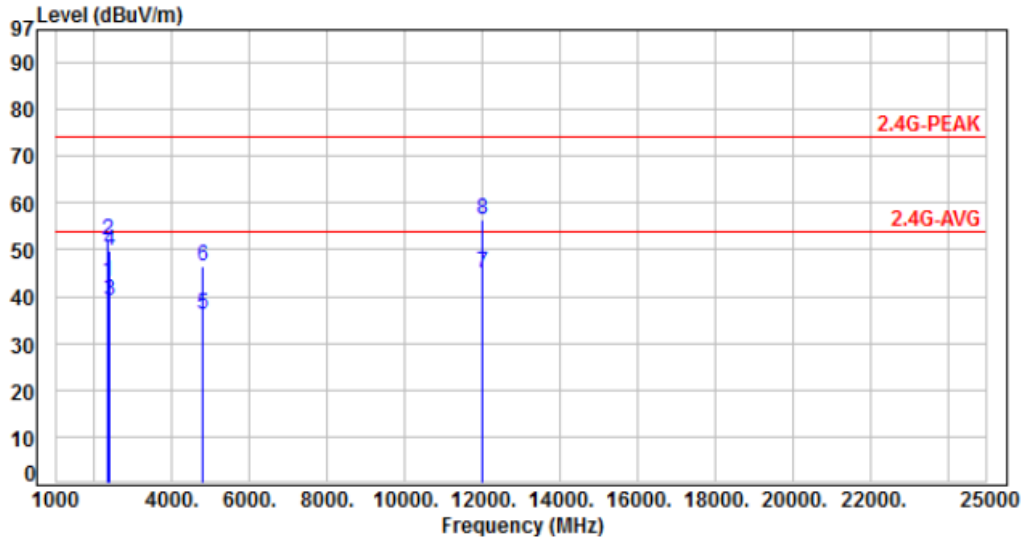

| No. | Frequency (MHz) | Factor (dB) | Reading (dBuV) | Level (dBuV/m) | Limit (dBuV/m) | Margin (dB) | Detector | Height (cm) | Azimuth (deg) | P/F |
|-----|-----------------|-------------|----------------|----------------|----------------|-------------|----------|-------------|---------------|-----|
| 1 | 2337.00 | -3.01 | 46.00 | 42.99 | 54.00 | -11.01 | Average | 277 | 0 | P |
| 2 | 2337.00 | -3.01 | 55.05 | 52.04 | 74.00 | -21.96 | Peak | 277 | 0 | P |
| 3 | 2390.00 | -2.89 | 41.81 | 38.92 | 54.00 | -15.08 | Average | 277 | 0 | P |
| 4 | 2390.00 | -2.89 | 52.70 | 49.81 | 74.00 | -24.19 | Peak | 277 | 0 | P |
| 5 | 4804.00 | 4.78 | 31.29 | 36.07 | 54.00 | -17.93 | Average | 100 | 241 | P |
| 6 | 4804.00 | 4.78 | 41.66 | 46.44 | 74.00 | -27.56 | Peak | 100 | 241 | P |
| 7 | 12010.00 | 14.85 | 30.08 | 44.93 | 54.00 | -9.07 | Average | 100 | 186 | P |
| 8 | 12010.00 | 14.85 | 41.56 | 56.41 | 74.00 | -17.59 | Peak | 100 | 186 | P |

Note: Level=Reading+Factor
 Margin=Level-Limit
 Factor=Antenna Factor + cable loss - Amplifier Factor



| | | | |
|-----------|------------------|-----------|--------------|
| Power | : AC 120V / 60HZ | Pol/Phase | : HORIZONTAL |
| Test Mode | : Mode 1, CH00 | | : |

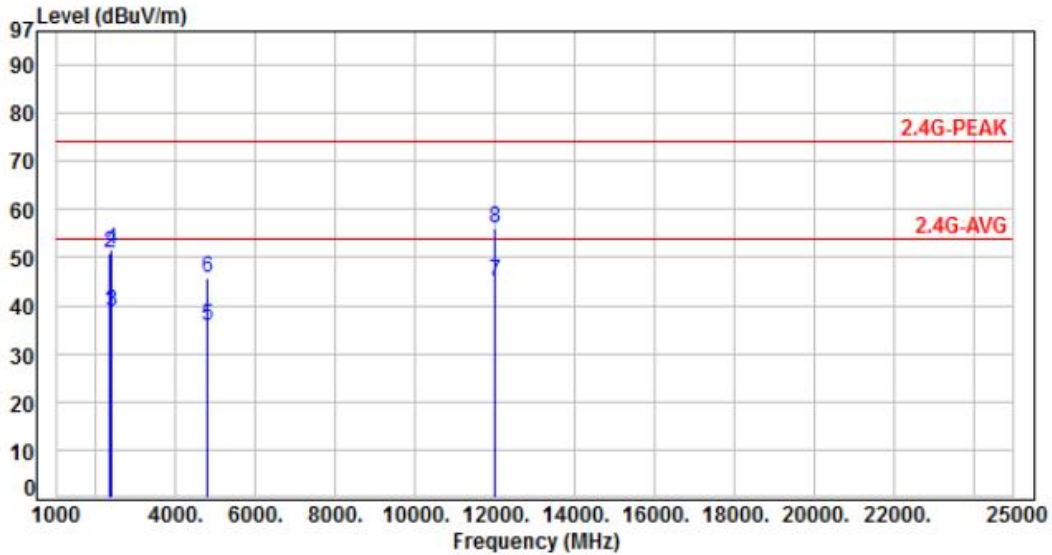

| No. | Frequency (MHz) | Factor (dB) | Reading (dBuV) | Level (dBuV/m) | Limit (dBuV/m) | Margin (dB) | Detector | Height (cm) | Azimuth (deg) | P/F |
|-----|-----------------|-------------|----------------|----------------|----------------|-------------|----------|-------------|---------------|-----|
| 1 | 2337.00 | -3.01 | 41.75 | 38.74 | 54.00 | -15.26 | Average | 343 | 248 | P |
| 2 | 2337.00 | -3.01 | 54.05 | 51.04 | 74.00 | -22.96 | Peak | 343 | 248 | P |
| 3 | 2390.00 | -2.89 | 41.79 | 38.90 | 54.00 | -15.10 | Average | 343 | 248 | P |
| 4 | 2390.00 | -2.89 | 54.58 | 51.69 | 74.00 | -22.31 | Peak | 343 | 248 | P |
| 5 | 4804.00 | 4.78 | 31.14 | 35.92 | 54.00 | -18.08 | Average | 100 | 252 | P |
| 6 | 4804.00 | 4.78 | 40.84 | 45.62 | 74.00 | -28.38 | Peak | 100 | 252 | P |
| 7 | 12010.00 | 14.85 | 30.18 | 45.03 | 54.00 | -8.97 | Average | 100 | 210 | P |
| 8 | 12010.00 | 14.85 | 41.13 | 55.98 | 74.00 | -18.02 | Peak | 100 | 210 | P |

Note: Level=Reading+Factor
 Margin=Level-Limit
 Factor=Antenna Factor + cable loss - Amplifier Factor



| | | | |
|-----------|------------------|-----------|------------|
| Power | : AC 120V / 60HZ | Pol/Phase | : VERTICAL |
| Test Mode | : Mode 1, CH19 | | : |

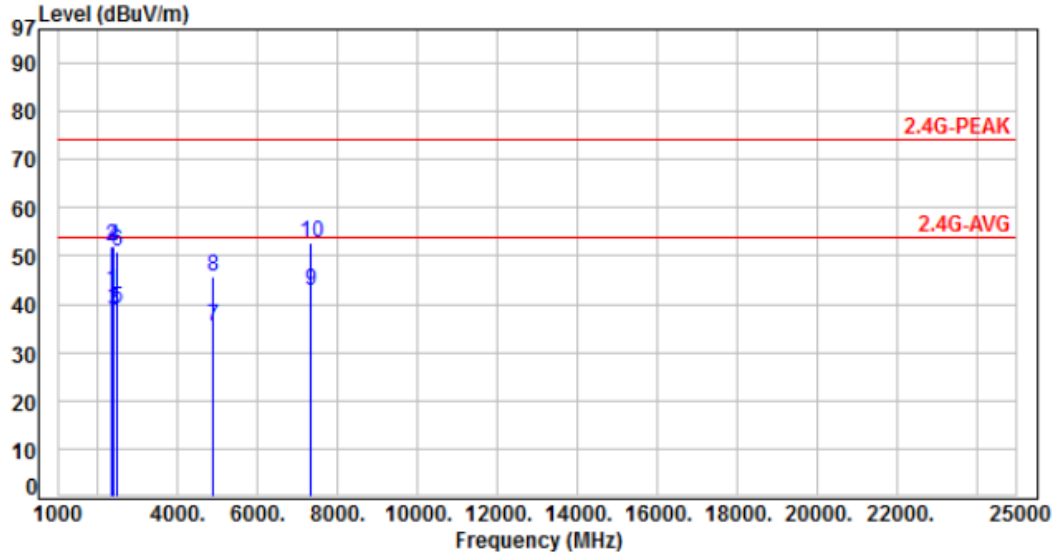

| No. | Frequency (MHz) | Factor (dB) | Reading (dBuV) | Level (dBuV/m) | Limit (dBuV/m) | Margin (dB) | Detector | Height (cm) | Azimuth (deg) | P/F |
|-----|-----------------|-------------|----------------|----------------|----------------|-------------|----------|-------------|---------------|-----|
| 1 | 2337.00 | -3.01 | 45.97 | 42.96 | 54.00 | -11.04 | Average | 278 | 0 | P |
| 2 | 2337.00 | -3.01 | 55.08 | 52.07 | 74.00 | -21.93 | Peak | 278 | 0 | P |
| 3 | 2390.00 | -2.89 | 41.65 | 38.76 | 54.00 | -15.24 | Average | 278 | 0 | P |
| 4 | 2390.00 | -2.89 | 54.83 | 51.94 | 74.00 | -22.06 | Peak | 278 | 0 | P |
| 5 | 2483.50 | -2.69 | 41.69 | 39.00 | 54.00 | -15.00 | Average | 278 | 0 | P |
| 6 | 2483.50 | -2.69 | 53.76 | 51.07 | 74.00 | -22.93 | Peak | 278 | 0 | P |
| 7 | 4880.00 | 5.10 | 30.14 | 35.24 | 54.00 | -18.76 | Average | 100 | 240 | P |
| 8 | 4880.00 | 5.10 | 40.57 | 45.67 | 74.00 | -28.33 | Peak | 100 | 240 | P |
| 9 | 7320.00 | 10.04 | 32.66 | 42.70 | 54.00 | -11.30 | Average | 173 | 48 | P |
| 10 | 7320.00 | 10.04 | 42.60 | 52.64 | 74.00 | -21.36 | Peak | 173 | 48 | P |

Note: Level=Reading+Factor
 Margin=Level-Limit
 Factor=Antenna Factor + cable loss - Amplifier Factor



| | | | |
|-----------|------------------|-----------|--------------|
| Power | : AC 120V / 60HZ | Pol/Phase | : HORIZONTAL |
| Test Mode | : Mode 1, CH19 | | : |

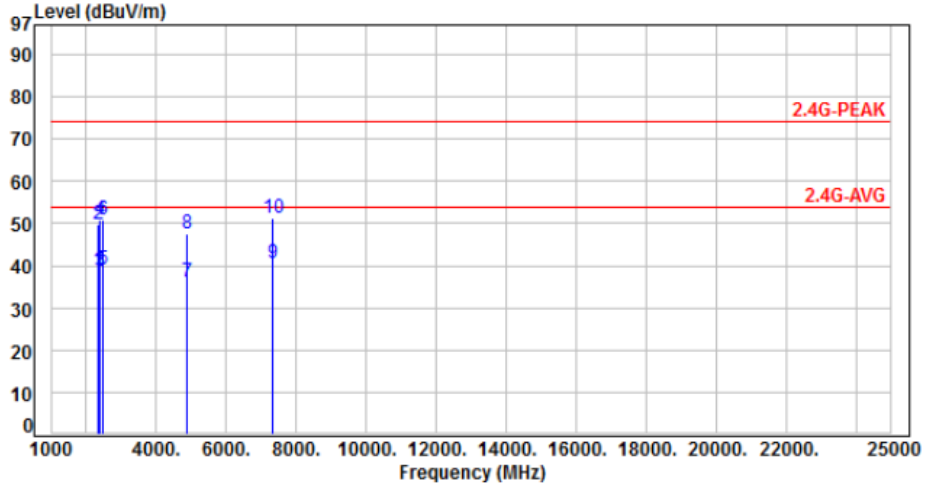

| No. | Frequency (MHz) | Factor (dB) | Reading (dBuV) | Level (dBuV/m) | Limit (dBuV/m) | Margin (dB) | Detector | Height (cm) | Azimuth (deg) | P/F |
|-----|-----------------|-------------|----------------|----------------|----------------|-------------|----------|-------------|---------------|-----|
| 1 | 2337.00 | -3.01 | 41.58 | 38.57 | 54.00 | -15.43 | Average | 342 | 242 | P |
| 2 | 2337.00 | -3.01 | 52.68 | 49.67 | 74.00 | -24.33 | Peak | 342 | 242 | P |
| 3 | 2390.00 | -2.89 | 41.56 | 38.67 | 54.00 | -15.33 | Average | 342 | 242 | P |
| 4 | 2390.00 | -2.89 | 53.66 | 50.77 | 74.00 | -23.23 | Peak | 342 | 242 | P |
| 5 | 2483.50 | -2.69 | 41.60 | 38.91 | 54.00 | -15.09 | Average | 342 | 242 | P |
| 6 | 2483.50 | -2.69 | 53.66 | 50.97 | 74.00 | -23.03 | Peak | 342 | 242 | P |
| 7 | 4880.00 | 5.10 | 30.99 | 36.09 | 54.00 | -17.91 | Average | 100 | 253 | P |
| 8 | 4880.00 | 5.10 | 42.44 | 47.54 | 74.00 | -26.46 | Peak | 100 | 253 | P |
| 9 | 7320.00 | 10.04 | 30.60 | 40.64 | 54.00 | -13.36 | Average | 100 | 350 | P |
| 10 | 7320.00 | 10.04 | 41.25 | 51.29 | 74.00 | -22.71 | Peak | 100 | 350 | P |

Note: Level=Reading+Factor
 Margin=Level-Limit
 Factor=Antenna Factor + cable loss - Amplifier Factor



| | | | |
|-----------|------------------|-----------|------------|
| Power | : AC 120V / 60HZ | Pol/Phase | : VERTICAL |
| Test Mode | : Mode 1, CH39 | | : |

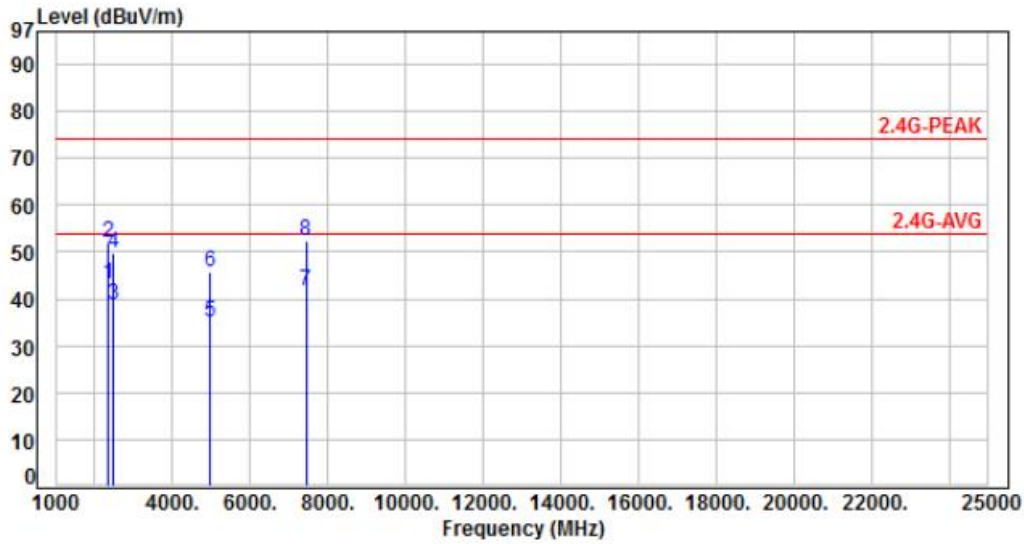

| No. | Frequency (MHz) | Factor (dB) | Reading (dBuV) | Level (dBuV/m) | Limit (dBuV/m) | Margin (dB) | Detector | Height (cm) | Azimuth (deg) | P/F |
|-----|-----------------|-------------|----------------|----------------|----------------|-------------|----------|-------------|---------------|-----|
| 1 | 2337.00 | -3.01 | 46.20 | 43.19 | 54.00 | -10.81 | Average | 277 | 0 | P |
| 2 | 2337.00 | -3.01 | 54.92 | 51.91 | 74.00 | -22.09 | Peak | 277 | 0 | P |
| 3 | 2483.50 | -2.69 | 41.57 | 38.88 | 54.00 | -15.12 | Average | 277 | 0 | P |
| 4 | 2483.50 | -2.69 | 52.53 | 49.84 | 74.00 | -24.16 | Peak | 277 | 0 | P |
| 5 | 4960.00 | 5.46 | 29.72 | 35.18 | 54.00 | -18.82 | Average | 100 | 252 | P |
| 6 | 4960.00 | 5.46 | 40.26 | 45.72 | 74.00 | -28.28 | Peak | 100 | 252 | P |
| 7 | 7440.00 | 10.16 | 31.48 | 41.64 | 54.00 | -12.36 | Average | 186 | 38 | P |
| 8 | 7440.00 | 10.16 | 42.36 | 52.52 | 74.00 | -21.48 | Peak | 186 | 38 | P |

Note: Level=Reading+Factor
 Margin=Level-Limit
 Factor=Antenna Factor + cable loss - Amplifier Factor



| | | | |
|-----------|------------------|-----------|--------------|
| Power | : AC 120V / 60HZ | Pol/Phase | : HORIZONTAL |
| Test Mode | : Mode 1, CH39 | | : |

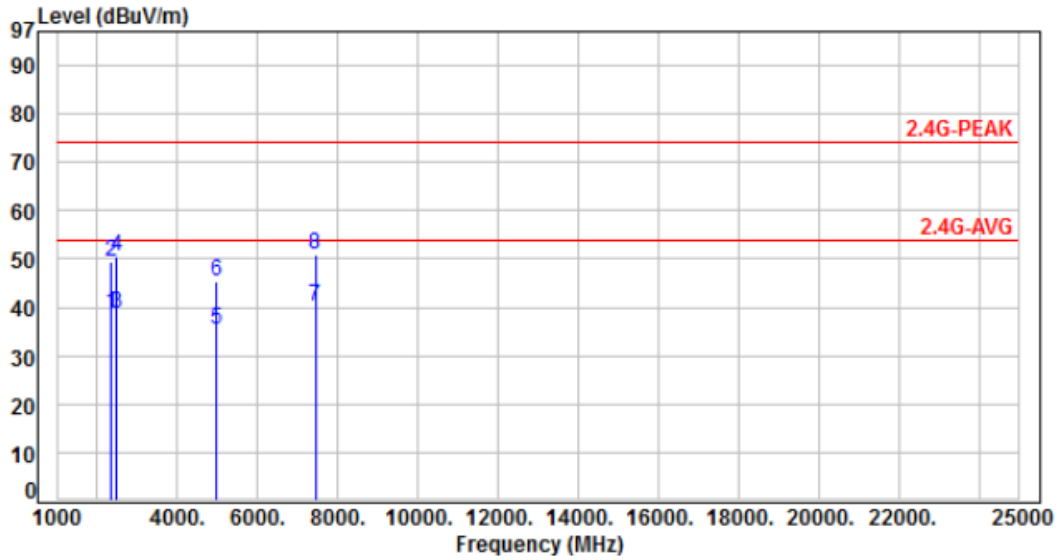

| No. | Frequency (MHz) | Factor (dB) | Reading (dBuV) | Level (dBuV/m) | Limit (dBuV/m) | Margin (dB) | Detector | Height (cm) | Azimuth (deg) | P/F |
|-----|-----------------|-------------|----------------|----------------|----------------|-------------|----------|-------------|---------------|-----|
| 1 | 2337.00 | -3.01 | 41.81 | 38.80 | 54.00 | -15.20 | Average | 345 | 244 | P |
| 2 | 2337.00 | -3.01 | 52.52 | 49.51 | 74.00 | -24.49 | Peak | 345 | 244 | P |
| 3 | 2483.50 | -2.69 | 41.56 | 38.87 | 54.00 | -15.13 | Average | 345 | 244 | P |
| 4 | 2483.50 | -2.69 | 53.08 | 50.39 | 74.00 | -23.61 | Peak | 345 | 244 | P |
| 5 | 4960.00 | 5.46 | 30.13 | 35.59 | 54.00 | -18.41 | Average | 100 | 257 | P |
| 6 | 4960.00 | 5.46 | 40.05 | 45.51 | 74.00 | -28.49 | Peak | 100 | 257 | P |
| 7 | 7440.00 | 10.16 | 30.18 | 40.34 | 54.00 | -13.66 | Average | 100 | 353 | P |
| 8 | 7440.00 | 10.16 | 40.75 | 50.91 | 74.00 | -23.09 | Peak | 100 | 353 | P |

Note: Level=Reading+Factor
Margin=Level-Limit
Factor=Antenna Factor + cable loss - Amplifier Factor



6.7 Restricted Bands of Operation

Only spurious emissions are permitted in any of the frequency bands listed below:

| MHz | MHz | MHz | GHz |
|---------------------|-----------------------|-----------------|-----------------|
| 0.09000 – 0.11000 | 16.42000 – 16.42300 | 399.9 – 410.0 | 4.500 – 5.250 |
| 0.49500 – 0.505** | 16.69475 – 16.69525 | 608.0 – 614.0 | 5.350 – 5.460 |
| 2.17350 – 2.19050 | 16.80425 – 16.80475 | 960.0 – 1240.0 | 7.250 – 7.750 |
| 4.12500 – 4.12800 | 25.50000 – 25.67000 | 1300.0 – 1427.0 | 8.025 – 8.500 |
| 4.17725 – 4.17775 | 37.50000 – 38.25000 | 1435.0 – 1626.5 | 9.000 – 9.200 |
| 4.20725 – 4.20775 | 73.00000 – 74.60000 | 1645.5 – 1646.5 | 9.300 – 9.500 |
| 6.21500 – 6.21800 | 74.80000 – 75.20000 | 1660.0 – 1710.0 | 10.600 – 12.700 |
| 6.26775 – 6.26825 | 108.00000 – 121.94000 | 1718.8 – 1722.2 | 13.250 – 13.400 |
| 6.31175 – 6.31225 | 123.00000 – 138.00000 | 2200.0 – 2300.0 | 14.470 – 14.500 |
| 8.29100 – 8.29400 | 149.90000 – 150.05000 | 2310.0 – 2390.0 | 15.350 – 16.200 |
| 8.36200 – 8.36600 | 156.52475 – 156.52525 | 2483.5 – 2500.0 | 17.700 – 21.400 |
| 8.37625 – 8.38675 | 156.70000 – 156.90000 | 2655.0 – 2900.0 | 22.010 – 23.120 |
| 8.41425 – 8.41475 | 162.01250 – 167.17000 | 3260.0 – 3267.0 | 23.600 – 24.000 |
| 12.29000 – 12.29300 | 167.72000 – 173.20000 | 3332.0 – 3339.0 | 31.200 – 31.800 |
| 12.51975 – 12.52025 | 240.00000 – 285.00000 | 3345.8 – 3358.0 | 36.430 – 36.500 |
| 12.57675 – 12.57725 | 322.00000 – 335.40000 | 3600.0 – 4400.0 | Above 38.6 |
| 13.36000 – 13.41000 | | | |

** : Until February 1, 1999, this restricted band shall be 0.490-0.510 MHz



7. Test of Spurious Emission (Conducted)

7.1 Test Limit

Below -20dB of the highest emission level of operating band (In 100 kHz Resolution Bandwidth)

7.2 Test Procedure

- a. The transmitter output was connected to the spectrum analyzer via a low loss cable.
- b. Set RBW of spectrum analyzer to 100 KHz and VBW of spectrum analyzer to 300 KHz with convenient frequency span including 100 KHz bandwidth from band edge.
- c. Peak conducted output power measured within any 100 kHz outside the authorized frequency band shall be attenuated by at least 20dB relative to the maximum measured in-band peak PSD level.
- d. The band edges was measured and recorded.

7.3 Test Setup Layout

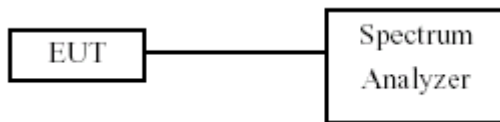

7.4 Test Result and Data

Note: Test plots refer to the following pages.



Modulation Type: GFSK
CH00

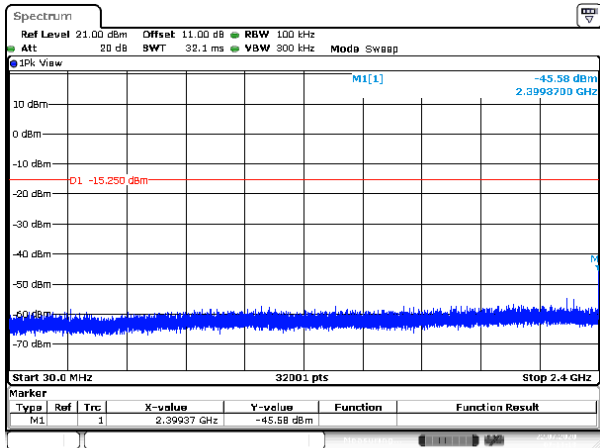

Modulation Type: GFSK
CH19

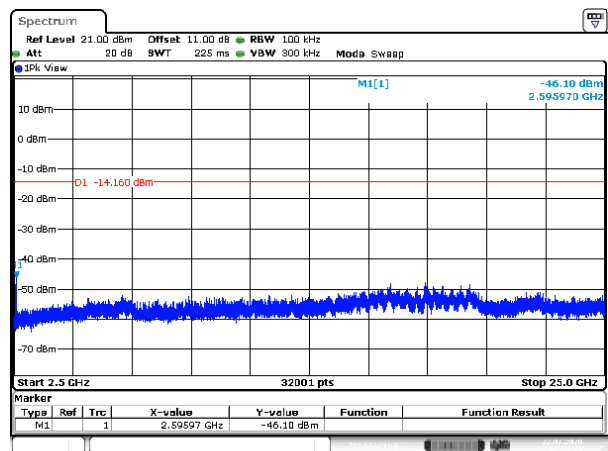
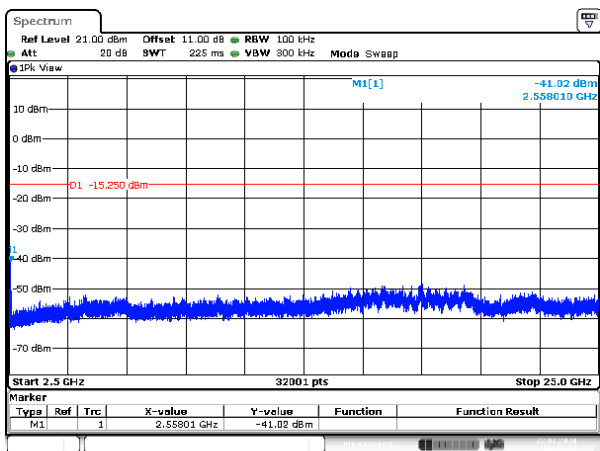
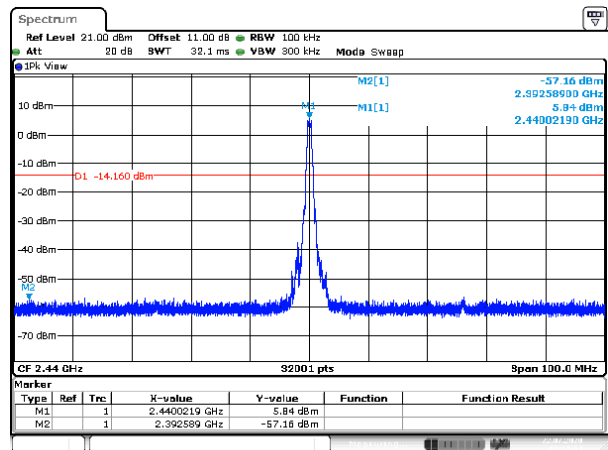
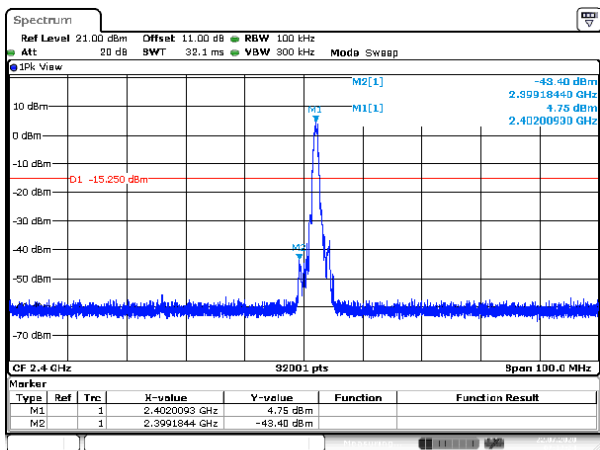
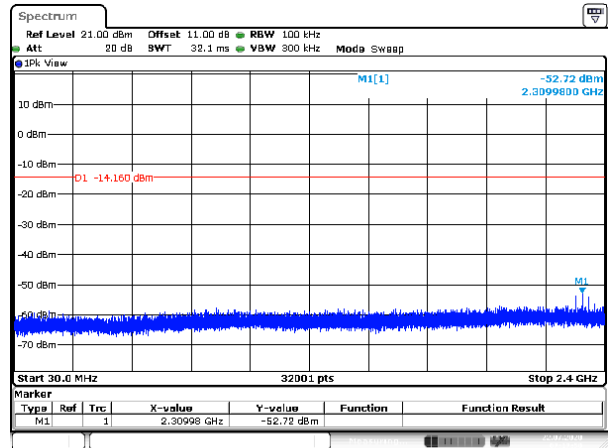



Modulation Type: GFSK
CH39

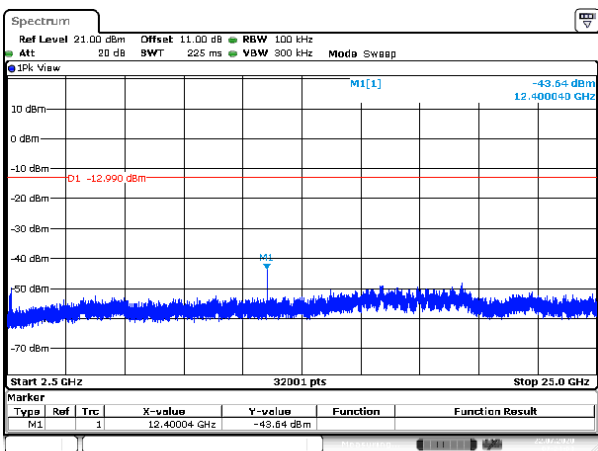
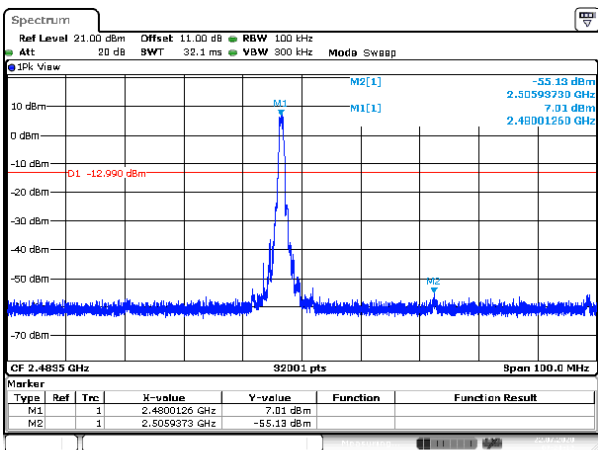
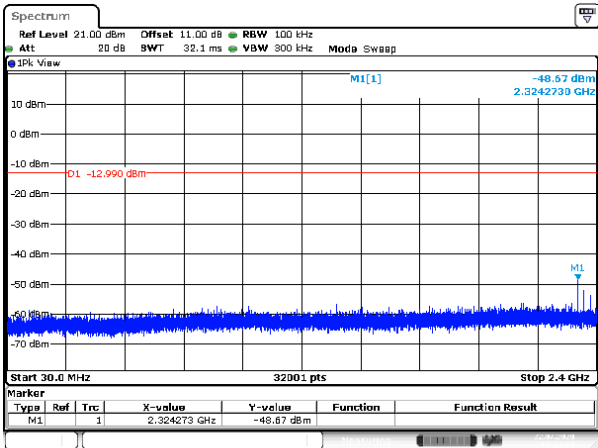



8. On Time, Duty Cycle and Measurement methods

8.1 Test Limit

None; for reporting purposes only.

8.2 Test Procedure

Zero-Span Spectrum Analyzer Method.

8.3 Test Setup Layout

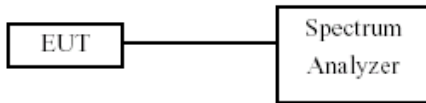

8.4 Test Result and Data

| Modulation Type | On Time (ms) | Period Time (ms) | Duty Cycle (%) |
|-----------------|--------------|------------------|----------------|
| GFSK | 0.44 | 0.66 | 67.40% |



Modulation Type: GFSK

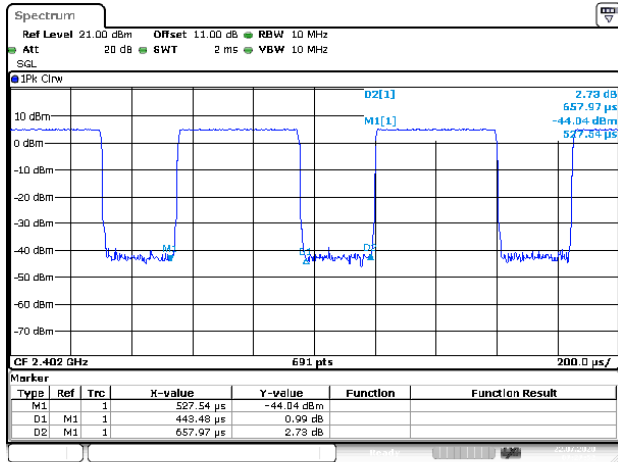



9. 6dB Bandwidth Measurement Data

9.1 Test Limit

The minimum of 6dB Bandwidth Measurement is 0.5 MHz.

9.2 Test Procedures

- a. The transmitter output was connected to the spectrum analyzer.
- b. Set RBW of spectrum analyzer to 100 KHz and VBW to 300 KHz.
- c. The 6 dB bandwidth is defined as the total spectrum the power of which is higher than peak power minus 6 dB.
- d. The 6dB Bandwidth was measured and recorded.

9.3 Test Setup Layout

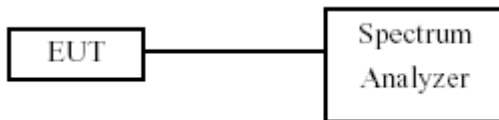

9.4 Test Result and Data

| Modulation Type | Channel | Frequency (MHz) | 6dB Bandwidth (KHz) | Limit (KHz) |
|-----------------|---------|-----------------|---------------------|-------------|
| GFSK | 0 | 2402 | 690.30 | 500 |
| | 19 | 2440 | 707.70 | 500 |
| | 39 | 2480 | 703.30 | 500 |



Modulation Type: GFSK
CH00

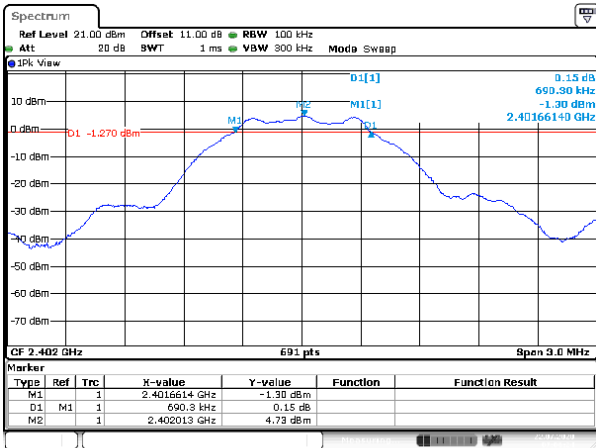

Modulation Type: GFSK
CH19

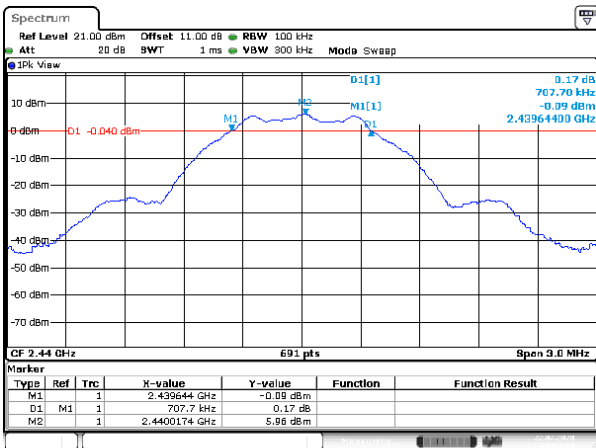

Modulation Type: GFSK
CH39

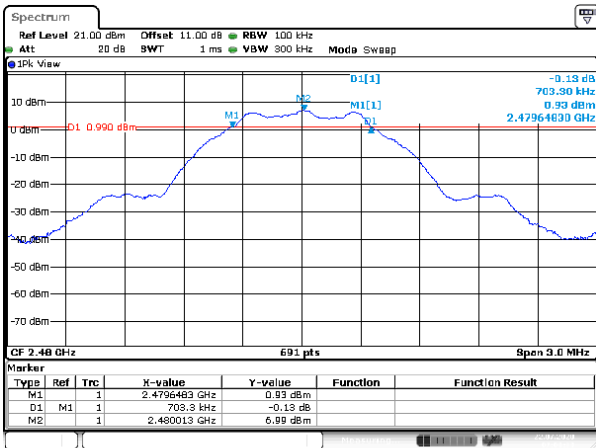



10. Maximum Peak and Average Output Power

10.1 Test Limit

The Maximum Peak Output Power Measurement is 30dBm.

10.2 Test Procedures

The antenna port (RF output) of the EUT was connected to the input (RF input) of a power meter. Power was read directly from the meter and cable loss connection was added to the reading to obtain power at the EUT antenna terminal. The EUT Output Power was set to maximum to produce the worse case test result.

10.3 Test Setup Layout

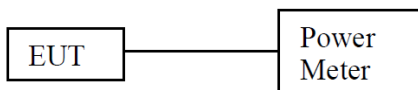

10.4 Test Result and Data

| Power Set | Modulation Type | Channel | Frequency (MHz) | Power Output (dBm) | | Power Output (mW) | |
|-----------|-----------------|---------|-----------------|--------------------|---------|-------------------|---------|
| | | | | Peak | Average | Peak | Average |
| Default | GFSK | 0 | 2402 | 5.06 | 4.81 | 3.206 | 3.027 |
| Default | | 19 | 2440 | 6.12 | 5.95 | 4.093 | 3.936 |
| Default | | 39 | 2480 | 7.01 | 6.89 | 5.023 | 4.887 |

*Average Power is for reference only



11. Power Spectral Density

11.1 Test Limit

The Maximum of Power Spectral Density Measurement is 8dBm.

11.2 Test Procedures

- a. The transmitter output was connected to spectrum analyzer.
- b. The spectrum analyzer's resolution bandwidth were set at 3KHz RBW and 10KHz VBW as that of the fundamental frequency. Set the sweep time=auto couple.
- c. The power spectral density was measured and recorded.

11.3 Test Setup Layout

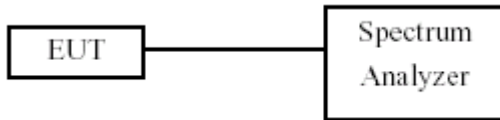

11.4 Test Result and Data

| Modulation Type | Channel | Frequency (MHz) | Maximum Power Density of 3KHz Bandwidth(dBm) | Limit |
|-----------------|---------|-----------------|--|-------|
| GFSK(1Mbps) | 0 | 2402 | -10.59 | 8.00 |
| | 19 | 2440 | -9.38 | 8.00 |
| | 39 | 2480 | -8.62 | 8.00 |



Modulation Type: GFSK
CH00

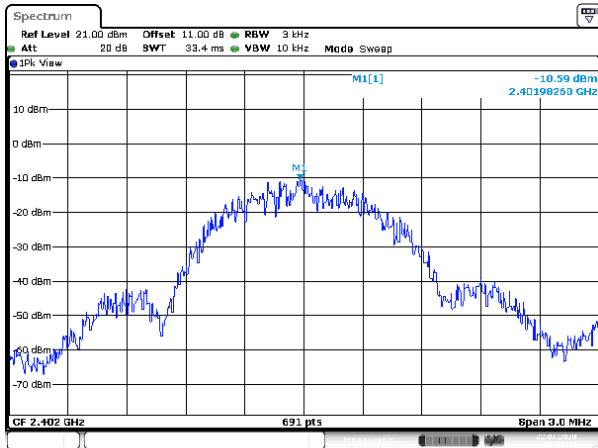

Modulation Type: GFSK
CH19

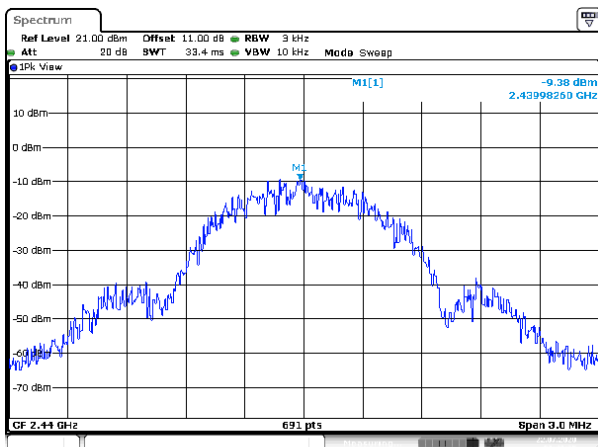

Modulation Type: GFSK
CH39

