



427 West 12800 South
Draper, UT 84020

Test Report Certification

FCC ID	SWX-UKU
ISED ID	6545A-UKU
Equipment Under Test	UK-Ultra
Test Report Serial Number	TR8502_02
Date of Test(s)	4, 8 – 10, 14, 23 August and 11, 14 September 2023
Report Issue Date	21 September 2023

Test Specification	Applicant
47 CFR FCC Part 15, Subpart E	Ubiquiti Inc. 685 Third Avenue New York, NY 10017 U.S.A.



NVLAP LAB CODE 600241-0

Certification of Engineering Report

This report has been prepared by Unified Compliance Laboratory (UCL) to document compliance of the device described below with the requirement of Federal Communication Commissions (FCC) Part 15, Subpart E. This report may be reproduced in full. Partial reproduction of this report may only be made with the written consent of the laboratory. The results in this report apply only to the sample tested.

Applicant	Ubiquiti Inc.
Manufacturer	Ubiquiti Inc.
Brand Name	UBIQUITI
Model Number	UK-Ultra
FCC ID	SWX-UKU
ISED ID	6545A-UKU

On this 21st day of September 2023, I individually and for Unified Compliance Laboratory certify that the statements made in this engineering report are true, complete, and correct to the best of my knowledge and are made in good faith.

Although NVLAP has accredited the Unified Compliance Laboratory testing facilities, this report must not be used to claim product certification, approval, or endorsement by NVLAP, NIST or any agency of the U.S. federal government.

Unified Compliance Laboratory



Written By: Joseph W. Jackson



Reviewed By: Kimberly Rodriguez

Revision History		
Revision	Description	Date
01	Original Report Release	9/21/2023
02	Amended Sections 5.4 and 5.6 – Added IC Number on Title Page and Page 2	11/28/2023

Table of Contents

1	Client Information.....	5
1.1	Applicant.....	5
1.2	Manufacturer.....	5
2	Equipment Under Test (EUT).....	6
2.1	Identification of EUT	6
2.2	Description of EUT	6
2.3	EUT and Support Equipment.....	6
2.4	Interface Ports on EUT	7
2.5	Operating Environment.....	7
2.6	Operating Modes.....	7
2.7	EUT Exercise Software.....	7
2.8	Block Diagram of Test Configuration	8
2.9	Modification Incorporated/Special Accessories on EUT.....	8
2.10	Deviation, Opinions Additional Information or Interpretations from Test Standard.....	8
3	Test Specification, Method and Procedures.....	9
3.1	Test Specification.....	9
3.2	Methods & Procedures.....	9
3.3	FCC Part 15, Subpart E.....	9
3.4	Results.....	9
3.5	Test Location	10
4	Test Equipment	11
4.1	Conducted Emissions at Mains Ports.....	11
4.2	Direct Connect at the Antenna Port Tests.....	11
4.3	Radiated Emissions.....	12
4.4	Equipment Calibration	13
4.5	Measurement Uncertainty.....	13
5	Test Results.....	14
5.1	§15.203 Antenna Requirements.....	14
5.2	Conducted Emissions at Mains Ports Data	15
5.3	§15.403(i) 26 dB Emissions Bandwidth	17
5.4	§15.407(a)(2) Maximum Average Output Power	18
5.5	§15.407(b) Spurious Emissions	22
5.6	§15.407(a) Maximum Power Spectral Density.....	37

1 Client Information

1.1 Applicant

Company	Ubiquiti Inc. 685 Third Avenue New York, NY 10017 U.S.A.
Contact Name	Alex Macon
Title	Compliance

1.2 Manufacturer

Company	Ubiquiti Inc. 685 Third Avenue New York, NY 10017 U.S.A.
Contact Name	Alex Macon
Title	Compliance

2 Equipment Under Test (EUT)

2.1 Identification of EUT

Brand Name	UBIQUITI
Model Number	UK-Ultra
Serial Number	077-M5ELV7
Dimensions (cm)	13.7 x 8.4 x 3.4

2.2 Description of EUT

The UK-Ultra is a WiFi mesh that provides simultaneous, dual-band, 2x2 MIMO technology. The UK-Ultra is used to expand the coverage of an UniFi system. The UK-Ultra provides 802.11ac technology for ubiquitous WiFi coverage for both indoor and outdoor use. The UK-Ultra is power from a 48 volt PoE adapter POE-24-12W-G-WH.

Band	WiFi Mode	Modulation Bandwidth	Modulation Type	Frequency (MHz)
UNII-1	a	20 MHz	OFDM	5180, 5200, 5210, 5240
	ac	20 MHz	VHT	5180, 5200, 5210, 5240
	ac	40 MHz	VHT	5190, 5230
	ac	80 MHz	VHT	5210

This report covers the circuitry of the device subject to FCC Part 15, Subpart E. The circuitry of the device subject to FCC Part 15 Subpart B was found to be compliant and is covered under a separate Unified Compliance Laboratory test report.

2.3 EUT and Support Equipment

The EUT and support equipment used during the test are listed below.

Brand Name Model Number Serial Number	Description	Name of Interface Ports / Interface Cables
BN: UBIQUITI MN: UK-Ultra (Note 1) SN: 077-M5ELV7	Wireless Access Point	See Section 2.4
BN: UBIQUITI MN: U-POE-af SN: N/A	PoE Power Adapter	Shielded or Un-shielded cat 5e cable / < 3 meters
BN: Dell MN: XPS 13 SN: N/A	Laptop Computer	Shielded or Un-shielded cat 5e cable / < 3 meters

Notes: (1) EUT

(2) Interface port connected to EUT (See Section 2.4)

The support equipment listed above was not modified in order to achieve compliance with this standard.

2.4 Interface Ports on EUT

Name of Ports	No. of Ports Fitted to EUT	Cable Description/Length
AC Mains	1	3 conductor power cord/80cm
PoE (PoE Injector)	1	Shielded or Un-shielded cat 5e cable/8 meters
LAN (PoE Injector)	1	Shielded or Un-shielded cat 5e cable/1 meters

2.5 Operating Environment

Power Supply	120 Volts AC to 48 Volts PoE
AC Mains Frequency	60 Hz
Temperature	20.1 – 26.0 °C
Humidity	35.2 – 50.3 %
Barometric Pressure	1015 mBar

2.6 Operating Modes

The UK-Ultra was tested using test software in order to enable a constant transmission. The measurements within this report are corrected to reference a 100% duty cycle. All emission modes of 802.11 a/ac were investigated. All measurements are reported with the worst-case mode (802.11ac) unless otherwise stated.

2.7 EUT Exercise Software

EUT firmware version 1.0 was used to operate the transmitter using a constant transmit mode.

2.8 Block Diagram of Test Configuration

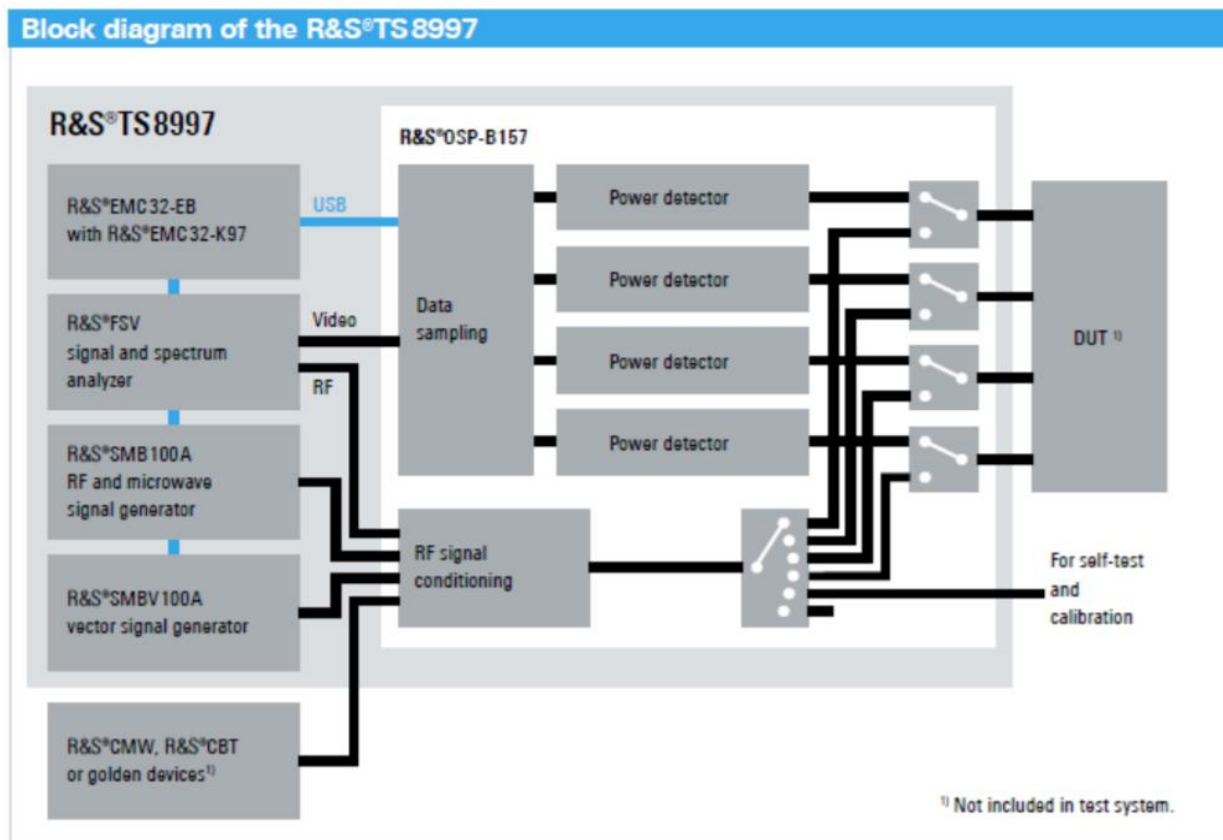

Diagram 1: Test Configuration Block Diagram

2.9 Modification Incorporated/Special Accessories on EUT

There were no modifications made to the EUT during testing to comply with the specification.

2.10 Deviation, Opinions Additional Information or Interpretations from Test Standard

There were no deviations, opinions, additional information or interpretations from the test specification.

3 Test Specification, Method and Procedures

3.1 Test Specification

Title	47 CFR FCC Part 15, Subpart E, Section 15.407 Limits and methods of measurement of radio interference characteristics of Unlicensed National Information Infrastructure Devices
Purpose of Test	The tests were performed to demonstrate initial compliance

3.2 Methods & Procedures

3.2.1 47 CFR FCC Part 15 Section 15.407

See test standard for details.

3.3 FCC Part 15, Subpart E

3.3.1 Summary of Tests

FCC Section	ISED Section	Environmental Phenomena	Frequency Range (MHZ)	Result
15.407(a)	N/A	Antenna requirements	Structural Requirement	Compliant
15.407(b)	RSS-Gen	Conducted Disturbance at Mains Port	0.15 to 30	Compliant
15.407(c)	RSS-247 §6.2.2, §6.2.3	Bandwidth Requirement	5180 to 5210	Compliant
15.407(e)	RSS-247 §6.2.2, §6.2.3	Peak Output Power	5180 to 5210	Compliant
15.407(f)	RSS-247 §6.2.2, §6.2.3	Antenna Conducted Spurious Emissions	0.009 to 40000	N/A
15.407(g)	RSS-247 §6.2.2, §6.2.3	Radiated Spurious Emissions	0.009 to 40000	Compliant
15.407(h)	RSS-247 §6.2.2, §6.2.3	Peak Power Spectral Density	5180 to 5210	Compliant

The testing was performed according to the procedures in ANSI C63.10-2013, KDB 789033 and 47 CFR Part 15. Where applicable, KDB 662911 was followed to sum required measurements.

3.4 Results

In the configuration tested, the EUT complied with the requirements of the specification.

3.5 Test Location

Testing was performed at the Unified Compliance Laboratory 3-Meter and 10-Meter chambers located at 427 West 12800 South, Draper, UT 84020. Unified Compliance Laboratory is accredited by National Voluntary Laboratory Accreditation Program (NVLAP); NVLAP Code 600241-0 which is effective until 30 June 2024. This site has also been registered with Innovations, Science and Economic Development (ISED) department as was accepted under Appendix B, Phase 1 procedures of the APEC Tel MRA for Canadian recognition. ISED No.: 25346, effective until 30 June 2024.

Unified Compliance Laboratory has been assigned Designation Number US5037 by the FCC and Conformity Assessment Number US0223 by ISED.

4 Test Equipment

4.1 Conducted Emissions at Mains Ports

Type of Equipment	Manufacturer	Model Number	Asset Number	Date of Last Calibration	Due Date of Calibration
EMI Receiver	AFJ	FFT3010	UCL-6754	2/22/2023	2/22/2024
LISN	AFJ	LS16C/10	UCL-6749	12/6/2021	12/6/2023
ISN	Teseq	ISN T800	UCL-2974	6/27/2022	6/27/2024
LISN	Com-Power	LIN-120C	UCL-2612	1/24/2023	1/24/2024
AC Power Source	Laplace Instruments	AC1000A	UCL-2857	N/A	N/A
Test Software	UCL	Revision 1	UCL-3107	N/A	N/A

Table 1: List of equipment used for Conducted Emissions Testing at Mains Port

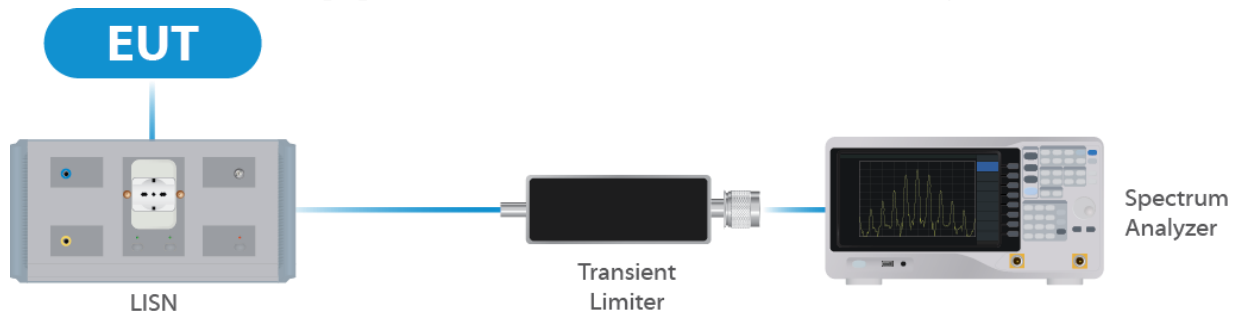

Figure 1: Conducted Emissions Test

4.2 Direct Connect at the Antenna Port Tests

Type of Equipment	Manufacturer	Model Number	Asset Number	Date of Last Calibration	Due Date of Calibration
Spectrum Analyzer	R&S	FSV40	UCL-2861	11/7/2022	11/7/2023
Signal Generator	R&S	SMB100A	UCL-2864	N/A	N/A
Vector Signal Generator	R&S	SMBV100A	UCL-2873	N/A	N/A
Switch Extension	R&S	OSP-B157WX	UCL-2867	2/22/2023	2/22/2024
Switch Extension	R&S	OSP-150W	UCL-2870	2/22/2023	2/22/2024

Table 2: List of equipment used for Direct Connect at the Antenna Port

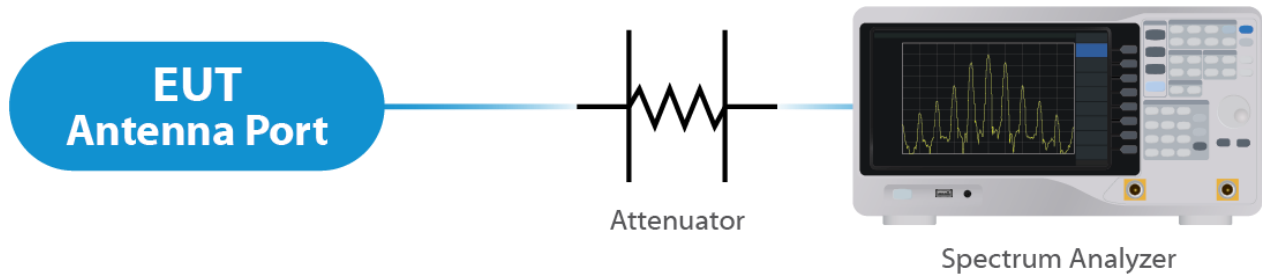

Figure 2: Direct Connect at the Antenna Port Test



Figure 3: Output Power Measurement

4.3 Radiated Emissions

Type of Equipment	Manufacturer	Model Number	Asset Number	Date of Last Calibration	Due Date of Calibration
EMI Receiver	Keysight	N9038A	UCL-2778	1/27/2023	1/27/2024
Pre-Amplifier 9 kHz – 1 GHz	Sonoma Instruments	310N	UCL-2889	10/7/2021	10/7/2023
Broadband Antenna	Scwarzbeck	VULB 9163	UCL-3062	2/22/2023	2/22/2025
Broadband Antenna	Scwarzbeck	VULB 9163	UCL-3071	1/11/2023	1/11/2025
Double Ridge Horn Antenna	Scwarzbeck	BBHA 9120D	UCL-3065	9/22/2022	9/22/2024
Log Periodic	Scwarzbeck	STLP 9129	UCL-3068	1/27/2023	1/27/2025
15 - 40 GHz Horn Antenna	Scwarzbeck	BBHA 9170	UCL-2487	6/09/2022	6/09/2024
1 – 18 GHz Amplifier	Com-Power	PAM 118A	UCL-3833	12/9/2022	12/9/2023
Test Software	UCL	Revision 1	UCL-3108	N/A	N/A

Table 3: List of equipment used for Radiated Emissions

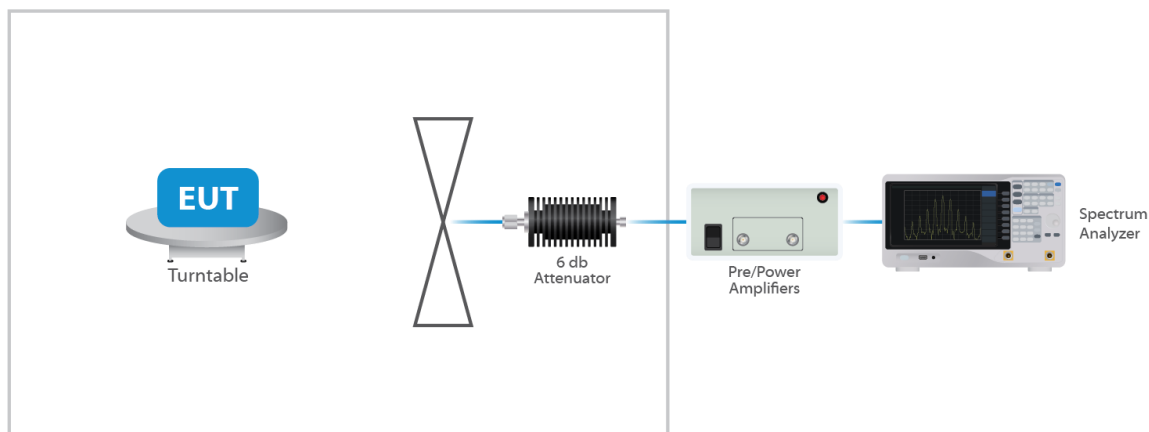

Figure 4: Radiated Emissions Test

4.4 Equipment Calibration

All applicable equipment is calibrated using either an independent calibration laboratory or Unified Compliance Laboratory personnel at intervals defined in ANSI C63.4:2014 following outlined calibration procedures. All measurement instrumentation is traceable to the National Institute of Standards and Technology (NIST). Supporting documentation relative to traceability is on file and is available for examination upon request.

4.5 Measurement Uncertainty

Test	Uncertainty (\pm dB)	Confidence (%)
Conducted Emissions	1.44	95
Radiated Emissions (9 kHz to 30 MHz)	2.50	95
Radiated Emissions (30 MHz to 1 GHz)	4.38	95
Radiated Emissions (1 GHz to 18 GHz)	4.37	95
Radiated Emissions (18 GHz to 40 GHz)	3.93	95
Direct Connect Tests	K Factor	Value
Emissions Bandwidth	2	2.0%
Output Power	2	1.0 dB
Peak Power Spectral Density	2	1.3 dB
Band Edge	2	0.8 dB
Transmitter Spurious Emissions	2	1.8 dB

5 Test Results

5.1 §15.203 Antenna Requirements

The EUT uses an integrated antenna structure and an omni external antenna. Per the manufacturer, the maximum gain of the integrated antenna per chain is 6.1 dBi and the omni external antenna is 4.57 dBi.

This is an 802.11 device and utilizes CDD as described in KDB 662911 D01. The integrated antenna is not user replaceable whereas the external omni antenna is user replaceable.

For power measurements on IEEE 802.11 devices, Array Gain = 0 dB for $N_{ANT} \leq 4$;

For PSD measurements when $N_{ss}=1$: Array Gain = $10 \log(N_{ant}/N_{ss})$ dB = 9.11 dB for the integrated antenna and 7.58 dB for the external omni antenna.

Results

The EUT complied with the specification

5.2 Conducted Emissions at Mains Ports Data

5.2.1 Line

Hot Lead

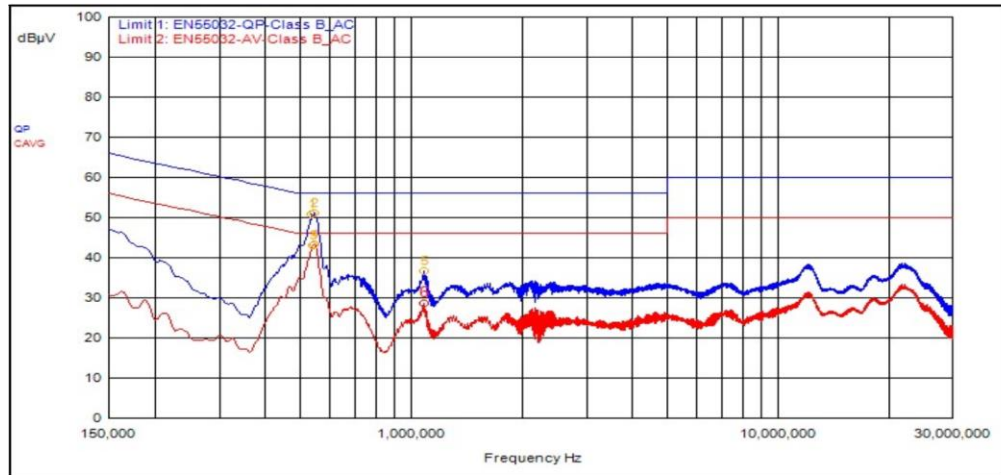

ID	Frequency	Probe	Cable	Atten.	Detector	Meter Read	Meas Level	Limit 1	Limit 1 Dist.	Limit 2	Limit 2 Dist.	P/F
MU	MHz	dB	dB	dB	Type	dBµV	dBµV	dBµV	dB	dBµV	dB	P/F
2	543,000kHz	9.49	0.00		QPeak	41.71	51.20	56.00	-4.80			
1	537,000kHz	9.49	0.00		QPeak	41.29	50.78	56.00	-5.22			
5	1.086	9.58	0.00		QPeak	26.96	36.54	56.00	-19.46			
3	540,000kHz	9.49	0.00		C_AVG	33.68	43.17			46.00	-2.83	
4	546,000kHz	9.49	0.00		C_AVG	33.80	43.29			46.00	-2.71	
6	1.086	9.58	0.00		C_AVG	18.98	28.56			46.00	-17.44	

Note 1: The reference detector used for the measurements was Quasi-Peak or Peak and the data was compared to the average limit: therefore, the EUT was deemed to meet both the average and quasi-peak limits.

Note 2: The reference detector used for the measurements was quasi-peak and average and the data was compared to the respective limits.

Note 3: The device the transceiver is in is a Class A device and the limits shown are from §15.207 which are the same as the limits for a Class B device under §15.107. These emissions were investigated and were found to be at the same level regardless of whether the transceivers of the device were not powered, powered and idle, or powered and active, therefore, the conducted emissions of the transceivers were deemed compliant with the requirements of the standard.

5.2.2 Neutral

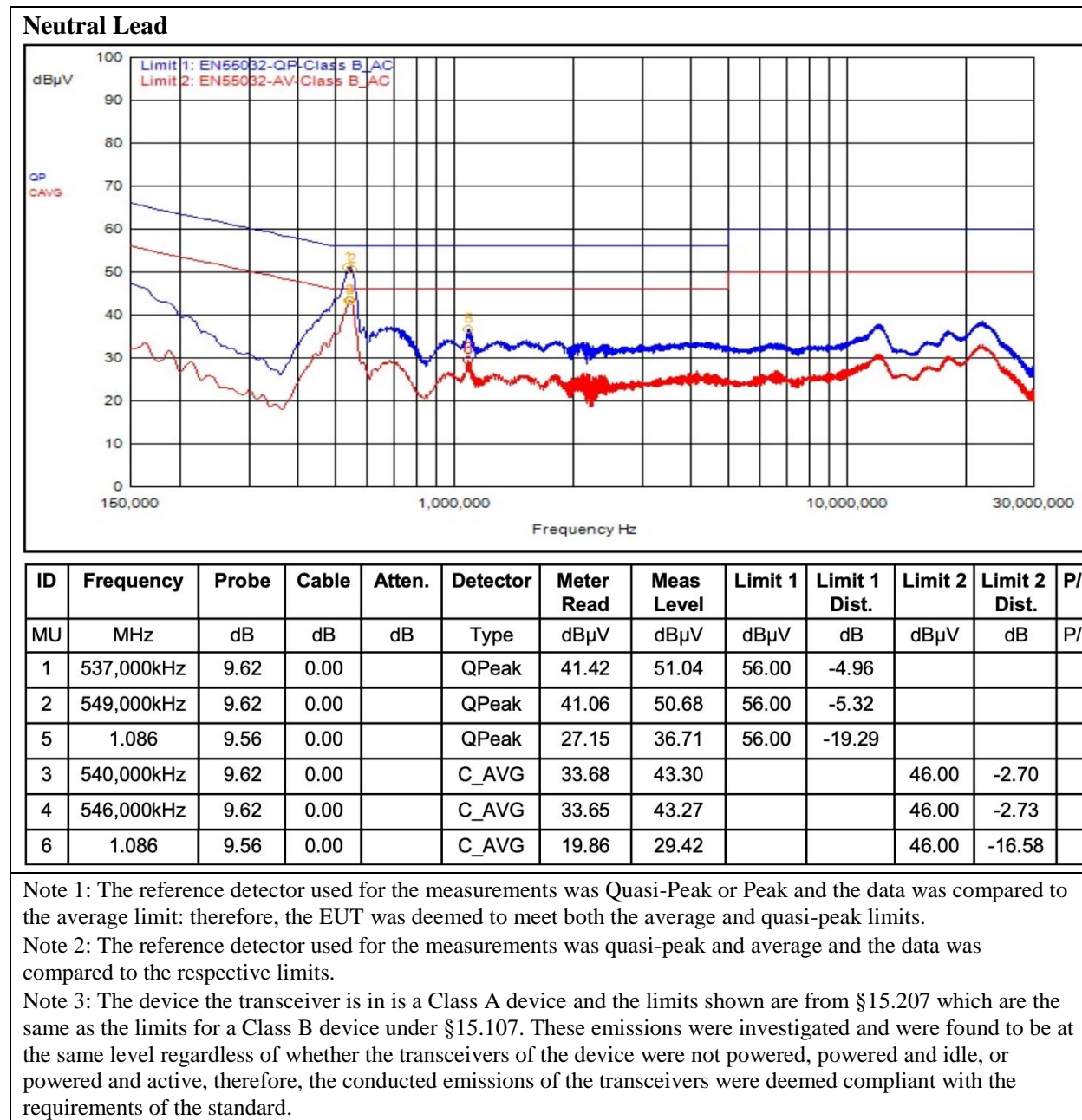

Result

The EUT complied with the specification limit.

5.3 §15.403(i) 26 dB Emissions Bandwidth

All chains were measured under the guidance of KDB 789033 Section II.C. and KDB 66291 D01. Please see associated annex for details on instrument settings.

5.3.1 Integrated Antenna

Nominal BW (MHz)	Frequency (MHz)	99% Bandwidth (MHz)	Emissions 26 dB Bandwidth (MHz)
a 20 MHz	5180	16.7	22.0
a 20 MHz	5210	16.7	23.4
a 20 MHz	5240	18.0	31.9
ac 20 MHz	5180	17.9	23.1
ac 20 MHz	5210	17.9	22.9
ac 20 MHz	5240	18.7	32.1
ac 40 MHz	5190	36.5	43.2
ac 40 MHz	5230	37.0	70.4
ac 80 MHz	5210	76.0	87.5

5.3.2 Omni External Antenna

Nominal BW (MHz)	Frequency (MHz)	99% Bandwidth (MHz)	Emissions 26 dB Bandwidth (MHz)
a 20 MHz	5180	16.6	21.7
a 20 MHz	5210	17.7	33.3
a 20 MHz	5240	18.5	34.3
ac 20 MHz	5180	17.9	23.0
ac 20 MHz	5210	18.2	28.5
ac 20 MHz	5240	18.8	37.2
ac 40 MHz	5190	36.5	42.2
ac 40 MHz	5230	37.0	61.8
ac 80 MHz	5210	76.5	87.5

Result

All chains were tested and the highest bandwidth per chain is reported above.

The 26 dB bandwidths are reported for information purposes. Please see Annex for all bandwidth measurements.

5.4 §15.407(a)(2) Maximum Average Output Power

All chains were measured and summed under the guidance of KDB 789033 Section II. E.2. and KDB 66291 D01. Please see associated annex for details on instrument settings.

The maximum average RF conducted output power measured for this device was 26.77 dBm or 475.34 mW. The limit is 30 dBm, or 1 Watt when using an antenna with 6 dBi (indoor/outdoor access point) or less gain. If transmitting antennas of directional gain greater than 6 dBi are used, both the maximum conducted output power and the maximum power spectral density shall be reduced by the amount in dB that the directional gain of the antenna exceeds 6 dB.

The internal antenna gain is 6.1 dBi (Nss=1 gain 9.11) however, the measured conducted output power is below an adjusted 26.9 dBm or 0.49 watts limit (At 30-degrees the antenna has a gain of 0 dBi, see Figure 1 below). The omni external antenna gain is 4.57 dBi (Nss=1 gain is 7.58) however, the measured conducted output power is below an adjusted 28.42 dBm or 0.7 watts limit (At 30-degrees the antenna has a gain of 1 dBi See figure 2 below).

5.4.1 Integrated Antenna

Modulation (BW)	Frequency (MHz)	Data Rate	TP Setting	Conducted Output Power	Measured EIRP
OFDM 20	5180	Mcs0	18	20.34	26.44
OFDM 20	5210	Mcs0	18	20.57	26.67
OFDM 20	5240	Mcs0	20	20.09	26.19
VHT 20	5180	Mcs0	18	20.30	26.40
VHT 20	5210	Mcs0	18	20.53	26.63
VHT 20	5240	Mcs0	18	20.05	26.15
VHT 40	5190	Mcs0	16	18.09	24.19
VHT 40	5230	Mcs0	19	20.55	26.65
VHT 80	5210	Mcs0	15	16.87	22.97

5.4.2 Integrated Antenna Outdoor 30-degree elevation angle reduction

Modulation (BW)	Frequency (MHz)	Data Rate	TP Setting	Conducted Output Power	Measured EIRP
OFDM 20	5180	Mcs0	12	14.34	20.44
OFDM 20	5210	Mcs0	12	14.57	20.67
OFDM 20	5240	Mcs0	14	14.09	20.19
VHT 20	5180	Mcs0	12	14.3	20.4
VHT 20	5210	Mcs0	12	14.53	20.63
VHT 20	5240	Mcs0	12	14.05	20.15
VHT 40	5190	Mcs0	12	14.09	20.19
VHT 40	5230	Mcs0	13	14.55	20.65
VHT 80	5210	Mcs0	12	13.87	19.97

5.4.3 Omni External Antenna

Modulation (BW)	Frequency (MHz)	Data Rate	TP Setting	Conducted Output Power	Measured EIRP
OFDM 20	5180	Mcs0	16	26.02	30.59
OFDM 20	5210	Mcs0	19	26.55	31.12
OFDM 20	5240	Mcs0	19	26.75	31.32
VHT 20	5180	Mcs0	16	18.51	23.08
VHT 20	5210	Mcs0	19	20.94	25.51
VHT 20	5240	Mcs0	19	20.63	25.20
VHT 40	5190	Mcs0	16	22.47	22.47
VHT 40	5230	Mcs0	19	24.92	24.92
VHT 80	5210	Mcs0	13	19.21	19.21

5.4.4 Omni External Antenna Outdoor 30-degree elevation angle reduction

Modulation (BW)	Frequency (MHz)	Data Rate	TP Setting	Conducted Output Power	Measured EIRP
OFDM 20	5180	Mcs0	6	16.02	20.59
OFDM 20	5210	Mcs0	8	15.55	20.12
OFDM 20	5240	Mcs0	8	15.75	20.32
VHT 20	5180	Mcs0	13	15.51	20.08
VHT 20	5210	Mcs0	14	15.94	20.51
VHT 20	5240	Mcs0	14	15.63	20.2
VHT 40	5190	Mcs0	14	20.47	20.47
VHT 40	5230	Mcs0	14	19.92	19.92
VHT 80	5210	Mcs0	13	19.21	19.21

Result

In the configuration tested, the maximum summed average RF output power was less than 0.49 & 0.7 watts; therefore, the EUT complied with the requirements of the specification (see spectrum analyzer plots in attached Annex).

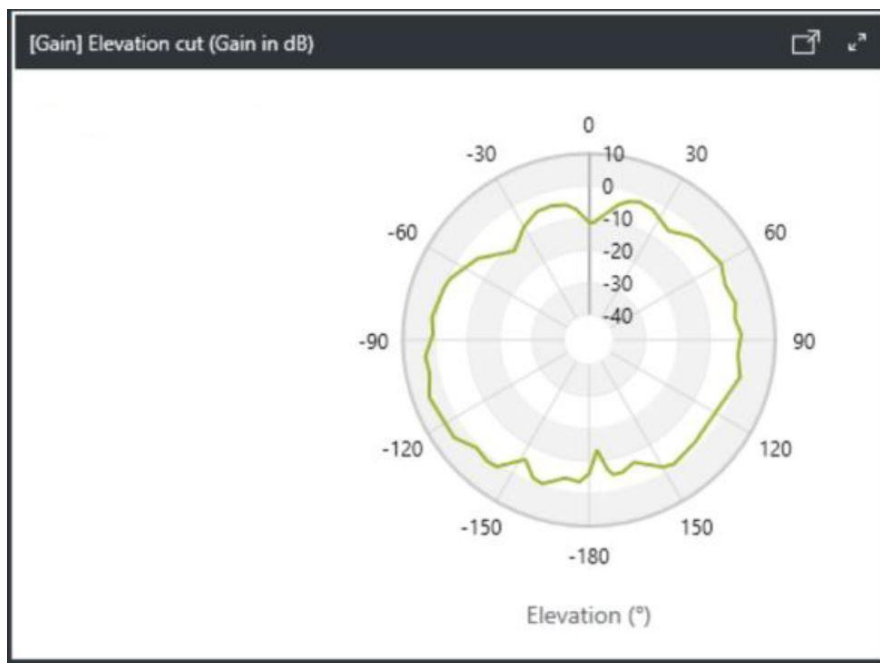

The maximum antenna gain can be found at -120 degrees. The antenna gain +/- 30 degrees from this point is nominally the same so max gain of 6.1 dB is used for the 30 degree elevation requirement.

Figure 1: Internal Antenna Elevation Plot Greater Than 30-Degrees from Horizon

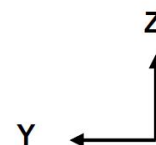
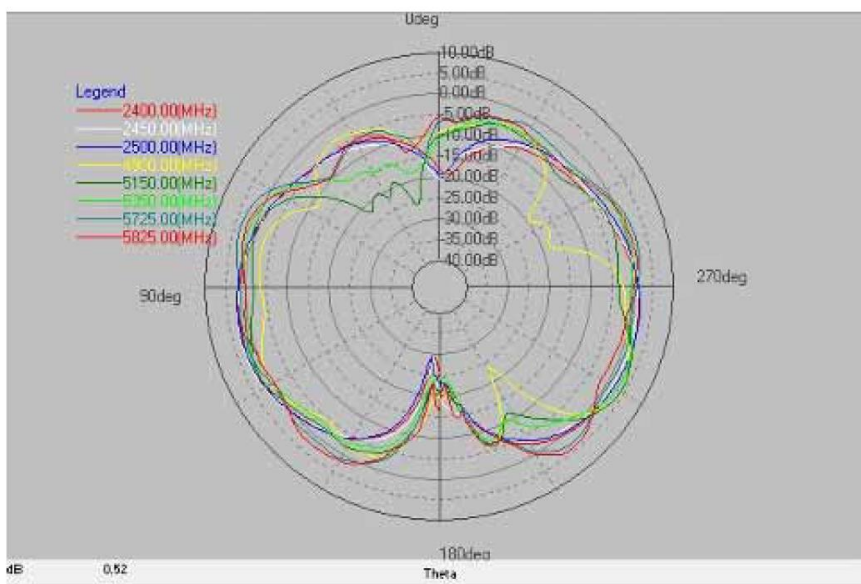

Y-Z Plane (E-total)

The maximum antenna gain is approximately 4.5 dBi. The antenna can be positioned in multiple angles so the max antenna gain is used for the 30 degree elevation requirement.

Figure 2: Omni Antenna Elevation Plot Greater Than 30-Degrees from Horizon

5.5 §15.407(b) Spurious Emissions

5.5.1 Conducted Spurious Emissions

The frequency range from the lowest frequency generated or used in the device to the tenth harmonic of the highest fundamental frequency was investigated to measure any antenna-conducted emissions. The graphs show the measurement data from spurious emissions noted across the frequency range when transmitting at the lowest frequency, middle frequency and upper frequency. Shown below are plots with the EUT turned to the upper and lower channels with the antenna gain of 6.1 dBi accounted for. These demonstrate compliance with the provisions of this section at the band edges.

The emissions must be remain below -27 dBm EIRP.

Result

Conducted spurious emissions were below -27 dBm; therefore, the EUT complies with the specification.

5.5.2 Radiated Spurious Emissions in the Restricted Bands of § 15.205

The EUT uses various power settings based on the channel in use. In order to reduce test time, the radiated spurious emissions at the lowest, middle, and highest channel were measured at the maximum power of TP20, as this setting was found to be worst case for spurious emissions. Power was subsequently reduced during in-band and band edge testing.

All emissions modes were tested, and the worst-case measurement are shown below. For frequencies above 1 GHz, a measurement of 3 meters was used. For frequencies below 1 GHz, a measurement distance of 10 meters was used.

Correction Factor = Antenna Factor + Cable Loss - Pre-Amplifier Gain, and is added to the Receiver reading.

Result

All emissions in the restricted bands of § 15.205 met the limits specified in § 15.209; therefore, the EUT complies with the specification. All emissions me the limits specified in § 15.407(b). Representative band edge plots are included in this report. See Annex for Conducted Band edge plots.

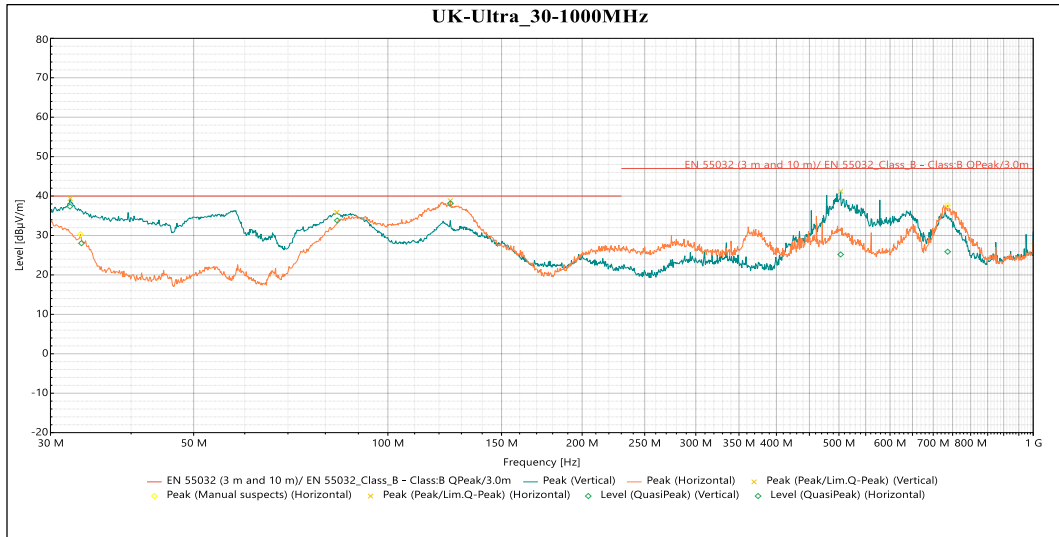
QuasiPeak

Frequency	Level (dBµV/m)	Limit (dBµV/m)	Margin	Azimuth (°)	Height	Pol.	Correction (dB)
32.158 MHz	37.372	40	-2.628	83	1.516	Vertical	-8.743
83.474 MHz	33.804	40	-6.196	300	1.5	Vertical	-20.804
503.04 MHz	25.189	47	-21.811	178	1.858	Vertical	-9.307
33.509 MHz	28.039	40	-11.961	75	2.401	Horizontal	-9.695
125.01 MHz	38.153	40	-1.847	253	2.783	Horizontal	-14.349
736.99 MHz	25.89	47	-21.11	253	1.324	Horizontal	-6.099

Table 4: Radiated Emissions 30 – 1000 MHz

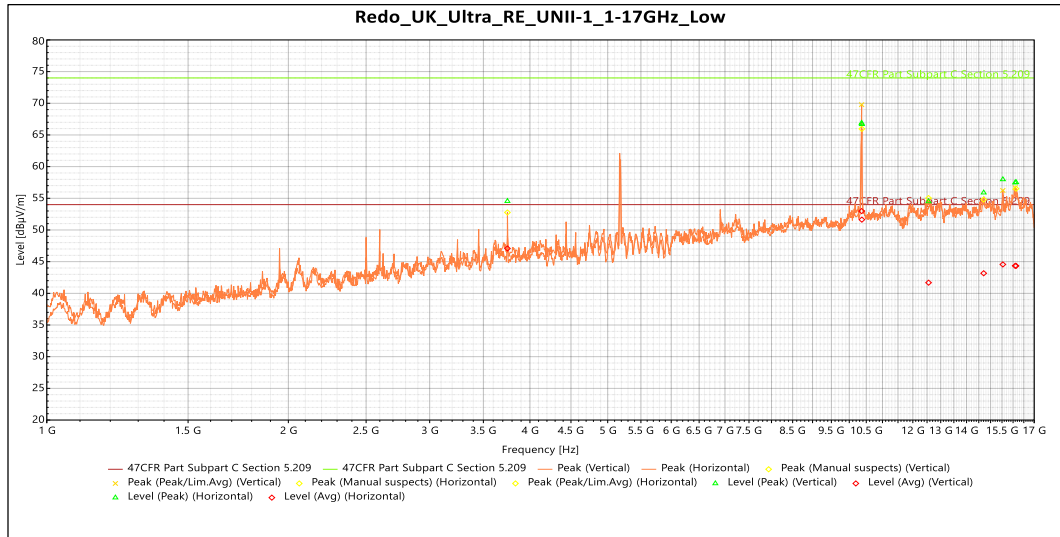

Peak

Frequency	Level (dBµV/m)	Limit (dBµV/m)	Margin (dB)	Azimuth (°)	Height (m)	Pol.	Correction (dB)
10.361 GHz	66.892	74	-7.108	190	1.638	Vertical	8.477
14.706 GHz	55.894	74	-18.106	173	2.65	Vertical	11.615
15.538 GHz	57.975	74	-16.025	156	3.153	Vertical	10.592
16.097 GHz	57.474	74	-16.526	38	1.5	Vertical	12.851
3.7501 GHz	54.553	74	-19.447	128	2.324	Horizontal	-4.611
10.368 GHz	66.686	74	-7.314	120	2.142	Horizontal	8.566
12.555 GHz	54.501	74	-19.499	274	1.643	Horizontal	10.111
16.136 GHz	57.54	74	-16.46	95	3.153	Horizontal	12.978

Avg

Frequency	Level (dBµV/m)	Limit (dBµV/m)	Margin (dB)	Azimuth (°)	Height (m)	Pol.	Correction (dB)
10.361 GHz	52.976	54	-1.024	190	1.638	Vertical	8.477
14.706 GHz	43.165	54	-10.835	173	2.65	Vertical	11.615
15.538 GHz	44.557	54	-9.443	156	3.153	Vertical	10.592
16.097 GHz	44.338	54	-9.662	38	1.5	Vertical	12.851
3.7501 GHz	47.076	54	-6.924	128	2.324	Horizontal	-4.611
10.368 GHz	51.633	54	-2.367	120	2.142	Horizontal	8.566
12.555 GHz	41.682	54	-12.318	274	1.643	Horizontal	10.111
16.136 GHz	44.335	54	-9.665	95	3.153	Horizontal	12.978

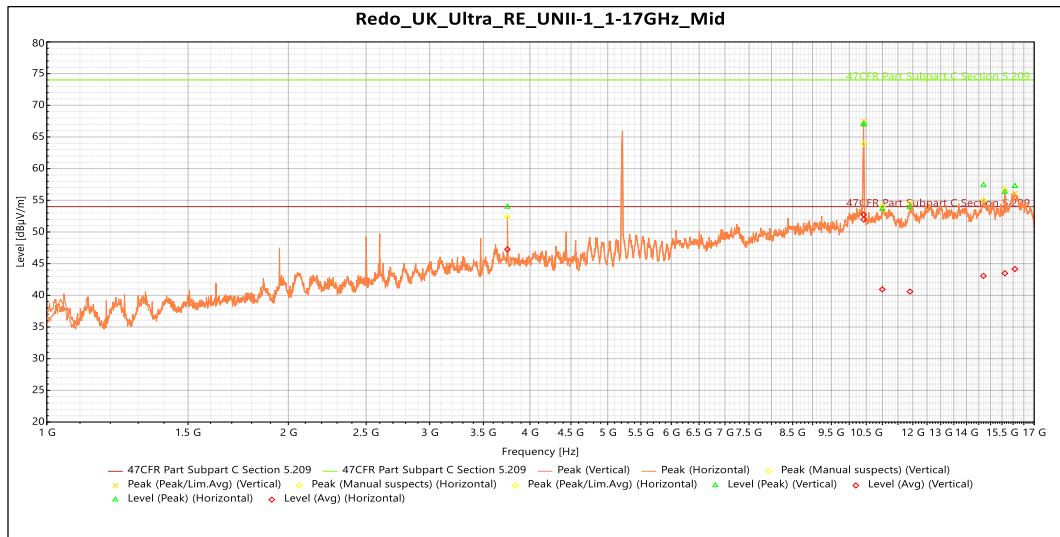
Table 5: Radiated Emissions 1 – 17 GHz Lowest Frequency 5180 MHz



Peak

Frequency	Level (dBµV/m)	Limit (dBµV/m)	Margin (dB)	Azimuth (°)	Height (m)	Pol.	Correction (dB)
10.421 GHz	66.936	74	-7.064	187	1.643	Vertical	8.719
10.995 GHz	53.625	74	-20.375	248	4	Vertical	9.108
14.697 GHz	57.424	74	-16.576	120	3.802	Vertical	11.667
16.087 GHz	57.244	74	-16.756	35	3.307	Vertical	12.807
3.7499 GHz	53.956	74	-20.044	123	2.325	Horizontal	-4.612
10.424 GHz	67.038	74	-6.962	120	1.643	Horizontal	8.686
11.903 GHz	53.93	74	-20.07	257	2.65	Horizontal	10.046
15.625 GHz	56.336	74	-17.664	112	2.142	Horizontal	10.659

Avg

Frequency	Level (dBµV/m)	Limit (dBµV/m)	Margin (dB)	Azimuth (°)	Height (m)	Pol.	Correction (dB)
10.421 GHz	52.744	54	-1.256	187	1.643	Vertical	8.719
10.995 GHz	40.939	54	-13.061	248	4	Vertical	9.108
14.697 GHz	43.071	54	-10.929	120	3.802	Vertical	11.667
16.087 GHz	44.15	54	-9.85	35	3.307	Vertical	12.807
3.7499 GHz	47.25	54	-6.75	123	2.325	Horizontal	-4.612
10.424 GHz	51.956	54	-2.044	120	1.643	Horizontal	8.686
11.903 GHz	40.586	54	-13.414	257	2.65	Horizontal	10.046
15.625 GHz	43.481	54	-10.519	112	2.142	Horizontal	10.659

Table 6: Radiated Emissions 1 – 17 GHz Middle Frequency 5200 MHz

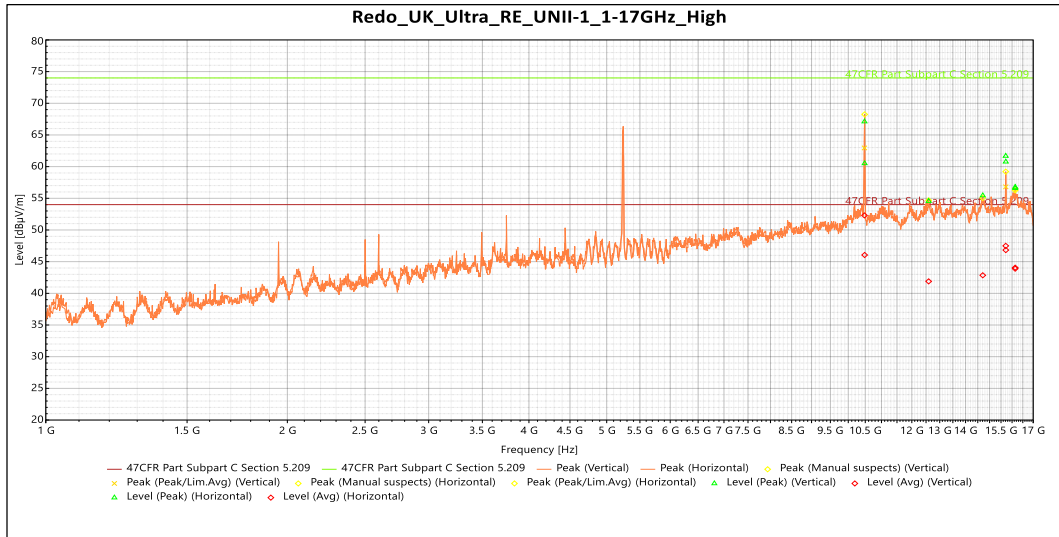

Peak

Frequency	Level (dBµV/m)	Limit (dBµV/m)	Margin (dB)	Azimuth (°)	Height (m)	Pol.	Correction (dB)
10.476 GHz	67.113	74	-6.887	186	1.643	Vertical	7.862
14.71 GHz	55.443	74	-18.557	34	3.657	Vertical	11.56
15.715 GHz	60.775	74	-13.225	142	2.816	Vertical	11.192
16.144 GHz	56.777	74	-17.223	359	1.833	Vertical	12.984
10.481 GHz	60.51	74	-13.49	53	3.798	Horizontal	7.77
12.594 GHz	54.549	74	-19.451	231	3.798	Horizontal	10.341
15.712 GHz	61.682	74	-12.318	125	1.5	Horizontal	11.21
16.143 GHz	56.6	74	-17.4	338	1.643	Horizontal	12.983

Avg

Frequency	Level (dBµV/m)	Limit (dBµV/m)	Margin (dB)	Azimuth (°)	Height (m)	Pol.	Correction (dB)
10.476 GHz	52.295	54	-1.705	186	1.643	Vertical	7.862
14.71 GHz	42.854	54	-11.146	34	3.657	Vertical	11.56
15.715 GHz	46.834	54	-7.166	142	2.816	Vertical	11.192
16.144 GHz	44.05	54	-9.95	359	1.833	Vertical	12.984
10.481 GHz	46.048	54	-7.952	53	3.798	Horizontal	7.77
12.594 GHz	41.891	54	-12.109	231	3.798	Horizontal	10.341
15.712 GHz	47.49	54	-6.51	125	1.5	Horizontal	11.21
16.143 GHz	43.888	54	-10.112	338	1.643	Horizontal	12.983

Table 7: Radiated Emissions 1 – 17 GHz Highest Frequency 5240 MHz

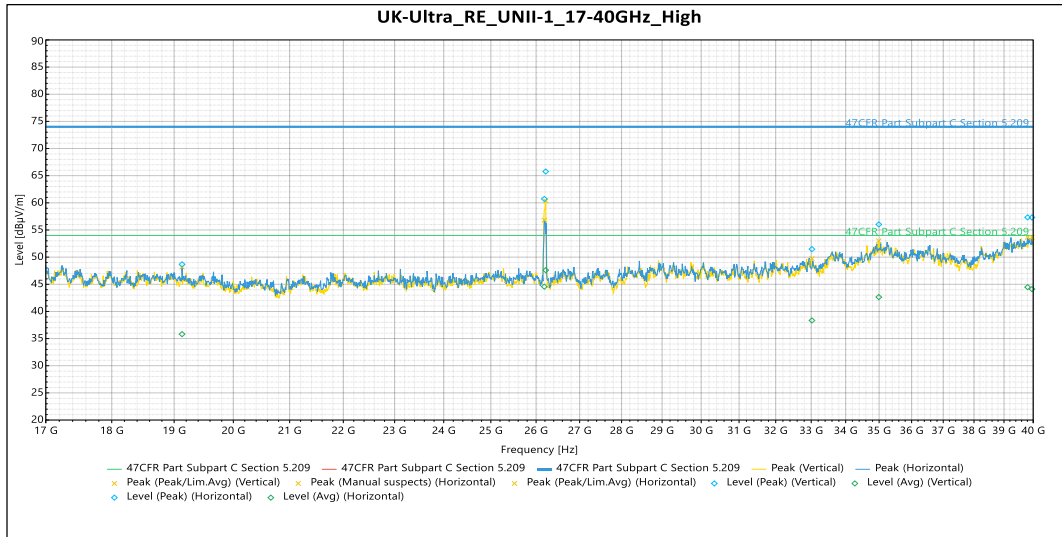
Peak

Frequency	Level (dBµV/m)	Limit (dBµV/m)	Margin (dB)	Azimuth (°)	Pol.	Correction (dB)
26.218 GHz	65.771	74	-8.229	111	Vertical	-2.339
33.021 GHz	51.468	74	-22.532	182	Vertical	0.669
34.991 GHz	56.015	74	-17.985	69	Vertical	5.296
39.958 GHz	57.303	74	-16.697	158	Vertical	5.824
19.131 GHz	48.677	74	-25.323	250	Horizontal	-1.304
26.186 GHz	60.717	74	-13.283	133	Horizontal	-2.293
39.807 GHz	57.317	74	-16.683	50	Horizontal	6.416

Avg

Frequency	Level (dBµV/m)	Limit (dBµV/m)	Margin (dB)	Azimuth (°)	Pol.	Correction (dB)
26.218 GHz	47.6	54	-6.4	111	Vertical	-2.339
33.021 GHz	38.338	54	-15.662	182	Vertical	0.669
34.991 GHz	42.642	54	-11.358	69	Vertical	5.296
39.958 GHz	44.105	54	-9.895	158	Vertical	5.824
19.131 GHz	35.819	54	-18.181	250	Horizontal	-1.304
26.186 GHz	44.556	54	-9.444	133	Horizontal	-2.293
39.807 GHz	44.471	54	-9.529	50	Horizontal	6.416

Table 8: Radiated Emissions 17 – 40 GHz Highest Frequency 5240 MHz (worse case)

5.5.3 Band Edge Internal Antenna

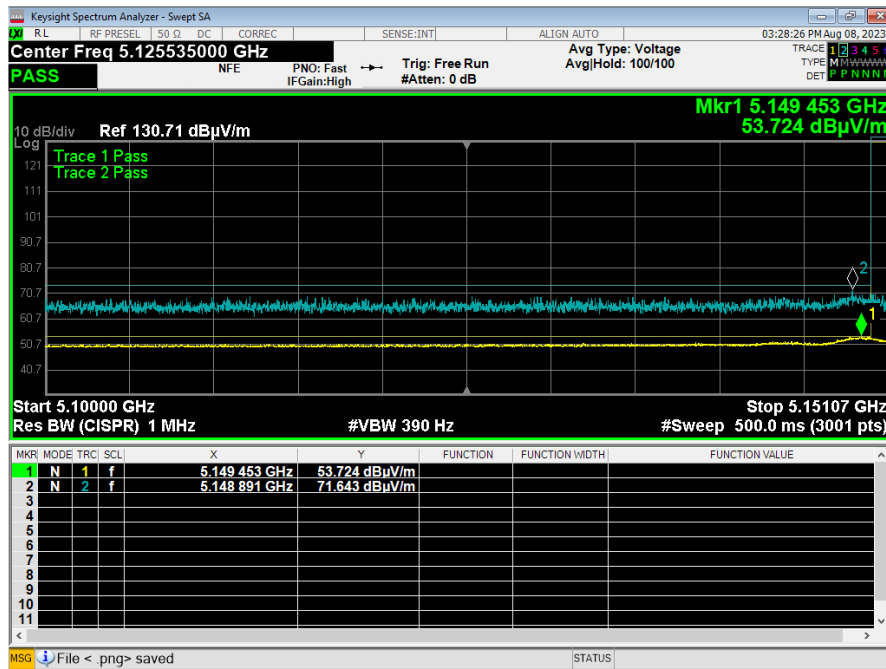

Plot 3: OFDM 20 MHz 5180 MHz

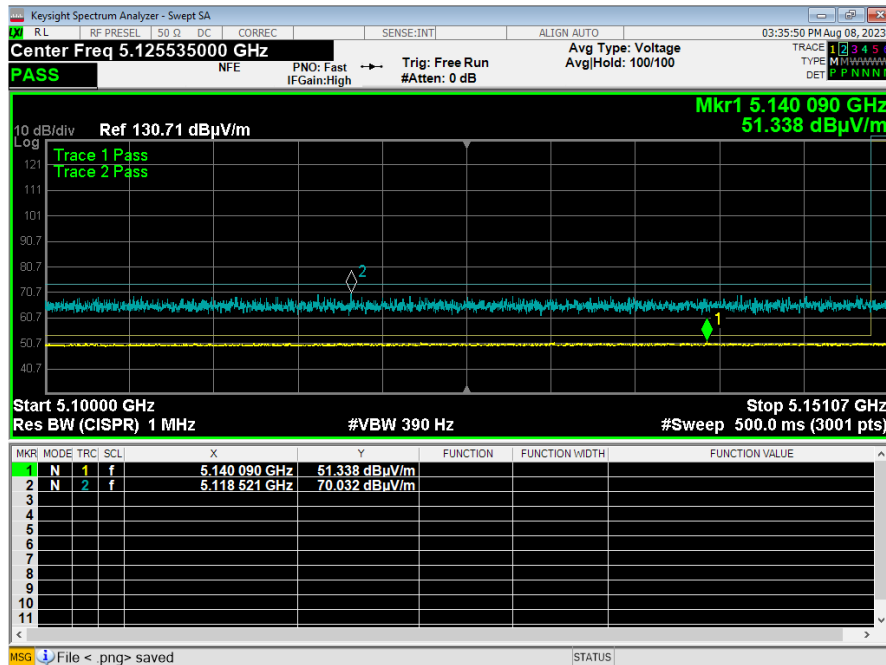

Plot 4: OFDM 20 MHz 5200 MHz

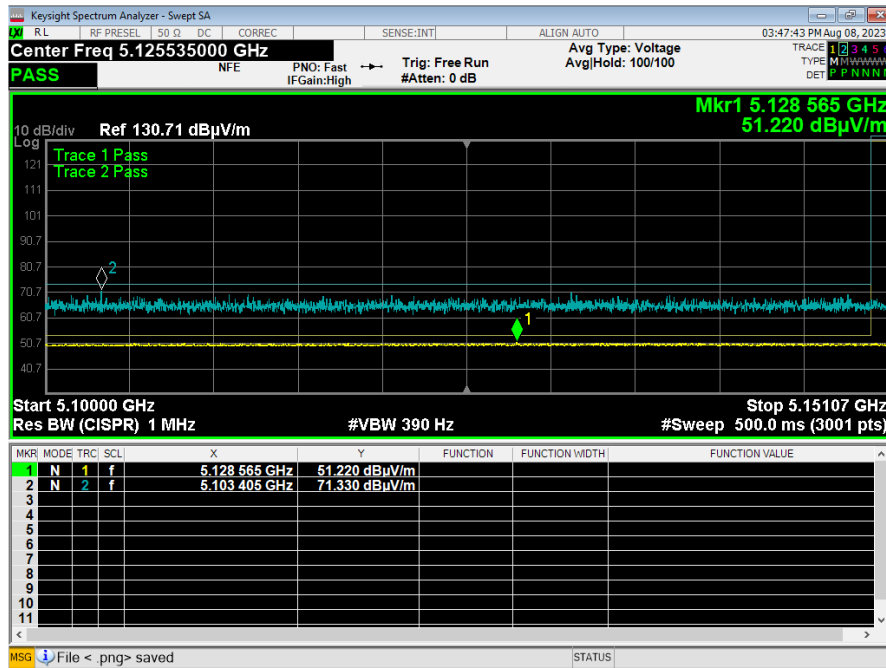

Plot 5: OFDM 20 MHz 5240 MHz

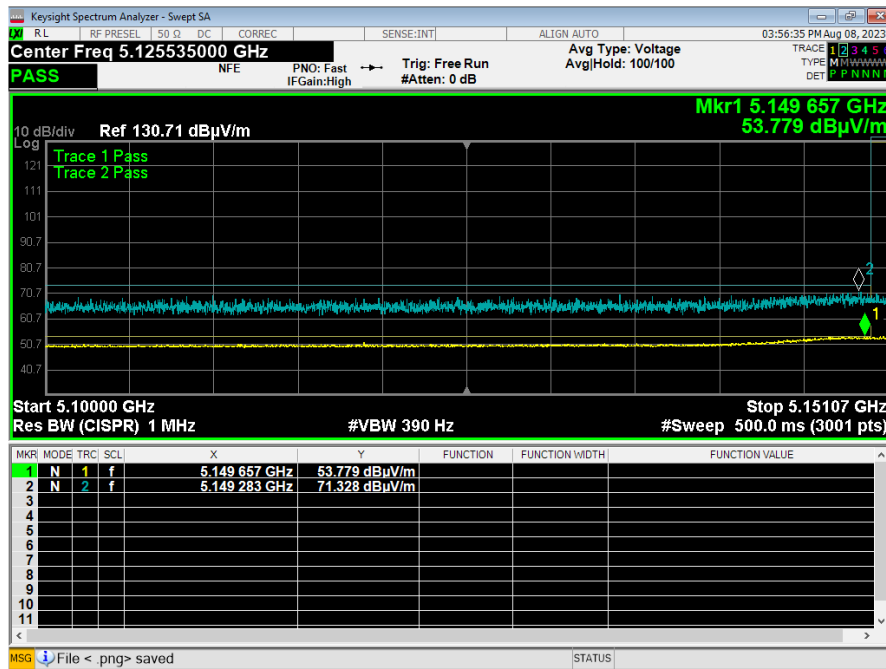

Plot 6: VHT 20 MHz 5180 MHz

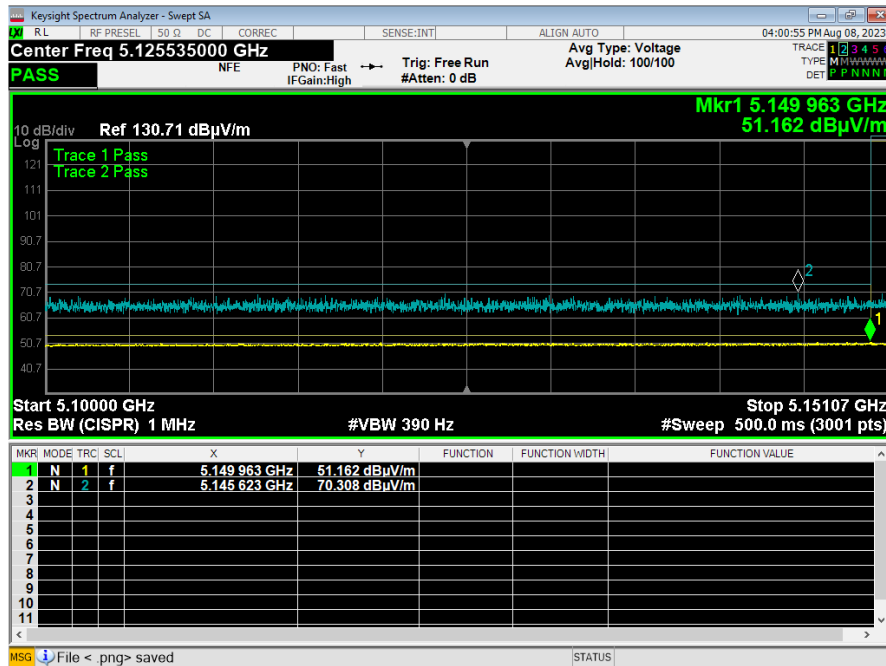

Plot 7: VHT 20 MHz 5200 MHz

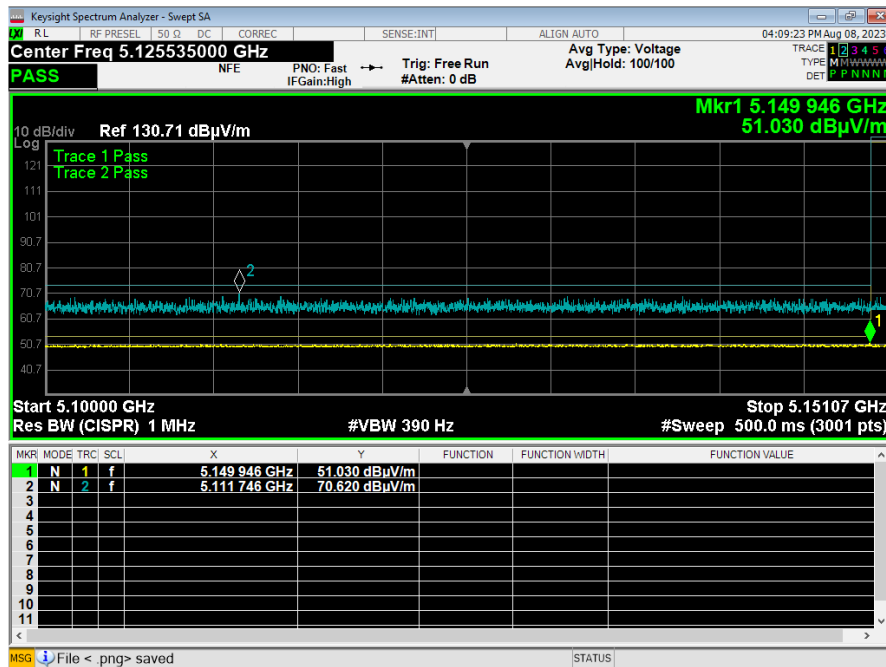

Plot 8: VHT 20 MHz 5240 MHz

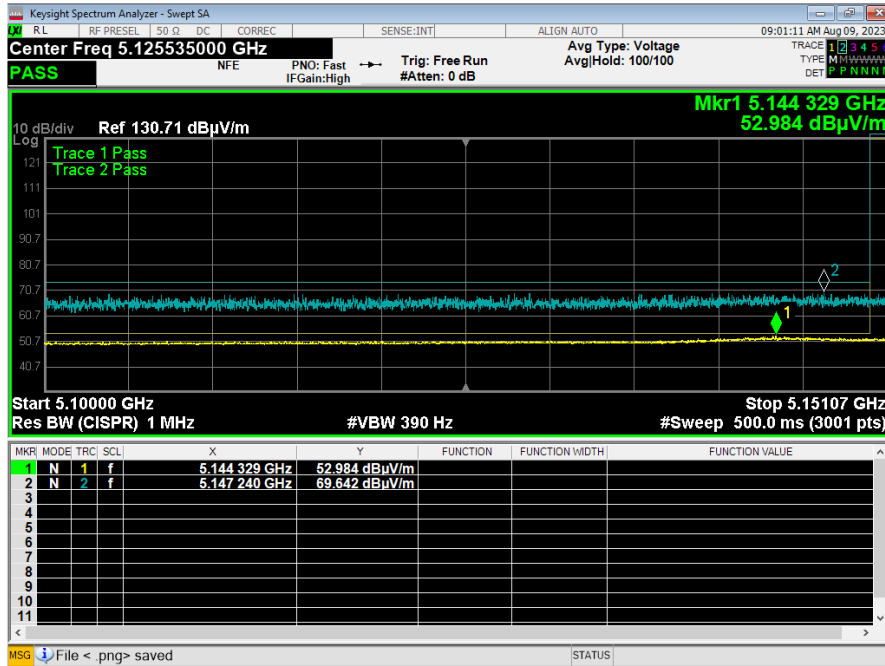

Plot 9: VHT 40 MHz 5190 MHz

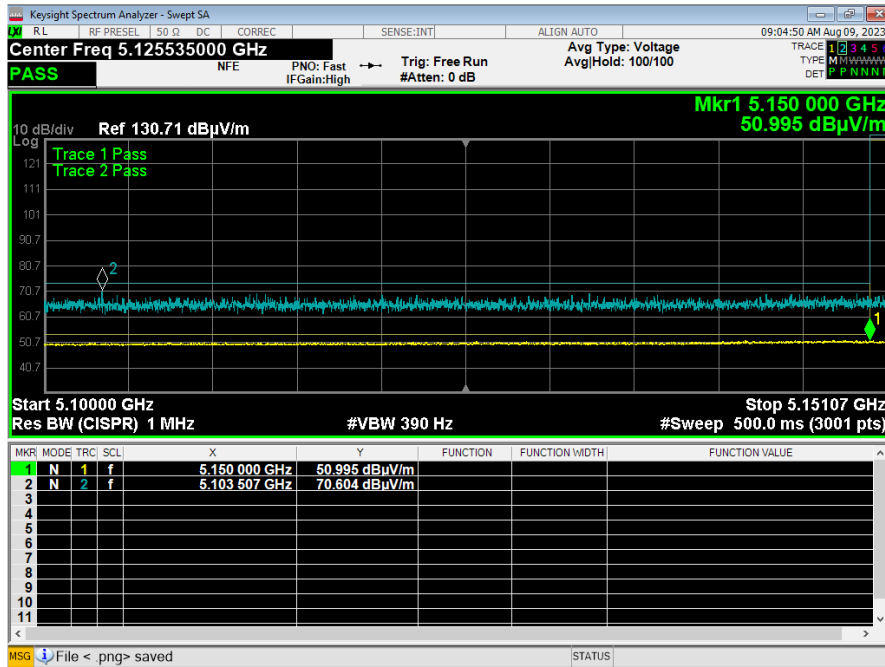

Plot 10: VHT 40 MHz 5230 MHz

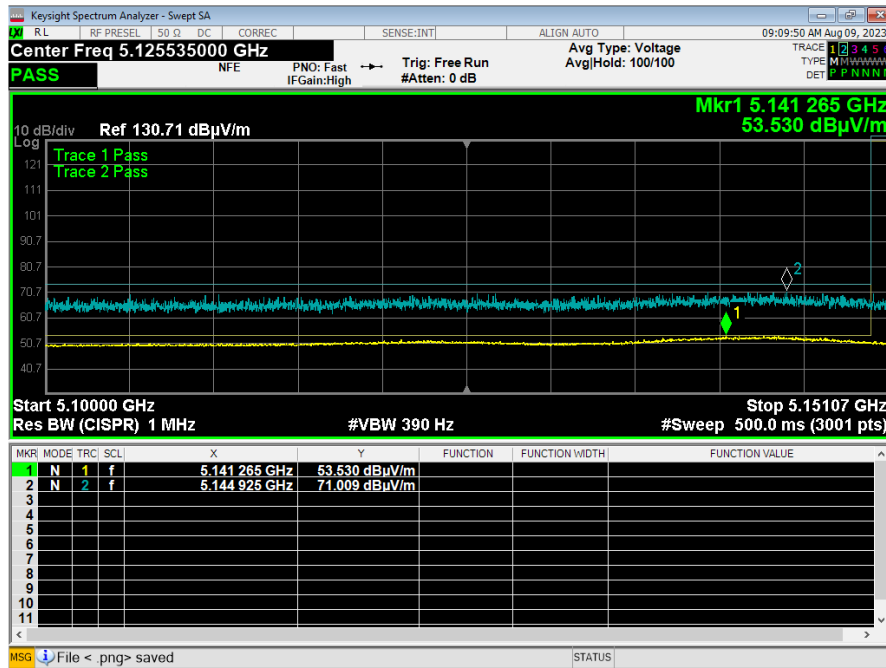

Plot 11: VHT 80 MHz 5210 MHz

5.5.4 Band Edge External Antenna

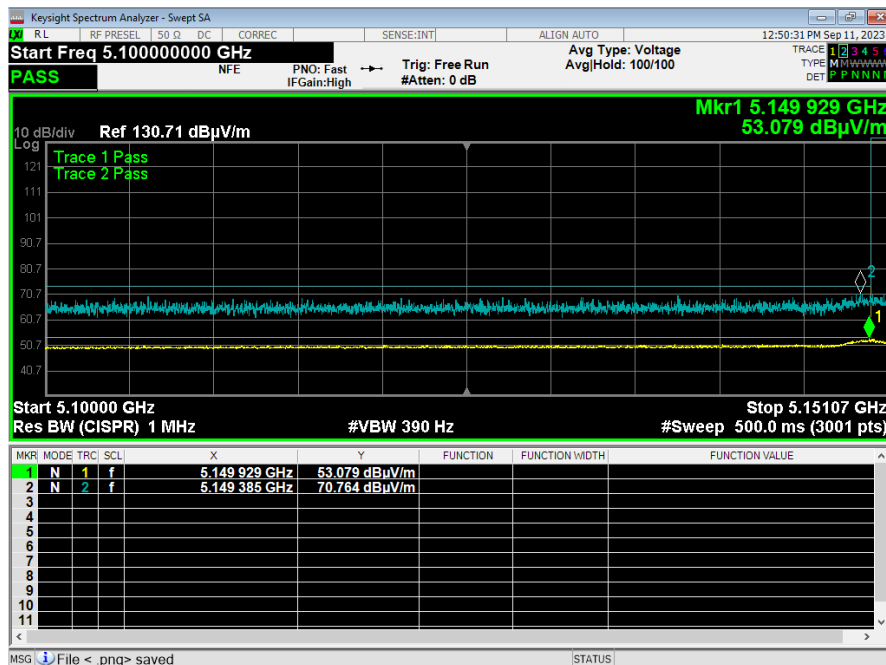

Plot 12: OFDM 20 MHz 5180 MHz

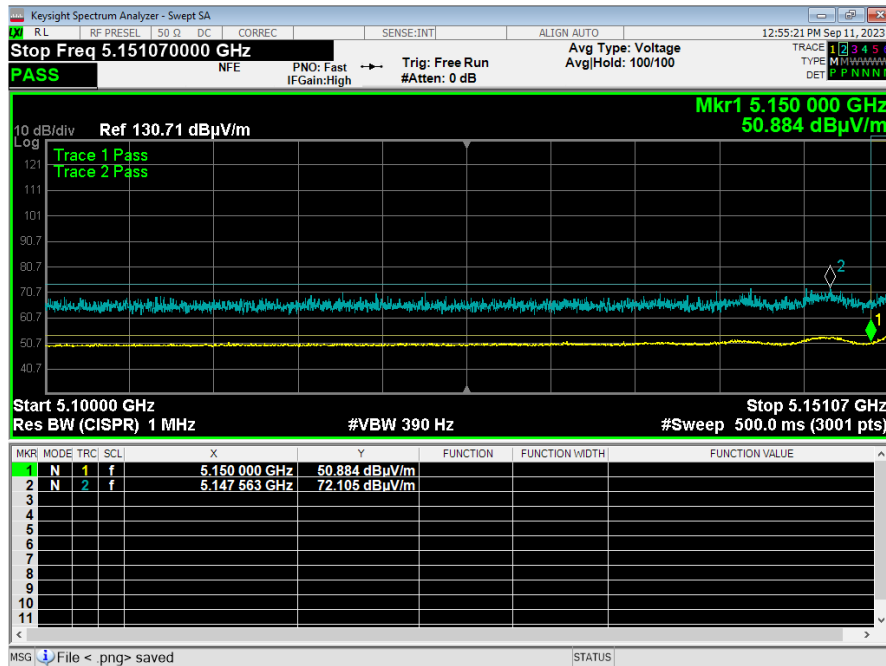

Plot 13: OFDM 20 MHz 5200 MHz

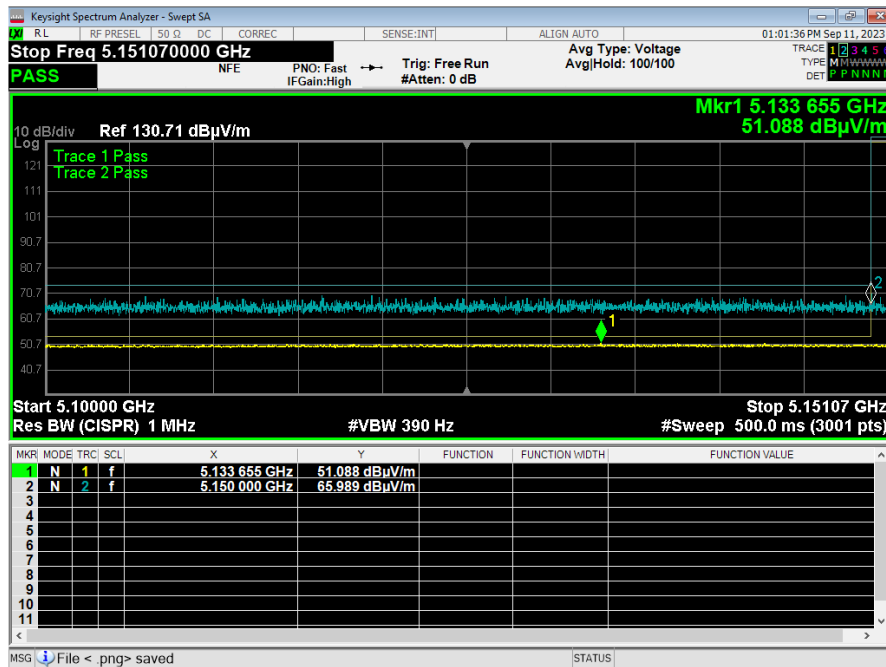

Plot 14: OFDM 20 MHz 5240 MHz

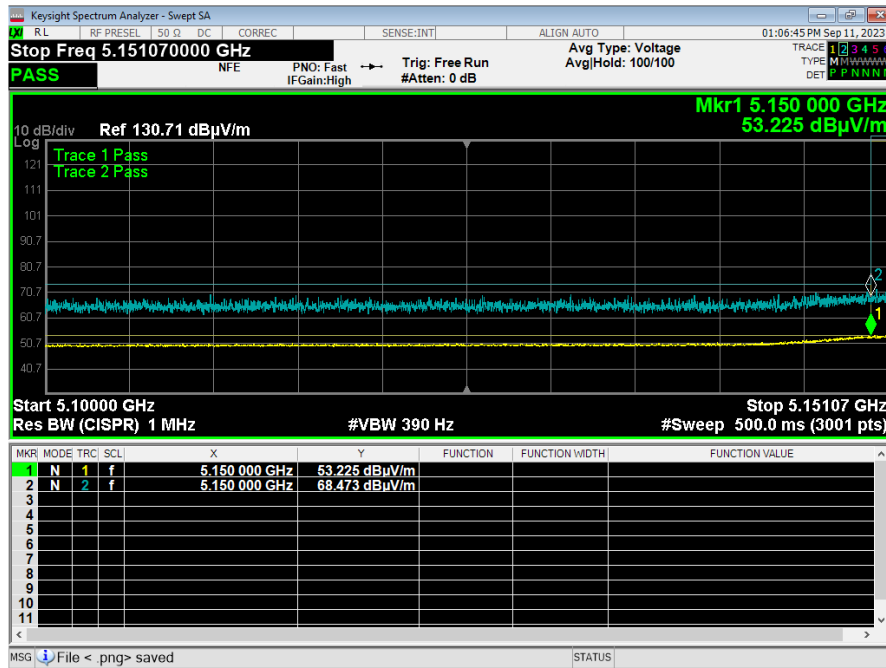

Plot 15: VHT 20 MHz 5180 MHz

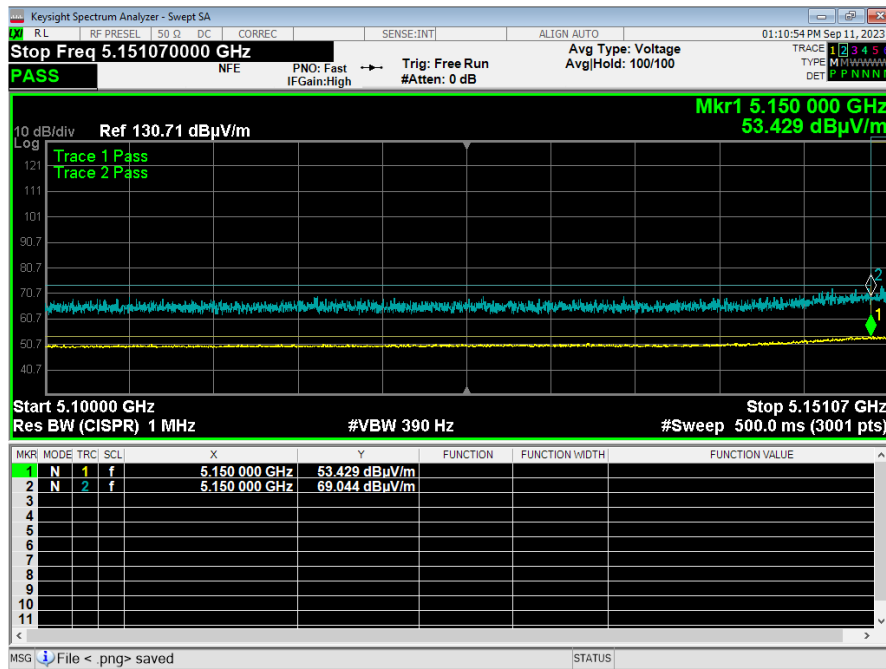

Plot 16: VHT 20 MHz 5200 MHz

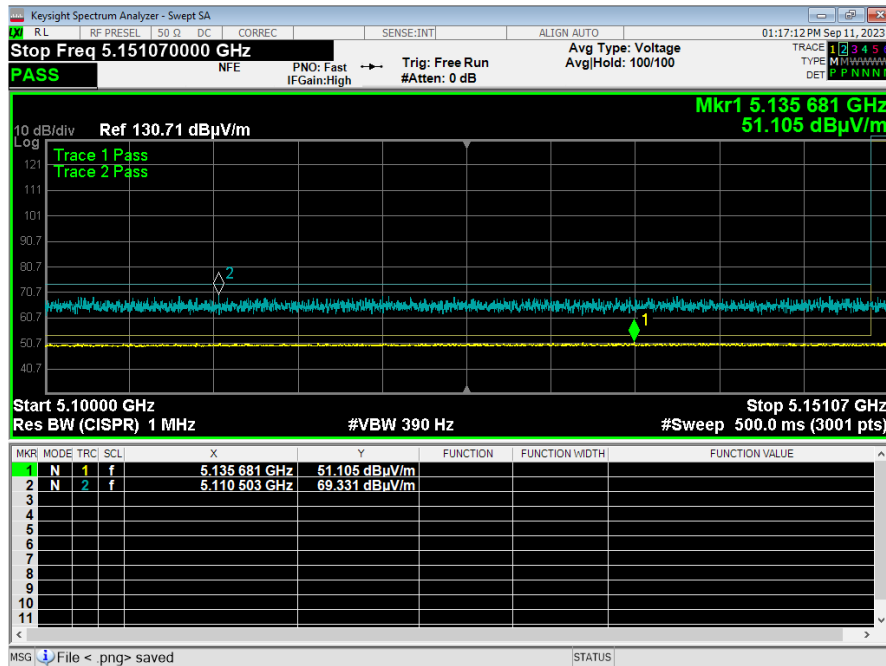

Plot 17: VHT 20 MHz 5240 MHz

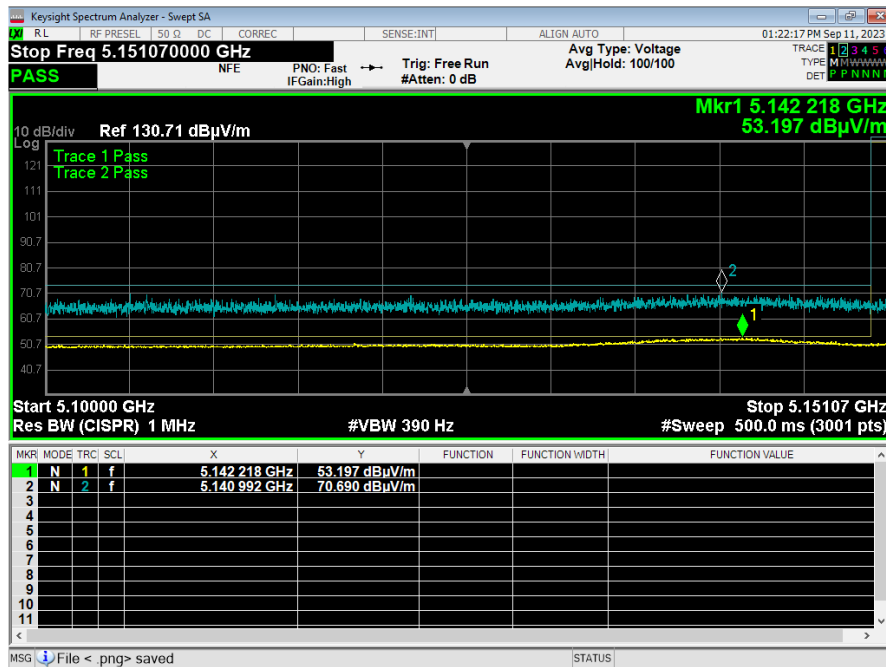

Plot 18: VHT 40 MHz 5190 MHz

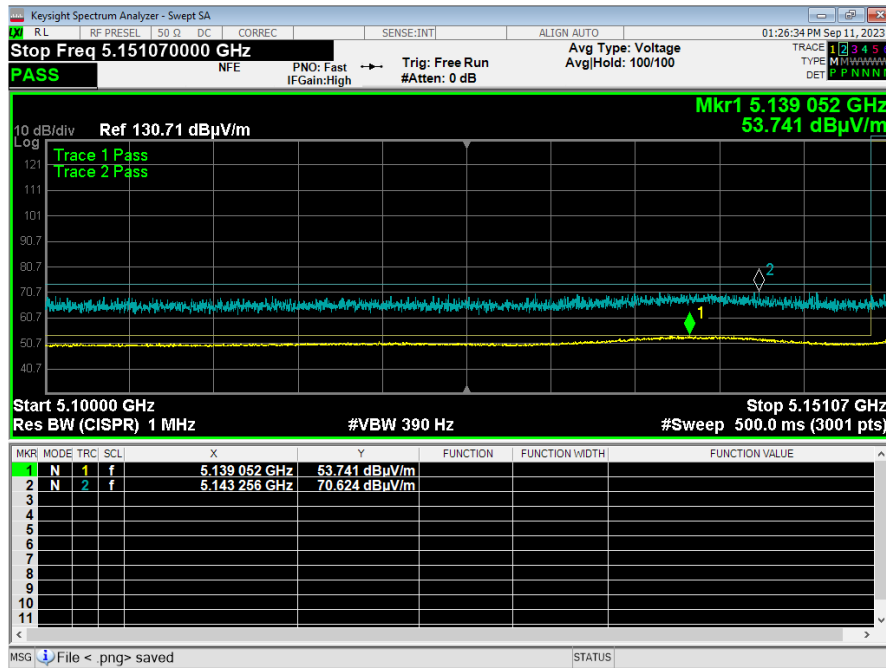

Plot 19: VHT 40 MHz 5230 MHz

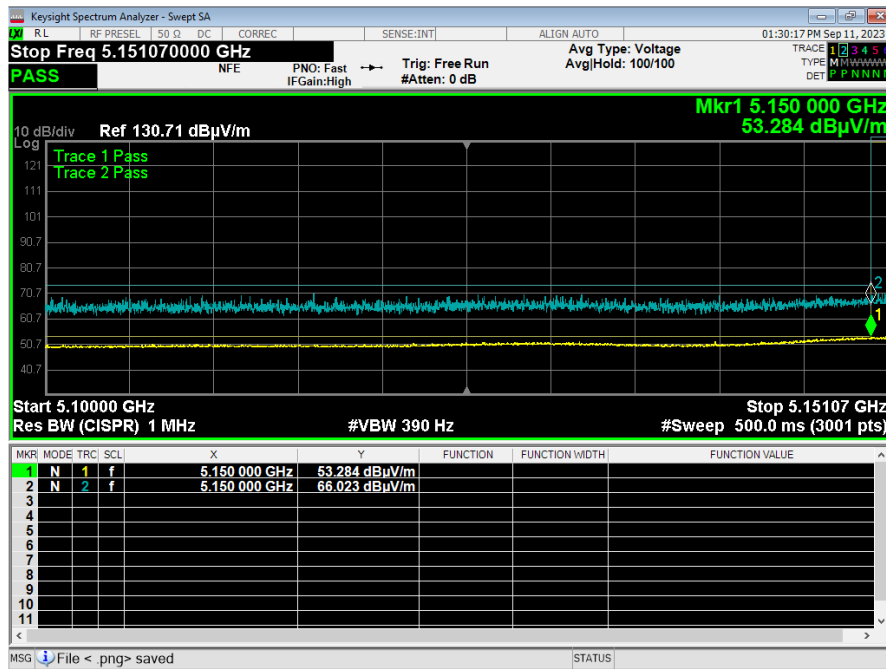

Plot 20: VHT 80 MHz 5210 MHz

5.6 §15.407(a) Maximum Power Spectral Density

All chains were measured and summed under the guidance of KDB 789033 Section II. F. and KDB 66291 D01. Please see associated annex for details on instrument settings.

The maximum average power spectral density conducted from the intentional radiator of the antenna shall not be greater than 17 dBm in any 1 MHz band during any time interval of continuous transmission.

As per KDB 662911, when the EUT is using spatial-multiplexing in HT to HE modes, there is not additional array gain to accommodate. When the EUT uses Nss=1 data rates, the internal antenna gain is 6.1 dBi + Array gain of 3.01 dB which is a total of 9.11 dBi. The external antenna gain is 4.57 dBi + array gain of 3.01 which is a total of 7.58 dBi.

Results of this testing are summarized.

5.6.1 Internal Antenna

Modulation (BW)	Frequency (MHz)	Data Rate	TP Setting	Measured PSD
OFDM 20	5180	Mcs0	18	7.10
OFDM 20	5210	Mcs0	18	7.58
OFDM 20	5240	Mcs0	20	9.03
VHT 20	5180	Mcs0	18	7.18
VHT 20	5210	Mcs0	18	7.35
VHT 20	5240	Mcs0	20	8.47
VHT 40	5190	Mcs0	16	1.46
VHT 40	5230	Mcs0	20	5.00
VHT 80	5210	Mcs0	15	-2.60

5.6.2 Omni External Antenna

Modulation (BW)	Frequency (MHz)	Data Rate	TP Setting	Measured PSD
OFDM 20	5180	Mcs0	16	5.59
OFDM 20	5210	Mcs0	19	7.92
OFDM 20	5240	Mcs0	19	7.37
VHT 20	5180	Mcs0	16	5.24
VHT 20	5210	Mcs0	19	7.85
VHT 20	5240	Mcs0	19	7.51
VHT 40	5190	Mcs0	16	1.66
VHT 40	5230	Mcs0	19	4.26
VHT 80	5210	Mcs0	13	-4.85

Result

The maximum summed average power spectral density was less than the limit of 17dBm; therefore, the EUT complies with the specification.

-- End of Test Report --