



FCC RADIO TEST REPORT

Applicant : Ubiquiti Inc.
Address : 685 Third Avenue, New York, New York 10017, USA
Equipment : UISP Switch Plus
Model No. : UISP-S-Plus
Trade Name : UBIQUITI
FCC ID. : SWX-UISPSPS

I HEREBY CERTIFY THAT:

The sample was received on Mar. 18, 2023 and the testing was completed on Sep. 21, 2023 at CerpPASS Technology Corp. The test result refers exclusively to the test presented test model / sample. Without written approval of CerpPASS Technology Corp., the test report shall not be reproduced except in full.

Approved by:

Mark Liao / Supervisor

Laboratory Accreditation:

CerpPASS Technology Corporation Test Laboratory





CONTENTS

1. Summary of Test Procedure and Test Results	5
1.1 Applicable Standards	5
2. Test Configuration of Equipment under Test	6
2.1 Feature of Equipment under Test	6
2.2 Carrier Frequency of Channels	6
2.3 Test Mode and Test Software	7
2.4 Description of Test System	8
2.5 General Information of Test	9
2.6 Measurement Uncertainty	10
3. Test Equipment and Ancillaries Used for Tests	11
4. Antenna Requirements	14
4.1 Standard Applicable	14
4.2 Antenna Construction and Directional Gain	14
5. Test of AC Power Line Conducted Emission	15
5.1 Test Limit	15
5.2 Test Procedures	15
5.3 Typical Test Setup	16
5.4 Test Result and Data	17
5.5 Test Photographs	19
6. Test of Spurious Emission (Radiated)	20
6.1 Test Limit	20
6.2 Test Procedures	21
6.3 Typical Test Setup	22
6.4 Test Result and Data (9kHz ~ 30MHz)	23
6.5 Test Result and Data (30MHz ~ 1GHz)	23
6.6 Test Result and Data (1GHz ~ 25GHz)	25
6.7 Restricted Bands of Operation	31
6.8 Test Photographs (30MHz ~ 1GHz)	32
6.9 Test Photographs (1GHz ~ 25GHz)	33
7. Test of Spurious Emission (Conducted)	35
7.1 Test Limit	35
7.2 Test Procedure	35
7.3 Test Setup Layout	35
7.4 Test Result and Data	35
8. On Time, Duty Cycle and Measurement methods	38
8.1 Test Limit	38
8.2 Test Procedure	38
8.3 Test Setup Layout	38
8.4 Test Result and Data	38
9. 6dB Bandwidth Measurement Data	39
9.1 Test Limit	39
9.2 Test Procedures	39



- 9.3 Test Setup Layout 39
- 9.4 Test Result and Data 39
- 10. Maximum Average Output Power 41**
 - 10.1 Test Limit 41
 - 10.2 Test Procedures 41
 - 10.3 Test Setup Layout 41
 - 10.4 Test Result and Data 41
- 11. Power Spectral Density 42**
 - 11.1 Test Limit 42
 - 11.2 Test Procedures 42
 - 11.3 Test Setup Layout 42
 - 11.4 Test Result and Data 42
- 12. Radio Frequency Exposure 44**
 - 12.1 Applicable Standards 44
 - 12.2 EUT Specification 45
 - 12.3 Test Result 45



History of this test report

Report No.	Issued Date	Description
23020209-TRFCC01	Oct. 06, 2023	Original



1. Summary of Test Procedure and Test Results

1.1 Applicable Standards

ANSI C63.10:2013

FCC Rules and Regulations Part 15 Subpart C §15.247

FCC Rule	Description of Test	Result
15.203	. Antenna Requirement	PASS
15.207	. AC Power Line Conducted Emission	PASS
15.209 15.205	. Radiated Spurious Emission	PASS
15.247(d)	. Conducted Spurious Emission	PASS
15.247(a)(2)	. 6dB Bandwidth	PASS
15.247(b)	. Maximum Output Power	PASS
15.247(e)	. Power Spectral Density	PASS
2.1091	. Radio Frequency Exposure	PASS

*The lab has reduced the uncertainty risk factor from test equipment, environment and staff technicians which according to the standard on contract. Therefore, the test result will only be determined by standard requirement, measurement uncertainty evaluation is not considered.



2. Test Configuration of Equipment under Test

2.1 Feature of Equipment under Test

Operation Frequency Range	2400MHz ~ 2483.5MHz
Center Frequency Range	2402MHz ~ 2480MHz
Modulation Type	GFSK
Modulation Technology	DTS
Data Rate	1Mbps
Antenna Type	PIFA
Antenna Gain	3.50 dBi
AC Adapter	Brand: UBIQUITI Model: UACC-Adapter-PT-190W
PTC to DC Plug Cable	Brand: UBIQUITI Model: 680-00322

Note: For more details, please refer to the User's manual of the EUT.

2.2 Carrier Frequency of Channels

Channel	Frequency (MHz)	Channel	Frequency (MHz)	Channel	Frequency (MHz)
*00	2402	14	2430	28	2458
01	2404	15	2432	29	2460
02	2406	16	2434	30	2462
03	2408	17	2436	31	2464
04	2410	18	2438	32	2466
05	2412	*19	2440	33	2468
06	2414	20	2442	34	2470
07	2416	21	2444	35	2472
08	2418	22	2446	36	2474
09	2420	23	2448	37	2476
10	2422	24	2450	38	2478
11	2424	25	2452	*39	2480
12	2426	26	2454	--	--
13	2428	27	2456	--	--

Note: Channels remarked * are selected to perform test.



2.3 Test Mode and Test Software

- a. During testing, the interface cables and equipment positions were varied according to ANSI C63.10.
- b. The complete test system included Notebook, USB 3.0 RJ45 2.5Gigabit Ethernet Adapter and EUT for RF test.
- c. An executive program, "command" under Windows 10 system was executed to transmit and receive data via Bluetooth.
- d. The following test modes were performed for the test:

Conducted Emissions from the AC mains power ports	
Test Mode	Operating Description
1	AC 120V / 60Hz, GFSK (1Mbps), From Adapter, TX Mode
2	AC 240V / 60Hz, GFSK (1Mbps), From Adapter, TX Mode
3	DC 27V / 6A, GFSK (1Mbps), From DC Power Supply (AC 120V / 60Hz), TX Mode
caused "Test Mode 3" generated the worst case, it was reported as the final data.	
Radiation Emissions (Below 1GHz)	
Test Mode	Operating Description
1	AC 120V / 60Hz, GFSK (1Mbps), From Adapter, TX Mode
2	AC 240V / 60Hz, GFSK (1Mbps), From Adapter, TX Mode
3	DC 27V / 6A, GFSK (1Mbps), From DC Power Supply (AC 120V / 60Hz), TX Mode
caused "Test Mode 2" generated the worst case, it was reported as the final data.	
Radiation Emissions (Above 1GHz)	
Test Mode	Operating Description
1	AC 120V / 60Hz, GFSK (1Mbps), From Adapter, TX Mode
2	AC 240V / 60Hz, GFSK (1Mbps), From Adapter, TX Mode
3	DC 27V / 6A, GFSK (1Mbps), From DC Power Supply (AC 120V / 60Hz), TX Mode
caused "Test Mode 2" generated the worst case, they were reported as the final data.	

Modulation Type	TX CONFIGURATION
GFSK (1Mbps)	1TX

**2.4 Description of Test System**

RF Conducted				
Equipment	Brand	Model	Length/Type	Power cord/ Length/Type
Notebook	Lenovo	S1GL2W	N/A	Adapter / 1.8m / NS
USB 3.0 to RJ45 2.5Gigabit Ethernet Adapter	Kamera	KA-UA2.5G	N/A	N/A
RJ45 Cable	TE CONNECTIVITY	CAT5E	1.2m / NS	N/A

Radiated Emissions				
Equipment	Brand	Model	Length/Type	Power cord/ Length/Type
Notebook	ASUS	P2430U	N/A	Adapter / 1.8m / NS
USB 3.0 to RJ45 2.5Gigabit Ethernet Adapter	Kamera	KA-UA2.5G	N/A	N/A
RJ45 Cable	TE CONNECTIVITY	CAT5E	15m / NS	N/A
Power Cord	KING-CORD	KC-003	1m / NS	N/A
Power Transport Cable	UBIQUITI	680-00322	0.2m / NS	N/A
Alligator Clip	Sconline	Red&Black	0.9m / NS	N/A
DC Power Supply	Gwinstek	GPR-360600	N/A	N/A

AC Power Line Conducted Emission				
Equipment	Brand	Model	Length/Type	Power cord/ Length/Type
Notebook	ASUS	P2430U	N/A	Adapter / 1.8m / NS
USB 3.0 to RJ45 2.5Gigabit Ethernet Adapter	Kamera	KA-UA2.5G	N/A	N/A
RJ45 Cable	TE CONNECTIVITY	CAT5E	1.2m / NS	N/A
Power Transport Cable	UBIQUITI	680-00322	0.2m / NS	N/A
Alligator Clip	Sconline	Red&Black	0.9m / NS	N/A
DC Power Supply	Gwinstek	GPR-360600	N/A	N/A



2.5 General Information of Test

Test Site	CerpPASS Technology Corporation Test Laboratory Address: No.10, Ln. 2, Lianfu St., Luzhu Dist., Taoyuan City 33848, Taiwan (R.O.C.) Tel: +886-3-3226-888 Fax: +886-3-3226-881	
	FCC	TW1439, TW1079
	IC	4934E-1, 4934E-2
Frequency Range Investigated:	Conducted: from 150kHz to 30 MHz Radiation: from 30 MHz to 25,000MHz	
Test Distance:	The test distance of radiated emission from antenna to EUT is 3 M.	

Test Item	Test Site	Test period	Environmental Conditions	Tested By
RF Conducted	RFCON02-NK	2023/03/27	23.5°C / 52%	Leon Huang
Radiated Emissions	3M02-NK	2023/03/22 ~ 2023/04/17	19~23°C / 35~39%	Leon Huang
Radiated Emissions	3M02-NK	2023/09/21	17°C / 46%	Leon Huang
AC Power Line Conducted Emission	CON02-NK	2023/09/21	23.9°C / 70%	Leon Huang



2.6 Measurement Uncertainty

ISO/IEC 17025 requires that an estimate of the measurement uncertainties associated with the emissions test results be included in the report. The measurement uncertainties given below are based on a 95% confidence level (based on a coverage factor (k=2)).

Test date before 2023/05/03

Measurement Item	Uncertainty
AC Power Line Conduction(150K~30MHz)	±3.28dB
Radiated Spurious Emission(9KHz~30MHz)	±3.4dB
Radiated Spurious Emission(30MHz~1GHz)	±5.7dB
Radiated Spurious Emission(1GHz~25GHz)	±6.8dB
Conducted Spurious Emission	±1.8dB
6dB Bandwidth	±4.4%
20dB Bandwidth	±4.4%
Occupied Bandwidth	±4.4%
Peak Output Power(Conducted Power Meter)	±1.1dB
Dwell Time / Deactivation Time	±1.2%
Power Spectral Density	±1.8dB
Duty Cycle	±1.2%

Test date after 2023/05/03

Measurement Item	Uncertainty
AC Power Line Conduction(150K~30MHz)	±3.28dB
Radiated Spurious Emission(9KHz~30MHz)	±3.5dB
Radiated Spurious Emission(30MHz~1GHz)	±5.1dB
Radiated Spurious Emission(1GHz~40GHz)	±5.2dB
Conducted Spurious Emission	±2.1dB
6dB Bandwidth	±5.4%
20dB Bandwidth	±4.4%
Occupied Bandwidth	±4.5%
Peak Output Power(Conducted Power Meter)	±1.1dB
Dwell Time / Deactivation Time	±7.6%
Power Spectral Density	±2.0dB
Duty Cycle	±3.5%



3. Test Equipment and Ancillaries Used for Tests

Test Item	Radiated Emissions (2023/03/22~2023/04/17)				
Test Site	Semi Anechoic Room (3M02-NK)				
Instrument	Manufacturer	Model No	Serial No	Calibration Date	Valid Date
Bilog Antenna	Schwarzbeck	VULB9168	275	2022/11/18	2023/11/17
Active Loop Antenna	EMCO	6507	40855	2022/05/25	2023/05/24
Horn Antenna	EMCO	3115	31601	2022/10/12	2023/10/11
Horn Antenna	EMCO	3116	31970	2023/03/03	2024/03/02
EMI Receiver	R&S	ESCI	101423	2022/07/05	2023/07/04
Spectrum Analyzer	R&S	FSV 40-N	102151	2022/08/19	2023/08/18
Preamplifier	Agilent	8449B	3008A01954	2023/03/08	2024/03/07
Preamplifier	EMC INSTRUMENTS	EMC184045	980065	2022/11/11	2023/11/10
Preamplifier	EM Electronics corp.	EM330	60659	2023/03/10	2024/03/09
Cable-6m (9kHz~300MHz)	NA	EMC5D-BM-BM-6	130605	2022/09/06	2023/09/05
Cable-3in1 (30MHz-1GHz)	HARBOUR INDUSTRIES	LL142	CCE1315	2023/02/25	2024/02/24
Cable-0.5m (1GHz-40GHz)	HUBER SUHNER	SUCOFLEX 104	805443/4	2023/03/07	2024/03/06
Cable-3m (1GHz-40GHz)	HUBER SUHNER	SUCOFLEX 104	805796/4	2023/03/07	2024/03/06
Cable-8m (1GHz-26.5GHz)	WOKEN	WCBA-WCA20 3SM	CCE1374	2023/03/07	2024/03/06
Cable-0.5m (30MHz-40GHz)	HUBER SUHNER	SUCOFLEX 102	28420/2	2023/03/07	2024/03/06
Cable-3m (30MHz-40GHz)	HUBER SUHNER	SUCOFLEX 102	MY2608/2	2023/03/07	2024/03/06
Cable-0.5m (1GHz-40GHz)	Rapidtek	40GHZ 50CM	38MS-38MS50314	2023/03/07	2024/03/06
Cable-3m (1GHz-40GHz)	Rapidtek	40GHZ 300CM	38MS-38MS300314	2023/03/07	2024/03/06
E3	AUDIX	v8.2014-8-6	RK-000529	NA	NA



Test Item	Radiated Emissions (2023/09/21)				
Test Site	Semi Anechoic Room (3M02-NK)				
Instrument	Manufacturer	Model No	Serial No	Calibration Date	Valid Date
Bilog Antenna	Schwarzbeck	VULB9168	275	2022/11/18	2023/11/17
Active Loop Antenna	Schwarzbeck	FMZB 1513	414	2023/02/03	2024/02/02
Horn Antenna	EMCO	3115	31589	2023/03/23	2024/03/22
Horn Antenna	EMCO	3116	31970	2023/03/03	2024/03/02
EMI Receiver	ROHDE & SCHWARZ	ESCI	101423	2023/07/05	2024/07/04
Spectrum Analyzer	ROHDE & SCHWARZ	FSP 40	100047	2023/02/24	2024/02/23
Preamplifier	Agilent	8449B	3008A01954	2023/03/08	2024/03/07
Preamplifier	EMC INSTRUMENTS	EMC184045	980065	2022/11/11	2023/11/10
Preamplifier	EM Electronics corp.	EM330	60658	2022/10/04	2023/10/03
Cable-6m (9k~300M)	NA	EMC5D-BM-B M-6	130606	2023/03/13	2024/03/12
Cable-3in1 (30M-1G)	HARBOUR INDUSTRIES	LL142	CCE1315	2023/02/25	2024/02/24
Cable-0.5m (1G-40G)	HUBER SUHNER	SUCOFLEX 104	805443/4	2023/03/07	2024/03/06
Cable-3m (1G-40G)	HUBER SUHNER	SUCOFLEX 104	805796/4	2023/03/07	2024/03/06
Cable-8m (1G-26.5G)	WOKEN	WCBA-WCA20 3SM	CCE1374	2023/03/07	2024/03/06
Cable-0.5m (30M-40G)	HUBER SUHNER	SUCOFLEX 102	28420/2	2023/03/07	2024/03/06
Cable-3m (10M-40G)	HUBER SUHNER	SF102	804619/2	2022/10/11	2023/10/10
E3	AUDIX	v8.2014-8-6	RK-000529	NA	NA

Test Item	RF Conducted				
Test Site	RFCON02-NK				
Instrument	Manufacturer	Model No	Serial No	Calibration Date	Valid Date
CAX Signal Analyzer	KEYSIGHT	N9000B	MY57100339	2022/11/29	2023/11/28
Attenuator	KEYSIGHT	8491B	MY39250705	2022/10/06	2023/10/05
Power Meter	Anritsu	ML2495A	2034001	2022/10/06	2023/10/05
Power Sensor	Anritsu	MA2411B	1911175	2022/10/06	2023/10/05



Test Item	AC Power Line Conducted Emission				
Test Site	CON02-NK				
Instrument	Manufacturer	Model No	Serial No	Calibration Date	Valid Date
EMI Receiver	ROHDE & SCHWARZ	ESR 7	101906	2023/05/08	2024/05/07
TWO-LINE V-NETWORK	ROHDE & SCHWARZ	ENV216	102185	2023/08/29	2024/08/28
Cable-4m(9k-3G)	EMEC	RG-223	18274M	2023/07/31	2024/07/30
E3	AUDIX	v8.2014-8-6	RK-000536	NA	NA
EMI Receiver	ROHDE & SCHWARZ	ESR 7	101906	2023/05/08	2024/05/07



4. Antenna Requirements

4.1 Standard Applicable

For intentional device, according to FCC 47 CFR Section 15.203, an intentional radiator shall be designed to ensure that no antenna other than that furnished by the responsible party shall be used with the device.

And according to FCC 47 CFR Section 15.247 (b), if transmitting antennas of directional gain greater than 6dBi are used, the power shall be reduced by the amount in dB that the directional gain of the antenna exceeds 6dBi.

4.2 Antenna Construction and Directional Gain

Antenna Type	PIFA Antenna
Antenna Gain	3.5 dBi



5. Test of AC Power Line Conducted Emission

5.1 Test Limit

Conducted Emissions were measured from 150 kHz to 30 MHz with a bandwidth of 9 KHz, according to the methods defined in ANSI C63.10-2013. The EUT was placed on a nonmetallic stand in a shielded room 0.8 meters above the ground plane. The interface cables and equipment positioning were varied within limits of reasonable applications to determine the position produced maximum conducted emissions.

Frequency (MHz)	Quasi Peak (dB μ V)	Average (dB μ V)
0.15 – 0.5	66-56*	56-46*
0.5 – 5.0	56	46
5.0 – 30.0	60	50

*Decreases with the logarithm of the frequency.

5.2 Test Procedures

- a. The EUT was placed 0.4 meter from the conducting wall of the shielding room was kept at least 80 centimeters from any other grounded conducting surface.
- b. Connect EUT to the power mains through a line impedance stabilization network (LISN).
- c. All the support units are connecting to the other LISN.
- d. The LISN provides 50 ohm coupling impedance for the measuring instrument.
- e. The FCC states that a 50 ohm, 50 micro-Henry LISN should be used.
- f. Both sides of AC line were checked for maximum conducted interference.
- g. The frequency range from 150 kHz to 30 MHz was searched.
- h. Set the test-receiver system to Peak Detect Function and Specified Bandwidth with Maximum Hold Mode.



5.3 Typical Test Setup

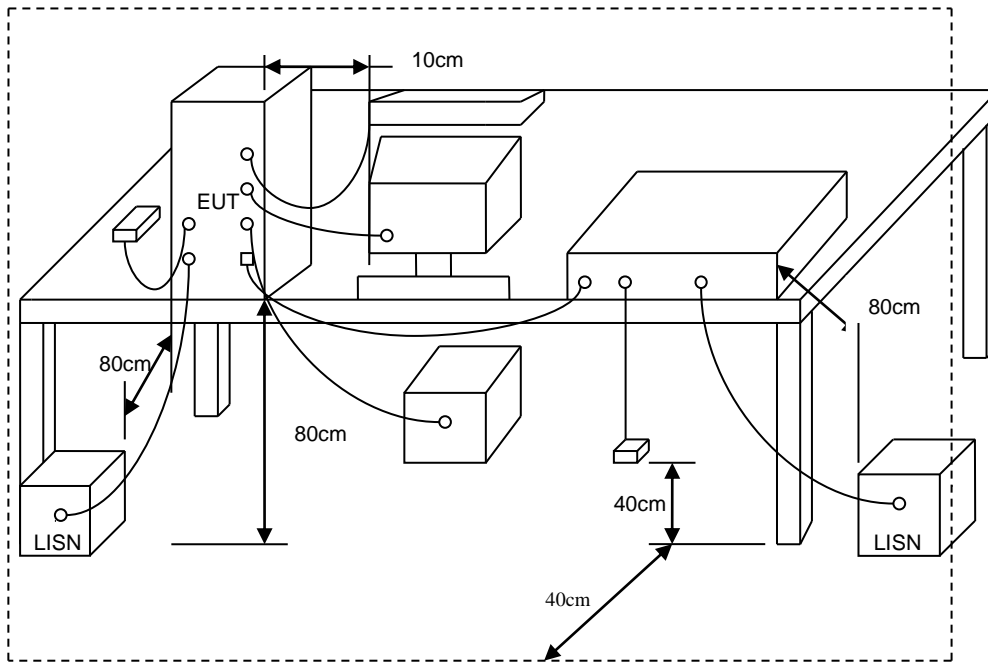



5.4 Test Result and Data

Power	: DC 27V / 6A from DC Power Supply (AC 120V / 60Hz)		
Test Mode	: Mode 3	Pol/Phase	: LINE

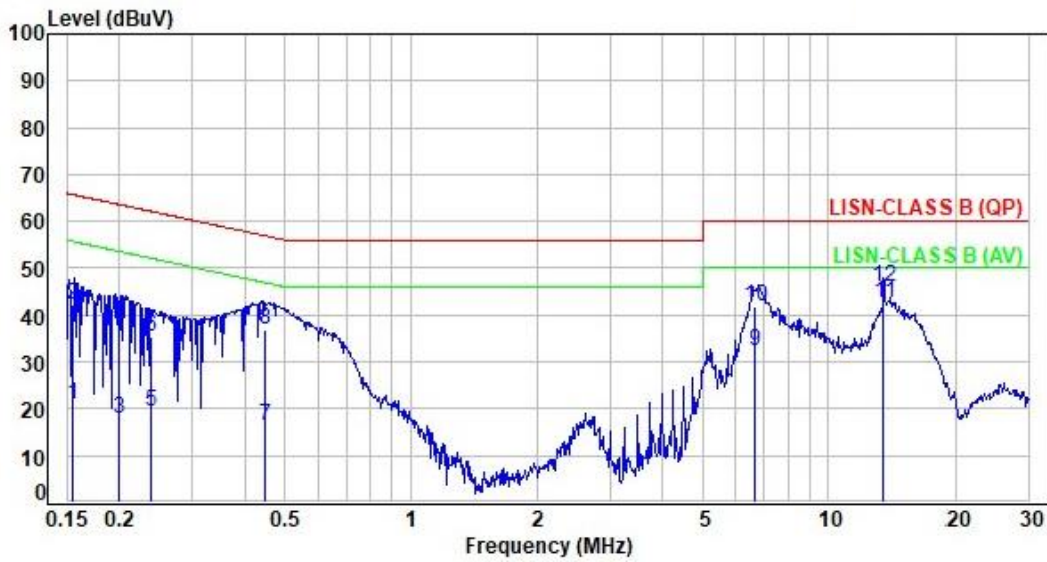

No.	Frequency (MHz)	Factor (dB)	Reading (dBuV)	Level (dBuV)	Limit (dBuV)	Margin (dB)	Detector	P/F
1	0.16	9.66	11.17	20.83	55.70	-34.87	Average	P
2	0.16	9.66	32.73	42.39	65.70	-23.31	QP	P
3	0.20	9.64	8.12	17.76	53.60	-35.84	Average	P
4	0.20	9.64	28.69	38.33	63.60	-25.27	QP	P
5	0.24	9.64	9.73	19.37	52.13	-32.76	Average	P
6	0.24	9.64	25.72	35.36	62.13	-26.77	QP	P
7	0.45	9.66	6.50	16.16	46.92	-30.76	Average	P
8	0.45	9.66	27.22	36.88	56.92	-20.04	QP	P
9	6.63	9.78	22.37	32.15	50.00	-17.85	Average	P
10	6.63	9.78	31.86	41.64	60.00	-18.36	QP	P
11	13.56	9.88	32.80	42.68	50.00	-7.32	Average	P
12	13.56	9.88	36.03	45.91	60.00	-14.09	QP	P

Note: Level=Reading+Factor
Margin=Level-Limit
Factor=(LISN or ISN or Current Probe)Factor + Cable Loss



Power	DC 27V / 6A from DC Power Supply (AC 120V / 60Hz)		
Test Mode	Mode 3	Pol/Phase	NEUTRAL

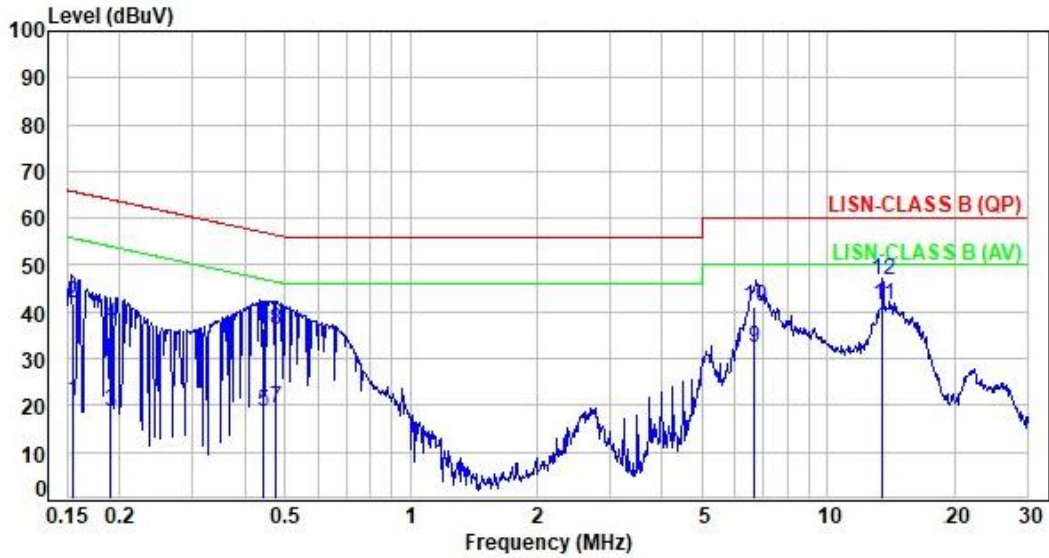

No.	Frequency (MHz)	Factor (dB)	Reading (dBuV)	Level (dBuV)	Limit (dBuV)	Margin (dB)	Detector	P/F
1	0.16	9.56	11.48	21.04	55.72	-34.68	Average	P
2	0.16	9.56	32.36	41.92	65.72	-23.80	QP	P
3	0.19	9.58	9.10	18.68	54.02	-35.34	Average	P
4	0.19	9.58	27.77	37.35	64.02	-26.67	QP	P
5	0.44	9.57	8.98	18.55	46.98	-28.43	Average	P
6	0.44	9.57	26.85	36.42	56.98	-20.56	QP	P
7	0.47	9.57	9.80	19.37	46.46	-27.09	Average	P
8	0.47	9.57	26.72	36.29	56.46	-20.17	QP	P
9	6.68	9.75	22.71	32.46	50.00	-17.54	Average	P
10	6.68	9.75	31.45	41.20	60.00	-18.80	QP	P
11	13.56	9.88	31.53	41.41	50.00	-8.59	Average	P
12	13.56	9.88	36.70	46.58	60.00	-13.42	QP	P

Note: Level=Reading+Factor
 Margin=Level-Limit
 Factor=(LISN or ISN or Current Probe)Factor + Cable Loss



6. Test of Spurious Emission (Radiated)

6.1 Test Limit

In any 100kHz bandwidth outside the frequency band in which the spread spectrum or digitally modulated intentional radiator is operating, the radio frequency power that is produced by the intentional radiator shall be at least 20dB below that in the 100kHz bandwidth within the band that contains the highest level of the desired power, based on either an RF conducted or a radiated measurement. If the transmitter measurement is based on the maximum conducted output power, the attenuation required under this paragraph shall be 30dB instead of 20dB. In addition, radiated emissions which fall in section 15.205(a) the restricted bands must also comply with the radiated emission limit specified in section 15.209(a).

Frequency (MHz)	Field Strength (microvolt/meter)	Measurement Distance (meters)
0.009 ~ 0.490	2400/F(kHz)	300
0.490 ~ 1.705	24000/F(kHz)	30
1.705 ~ 30.0	30	30
30 ~ 88	100	3
88 ~ 216	150	3
216 ~ 960	200	3
Above 960	500	3



6.2 Test Procedures

- a. The EUT was placed on a rotatable table top 0.8 meter above ground.
- b. The EUT was set 3 meters from the interference receiving antenna which was mounted on the top of a variable height antenna tower.
- c. The table was rotated 360 degrees to determine the position of the highest radiation.
- d. The antenna is a broadband antenna and its height is varied between one meter and four meters above ground to find the maximum value of the field strength both horizontal polarization and vertical polarization of the antenna are set to make the measurement.
- e. For each suspected emission the EUT was arranged to its worst case and then tune the antenna tower (from 1 M to 4 M) and turn table (from 0 degree to 360 degrees) to find the maximum reading.
- f. Set the test-receiver system to Peak or CISPR quasi-peak Detect Function and specified bandwidth with Maximum Hold Mode.
- g. If the emission level of the EUT in peak mode was 3 dB lower than the limit specified, then testing will be stopped and peak values of EUT will be reported, otherwise, the emissions which do not have 3 dB margin will be repeated one by one using the quasi-peak method and reported.
- h. For testing above 1GHz, the emission level of the EUT in peak mode was 20dB lower than average limit (that means the emission level in peak mode also complies with the limit in average mode), then testing will be stopped and peak values of EUT will be reported, otherwise, the emissions will be measured in average mode again and reported.
- i. "Cone of radiation" has been considered to be 3dB bandwidth of the measurement antenna.

Note:

1. The supporting fixture shall permit orientation of the EUT in each of three orthogonal axis positions such that emissions from the EUT are maximized. (Z-AXIS is the worst.)
2. Due to the test software function limit the operation band setting(200dBuV/m). There's no corresponding limitation in the actual test item.



6.3 Typical Test Setup

Below 30MHz test setup

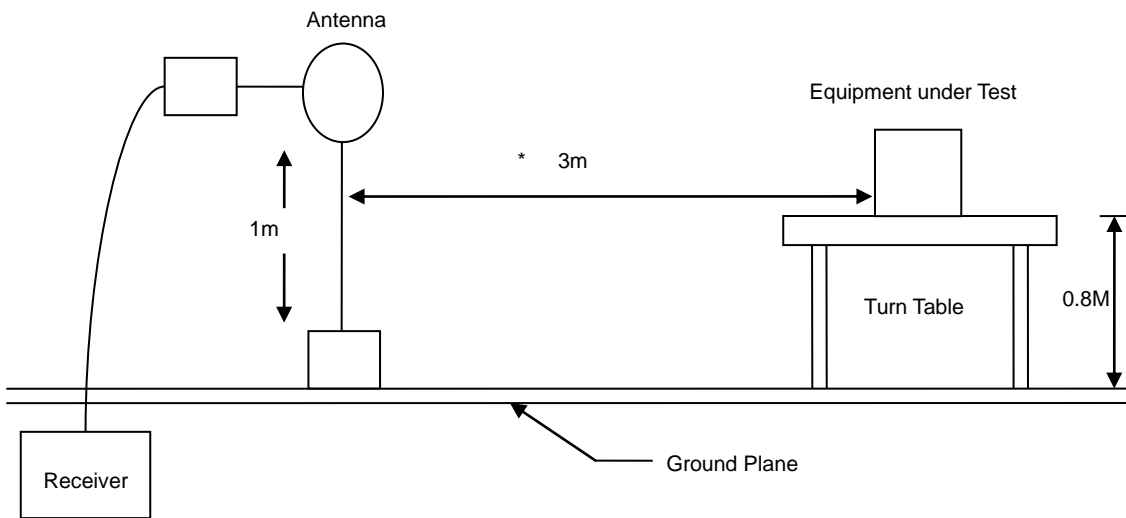

30MHz- 1GHz Test Setup

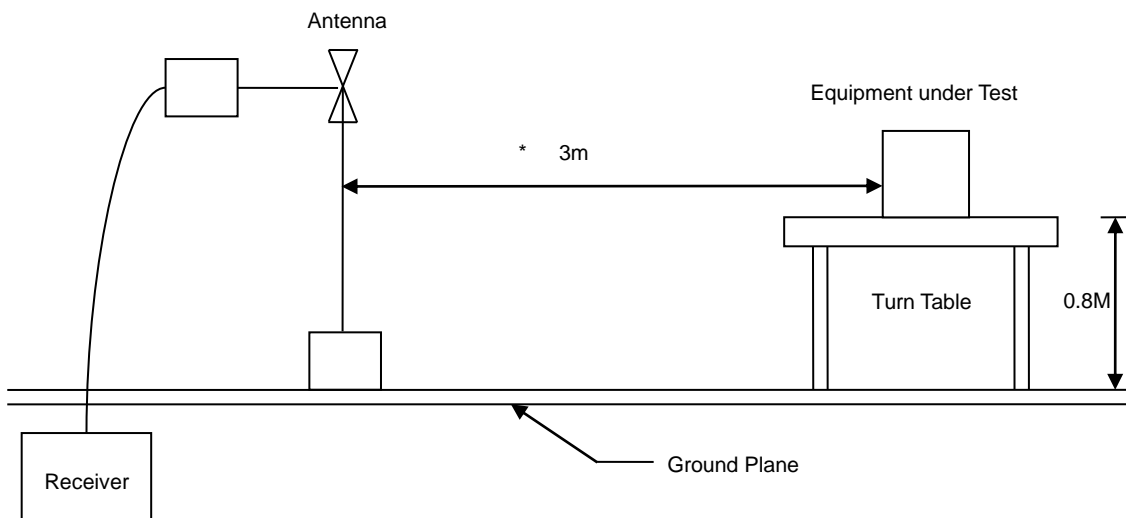

Above 1GHz Test Setup

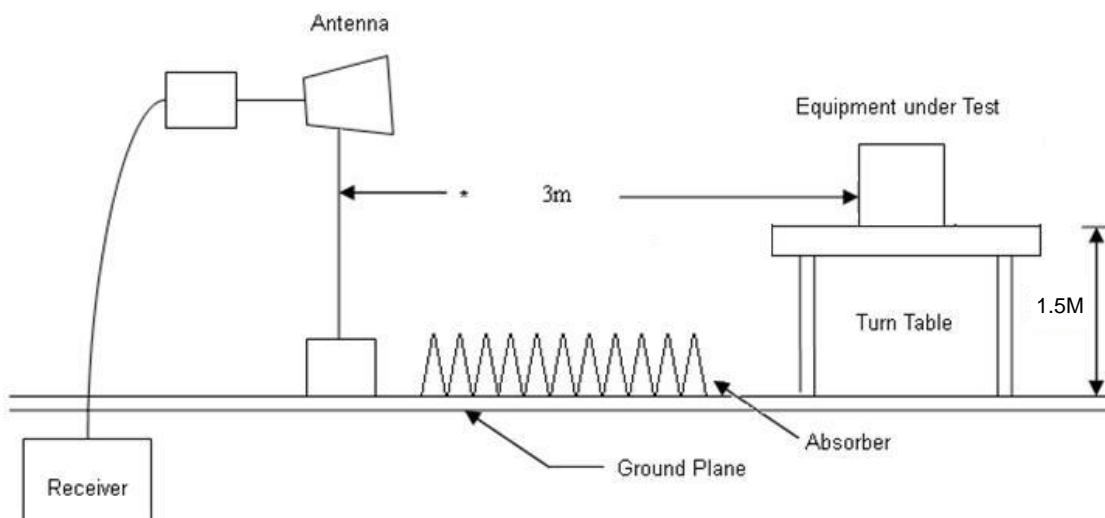



6.4 Test Result and Data (9kHz ~ 30MHz)

The 9kHz - 30MHz spurious emission is under limit 20dB more.

6.5 Test Result and Data (30MHz ~ 1GHz)

Power	: AC 240V / 60Hz	Pol/Phase	: VERTICAL
Test Mode	: Mode 2, CH00		:

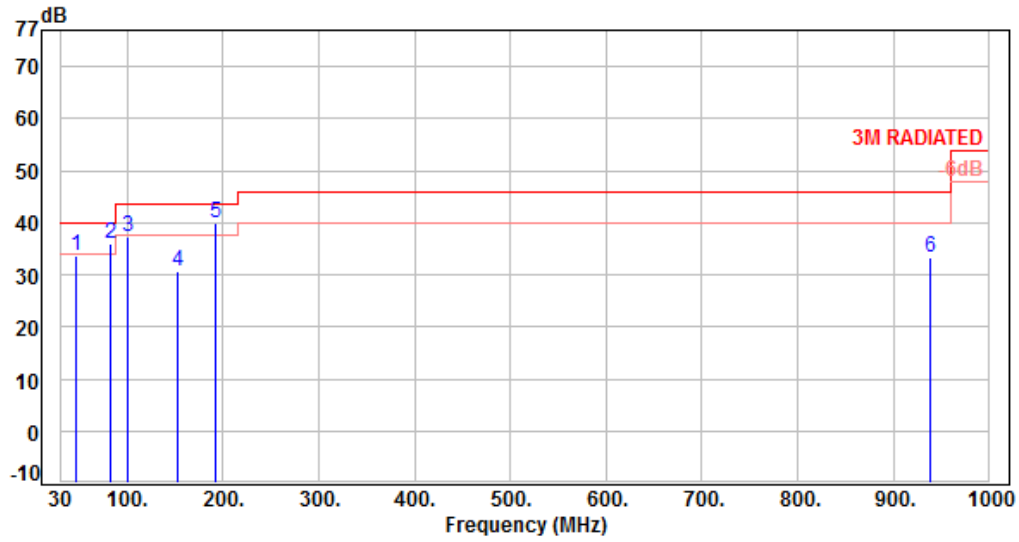

No.	Frequency (MHz)	Factor (dB)	Reading (dBuV)	Level (dBuV/m)	Limit (dBuV/m)	Margin (dB)	Detector	Height (cm)	Azimuth (deg)	P/F
1	47.46	-10.56	44.23	33.67	40.00	-6.33	Peak	400	0	P
2	82.38	-16.17	52.07	35.90	40.00	-4.10	Peak	400	0	P
3	99.84	-15.82	53.27	37.45	43.50	-6.05	Peak	400	0	P
4	152.22	-10.72	41.51	30.79	43.50	-12.71	Peak	400	0	P
5	192.96	-13.85	53.84	39.99	43.50	-3.51	Peak	400	0	P
6	937.92	2.69	30.70	33.39	46.00	-12.61	Peak	400	0	P

Note: Level=Reading+Factor
 Margin=Level-Limit
 Factor=Antenna Factor + cable loss - Amplifier Factor



Power	: AC 240V / 60Hz	Pol/Phase	: HORIZONTAL
Test Mode	: Mode 2, CH00		

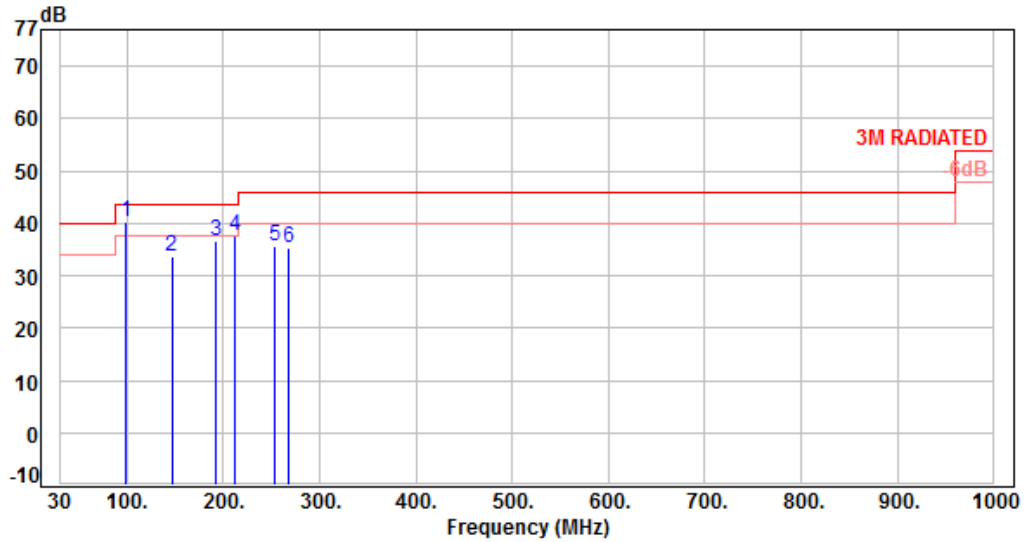

No.	Frequency (MHz)	Factor (dB)	Reading (dBuV)	Level (dBuV/m)	Limit (dBuV/m)	Margin (dB)	Detector	Height (cm)	Azimuth (deg)	P/F
1	97.90	-16.04	56.38	40.34	43.50	-3.16	Peak	400	360	P
2	146.40	-10.86	44.47	33.61	43.50	-9.89	Peak	400	360	P
3	192.96	-13.85	50.65	36.80	43.50	-6.70	Peak	400	360	P
4	212.36	-13.91	51.67	37.76	43.50	-5.74	Peak	400	360	P
5	253.10	-11.93	47.58	35.65	46.00	-10.35	Peak	400	360	P
6	268.62	-11.25	46.42	35.17	46.00	-10.83	Peak	400	360	P

Note: Level=Reading+Factor
Margin=Level-Limit
Factor=Antenna Factor + cable loss - Amplifier Factor



6.6 Test Result and Data (1GHz ~ 25GHz)

Power	: AC 240V / 60Hz	Pol/Phase	: VERTICAL
Test Mode	: Mode 2, CH00		:

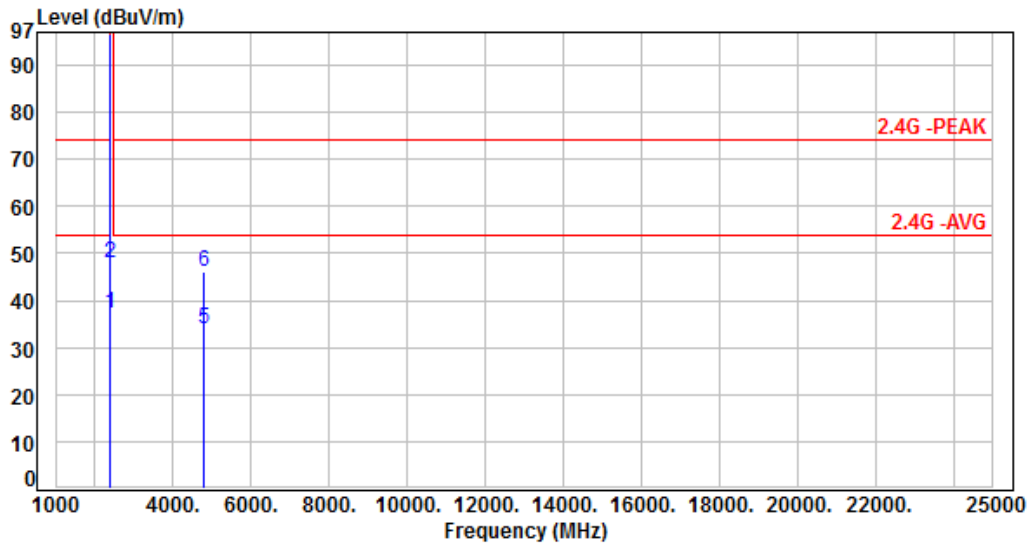

No.	Frequency (MHz)	Factor (dB)	Reading (dBuV)	Level (dBuV/m)	Limit (dBuV/m)	Margin (dB)	Detector	Height (cm)	Azimuth (deg)	P/F
1	2390.00	-2.92	40.32	37.40	54.00	-16.60	Average	100	326	P
2	2390.00	-2.92	50.73	47.81	74.00	-26.19	Peak	100	326	P
3	2402.00	-3.07	98.66	95.59	200.00	-104.41	Average	100	326	P
4	2402.00	-3.07	99.65	96.58	200.00	-103.42	Peak	100	326	P
5	4804.00	5.60	28.43	34.03	54.00	-19.97	Average	100	16	P
6	4804.00	5.60	40.54	46.14	74.00	-27.86	Peak	100	16	P

Note: Level=Reading+Factor
 Margin=Level-Limit
 Factor=Antenna Factor + cable loss - Amplifier Factor



Power	: AC 240V / 60Hz	Pol/Phase	: HORIZONTAL
Test Mode	: Mode 2, CH00		

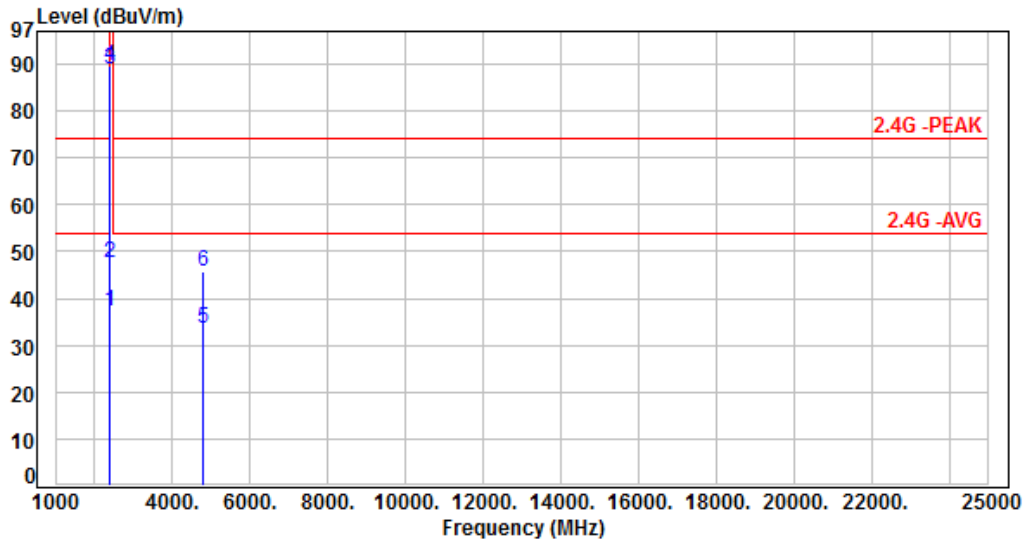

No.	Frequency (MHz)	Factor (dB)	Reading (dBuV)	Level (dBuV/m)	Limit (dBuV/m)	Margin (dB)	Detector	Height (cm)	Azimuth (deg)	P/F
1	2390.00	-2.92	40.16	37.24	54.00	-16.76	Average	394	282	P
2	2390.00	-2.92	50.60	47.68	74.00	-26.32	Peak	394	282	P
3	2402.00	-3.07	92.10	89.03	200.00	-110.97	Average	394	282	P
4	2402.00	-3.07	92.87	89.80	200.00	-110.20	Peak	394	282	P
5	4804.00	5.60	28.13	33.73	54.00	-20.27	Average	100	296	P
6	4804.00	5.60	40.21	45.81	74.00	-28.19	Peak	100	296	P

Note: Level=Reading+Factor
 Margin=Level-Limit
 Factor=Antenna Factor + cable loss - Amplifier Factor



Power	: AC 240V / 60Hz	Pol/Phase	: VERTICAL
Test Mode	: Mode 2, CH19		:

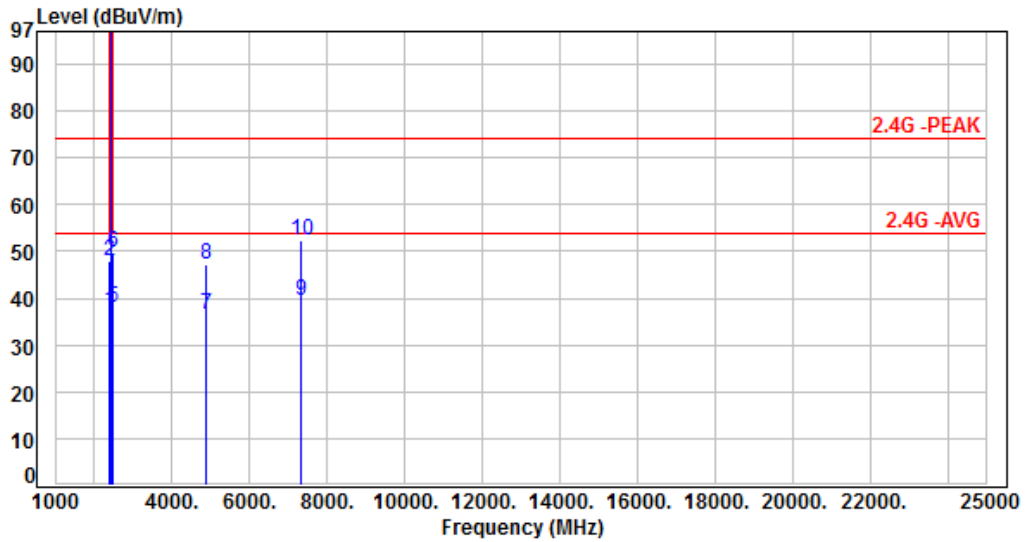

No.	Frequency (MHz)	Factor (dB)	Reading (dBuV)	Level (dBuV/m)	Limit (dBuV/m)	Margin (dB)	Detector	Height (cm)	Azimuth (deg)	P/F
1	2390.00	-2.92	40.23	37.31	54.00	-16.69	Average	109	325	P
2	2390.00	-2.92	50.71	47.79	74.00	-26.21	Peak	109	325	P
3	2440.00	-2.34	99.19	96.85	200.00	-103.15	Average	109	325	P
4	2440.00	-2.34	100.16	97.82	200.00	-102.18	Peak	109	325	P
5	2483.50	-2.04	40.11	38.07	54.00	-15.93	Average	109	325	P
6	2483.50	-2.04	51.95	49.91	74.00	-24.09	Peak	109	325	P
7	4880.00	5.94	30.40	36.34	54.00	-17.66	Average	100	8	P
8	4880.00	5.94	41.38	47.32	74.00	-26.68	Peak	100	8	P
9	7320.00	10.91	28.68	39.59	54.00	-14.41	Average	100	34	P
10	7320.00	10.91	41.64	52.55	74.00	-21.45	Peak	100	34	P

Note: Level=Reading+Factor
 Margin=Level-Limit
 Factor=Antenna Factor + cable loss - Amplifier Factor



Power	: AC 240V / 60Hz	Pol/Phase	: HORIZONTAL
Test Mode	: Mode 2, CH19		

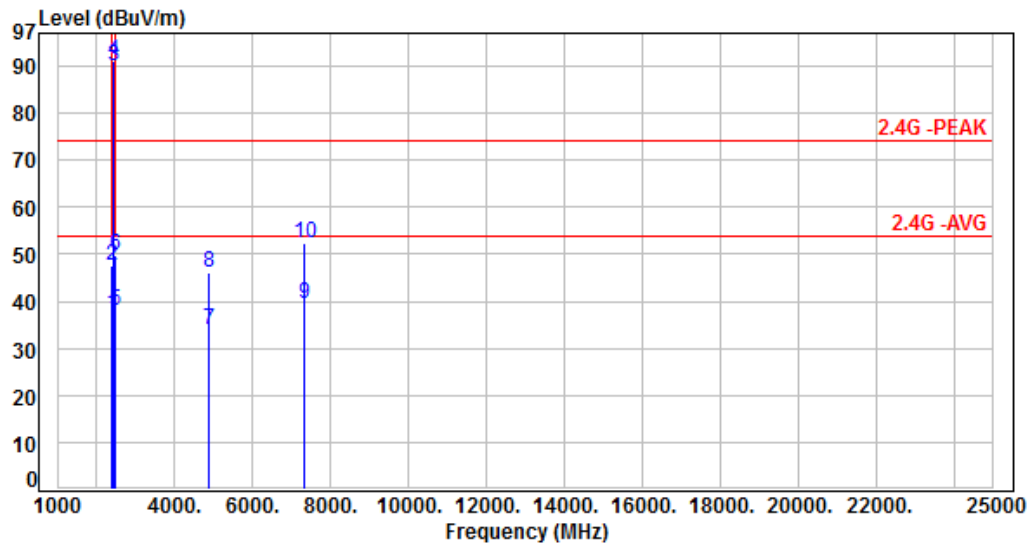

No.	Frequency (MHz)	Factor (dB)	Reading (dBuV)	Level (dBuV/m)	Limit (dBuV/m)	Margin (dB)	Detector	Height (cm)	Azimuth (deg)	P/F
1	2390.00	-2.92	40.17	37.25	54.00	-16.75	Average	386	286	P
2	2390.00	-2.92	50.38	47.46	74.00	-26.54	Peak	386	286	P
3	2440.00	-2.34	92.35	90.01	200.00	-109.99	Average	386	286	P
4	2440.00	-2.34	93.35	91.01	200.00	-108.99	Peak	386	286	P
5	2483.50	-2.04	40.02	37.98	54.00	-16.02	Average	386	286	P
6	2483.50	-2.04	51.67	49.63	74.00	-24.37	Peak	386	286	P
7	4880.00	5.94	28.02	33.96	54.00	-20.04	Average	100	330	P
8	4880.00	5.94	40.24	46.18	74.00	-27.82	Peak	100	330	P
9	7320.00	10.91	28.67	39.58	54.00	-14.42	Average	100	306	P
10	7320.00	10.91	41.41	52.32	74.00	-21.68	Peak	100	306	P

Note: Level=Reading+Factor
 Margin=Level-Limit
 Factor=Antenna Factor + cable loss - Amplifier Factor



Power	: AC 240V / 60Hz	Pol/Phase	: VERTICAL
Test Mode	: Mode 2, CH39		:

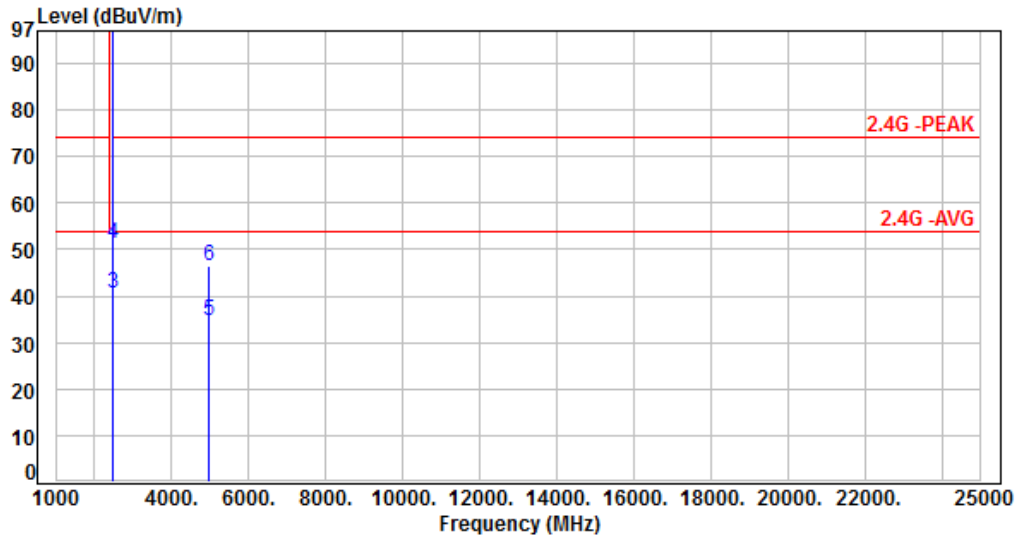

No.	Frequency (MHz)	Factor (dB)	Reading (dBuV)	Level (dBuV/m)	Limit (dBuV/m)	Margin (dB)	Detector	Height (cm)	Azimuth (deg)	P/F
1	2480.00	-2.05	100.42	98.37	200.00	-101.63	Average	102	319	P
2	2480.00	-2.05	101.43	99.38	200.00	-100.62	Peak	102	319	P
3	2483.50	-2.04	42.57	40.53	54.00	-13.47	Average	102	319	P
4	2483.50	-2.04	53.13	51.09	74.00	-22.91	Peak	102	319	P
5	4960.00	6.08	28.64	34.72	54.00	-19.28	Average	100	10	P
6	4960.00	6.08	40.51	46.59	74.00	-27.41	Peak	100	10	P

Note: Level=Reading+Factor
Margin=Level-Limit
Factor=Antenna Factor + cable loss - Amplifier Factor



Power	: AC 240V / 60Hz	Pol/Phase	: HORIZONTAL
Test Mode	: Mode 2, CH39		

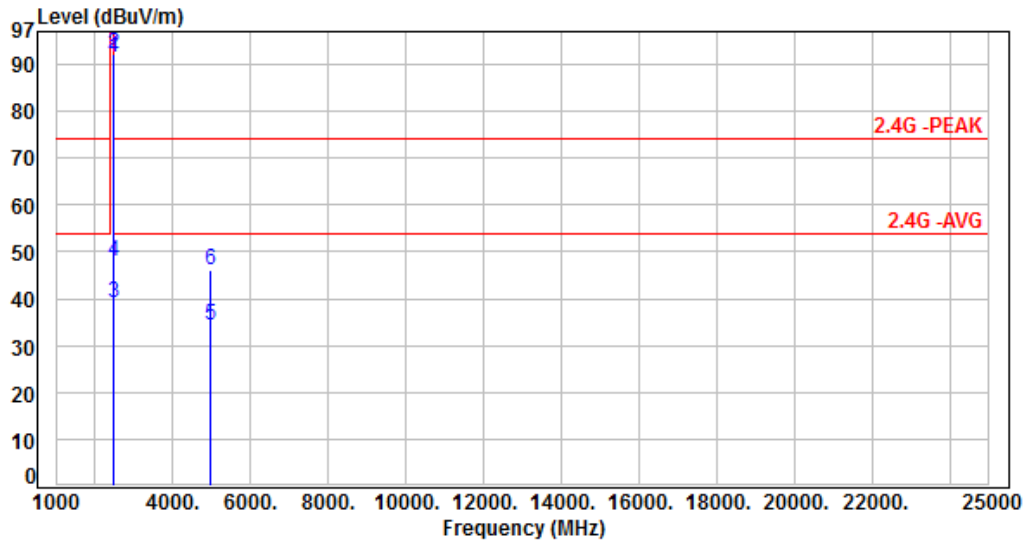

No.	Frequency (MHz)	Factor (dB)	Reading (dBuV)	Level (dBuV/m)	Limit (dBuV/m)	Margin (dB)	Detector	Height (cm)	Azimuth (deg)	P/F
1	2480.00	-2.05	93.44	91.39	200.00	-108.61	Average	375	287	P
2	2480.00	-2.05	94.41	92.36	200.00	-107.64	Peak	375	287	P
3	2483.50	-2.04	41.10	39.06	54.00	-14.94	Average	375	287	P
4	2483.50	-2.04	50.07	48.03	74.00	-25.97	Peak	375	287	P
5	4960.00	6.08	28.05	34.13	54.00	-19.87	Average	100	340	P
6	4960.00	6.08	40.04	46.12	74.00	-27.88	Peak	100	340	P

Note: Level=Reading+Factor
Margin=Level-Limit
Factor=Antenna Factor + cable loss - Amplifier Factor



6.7 Restricted Bands of Operation

Only spurious emissions are permitted in any of the frequency bands listed below:

MHz	MHz	MHz	GHz
0.09000 – 0.11000	16.42000 – 16.42300	399.9 – 410.0	4.500 – 5.250
0.49500 – 0.505**	16.69475 – 16.69525	608.0 – 614.0	5.350 – 5.460
2.17350 – 2.19050	16.80425 – 16.80475	960.0 – 1240.0	7.250 – 7.750
4.12500 – 4.12800	25.50000 – 25.67000	1300.0 – 1427.0	8.025 – 8.500
4.17725 – 4.17775	37.50000 – 38.25000	1435.0 – 1626.5	9.000 – 9.200
4.20725 – 4.20775	73.00000 – 74.60000	1645.5 – 1646.5	9.300 – 9.500
6.21500 – 6.21800	74.80000 – 75.20000	1660.0 – 1710.0	10.600 – 12.700
6.26775 – 6.26825	108.00000 – 121.94000	1718.8 – 1722.2	13.250 – 13.400
6.31175 – 6.31225	123.00000 – 138.00000	2200.0 – 2300.0	14.470 – 14.500
8.29100 – 8.29400	149.90000 – 150.05000	2310.0 – 2390.0	15.350 – 16.200
8.36200 – 8.36600	156.52475 – 156.52525	2483.5 – 2500.0	17.700 – 21.400
8.37625 – 8.38675	156.70000 – 156.90000	2655.0 – 2900.0	22.010 – 23.120
8.41425 – 8.41475	162.01250 – 167.17000	3260.0 – 3267.0	23.600 – 24.000
12.29000 – 12.29300	167.72000 – 173.20000	3332.0 – 3339.0	31.200 – 31.800
12.51975 – 12.52025	240.00000 – 285.00000	3345.8 – 3358.0	36.430 – 36.500
12.57675 – 12.57725	322.00000 – 335.40000	3600.0 – 4400.0	Above 38.6
13.36000 – 13.41000			

** : Until February 1, 1999, this restricted band shall be 0.490-0.510 MHz



7. Test of Spurious Emission (Conducted)

7.1 Test Limit

According to the methods defined in ANSI C63.10-2013 Section 11.11.1

Below -30dB of the highest emission level of operating band (In 100 kHz Resolution Bandwidth)

7.2 Test Procedure

According to the methods defined in ANSI C63.10-2013 Section 11.11.2 & 11.11.3

- a. The transmitter output was connected to the spectrum analyzer via a low loss cable.
- b. Set RBW of spectrum analyzer to 100 KHz and VBW of spectrum analyzer to 300 KHz with convenient frequency span including 100 KHz bandwidth from band edge.
- c. Peak conducted output power measured within any 100 kHz outside the authorized frequency band shall be attenuated by at least 30dB relative to the maximum measured in-band peak PSD level.
- d. The band edges was measured and recorded.

7.3 Test Setup Layout

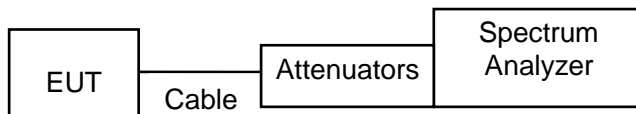

7.4 Test Result and Data

Note: Test plots refer to the following pages.



Modulation Type: GFSK(1Mbps)
CH00

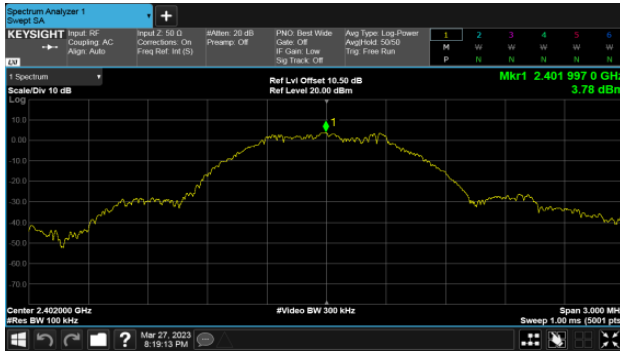

Modulation Type: GFSK(1Mbps)
CH19

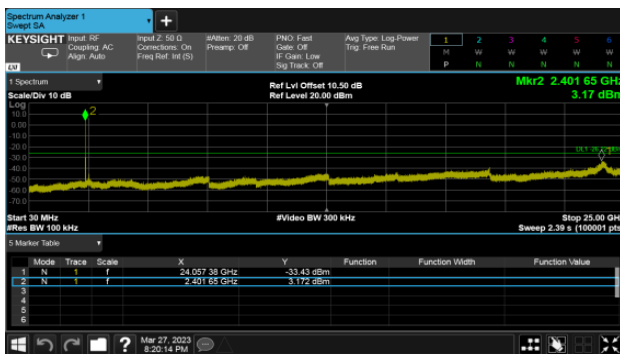
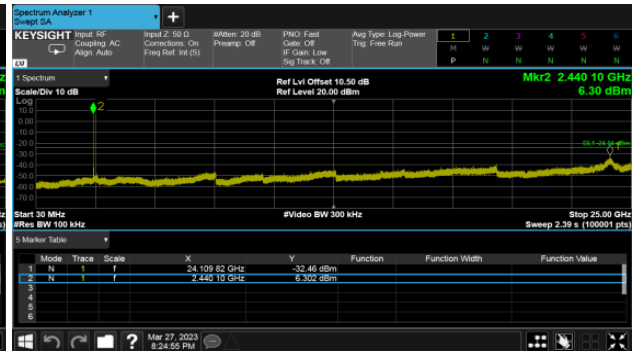
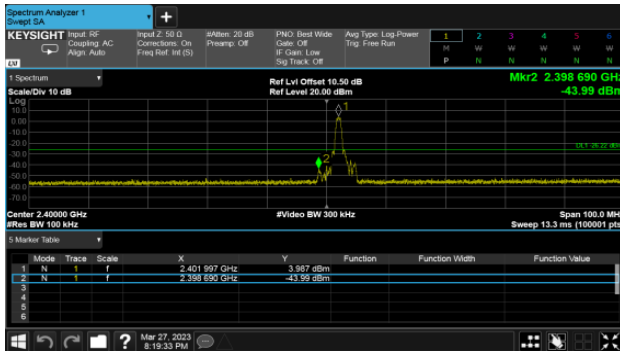
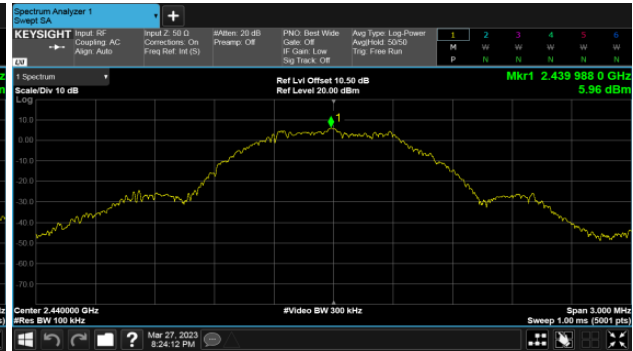



Modulation Type: GFSK(1Mbps)
CH39

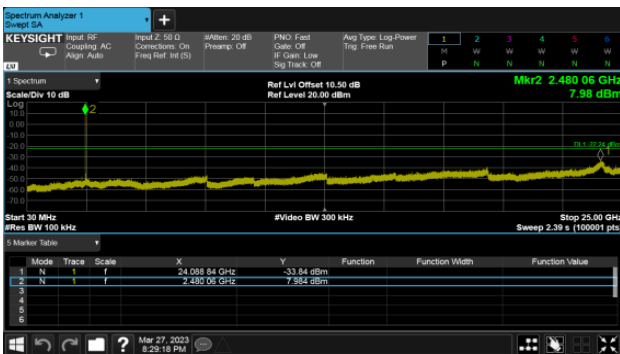
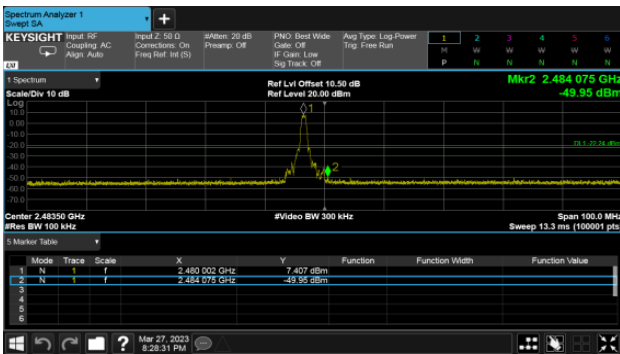
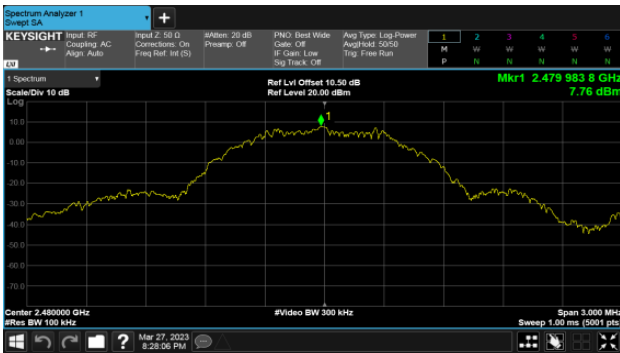



8. On Time, Duty Cycle and Measurement methods

8.1 Test Limit

None; for reporting purposes only.

8.2 Test Procedure

According to the methods defined in ANSI C63.10-2013 Section 11.6 Zero-Span Spectrum Analyzer Method.

8.3 Test Setup Layout

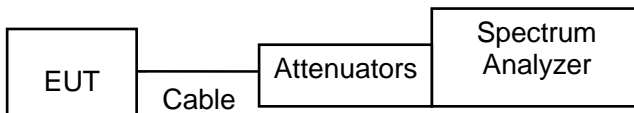

8.4 Test Result and Data

Modulation Type	On Time (ms)	Period Time (ms)	Duty Cycle (%)
GFSK(1Mbps)	0.41	0.65	63.15%

Modulation Type: GFSK(1Mbps)

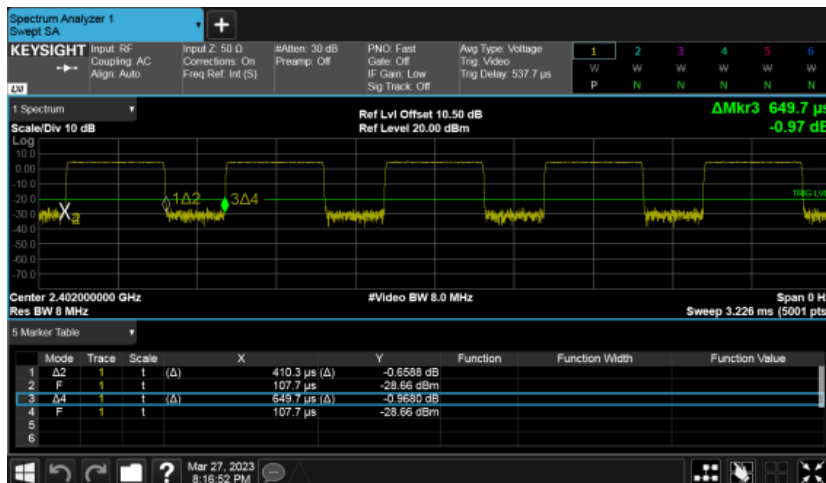



9. 6dB Bandwidth Measurement Data

9.1 Test Limit

The minimum of 6dB Bandwidth Measurement is 0.5 MHz.

9.2 Test Procedures

According to the methods defined in ANSI C63.10-2013 Section 11.8

- a. The transmitter output was connected to the spectrum analyzer.
- b. Set RBW of spectrum analyzer to 100 KHz and VBW to 300 KHz.
- c. The 6 dB bandwidth is defined as the total spectrum the power of which is higher than peak power minus 6 dB.
- d. The 6dB Bandwidth was measured and recorded.

9.3 Test Setup Layout

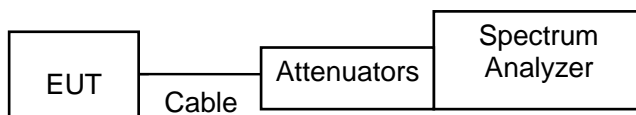

9.4 Test Result and Data

Modulation Type	Channel	Frequency (MHz)	6dB Bandwidth (KHz)	Limit (KHz)
GFSK(1Mbps)	0	2402	702.10	500
	19	2440	697.60	500
	39	2480	697.50	500



Modulation Type: GFSK(1Mbps) CH00



Modulation Type: GFSK(1Mbps) CH19

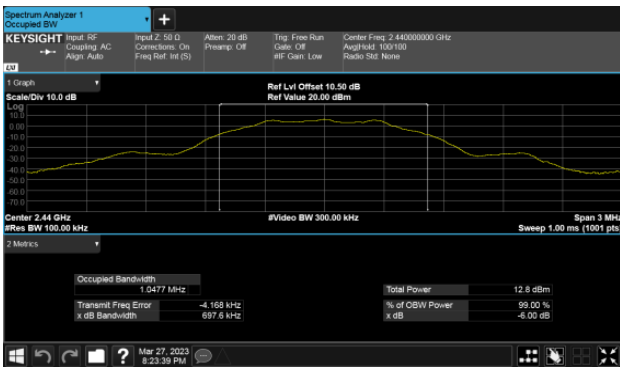

Modulation Type: GFSK(1Mbps) CH39

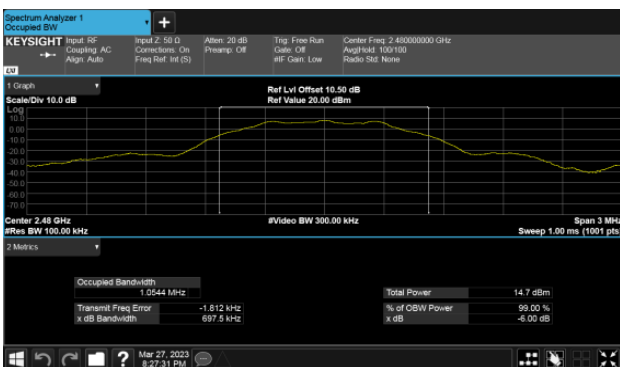



10. Maximum Average Output Power

10.1 Test Limit

The Maximum Output Power Measurement is 30dBm.

10.2 Test Procedures

According to the methods defined in ANSI C63.10-2013 Section 11.9.2.3.2

The antenna port (RF output) of the EUT was connected to the input (RF input) of a power meter. Power was read directly from the meter and cable loss connection was added to the reading to obtain power at the EUT antenna terminal. The EUT Output Power was set to maximum to produce the worse case test result.

10.3 Test Setup Layout

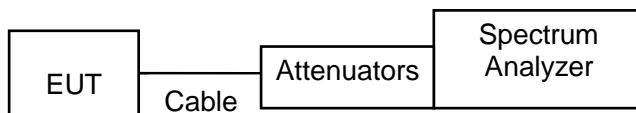

10.4 Test Result and Data

Power Set	Modulation Type	Channel	Frequency (MHz)	Power Output (dBm)	Power Output (mW)
				Average	Average
8	GFSK	0	2402	4.79	3.013
8		19	2440	6.41	4.375
8		39	2480	7.85	6.095



11. Power Spectral Density

11.1 Test Limit

The Maximum of Power Spectral Density Measurement is 8dBm.

11.2 Test Procedures

According to the methods defined in ANSI C63.10-2013 Section 11.10

- a. The transmitter output was connected to spectrum analyzer.
- b. The spectrum analyzer's resolution bandwidth were set at 10KHz RBW and 30KHz VBW as that of the fundamental frequency.
- c. The power spectral density was measured and recorded.

11.3 Test Setup Layout

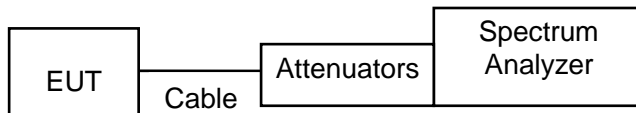

11.4 Test Result and Data

Modulation Type	Channel	Frequency (MHz)	Maximum Power Density of 10kHz Bandwidth (dBm)	Duty Cycle CF (dB)	Total PSD (dBm)	Limit
GFSK (1Mbps)	0	2402	-12.660	2.00	-10.66	8.00
	19	2440	-10.971	2.00	-8.97	8.00
	39	2480	-9.075	2.00	-7.08	8.00



Modulation Type: GFSK(1Mbps)
CH00

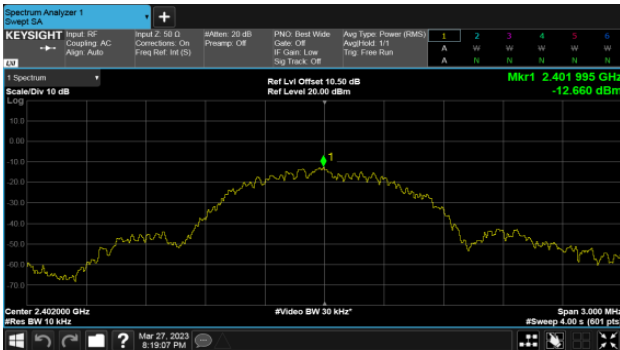

Modulation Type: GFSK(1Mbps)
CH19

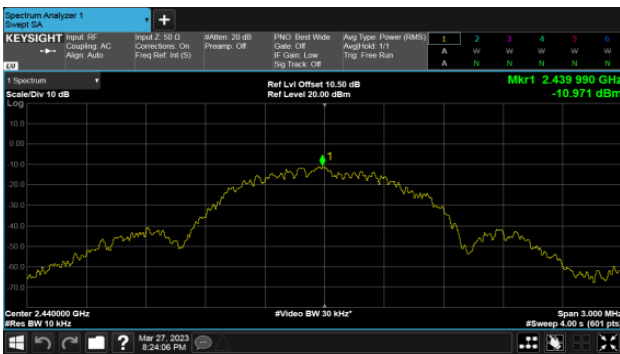

Modulation Type: GFSK(1Mbps)
CH39

