



FCC Test Report

Equipment : UniFi CLOUD KEY GEN2
Brand Name : UBIQUITI
Model No. : UCK-G2
FCC ID : SWX-UCKG2
Standard : 47 CFR FCC Part 15.247
Operating Band : 2400 MHz – 2483.5 MHz
Function : Point-to-multipoint; Point-to-point
Applicant/
Manufacturer : Ubiquiti Networks, Inc.
685 Third Avenue, 27th Floor New York, New York
10017 USA

The product sample received on Jan. 16, 2018 and completely tested on Feb. 14, 2018. We, SPORTON, would like to declare that the tested sample has been evaluated in accordance with the procedures given in ANSI C63.10-2013 and shown compliance with the applicable technical standards.

The test results in this report apply exclusively to the tested model / sample. Without written approval of SPORTON INTERNATIONALINC., the test report shall not be reproduced except in full.

Phoenix Chen / Assistant Manager





Table of Contents

1 GENERAL DESCRIPTION5

1.1 Information.....5

1.2 Testing Applied Standards6

1.3 Testing Location Information6

1.4 Measurement Uncertainty6

2 TEST CONFIGURATION OF EUT.....7

2.1 Test Condition7

2.2 Test Channel Mode7

2.3 The Worst Case Measurement Configuration.....8

2.4 Support Equipment.....9

2.5 Test Setup Diagram10

3 TRANSMITTER TEST RESULT12

3.1 AC Power-line Conducted Emissions12

3.2 DTS Bandwidth.....13

3.3 Maximum Conducted Output Power14

3.4 Power Spectral Density16

3.5 Emissions in Non-restricted Frequency Bands17

3.6 Emissions in Restricted Frequency Bands.....18

4 TEST EQUIPMENT AND CALIBRATION DATA22

APPENDIX A. TEST RESULTS OF DTS BANDWIDTH

APPENDIX B. TEST RESULTS OF MAXIMUM CONDUCTED OUTPUT POWER

APPENDIX C. TEST RESULTS OF POWER SPECTRAL DENSITY

APPENDIX D. TEST RESULTS OF EMISSIONS IN NON-RESTRICTED FREQUENCY BANDS

APPENDIX E. TEST RESULTS OF EMISSIONS IN RESTRICTED FREQUENCY BANDS

APPENDIX F. TEST RESULTS OF AC POWER-LINE CONDUCTED EMISSIONS

APPENDIX G. TEST PHOTOS

PHOTOGRAPHS OF EUT V01



Summary of Test Result

Conformance Test Specifications				
Report Clause	Ref. Std. Clause	Description	Limit	Result
1.1.2	15.203	Antenna Requirement	FCC 15.203	Complied
3.1	15.207	AC Power-line Conducted Emissions	FCC 15.207	Complied
3.2	15.247(a)	DTS Bandwidth	≥500kHz	Complied
3.3	15.247(b)	Maximum Conducted Output Power	Power [dBm]:30	Complied
3.4	15.247(e)	Power Spectral Density	PSD [dBm/3kHz]:8	Complied
3.5	15.247(d)	Emissions in Non-restricted Frequency Bands	Non-Restricted Bands: >30 dBc	Complied
3.6	15.247(d)	Emissions in Restricted Frequency Bands	Restricted Bands: FCC 15.209	Complied



1 General Description

1.1 Information

1.1.1 RF General Information

Frequency Range (MHz)	Bluetooth Mode	Ch. Frequency (MHz)	Channel Number
2400-2483.5	LE	2402-2480	0-39 [40]

Band	Mode	BWch (MHz)	Nant
2.4-2.4835GHz	BT-LE(1Mbps)	1.0	1TX

Note:

- ♦ Bluetooth LE uses a GFSK (1Mbps) modulation for DSSS.
- ♦ BWch is the nominal channel bandwidth.

1.1.2 Antenna Information

Ant.	Port	Brand	Model Name	Antenna Type	Connector	Gain (dBi)
1	1	-	-	internal Antenna	I-PEX	0

1.1.3 EUT Information

Operational Condition	
EUT Power Type	From Battery / From AC adapter / From PoE
Type of EUT	
<input checked="" type="checkbox"/>	Stand-alone
<input type="checkbox"/>	Combined (EUT where the radio part is fully integrated within another device)
	Combined Equipment - Brand Name / Model No.: ...
<input type="checkbox"/>	Plug-in radio (EUT intended for a variety of host systems)
	Host System - Brand Name / Model No.: ...
<input type="checkbox"/>	Other:

1.1.4 Mode Test Duty Cycle

Mode	DC	DCF(dB)	T(s)	VBW(Hz) $\geq 1/T$
BT-LE(1Mbps)	0.631	2	396.875u	3k



1.2 Testing Applied Standards

According to the specifications of the manufacturer, the EUT must comply with the requirements of the following standards:

- ◆ 47 CFR FCC Part 15
- ◆ ANSI C63.10-2013
- ◆ KDB 558074 D01 v04

1.3 Testing Location Information

Testing Location		
<input checked="" type="checkbox"/>	HWA YA	ADD : No. 52, Huaya 1st Rd., Guishan Dist., Taoyuan City, Taiwan (R.O.C.) TEL : 886-3-327-3456 FAX : 886-3-327-0973
Test site Designation No. TW1190 with FCC.		
<input type="checkbox"/>	JHUBEI	ADD : No.8, Ln. 724, Bo'ai St., Zhubei City, Hsinchu County, Taiwan (R.O.C.) TEL : 886-3-656-9065 FAX : 886-3-656-9085
Test site Designation No. TW0006 with FCC.		

Test Condition	Test Site No.	Test Engineer	Test Environment	Test Date
RF Conducted	TH07-HY	Ryan	23.3°C / 65%	17/Jan/2018
Radiated	03CH03-HY	Jeff	21°C / 51%	16/Jan/2018
AC Conduction	CO04-HY	Andy	21°C / 51%	14/Feb/2018

1.4 Measurement Uncertainty

ISO/IEC 17025 requires that an estimate of the measurement uncertainties associated with the emissions test results be included in the report. The measurement uncertainties given below are based on a 95% confidence level (based on a coverage factor (k=2))

Test Items	Uncertainty	Remark
Conducted Emission (150kHz ~ 30MHz)	3.6 dB	Confidence levels of 95%
Radiated Emission (9kHz ~ 30MHz)	3.0 dB	Confidence levels of 95%
Radiated Emission (30MHz ~ 1,000MHz)	4.3 dB	Confidence levels of 95%
Radiated Emission (1GHz ~ 18GHz)	3.9 dB	Confidence levels of 95%
Radiated Emission (18GHz ~ 40GHz)	3.5 dB	Confidence levels of 95%
Conducted Emission	1.3 dB	Confidence levels of 95%



2 Test Configuration of EUT

2.1 Test Condition

RF Conducted	Abbreviation	Remark
TnomVnom	Tnom	20°C
-	Vnom	3.8V

2.2 Test Channel Mode



Test Software Version	QRCT v3.0.265.0
-----------------------	-----------------

Mode	Power Setting
BT-LE(1Mbps)	-
2402MHz	default
2440MHz	default
2480MHz	default

2.3 The Worst Case Measurement Configuration

The Worst Case Mode for Following Conformance Tests	
Tests Item	AC power-line conducted emissions
Condition	AC power-line conducted measurement for line and neutral
Operating Mode	CTX
1	Adapter mode
2	PoE mode

The Worst Case Mode for Following Conformance Tests	
Tests Item	DTS Bandwidth Maximum Conducted Output Power Power Spectral Density Emissions in Non-restricted Frequency Bands
Test Condition	Conducted measurement at transmit chains

The Worst Case Mode for Following Conformance Tests			
Tests Item	Emissions in Restricted Frequency Bands		
Test Condition	Radiated measurement If EUT consist of multiple antenna assembly (multiple antenna are used in EUT regardless of spatial multiplexing MIMO configuration), the radiated test should be performed with highest antenna gain of each antenna type.		
Operating Mode < 1GHz	CTX		
1	Battery		
Operating Mode > 1GHz	CTX		
Orthogonal Planes of EUT	X Plane	Y Plane	Z Plane
			
Worst Planes of EUT			V



2.4 Support Equipment

Support Equipment – RF Conducted				
No.	Equipment	Brand Name	Model Name	FCC ID
1	Notebook	DELL	E4300	DoC
2	Adapter for NB	DELL	HA65NM130	DoC

Support Equipment – Radiated Emission				
No.	Equipment	Brand Name	Model Name	FCC ID
1	Battery	-	-	-

Note: Support equipment No.1 was provided by customer.

Support Equipment – AC Conduction				
No.	Equipment	Brand Name	Model Name	FCC ID
1	PoE	Powerdsine ltd	PD-3501G	-
2	AC adaptor	Ubiquiti	GP-Q027-QC	-

2.5 Test Setup Diagram

Test Setup Diagram – AC Line Conducted Emission Test – Mode 1

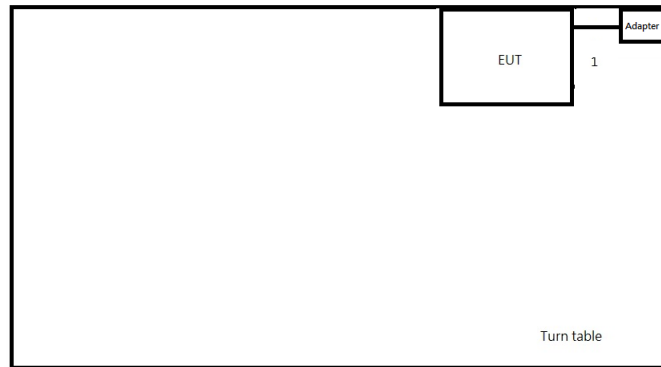

Item	Connection	Shielded	Length(m)	Remark
1	DC Cable	No	1m	-

Test Setup Diagram – AC Line Conducted Emission Test – Mode 2

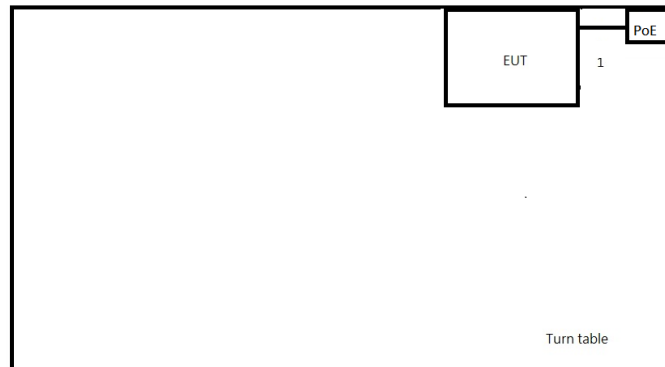

Item	Connection	Shielded	Length(m)	Remark
1	LAN Cable	No	0.07m	-

Test Setup Diagram - Radiated Test

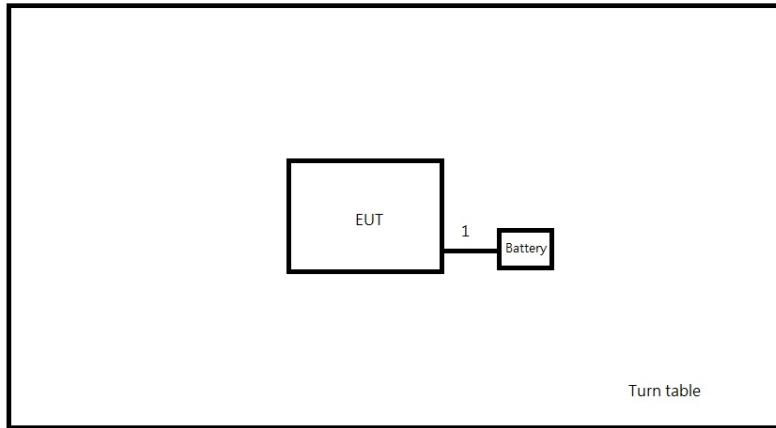

Item	Connection	Shielded	Length(m)	Remark
1	cable	No	0.07m	-

3 Transmitter Test Result

3.1 AC Power-line Conducted Emissions

3.1.1 AC Power-line Conducted Emissions Limit

AC Power-line Conducted Emissions Limit		
Frequency Emission (MHz)	Quasi-Peak	Average
0.15-0.5	66 - 56 *	56 - 46 *
0.5-5	56	46
5-30	60	50

Note 1: * Decreases with the logarithm of the frequency.

3.1.2 Measuring Instruments

Refer a test equipment and calibration data table in this test report.

3.1.3 Test Procedures

Test Method
<ul style="list-style-type: none"> Refer as ANSI C63.10-2013, clause 6.2 foray power-line conducted emissions.

3.1.4 Test Setup

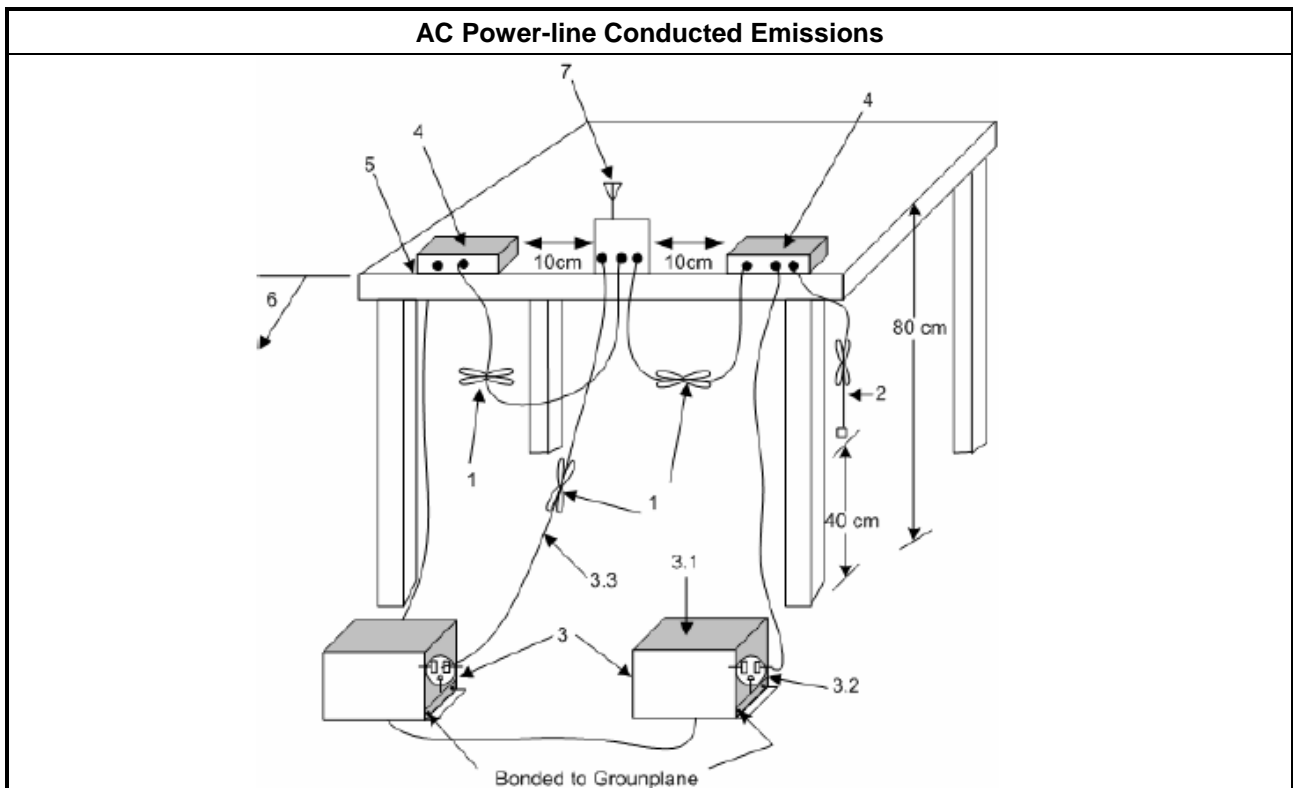

3.1.5 Test Result of AC Power-line Conducted Emissions

Refer as Appendix F

3.2 DTS Bandwidth

3.2.1 6dB Bandwidth Limit

6dB Bandwidth Limit
Systems using digital modulation techniques:
<ul style="list-style-type: none"> ▪ 6 dB bandwidth \geq 500 kHz.

3.2.2 Measuring Instruments

Refer a test equipment and calibration data table in this test report.

3.2.3 Test Procedures

Test Method	
<ul style="list-style-type: none"> ▪ For the emission bandwidth shall be measured using one of the options below: 	
<input checked="" type="checkbox"/>	Refer as KDB 558074, clause 8.1 Option 1 for 6 dB bandwidth measurement.
<input type="checkbox"/>	Refer as KDB 558074, clause 8.2 Option 2 for 6 dB bandwidth measurement.
<input type="checkbox"/>	Refer as ANSI C63.10, clause 6.9.3 for occupied bandwidth testing.
<input type="checkbox"/>	Refer as RSS-Gen, clause 6.6 for occupied bandwidth testing.

3.2.4 Test Setup

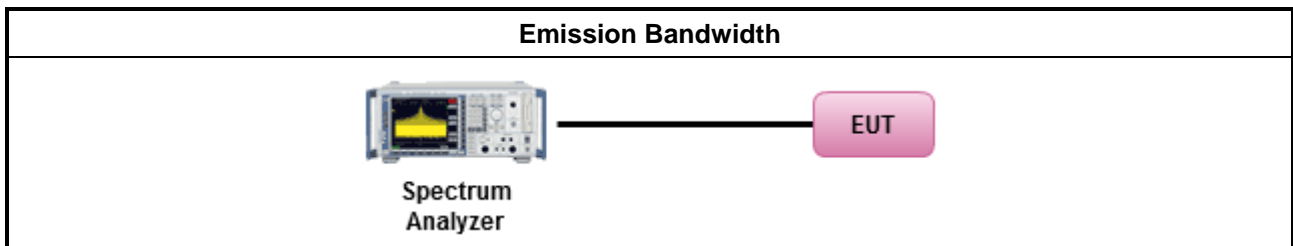

3.2.5 Test Result of Emission Bandwidth

Refer as Appendix A

3.3 Maximum Conducted Output Power

3.3.1 Maximum Conducted Output Power Limit

Maximum Conducted Output Power Limit	
	<ul style="list-style-type: none"> ▪ If $G_{TX} \leq 6$ dBi, then $P_{Out} \leq 30$ dBm (1 W)
	<ul style="list-style-type: none"> ▪ Point-to-multipoint systems (P2M): If $G_{TX} > 6$ dBi, then $P_{Out} = 30 - (G_{TX} - 6)$ dBm
	<ul style="list-style-type: none"> ▪ Point-to-point systems (P2P): If $G_{TX} > 6$ dBi, then $P_{Out} = 30 - (G_{TX} - 6)/3$ dBm
	<ul style="list-style-type: none"> ▪ Smart antenna system (SAS):
	<ul style="list-style-type: none"> - Single beam: If $G_{TX} > 6$ dBi, then $P_{Out} = 30 - (G_{TX} - 6)/3$ dBm
	<ul style="list-style-type: none"> - Overlap beam: If $G_{TX} > 6$ dBi, then $P_{Out} = 30 - (G_{TX} - 6)/3$ dBm
	<ul style="list-style-type: none"> - Aggregate power on all beams: If $G_{TX} > 6$ dBi, then $P_{Out} = 30 - (G_{TX} - 6)/3 + 8$ dBm
e.i.r.p. Power Limit:	
	<ul style="list-style-type: none"> ▪ 2400-2483.5 MHz Band
	<ul style="list-style-type: none"> ▪ Point-to-multipoint systems (P2M): $P_{eirp} \leq 36$ dBm (4 W)
	<ul style="list-style-type: none"> ▪ Point-to-point systems (P2P): $P_{eirp} \leq \text{MAX}(36, [P_{Out} + G_{TX}])$ dBm
	<ul style="list-style-type: none"> ▪ Smart antenna system (SAS)
	<ul style="list-style-type: none"> - Single beam: $P_{eirp} \leq \text{MAX}(36, P_{Out} + G_{TX})$ dBm
	<ul style="list-style-type: none"> - Overlap beam: $P_{eirp} \leq \text{MAX}(36, P_{Out} + G_{TX})$ dBm
	<ul style="list-style-type: none"> - Aggregate power on all beams: $P_{eirp} \leq \text{MAX}(36, [P_{Out} + G_{TX} + 8])$ dBm
<p>P_{Out} = maximum peak conducted output power or maximum conducted output power in dBm, G_{TX} = the maximum transmitting antenna directional gain in dBi.</p>	

3.3.2 Measuring Instruments

Refer a test equipment and calibration data table in this test report.

3.3.3 Test Procedures

Test Method	
<ul style="list-style-type: none"> ▪ Maximum Peak Conducted Output Power 	
	<input type="checkbox"/> Refer as KDB 558074, clause 9.1.1 Option 1 (RBW ≥ EBW method).
	<input type="checkbox"/> Refer as KDB 558074, clause 9.1.2 Option 2 (integrated band power method)
	<input type="checkbox"/> Refer as KDB 558074, clause 9.1.3 Option 3 (peak power meter for VBW ≥ DTS BW)
<ul style="list-style-type: none"> ▪ Maximum Average Conducted Output Power 	
	Duty cycle ≥ 98%
	<input type="checkbox"/> Refer as KDB 558074, clause 9.2.2.4 Method AVGSA-2 (spectral trace averaging).
	Duty cycle < 98%
	<input type="checkbox"/> Refer as KDB 558074, clause 9.2.2.5 Method AVGSA-2 Alt. (slow sweep speed)
	RF power meter and average over on/off periods with duty factor or gated trigger
	<input checked="" type="checkbox"/> Refer as KDB 558074, clause 9.2.3.1 Method AVGPM (using an RF average power meter).
<ul style="list-style-type: none"> ▪ For conducted measurement. 	
	<ul style="list-style-type: none"> ▪ If the EUT supports multiple transmit chains using options given below: Refer as KDB 662911, In-band power measurements. Using the measure-and-sum approach, measured all transmit ports individually. Sum the power (in linear power units e.g., mW) of all ports for each individual sample and save them.
	<ul style="list-style-type: none"> ▪ If multiple transmit chains, EIRP calculation could be following as methods: $P_{total} = P_1 + P_2 + \dots + P_n$ (calculated in linear unit [mW] and transfer to log unit [dBm]) $EIRP_{total} = P_{total} + DG$

3.3.4 Test Setup

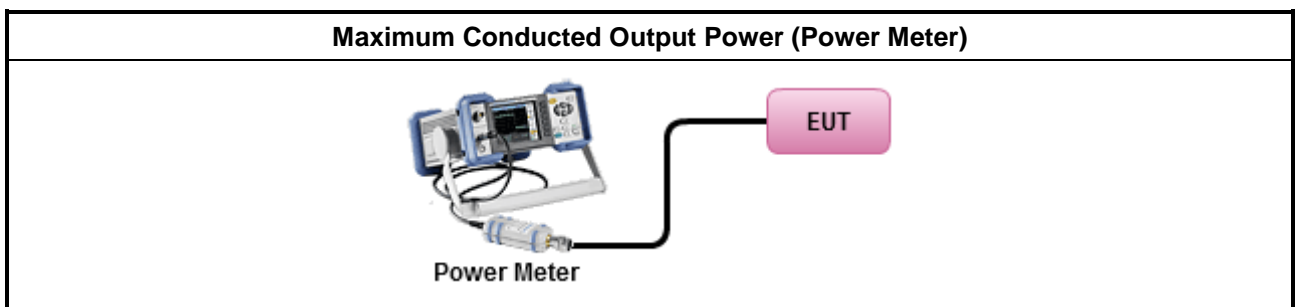

3.3.5 Test Result of Maximum Conducted Output Power

Refer as Appendix B

3.4 Power Spectral Density

3.4.1 Power Spectral Density Limit

Power Spectral Density Limit
<ul style="list-style-type: none"> Power Spectral Density (PSD) ≤ 8 dBm/3kHz

3.4.2 Measuring Instruments

Refer a test equipment and calibration data table in this test report.

3.4.3 Test Procedures

Test Method	
	<ul style="list-style-type: none"> Peak power spectral density procedures that the same method as used to determine the conducted output power. If maximum peak conducted output power was measured to demonstrate compliance to the output power limit, then the peak PSD procedure below (Method PKPSD) shall be used. If maximum conducted output power was measured to demonstrate compliance to the output power limit, then one of the average PSD procedures shall be used, as applicable based on the following criteria (the peak PSD procedure is also an acceptable option).
<input checked="" type="checkbox"/>	Refer as KDB 558074, clause 10.2 Method PKPSD (RBW=3-100kHz; Detector=peak).
	<ul style="list-style-type: none"> For conducted measurement.
	<ul style="list-style-type: none"> If The EUT supports multiple transmit chains using options given below:
	<ul style="list-style-type: none"> Measure and sum the spectra across the outputs. Refer as KDB 662911, In-band power spectral density (PSD). Sample all transmit ports simultaneously using a spectrum analyzer for each transmit port. Where the trace bin-by-bin of each transmit port summing can be performed. (i.e., in the first spectral bin of output 1 is summed with that in the first spectral bin of output 2 and that from the first spectral bin of output 3, and so on up to the NTX output to obtain the value for the first frequency bin of the summed spectrum.). Add up the amplitude (power) values for the different transmit chains and use this as the new data trace.

3.4.4 Test Setup

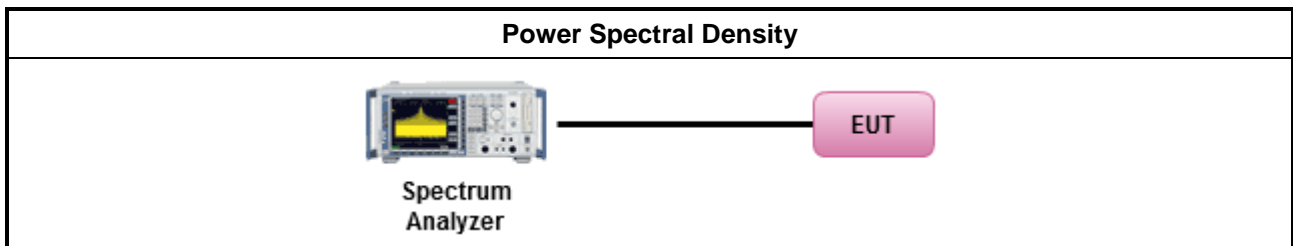

3.4.5 Test Result of Power Spectral Density

Refer as Appendix C

3.5 Emissions in Non-restricted Frequency Bands

3.5.1 Emissions in Non-restricted Frequency Bands Limit

Un-restricted Band Emissions Limit	
RF output power procedure	Limit (dB)
Peak output power procedure	20
Average output power procedure	30

Note 1: If the peak output power procedure is used to measure the fundamental emission power to demonstrate compliance to requirements, then the peak conducted output power measured within any 100 kHz outside the authorized frequency band shall be attenuated by at least 20 dB relative to the maximum measured in-band peak PSD level.

Note 2: If the average output power procedure is used to measure the fundamental emission power to demonstrate compliance to requirements, then the power in any 100 kHz outside of the authorized frequency band shall be attenuated by at least 30 dB relative to the maximum measured in-band average PSD level.

3.5.2 Measuring Instruments

Refer a test equipment and calibration data table in this test report.

3.5.3 Test Procedures

Test Method
<ul style="list-style-type: none"> Refer as KDB 558074, clause 11 for unwanted emissions into non-restricted bands.

3.5.4 Test Setup

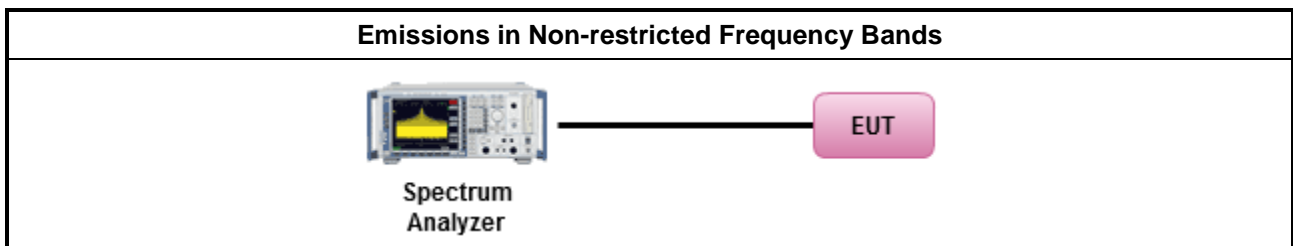

3.5.5 Test Result of Emissions in Non-restricted Frequency Bands

Refer as Appendix D

3.6 Emissions in Restricted Frequency Bands

3.6.1 Emissions in Restricted Frequency Bands Limit

Restricted Band Emissions Limit			
Frequency Range (MHz)	Field Strength (uV/m)	Field Strength (dBuV/m)	Measure Distance (m)
0.009~0.490	2400/F(kHz)	48.5 - 13.8	300
0.490~1.705	24000/F(kHz)	33.8 - 23	30
1.705~30.0	30	29	30
30~88	100	40	3
88~216	150	43.5	3
216~960	200	46	3
Above 960	500	54	3

Note 1: Test distance for frequencies at or above 30 MHz, measurements may be performed at a distance other than the limit distance provided they are not performed in the near field and the emissions to be measured can be detected by the measurement equipment. When performing measurements at a distance other than that specified, the results shall be extrapolated to the specified distance using an extrapolation factor of 20 dB/decade (inverse of linear distance for field-strength measurements, inverse of linear distance-squared for power-density measurements).

Note 2: Test distance for frequencies at below 30 MHz, measurements may be performed at a distance closer than the EUT limit distance; however, an attempt should be made to avoid making measurements in the near field. When performing measurements below 30 MHz at a closer distance than the limit distance, the results shall be extrapolated to the specified distance by either making measurements at a minimum of two or more distances on at least one radial to determine the proper extrapolation factor or by using the square of an inverse linear distance extrapolation factor (40 dB / decade). The test report shall specify the extrapolation method used to determine compliance of the EUT.

Note 3: Using the distance of 1m during the test for above 18 GHz, and the test value to correct for the distance factor at 3m.

3.6.2 Measuring Instruments

Refer a test equipment and calibration data table in this test report.



3.6.3 Test Procedures

Test Method	
<ul style="list-style-type: none"> ▪ The average emission levels shall be measured in [duty cycle \geq 98 or duty factor]. 	
<ul style="list-style-type: none"> ▪ Refer as ANSI C63.10, clause 6.10.3 band-edge testing shall be performed at the lowest frequency channel and highest frequency channel within the allowed operating band. 	
<ul style="list-style-type: none"> ▪ For the transmitter unwanted emissions shall be measured using following options below: 	
	<ul style="list-style-type: none"> ▪ Refer as KDB 558074, clause 12 for unwanted emissions into restricted bands.
<input checked="" type="checkbox"/>	Refer as KDB 558074, clause 12.2.5.3 (ANSI C63.10, clause 4.1.4.2.3), Reduced VBW \geq 1/T.
<input checked="" type="checkbox"/>	Refer as KDB 558074, clause 12.2.4 measurement procedure peak limit.
<ul style="list-style-type: none"> ▪ For the transmitter band-edge emissions shall be measured using following options below: 	
	<ul style="list-style-type: none"> ▪ Refer as KDB 558074 clause 13.1, When the performing peak or average radiated measurements, emissions within 2 MHz of the authorized band edge may be measured using the marker-delta method described below.
	<ul style="list-style-type: none"> ▪ Refer as KDB 558074, clause 13.2 (ANSI C63.10, clause 6.10.6) for marker-delta method for band-edge measurements.
	<ul style="list-style-type: none"> ▪ Refer as KDB 558074, clause 13.3 for narrower resolution bandwidth (100kHz) using the band power and summing the spectral levels (i.e., 1 MHz).
<ul style="list-style-type: none"> ▪ For conducted and cabinet radiation measurement, refer as KDB 558074, clause 12.2.2. 	
	<ul style="list-style-type: none"> ▪ For conducted unwanted emissions into restricted bands (absolute emission limits). Devices with multiple transmit chains using options given below: (1) Measure and sum the spectra across the outputs or (2) Measure and add 10 log(N) dB
	<ul style="list-style-type: none"> ▪ For KDB 662911 The methodology described here may overestimate array gain, thereby resulting in apparent failures to satisfy the out-of-band limits even if the device is actually compliant. In such cases, compliance may be demonstrated by performing radiated tests around the frequencies at which the apparent failures occurred.

3.6.4 Test Setup

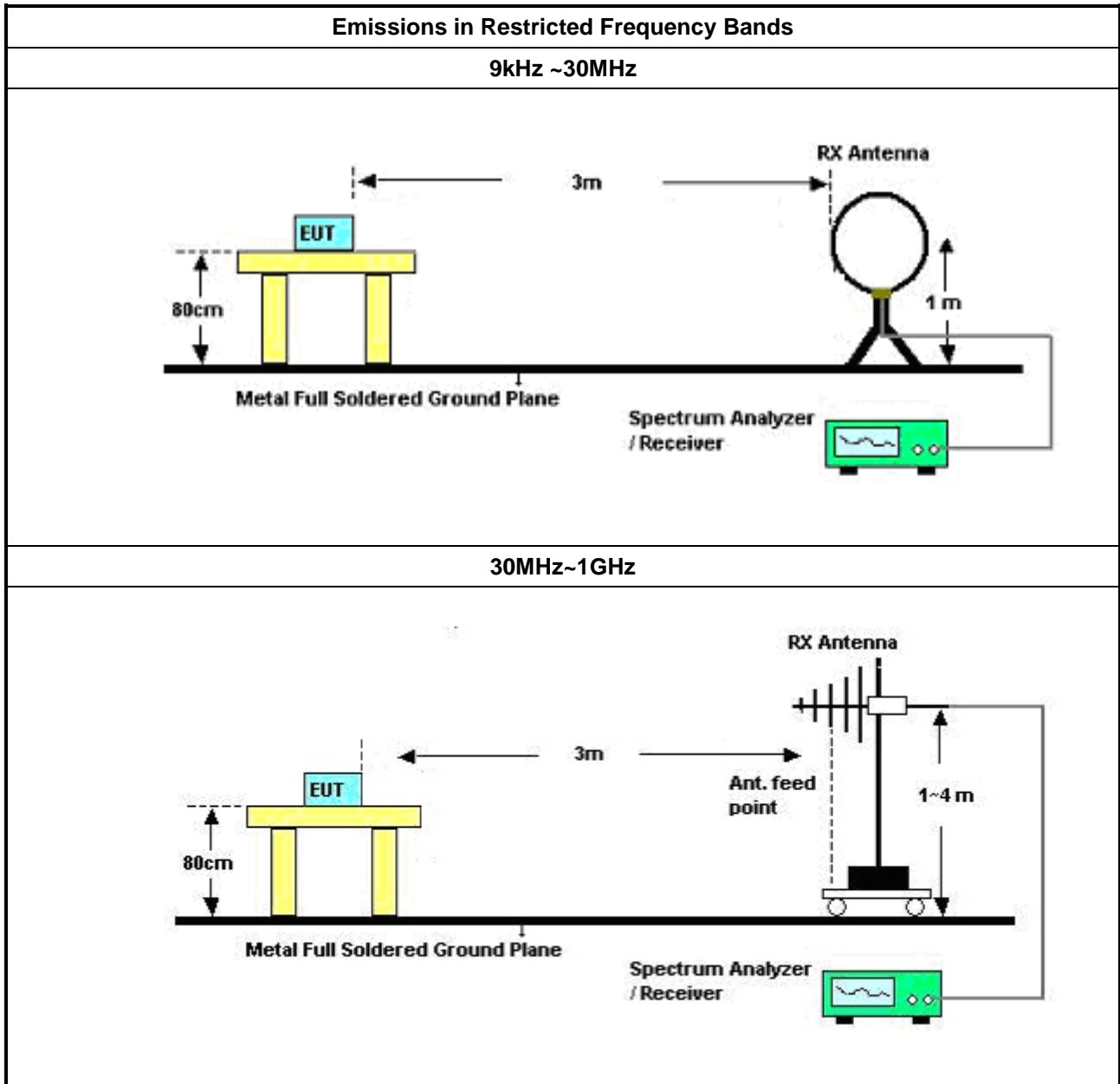

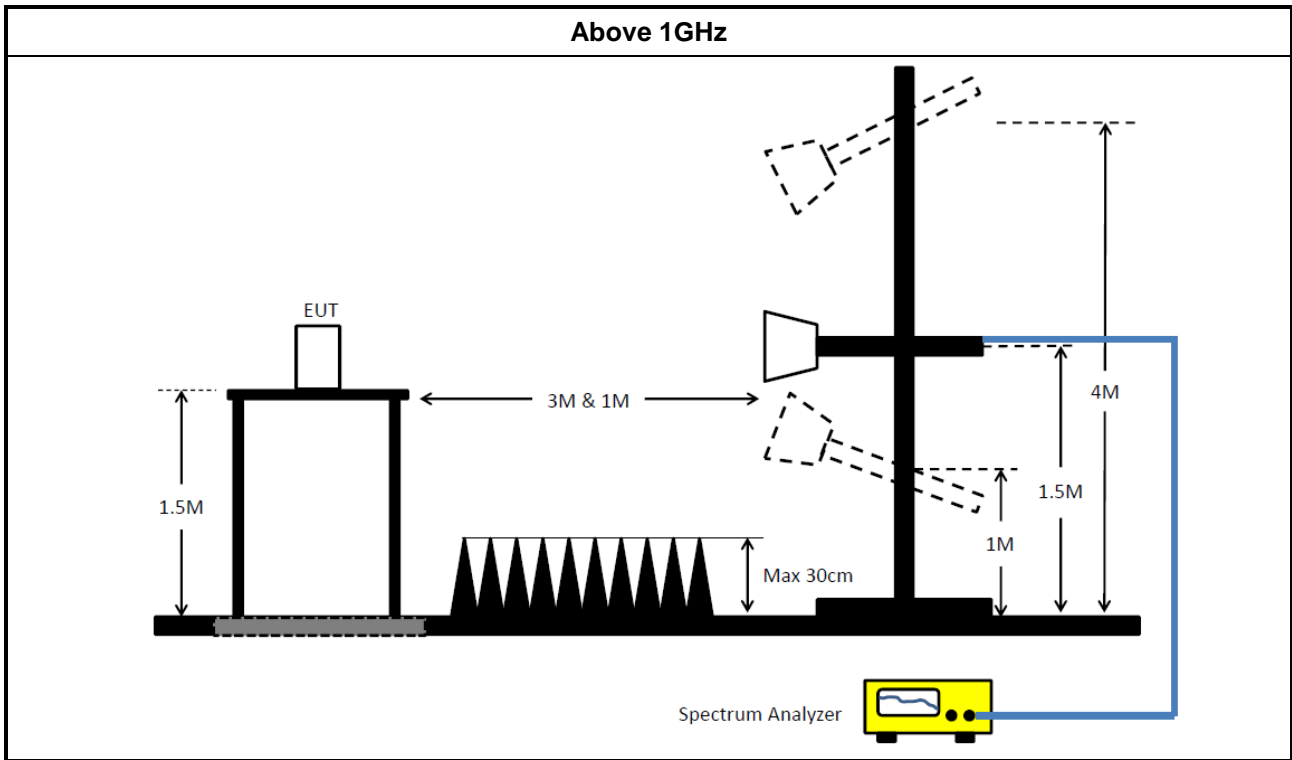

3.6.5 Test Result of Emissions in Restricted Frequency Bands (Below 30MHz)

The amplitude of spurious emissions which are attenuated by more than 20dB below the permissible value has no need to be reported.

3.6.6 Test Result of Emissions in Restricted Frequency Bands

Refer as Appendix E



4 Test Equipment and Calibration Data

Instrument for Radiated Test

Instrument	Manufacturer	Model No.	Serial No.	Spec.	Calibration Date	Calibration Due Date
3m Semi Anechoic Chamber	SIDT FRANKONIA	SAC-3M	03CH03-HY	30MHz ~ 1GHz 3m	31/Oct/2017	30/Oct/2018
3m Semi Anechoic Chamber	SIDT FRANKONIA	SAC-3M	03CH03-HY	1GHz ~ 18GHz 3m	01/Nov/2017	31/Oct/2018
Amplifier	HP	8447D	2944A08033	10kHz ~ 1.3GHz	19/Apr/2017	18/Apr/2018
Amplifier	Keysight	83017A	MY53270196	1GHz ~ 26.5GHz	31/Aug/2017	30/Aug/2018
Spectrum	R&S	FSV40	101500	9kHz ~ 40GHz	28/Jun/2017	27/Jun/2018
Receiver	R&S	ESR3	102052	9kHz ~ 3.6GHz	29/Apr/2017	28/Apr/2018
RF Cable-R03m	Jye Bao	RG142	CB021	9kHz ~ 1GHz	26/Jan/2017	25/Jan/2018
RF Cable-high	SUHNER	SUCOFLEX106	CB222	1GHz ~ 40GHz	26/Jan/2017	25/Jan/2018
Bilog Antenna	SCHAFFNER	CBL 6112B	22237	30MHz ~ 1GHz	08/Jul/2017	07/Jul/2018
Horn Antenna	SCHWARZBECK	BBHA9170	BBHA9170154	18GHz ~ 40GHz	06/Feb/ 2017	05/Feb/2018
Horn Antenna	SCHWARZBECK	BBHA9120D	1531	1GHz ~ 18GHz	25/Apr/ 2017	24/Apr/2018
Loop Antenna	TESEQ	HLA 6120	31244	9 kHz~30 MHz	02/Mar/2017	01/Mar/2018

Instrument for Conducted Test

Instrument	Manufacturer	Model No.	Serial No.	Spec.	Calibration Date	Calibration Due Date
Spectrum Analyzer	R&S	FSV 40	101515	9kHz~40GHz	08/Dec/2017	07/Dec/2018
Power Sensor	Anritsu	MA2411B	1339407	300MHz ~ 40GHz	10/May/2017	09/May/2018
Power Meter	Anritsu	ML2495A	1517010	300MHz ~ 40GHz	06/Nov/2017	05/Nov/2018
RF Cable-0.2m	HUBER+SUHNER	SUCOFLEX_104	MY10709/4	30MHz ~ 26.5GHz	25/Aug/2017	24/Aug/2018
RF Cable-0.2m	HUBER+SUHNER	SUCOFLEX_104	MY10712/4	30MHz ~ 26.5GHz	25/Aug/2017	24/Aug/2018
RF Cable-0.5m	HUBER+SUHNER	SUCOFLEX_104	MY10713/4	30MHz ~ 26.5GHz	25/Aug/2017	24/Aug/2018
Signal Generator	R&S	SMR40	100116	10MHz ~ 40GHz	27/Jul/2017	26/Jul/2018



Instrument for AC Conduction

Instrument	Manufacturer	Model No.	Serial No.	Spec.	Calibration Date	Calibration Due Date
EMC Receiver	R&S	ESR3	102052	9KHz ~ 3.6GHz	29/Apr/2017	28/Apr/2018
RF Cable-CON	HUBER+SUHNER	RG213/U	07611832020001	9kHz ~ 30MHz	06/Oct/2017	05/Oct/2018
AC POWER	APC	AFC-11005G	F310050055	47Hz~63Hz 5~300V	NCR	NCR
Impuls Begrenzer Pulse Limiter	SCHWARZBECK	VTSD 9561-F	9561-F041	9 kHz ~ 30 MHz	12/Oct/2017	11/Oct/2018
LISN	R&S	ENV216	101295	9kHz ~ 30MHz	17/Nov/2017	16/Nov/2018

NCR : Non-Calibration Require



Summary

Mode	Max-N dB (Hz)	Max-OBW (Hz)	ITU-Code	Min-N dB (Hz)	Min-OBW (Hz)
2.4-2.4835GHz	-	-	-	-	-
BT-LE(1Mbps)	680k	1.061M	1M06F1D	676.25k	1.056M

Max-N dB = Maximum 6dB down bandwidth; Max-OBW = Maximum 99% occupied bandwidth;
Min-N dB = Minimum 6dB down bandwidth; Min-OBW = Minimum 99% occupied bandwidth;

Result

Mode	Result	Limit (Hz)	Port 1-N dB (Hz)	Port 1-OBW (Hz)
BT-LE(1Mbps)	-	-	-	-
2402MHz	Pass	500k	678.75k	1.058M
2440MHz	Pass	500k	676.25k	1.061M
2480MHz	Pass	500k	680k	1.056M

Port X-N dB = Port X 6dB down bandwidth; Port X-OBW = Port X 99% occupied bandwidth;

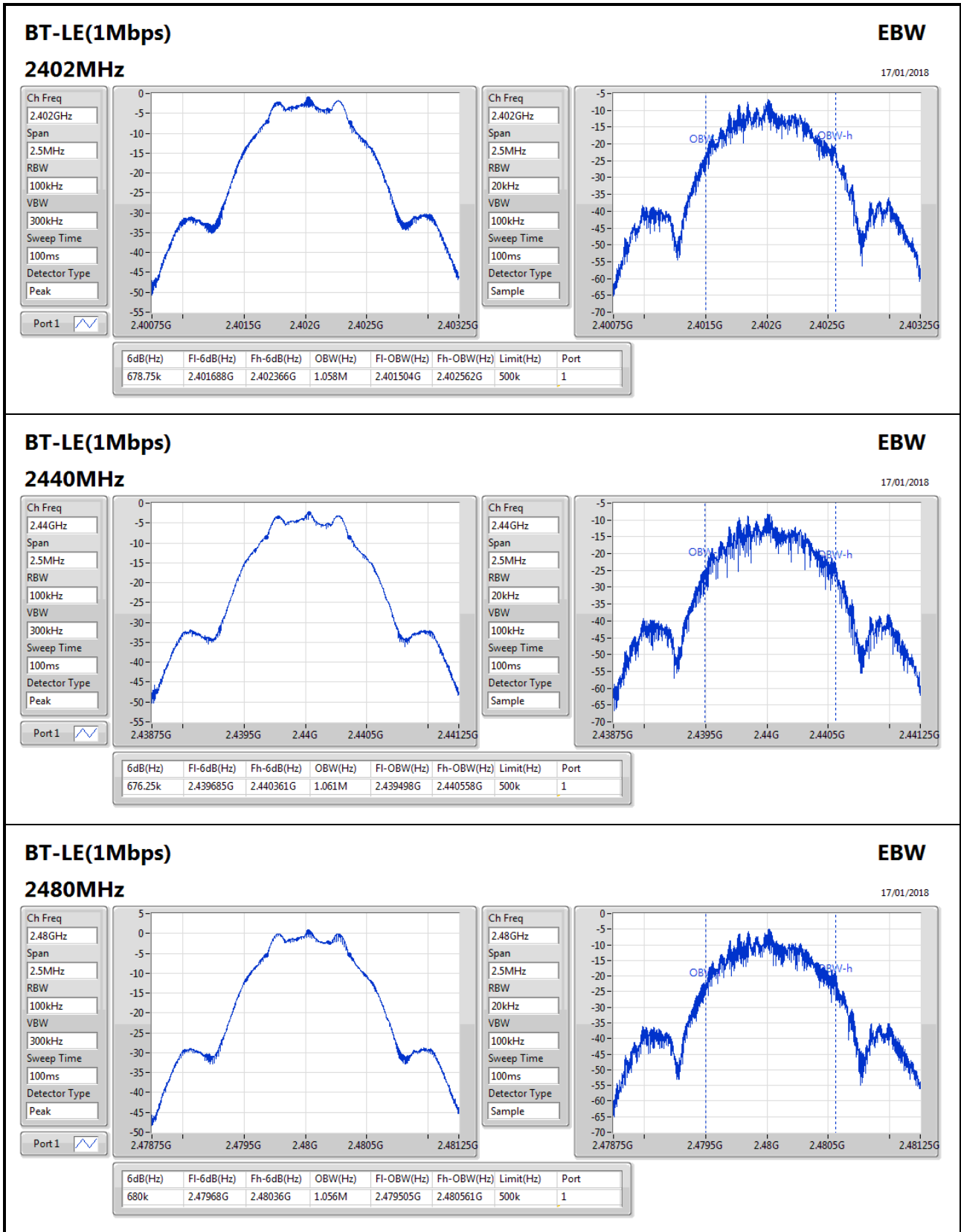



Summary

Mode	Power (dBm)	Power (W)
2.4-2.4835GHz	-	-
BT-LE(1Mbps)	1.04	0.00127

Result

Mode	Result	Gain (dBi)	Power (dBm)	Power Limit (dBm)
BT-LE(1Mbps)	-	-	-	-
2402MHz	Pass	0.00	-0.97	30.00
2440MHz	Pass	0.00	-2.37	30.00
2480MHz	Pass	0.00	1.04	30.00



Summary

Mode	PD (dBm/RBW)
2.4-2.4835GHz	-
BT-LE(1Mbps)	-16.29

RBW=3kHz.

Result

Mode	Result	Gain (dBi)	PD (dBm/RBW)	PD Limit (dBm/RBW)
BT-LE(1Mbps)	-	-	-	-
2402MHz	Pass	0.00	-17.96	8.00
2440MHz	Pass	0.00	-17.88	8.00
2480MHz	Pass	0.00	-16.29	8.00

RBW=3kHz.

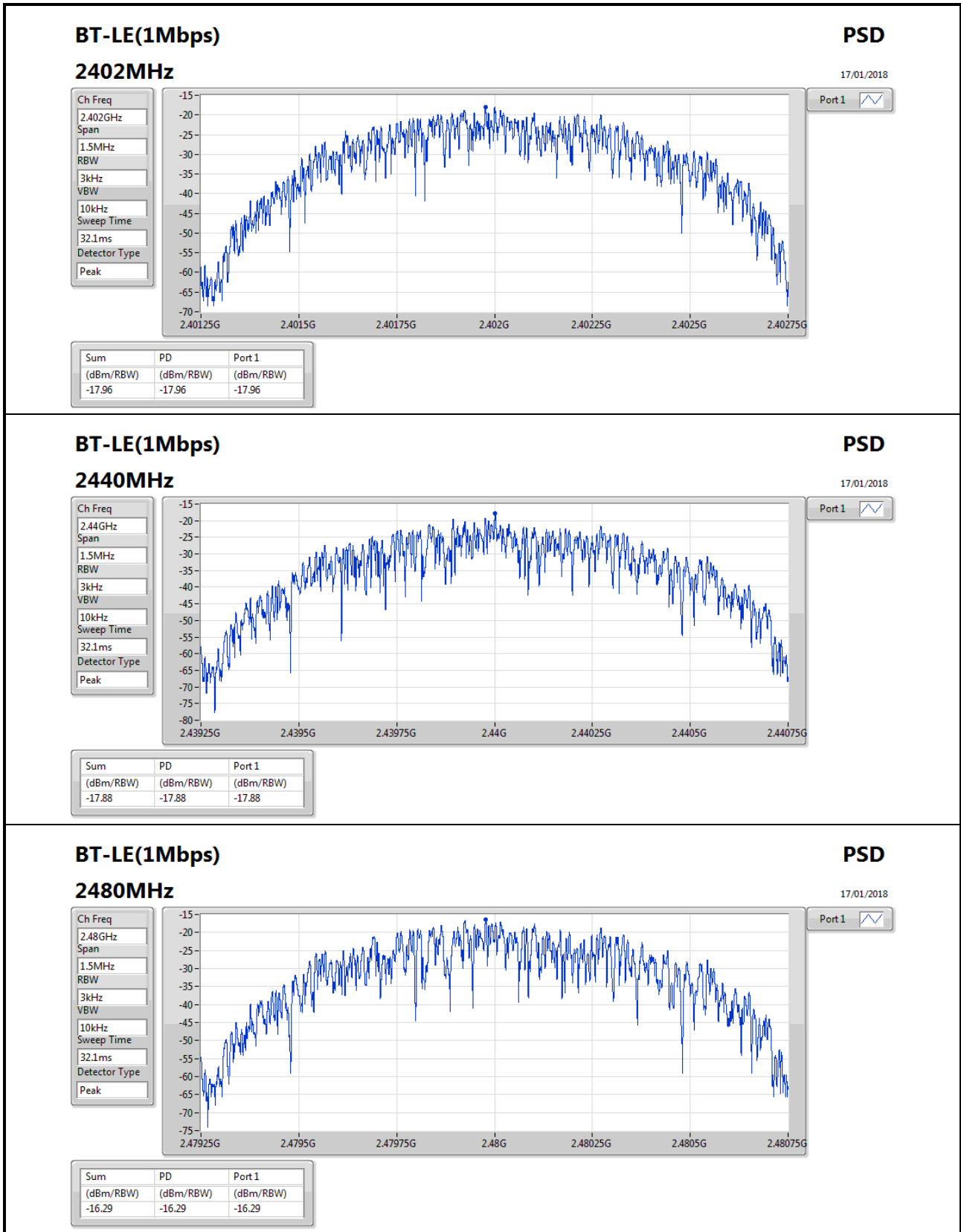



Summary

Mode	Result	Ref (Hz)	Ref (dBm)	Limit (dBm)	Freq (Hz)	Level (dBm)	Freq (Hz)	Level (dBm)	Freq (Hz)	Level (dBm)	Freq (Hz)	Level (dBm)	Port
2.4-2.4835GHz	-	-	-	-	-	-	-	-	-	-	-	-	-
BT-LE(1Mbps)	Pass	2.480327G	-0.32	-30.32	147.216M	-62.26	2.399976G	-58.00	2.483724G	-62.98	15.104877G	-53.14	1

Result

Mode	Result	Ref (Hz)	Ref (dBm)	Limit (dBm)	Freq (Hz)	Level (dBm)	Freq (Hz)	Level (dBm)	Freq (Hz)	Level (dBm)	Freq (Hz)	Level (dBm)	Port
BT-LE(1Mbps)	-	-	-	-	-	-	-	-	-	-	-	-	-
2402MHz	Pass	2.480327G	-0.32	-30.32	147.216M	-62.26	2.399976G	-58.00	2.483724G	-62.98	15.104877G	-53.14	1
2440MHz	Pass	2.480327G	-0.32	-30.32	147.216M	-62.08	2.398732G	-64.55	2.485188G	-63.60	15.349722G	-55.04	1
2480MHz	Pass	2.480327G	-0.32	-30.32	147.216M	-60.69	2.398808G	-64.11	2.4836G	-62.31	15.062663G	-54.24	1

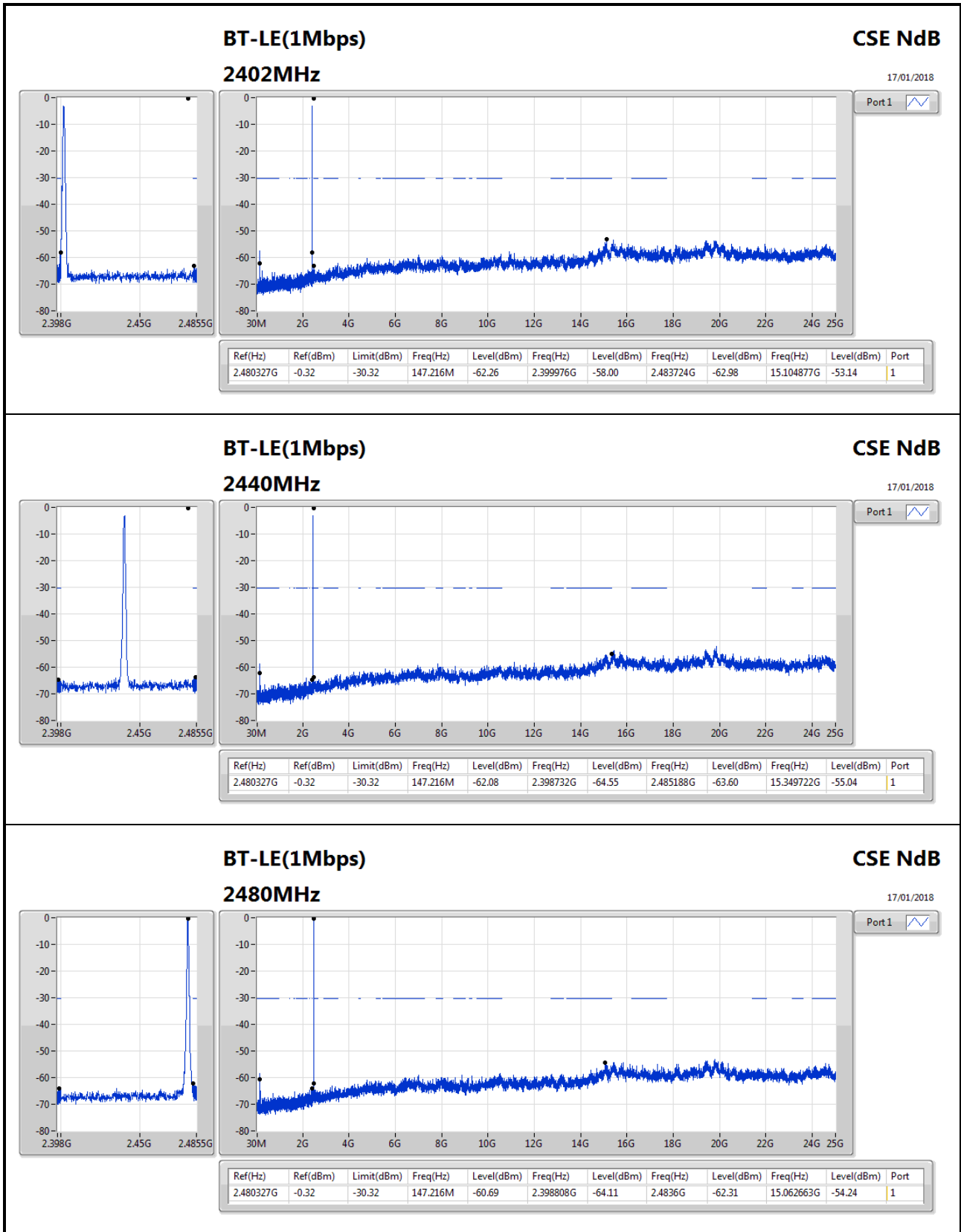



Summary

Mode	Result	Type	Freq (Hz)	Level (dBuV/m)	Limit (dBuV/m)	Margin (dB)	Factor (dB)	Dist (m)	Condition	Azimuth (°)	Height (m)	Comments
2.4-2.4835GHz	-	-	-	-	-	-	-	-	-	-	-	-
BT-LE(1Mbps)	Pass	PK	30M	24.62	40.00	-15.38	-2.39	3	Horizontal	360	1.00	-



Result

Mode	Result	Type	Freq (Hz)	Level (dBuV/m)	Limit (dBuV/m)	Margin (dB)	Factor (dB)	Dist (m)	Condition	Azimuth (°)	Height (m)	Comments
BT-LE(1Mbps)	-	-	-	-	-	-	-	-	-	-	-	-
2440MHz	Pass	PK	30M	24.62	40.00	-15.38	-2.39	3	Horizontal	360	1.00	-
2440MHz	Pass	PK	90.14M	21.66	43.50	-21.84	-11.48	3	Horizontal	360	1.00	-
2440MHz	Pass	PK	280.26M	20.23	46.00	-25.77	-6.01	3	Horizontal	360	1.00	-
2440MHz	Pass	PK	472.32M	25.92	46.00	-20.08	-1.80	3	Horizontal	360	1.00	-
2440MHz	Pass	PK	540.22M	27.33	46.00	-18.67	-0.29	3	Horizontal	360	1.00	-
2440MHz	Pass	PK	670.2M	29.05	46.00	-16.95	0.20	3	Horizontal	360	1.00	-
2440MHz	Pass	PK	31.94M	24.06	40.00	-15.94	-3.57	3	Vertical	0	1.00	-
2440MHz	Pass	PK	90.14M	24.47	43.50	-19.03	-11.48	3	Vertical	0	1.00	-
2440MHz	Pass	PK	276.38M	20.23	46.00	-25.77	-6.09	3	Vertical	0	1.00	-
2440MHz	Pass	PK	352.04M	23.86	46.00	-22.14	-4.57	3	Vertical	0	1.00	-
2440MHz	Pass	PK	538.28M	27.41	46.00	-18.59	-0.44	3	Vertical	0	1.00	-
2440MHz	Pass	PK	594.54M	27.65	46.00	-18.35	-0.61	3	Vertical	0	1.00	-

BT-LE(1Mbps)

2440MHz_Battery

16/01/2018

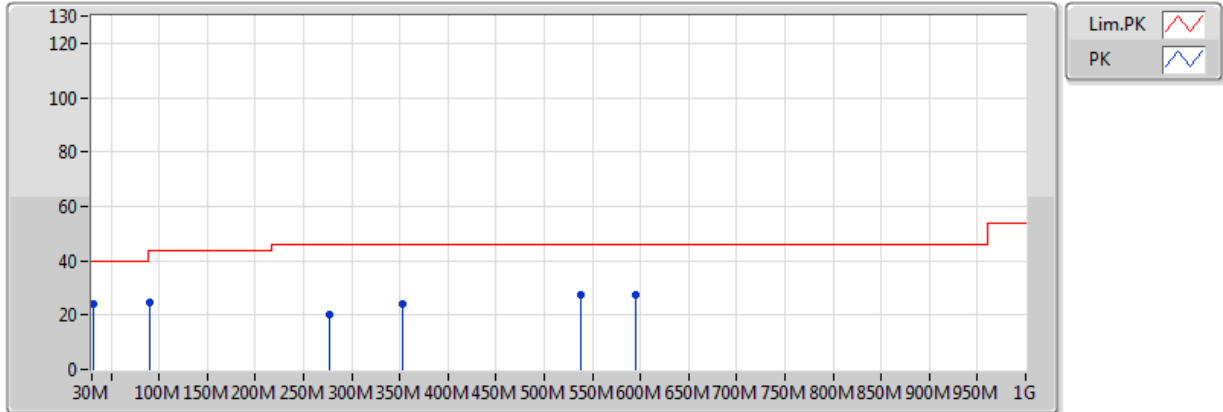



Type	Freq (Hz)	Level (dBuV/m)	Limit (dBuV/m)	Margin (dB)	Factor (dB)	Dist (m)	Condition	Azimuth (°)	Height (m)	Comments	Raw (dBuV)	AF (dB)	CL (dB)	PA (dB)
PK	31.94M	24.06	40.00	-15.94	-3.57	3	Vertical	0	1.00	-	27.63	22.27	1.74	27.58
PK	90.14M	24.47	43.50	-19.03	-11.48	3	Vertical	0	1.00	-	35.95	14.05	1.87	27.40
PK	276.38M	20.23	46.00	-25.77	-6.09	3	Vertical	0	1.00	-	26.32	18.00	2.65	26.74
PK	352.04M	23.86	46.00	-22.14	-4.57	3	Vertical	0	1.00	-	28.43	19.45	2.97	27.00
PK	538.28M	27.41	46.00	-18.59	-0.44	3	Vertical	0	1.00	-	27.85	23.82	3.63	27.89
PK	594.54M	27.65	46.00	-18.35	-0.61	3	Vertical	0	1.00	-	28.26	23.66	3.71	27.98

BT-LE(1Mbps)
2440MHz_Battery

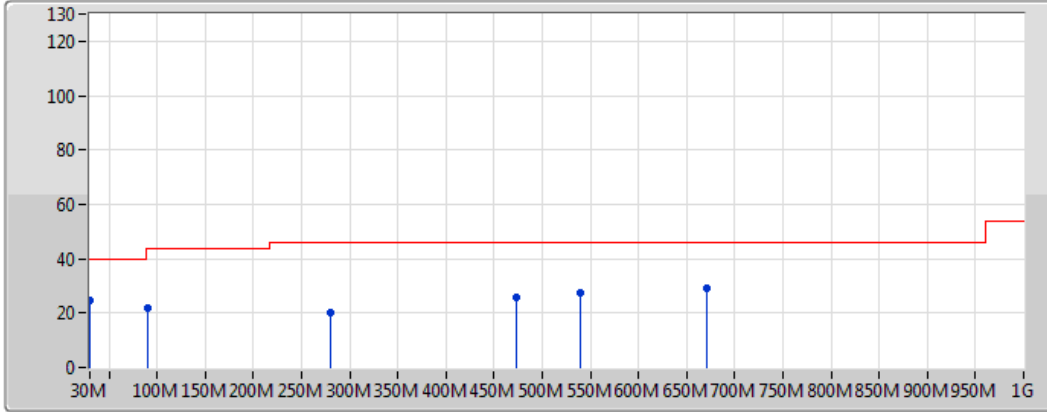
16/01/2018



Lim.PK 
PK 

Type	Freq (Hz)	Level (dBuV/m)	Limit (dBuV/m)	Margin (dB)	Factor (dB)	Dist (m)	Condition	Azimuth (°)	Height (m)	Comments	Raw (dBuV)	AF (dB)	CL (dB)	PA (dB)
PK	30M	24.62	40.00	-15.38	-2.39	3	Horizontal	360	1.00	-	27.01	23.48	1.71	27.58
PK	90.14M	21.66	43.50	-21.84	-11.48	3	Horizontal	360	1.00	-	33.14	14.05	1.87	27.40
PK	280.26M	20.23	46.00	-25.77	-6.01	3	Horizontal	360	1.00	-	26.24	17.99	2.72	26.73
PK	472.32M	25.92	46.00	-20.08	-1.80	3	Horizontal	360	1.00	-	27.72	22.41	3.48	27.68
PK	540.22M	27.33	46.00	-18.67	-0.29	3	Horizontal	360	1.00	-	27.62	23.96	3.64	27.89
PK	670.2M	29.05	46.00	-16.95	0.20	3	Horizontal	360	1.00	-	28.85	24.00	4.16	27.96



Summary

Mode	Result	Type	Freq (Hz)	Level (dBuV/m)	Limit (dBuV/m)	Margin (dB)	Factor (dB)	Dist (m)	Condition	Azimuth (°)	Height (m)	Comments
2.4-2.4835GHz	-	-	-	-	-	-	-	-	-	-	-	-
BT-LE(1Mbps)	Pass	AV	2.4952G	48.39	54.00	-5.61	30.83	3	Vertical	136	1.08	-



Result

Mode	Result	Type	Freq (Hz)	Level (dBuV/m)	Limit (dBuV/m)	Margin (dB)	Factor (dB)	Dist (m)	Condition	Azimuth (°)	Height (m)	Comments
BT-LE(1Mbps)	-	-	-	-	-	-	-	-	-	-	-	-
2402MHz	Pass	AV	2.3832G	47.29	54.00	-6.71	30.43	3	Horizontal	40	1.61	-
2402MHz	Pass	AV	2.402G	90.00	Inf	-Inf	30.50	3	Horizontal	40	1.61	-
2402MHz	Pass	PK	2.3674G	57.93	74.00	-16.07	30.38	3	Horizontal	40	1.61	-
2402MHz	Pass	PK	2.4022G	90.66	Inf	-Inf	30.50	3	Horizontal	40	1.61	-
2402MHz	Pass	AV	2.3526G	47.29	54.00	-6.71	30.32	3	Vertical	138	1.12	-
2402MHz	Pass	AV	2.402G	91.84	Inf	-Inf	30.50	3	Vertical	138	1.12	-
2402MHz	Pass	PK	2.3614G	58.37	74.00	-15.63	30.35	3	Vertical	138	1.12	-
2402MHz	Pass	PK	2.4022G	92.48	Inf	-Inf	30.50	3	Vertical	138	1.12	-
2402MHz	Pass	AV	4.80392G	35.02	54.00	-18.98	5.85	3	Horizontal	176	1.01	-
2402MHz	Pass	PK	4.807313G	45.53	74.00	-28.47	5.86	3	Horizontal	176	1.01	-
2402MHz	Pass	AV	4.80396G	34.16	54.00	-19.84	5.85	3	Vertical	142	1.10	-
2402MHz	Pass	PK	4.80408G	45.78	74.00	-28.22	5.85	3	Vertical	142	1.10	-
2440MHz	Pass	AV	2.3408G	47.36	54.00	-6.64	30.28	3	Horizontal	49	1.33	-
2440MHz	Pass	AV	2.44G	91.02	Inf	-Inf	30.63	3	Horizontal	49	1.33	-
2440MHz	Pass	AV	2.5G	47.90	54.00	-6.10	30.85	3	Horizontal	49	1.33	-
2440MHz	Pass	PK	2.3448G	57.80	74.00	-16.20	30.30	3	Horizontal	49	1.33	-
2440MHz	Pass	PK	2.4396G	91.66	Inf	-Inf	30.63	3	Horizontal	49	1.33	-
2440MHz	Pass	PK	2.4908G	58.56	74.00	-15.44	30.82	3	Horizontal	49	1.33	-
2440MHz	Pass	AV	2.3628G	47.25	54.00	-6.75	30.36	3	Vertical	136	1.08	-
2440MHz	Pass	AV	2.44G	91.09	Inf	-Inf	30.63	3	Vertical	136	1.08	-
2440MHz	Pass	AV	2.4952G	48.39	54.00	-5.61	30.83	3	Vertical	136	1.08	-
2440MHz	Pass	PK	2.3848G	58.17	74.00	-15.83	30.44	3	Vertical	136	1.08	-
2440MHz	Pass	PK	2.4396G	91.72	Inf	-Inf	30.63	3	Vertical	136	1.08	-
2440MHz	Pass	PK	2.4908G	58.70	74.00	-15.30	30.82	3	Vertical	136	1.08	-
2440MHz	Pass	AV	4.88008G	35.64	54.00	-18.36	6.02	3	Horizontal	292	1.07	-
2440MHz	Pass	PK	4.879521G	46.77	74.00	-27.23	6.02	3	Horizontal	292	1.07	-
2440MHz	Pass	AV	4.87984G	34.93	54.00	-19.07	6.02	3	Vertical	163	1.49	-
2440MHz	Pass	PK	4.879521G	45.43	74.00	-28.57	6.02	3	Vertical	163	1.49	-
2480MHz	Pass	AV	2.48G	91.99	Inf	-Inf	30.78	3	Horizontal	138	1.36	-
2480MHz	Pass	AV	2.5G	48.16	54.00	-5.84	30.85	3	Horizontal	138	1.36	-
2480MHz	Pass	PK	2.4798G	92.60	Inf	-Inf	30.78	3	Horizontal	138	1.36	-
2480MHz	Pass	PK	2.492G	59.18	74.00	-14.82	30.82	3	Horizontal	138	1.36	-
2480MHz	Pass	AV	2.48G	92.38	Inf	-Inf	30.78	3	Vertical	133	1.16	-
2480MHz	Pass	AV	2.499G	48.15	54.00	-5.85	30.85	3	Vertical	133	1.16	-
2480MHz	Pass	PK	2.4798G	92.98	Inf	-Inf	30.78	3	Vertical	133	1.16	-
2480MHz	Pass	PK	2.499G	58.79	74.00	-15.21	30.85	3	Vertical	133	1.16	-
2480MHz	Pass	AV	4.95002G	34.10	54.00	-19.90	6.19	3	Horizontal	223	1.09	-
2480MHz	Pass	PK	4.956687G	45.73	74.00	-28.27	6.20	3	Horizontal	223	1.09	-
2480MHz	Pass	AV	4.95988G	34.96	54.00	-19.04	6.21	3	Vertical	0	1.02	-
2480MHz	Pass	PK	4.960559G	46.88	74.00	-27.12	6.21	3	Vertical	0	1.02	-

BT-LE(1Mbps)

2402MHz_TX

16/01/2018

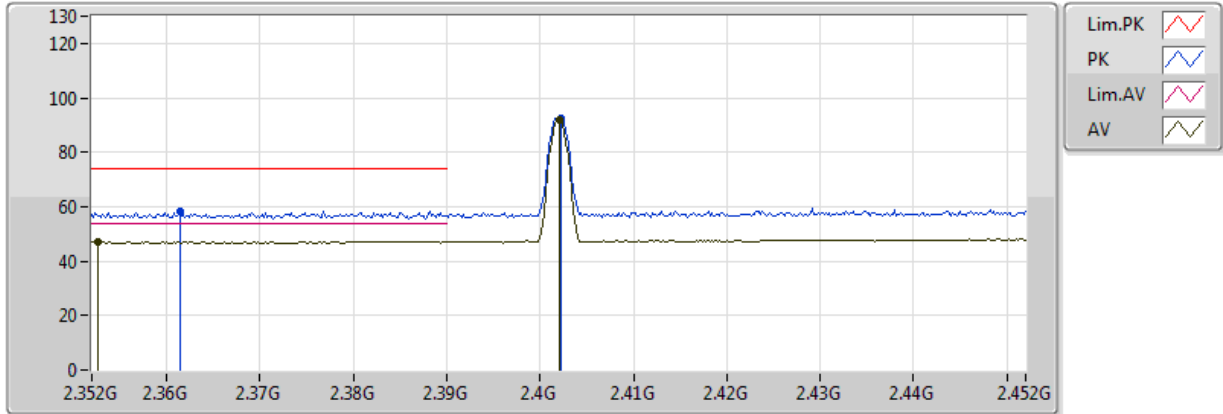

Type	Freq (Hz)	Level (dBuV/m)	Limit (dBuV/m)	Margin (dB)	Factor (dB)	Dist (m)	Condition	Azimuth (°)	Height (m)	Comments	Raw (dBuV)	AF (dB)	CL (dB)	PA (dB)
AV	2.3526G	47.29	54.00	-6.71	30.32	3	Vertical	138	1.12	-	16.96	27.12	3.21	-
AV	2.402G	91.84	Inf	-Inf	30.50	3	Vertical	138	1.12	-	61.34	27.25	3.25	-
PK	2.3614G	58.37	74.00	-15.63	30.35	3	Vertical	138	1.12	-	28.02	27.14	3.22	-
PK	2.4022G	92.48	Inf	-Inf	30.50	3	Vertical	138	1.12	-	61.98	27.25	3.25	-

BT-LE(1Mbps)

2402MHz_TX

16/01/2018

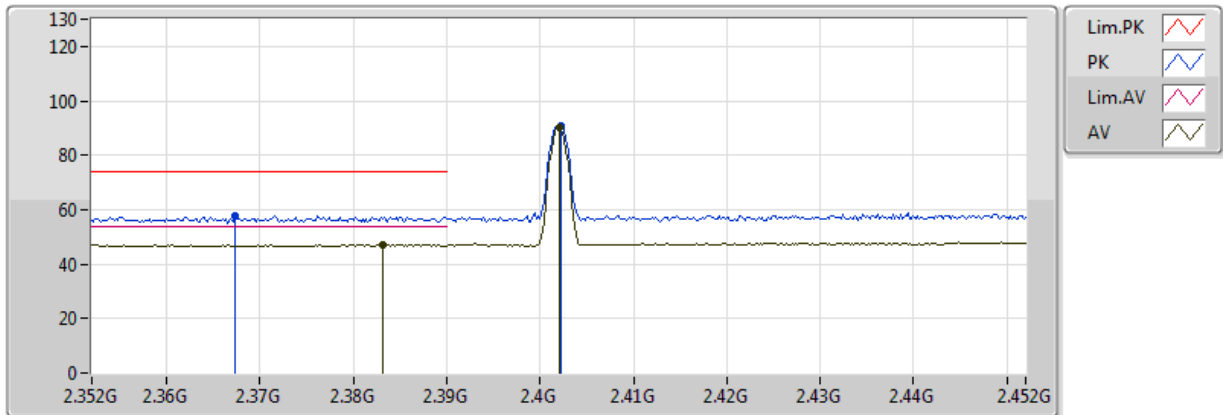

Type	Freq (Hz)	Level (dBuV/m)	Limit (dBuV/m)	Margin (dB)	Factor (dB)	Dist (m)	Condition	Azimuth (°)	Height (m)	Comments	Raw (dBuV)	AF (dB)	CL (dB)	PA (dB)
AV	2.3832G	47.29	54.00	-6.71	30.43	3	Horizontal	40	1.61	-	16.86	27.20	3.23	-
AV	2.402G	90.00	Inf	-Inf	30.50	3	Horizontal	40	1.61	-	59.50	27.25	3.25	-
PK	2.3674G	57.93	74.00	-16.07	30.38	3	Horizontal	40	1.61	-	27.55	27.16	3.22	-
PK	2.4022G	90.66	Inf	-Inf	30.50	3	Horizontal	40	1.61	-	60.17	27.25	3.25	-

BT-LE(1Mbps)

2402MHz_TX

16/01/2018

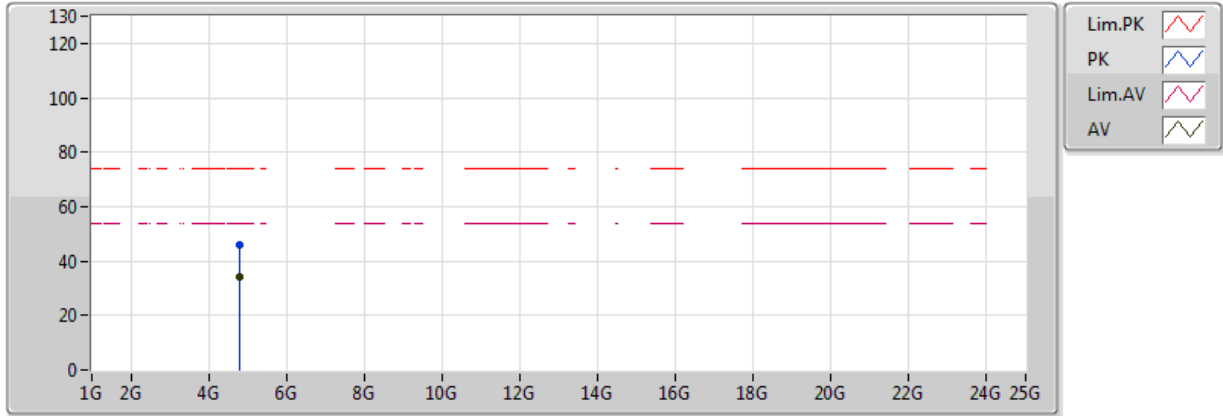

Type	Freq (Hz)	Level (dBuV/m)	Limit (dBuV/m)	Margin (dB)	Factor (dB)	Dist (m)	Condition	Azimuth (°)	Height (m)	Comments	Raw (dBuV)	AF (dB)	CL (dB)	PA (dB)
AV	4.80396G	34.16	54.00	-19.84	5.85	3	Vertical	142	1.10	-	28.31	31.19	4.51	29.85
PK	4.80408G	45.78	74.00	-28.22	5.85	3	Vertical	142	1.10	-	39.93	31.19	4.51	29.85

BT-LE(1Mbps)

2402MHz_TX

16/01/2018

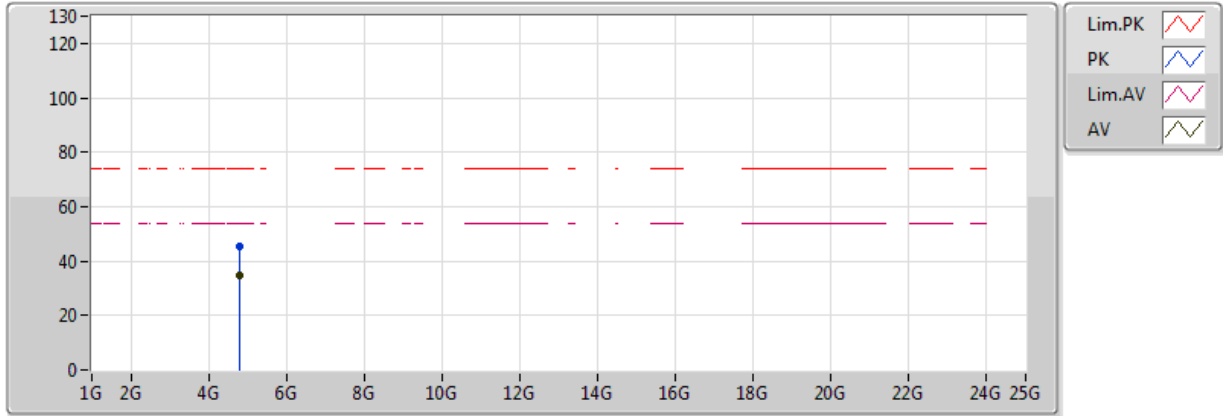

Type	Freq (Hz)	Level (dBuV/m)	Limit (dBuV/m)	Margin (dB)	Factor (dB)	Dist (m)	Condition	Azimuth (°)	Height (m)	Comments	Raw (dBuV)	AF (dB)	CL (dB)	PA (dB)
AV	4.80392G	35.02	54.00	-18.98	5.85	3	Horizontal	176	1.01	-	29.17	31.19	4.51	29.85
PK	4.807313G	45.53	74.00	-28.47	5.86	3	Horizontal	176	1.01	-	39.68	31.19	4.51	29.85

BT-LE(1Mbps)

2440MHz_TX

16/01/2018

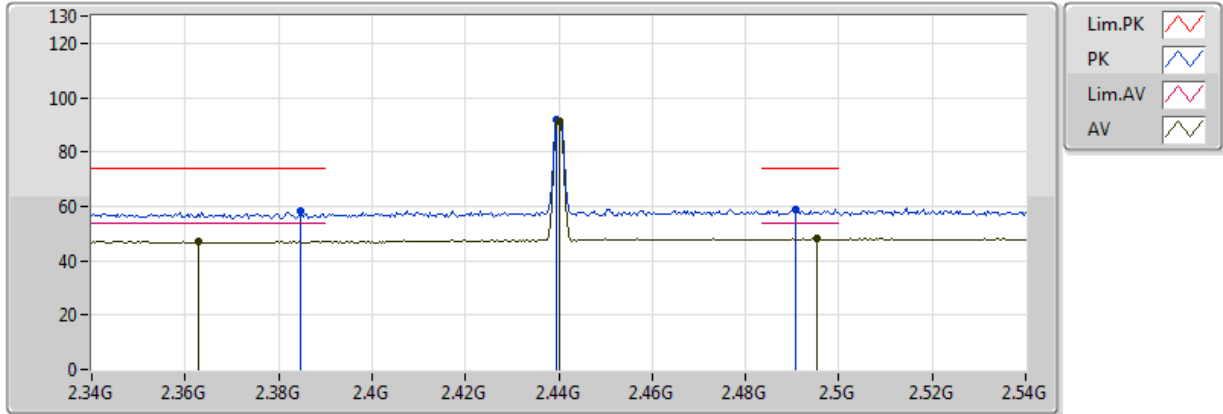

Type	Freq (Hz)	Level (dBuV/m)	Limit (dBuV/m)	Margin (dB)	Factor (dB)	Dist (m)	Condition	Azimuth (°)	Height (m)	Comments	Raw (dBuV)	AF (dB)	CL (dB)	PA (dB)
AV	2.3628G	47.25	54.00	-6.75	30.36	3	Vertical	136	1.08	-	16.89	27.14	3.22	-
AV	2.44G	91.09	Inf	-Inf	30.63	3	Vertical	136	1.08	-	60.45	27.34	3.29	-
AV	2.4952G	48.39	54.00	-5.61	30.83	3	Vertical	136	1.08	-	17.56	27.49	3.35	-
PK	2.3848G	58.17	74.00	-15.83	30.44	3	Vertical	136	1.08	-	27.73	27.20	3.24	-
PK	2.4396G	91.72	Inf	-Inf	30.63	3	Vertical	136	1.08	-	61.09	27.34	3.29	-
PK	2.4908G	58.70	74.00	-15.30	30.82	3	Vertical	136	1.08	-	27.88	27.48	3.34	-



BT-LE(1Mbps)

2440MHz_TX

16/01/2018

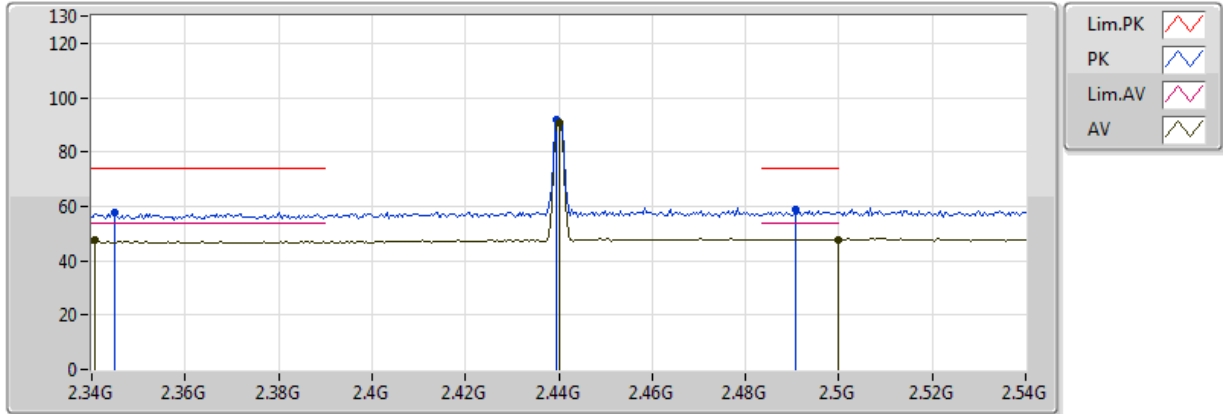

Type	Freq (Hz)	Level (dBuV/m)	Limit (dBuV/m)	Margin (dB)	Factor (dB)	Dist (m)	Condition	Azimuth (°)	Height (m)	Comments	Raw (dBuV)	AF (dB)	CL (dB)	PA (dB)
AV	2.3408G	47.36	54.00	-6.64	30.28	3	Horizontal	49	1.33	-	17.07	27.09	3.20	-
AV	2.44G	91.02	Inf	-Inf	30.63	3	Horizontal	49	1.33	-	60.39	27.34	3.29	-
AV	2.5G	47.90	54.00	-6.10	30.85	3	Horizontal	49	1.33	-	17.05	27.50	3.35	-
PK	2.3448G	57.80	74.00	-16.20	30.30	3	Horizontal	49	1.33	-	27.50	27.10	3.20	-
PK	2.4396G	91.66	Inf	-Inf	30.63	3	Horizontal	49	1.33	-	61.02	27.34	3.29	-
PK	2.4908G	58.56	74.00	-15.44	30.82	3	Horizontal	49	1.33	-	27.74	27.48	3.34	-

BT-LE(1Mbps)

2440MHz_TX

16/01/2018

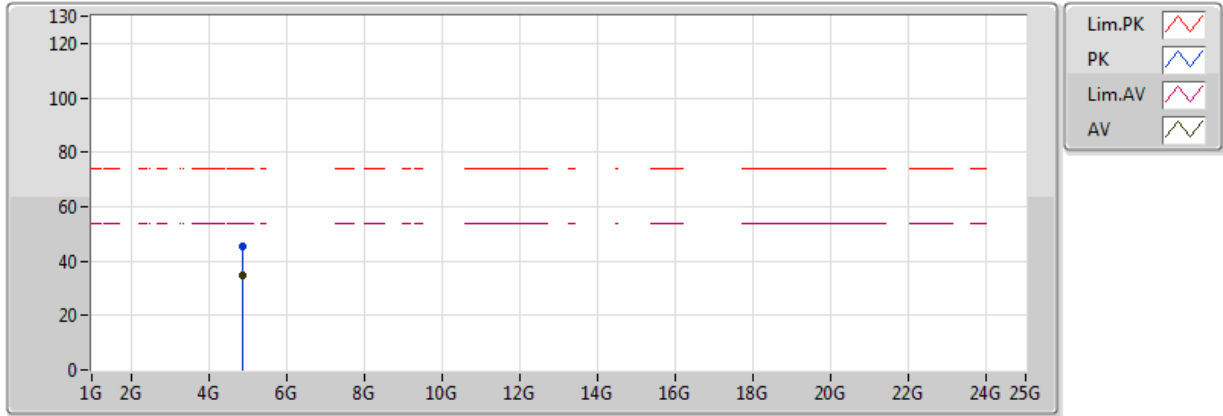

Type	Freq (Hz)	Level (dBuV/m)	Limit (dBuV/m)	Margin (dB)	Factor (dB)	Dist (m)	Condition	Azimuth (°)	Height (m)	Comments	Raw (dBuV)	AF (dB)	CL (dB)	PA (dB)
AV	4.87984G	34.93	54.00	-19.07	6.02	3	Vertical	163	1.49	-	28.90	31.31	4.55	29.83
PK	4.879521G	45.43	74.00	-28.57	6.02	3	Vertical	163	1.49	-	39.40	31.31	4.55	29.83

BT-LE(1Mbps)

2440MHz_TX

16/01/2018

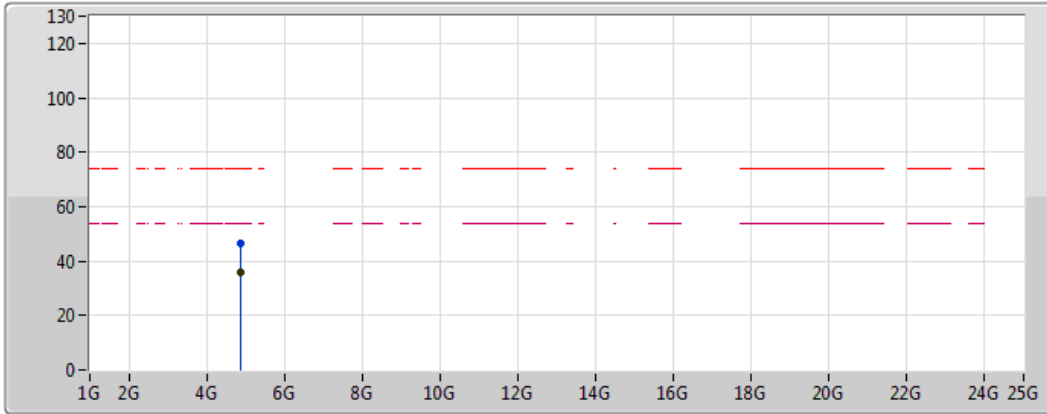

Legend for the spectrum plot:

- Lim.PK: Red dashed line
- PK: Blue solid line
- Lim.AV: Magenta dashed line
- AV: Green solid line

Type	Freq (Hz)	Level (dBuV/m)	Limit (dBuV/m)	Margin (dB)	Factor (dB)	Dist (m)	Condition	Azimuth (°)	Height (m)	Comments	Raw (dBuV)	AF (dB)	CL (dB)	PA (dB)
AV	4.88008G	35.64	54.00	-18.36	6.02	3	Horizontal	292	1.07	-	29.61	31.31	4.55	29.83
PK	4.879521G	46.77	74.00	-27.23	6.02	3	Horizontal	292	1.07	-	40.75	31.31	4.55	29.83

BT-LE(1Mbps)

2480MHz_TX

16/01/2018

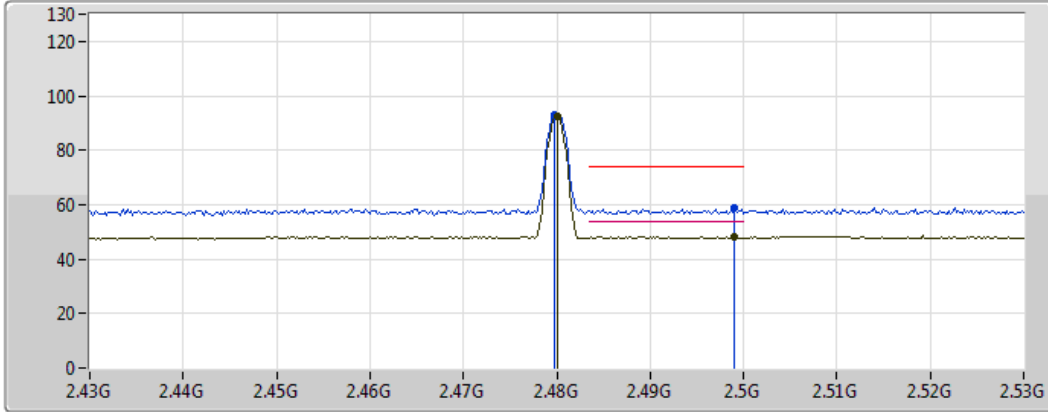

Legend for the spectrum plot:

- Lim.PK: Red line with a peak icon
- PK: Blue line with a peak icon
- Lim.AV: Red line with a valley icon
- AV: Blue line with a valley icon

Type	Freq (Hz)	Level (dBuV/m)	Limit (dBuV/m)	Margin (dB)	Factor (dB)	Dist (m)	Condition	Azimuth (°)	Height (m)	Comments	Raw (dBuV)	AF (dB)	CL (dB)	PA (dB)
AV	2.48G	92.38	Inf	-Inf	30.78	3	Vertical	133	1.16	-	61.60	27.45	3.33	-
AV	2.499G	48.15	54.00	-5.85	30.85	3	Vertical	133	1.16	-	17.31	27.50	3.35	-
PK	2.4798G	92.98	Inf	-Inf	30.78	3	Vertical	133	1.16	-	62.20	27.45	3.33	-
PK	2.499G	58.79	74.00	-15.21	30.85	3	Vertical	133	1.16	-	27.95	27.50	3.35	-

BT-LE(1Mbps)

2480MHz_TX

16/01/2018

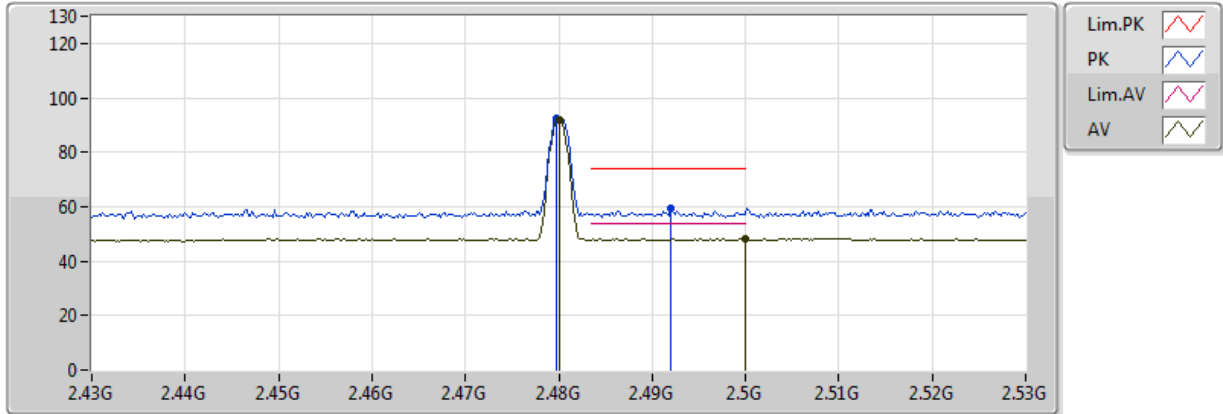

Type	Freq (Hz)	Level (dBuV/m)	Limit (dBuV/m)	Margin (dB)	Factor (dB)	Dist (m)	Condition	Azimuth (°)	Height (m)	Comments	Raw (dBuV)	AF (dB)	CL (dB)	PA (dB)
AV	2.48G	91.99	Inf	-Inf	30.78	3	Horizontal	138	1.36	-	61.21	27.45	3.33	-
AV	2.5G	48.16	54.00	-5.84	30.85	3	Horizontal	138	1.36	-	17.31	27.50	3.35	-
PK	2.4798G	92.60	Inf	-Inf	30.78	3	Horizontal	138	1.36	-	61.82	27.45	3.33	-
PK	2.492G	59.18	74.00	-14.82	30.82	3	Horizontal	138	1.36	-	28.36	27.48	3.34	-

BT-LE(1Mbps)

2480MHz_TX

16/01/2018

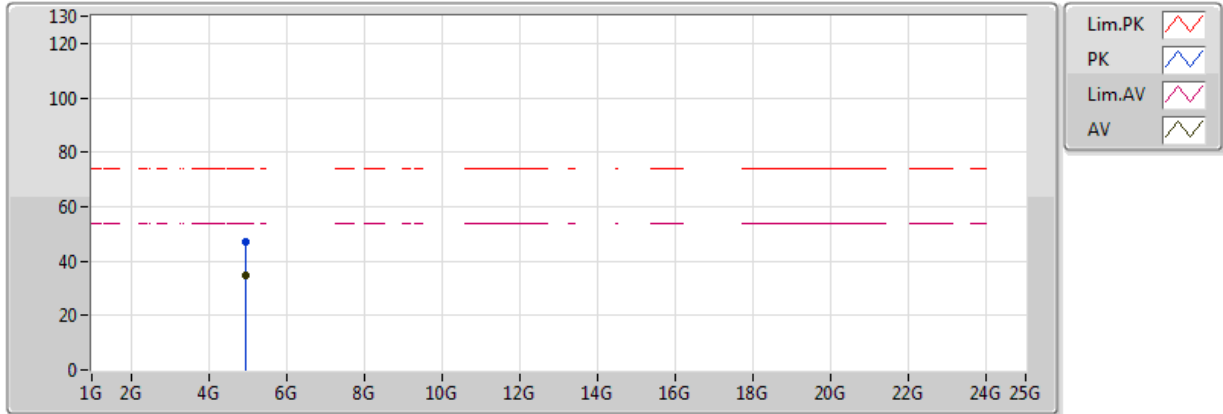

Type	Freq (Hz)	Level (dBuV/m)	Limit (dBuV/m)	Margin (dB)	Factor (dB)	Dist (m)	Condition	Azimuth (°)	Height (m)	Comments	Raw (dBuV)	AF (dB)	CL (dB)	PA (dB)
AV	4.95988G	34.96	54.00	-19.04	6.21	3	Vertical	0	1.02	-	28.76	31.44	4.59	29.82
PK	4.960559G	46.88	74.00	-27.12	6.21	3	Vertical	0	1.02	-	40.67	31.44	4.59	29.82

BT-LE(1Mbps)

2480MHz_TX

16/01/2018

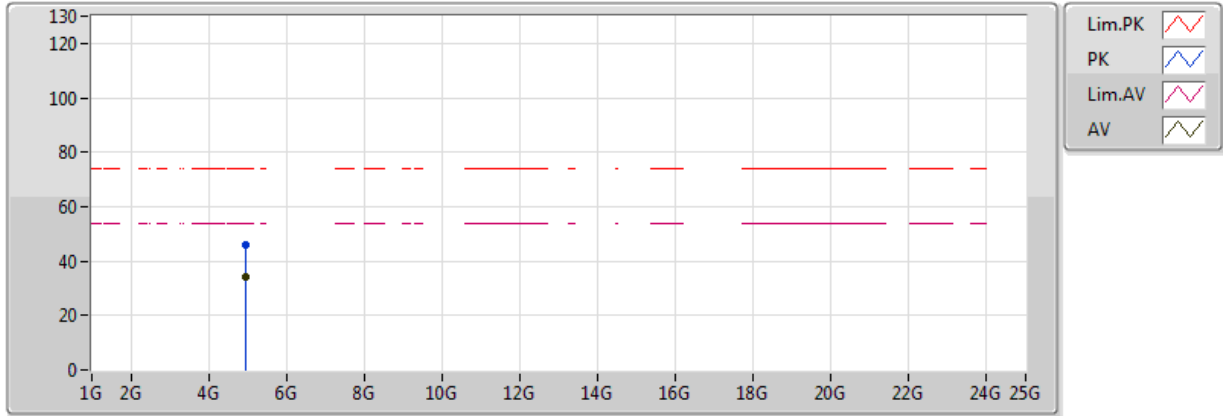

Type	Freq (Hz)	Level (dBuV/m)	Limit (dBuV/m)	Margin (dB)	Factor (dB)	Dist (m)	Condition	Azimuth (°)	Height (m)	Comments	Raw (dBuV)	AF (dB)	CL (dB)	PA (dB)
AV	4.95002G	34.10	54.00	-19.90	6.19	3	Horizontal	223	1.09	-	27.91	31.42	4.59	29.82
PK	4.956687G	45.73	74.00	-28.27	6.20	3	Horizontal	223	1.09	-	39.53	31.43	4.59	29.82



AC Power-line Conducted Emissions Result																																																																																																																																		
Operating Mode	1	Power Phase	Neutral																																																																																																																															
Operating Function	Adapter mode																																																																																																																																	
<div style="text-align: right;">Date: 2018-02-14</div> <p>The graph displays the AC power-line conducted emissions. The y-axis represents Level in dBuV, ranging from 0 to 80. The x-axis represents Frequency in MHz, ranging from 0.150 to 30. Two red lines indicate the limits: NCC/IC/FCC-B (upper) and NCC/IC/FCC-B-AV (lower). A blue line shows the measured emission levels, which are generally below the limits, with a notable peak at 0.6140 MHz.</p>																																																																																																																																		
	<table border="1"> <thead> <tr> <th></th> <th>Freq</th> <th>Level</th> <th>Over Limit</th> <th>Limit Line</th> <th>Read Level</th> <th>LISN Factor</th> <th>Cable Loss</th> <th>Remark</th> </tr> <tr> <th></th> <th>MHz</th> <th>dBuV</th> <th>dB</th> <th>dBuV</th> <th>dBuV</th> <th>dB</th> <th>dB</th> <th></th> </tr> </thead> <tbody> <tr><td>1</td><td>0.1508</td><td>34.68</td><td>-21.28</td><td>55.96</td><td>25.01</td><td>9.63</td><td>0.04</td><td>Average</td></tr> <tr><td>2</td><td>0.1508</td><td>45.88</td><td>-20.08</td><td>65.96</td><td>36.21</td><td>9.63</td><td>0.04</td><td>QP</td></tr> <tr><td>3</td><td>0.1768</td><td>33.69</td><td>-20.95</td><td>54.64</td><td>24.05</td><td>9.62</td><td>0.02</td><td>Average</td></tr> <tr><td>4</td><td>0.1768</td><td>44.14</td><td>-20.50</td><td>64.64</td><td>34.50</td><td>9.62</td><td>0.02</td><td>QP</td></tr> <tr><td>5</td><td>0.1945</td><td>33.85</td><td>-19.99</td><td>53.84</td><td>24.23</td><td>9.62</td><td>0.00</td><td>Average</td></tr> <tr><td>6</td><td>0.1945</td><td>42.95</td><td>-20.89</td><td>63.84</td><td>33.33</td><td>9.62</td><td>0.00</td><td>QP</td></tr> <tr><td>7</td><td>0.2185</td><td>33.48</td><td>-19.40</td><td>52.88</td><td>23.85</td><td>9.62</td><td>0.01</td><td>Average</td></tr> <tr><td>8</td><td>0.2185</td><td>41.51</td><td>-21.37</td><td>62.88</td><td>31.88</td><td>9.62</td><td>0.01</td><td>QP</td></tr> <tr><td>9</td><td>0.2391</td><td>32.39</td><td>-19.74</td><td>52.13</td><td>22.74</td><td>9.62</td><td>0.03</td><td>Average</td></tr> <tr><td>10</td><td>0.2391</td><td>39.45</td><td>-22.68</td><td>62.13</td><td>29.80</td><td>9.62</td><td>0.03</td><td>QP</td></tr> <tr><td>11 MAX</td><td>0.6140</td><td>31.76</td><td>-14.24</td><td>46.00</td><td>22.10</td><td>9.61</td><td>0.05</td><td>Average</td></tr> <tr><td>12</td><td>0.6140</td><td>37.26</td><td>-18.74</td><td>56.00</td><td>27.60</td><td>9.61</td><td>0.05</td><td>QP</td></tr> </tbody> </table>		Freq	Level	Over Limit	Limit Line	Read Level	LISN Factor	Cable Loss	Remark		MHz	dBuV	dB	dBuV	dBuV	dB	dB		1	0.1508	34.68	-21.28	55.96	25.01	9.63	0.04	Average	2	0.1508	45.88	-20.08	65.96	36.21	9.63	0.04	QP	3	0.1768	33.69	-20.95	54.64	24.05	9.62	0.02	Average	4	0.1768	44.14	-20.50	64.64	34.50	9.62	0.02	QP	5	0.1945	33.85	-19.99	53.84	24.23	9.62	0.00	Average	6	0.1945	42.95	-20.89	63.84	33.33	9.62	0.00	QP	7	0.2185	33.48	-19.40	52.88	23.85	9.62	0.01	Average	8	0.2185	41.51	-21.37	62.88	31.88	9.62	0.01	QP	9	0.2391	32.39	-19.74	52.13	22.74	9.62	0.03	Average	10	0.2391	39.45	-22.68	62.13	29.80	9.62	0.03	QP	11 MAX	0.6140	31.76	-14.24	46.00	22.10	9.61	0.05	Average	12	0.6140	37.26	-18.74	56.00	27.60	9.61	0.05	QP			
	Freq	Level	Over Limit	Limit Line	Read Level	LISN Factor	Cable Loss	Remark																																																																																																																										
	MHz	dBuV	dB	dBuV	dBuV	dB	dB																																																																																																																											
1	0.1508	34.68	-21.28	55.96	25.01	9.63	0.04	Average																																																																																																																										
2	0.1508	45.88	-20.08	65.96	36.21	9.63	0.04	QP																																																																																																																										
3	0.1768	33.69	-20.95	54.64	24.05	9.62	0.02	Average																																																																																																																										
4	0.1768	44.14	-20.50	64.64	34.50	9.62	0.02	QP																																																																																																																										
5	0.1945	33.85	-19.99	53.84	24.23	9.62	0.00	Average																																																																																																																										
6	0.1945	42.95	-20.89	63.84	33.33	9.62	0.00	QP																																																																																																																										
7	0.2185	33.48	-19.40	52.88	23.85	9.62	0.01	Average																																																																																																																										
8	0.2185	41.51	-21.37	62.88	31.88	9.62	0.01	QP																																																																																																																										
9	0.2391	32.39	-19.74	52.13	22.74	9.62	0.03	Average																																																																																																																										
10	0.2391	39.45	-22.68	62.13	29.80	9.62	0.03	QP																																																																																																																										
11 MAX	0.6140	31.76	-14.24	46.00	22.10	9.61	0.05	Average																																																																																																																										
12	0.6140	37.26	-18.74	56.00	27.60	9.61	0.05	QP																																																																																																																										
<p>Note 1: ">20dB" means emission levels that exceed the level of 20 dB below the applicable limit. Note 2: "N/F" means Nothing Found emissions (No emissions were detected.)</p>																																																																																																																																		



AC Power-line Conducted Emissions Result

Operating Mode	1	Power Phase	Line
Operating Function	Adapter mode		

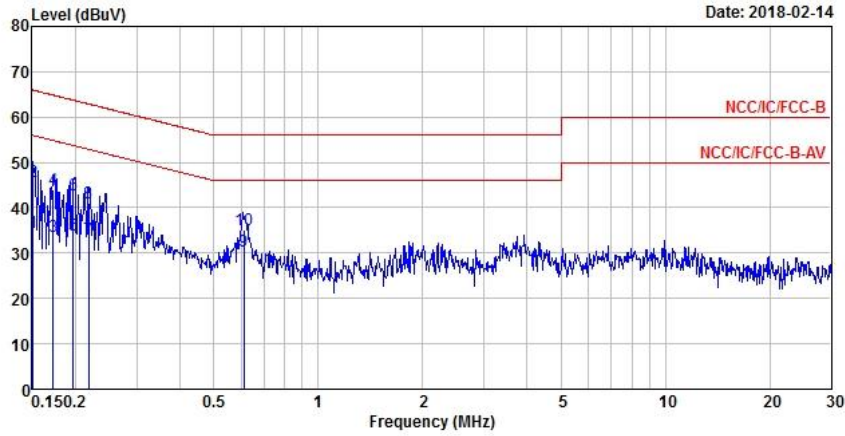

	Freq	Level	Over	Limit	Read	LISN	Cable	Remark
	MHz	dBuV	Limit	Line	Level	Factor	Loss	
			dB	dBuV	dBuV	dB	dB	
1	0.1508	34.42	-21.54	55.96	24.76	9.62	0.04	Average
2	0.1508	45.75	-20.21	65.96	36.09	9.62	0.04	QP
3	0.1722	33.77	-21.09	54.86	24.13	9.62	0.02	Average
4	0.1722	43.88	-20.98	64.86	34.24	9.62	0.02	QP
5	0.1965	33.85	-19.91	53.76	24.23	9.62	0.00	Average
6	0.1965	42.67	-21.09	63.76	33.05	9.62	0.00	QP
7	0.2185	32.96	-19.92	52.88	23.33	9.62	0.01	Average
8	0.2185	40.94	-21.94	62.88	31.31	9.62	0.01	QP
9 MAX	0.6108	30.45	-15.55	46.00	20.79	9.61	0.05	Average
10	0.6108	35.21	-20.79	56.00	25.55	9.61	0.05	QP

Note 1: ">20dB" means emission levels that exceed the level of 20 dB below the applicable limit.
 Note 2: "N/F" means Nothing Found emissions (No emissions were detected.)

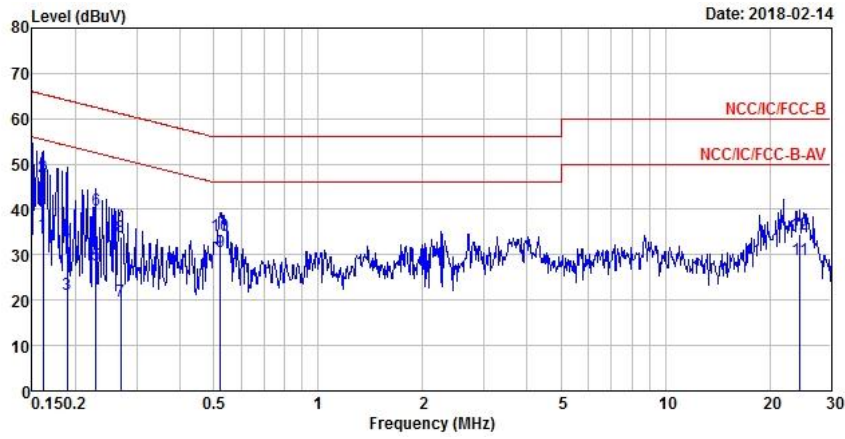

AC Power-line Conducted Emissions Result																																																																																																																																	
Operating Mode	2	Power Phase	Neutral																																																																																																																														
Operating Function	PoE mode																																																																																																																																
<div style="display: flex; justify-content: space-between;"> <div>  <p>The graph shows the AC Power-line Conducted Emissions Result. The Y-axis is Level (dBuV) ranging from 0 to 80. The X-axis is Frequency (MHz) on a logarithmic scale from 0.150.2 to 30. Two red lines represent the NCC/IC/FCC-B and NCC/IC/FCC-B-AV limits. A blue line shows the measured emission levels, which are generally below the limits, with a peak at 0.5238 MHz.</p> </div> <div style="text-align: right;">Date: 2018-02-14</div> </div>																																																																																																																																	
<table border="1" style="width:100%; border-collapse: collapse;"> <thead> <tr> <th></th> <th>Freq</th> <th>Level</th> <th>Over Limit</th> <th>Limit Line</th> <th>Read Level</th> <th>LISN Factor</th> <th>Cable Loss</th> <th>Remark</th> </tr> <tr> <th></th> <th>MHz</th> <th>dBuV</th> <th>dB</th> <th>dBuV</th> <th>dBuV</th> <th>dB</th> <th>dB</th> <th></th> </tr> </thead> <tbody> <tr><td>1</td><td>0.1616</td><td>34.59</td><td>-20.79</td><td>55.38</td><td>24.94</td><td>9.62</td><td>0.03</td><td>Average</td></tr> <tr><td>2</td><td>0.1616</td><td>47.17</td><td>-18.21</td><td>65.38</td><td>37.52</td><td>9.62</td><td>0.03</td><td>QP</td></tr> <tr><td>3</td><td>0.1894</td><td>21.35</td><td>-32.71</td><td>54.06</td><td>11.72</td><td>9.62</td><td>0.01</td><td>Average</td></tr> <tr><td>4</td><td>0.1894</td><td>32.87</td><td>-31.19</td><td>64.06</td><td>23.24</td><td>9.62</td><td>0.01</td><td>QP</td></tr> <tr><td>5</td><td>0.2292</td><td>27.89</td><td>-24.59</td><td>52.48</td><td>18.25</td><td>9.62</td><td>0.02</td><td>Average</td></tr> <tr><td>6</td><td>0.2292</td><td>39.88</td><td>-22.60</td><td>62.48</td><td>30.24</td><td>9.62</td><td>0.02</td><td>QP</td></tr> <tr><td>7</td><td>0.2701</td><td>19.75</td><td>-31.37</td><td>51.12</td><td>10.09</td><td>9.62</td><td>0.04</td><td>Average</td></tr> <tr><td>8</td><td>0.2701</td><td>33.88</td><td>-27.24</td><td>61.12</td><td>24.22</td><td>9.62</td><td>0.04</td><td>QP</td></tr> <tr style="border: 2px solid black;"><td>9 MAX</td><td>0.5238</td><td>30.77</td><td>-15.23</td><td>46.00</td><td>21.09</td><td>9.61</td><td>0.07</td><td>Average</td></tr> <tr><td>10</td><td>0.5238</td><td>34.35</td><td>-21.65</td><td>56.00</td><td>24.67</td><td>9.61</td><td>0.07</td><td>QP</td></tr> <tr><td>11</td><td>24.3995</td><td>28.90</td><td>-21.10</td><td>50.00</td><td>19.32</td><td>9.56</td><td>0.02</td><td>Average</td></tr> <tr><td>12</td><td>24.3995</td><td>34.54</td><td>-25.46</td><td>60.00</td><td>24.96</td><td>9.56</td><td>0.02</td><td>QP</td></tr> </tbody> </table>					Freq	Level	Over Limit	Limit Line	Read Level	LISN Factor	Cable Loss	Remark		MHz	dBuV	dB	dBuV	dBuV	dB	dB		1	0.1616	34.59	-20.79	55.38	24.94	9.62	0.03	Average	2	0.1616	47.17	-18.21	65.38	37.52	9.62	0.03	QP	3	0.1894	21.35	-32.71	54.06	11.72	9.62	0.01	Average	4	0.1894	32.87	-31.19	64.06	23.24	9.62	0.01	QP	5	0.2292	27.89	-24.59	52.48	18.25	9.62	0.02	Average	6	0.2292	39.88	-22.60	62.48	30.24	9.62	0.02	QP	7	0.2701	19.75	-31.37	51.12	10.09	9.62	0.04	Average	8	0.2701	33.88	-27.24	61.12	24.22	9.62	0.04	QP	9 MAX	0.5238	30.77	-15.23	46.00	21.09	9.61	0.07	Average	10	0.5238	34.35	-21.65	56.00	24.67	9.61	0.07	QP	11	24.3995	28.90	-21.10	50.00	19.32	9.56	0.02	Average	12	24.3995	34.54	-25.46	60.00	24.96	9.56	0.02	QP
	Freq	Level	Over Limit	Limit Line	Read Level	LISN Factor	Cable Loss	Remark																																																																																																																									
	MHz	dBuV	dB	dBuV	dBuV	dB	dB																																																																																																																										
1	0.1616	34.59	-20.79	55.38	24.94	9.62	0.03	Average																																																																																																																									
2	0.1616	47.17	-18.21	65.38	37.52	9.62	0.03	QP																																																																																																																									
3	0.1894	21.35	-32.71	54.06	11.72	9.62	0.01	Average																																																																																																																									
4	0.1894	32.87	-31.19	64.06	23.24	9.62	0.01	QP																																																																																																																									
5	0.2292	27.89	-24.59	52.48	18.25	9.62	0.02	Average																																																																																																																									
6	0.2292	39.88	-22.60	62.48	30.24	9.62	0.02	QP																																																																																																																									
7	0.2701	19.75	-31.37	51.12	10.09	9.62	0.04	Average																																																																																																																									
8	0.2701	33.88	-27.24	61.12	24.22	9.62	0.04	QP																																																																																																																									
9 MAX	0.5238	30.77	-15.23	46.00	21.09	9.61	0.07	Average																																																																																																																									
10	0.5238	34.35	-21.65	56.00	24.67	9.61	0.07	QP																																																																																																																									
11	24.3995	28.90	-21.10	50.00	19.32	9.56	0.02	Average																																																																																																																									
12	24.3995	34.54	-25.46	60.00	24.96	9.56	0.02	QP																																																																																																																									
<p>Note 1: ">20dB" means emission levels that exceed the level of 20 dB below the applicable limit. Note 2: "N/F" means Nothing Found emissions (No emissions were detected.)</p>																																																																																																																																	

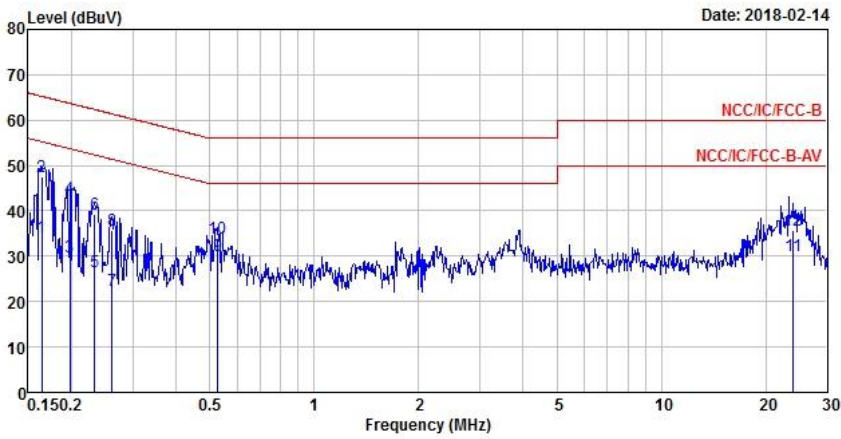
AC Power-line Conducted Emissions Result																																																																																																																															
Operating Mode	2	Power Phase	Line																																																																																																																												
Operating Function	PoE mode																																																																																																																														
<div style="display: flex; justify-content: space-between;"> <div>  <p>The graph shows the AC Power-line Conducted Emissions Result. The Y-axis is Level (dBuV) ranging from 0 to 80. The X-axis is Frequency (MHz) on a logarithmic scale from 0.150.2 to 30. Two red lines represent the limits: NCC/IC/FCC-B (upper) and NCC/IC/FCC-B-AV (lower). A blue line represents the measured emission level, which fluctuates between approximately 20 and 50 dBuV, generally staying below the NCC/IC/FCC-B-AV limit.</p> </div> <div style="text-align: right;">Date: 2018-02-14</div> </div>																																																																																																																															
	<table border="1" style="width: 100%; border-collapse: collapse;"> <thead> <tr> <th></th> <th>Freq</th> <th>Level</th> <th>Over Limit</th> <th>Limit Line</th> <th>Read Level</th> <th>LISN Factor</th> <th>Cable Loss</th> <th>Remark</th> </tr> <tr> <th></th> <th>MHz</th> <th>dBuV</th> <th>dB</th> <th>dBuV</th> <th>dBuV</th> <th>dB</th> <th>dB</th> <th></th> </tr> </thead> <tbody> <tr><td>1</td><td>0.1641</td><td>34.21</td><td>-21.04</td><td>55.25</td><td>24.55</td><td>9.63</td><td>0.03</td><td>Average</td></tr> <tr><td>2</td><td>0.1641</td><td>47.40</td><td>-17.85</td><td>65.25</td><td>37.74</td><td>9.63</td><td>0.03</td><td>QP</td></tr> <tr><td>3</td><td>0.1976</td><td>29.94</td><td>-23.77</td><td>53.71</td><td>20.32</td><td>9.62</td><td>0.00</td><td>Average</td></tr> <tr><td>4</td><td>0.1976</td><td>42.93</td><td>-20.78</td><td>63.71</td><td>33.31</td><td>9.62</td><td>0.00</td><td>QP</td></tr> <tr><td>5</td><td>0.2329</td><td>26.44</td><td>-25.91</td><td>52.35</td><td>16.80</td><td>9.62</td><td>0.02</td><td>Average</td></tr> <tr><td>6</td><td>0.2329</td><td>39.13</td><td>-23.22</td><td>62.35</td><td>29.49</td><td>9.62</td><td>0.02</td><td>QP</td></tr> <tr><td>7</td><td>0.2616</td><td>22.53</td><td>-28.85</td><td>51.38</td><td>12.87</td><td>9.62</td><td>0.04</td><td>Average</td></tr> <tr><td>8</td><td>0.2616</td><td>35.63</td><td>-25.75</td><td>61.38</td><td>25.97</td><td>9.62</td><td>0.04</td><td>QP</td></tr> <tr><td>9 MAX</td><td>0.5265</td><td>30.21</td><td>-15.79</td><td>46.00</td><td>20.53</td><td>9.61</td><td>0.07</td><td>Average</td></tr> <tr><td>10</td><td>0.5265</td><td>34.06</td><td>-21.94</td><td>56.00</td><td>24.38</td><td>9.61</td><td>0.07</td><td>QP</td></tr> <tr><td>11</td><td>24.0148</td><td>30.21</td><td>-19.79</td><td>50.00</td><td>20.47</td><td>9.70</td><td>0.04</td><td>Average</td></tr> <tr><td>12</td><td>24.0148</td><td>35.59</td><td>-24.41</td><td>60.00</td><td>25.85</td><td>9.70</td><td>0.04</td><td>QP</td></tr> </tbody> </table>		Freq	Level	Over Limit	Limit Line	Read Level	LISN Factor	Cable Loss	Remark		MHz	dBuV	dB	dBuV	dBuV	dB	dB		1	0.1641	34.21	-21.04	55.25	24.55	9.63	0.03	Average	2	0.1641	47.40	-17.85	65.25	37.74	9.63	0.03	QP	3	0.1976	29.94	-23.77	53.71	20.32	9.62	0.00	Average	4	0.1976	42.93	-20.78	63.71	33.31	9.62	0.00	QP	5	0.2329	26.44	-25.91	52.35	16.80	9.62	0.02	Average	6	0.2329	39.13	-23.22	62.35	29.49	9.62	0.02	QP	7	0.2616	22.53	-28.85	51.38	12.87	9.62	0.04	Average	8	0.2616	35.63	-25.75	61.38	25.97	9.62	0.04	QP	9 MAX	0.5265	30.21	-15.79	46.00	20.53	9.61	0.07	Average	10	0.5265	34.06	-21.94	56.00	24.38	9.61	0.07	QP	11	24.0148	30.21	-19.79	50.00	20.47	9.70	0.04	Average	12	24.0148	35.59	-24.41	60.00	25.85	9.70	0.04	QP
	Freq	Level	Over Limit	Limit Line	Read Level	LISN Factor	Cable Loss	Remark																																																																																																																							
	MHz	dBuV	dB	dBuV	dBuV	dB	dB																																																																																																																								
1	0.1641	34.21	-21.04	55.25	24.55	9.63	0.03	Average																																																																																																																							
2	0.1641	47.40	-17.85	65.25	37.74	9.63	0.03	QP																																																																																																																							
3	0.1976	29.94	-23.77	53.71	20.32	9.62	0.00	Average																																																																																																																							
4	0.1976	42.93	-20.78	63.71	33.31	9.62	0.00	QP																																																																																																																							
5	0.2329	26.44	-25.91	52.35	16.80	9.62	0.02	Average																																																																																																																							
6	0.2329	39.13	-23.22	62.35	29.49	9.62	0.02	QP																																																																																																																							
7	0.2616	22.53	-28.85	51.38	12.87	9.62	0.04	Average																																																																																																																							
8	0.2616	35.63	-25.75	61.38	25.97	9.62	0.04	QP																																																																																																																							
9 MAX	0.5265	30.21	-15.79	46.00	20.53	9.61	0.07	Average																																																																																																																							
10	0.5265	34.06	-21.94	56.00	24.38	9.61	0.07	QP																																																																																																																							
11	24.0148	30.21	-19.79	50.00	20.47	9.70	0.04	Average																																																																																																																							
12	24.0148	35.59	-24.41	60.00	25.85	9.70	0.04	QP																																																																																																																							
<p>Note 1: ">20dB" means emission levels that exceed the level of 20 dB below the applicable limit. Note 2: "N/F" means Nothing Found emissions (No emissions were detected.)</p>																																																																																																																															