



# FCC RADIO TEST REPORT

Applicant : Ubiquiti Inc.  
Address : 685 Third Avenue, New York, New York 10017, USA  
Equipment : UniFi Connect Cast  
Model No. : UC-Cast  
Trade Name : UBIQUITI  
FCC ID : SWX-UCCAST

**I HEREBY CERTIFY THAT :**

The sample was received on Jan. 04, 2022 and the testing was completed on Jan. 19, 2022 at CerpPASS Technology Corp. The test result refers exclusively to the test presented test model / sample. Without written approval of CerpPASS Technology Corp., the test report shall not be reproduced except in full.

Approved by:

Mark Liao / Supervisor

Laboratory Accreditation:

CerpPASS Technology Corporation Test Laboratory





CONTENTS

- 1. **Summary of Test Procedure and Test Results**.....5
  - 1.1 Applicable Standards .....5
- 2. **Test Configuration of Equipment under Test**.....6
  - 2.1 Feature of Equipment under Test.....6
  - 2.2 Carrier Frequency of Channels .....7
  - 2.3 Test Mode & Test Software .....8
  - 2.4 Description of Test System.....9
  - 2.5 General Information of Test.....10
  - 2.6 Measurement Uncertainty .....10
- 3. **Test Equipment and Ancillaries Used for Tests**.....11
- 4. **Antenna Requirements**.....13
  - 4.1 Standard Applicable .....13
  - 4.2 Antenna Construction and Directional Gain.....13
- 5. **Test of AC Power Line Conducted Emission** .....14
  - 5.1 Test Limit .....14
  - 5.2 Test Procedures .....14
  - 5.3 Typical Test Setup .....15
  - 5.4 Test Result and Data .....16
  - 5.5 Test Photographs .....18
- 6. **Test of Radiated Spurious Emission**.....19
  - 6.1 Test Limit .....19
  - 6.2 Test Procedures.....20
  - 6.3 Typical Test Setup .....21
  - 6.4 Test Result and Data (9kHz ~ 30MHz).....22
  - 6.5 Test Result and Data (30MHz ~ 1GHz).....22
  - 6.6 Test Result and Data (1GHz ~ 25GHz).....24
  - 6.7 Restricted Bands of Operation .....36
  - 6.8 Test Photographs (30MHz ~ 1GHz) .....37
  - 6.9 Test Photographs (1GHz ~ 25GHz) .....38
- 7. **Test of Conducted Spurious Emission** .....40
  - 7.1 Test Limit .....40
  - 7.2 Test Procedure .....40
  - 7.3 Test Setup Layout .....40
  - 7.4 Test Result and Data .....40
- 8. **20dB Bandwidth Measurement Data**.....48
  - 8.1 Test Limit .....48
  - 8.2 Test Procedures .....48
  - 8.3 Test Setup Layout .....48
  - 8.4 Test Result and Data .....48
- 9. **Carrier Frequency Separation** .....51
  - 9.1 Test Limit .....51
  - 9.2 Test Procedures .....51



9.3 Test Setup Layout .....51

9.4 Test Result and Data .....51

**10. Dwell Time on each channel .....54**

10.1 Test Limit .....54

10.2 Test Procedures .....54

10.3 Test Setup Layout .....54

10.4 Test Result and Data .....54

**11. Number of Hopping Channels .....57**

11.1 Test Limit .....57

11.2 Test Procedures .....57

11.3 Test Setup Layout .....57

11.4 Test Result and Data .....57

**12. Maximum Average Output Power .....59**

12.1 Test Limit .....59

12.2 Test Procedures .....59

12.3 Test Setup Layout .....59

12.4 Test Result and Data .....59

**13. Radio Frequency Exposure .....60**

13.1 Applicable Standards .....60

13.2 EUT Specification .....60

13.3 Test Results .....61

13.4 Calculation .....61

13.5 Maximum Permissible Exposure.....62



**History of this test report**

Report No.	Issued Date	Description
21120307-TRFCC02	Jan. 21, 2022	Original



# 1. Summary of Test Procedure and Test Results

## 1.1 Applicable Standards

**ANSI C63.10:2013**

**FCC Rules and Regulations Part 15 Subpart C §15.247**

FCC Rule	Description of Test	Result
15.203	. Antenna Requirement	PASS
15.207	. AC Power Line Conducted Emission	PASS
15.209 15.205	. Radiated Spurious Emission	PASS
15.247(d)	. Conducted Spurious Emission	PASS
15.247(a)(1)	. Channel Carrier Frequencies Separation	PASS
15.247(a)(1)	. 20dB Bandwidth	PASS
15.247(a)(1)	. Dwell Time	PASS
15.247(b)	. Number of Hopping Channels	PASS
15.247(b)	. Output Power	PASS
2.1091	. Radio Frequency Exposure	PASS

\* The lab has reduced the uncertainty risk factor from test equipment, environment and staff technicians which according to the standard on contract. Therefore, the test result will only be determined by standard requirement.

\*This EUT has been also tested and compiled with the requirement of FCC Part 15, Subpart B, recorded in a separate test report(21120307-TEFV01).



## 2. Test Configuration of Equipment under Test

### 2.1 Feature of Equipment under Test

Operation Frequency Range	BT / BLE: 2400-2483.5MHz 802.11b/g/n: 2400-2483.5MHz 802.11a/n/ac: 5150-5250MHz, 5250-5350MHz, 5470-5725MHz, 5725-5850MHz
Center Frequency Range	BT / BLE: 2402MHz-2480MHz 802.11b/g/n: 2412MHz-2462MHz 802.11a/n/ac: 5180-5240MHz, 5260-5320MHz, 5500-5700MHz, 5745-5825MHz
Modulation Type	BT: GFSK, $\pi/4$ -DQPSK, 8DPSK BLE: GFSK WLAN: 2.4GHz: 802.11b: CCK, DQPSK, DBPSK 802.11g/n: BPSK, QPSK, 16QAM, 64QAM 5GHz: 802.11n/a: BPSK, QPSK, 16QAM, 64QAM 802.11ac: BPSK, QPSK, 16QAM, 64QAM, 256QAM
Modulation Technology	DSSS, OFDM, FHSS, DTS
Data Rate	BT: GFSK: 1Mbps, $\pi/4$ -DQPSK: 2Mbps, 8DPSK: 3Mbps BLE: GFSK: 1Mbps, GFSK: 2Mbps WLAN: 2.4GHz: 802.11b: 1, 2, 5.5, 11Mbps 802.11g: 6, 9, 12, 18, 24, 36, 48, 54Mbps 802.11n: MCS0 – MCS7, HT20/40 5GHz: 802.11a: 6, 9, 12, 18, 24, 36, 48, 54Mbps 802.11n: MCS0 – MCS7, HT20/40 802.11ac: MCS0 – MCS9, VHT20/40/80
Antenna Type	PIFA Antenna
Antenna Gain	For BT / BLE: 2400-2480MHz: 0.3dBi For WLAN: 2400-2483.5MHz: 0.3dBi 5150-5250MHz: 5.4dBi 5250-5350MHz: 5.4dBi 5470-5725MHz: 5.4dBi 5725-5850MHz: 5.4dBi
Adapter	Brand: UBIQUITI Model: E005-1I050100VU
HDMI cable	Brand: YUQIU ELECTRONICS CO., LTD. Model: 680-00265

Note:

1. EUT support TPC Function.
2. WLAN 5GHz and BT can simultaneously transmission.
3. EUT support DFS Client Mode, without radar detection.
4. For more details, please refer to the User's manual of the EUT.



## 2.2 Carrier Frequency of Channels

Channel	Frequency (MHz)	Channel	Frequency (MHz)	Channel	Frequency (MHz)	Channel	Frequency (MHz)
<b>*00</b>	<b>2402</b>	20	2422	40	2442	60	2462
01	2403	21	2423	41	2443	61	2463
02	2404	22	2424	42	2444	62	2464
03	2405	23	2425	43	2445	63	2465
04	2406	24	2426	44	2446	64	2466
05	2407	25	2427	45	2447	65	2467
06	2408	26	2428	46	2448	66	2468
07	2409	27	2429	47	2449	67	2469
08	2410	28	2430	48	2450	68	2470
09	2411	29	2431	49	2451	69	2471
10	2412	30	2432	50	2452	70	2472
11	2413	31	2433	51	2453	71	2473
12	2414	32	2434	52	2454	72	2474
13	2415	33	2435	53	2455	73	2475
14	2416	34	2436	54	2456	74	2476
15	2417	35	2437	55	2457	75	2477
16	2418	36	2438	56	2458	76	2478
17	2419	37	2439	57	2459	77	2479
18	2420	38	2440	58	2460	<b>*78</b>	<b>2480</b>
19	2421	<b>*39</b>	<b>2441</b>	59	2461	---	---

Note: Channels remarked \* are selected to perform test.



## 2.3 Test Mode & Test Software

- During testing, the interface cables and equipment positions were varied according to ANSI C63.10
- The complete test system included Notebook and EUT for RF test.
- An executive program, " RFTestTool ver.1" under Windows OS system was executed to transmit and receive data via Bluetooth.
- The following test modes were performed for the test:

Conducted Emissions from the AC mains power ports	
Test Mode	Operating Description
1	GFSK (1Mbps) With Adapter
2	$\pi/4$ -DQPSK (2Mbps) With Adapter
3	8DPSK (3Mbps) With Adapter
4	GFSK (1Mbps) With PoE
5	$\pi/4$ -DQPSK (2Mbps) With PoE
6	8DPSK (3Mbps) With PoE
caused "Test Mode 4" generated the worst case, it was reported as the final data.	
Radiation Emissions (9KHz ~ 30MHz and 30MHz ~ 1GHz)	
Test Mode	Operating Description
1	GFSK (1Mbps) With Adapter
2	$\pi/4$ -DQPSK (2Mbps) With Adapter
3	8DPSK (3Mbps) With Adapter
4	GFSK (1Mbps) With PoE
5	$\pi/4$ -DQPSK (2Mbps) With PoE
6	8DPSK (3Mbps) With PoE
caused "Test Mode 1" generated the worst case, it was reported as the final data.	
Radiation Emissions (1GHz ~ 25GHz)	
Test Mode	Operating Description
1	GFSK (1Mbps)
2	$\pi/4$ -DQPSK (2Mbps)
3	8DPSK (3Mbps)
caused "Test Mode 1~2" generated the worst case, they were reported as the final data.	

Note:

- There are two kinds of test voltage: AC 120V / 60Hz and AC 240V / 60Hz.  
For AC Power Line Conducted Emission, AC 240V / 60Hz is worst case.  
For Radiated Spurious Emission, (9KHz ~30MHz & 30MHz ~ 1GHz), AC 240V / 60Hz is worst case.

Modulation Type	TX CONFIGURATION
GFSK	1TX
$\pi/4$ -DQPSK	1TX
8DPSK	1TX





### 2.4 Description of Test System

RF Conducted				
Equipment	Brand	Model	Length/Type	Power cord/Length/Type
Notebook	lenovo	S1GL2W	N/A	N/A
Type C Cable	kolin	KEX-DLCP07	1m / NS	N/A
RJ45 Cable	TE CONNECTIVITY	Cat5e	1.2m / NS	N/A
POE	UBIQUITI	GP-H480-050G	N/A	0.6m / NS
Radiated Emissions				
Equipment	Brand	Model	Length/Type	Power cord/Length/Type
Notebook	ASUS	P2430U	N/A	Adapter / 1.8m / NS
Type C Cable	kolin	KEX-DLCP07	1m / NS	N/A
RJ45 Cable	TE CONNECTIVITY	Cat5e	1.2m / NS	N/A
POE	UBIQUITI	GP-H480-050G	N/A	0.6m / NS
Monitor	DELL	U2410f	NA	N/A
AC Power Line Conducted Emission				
Equipment	Brand	Model	Length/Type	Power cord/Length/Type
Notebook	ASUS	P2430U	N/A	Adapter / 1.8m / NS
Type C Cable	kolin	KEX-DLCP07	1m / NS	N/A
RJ45 Cable	TE CONNECTIVITY	Cat5e	1.2m / NS	N/A
POE	UBIQUITI	GP-H480-050G	N/A	0.6m / NS
Monitor	DELL	U2410f	NA	N/A



## 2.5 General Information of Test

Test Site	<b>Cerpass Technology Corporation Test Laboratory</b> Address: No.10, Ln. 2, Lianfu St., Luzhu Dist., Taoyuan City 33848, Taiwan (R.O.C.) Tel:+886-3-3226-888 Fax:+886-3-3226-881	
	FCC	TW1439, TW1079
	IC	4934E-1, 4934E-2
	VCCI	T-2205 for Telecommunication test C-4663 for Conducted emission test R-4218 for Radiated emission test G-10812, G-10813 for radiated disturbance above 1GHz
Frequency Range Investigated:	Conducted: from 150kHz to 30 MHz Radiation: from 30 MHz to 25,000MHz	
Test Distance:	The test distance of radiated emission from antenna to EUT is 3 M.	

Test Item	Test Site	Test period	Environmental Conditions	Tested By
RF Conducted	RFCON01-NK	2022/01/14	23°C / 45%	Dian Chen
Radiated Emissions	3M02-NK	2022/01/17	20°C / 52%	Dian Chen
AC Power Line Conducted Emission	CON01-NK	2022/01/13~2022/01/19	19~20°C / 47~53%	Dian Chen

## 2.6 Measurement Uncertainty

ISO/IEC 17025 requires that an estimate of the measurement uncertainties associated with the emissions test results be included in the report. The measurement uncertainties given below are based on a 95% confidence level (based on a coverage factor (k=2))

Measurement Item	Uncertainty
AC Power Line Conduction(150K~30MHz)	±3.12dB
Radiated Spurious Emission(9KHz~30MHz)	±3.4dB
Radiated Spurious Emission(30MHz~1GHz)	±5.6dB
Radiated Spurious Emission(1GHz~25GHz)	±6.6dB
Conducted Spurious Emission	±1.8dB
6dB Bandwidth	±4.4%
20dB Bandwidth	±4.4%
Occupied Bandwidth	±4.4%
Peak Output Power(Conducted Power Meter)	±1.1dB
Dwell Time / Deactivation Time	±1.2%
Power Spectral Density	±1.8dB
Duty Cycle	±1.2%



### 3. Test Equipment and Ancillaries Used for Tests

Test Item	Radiated Emissions				
Test Site	Semi Anechoic Room(3M02-NK)				
Instrument	Manufacturer	Model No	Serial No	Calibration Date	Valid Date
Bilog Antenna	Schwarzbeck	VULB9168	275	2021/11/05	2022/11/04
Active Loop Antenna	EMCO	6507	40855	2021/06/10	2022/06/09
Horn Antenna	EMCO	3115	31601	2021/10/14	2022/10/13
EMI Receiver	ROHDE & SCHWARZ	ESCI	101402	2021/03/12	2022/03/11
Spectrum Analyzer	ROHDE & SCHWARZ	FSV 40-N	102151	2021/08/06	2022/08/05
Preamplifier	EM Electronics corp.	EM330	60658	2021/10/13	2022/10/12
Preamplifier	Agilent	8449B	3008A01954	2021/03/22	2022/03/21
Bluetooth Tester	ROHDE & SCHWARZ	CBT	101133	2021/04/19	2022/04/18
Cable-3in1(30M-1G)	HARBOUR INDUSTRIES	LL142	CCE1315	2021/04/12	2022/04/11
Cable-0.5m(1G-18G)	EMEC	EM104-SMSM-0.5M	CCE1354	2021/05/06	2022/05/05
Cable-3m(1G-18G)	EMEC	EM104-SMSM-3M	CCE1355	2021/05/06	2022/05/05
Cable-8m(1G-18G)	EMEC	EM104-SMSM-8M	CCE1356	2021/05/06	2022/05/05
Cable-0.5m(30M-40G)	HUBER SUHNER	SUCOFLEX 102	28420/2	2021/04/03	2022/04/02
Cable-3m(30M-40G)	HUBER SUHNER	SUCOFLEX 102	MY2608/2	2021/04/09	2022/04/08
Cable-0.5m(1G-40G)	Rapidtek	40GHZ 50CM	38MS-38MS50314	2021/04/08	2022/04/07
Cable-6m(9k~300M)	NA	EMC5D-BM-BM-6	130605	2021/09/22	2022/09/21
E3	AUDIX	v8.2014-8-6	RK-000529	NA	NA

Test Item	RF Conducted				
Test Site	RFCON01-NK				
Instrument	Manufacturer	Model No	Serial No	Calibration Date	Valid Date
Bluetooth Tester	ROHDE & SCHWARZ	CBT	101133	2021/04/19	2022/04/18
EXA Signal Analyzer	KEYSIGHT	N9010A	MY54200207	2021/04/21	2022/04/20
Attenuator	KEYSIGHT	8491B	MY39250703	2021/04/09	2022/04/08
TEMP & HUMI CHAMBER	T-MACHINE	TMJ-9712	T-12-040111	2021/08/27	2022/08/26
Cable-0.5m(1G-26.5G)	HUBER SUHNER	SUCOFLEX 102	28422/2	2021/04/08	2022/04/07
Power Meter	Anritsu	ML2495A	1224005	2021/04/14	2022/04/13
Power Sensor	Anritsu	MA2411B	1207295	2021/04/14	2022/04/13
Switch Box	Theda	1-4	TW5451159	NA	NA
MXG-B RF Vector Signal Generator	KEYSIGHT	N5182B	MY53051383	2021/06/30	2022/06/29



Test Item	AC Power Line Conducted Emission				
Test Site	CON01-NK				
<b>Instrument</b>	<b>Manufacturer</b>	<b>Model No</b>	<b>Serial No</b>	<b>Calibration Date</b>	<b>Valid Date</b>
EMI Receiver	ROHDE & SCHWARZ	ESCI	101200	2021/08/30	2022/08/29
Line Impedance Stabilization Network	Schwarzbeck	NSLK 8127	8127-568	2021/06/02	2022/06/01
Pulse Limiter	ROHDE & SCHWARZ	ESH3-Z2	101934	2021/03/10	2022/03/09
Cable-6m(9k~300M)	NA	EMC5D-BM-BM-6	130606	2021/03/15	2022/03/14
E3	AUDIX	v8.2014-8-6	RK-000531	NA	NA



## 4. Antenna Requirements

### 4.1 Standard Applicable

For intentional device, according to FCC 47 CFR Section 15.203, an intentional radiator shall be designed to ensure that no antenna other than that furnished by the responsible party shall be used with the device.

And according to FCC 47 CFR Section 15.247 (b), if transmitting antennas of directional gain greater than 6dBi are used, the power shall be reduced by the amount in dB that the directional gain of the antenna exceeds 6dBi.

### 4.2 Antenna Construction and Directional Gain

Antenna Type	PIFA Antenna
Antenna Gain	0.3 dBi



## 5. Test of AC Power Line Conducted Emission

### 5.1 Test Limit

Conducted Emissions were measured from 150 kHz to 30 MHz with a bandwidth of 9 KHz, according to the methods defined in ANSI C63.10-2013. The EUT was placed on a nonmetallic stand in a shielded room 0.8 meters above the ground plane. The interface cables and equipment positioning were varied within limits of reasonable applications to determine the position produced maximum conducted emissions.

Frequency (MHz)	Quasi Peak (dB $\mu$ V)	Average (dB $\mu$ V)
0.15 – 0.5	66-56*	56-46*
0.5 – 5.0	56	46
5.0 – 30.0	60	50

\*Decreases with the logarithm of the frequency.

### 5.2 Test Procedures

- The EUT was placed 0.4 meter from the conducting wall of the shielding room was kept at least 80 centimeters from any other grounded conducting surface.
- Connect EUT to the power mains through a line impedance stabilization network (LISN).
- All the support units are connecting to the other LISN.
- The LISN provides 50 ohm coupling impedance for the measuring instrument.
- The FCC states that a 50 ohm, 50 micro-Henry LISN should be used.
- Both sides of AC line were checked for maximum conducted interference.
- The frequency range from 150 kHz to 30 MHz was searched.
- Set the test-receiver system to Peak Detect Function and Specified Bandwidth with Maximum Hold Mode.



### 5.3 Typical Test Setup

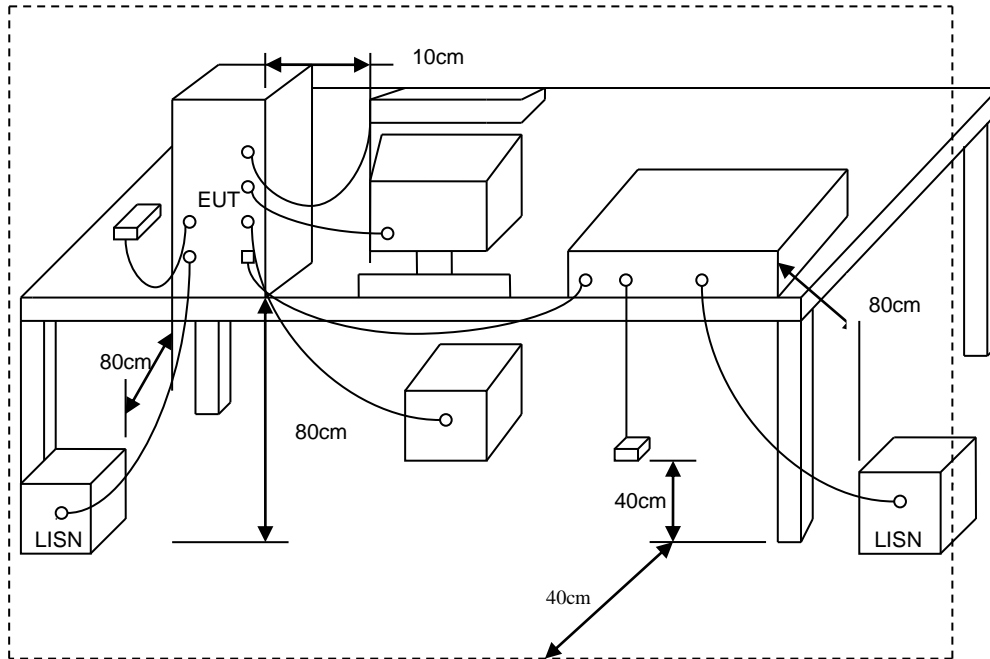



### 5.4 Test Result and Data

Power	: AC 240V / 60Hz	Pol/Phase	: LINE
Test Mode	: Mode 4		

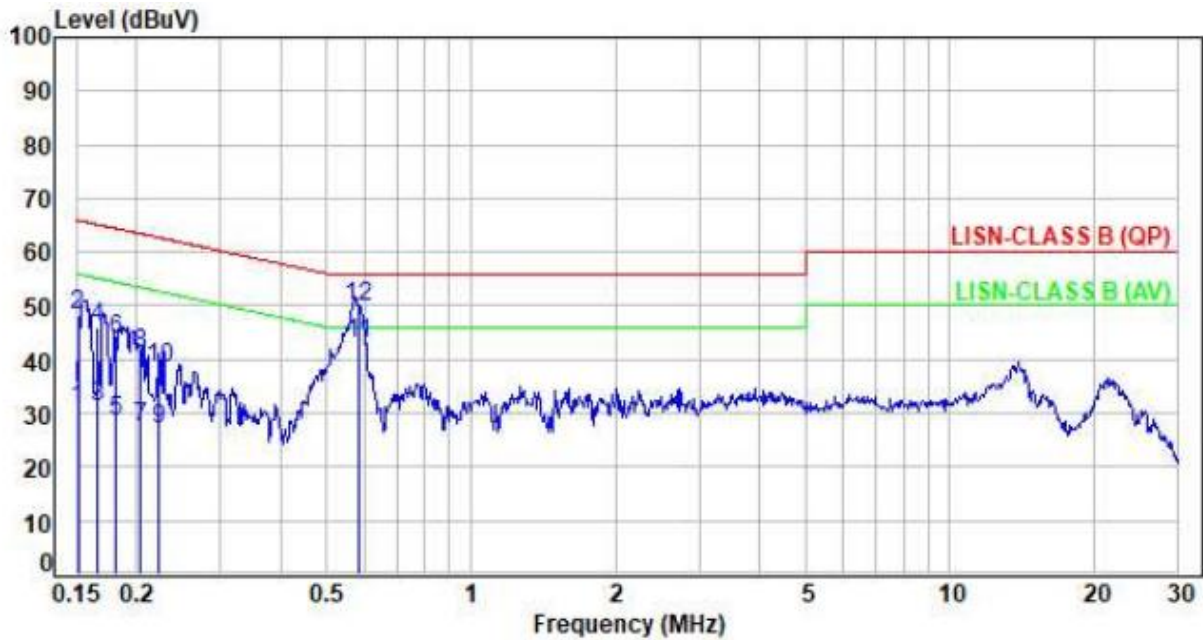

No.	Frequency (MHz)	Factor (dB)	Reading (dBuV)	Level (dBuV)	Limit (dBuV)	Margin (dB)	Detector	P/F
1	0.15	9.92	20.87	30.79	55.94	-25.15	Average	P
2	0.15	9.92	38.35	48.27	65.94	-17.67	QP	P
3	0.17	9.92	21.32	31.24	55.15	-23.91	Average	P
4	0.17	9.92	36.13	46.05	65.15	-19.10	QP	P
5	0.18	9.92	18.76	28.68	54.41	-25.73	Average	P
6	0.18	9.92	33.73	43.65	64.41	-20.76	QP	P
7	0.20	9.92	17.60	27.52	53.46	-25.94	Average	P
8	0.20	9.92	31.00	40.92	63.46	-22.54	QP	P
9	0.22	9.92	17.08	27.00	52.72	-25.72	Average	P
10	0.22	9.92	28.47	38.39	62.72	-24.33	QP	P
11	0.58	9.92	32.98	42.90	46.00	-3.10	Average	P
12	0.58	9.92	39.82	49.74	56.00	-6.26	QP	P

Note: Level=Reading+Factor  
Margin=Level-Limit  
Factor=(LISN or ISN or Current Probe)Factor + Cable Loss





Power	: AC 240V / 60Hz	Pol/Phase	: NEUTRAL
Test Mode	: Mode 4		:

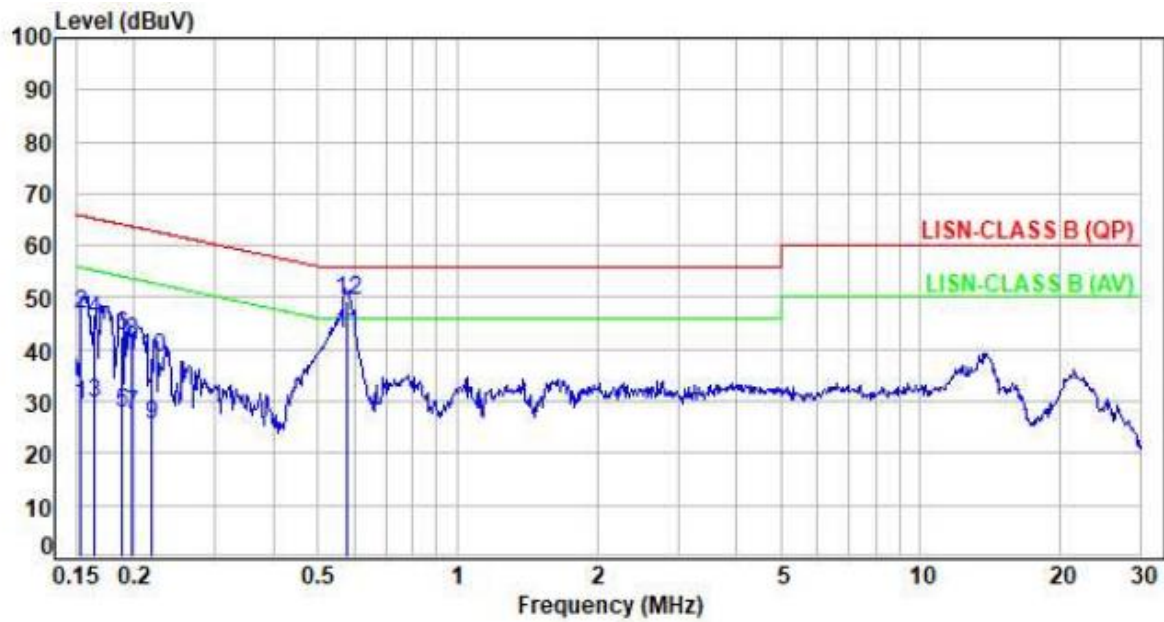

No.	Frequency (MHz)	Factor (dB)	Reading (dBuV)	Level (dBuV)	Limit (dBuV)	Margin (dB)	Detector	P/F
1	0.15	9.92	19.30	29.22	55.80	-26.58	Average	P
2	0.15	9.92	36.80	46.72	65.80	-19.08	QP	P
3	0.16	9.92	19.93	29.85	55.22	-25.37	Average	P
4	0.16	9.92	35.73	45.65	65.22	-19.57	QP	P
5	0.19	9.92	17.90	27.82	54.11	-26.29	Average	P
6	0.19	9.92	32.70	42.62	64.11	-21.49	QP	P
7	0.20	9.92	17.32	27.24	53.73	-26.49	Average	P
8	0.20	9.92	31.54	41.46	63.73	-22.27	QP	P
9	0.22	9.92	15.72	25.64	52.84	-27.20	Average	P
10	0.22	9.92	28.38	38.30	62.84	-24.54	QP	P
11	0.58	9.91	33.05	42.96	46.00	-3.04	Average	P
12	0.58	9.91	39.34	49.25	56.00	-6.75	QP	P

Note: Level=Reading+Factor  
 Margin=Level-Limit  
 Factor=(LISN or ISN or Current Probe)Factor + Cable Loss



## 6. Test of Radiated Spurious Emission

### 6.1 Test Limit

In any 100kHz bandwidth outside the frequency band in which the spread spectrum or digitally modulated intentional radiator is operating, the radio frequency power that is produced by the intentional radiator shall be at least 20dB below that in the 100kHz bandwidth within the band that contains the highest level of the desired power, based on either an RF conducted or a radiated measurement. If the transmitter measurement is based on the maximum conducted output power, the attenuation required under this paragraph shall be 30dB instead of 20dB. In addition, radiated emissions which fall in section 15.205(a) the restricted bands must also comply with the radiated emission limit specified in section 15.209(a).

Frequency (MHz)	Field Strength (microvolt/meter)	Measurement Distance (meters)
0.009 ~ 0.490	2400/F(kHz)	300
0.490 ~ 1.705	24000/F(kHz)	30
1.705 ~ 30.0	30	30
30 ~ 88	100	3
88 ~ 216	150	3
216 ~ 960	200	3
Above 960	500	3



## 6.2 Test Procedures

- a. The EUT was placed on a rotatable table top 0.8 meter above ground.
- b. The EUT was set 3 meters from the interference receiving antenna which was mounted on the top of a variable height antenna tower.
- c. The table was rotated 360 degrees to determine the position of the highest radiation.
- d. The antenna is a broadband antenna and its height is varied between one meter and four meters above ground to find the maximum value of the field strength both horizontal polarization and vertical polarization of the antenna are set to make the measurement.
- e. For each suspected emission the EUT was arranged to its worst case and then tune the antenna tower (from 1 M to 4 M) and turn table (from 0 degree to 360 degrees) to find the maximum reading.
- f. Set the test-receiver system to Peak or CISPR quasi-peak Detect Function and specified bandwidth with Maximum Hold Mode.
- g. If the emission level of the EUT in peak mode was 3 dB lower than the limit specified, then testing will be stopped and peak values of EUT will be reported, otherwise, the emissions which do not have 3 dB margin will be repeated one by one using the quasi-peak method and reported.
- h. For testing above 1GHz, the emission level of the EUT in peak mode was 20dB lower than average limit (that means the emission level in peak mode also complies with the limit in average mode), then testing will be stopped and peak values of EUT will be reported, otherwise, the emissions will be measured in average mode again and reported.
- i. "Cone of radiation" has been considered to be 3dB bandwidth of the measurement antenna.

Note:

- 1.The supporting fixture shall permit orientation of the EUT in each of three orthogonal axis positions such that emissions from the EUT are maximized.  
(Z-AXIS is the worst.)
- 2.Due to the test software function limit the operation band setting(200dBuV/m).  
There's no corresponding limitation in the actual test item.



### 6.3 Typical Test Setup

Below 30MHz test setup

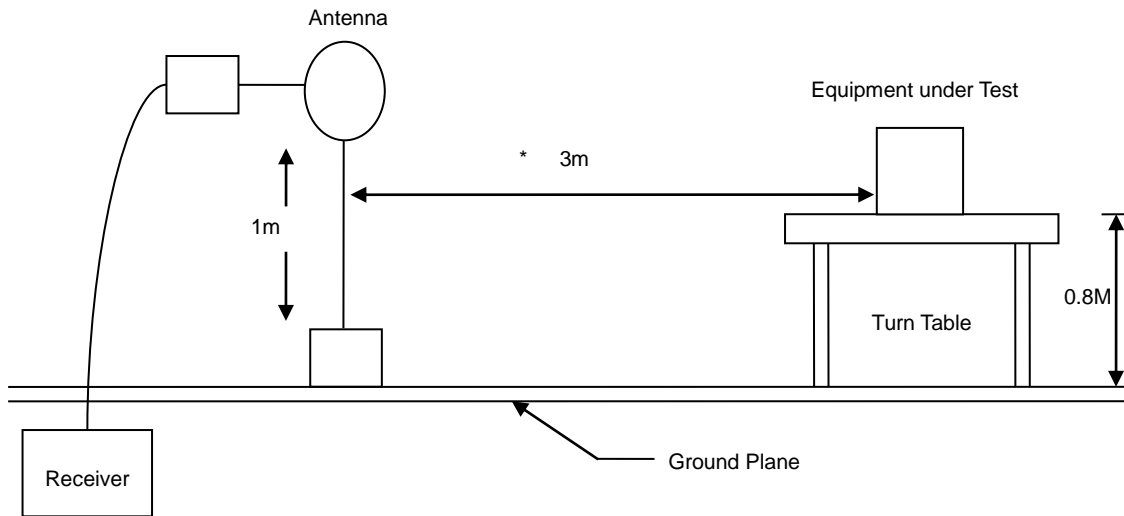

30MHz- 1GHz Test Setup

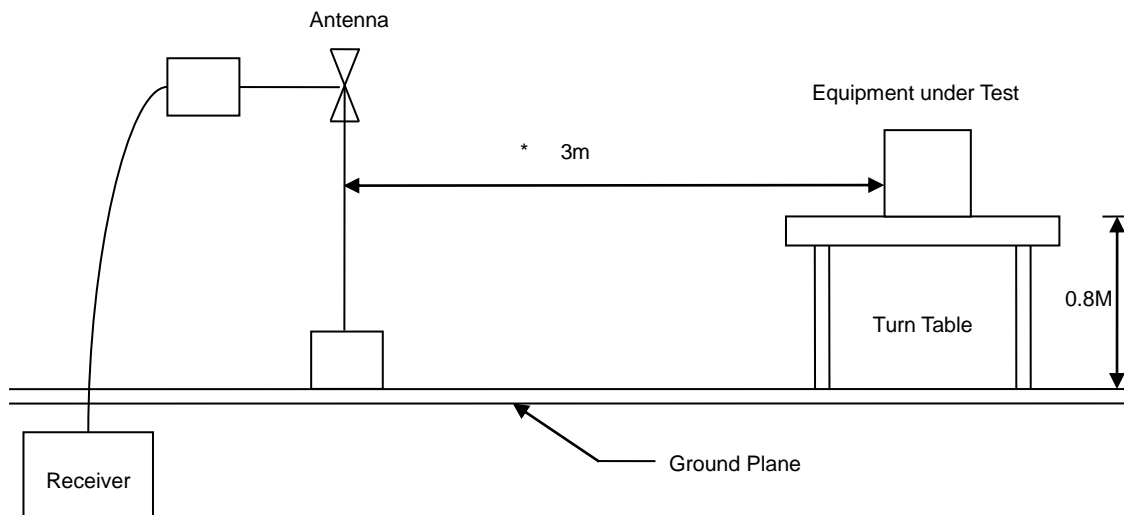

Above 1GHz Test Setup

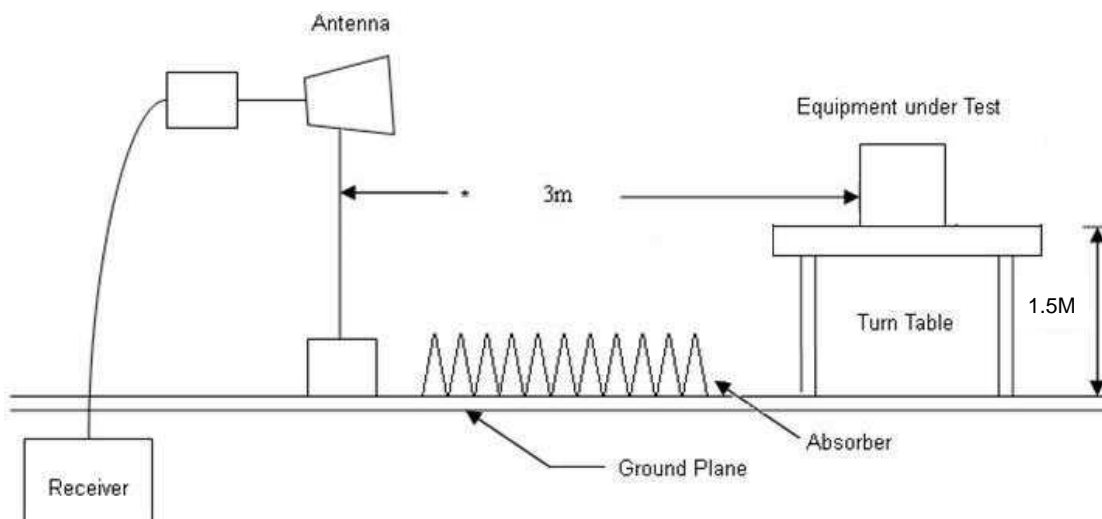



### 6.4 Test Result and Data (9kHz ~ 30MHz)

The 9kHz-30MHz spurious emission is under limit 20dB more.

### 6.5 Test Result and Data (30MHz ~ 1GHz)

Power	: AC 240V / 60Hz	Pol/Phase	: VERTICAL
Test Mode	: Mode 1		:

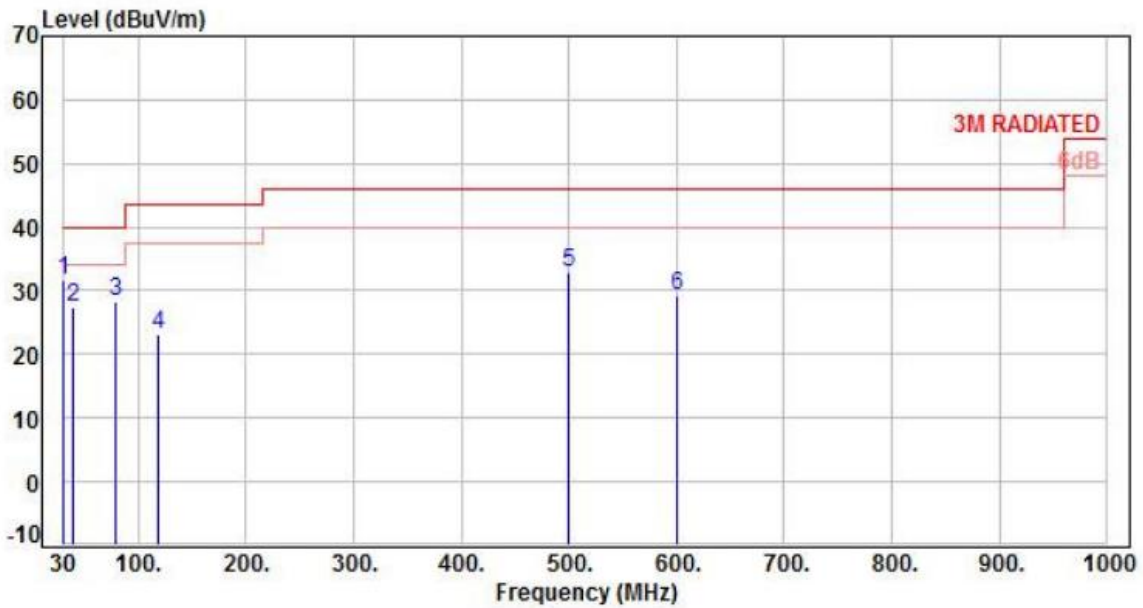

No.	Frequency (MHz)	Factor (dB)	Reading (dBuV)	Level (dBuV/m)	Limit (dBuV/m)	Margin (dB)	Detector	Height (cm)	Azimuth (deg)	P/F
1	30.00	-12.63	44.21	31.58	40.00	-8.42	Peak	400	360	P
2	39.70	-11.86	39.18	27.32	40.00	-12.68	Peak	400	360	P
3	78.50	-15.51	43.81	28.30	40.00	-11.70	Peak	400	360	P
4	119.24	-13.82	36.94	23.12	43.50	-20.38	Peak	400	360	P
5	499.48	-5.46	38.35	32.89	46.00	-13.11	Peak	400	360	P
6	600.36	-2.94	32.21	29.27	46.00	-16.73	Peak	400	360	P

Note: Level=Reading+Factor  
Margin=Level-Limit  
Factor=Antenna Factor + cable loss - Amplifier Factor



Power	: AC 240V / 60Hz	Pol/Phase	: HORIZONTAL
Test Mode	: Mode 1		:

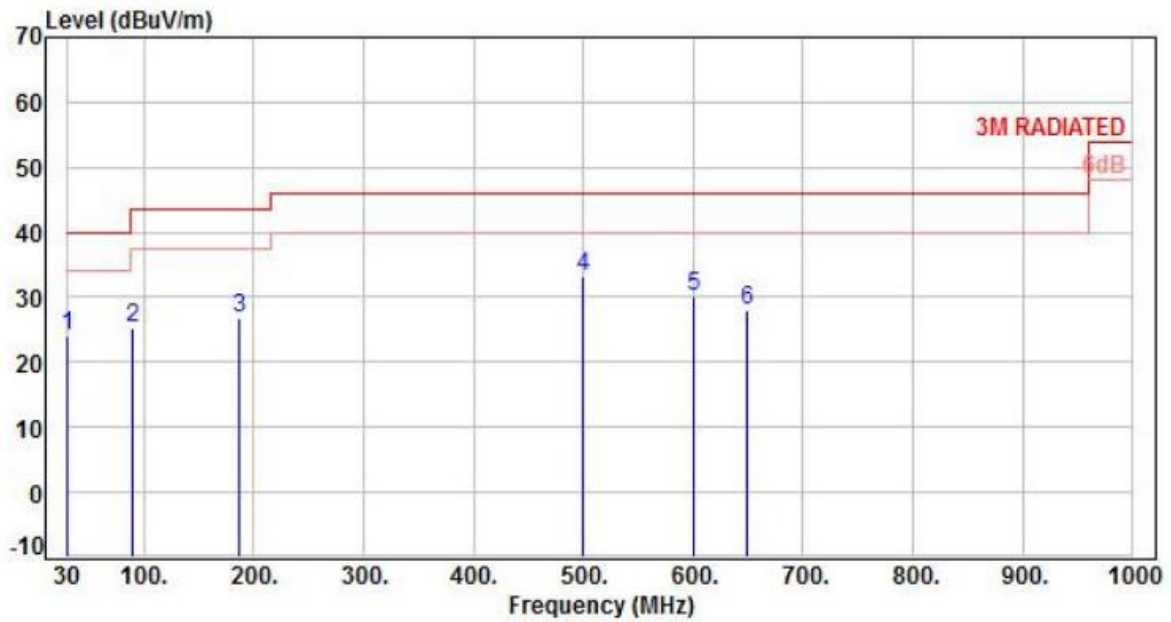

No.	Frequency (MHz)	Factor (dB)	Reading (dBUV)	Level (dBUV/m)	Limit (dBUV/m)	Margin (dB)	Detector	Height (cm)	Azimuth (deg)	P/F
1	30.00	-12.63	36.72	24.09	40.00	-15.91	Peak	400	0	P
2	90.14	-16.64	41.96	25.32	43.50	-18.18	Peak	400	0	P
3	187.14	-13.30	40.06	26.76	43.50	-16.74	Peak	400	0	P
4	499.48	-5.46	38.71	33.25	46.00	-12.75	Peak	400	0	P
5	600.36	-2.94	33.17	30.23	46.00	-15.77	Peak	400	0	P
6	648.86	-2.16	30.15	27.99	46.00	-18.01	Peak	400	0	P

Note: Level=Reading+Factor  
 Margin=Level-Limit  
 Factor=Antenna Factor + cable loss - Amplifier Factor



### 6.6 Test Result and Data (1GHz ~ 25GHz)

Power	: AC 120V / 60Hz	Pol/Phase	: VERTICAL
Test Mode	: Mode 1, CH00		:

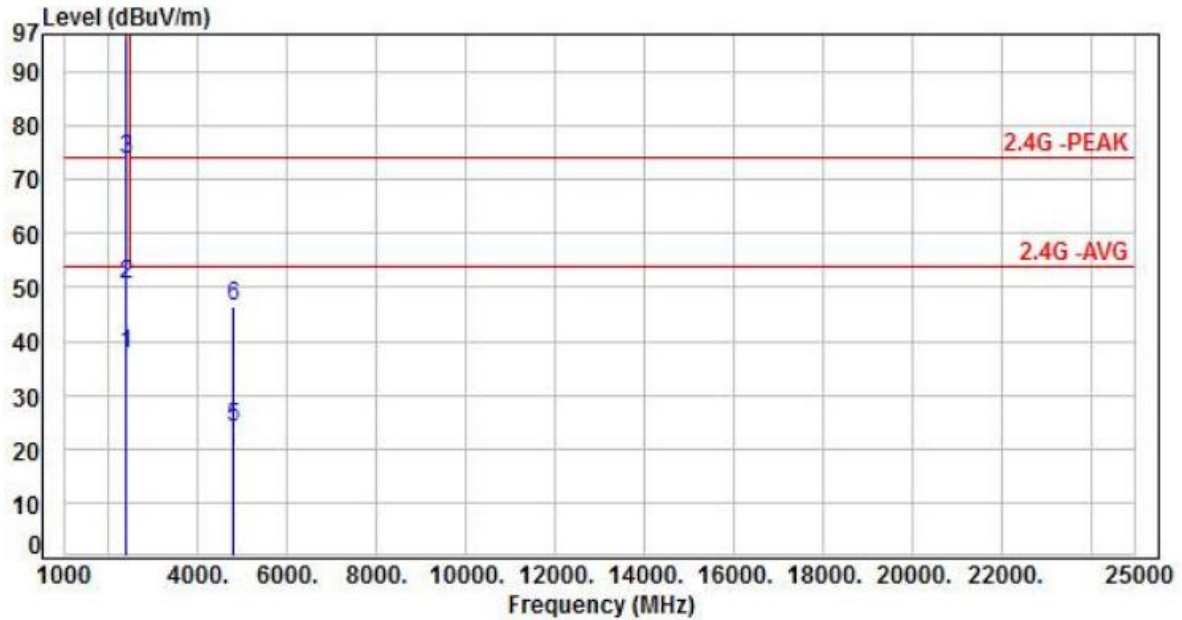

No.	Frequency (MHz)	Factor (dB)	Reading (dBuV)	Level (dBuV/m)	Limit (dBuV/m)	Margin (dB)	Detector	Height (cm)	Azimuth (deg)	P/F
1	2390.00	-3.54	41.24	37.70	54.00	-16.30	Average	246	204	P
2	2390.00	-3.54	54.11	50.57	74.00	-23.43	Peak	246	204	P
3	2402.00	-3.51	77.21	73.70	200.00	-126.30	Average	246	204	P
4	2402.00	-3.51	99.71	96.20	200.00	-103.80	Peak	246	204	P
5	4804.00	3.76	20.08	23.84	54.00	-30.16	Average	100	74	P
6	4804.00	3.76	42.58	46.34	74.00	-27.66	Peak	100	74	P

Note: Level=Reading+Factor  
Margin=Level-Limit  
Factor=Antenna Factor + cable loss - Amplifier Factor



Power	: AC 120V / 60Hz	Pol/Phase	: HORIZONTAL
Test Mode	: Mode 1, CH00		:

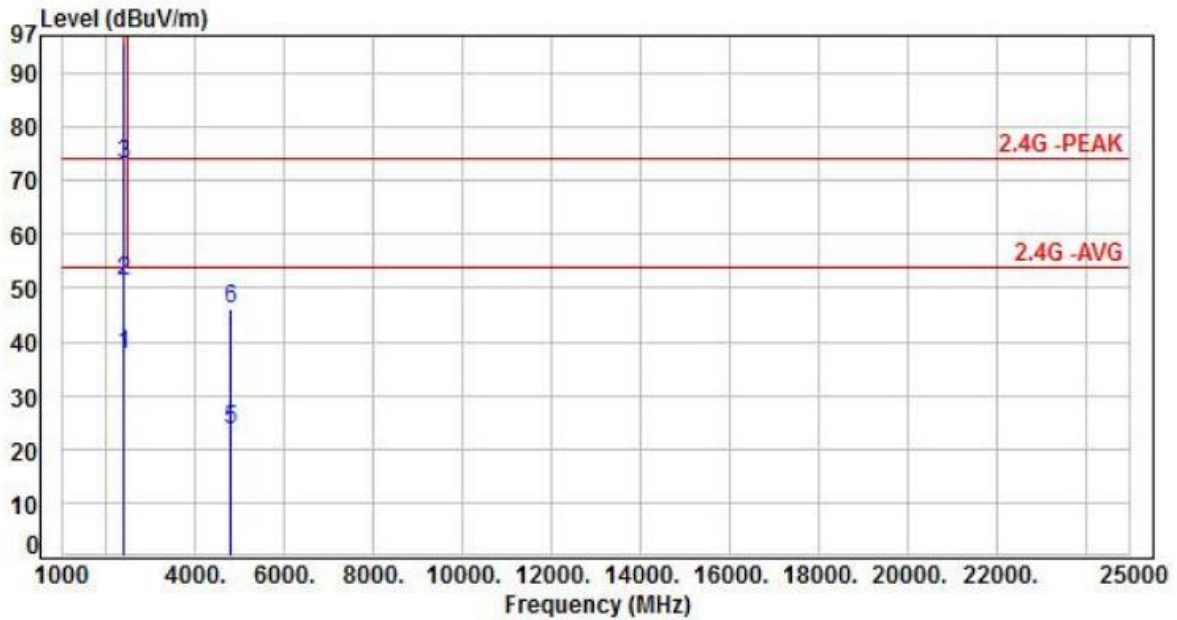

No.	Frequency (MHz)	Factor (dB)	Reading (dBuV)	Level (dBuV/m)	Limit (dBuV/m)	Margin (dB)	Detector	Height (cm)	Azimuth (deg)	P/F
1	2390.00	-3.54	41.21	37.67	54.00	-16.33	Average	162	153	P
2	2390.00	-3.54	54.78	51.24	74.00	-22.76	Peak	162	153	P
3	2402.00	-3.51	76.68	73.17	200.00	-126.83	Average	162	153	P
4	2402.00	-3.51	99.18	95.67	200.00	-104.33	Peak	162	153	P
5	4804.00	3.76	19.87	23.63	54.00	-30.37	Average	100	148	P
6	4804.00	3.76	42.37	46.13	74.00	-27.87	Peak	100	148	P

Note: Level=Reading+Factor  
 Margin=Level-Limit  
 Factor=Antenna Factor + cable loss - Amplifier Factor





Power	: AC 120V / 60Hz	Pol/Phase	: VERTICAL
Test Mode	: Mode 1, CH39		:

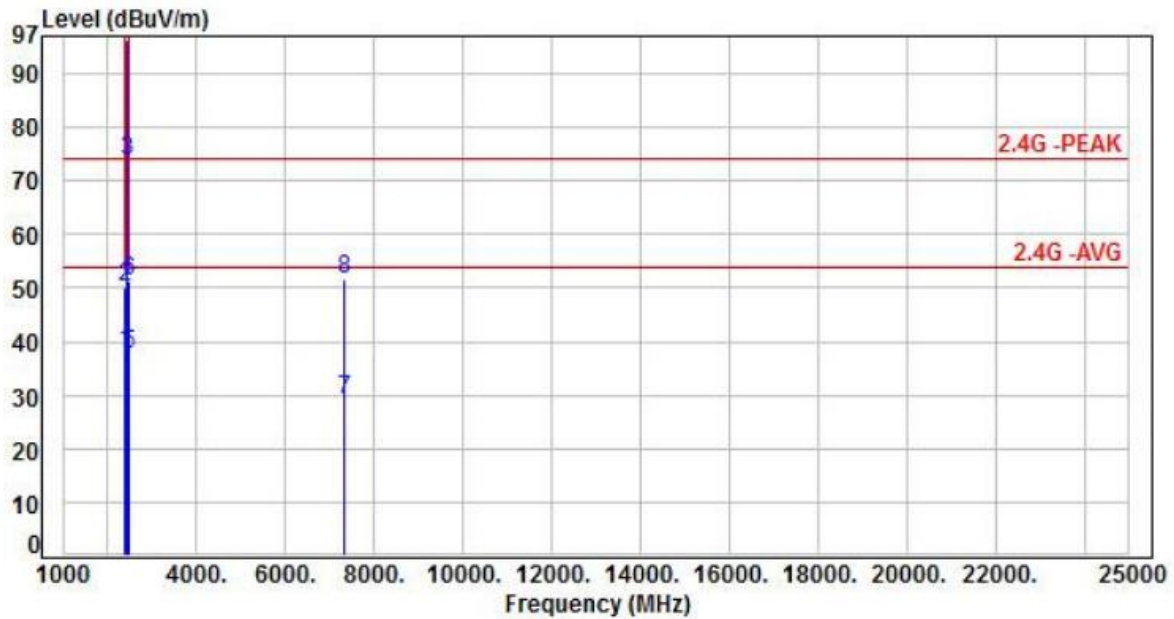

No.	Frequency (MHz)	Factor (dB)	Reading (dBuV)	Level (dBuV/m)	Limit (dBuV/m)	Margin (dB)	Detector	Height (cm)	Azimuth (deg)	P/F
1	2390.00	-3.54	41.63	38.09	54.00	-15.91	Average	135	142	P
2	2390.00	-3.54	53.82	50.28	74.00	-23.72	Peak	135	142	P
3	2441.00	-3.47	77.41	73.94	200.00	-126.06	Average	135	142	P
4	2441.00	-3.47	99.91	96.44	200.00	-103.56	Peak	135	142	P
5	2483.50	-3.30	40.99	37.69	54.00	-16.31	Average	135	142	P
6	2483.50	-3.30	54.61	51.31	74.00	-22.69	Peak	135	142	P
7	7323.00	8.62	20.42	29.04	54.00	-24.96	Average	100	176	P
8	7323.00	8.62	42.92	51.54	74.00	-22.46	Peak	100	176	P

Note: Level=Reading+Factor  
 Margin=Level-Limit  
 Factor=Antenna Factor + cable loss - Amplifier Factor



Power	: AC 120V / 60Hz	Pol/Phase	: HORIZONTAL
Test Mode	: Mode 1, CH39		:

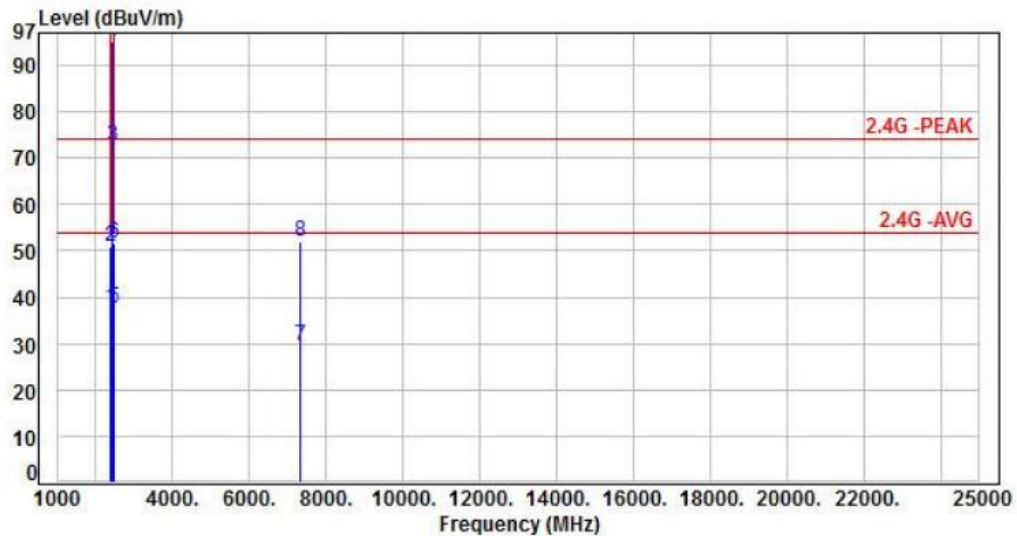

No.	Frequency (MHz)	Factor (dB)	Reading (dBuV)	Level (dBuV/m)	Limit (dBuV/m)	Margin (dB)	Detector	Height (cm)	Azimuth (deg)	P/F
1	2390.00	-3.54	41.12	37.58	54.00	-16.42	Average	106	211	P
2	2390.00	-3.54	54.44	50.90	74.00	-23.10	Peak	106	211	P
3	2441.00	-3.47	75.97	72.50	200.00	-127.50	Average	106	211	P
4	2441.00	-3.47	98.47	95.00	200.00	-105.00	Peak	106	211	P
5	2483.50	-3.30	41.04	37.74	54.00	-16.26	Average	106	211	P
6	2483.50	-3.30	55.00	51.70	74.00	-22.30	Peak	106	211	P
7	7323.00	8.62	20.90	29.52	54.00	-24.48	Average	100	115	P
8	7323.00	8.62	43.40	52.02	74.00	-21.98	Peak	100	115	P

Note: Level=Reading+Factor  
 Margin=Level-Limit  
 Factor=Antenna Factor + cable loss - Amplifier Factor



Power	: AC 120V / 60Hz	Pol/Phase	: VERTICAL
Test Mode	: Mode 1, CH78		:

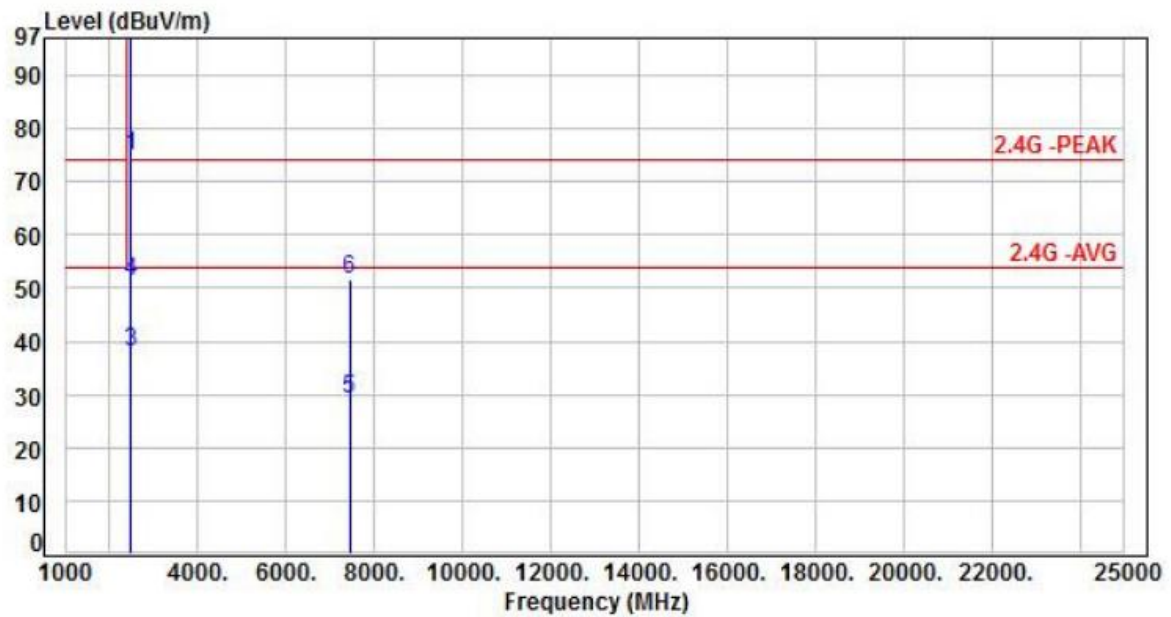

No.	Frequency (MHz)	Factor (dB)	Reading (dBuV)	Level (dBuV/m)	Limit (dBuV/m)	Margin (dB)	Detector	Height (cm)	Azimuth (deg)	P/F
1	2480.00	-3.31	78.02	74.71	200.00	-125.29	Average	100	142	P
2	2480.00	-3.31	100.52	97.21	200.00	-102.79	Peak	100	142	P
3	2483.50	-3.30	41.16	37.86	54.00	-16.14	Average	100	142	P
4	2483.50	-3.30	54.40	51.10	74.00	-22.90	Peak	100	142	P
5	7440.00	8.79	20.35	29.14	54.00	-24.86	Average	100	179	P
6	7440.00	8.79	42.85	51.64	74.00	-22.36	Peak	100	179	P

Note: Level=Reading+Factor  
Margin=Level-Limit  
Factor=Antenna Factor + cable loss - Amplifier Factor



Power	: AC 120V / 60Hz	Pol/Phase	: HORIZONTAL
Test Mode	: Mode 1, CH78		:

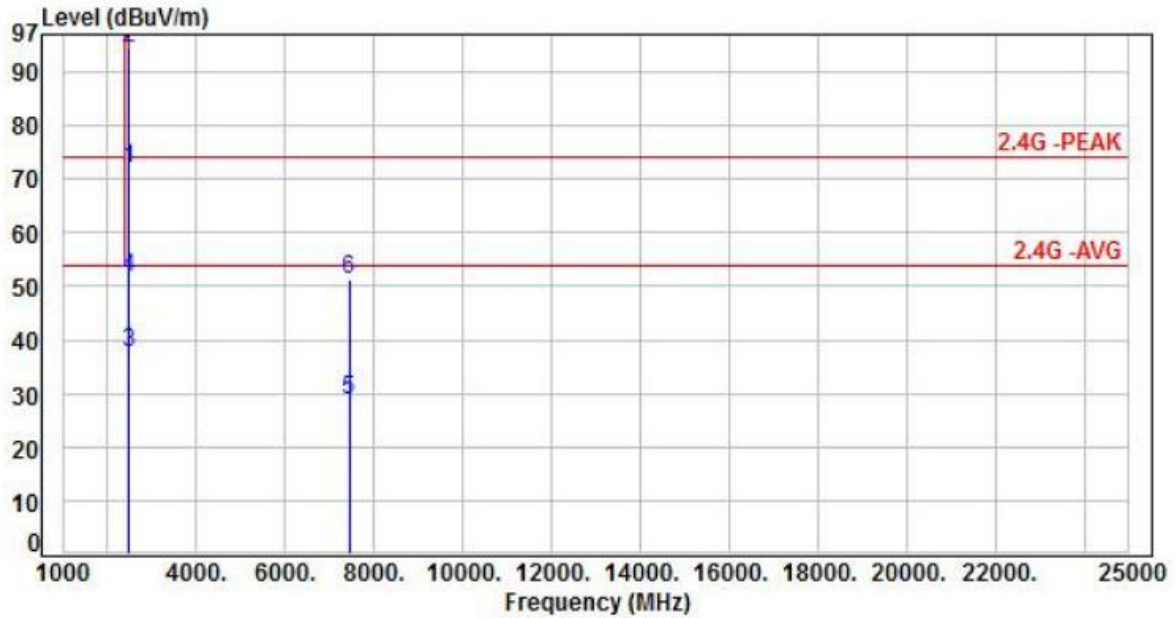

No.	Frequency (MHz)	Factor (dB)	Reading (dBuV)	Level (dBuV/m)	Limit (dBuV/m)	Margin (dB)	Detector	Height (cm)	Azimuth (deg)	P/F
1	2480.00	-3.31	75.37	72.06	200.00	-127.94	Average	125	214	P
2	2480.00	-3.31	97.87	94.56	200.00	-105.44	Peak	125	214	P
3	2483.50	-3.30	41.04	37.74	54.00	-16.26	Average	125	214	P
4	2483.50	-3.30	54.88	51.58	74.00	-22.42	Peak	125	214	P
5	7440.00	8.79	19.85	28.64	54.00	-25.36	Average	100	111	P
6	7440.00	8.79	42.35	51.14	74.00	-22.86	Peak	100	111	P

Note: Level=Reading+Factor  
 Margin=Level-Limit  
 Factor=Antenna Factor + cable loss - Amplifier Factor



Power	: AC 120V / 60Hz	Pol/Phase	: VERTICAL
Test Mode	: Mode 2, CH00		:

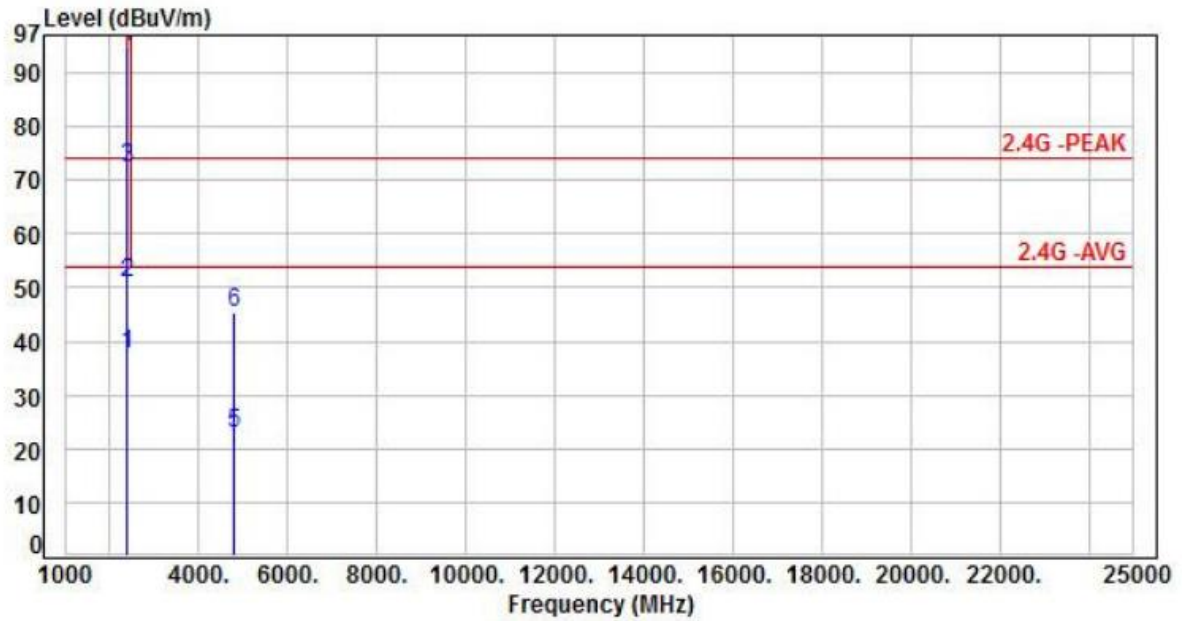

No.	Frequency (MHz)	Factor (dB)	Reading (dBuV)	Level (dBuV/m)	Limit (dBuV/m)	Margin (dB)	Detector	Height (cm)	Azimuth (deg)	P/F
1	2390.00	-3.54	41.34	37.80	54.00	-16.20	Average	111	140	P
2	2390.00	-3.54	54.42	50.88	74.00	-23.12	Peak	111	140	P
3	2402.00	-3.51	75.98	72.47	200.00	-127.53	Average	111	140	P
4	2402.00	-3.51	98.48	94.97	200.00	-105.03	Peak	111	140	P
5	4804.00	3.76	19.24	23.00	54.00	-31.00	Average	100	76	P
6	4804.00	3.76	41.74	45.50	74.00	-28.50	Peak	100	76	P

Note: Level=Reading+Factor  
 Margin=Level-Limit  
 Factor=Antenna Factor + cable loss - Amplifier Factor



Power	: AC 120V / 60Hz	Pol/Phase	: HORIZONTAL
Test Mode	: Mode 2, CH00		:

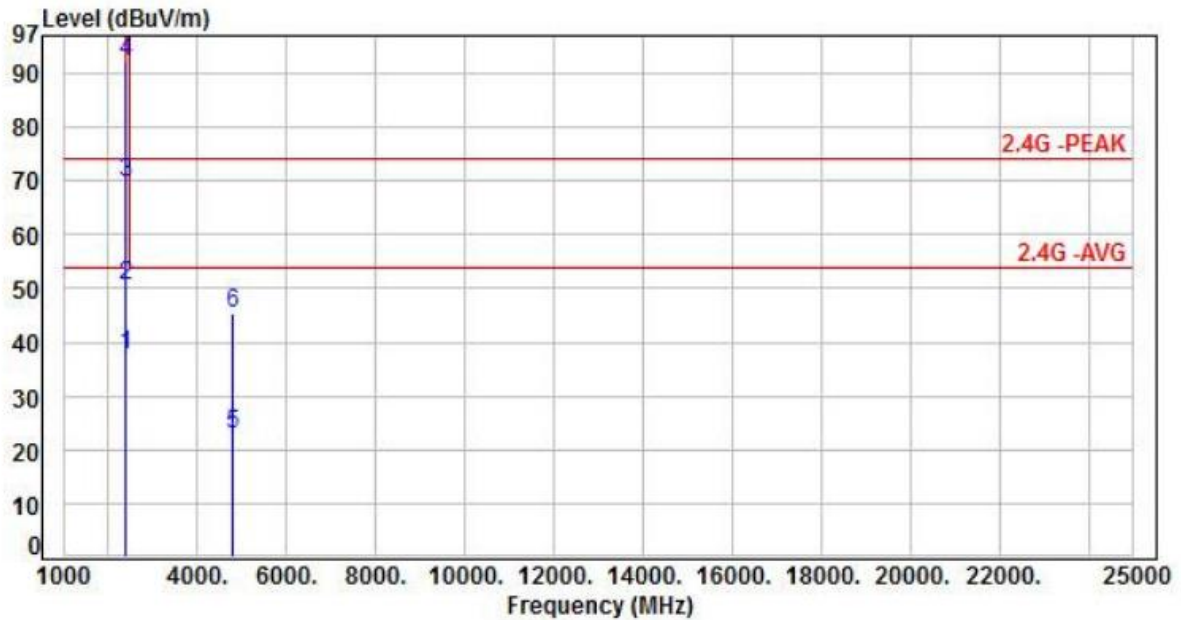

No.	Frequency (MHz)	Factor (dB)	Reading (dBuV)	Level (dBuV/m)	Limit (dBuV/m)	Margin (dB)	Detector	Height (cm)	Azimuth (deg)	P/F
1	2390.00	-3.54	41.10	37.56	54.00	-16.44	Average	107	214	P
2	2390.00	-3.54	54.19	50.65	74.00	-23.35	Peak	107	214	P
3	2402.00	-3.51	73.16	69.65	200.00	-130.35	Average	107	214	P
4	2402.00	-3.51	95.66	92.15	200.00	-107.85	Peak	107	214	P
5	4804.00	3.76	19.03	22.79	54.00	-31.21	Average	100	144	P
6	4804.00	3.76	41.53	45.29	74.00	-28.71	Peak	100	144	P

Note: Level=Reading+Factor  
 Margin=Level-Limit  
 Factor=Antenna Factor + cable loss - Amplifier Factor



Power	: AC 120V / 60Hz	Pol/Phase	: VERTICAL
Test Mode	: Mode 2, CH39		:

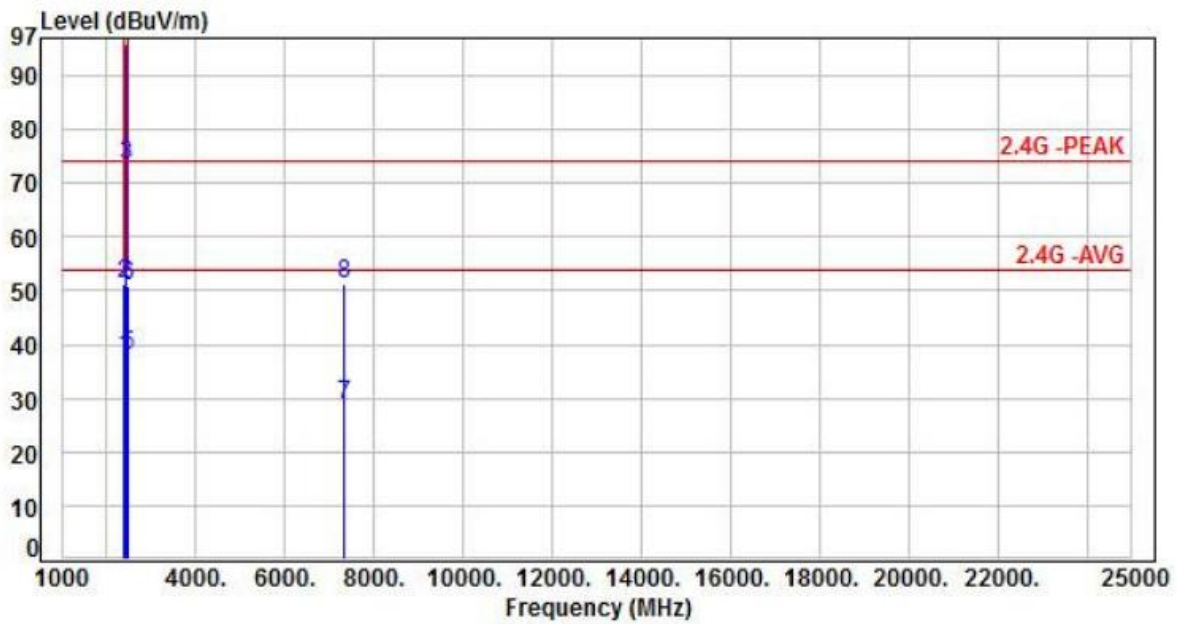

No.	Frequency (MHz)	Factor (dB)	Reading (dBUV)	Level (dBUV/m)	Limit (dBUV/m)	Margin (dB)	Detector	Height (cm)	Azimuth (deg)	P/F
1	2390.00	-3.54	40.98	37.44	54.00	-16.56	Average	113	142	P
2	2390.00	-3.54	54.67	51.13	74.00	-22.87	Peak	113	142	P
3	2441.00	-3.47	77.00	73.53	200.00	-126.47	Average	113	142	P
4	2441.00	-3.47	99.50	96.03	200.00	-103.97	Peak	113	142	P
5	2483.50	-3.30	41.11	37.81	54.00	-16.19	Average	113	142	P
6	2483.50	-3.30	54.20	50.90	74.00	-23.10	Peak	113	142	P
7	7323.00	8.62	20.16	28.78	54.00	-25.22	Average	100	194	P
8	7323.00	8.62	42.66	51.28	74.00	-22.72	Peak	100	194	P

Note: Level=Reading+Factor  
 Margin=Level-Limit  
 Factor=Antenna Factor + cable loss - Amplifier Factor



Power	: AC 120V / 60Hz	Pol/Phase	: HORIZONTAL
Test Mode	: Mode 2, CH39		:

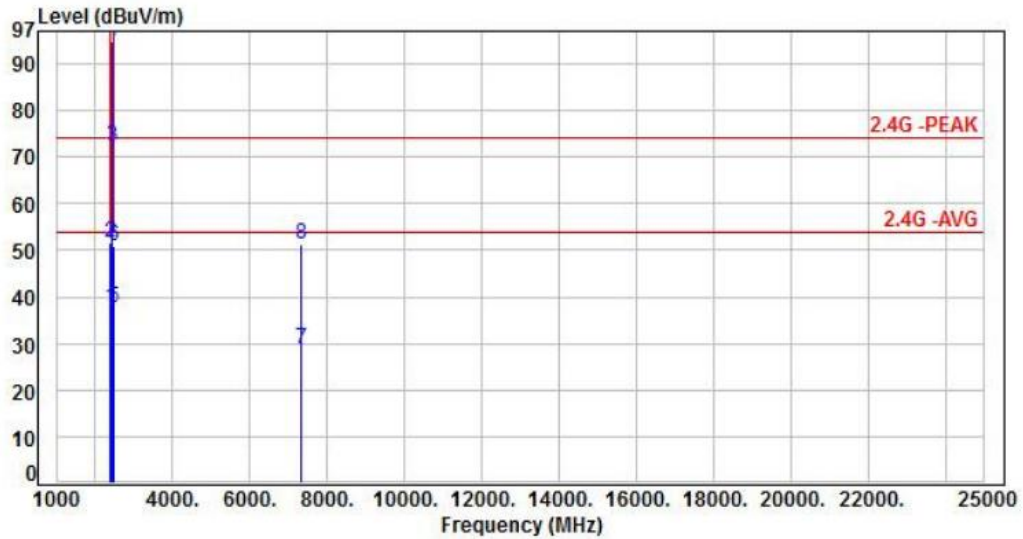

No.	Frequency (MHz)	Factor (dB)	Reading (dBuV)	Level (dBuV/m)	Limit (dBuV/m)	Margin (dB)	Detector	Height (cm)	Azimuth (deg)	P/F
1	2390.00	-3.54	41.22	37.68	54.00	-16.32	Average	107	213	P
2	2390.00	-3.54	55.31	51.77	74.00	-22.23	Peak	107	213	P
3	2441.00	-3.47	75.80	72.33	200.00	-127.67	Average	107	213	P
4	2441.00	-3.47	98.30	94.83	200.00	-105.17	Peak	107	213	P
5	2483.50	-3.30	41.03	37.73	54.00	-16.27	Average	107	213	P
6	2483.50	-3.30	54.25	50.95	74.00	-23.05	Peak	107	213	P
7	7323.00	8.62	20.26	28.88	54.00	-25.12	Average	100	114	P
8	7323.00	8.62	42.76	51.38	74.00	-22.62	Peak	100	114	P

Note: Level=Reading+Factor  
 Margin=Level-Limit  
 Factor=Antenna Factor + cable loss - Amplifier Factor





Power	: AC 120V / 60Hz	Pol/Phase	: VERTICAL
Test Mode	: Mode 2, CH78		:

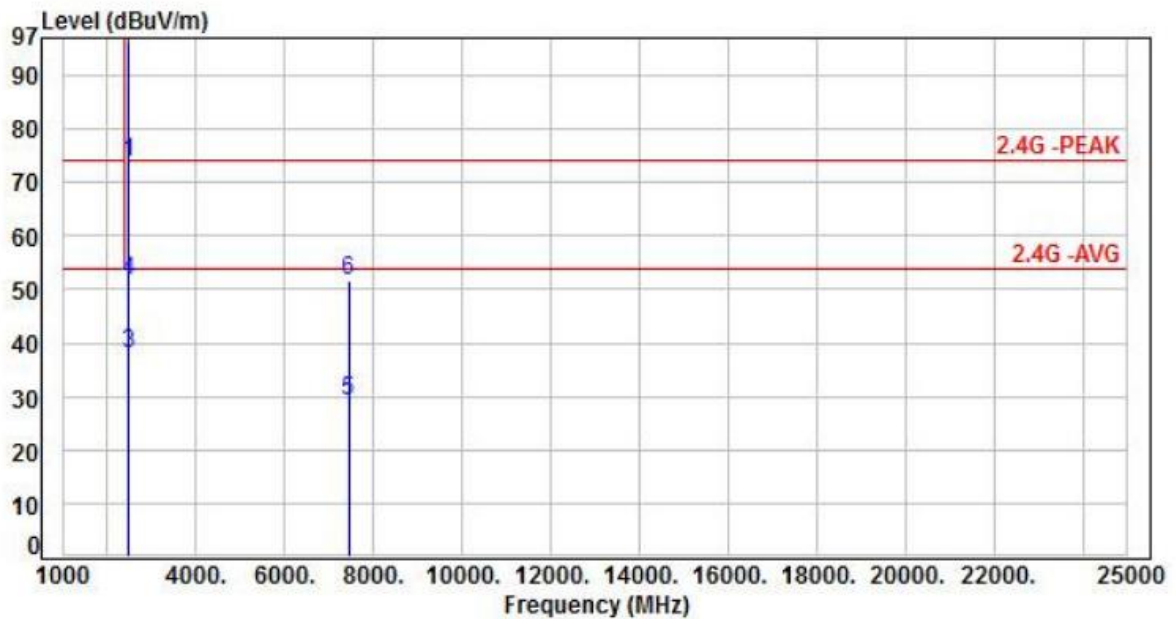

No.	Frequency (MHz)	Factor (dB)	Reading (dBuV)	Level (dBuV/m)	Limit (dBuV/m)	Margin (dB)	Detector	Height (cm)	Azimuth (deg)	P/F
1	2480.00	-3.31	77.01	73.70	200.00	-126.30	Average	139	144	P
2	2480.00	-3.31	99.51	96.20	200.00	-103.80	Peak	139	144	P
3	2483.50	-3.30	41.47	38.17	54.00	-15.83	Average	139	144	P
4	2483.50	-3.30	54.94	51.64	74.00	-22.36	Peak	139	144	P
5	7440.00	8.79	20.41	29.20	54.00	-24.80	Average	100	182	P
6	7440.00	8.79	42.91	51.70	74.00	-22.30	Peak	100	182	P

Note: Level=Reading+Factor  
Margin=Level-Limit  
Factor=Antenna Factor + cable loss - Amplifier Factor



Power	: AC 120V / 60Hz	Pol/Phase	: HORIZONTAL
Test Mode	: Mode 2, CH78		:

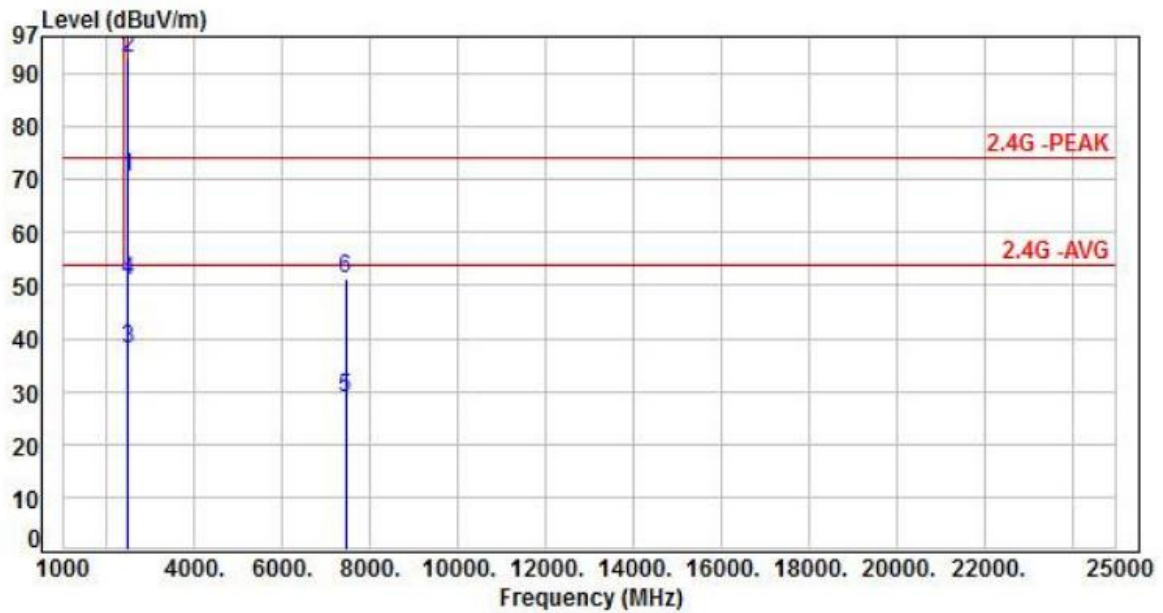

No.	Frequency (MHz)	Factor (dB)	Reading (dBuV)	Level (dBuV/m)	Limit (dBuV/m)	Margin (dB)	Detector	Height (cm)	Azimuth (deg)	P/F
1	2480.00	-3.31	73.65	70.34	200.00	-129.66	Average	134	154	P
2	2480.00	-3.31	96.15	92.84	200.00	-107.16	Peak	134	154	P
3	2483.50	-3.30	41.12	37.82	54.00	-16.18	Average	134	154	P
4	2483.50	-3.30	54.12	50.82	74.00	-23.18	Peak	134	154	P
5	7440.00	8.79	20.13	28.92	54.00	-25.08	Average	100	109	P
6	7440.00	8.79	42.63	51.42	74.00	-22.58	Peak	100	109	P

Note: Level=Reading+Factor  
 Margin=Level-Limit  
 Factor=Antenna Factor + cable loss - Amplifier Factor



### 6.7 Restricted Bands of Operation

Only spurious emissions are permitted in any of the frequency bands listed below:

MHz	MHz	MHz	GHz
0.09000 – 0.11000	16.42000 – 16.42300	399.9 – 410.0	4.500 – 5.250
0.49500 – 0.505**	16.69475 – 16.69525	608.0 – 614.0	5.350 – 5.460
2.17350 – 2.19050	16.80425 – 16.80475	960.0 – 1240.0	7.250 – 7.750
4.12500 – 4.12800	25.50000 – 25.67000	1300.0 – 1427.0	8.025 – 8.500
4.17725 – 4.17775	37.50000 – 38.25000	1435.0 – 1626.5	9.000 – 9.200
4.20725 – 4.20775	73.00000 – 74.60000	1645.5 – 1646.5	9.300 – 9.500
6.21500 – 6.21800	74.80000 – 75.20000	1660.0 – 1710.0	10.600 – 12.700
6.26775 – 6.26825	108.00000 – 121.94000	1718.8 – 1722.2	13.250 – 13.400
6.31175 – 6.31225	123.00000 – 138.00000	2200.0 – 2300.0	14.470 – 14.500
8.29100 – 8.29400	149.90000 – 150.05000	2310.0 – 2390.0	15.350 – 16.200
8.36200 – 8.36600	156.52475 – 156.52525	2483.5 – 2500.0	17.700 – 21.400
8.37625 – 8.38675	156.70000 – 156.90000	2655.0 – 2900.0	22.010 – 23.120
8.41425 – 8.41475	162.01250 – 167.17000	3260.0 – 3267.0	23.600 – 24.000
12.29000 – 12.29300	167.72000 – 173.20000	3332.0 – 3339.0	31.200 – 31.800
12.51975 – 12.52025	240.00000 – 285.00000	3345.8 – 3358.0	36.430 – 36.500
12.57675 – 12.57725	322.00000 – 335.40000	3600.0 – 4400.0	Above 38.6
13.36000 – 13.41000			

\*\* : Until February 1, 1999, this restricted band shall be 0.490-0.510 MHz



## 7. Test of Conducted Spurious Emission

### 7.1 Test Limit

According to the methods defined in ANSI C63.10-2013 Section 7.8.8  
Below -30dB of the highest emission level of operating band (in 100kHz Resolution Bandwidth).

### 7.2 Test Procedure

- According to the methods defined in ANSI C63.10-2013
- The transmitter output was connected to the spectrum analyzer via a low loss cable.
  - Set RBW of spectrum analyzer to 100 KHz and VBW of spectrum analyzer to 300 KHz with convenient frequency span including 100 KHz bandwidth from band edge.
  - The band edges was measured and recorded.

### 7.3 Test Setup Layout

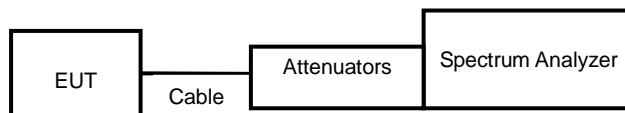

### 7.4 Test Result and Data

Note: Test plots refer to the following pages.



Modulation Type: GFSK (1Mbps)  
Channel: 00

Modulation Type: GFSK (1Mbps)  
Channel: 39

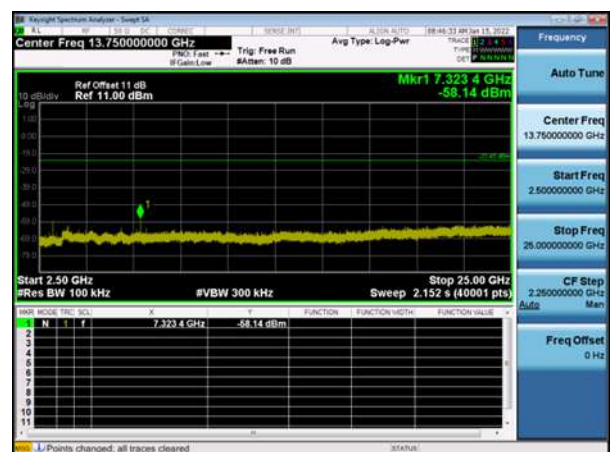
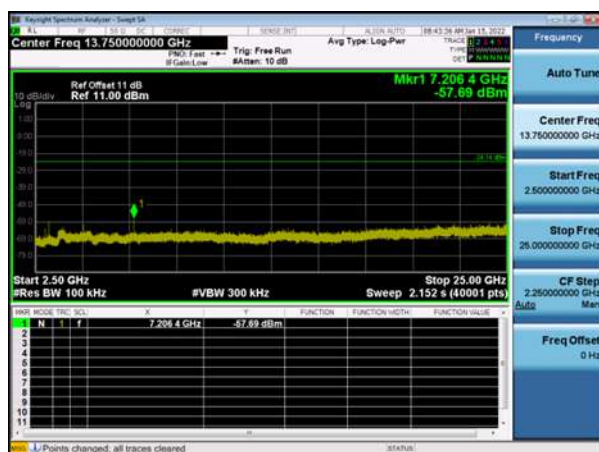
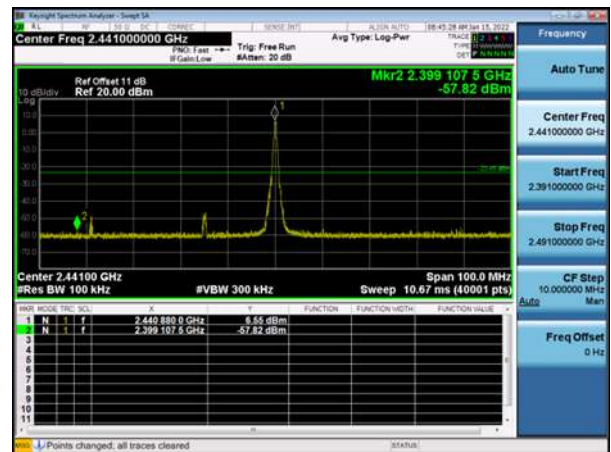
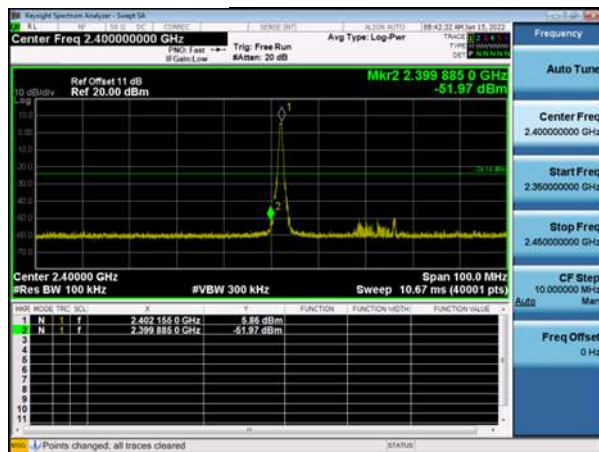
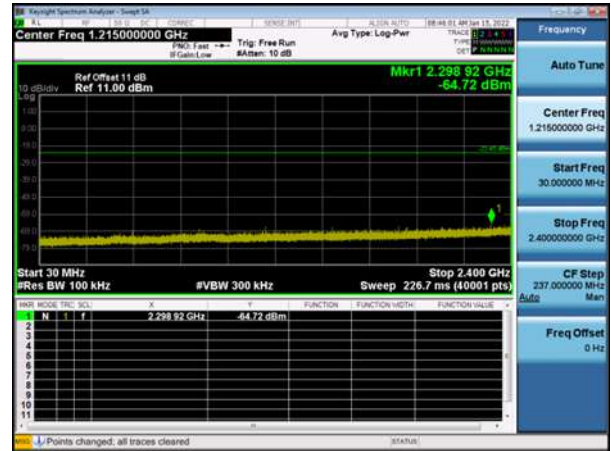
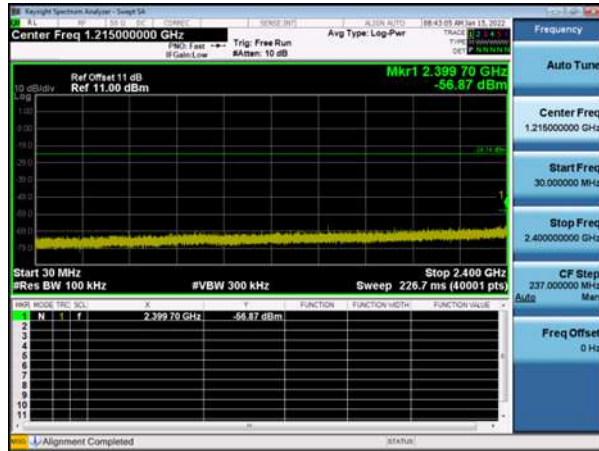



Modulation Type: GFSK (1Mbps)  
Channel: 78

Modulation Type:  $\pi/4$ -DQPSK (2Mbps)  
Channel: 00

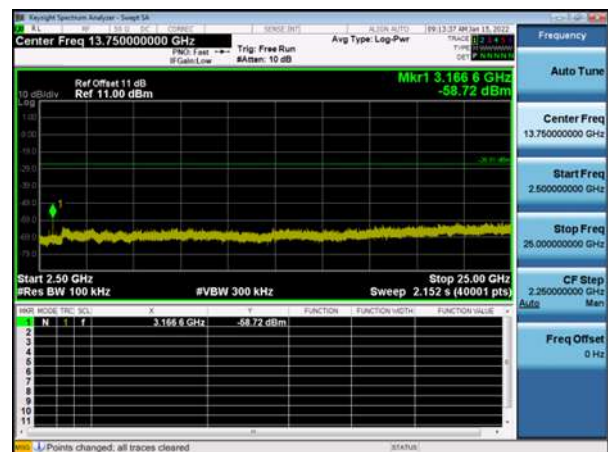
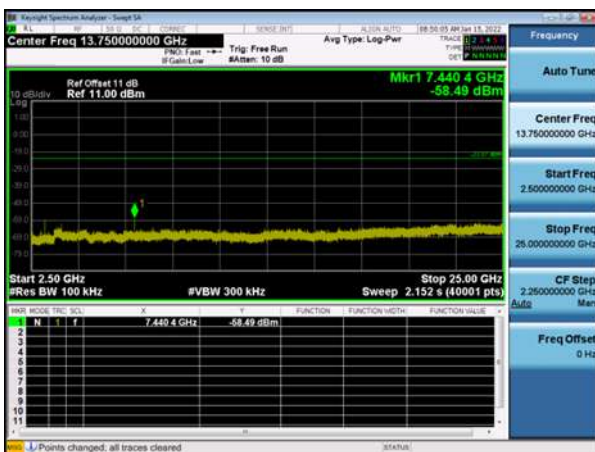
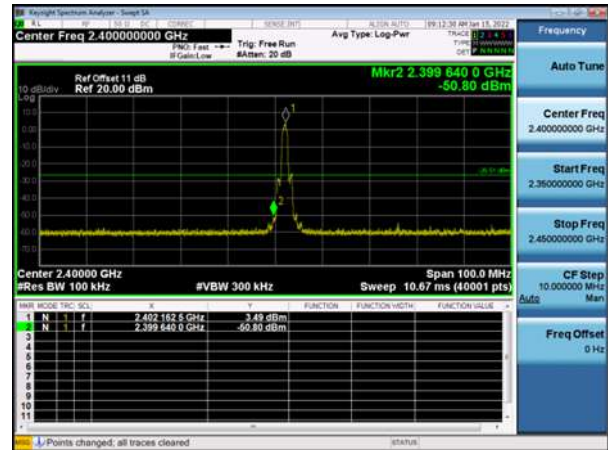
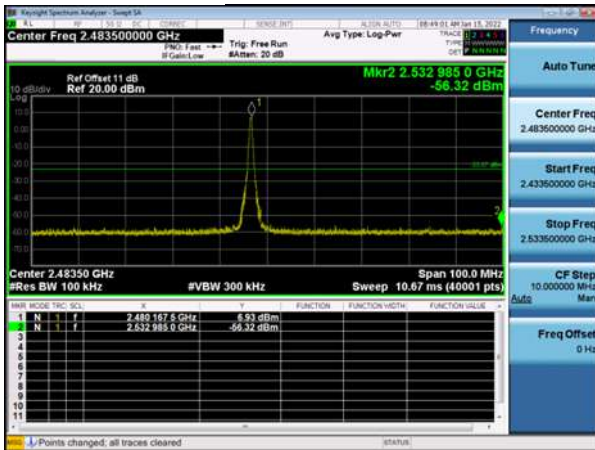
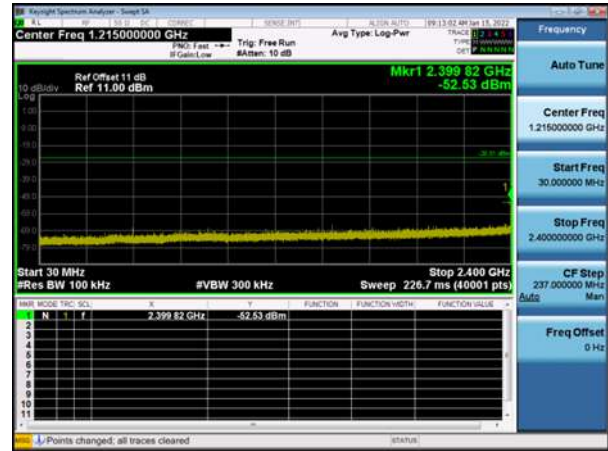
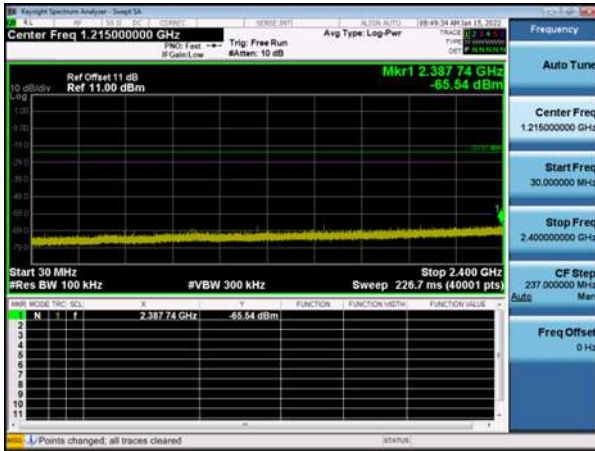



Modulation Type:  $\pi/4$ -DQPSK (2Mbps)  
Channel: 39

Modulation Type:  $\pi/4$ -DQPSK (2Mbps)  
Channel: 78

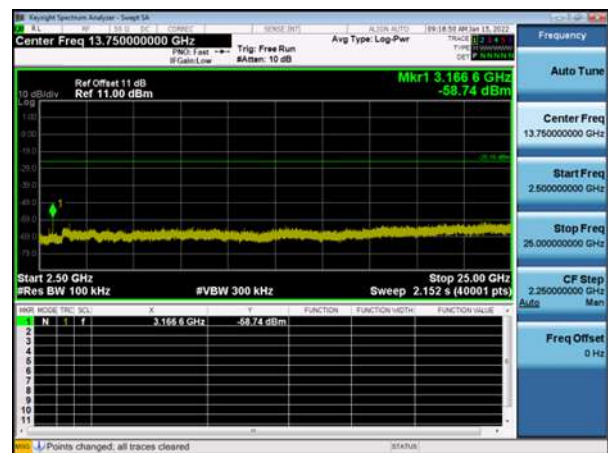
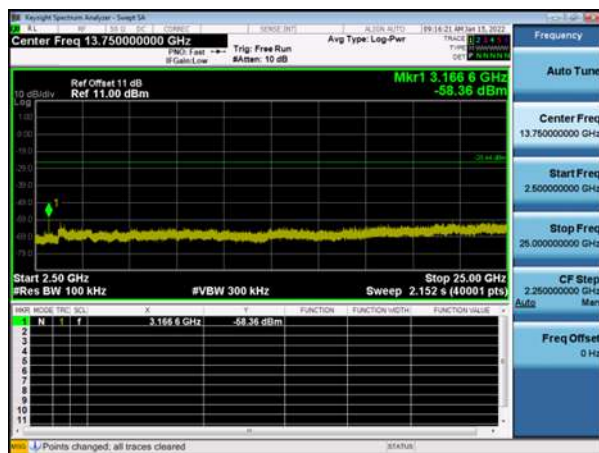
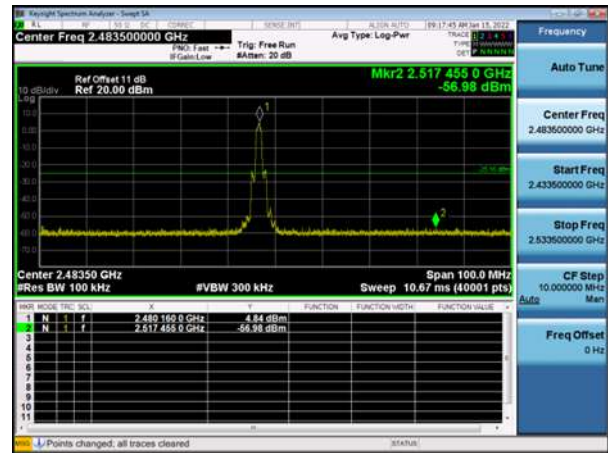
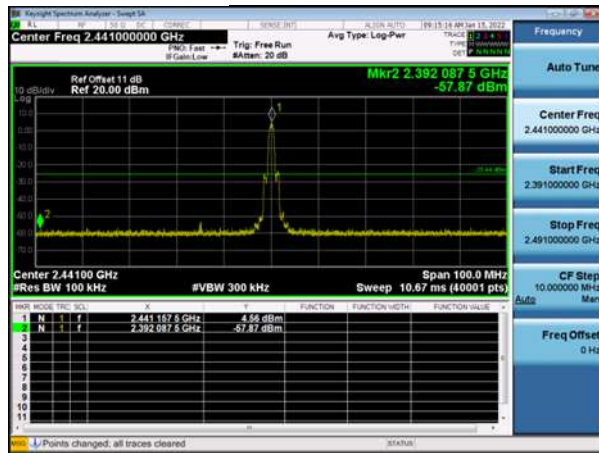
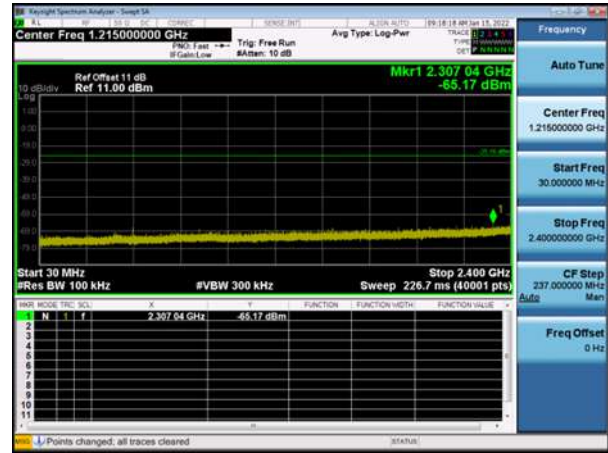
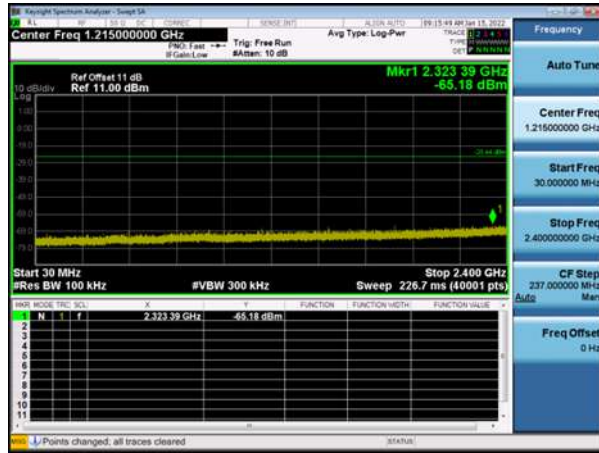



Modulation Type: 8DPSK (3Mbps)  
Channel: 00

Modulation Type: 8DPSK (3Mbps)  
Channel: 39

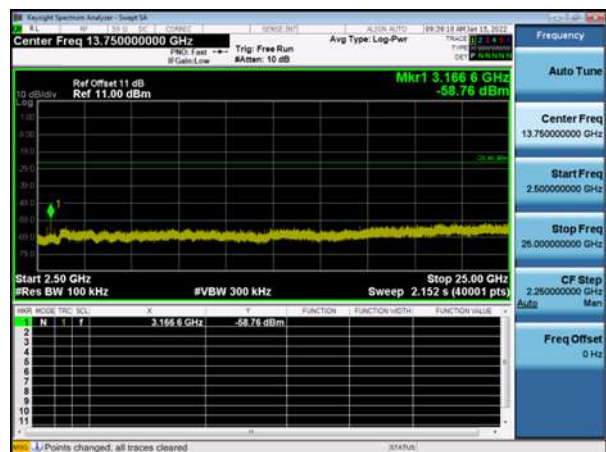
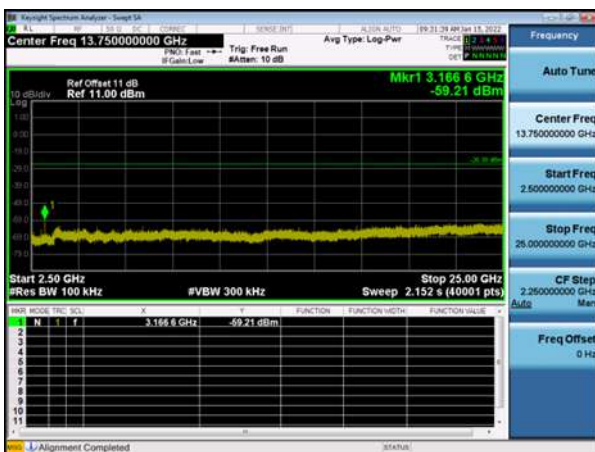
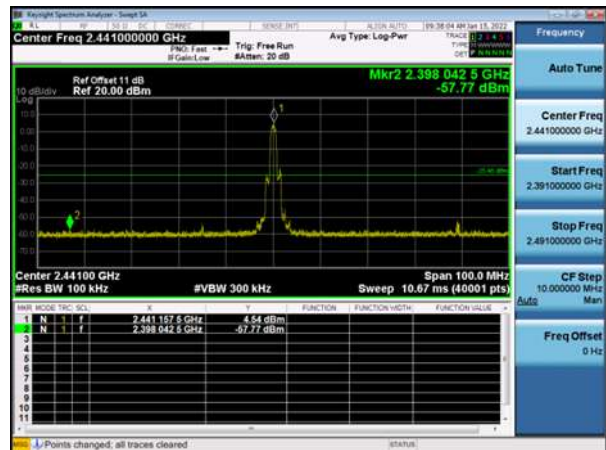
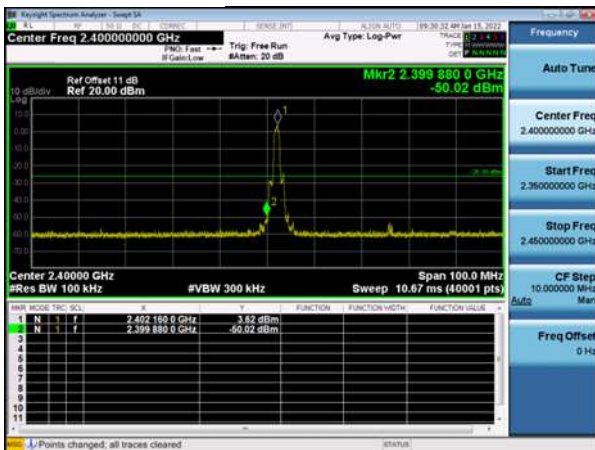
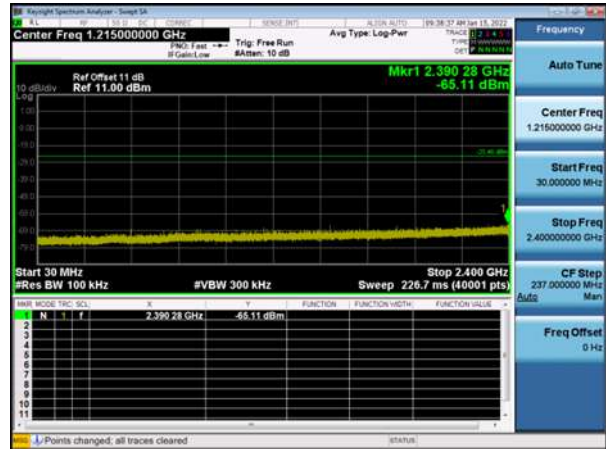
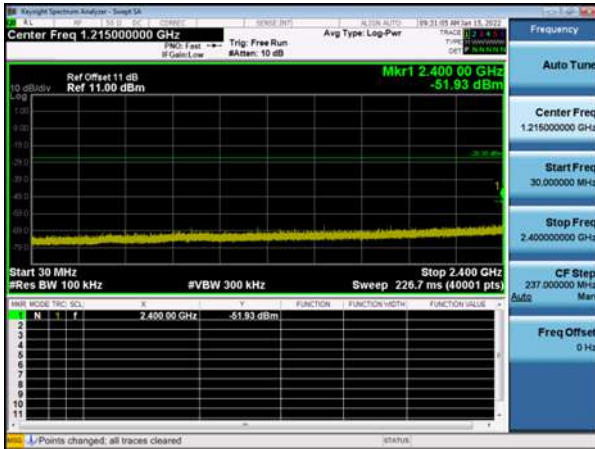





Modulation Type: 8DPSK (3Mbps)  
Channel: 78

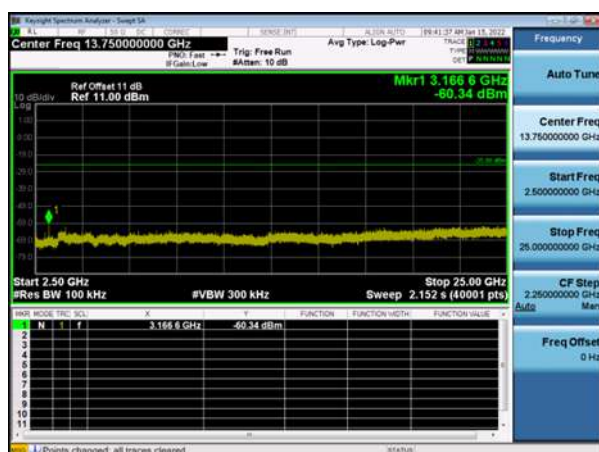
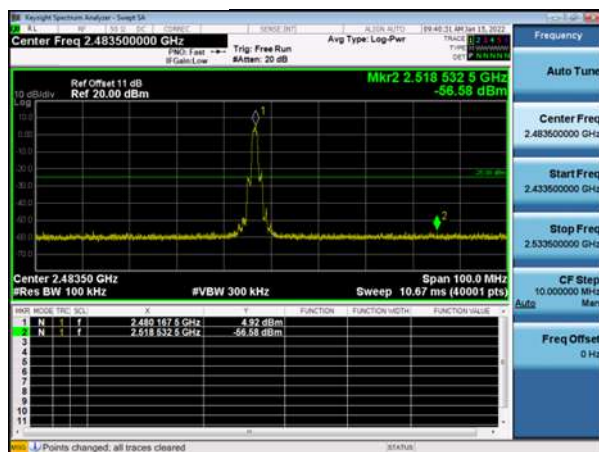
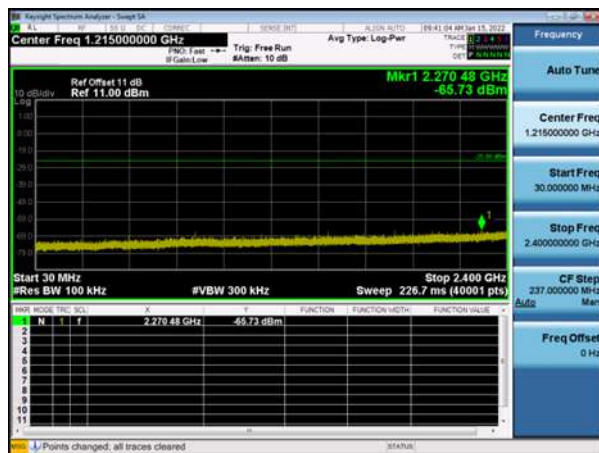



Hopping Mode: Modulation Type: GFSK

Modulation Type:  $\pi/4$ -DQPSK

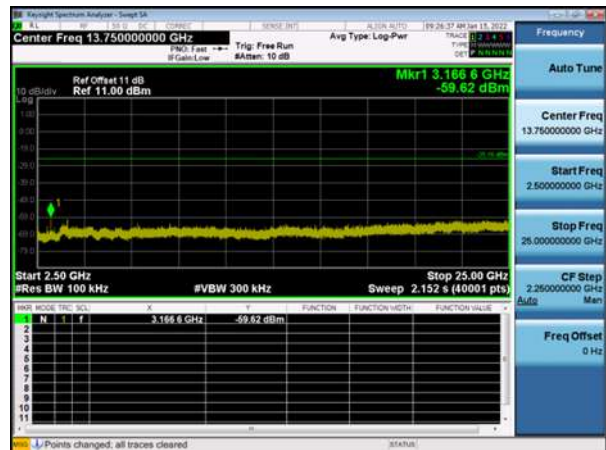
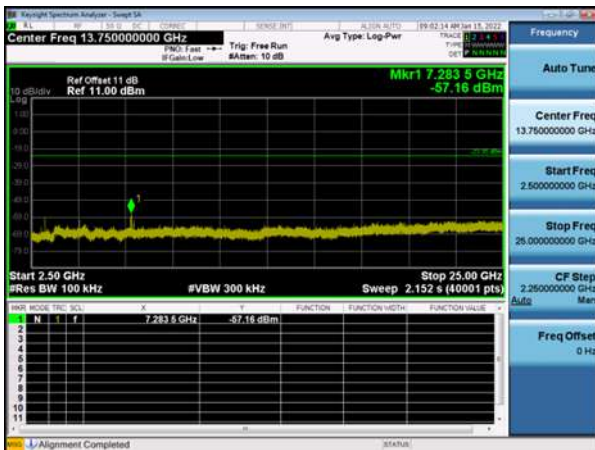
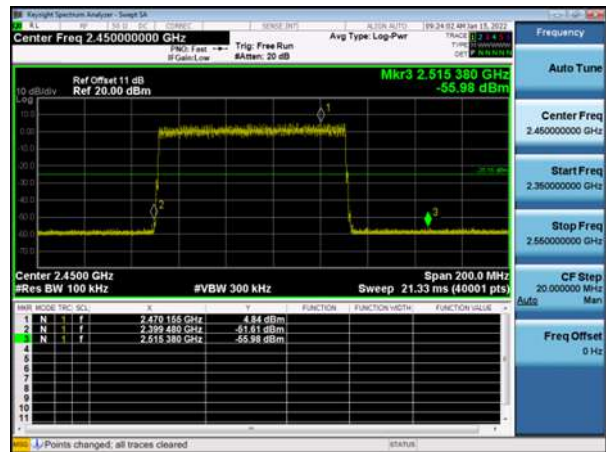
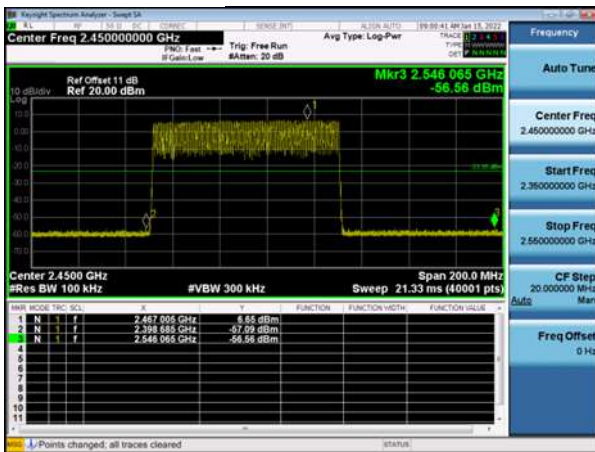
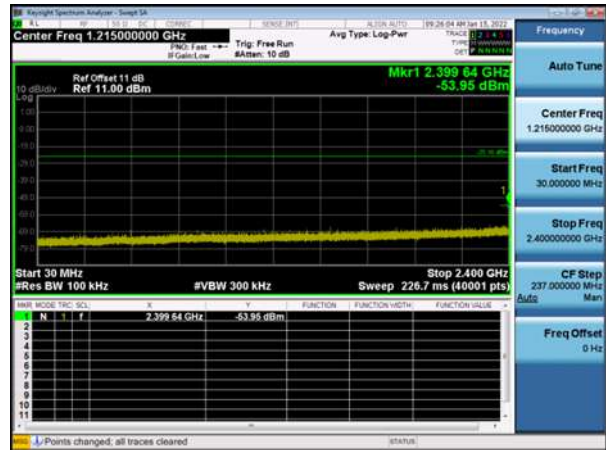
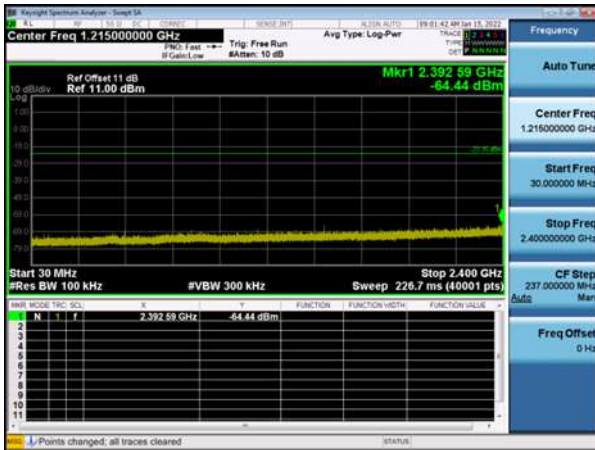



Modulation Type: 8DPSK

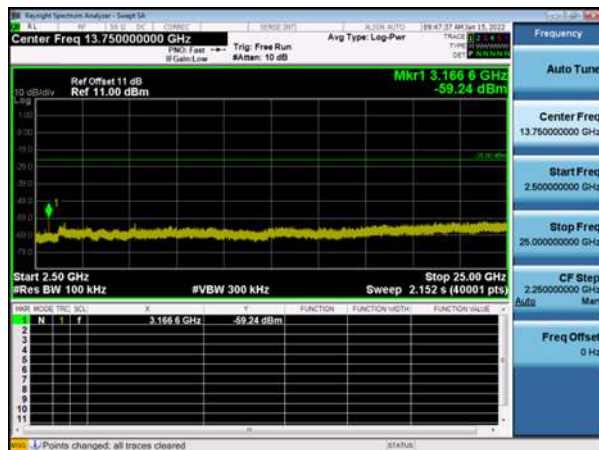
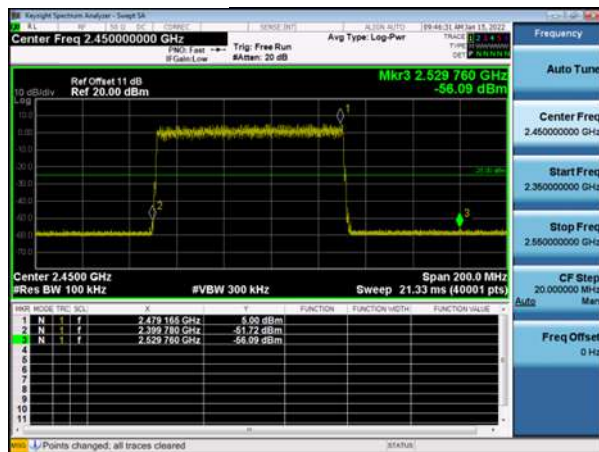
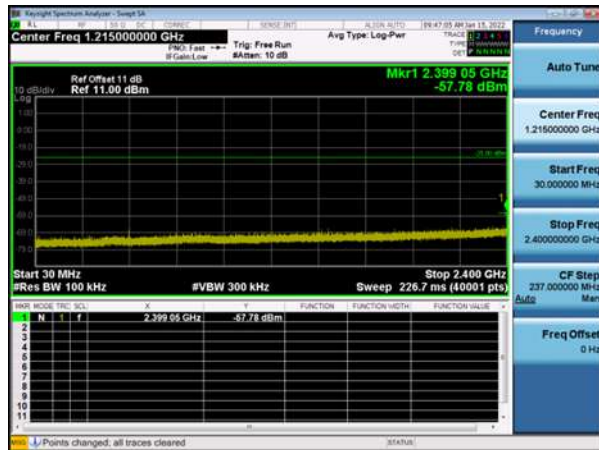



### 8. 20dB Bandwidth Measurement Data

#### 8.1 Test Limit

For reference data.

#### 8.2 Test Procedures

According to the methods defined in ANSI C63.10-2013 Section 6.9

- a. The transmitter output was connected to the spectrum analyzer.
- b. Set RBW of spectrum analyzer to 1% to 5% of the 20dB Bandwidth and VBW to approximately three times RBW.
- c. The 20 dB bandwidth is defined as the total spectrum the power of which is higher than peak power minus 20 dB.

#### 8.3 Test Setup Layout

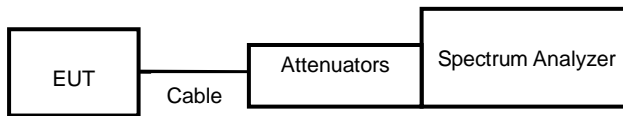

#### 8.4 Test Result and Data

Modulation Type	Channel	Frequency (MHz)	20dB Bandwidth (MHz)	2/3 20dB Bandwidth (MHz)
GFSK	0	2402	1.013	0.675
	39	2441	1.005	0.670
	78	2480	1.019	0.679
π/4-DQPSK	0	2402	1.361	0.907
	39	2441	1.365	0.910
	78	2480	1.364	0.909
8DPSK	0	2402	1.318	0.879
	39	2441	1.315	0.877
	78	2480	1.316	0.877



Modulation Type: GFSK (1Mbps)  
Channel: 00

Modulation Type:  $\pi/4$ -DQPSK (2Mbps)  
Channel: 00



CH78

CH78

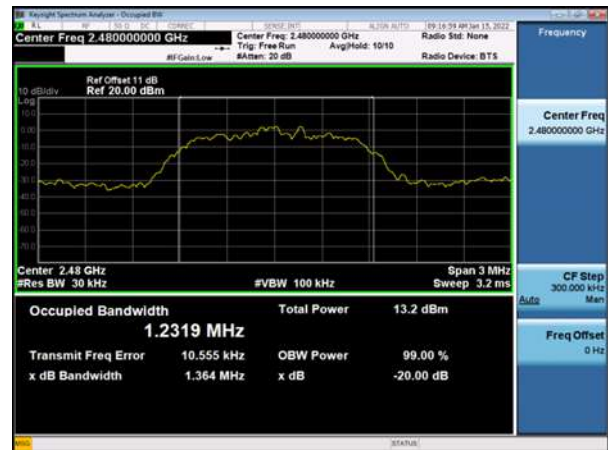



Modulation Type: 8DPSK (3Mbps)  
Channel: 00

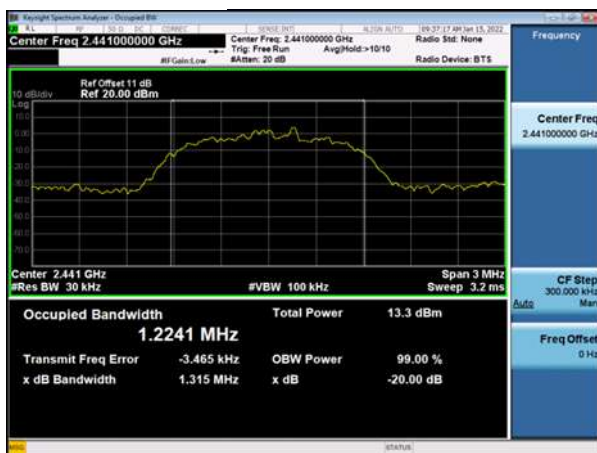
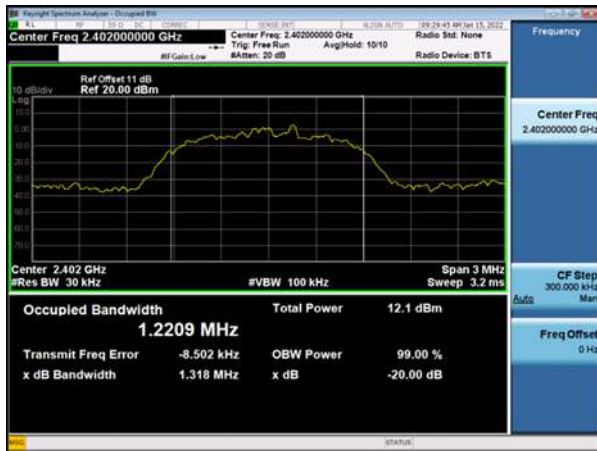

CH78

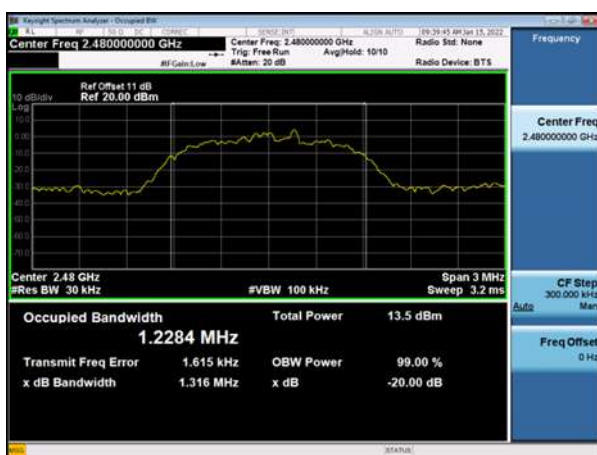



## 9. Carrier Frequency Separation

### 9.1 Test Limit

Frequency hopping systems shall have hopping channel carrier frequencies separated by a minimum of 25 kHz or the 20 dB bandwidth of the hopping channel, whichever is greater. Alternatively, frequency hopping systems operating in the 2400–2483.5 MHz band may have hopping channel carrier frequencies that are separated by 25 kHz or two-thirds of the 20 dB bandwidth of the hopping channel, whichever is greater, provided the systems operate with an output power no greater than 125 mW.

### 9.2 Test Procedures

According to the methods defined in ANSI C63.10-2013 Section 7.8.2

- a. The transmitter output was connected to the spectrum analyzer.
- b. Set RBW of spectrum analyzer to 300 KHz and VBW to 1000 KHz.
- c. By using the MaxHold function record the separation of two adjacent channels.
- d. Measure the frequency difference of these two adjacent channels.

### 9.3 Test Setup Layout

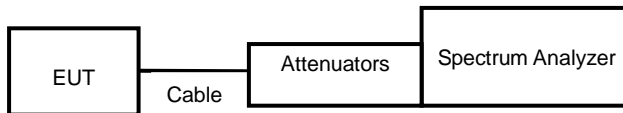

### 9.4 Test Result and Data

Modulation Type	Channel	Frequency (MHz)	Channel Separation (MHz)	Limit (MHz)
GFSK	0	2402	1.002	0.675
	39	2441	1.002	0.670
	78	2480	1.002	0.679
π/4-DQPSK	0	2402	1.002	0.907
	39	2441	1.002	0.910
	78	2480	1.002	0.909
8DPSK	0	2402	1.002	0.879
	39	2441	1.002	0.877
	78	2480	1.002	0.877



Modulation Type: GFSK (1Mbps)  
Channel: 00

Modulation Type:  $\pi/4$ -DQPSK (2Mbps)  
Channel: 00

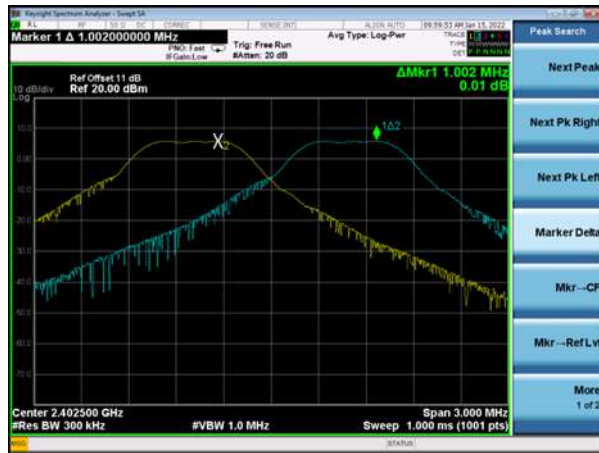

CH78

CH78

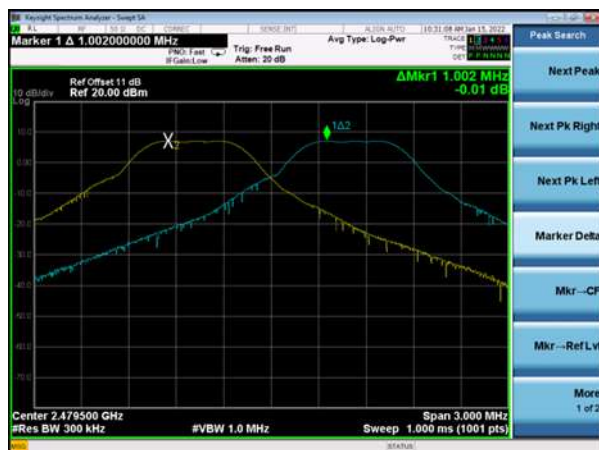





Modulation Type: 8DPSK (3Mbps)  
Channel: 00



CH78





## 10. Dwell Time on each channel

### 10.1 Test Limit

The average time of occupancy on any channel shall not be greater than 0.4 seconds within a period of 0.4 seconds multiplied by the number of hopping channels employed.

### 10.2 Test Procedures

According to the methods defined in ANSI C63.10-2013 Section 7.8.4

1. The transmitter output was connected to the spectrum analyzer.
2. Adjust the center frequency to measure frequency, then set zero span mode.
3. Set RBW of spectrum analyzer to 300KHz and VBW to 1MHz.
4. Measure the time duration of one transmission on the measured frequency.

### 10.3 Test Setup Layout

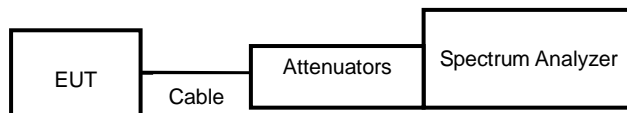

### 10.4 Test Result and Data

Channel	Frequency (MHz)	Length of transmission time (ms)	Number of transmission in a 31.6 (79 Hopping*0.4)	Dwell Time (ms)	Limit (ms)
GFSK-DH1	2402	0.395	320.00	126.40	400
GFSK-DH3	2402	1.642	160.00	262.72	400
GFSK-DH5	2402	2.896	106.67	308.91	400
$\pi/4$ -DQPSK-DH1	2402	0.400	320.00	128.00	400
$\pi/4$ -DQPSK-DH3	2402	1.642	160.00	262.72	400
$\pi/4$ -DQPSK-DH5	2402	2.896	106.67	308.91	400
8DPSK-DH1	2402	0.400	320.00	128.00	400
8DPSK-DH3	2402	1.651	160.00	264.16	400
8DPSK-DH5	2402	2.893	106.67	308.59	400

Channel	Frequency (MHz)	Length of transmission time (ms)	Number of transmission in a 8 (20 Hopping*0.4)	Dwell Time (ms)	Limit (ms)
AFH-DH1	2402-2421	0.394	160.00	63.09	400
AFH-DH3	2402-2421	1.643	80.00	131.44	400
AFH-DH5	2402-2421	2.895	53.33	154.39	400



Modulation Type: GFSK-DH1  
Channel: 00

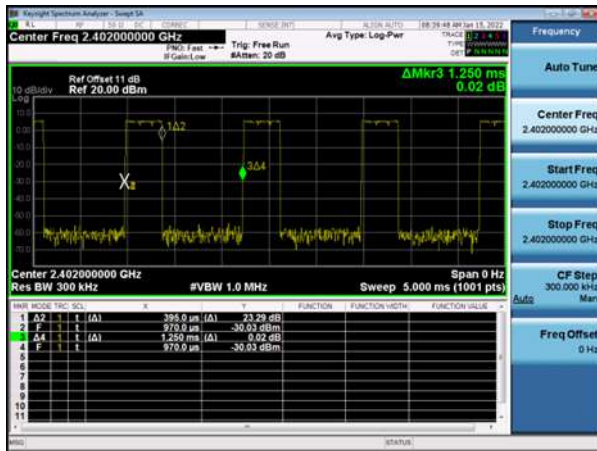

Modulation Type: π/4-DQPSK-DH1  
Channel: 00

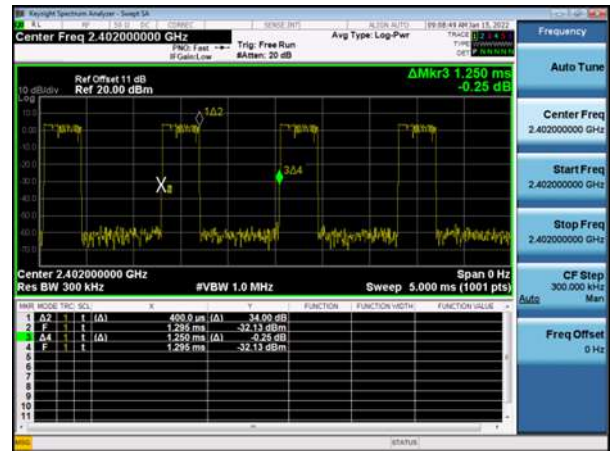

Modulation Type: GFSK-DH3  
Channel: 00

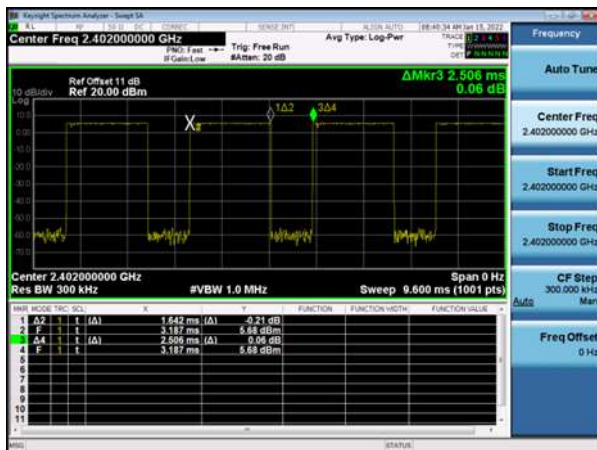

Modulation Type: π/4-DQPSK-DH3  
Channel: 00

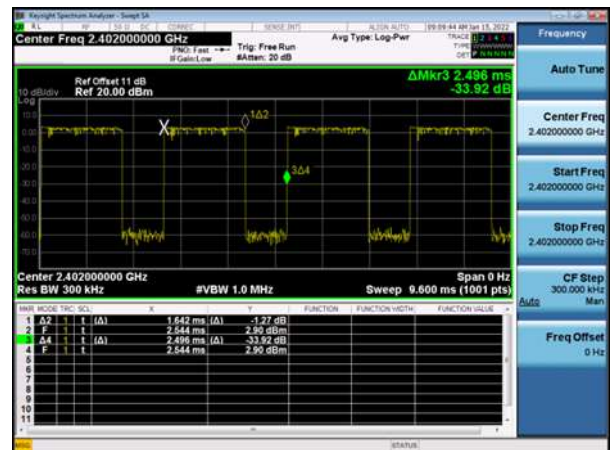

Modulation Type: GFSK-DH5  
Channel: 00

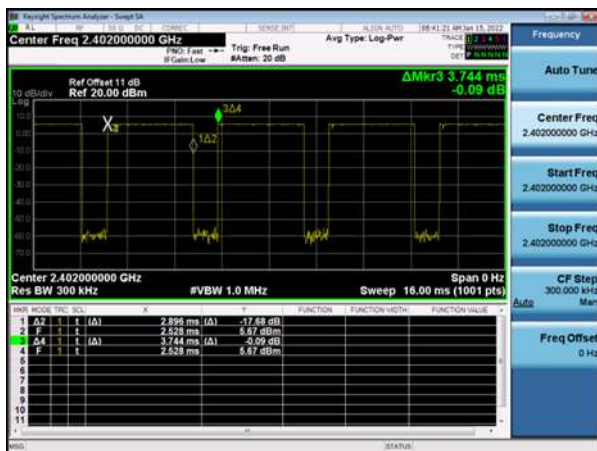

Modulation Type: π/4-DQPSK-DH5  
Channel: 00

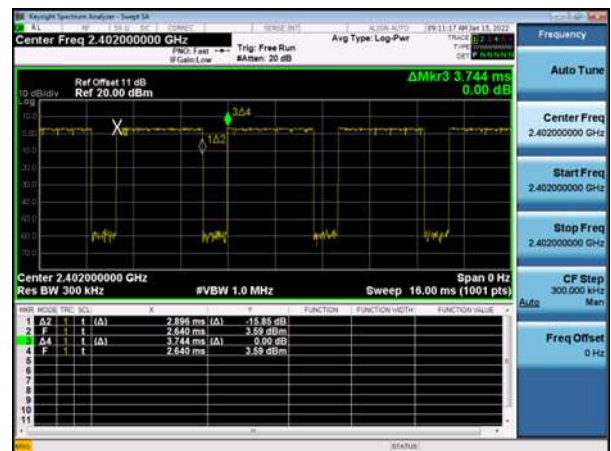



Modulation Type: 8DPSK-DH1  
Channel: 00

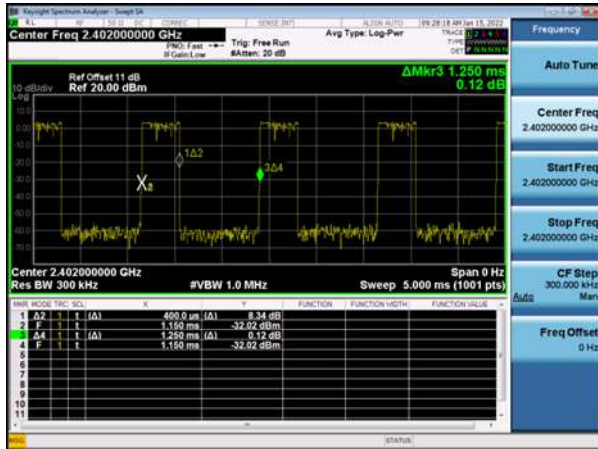

Modulation Type: GFSK-DH1 (AFH)  
Channel: 00

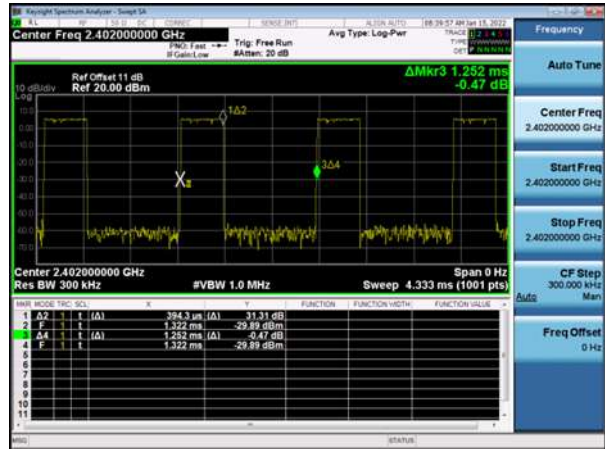

Modulation Type: 8DPSK-DH3  
Channel: 00

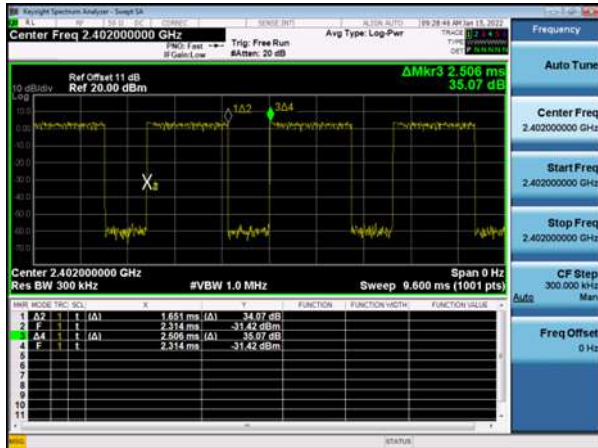

Modulation Type: GFSK-DH3 (AFH)  
Channel: 00

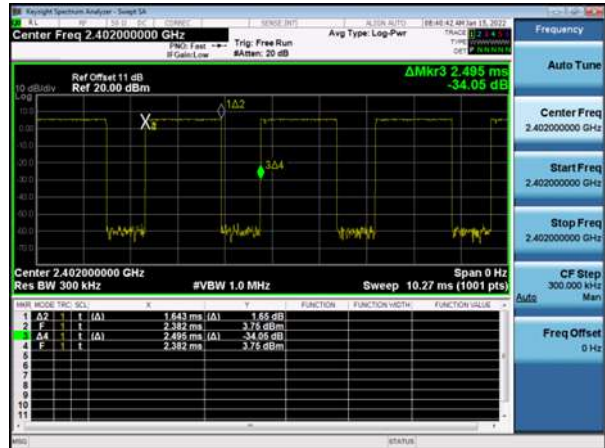

Modulation Type: 8DPSK-DH5  
Channel: 00

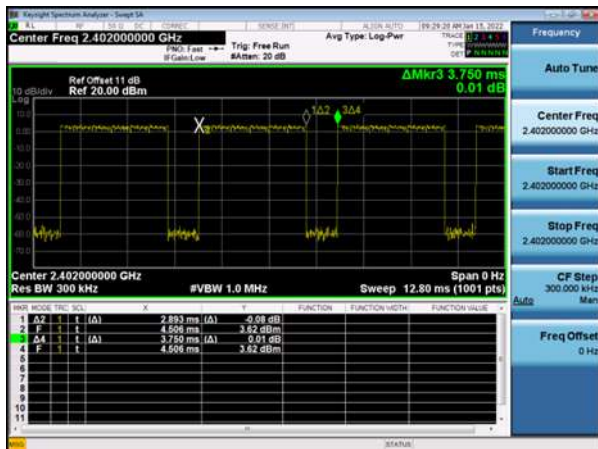

Modulation Type: GFSK-DH5 (AFH)  
Channel: 00

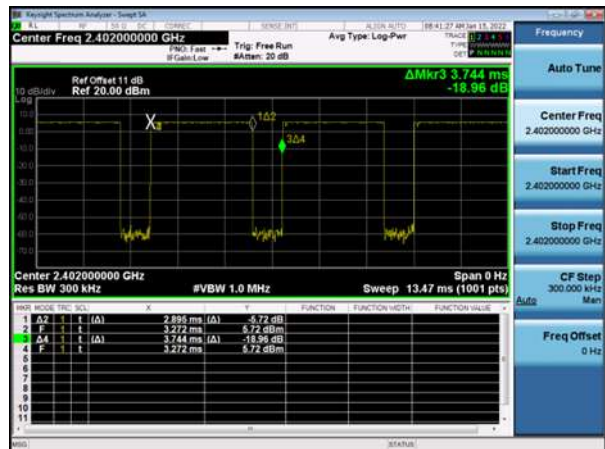



## 11. Number of Hopping Channels

### 11.1 Test Limit

Frequency hopping systems in the 2400 ~ 2483.5 MHz band shall use at least 15 channels.

### 11.2 Test Procedures

According to the methods defined in ANSI C63.10-2013 Section 7.8.3

- a. The transmitter output was connected to the spectrum analyzer.
- b. 2. Set RBW of spectrum analyzer to 100 KHz and VBW to 300 KHz.
- c. 3. Set the MaxHold function, and then keep the EUT in hopping mode. Record all the signals from each channel until each one has been record.

### 11.3 Test Setup Layout

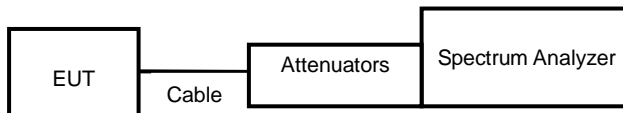

### 11.4 Test Result and Data

Modulation Type	Hopping Channels
GFSK	79
$\pi/4$ -DQPSK	79
8DPSK	79



Modulation Type: GFSK (1Mbps)

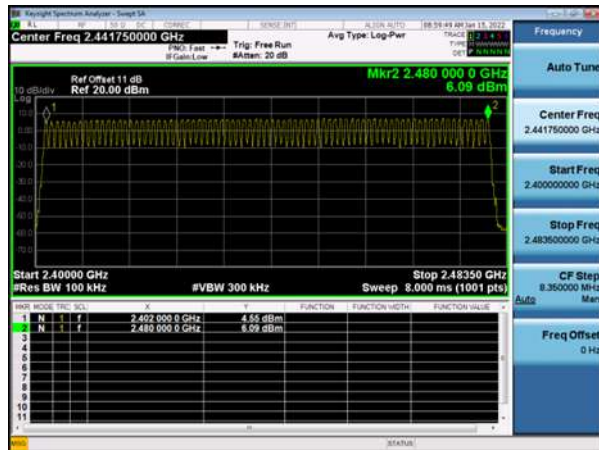

Modulation Type:  $\pi/4$ -DQPSK (2Mbps)

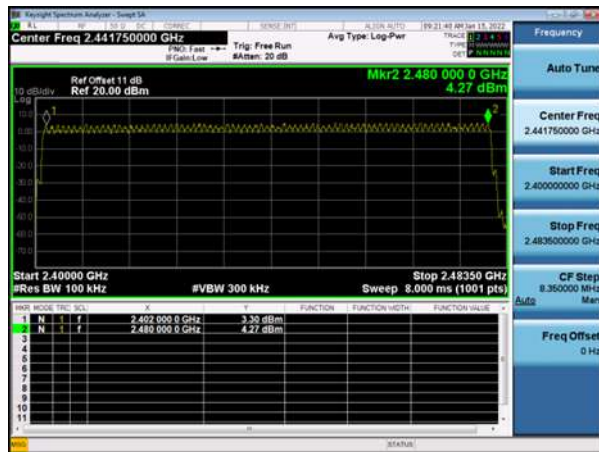

Modulation Type: 8DPSK (3Mbps)

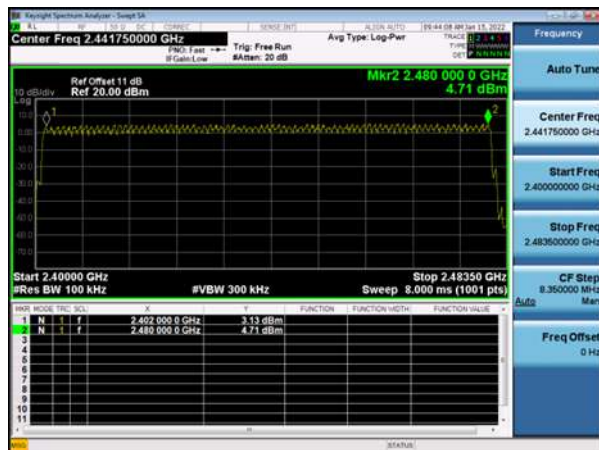



## 12. Maximum Average Output Power

### 12.1 Test Limit

The Maximum Average Output Power Measurement is 30dBm.

### 12.2 Test Procedures

According to the methods defined in ANSI C63.10-2013 Section 7.8.5

The antenna port( RF output )of the EUT was connected to the input( RF input )of a power meter.

Power was read directly from the meter and cable loss connection was added to the reading to obtain power at the EUT antenna terminal. The EUT Output Power was set to maximum to produce the worse case test result.

### 12.3 Test Setup Layout

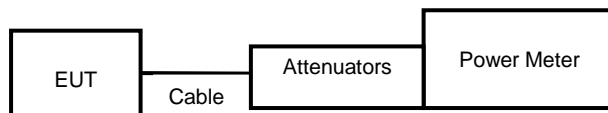

### 12.4 Test Result and Data

Modulation Type	Setting	Channel	Frequency (MHz)	AV Output Power (dBm)	AV Output Power (mW)
GFSK	0	0	2402	5.37	3.443
	0	39	2441	6.46	4.426
	0	78	2480	6.61	4.581
π/4-DQPSK	0	0	2402	3.21	2.094
	0	39	2441	4.28	2.679
	0	78	2480	4.47	2.799
8DPSK	0	0	2402	3.17	2.075
	0	39	2441	4.23	2.649
	0	78	2480	4.41	2.761

#### AFH Mode

Modulation Type	Setting	Channel	Frequency (MHz)	AV Output Power (dBm)	AV Output Power (mW)
GFSK	0	0-19	2402-2421	5.92	3.904
π/4-DQPSK	0	0-19	2402-2421	3.75	2.369
8DPSK	0	0-19	2402-2421	3.70	2.344