



427 West 12800 South
Draper, UT 84020

Test Report Certification

FCC ID	SWX-UBBXG
IC ID	6545A-UBBXG
Equipment Under Test	UBB-XG
Test Report Serial Number	TR5694_04
Date of Test(s)	14, 28 and 31 December 2020
Report Issue Date	7 th January 2021

Test Specification	Applicant
47 CFR FCC Part 15, Subpart C	Ubiquiti Inc. 685 Third Avenue New York, NY 10019 U.S.A.



NVLAP LAB CODE 600241-0

Certification of Engineering Report

This report has been prepared by Unified Compliance Laboratory (UCL) to document compliance of the device described below with the requirement of Federal Communication Commissions (FCC) Part 15, Subpart C. This report may be reproduced in full. Partial reproduction of this report may only be made with the written consent of the laboratory. The results in this report apply only to the sample tested.

Applicant	Ubiquiti Inc.
Manufacturer	Ubiquiti Inc.
Brand Name	UniFi
Model Number	UBB-XG
FCC ID	SWX-UBBXG
IC ID	6545A-UBBXG

On this 7th day of January 2021, I individually and for Unified Compliance Laboratory certify that the statements made in this engineering report are true, complete and correct to the best of my knowledge and are made in good faith.

Although NVLAP has accredited the Unified Compliance Laboratory testing facilities, this report must not be used to claim product certification, approval, or endorsement by NVLAP, NIST or any agency of the U.S. federal government.

Unified Compliance Laboratory



Written By: Joseph W. Jackson



Reviewed By: Richard L. Winter

Revision History		
Revision	Description	Date
01	Original Report Release	7 th January 2021
02	Updated sections 5.7 and 5.8	1 st February 2021
03	Updated section 5.7.2	2 nd February 2021
04	Updated AC line conducted emissions data	25 th March 2021

Table of Contents

1	Client Information.....	5
1.1	Applicant.....	5
1.2	Manufacturer.....	5
2	Equipment Under Test (EUT).....	6
2.1	Identification of EUT	6
2.2	Description of EUT.....	6
2.3	EUT and Support Equipment.....	6
2.4	Interface Ports on EUT	7
2.5	Operating Environment.....	7
2.6	Operating Modes.....	7
2.7	EUT Exercise Software.....	7
2.8	Block Diagram of Test Configuration	8
2.9	Modification Incorporated/Special Accessories on EUT.....	8
2.10	Deviation, Opinions Additional Information or Interpretations from Test Standard.....	8
3	Test Specification, Method and Procedures.....	9
3.1	Test Specification.....	9
3.2	Methods & Procedures.....	9
3.3	FCC Part 15, Subpart C	9
3.4	Results.....	10
3.5	Test Location	10
4	Test Equipment	11
4.1	Conducted Emissions at Mains Ports.....	11
4.2	Direct Connect at the Antenna Port Tests.....	11
4.3	Radiated Emissions.....	12
4.4	Equipment Calibration	13
4.5	Measurement Uncertainty.....	13
5	Test Results.....	14
5.1	§15.203 Antenna Requirements.....	14
5.2	Conducted Emissions at Mains Ports Data	14
5.3	Hot Lead.....	14
5.4	Neutral Lead.....	15
5.5	§15.247(a)(2) Emissions Bandwidth.....	16
5.6	§15.247(b)(3) Maximum Average Output Power.....	16
5.7	§15.247(d) Spurious Emissions	16
5.8	§15.247(e) Maximum Average Power Spectral Density	22

1 Client Information

1.1 Applicant

Company	Ubiquiti Inc. 685 Third Avenue New York, NY 10017 U.S.A.
Contact Name	Mark Feil
Title	Compliance Manager

1.2 Manufacturer

Company	Ubiquiti Inc. 685 Third Avenue New York, NY 10017 U.S.A.
Contact Name	Mark Feil
Title	Compliance Manager

2 Equipment Under Test (EUT)

2.1 Identification of EUT

Brand Name	UniFi
Model Number	UBB-XG
Serial Number	0418D6A24C9F
Dimensions (cm)	19.18 x 19.18 x 5.9

2.2 Description of EUT

The UBB-XG is a 60 GHz building to building network bridge transmitter with a 5 GHz backup redundancy transmitter. The UBB-XG is paired with a second UBB-XG for ease in setup and operation. When used with the UniFi Controller it provides bridging two networks with a high Gbps throughput. The UBB-XG is powered from a Model U-POE-at PoE power adapter.

This report covers the circuitry of the device subject to FCC Part 15, Subpart C. The circuitry of the device subject to FCC Part 15 Subpart B was found to be compliant and is covered under a separate Unified Compliance Laboratory test report.

2.3 EUT and Support Equipment

The EUT and support equipment used during the test are listed below.

Brand Name Model Number Serial Number	Description	Name of Interface Ports / Interface Cables
BN: UniFi MN: UBB-XG (Note 1) SN: 0418D6A24C9F	Building-to-Building Network Bridge	See Section 2.4
BN: Ubiquiti MN: U-POE-at SN: N/A	PoE Power Adapter	PoE Port See Section 2.4
BN: Dell MN: XPS 13 SN: N/A	Laptop Personal Computer	LAN Port / Un-shielded Cat 5e cable (Note 2)

Notes: (1) EUT

(2) Interface port connected to EUT (See Section 2.4)

The support equipment listed above was not modified in order to achieve compliance with this standard.

2.4 Interface Ports on EUT

Name of Ports	No. of Ports Fitted to EUT	Cable Description/Length
AC	1	3 conductor power cord/80 cm
PoE	1	Un-shielded Cat 5e cable/1 meter
LAN	1	Un-shielded Cat 5e cable/1 meter

2.5 Operating Environment

Power Supply	120/240 VAC to 48 Volt PoE Power
AC Mains Frequency	50/60 Hz
Temperature	20.0 – 22.0 °C
Humidity	19.3 – 28.9 %
Barometric Pressure	1023 mBar

2.6 Operating Modes

The UBB-XG was connected to a personal computer laptop and tested using test software in order to enable to constant transmission of the Bluetooth transceiver.

2.7 EUT Exercise Software

EUT firmware version 1.0 was used to operate the transmitter using a constant transmit mode.

2.8 Block Diagram of Test Configuration

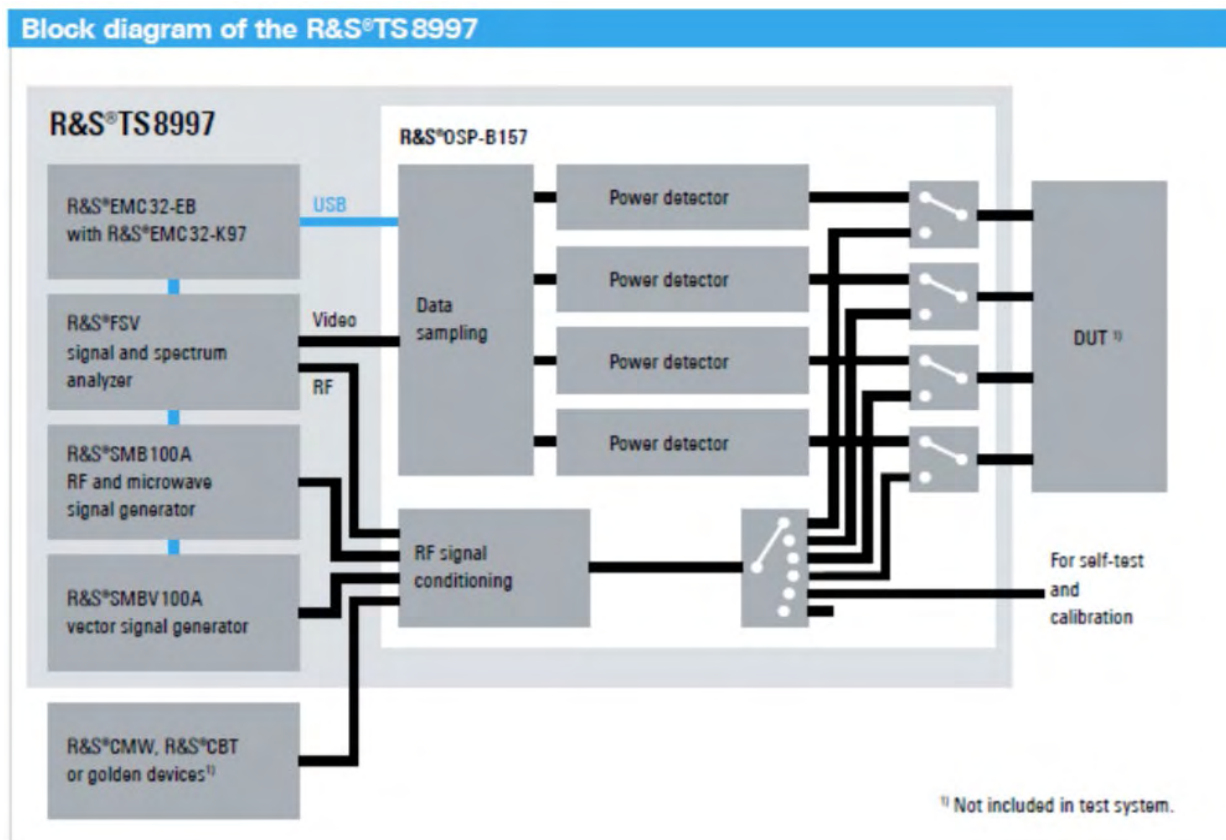

Diagram 1: Test Configuration Block Diagram

2.9 Modification Incorporated/Special Accessories on EUT

There were no modifications made to the EUT during testing to comply with the specification.

2.10 Deviation, Opinions Additional Information or Interpretations from Test Standard

There were no deviations, opinions, additional information or interpretations from the test specification.

3 Test Specification, Method and Procedures

3.1 Test Specification

Title	47 CFR FCC Part 15, Subpart C 15.203, 15.207 and 15.247 Limits and methods of measurement of radio interference characteristics of radio frequency devices.
Purpose of Test	The tests were performed to demonstrate initial compliance

3.2 Methods & Procedures

3.2.1 47 CFR FCC Part 15 Section 15.203

See test standard for details.

3.2.2 47 CFR FCC Part 15 Section 15.207

See test standard for details.

3.2.3 47 CFR FCC Part 15 Section 15.247

See test standard for details.

3.3 FCC Part 15, Subpart C

3.3.1 Summary of Tests

FCC Section	ISED Section	Environmental Phenomena	Frequency Range (MHZ)	Result
15.203	N/A	Antenna requirements	Structural Requirement	Compliant
15.207	RSS-Gen	Conducted Disturbance at Mains Port	0.15 to 30	Compliant
15.247(a)	RSS-247 § 5.2	Bandwidth Requirement	2400 to 2483.5	Compliant
15.247(b)	RSS-247 § 5.4	Peak Output Power	2400 to 2483.5	Compliant
15.247(d)	RSS-247 § 5.4	Antenna Conducted Spurious Emissions	0.009 to 26000	Compliant
15.247(d)	RSS-247 § 5.4	Radiated Spurious Emissions	0.009 to 26000	Compliant
15.247(e)	RSS-247 § 5.2	Peak Power Spectral Density	2400 to 2483.5	Compliant
The testing was performed according to the procedures in ANSI C63.10-2013, KDB 558074 and 47 CFR Part 15.				

3.4 Results

In the configuration tested, the EUT complied with the requirements of the specification.

3.5 Test Location

Testing was performed at the Unified Compliance Laboratory 10-Meter chamber located at 427 West 12800 South, Draper, UT 84020. Unified Compliance Laboratory is accredited by National Voluntary Laboratory Accreditation Program (NVLAP); NVLAP Code 600241-0 which is effective until 30 June 2021. This site has also been registered with Innovations, Science and Economic Development (ISED) department and was accepted under Appendix B, Phase 1 procedures of the APEC Tel MRA for Canadian recognition. ISED No.: 25346, effective until June 30, 2021. Unified Compliance Laboratory has been assigned Conformity Assessment Number US0223 by ISED.

4 Test Equipment

4.1 Conducted Emissions at Mains Ports

Type of Equipment	Manufacturer	Model Number	Asset Number	Date of Last Calibration	Due Date of Calibration
EMI Receiver	AFJ	FFT3010	UCL-2500	9/18/2020	9/18/2021
LISN	AFJ	LS16C/10	UCL-2512	5/26/2020	5/26/2021
Cat6 ISN	Teseq	ISN T8-Cat6	UCL-2971	5/18/2020	5/18/2021
ISN	Teseq	ISN T800	UCL-2974	6/1/2020	6/1/2021
LISN	Com-Power	LIN-120C	UCL-2612	5/19/2020	5/19/2021
AC Power Source	Laplace Instruments	AC1000A	UCL-2857	N/A	N/A
Test Software	UCL	Revision 1	UCL-3107	N/A	N/A

Table 1: List of equipment used for Conducted Emissions Testing at Mains Port

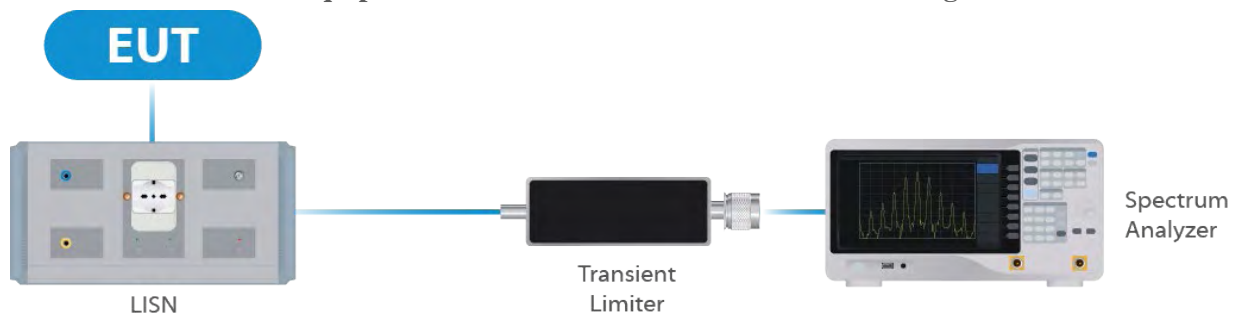

Figure 1: Conducted Emissions Test

4.2 Direct Connect at the Antenna Port Tests

Type of Equipment	Manufacturer	Model Number	Asset Number	Date of Last Calibration	Due Date of Calibration
Spectrum Analyzer	R&S	FSV40	UCL-2861	8/24/2020	8/24/2021
Signal Generator	R&S	SMB100A	UCL-2864	N/A	N/A
Vector Signal Generator	R&S	SMBV100A	UCL-2873	N/A	N/A
Switch Extension	R&S	OSP-B157WX	UCL-2867	8/25/2020	8/25/2021
Switch Extension	R&S	OSP-150W	UCL-2870	8/21/2020	8/21/2021

Table 2: List of equipment used for Direct Connect at the Antenna Port

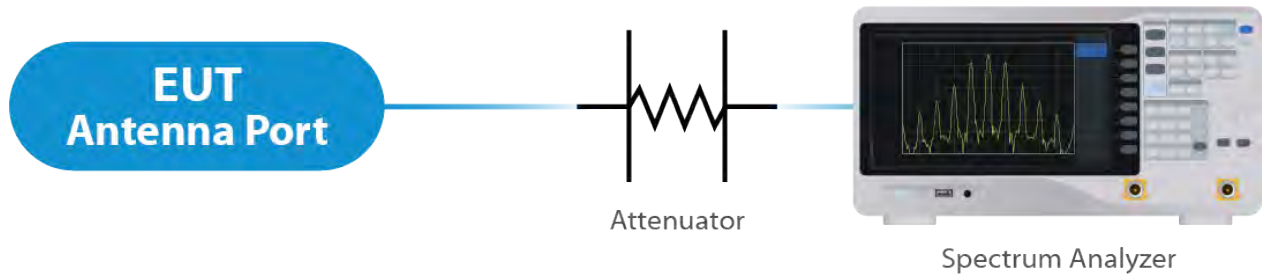

Figure 2: Direct Connect at the Antenna Port Test

4.3 Radiated Emissions

Type of Equipment	Manufacturer	Model Number	Asset Number	Date of Last Calibration	Due Date of Calibration
EMI Receiver	Keysight	N9038A	UCL-2778	6/1/2020	6/1/2021
Pre-Amplifier	Sonoma Instruments	310N	UCL-2889	9/10/2020	9/10/2021
Double Ridge Horn Antenna	Scwarzbeck	BBHA 9120D	UCL-3065	7/8/2020	7/8/2021
Log Periodic	Scwarzbeck	STLP 9129	UCL-3068	5/20/2020	5/20/2021
15 - 40 GHz Horn Antenna	Scwarzbeck	BBHA 9170	UCL-2487	5/21/2020	5/21/2021
18 – 40 GHz Amplifier	Com-Power	PAM 118A	UCL-3833	1/28/2020	1/28/2021
0.5 – 18 GHz Amplifier	Scwarzbeck	BBV 9718C	UCL-2493	1/24/2020	1/24/2021
Test Software	UCL	Revision 1	UCL-3108	N/A	N/A

Table 3: List of equipment used for Radiated Emissions

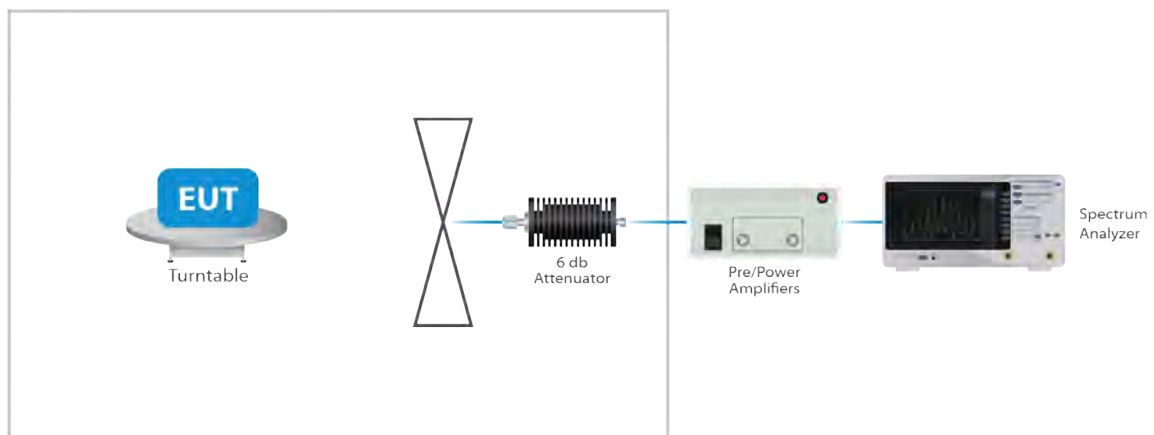

Figure 3: Radiated Emissions Test

4.4 Equipment Calibration

All applicable equipment is calibrated using either an independent calibration laboratory or Unified Compliance Laboratory personnel at intervals defined in ANSI C63.4:2014 following outlined calibration procedures. All measurement instrumentation is traceable to the National Institute of Standards and Technology (NIST). Supporting documentation relative to traceability is on file and is available for examination upon request.

4.5 Measurement Uncertainty

Test	Uncertainty (\pm dB)	Confidence (%)
Conducted Emissions	1.44	95
Radiated Emissions (9 kHz to 30 MHz)	2.50	95
Radiated Emissions (30 MHz to 1 GHz)	4.38	95
Radiated Emissions (1 GHz to 18 GHz)	4.37	95
Radiated Emissions (18 GHz to 40 GHz)	3.93	95
Direct Connect Tests	K Factor	Value
Emissions Bandwidth	2	2.0%
Output Power	2	1.0 dB
Peak Power Spectral Density	2	1.3 dB
Band Edge	2	0.8 dB
Transmitter Spurious Emissions	2	1.8 dB

5 Test Results

5.1 §15.203 Antenna Requirements

The EUT uses an integral antenna. The Maximum gain of the antenna is 2.5 dBi. The antenna is not user replaceable.

Results

The EUT complied with the specification

5.2 Conducted Emissions at Mains Ports Data

5.3 Hot Lead

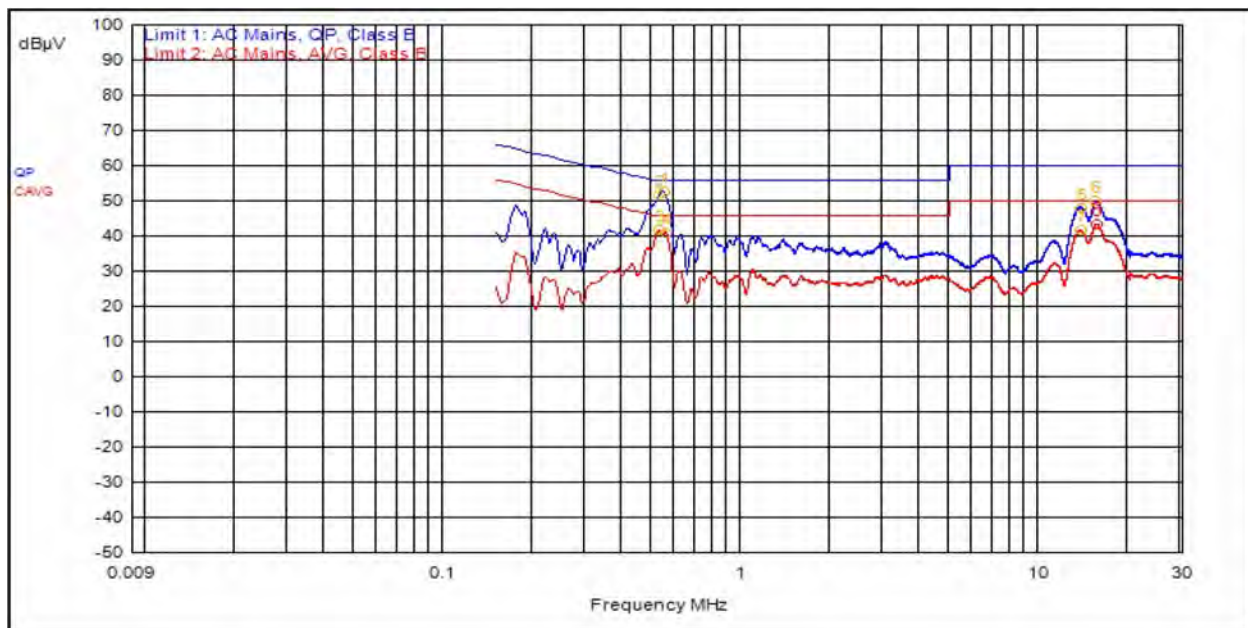

ID	Frequency	Probe	Cable	Atten.	Detector	Meter Read	Meas Level	Limit	Limit Dist.
1	546.000kHz	12.4	0.0		QPeak	40.2	52.6	56.0	-3.4
2	528.000kHz	12.4	0.0		QPeak	39.4	51.8	56.0	-4.2
3	528.000kHz	12.4	0.0		C_AVG	29.1	41.5	46.0	-4.5
4	558.000kHz	12.4	0.0		C_AVG	28.5	40.9	46.0	-5.1
8	15.465MHz	12.5	0.2		C_AVG	30.8	43.5	50.0	-6.5
7	13.644MHz	12.4	0.2		C_AVG	28.9	41.5	50.0	-8.5
6	15.363MHz	12.5	0.2		QPeak	37.2	49.9	60.0	-10.1
5	13.689MHz	12.4	0.2		QPeak	35.3	48.0	60.0	-12.0

5.4 Neutral Lead

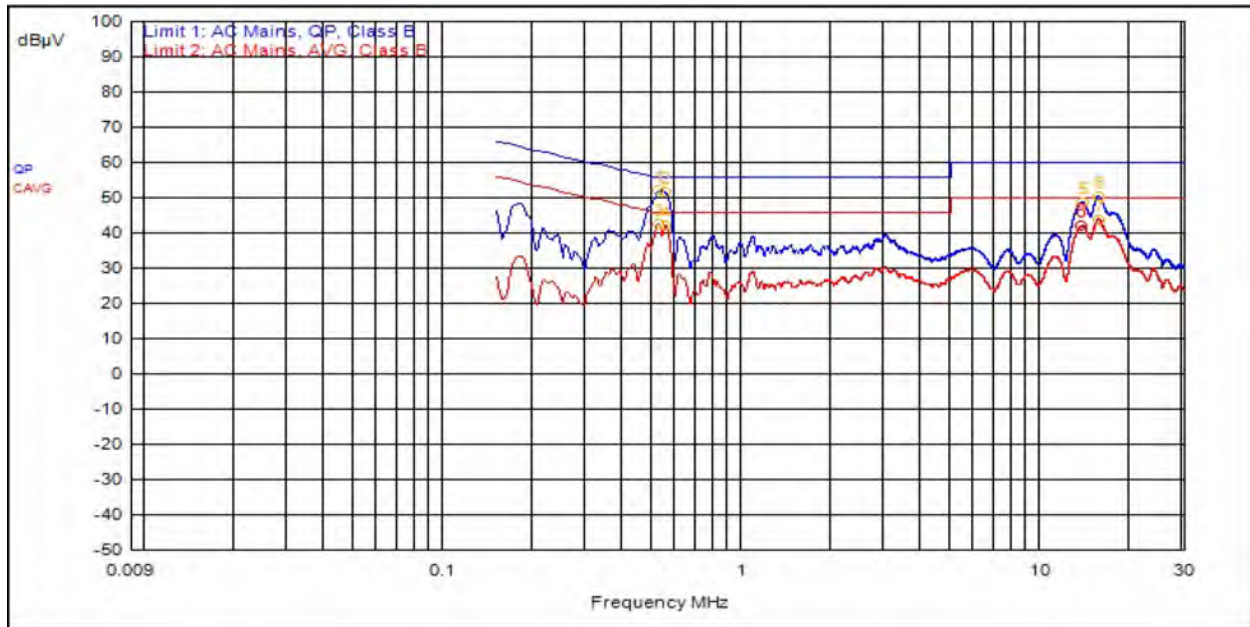

ID	Frequency	Probe	Cable	Atten.	Detector	Meter Read	Meas Level	Limit	Limit Dist.
3	519.000kHz	12.4	0.0		C_AVG	30.0	42.4	46.0	-3.6
1	522.000kHz	12.4	0.0		QPeak	39.4	51.9	56.0	-4.1
4	552.000kHz	12.4	0.0		C_AVG	29.5	41.9	46.0	-4.1
2	549.000kHz	12.4	0.0		QPeak	39.1	51.5	56.0	-4.5
7	15.405MHz	12.5	0.2		C_AVG	31.3	43.9	50.0	-6.1
8	13.563MHz	12.4	0.2		C_AVG	29.4	42.1	50.0	-7.9
6	15.450MHz	12.5	0.2		QPeak	37.8	50.4	60.0	-9.6
5	13.623MHz	12.4	0.2		QPeak	35.9	48.6	60.0	-11.4

Result

The EUT complied with the specification limit.

5.5 §15.247(a)(2) Emissions Bandwidth

Frequency (MHz)	Emissions 6 dB Bandwidth (MHz)
2402	0.67
2442	0.67
2480	0.65

Result

In the configuration tested, the 6 dB bandwidth was greater than 500 kHz; therefore, the EUT complied with the requirements of the specification (see spectrum analyzer plot within the Annex).

5.6 §15.247(b)(3) Maximum Average Output Power

The maximum average RF conducted output power measured for this device was 5.8 dBm or 3.80 mW. The limit is 30 dBm or 1 Watt when using antennas with 6 dBi or less gain. The antenna has a gain of 2.5 dBi.

Frequency (MHz)	Measured Output Power (dBm)	Output Power (mW)
2402	4.2	2.63
2442	5.8	3.80
2480	5.7	3.72

Result

In the configuration tested, the maximum average RF output power was less than 1 watt; therefore, the EUT complied with the requirements of the specification (see spectrum analyzer plot within the Annex).

5.7 §15.247(d) Spurious Emissions

5.7.1 Conducted Spurious Emissions

The frequency range from the lowest frequency generated or used in the device to the tenth harmonic of the highest fundamental frequency was investigated to measure any antenna-conducted emissions. The table show the measurement data from spurious emissions noted across the frequency range when transmitting at the lowest frequency, middle frequency and upper frequency. Shown within the Annex are plot(s) with the EUT tuned to the upper and lower channels. These demonstrate compliance with the provisions of this section at the band edges.

The emissions must be attenuated 30 dB below the highest power spectral density level measured within the authorized band as measured with a 100 kHz RBW.

Result

Conducted spurious emissions were attenuated 30 dB or more below the fundamental; therefore, the EUT complies with the specification.

5.7.2 Radiated Spurious Emissions in the Restricted Bands of §15.205

The frequency ranges from the lowest frequency generated or used in the device to the tenth harmonic of the highest fundamental emissions was investigated to measure any radiated emissions in the restricted bands. The following tables show measurements of any emissions that fell into the restricted bands of §15.205. The tables show the worst-case emissions measured from the EUT. For frequencies above 18.0 GHz, a measurement distance of 1 meter was used. For frequencies between 1 GHz and 18 GHz, a measurement distance of 3 meters was used. For frequencies below 1 GHz, a measurement distance of 10 meters was used. The noise floor was a minimum of 6 dB below the limits. The emissions in the restricted bands must meet the limits specified in §15.209. Tabular data for each of the spurious emissions is shown below for each of the units. No spurious emissions from 17 to 26 GHz were observed. Plots of the band edges are also shown in the annex. When performing measurements at a distance other than that specified, the results have been extrapolated to the specified distance using an extrapolation factor of 20 dB/decade (inverse linear-distance for field strength measurements) e.g $20\log(3\text{m}/10\text{m}) = -10.45$

Result

All emissions in the restricted bands of §15.205 met the limits specified in §15.209; therefore, the EUT complies with the specification.

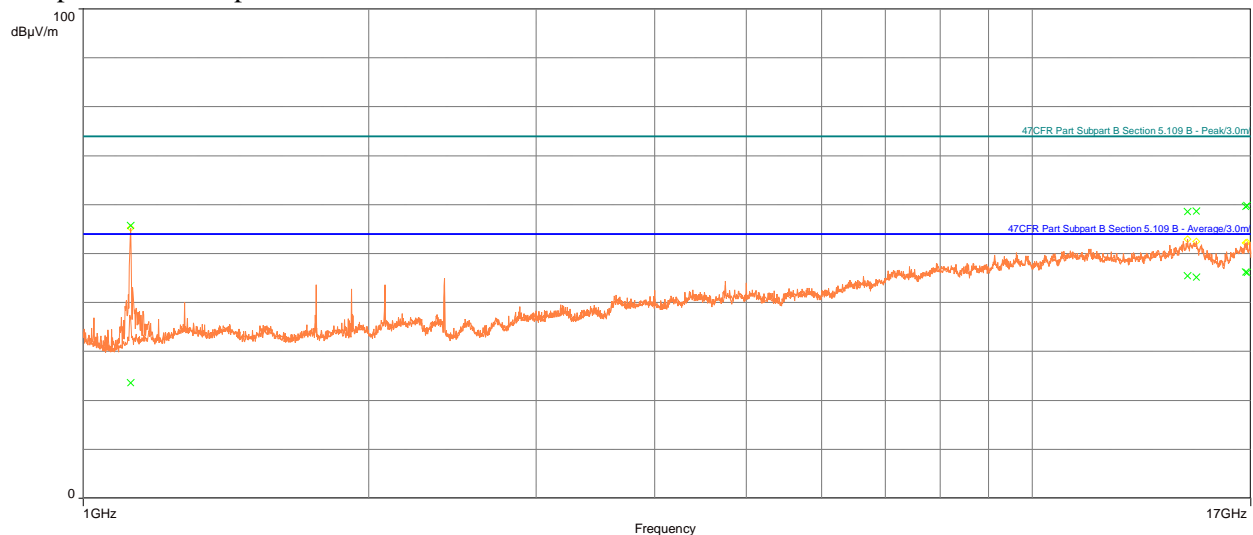

Avg

Frequency (MHz)	Level (dBµV/m)	Limit (dBµV/m)	Margin (dB)	Azimuth (°)	Height (m)	Pol.	Correction (dB)
14579	45.44	54.00	-8.56	289.00	2.51	Vertical	17.61
16855	46.12	54.00	-7.88	308.00	1.65	Vertical	19.14
1121.9	23.58	54.00	-30.42	129.00	3.35	Horizontal	-12.63
14902	45.20	54.00	-8.80	8.00	1.50	Horizontal	17.60

16800	46.19	54.00	-7.81	323.00	3.25	Horizontal	18.71
-------	-------	-------	-------	--------	------	------------	-------

Peak

14579	58.53	74.00	-15.47	289.00	2.51	Vertical	17.61
16855	59.79	74.00	-14.21	308.00	1.65	Vertical	19.14
1121.9	55.72	74.00	-18.28	129.00	3.35	Horizontal	-12.63
14902	58.66	74.00	-15.34	8.00	1.50	Horizontal	17.60
16800	59.64	74.00	-14.36	323.00	3.25	Horizontal	18.71

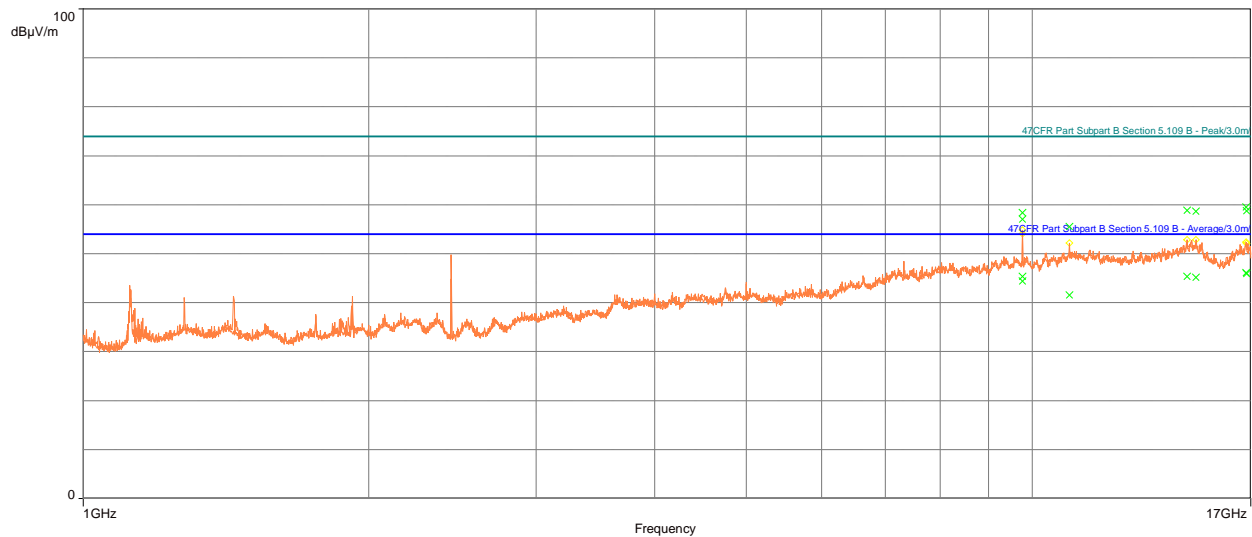
Table 4: Transmitting at the Lowest Frequency

Avg

Frequency (MHz)	Level (dBµV/m)	Limit (dBµV/m)	Margin (dB)	Azimuth (°)	Height (m)	Pol.	Correction (dB)
9769.1	45.34	54.00	-8.66	62.00	3.22	Vertical	11.66
10950	41.52	54.00	-12.48	336.00	1.92	Vertical	13.86
14882	45.17	54.00	-8.83	222.00	2.99	Vertical	17.45
16803	46.13	54.00	-7.87	28.00	3.11	Vertical	18.67
9767.4	44.43	54.00	-9.57	104.00	2.27	Horizontal	11.66
14569	45.33	54.00	-8.67	1.00	2.00	Horizontal	17.51
16821	45.90	54.00	-8.10	9.00	2.91	Horizontal	18.59

Peak

9769.1	58.38	74.00	-15.62	62.00	3.22	Vertical	11.66
10950	55.53	74.00	-18.47	336.00	1.92	Vertical	13.86
14882	58.70	74.00	-15.30	222.00	2.99	Vertical	17.45
16803	59.47	74.00	-14.53	28.00	3.11	Vertical	18.67
9767.4	57.05	74.00	-16.95	104.00	2.27	Horizontal	11.66
14569	58.83	74.00	-15.17	1.00	2.00	Horizontal	17.51
16821	58.79	74.00	-15.21	9.00	2.91	Horizontal	18.59

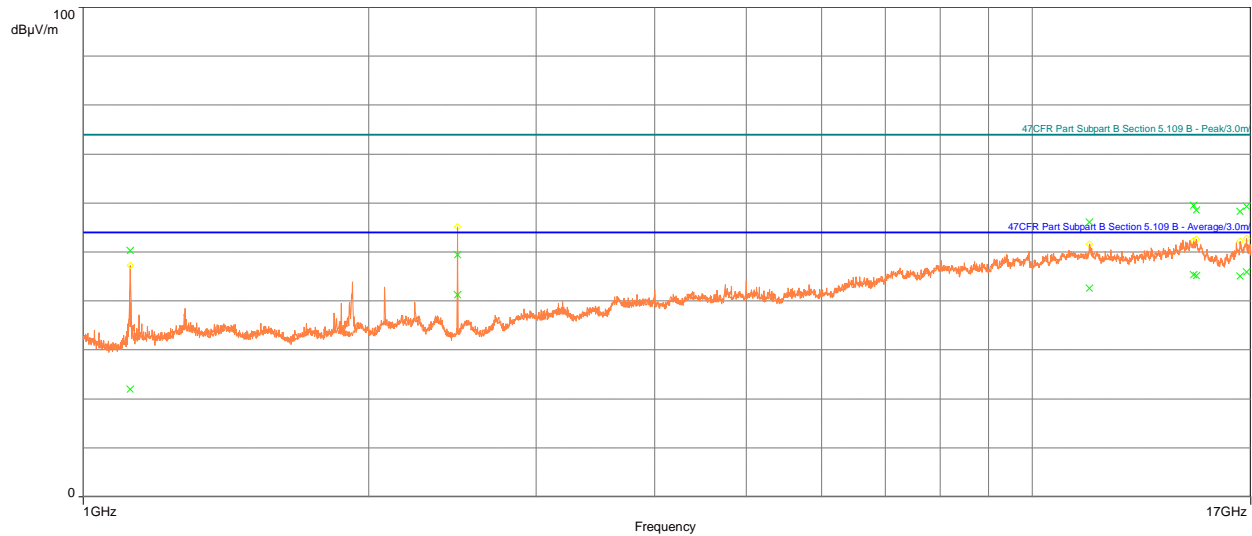
Table 5: Transmitting at the Middle Frequency

Avg

Frequency (MHz)	Level (dBµV/m)	Limit (dBµV/m)	Margin (dB)	Azimuth (°)	Height (m)	Pol.	Correction (dB)
1120.6	21.94	54.00	-32.06	5.00	3.94	Vertical	-12.65
2480.3	41.31	54.00	-12.69	55.00	1.62	Vertical	-6.30
14902	45.18	54.00	-8.82	202.00	1.87	Vertical	17.60
16564	45.03	54.00	-8.97	190.00	2.72	Vertical	17.64
11499	42.60	54.00	-11.40	140.00	3.46	Horizontal	14.99
14798	45.39	54.00	-8.61	134.00	3.43	Horizontal	17.83
16820	45.90	54.00	-8.10	345.00	2.12	Horizontal	18.60

Peak

1120.6	50.29	74.00	-23.71	5.00	3.94	Vertical	-12.65
2480.3	49.42	74.00	-24.58	55.00	1.62	Vertical	-6.30
14902	58.54	74.00	-15.46	202.00	1.87	Vertical	17.60
16564	58.24	74.00	-15.76	190.00	2.72	Vertical	17.64
11499	56.07	74.00	-17.93	140.00	3.46	Horizontal	14.99
14798	59.54	74.00	-14.46	134.00	3.43	Horizontal	17.83
16820	59.34	74.00	-14.66	345.00	2.12	Horizontal	18.60

Table 6: Transmitting at the Highest Frequency

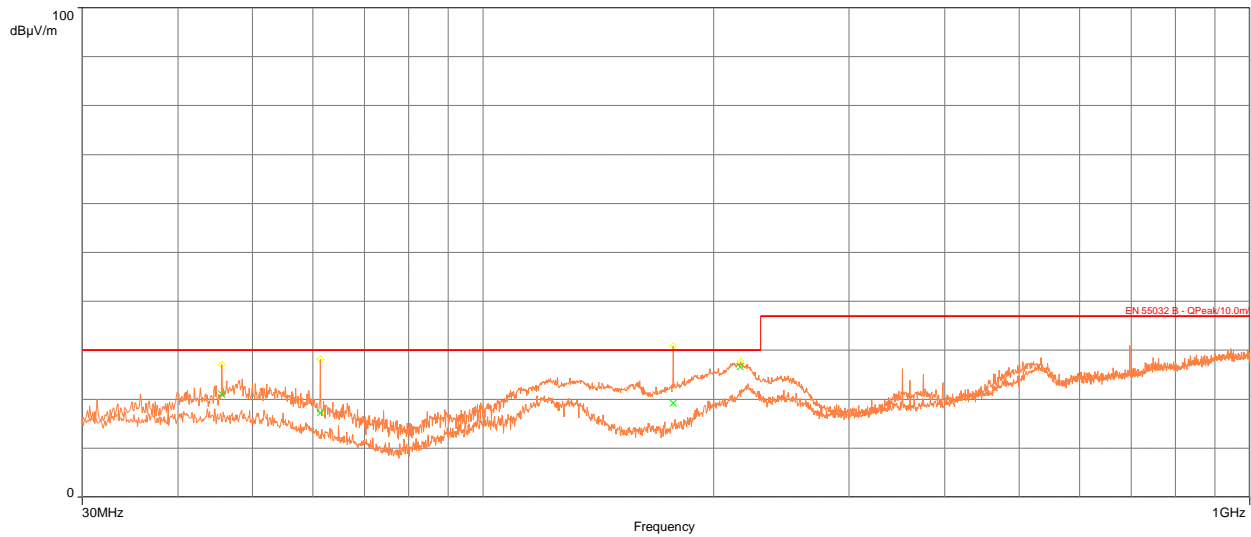

Frequency (MHz)	Level (dBµV/m)	Limit (dBµV/m)	Margin (dB)	Azimuth (°)	Height (m)	Pol.	Correction (dB)
45.661	21.03	30.00	-8.97	359.00	1.61	Vertical	-11.29
61.367	17.20	30.00	-12.80	304.00	1.54	Vertical	-14.33
177.1	19.19	30.00	-10.81	335.00	1.14	Vertical	-16.37
216.51	26.58	30.00	-3.42	359.00	1.12	Vertical	-14.49

Table 7: Transmitting at the Middle Frequency (worst case)

5.8 §15.247(e) Maximum Average Power Spectral Density

The maximum average power spectral density conducted from the intentional radiator of the antenna shall not be greater than 8 dBm in any 3 kHz band during any time interval of continuous transmission. Results of this testing are summarized.

Frequency (MHz)	Measurement (dBm)	Criteria (dBm)
2402	-3.4	8.0
2442	-2	8.0
2480	-2.2	8.0

Result

The maximum average power spectral density was less than the limit of 8 dBm; therefore, the EUT complies with the specification.

-- End of Test Report --