

FCC Test Report

Report No.: RFBFPJ-WTW-P20110897

FCC ID: SWX-UBBXG

Test Model: UBB-XG

Received Date: Dec. 02, 2020

Test Date: Dec. 05 to 08, 2020

Issued Date: Jan. 21, 2021

Applicant: Ubiquiti Inc.

Address: 685 Third Avenue, New York, New York 10017 USA

Issued By: Bureau Veritas Consumer Products Services (H.K.) Ltd., Taoyuan Branch
Hsin Chu Laboratory

Lab Address: E-2, No.1, Li Hsin 1st Road, Hsinchu Science Park, Hsinchu City 300,
Taiwan

Test Location : E-2, No.1, Li Hsin 1st Road, Hsinchu Science Park, Hsinchu City 300,
Taiwan

**FCC Registration /
Designation Number:** 723255 / TW2022 for Test Location



This report is for your exclusive use. Any copying or replication of this report to or for any other person or entity, or use of our name or trademark, is permitted only with our prior written permission. This report sets forth our findings solely with respect to the test samples identified herein. The results set forth in this report are not indicative or representative of the quality or characteristics of the lot from which a test sample was taken or any similar or identical product unless specifically and expressly noted. Our report includes all of the tests requested by you and the results thereof based upon the information that you provided to us. You have 60 days from date of issuance of this report to notify us of any material error or omission caused by our negligence, provided, however, that such notice shall be in writing and shall specifically address the issue you wish to raise. A failure to raise such issue within the prescribed time shall constitute your unqualified acceptance of the completeness of this report, the tests conducted and the correctness of the report contents. Unless specifically mentioned, the uncertainty of measurement has been explicitly taken into account to declare the compliance or non-compliance to the specification.

Table of Contents

Release Control Record	4
1 Certificate of Conformity	5
2 Summary of Test Results	6
2.1 Measurement Uncertainty	6
2.2 Modification Record	6
3 General Information	7
3.1 General Description of EUT	7
3.2 Description of Test Modes	8
3.2.1 Test Mode Applicability and Tested Channel Detail	9
3.3 Description of Support Units	11
3.3.1 Configuration of System under Test	12
3.4 General Description of Applied Standards	14
4 Test Types and Results	15
4.1 Radiated Emission Measurement	15
4.1.1 Limits of Radiated Emission Measurement	15
4.1.2 Test Instruments	16
4.1.3 Test Procedures	19
4.1.4 Deviation from Test Standard	20
4.1.5 Test Setup	21
4.1.6 EUT Operating Conditions	22
4.1.7 Test Results	23
4.2 Conducted Emission Measurement	55
4.2.1 Limits of Conducted Emission Measurement	55
4.2.2 Test Instruments	55
4.2.3 Test Procedures	56
4.2.4 Deviation from Test Standard	56
4.2.5 Test Setup	56
4.2.6 EUT Operating Conditions	56
4.2.7 Test Results	57
4.3 6dB Bandwidth Measurement	65
4.3.1 Limits of 6dB Bandwidth Measurement	65
4.3.2 Test Setup	65
4.3.3 Test Instruments	65
4.3.4 Test Procedure	65
4.3.5 Deviation from Test Standard	65
4.3.6 EUT Operating Conditions	65
4.3.7 Test Result	66
4.4 Output Power Measurement	67
4.4.1 Limits of Output Power Measurement	67
4.4.2 Test Setup	68
4.4.3 Test Instruments	68
4.4.4 Test Procedures	69
4.4.5 Deviation from Test Standard	69
4.4.6 EUT Operating Conditions	69
4.4.7 Test Results	70
4.5 Frequency Stability Measurement	71
4.5.1 Limits of Frequency Stability Measurement	71
4.5.2 Test Setup	71
4.5.3 Test Instruments	72
4.5.4 Test Procedure	72
4.5.5 Deviation from Test Standard	72
4.5.6 EUT Operating Condition	72
4.5.7 Test Results	73

5	Pictures of Test Arrangements.....	74
	Appendix – Information of the Testing Laboratories	75

Release Control Record

Issue No.	Description	Date Issued
RFBFPJ-WTW-P20110897	Original release.	Jan. 21, 2021

1 Certificate of Conformity

Product: UniFi Network Building Bridge XG

Brand: UBIQUITI

Test Model: UBB-XG

Sample Status: Engineering sample

Applicant: Ubiquiti Inc.

Test Date: Dec. 05 to 08, 2020

Standards: 47 CFR FCC Part 15, Subpart C (Section 15.255)
ANSI C63.10: 2013

The above equipment has been tested by **Bureau Veritas Consumer Products Services (H.K.) Ltd., Taoyuan Branch**, and found compliance with the requirement of the above standards. The test record, data evaluation & Equipment Under Test (EUT) configurations represented herein are true and accurate accounts of the measurements of the sample's EMC characteristics under the conditions specified in this report.

Prepared by : Joyce Kuo , **Date:** Jan. 21, 2021
Joyce Kuo / Specialist

Approved by : Clark Lin , **Date:** Jan. 21, 2021
Clark Lin / Technical Manager

2 Summary of Test Results

47 CFR FCC Part 15, Subpart C (Section 15.255)			
FCC Clause	Test Item	Result	Remarks
15.207	AC Power Conducted Emission	Pass	Meet the requirement of limit. Minimum passing margin is -3.84 dB at 0.52500 MHz.
15.255(e)	6dB Bandwidth	-	Reference only.
15.255 (c) & (e)	Output Power	Pass	Meet the requirement of limit.
15.255(d)	Spurious Emissions	Pass	Meet the requirement of limit. Minimum passing margin is -3.9 dB at 17968.18 MHz, 17967.32 MHz.
15.255(f)	Frequency Stability	Pass	Meet the requirement of limit.

Note:

Determining compliance based on the results of the compliance measurement, not taking into account measurement instrumentation uncertainty.

2.1 Measurement Uncertainty

Where relevant, the following measurement uncertainty levels have been estimated for tests performed on the EUT as specified in CISPR 16-4-2:

Measurement	Frequency	Expanded Uncertainty (k=2) (\pm)
Conducted Emissions at mains ports	150kHz ~ 30MHz	1.9 dB
Radiated Emissions up to 1 GHz	9kHz ~ 30MHz	3.1 dB
	30MHz ~ 1GHz	5.4 dB
Radiated Emissions above 1 GHz	1GHz ~ 18GHz	5.0 dB
	18GHz ~ 40GHz	5.3 dB

2.2 Modification Record

There were no modifications required for compliance.

3 General Information

3.1 General Description of EUT

Product	UniFi Network Building Bridge XG
Brand	UBIQUITI
Test Model	UBB-XG
Status of EUT	Engineering sample
Power Supply Method	48 Vdc from PoE
Modulation Type	$\pi/2$ -BPSK, $\pi/2$ -QPSK, $\pi/2$ -16QAM
Modulation Technology	OFDM
Transfer Rate	4620 Mbps
Operating Frequency	57 ~ 71 GHz
Output Power (EIRP)	58.32 GHz: 38.80 dBm 60.48 GHz: 39.92 dBm 62.64 GHz: 40.20 dBm 64.80 GHz: 38.88 dBm
Antenna Type	Refer to Note
Antenna Connector	Refer to Note
Accessory Device	PoE Adapter x 1, power cord x1
Data Cable Supplied	NA

Note:

1. The EUT has below radios as following table:

Radio 1	Radio 2	Radio 3
WLAN(5GHz) + BT LE	WiGig (60GHz)	GPS

2. Simultaneously transmission condition.

Condition	Technology	
1	WLAN(5GHz) + BT LE	WiGig (60GHz)

Note: The emission of the simultaneous operation has been evaluated and no non-compliance was found.

3. The EUT must be supplied with a PoE adapter as following table:

Brand	Model No.	Spec.
UBIQUITI	GP-H480-065G	AC Input: 100-240 Vac, 0.75A MAX, 50/60Hz DC Output: 48 Vdc, 0.65A AC Input Cable: Unshielded, 0.6m

4. The antennas type and connector type, please refer to the following table:

Antenna No.	Antenna Net Gain (dBi)	Frequency Range	Antenna Type	Connector Type
WiGig (60GHz)	22	57-71GHz	integral	None
WLAN(5GHz)	14	5150~5850MHz	internal	None
BT	2.5	2.4~2.4835GHz	internal	None

5. The above EUT information is declared by manufacturer and for more detailed features description, please refer to the manufacturer's specifications or user's manual.

6. The above Antenna information is declared by manufacturer and for more detailed features description, please refer to the manufacturer's specifications, the laboratory shall not be held responsible.

3.2 Description of Test Modes

4 channels are provided for EUT.

Channel's Number	1	2	3	4
Frequency (MHz)	58320	60480	62640	64800

3.2.1 Test Mode Applicability and Tested Channel Detail

EUT CONFIGURE MODE	APPLICABLE TO						DESCRIPTION
	PLC	BW	OP	FS	RE < 1G	RE ≥ 1G	
-	√	√	√	√	√	√	-

Where **PLC**: Power Line Conducted Emission **BW**: 6dB Bandwidth
OP: Output Power **FS**: Frequency Stability
RE < 1G: Radiated Emission below 1GHz **RE ≥ 1G**: Radiated Emission above 1GHz

Power Line Conducted Emission Test:

- Pre-Scan has been conducted to determine the worst-case mode from all possible combinations between available modulations, data rates and antenna ports (if EUT with antenna diversity architecture).
- Following channel(s) was (were) selected for the final test as listed below.

AVAILABLE CHANNEL	TESTED CHANNEL	MODULATION TECHNOLOGY	MODULATION TYPE	DATA RATE (Mbps)
1 to 4	1, 2, 3, 4	OFDM	$\pi/2$ -BPSK	385

6dB Bandwidth Test:

- Pre-Scan has been conducted to determine the worst-case mode from all possible combinations between available modulations, data rates and antenna ports (if EUT with antenna diversity architecture).
- Following channel(s) was (were) selected for the final test as listed below.

AVAILABLE CHANNEL	TESTED CHANNEL	MODULATION TECHNOLOGY	MODULATION TYPE	DATA RATE (Mbps)
1 to 4	1, 2, 3, 4	OFDM	$\pi/2$ -BPSK	385

Output Power Measurement:

- Pre-Scan has been conducted to determine the worst-case mode from all possible combinations between available modulations, data rates and antenna ports (if EUT with antenna diversity architecture).
- Following channel(s) was (were) selected for the final test as listed below.

AVAILABLE CHANNEL	TESTED CHANNEL	MODULATION TECHNOLOGY	MODULATION TYPE	DATA RATE (Mbps)
1 to 4	1, 2, 3, 4	OFDM	$\pi/2$ -BPSK	385

Frequency Stability Test:

- Following channel(s) was (were) selected for the final test as listed below.

AVAILABLE CHANNEL	TESTED CHANNEL	MODULATION TECHNOLOGY	MODULATION TYPE	DATA RATE (Mbps)
1 to 4	1	OFDM	$\pi/2$ -BPSK	385

Radiated Emission Test (Below 1GHz):

- Pre-Scan has been conducted to determine the worst-case mode from all possible combinations between available modulations, data rates and antenna ports (if EUT with antenna diversity architecture).
- Following channel(s) was (were) selected for the final test as listed below.

AVAILABLE CHANNEL	TESTED CHANNEL	MODULATION TECHNOLOGY	MODULATION TYPE	DATA RATE (Mbps)
1 to 4	1, 2, 3, 4	OFDM	$\pi/2$ -BPSK	385

Radiated Emission Test (Above 1GHz):

- Pre-Scan has been conducted to determine the worst-case mode from all possible combinations between available modulations, data rates and antenna ports (if EUT with antenna diversity architecture).
- Following channel(s) was (were) selected for the final test as listed below.

AVAILABLE CHANNEL	TESTED CHANNEL	MODULATION TECHNOLOGY	MODULATION TYPE	DATA RATE (Mbps)
1 to 4	1, 2, 3, 4	OFDM	$\pi/2$ -BPSK	385

Test Condition:

APPLICABLE TO	ENVIRONMENTAL CONDITIONS	INPUT POWER	TESTED BY
PLC	25 deg. C, 75 %RH	120Vac, 60Hz	Ryan Du
BW	23 deg. C, 62 %RH	120Vac, 60Hz	Sampson Chen
OP	25 deg. C, 66 %RH	120Vac, 60Hz	Sampson Chen
FS	23 deg. C, 62 %RH	120Vac, 60Hz	Sampson Chen
RE<1G	25 deg. C, 69 %RH	120Vac, 60Hz	Ryan Du
RE≥1G	25 deg. C, 69 %RH	120Vac, 60Hz	Ryan Du

3.3 Description of Support Units

The EUT has been tested as an independent unit together with other necessary accessories or support units. The following support units or accessories were used to form a representative test configuration during the tests.

ID	Product	Brand	Model No.	Serial No.	FCC ID	Remarks
A.	Laptop	DELL	E5430	HYV4VY1	FCC DoC	Provided by Lab

Note:

1. All power cords of the above support units are non-shielded (1.8m).

ID	Descriptions	Qty.	Length (m)	Shielding (Yes/No)	Cores (Qty.)	Remarks
1.	RJ-45 Cable	1	3	No	0	Provided by Lab
2.	RJ-45 Cable	1	10	No	0	Provided by Lab
3.	AC Cable	1	0.6	No	0	Supplied by client
4.	Fiber Cable	1	10	Yes	0	Provided by Lab

3.3.1 Configuration of System under Test

For Power Line Conducted Emission Test:

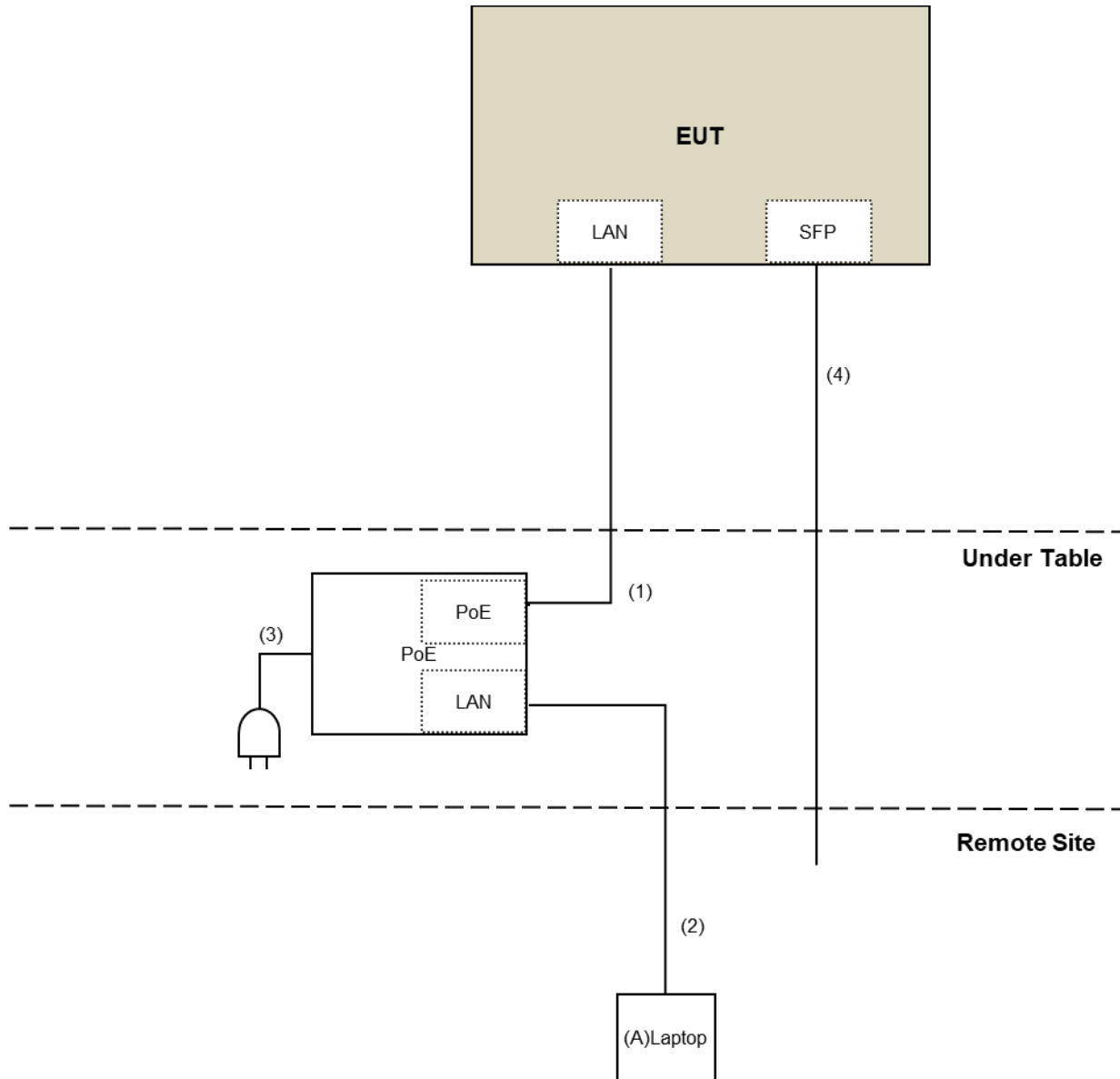

For Radiated Emission Test:

:

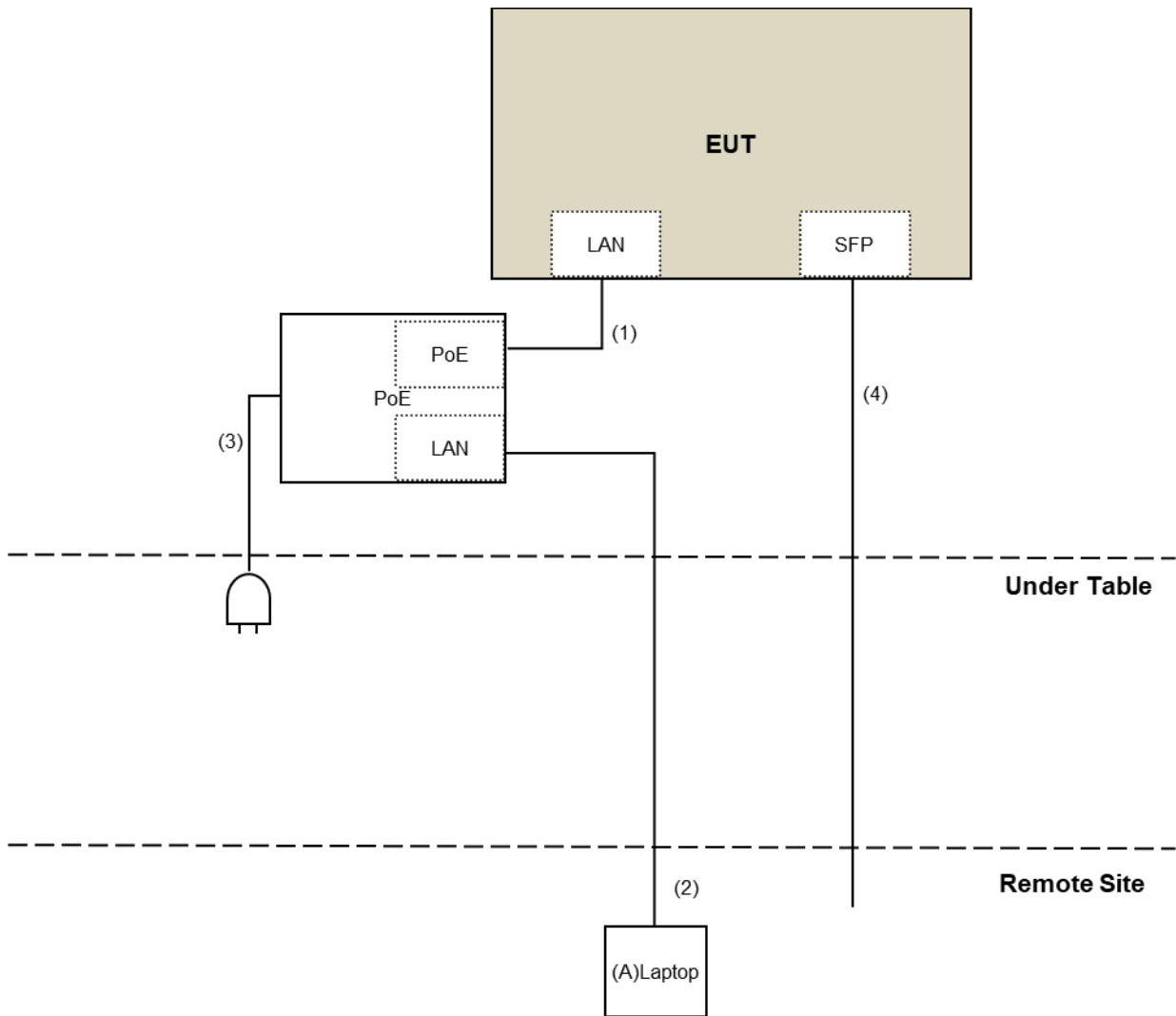

3.4 General Description of Applied Standards

The EUT is a RF Product. According to the specifications of the manufacturer, it must comply with the requirements of the following standards:

FCC Part 15, Subpart C (15.255)

ANSI C63.10-2013

All test items have been performed and recorded as per the above standards.

4 Test Types and Results

4.1 Radiated Emission Measurement

4.1.1 Limits of Radiated Emission Measurement

Spurious Emission	
Frequency Range	Limitation
Radiated emissions below 40GHz	Part 15.209
Between 40GHz and 200GHz	90pW/cm ² (at 3 meter)

Note:
The levels of the spurious emissions shall not exceed the level of the fundamental emission

Emissions radiated outside of the specified bands, shall be according to the general radiated limits in 15.209 as following:

Frequencies (MHz)	Field strength (microvolts/meter)	Measurement distance (meters)
0.009-0.490	2400/F(kHz)	300
0.490-1.705	24000/F(kHz)	30
1.705-30.0	30	30
30-88	100	3
88-216	150	3
216-960	200	3
Above 960	500	3

Note:

1. The lower limit shall apply at the transition frequencies.
2. Emission level (dBuV/m) = 20 log Emission level (uV/m).
3. As shown in 15.35(b), for frequencies above 1000MHz, the field strength limits are based on average detector, however, the peak field strength of any emission shall not exceed the maximum permitted average limits, specified above by more than 20dB under any condition of modulation.
4. Section 15.205 restricted bands of operation shall compliance with the limits in Section 15.209.

4.1.2 Test Instruments

For Below 40GHz:

DESCRIPTION & MANUFACTURER	MODEL NO.	SERIAL NO.	CALIBRATED DATE	CALIBRATED UNTIL
Test Receiver Keysight	N9038A	MY54450088	July 06, 2020	July 05, 2021
Pre-Amplifier EMCI	EMC001340	980142	May 25, 2020	May 24, 2021
Loop Antenna Electro-Metrics	EM-6879	264	Feb. 18, 2020	Feb. 17, 2021
RF Cable	NA	LOOPCAB-001	Jan. 08, 2020	Jan. 07, 2021
RF Cable	NA	LOOPCAB-002	Jan. 08, 2020	Jan. 07, 2021
Pre-Amplifier Mini-Circuits	ZFL-1000VH2B	AMP-ZFL-05	Apr. 28, 2020	Apr. 27, 2021
Trilog Broadband Antenna SCHWARZBECK	VULB 9168	9168-361	Nov. 05, 2020	Nov. 04, 2021
RF Cable	8D	966-3-1	Mar. 17, 2020	Mar. 16, 2021
RF Cable	8D	966-3-2	Mar. 17, 2020	Mar. 16, 2021
RF Cable	8D	966-3-3	Mar. 17, 2020	Mar. 16, 2021
Fixed attenuator Mini-Circuits	UNAT-5+	PAD-3m-3-01	Sep. 24, 2020	Sep. 23, 2021
Horn_Antenna SCHWARZBECK	BBHA9120-D	9120D-406	Nov. 22, 2020	Nov. 21, 2021
Pre-Amplifier EMCI	EMC12630SE	980384	Jan. 15, 2020	Jan. 14, 2021
RF Cable	EMC104-SM-SM-1500	180504	Apr. 29, 2020	Apr. 28, 2021
RF Cable	EMC104-SM-SM-2000	180601	June 09, 2020	June 08, 2021
RF Cable	EMC104-SM-SM-6000	180602	June 09, 2020	June 08, 2021
Spectrum Analyzer Keysight	N9030A	MY54490679	July 13, 2020	July 12, 2021
Pre-Amplifier EMCI	EMC184045SE	980387	Jan. 15, 2020	Jan. 14, 2021
Horn_Antenna SCHWARZBECK	BBHA 9170	BBHA9170519	Nov. 22, 2020	Nov. 21, 2021
RF Cable	EMC102-KM-KM-1200	160924	Jan. 15, 2020	Jan. 14, 2021
RF Cable	EMC-KM-KM-4000	200214	Mar. 11, 2020	Mar. 10, 2021
Software	ADT_Radiated_V8.7.08	NA	NA	NA
Antenna Tower & Turn Table Max-Full	MF-7802	MF780208406	NA	NA
Boresight Antenna Fixture	FBA-01	FBA-SIP01	NA	NA

Note:

1. The calibration interval of the above test instruments is 12 months and the calibrations are traceable to NML/ROC and NIST/USA.
2. The test was performed in 966 Chamber No. 3.
3. Tested Date: Dec. 05, 2020

For Above 40GHz:

DESCRIPTION & MANUFACTURER	MODEL NO.	SERIAL NO.	CALIBRATED DATE	CALIBRATED UNTIL
Spectrum Analyzer Keysight	N9030A	MY55330160	Feb. 07, 2020	Feb. 06, 2021
*OXE89 Horn Antenna (33~55GHz) QuinStar	QWH-UCRR00	924200002	Jan. 20, 2020	Jan. 19, 2022
*Conical Horn Antenna (50~75GHz) Keysight	WR15CH-Conical	WR15CH_001	Jan. 20, 2020	Jan. 19, 2022
*Conical Horn Antenna (75~110GHz) Keysight	WR10CH-Conical	WR10CH_001	Jan. 20, 2020	Jan. 19, 2022
*Conical Horn Antenna (110~170GHz) Keysight	WR6.5CH-Conical	WR6.5CH_001	Jan. 20, 2020	Jan. 19, 2022
*Conical Horn Antenna (140~220GHz) Keysight	WR5.1CH-Conical	WR5.1CH_001	Dec. 09, 2019	Dec. 08, 2021
N9029AV15-DC9 - 50-75 GHz VDI Standard Downconverter with 9VDC supply Keysight	SA Extension WR15	SAX 381	CoC	CoC
N9029AV10-DC9 - 75-110 GHz VDI Standard Downconverter with 9VDC supply Keysight	SA Extension WR10	SAX 378	CoC	CoC
N9029AV06-DC9 - 110-170 GHz VDI Standard Downconverter with 9VDC supply Keysight	SA Extension WR6.5	SAX 377	CoC	CoC
*N9029AV05-DC9 - 140-220 GHz VDI Standard Downconverter with 9VDC supply Keysight	SA Extension WR5.1	SAX 375	Dec. 09, 2019	Dec. 08, 2021
Millimeter-Wave Signal Generator Frequency Extension Module (50~75 GHz) Keysight	E8257DV15	SGX 050	CoC	CoC
Millimeter-Wave Signal Generator Frequency Extension Module (75~110 GHz) Keysight	E8257DV10	SGX 069	CoC	CoC
Millimeter-Wave Signal Generator Frequency Extension Module (110~170 GHz) Keysight	E8257DV06-DC9	SGX 223	CoC	CoC
PSG analog signal generator Keysight	E8257D	MY53401987	June 17, 2020	June 16, 2021

*Power Meter VDI	PM5	431V	Dec. 09, 2019	Dec. 08, 2021
Boresight Antenna Tower & Turn Table Max-Full	MF-7802BS	MF780208530	NA	NA
**Zero-Bias Detector (50~75GHz) Vdi	WR15ZBD	WR15R5 1-30	CoC	CoC
4CH Infiniivision Oscilloscope Keysight	DSOX6004A	MY55190202	July 03, 2020	July 02, 2021

Note:

1. The calibration interval of the above test instruments is 12 months and the calibrations are traceable to NML/ROC and NIST/USA.
2. *The calibration interval of the above test instruments is 24 months and the calibrations are traceable to NML/ROC and NIST/USA.
3. **The calibration interval of the above test instruments is 36 months and the calibrations are traceable to NML/ROC and NIST/USA.
4. Certificate of Conformance (CoC) which is issued by manufacturer states that the product meets the specification.
5. The test was performed in 966 Chamber No. 3.
6. Tested Date: Dec. 05, 2020

4.1.3 Test Procedures

For Radiated emission below 30MHz

- a. The EUT was placed on the top of a rotating table 0.8 meters above the ground at a 3 meter chamber room. The table was rotated 360 degrees to determine the position of the highest radiation.
- b. The EUT was set 3 meters away from the interference-receiving antenna, which was mounted on the top of a variable-height antenna tower.
- c. Parallel, perpendicular, and ground-parallel orientations of the antenna are set to make the measurement.
- d. For each suspected emission, the EUT was arranged to its worst case and the rotatable table was turned from 0 degrees to 360 degrees to find the maximum reading.
- e. The test-receiver system was set to Quasi-Peak Detect Function and Specified Bandwidth with Maximum Hold Mode.

Note:

1. The resolution bandwidth and video bandwidth of test receiver/spectrum analyzer is 9kHz at frequency below 30MHz.

For Radiated emission 30MHz to 40GHz

- a. The EUT was placed on the top of a rotating table 0.8 meters (for 30MHz ~ 1GHz) / 1.5 meters (for above 1GHz) above the ground at 3 meter chamber room for test. The table was rotated 360 degrees to determine the position of the highest radiation.
- b. The EUT was set 3 meters away from the interference-receiving antenna, which was mounted on the top of a variable-height antenna tower.
- c. The height of antenna is varied from one meter to four meters above the ground to determine the maximum value of the field strength. Both horizontal and vertical polarizations of the antenna are set to make the measurement.
- d. For each suspected emission, the EUT was arranged to its worst case and then the antenna was tuned to heights from 1 meter to 4 meters and the rotatable table was turned from 0 degrees to 360 degrees to find the maximum reading.
- e. The test-receiver system was set to quasi-peak detect function and specified bandwidth with maximum hold mode when the test frequency is below 1 GHz.
- f. The test-receiver system was set to peak and average detects function and specified bandwidth with maximum hold mode when the test frequency is above 1 GHz. If the peak reading value also meets average limit, measurement with the average detector is unnecessary.

Note:

1. The resolution bandwidth and video bandwidth of test receiver/spectrum analyzer is 120kHz for Quasi-peak detection (QP) at frequency below 1GHz.
2. The resolution bandwidth of test receiver/spectrum analyzer is 1 MHz and the video bandwidth is 3 MHz for Peak detection (PK) and Average detection (AV) at frequency above 1GHz.
3. All modes of operation were investigated and the worst-case emissions are reported.

For Radiated emission above 40GHz

- a. Connect the test antenna covering the appropriate frequency range to a spectrum analyzer via an external mixer to the spectrum analyzer.
- b. Set spectrum analyzer RBW = 1 MHz, VBW = 3 MHz, average detector.
- c. Calculate the distance to the far field boundary and determine the maximum measurement distance.
- d. Perform an exploratory search for emissions and determine the approximate direction at which each observed emission emanates from the EUT.
- e. Exploratory measurements be made at a closer distance than the validated maximum measurement distance.
- f. Perform a final measurement; begin with the test antenna at the approximate position where the maximum level occurred during the exploratory scan.
- g. Slowly scan the test antenna around this position, slowly vary the test antenna polarization by rotating through at least 0° to 180°, and slowly vary the orientation of the test antenna to find the final position, polarization, and orientation at which the maximum level of the emission is observed.
- h. Record the measured reading with the test antenna fixed at this maximized position, polarization, and orientation. Record the measurement distance.
- i. Calculate the maximum field strength of the emission at the measurement distance and the adjusted/corrected power at the output of the test antenna.
- j. Calculate the EIRP from the measured field strength and then convert to the linear.
- k. Calculate the power density at the distance specified by the limit from the field strength at the distance specified by the limit.
- l. Repeat the preceding sequence for every emission observed in the frequency band under investigation.

4.1.4 Deviation from Test Standard

No deviation.

4.1.5 Test Setup

For Radiated emission below 30MHz

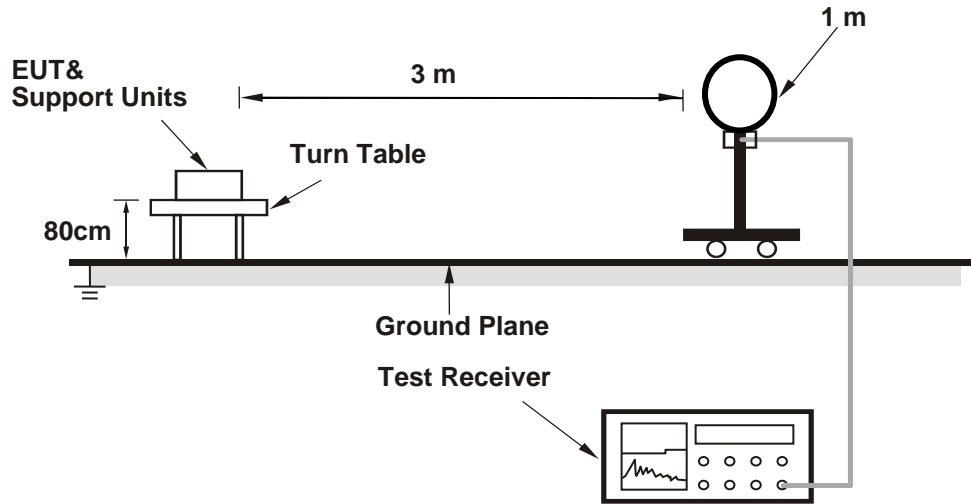

For Radiated emission 30MHz to 1GHz

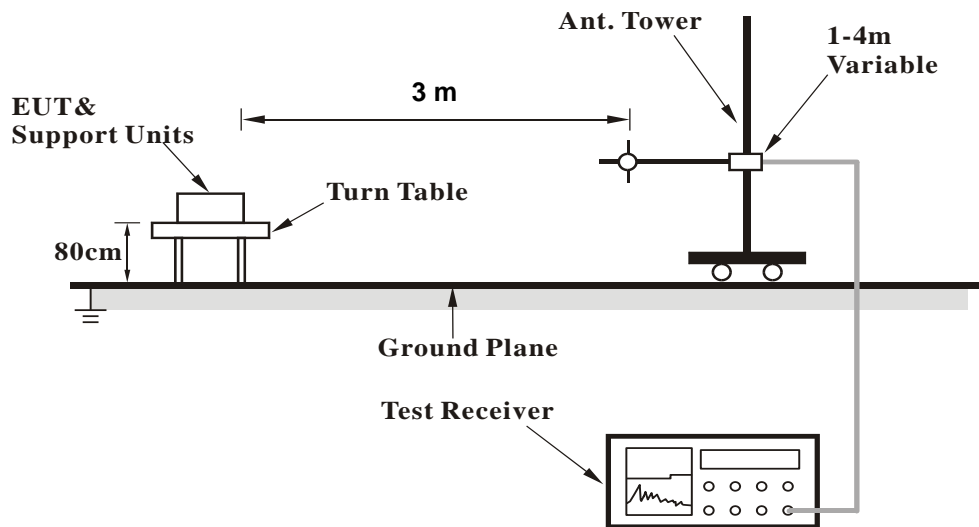

For Radiated emission 1GHz to 50GHz

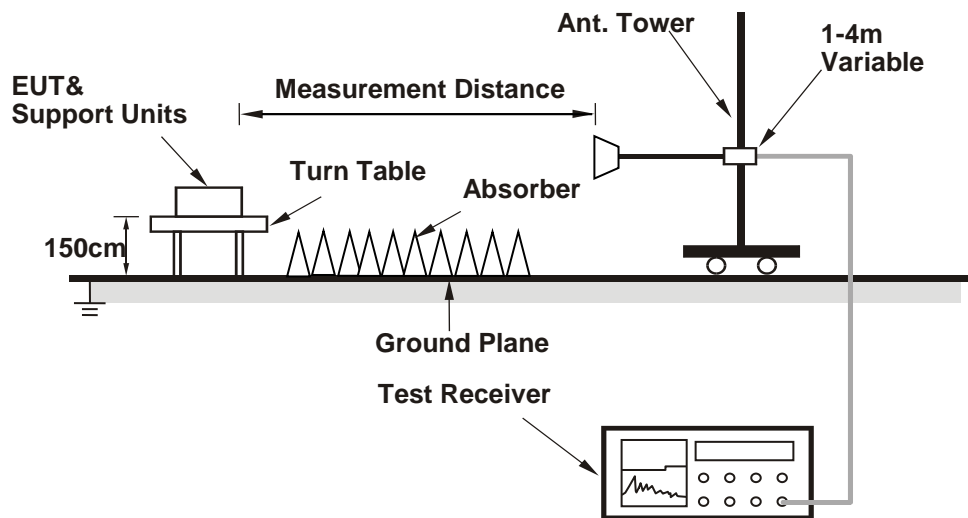

For Radiated emission above 50GHz

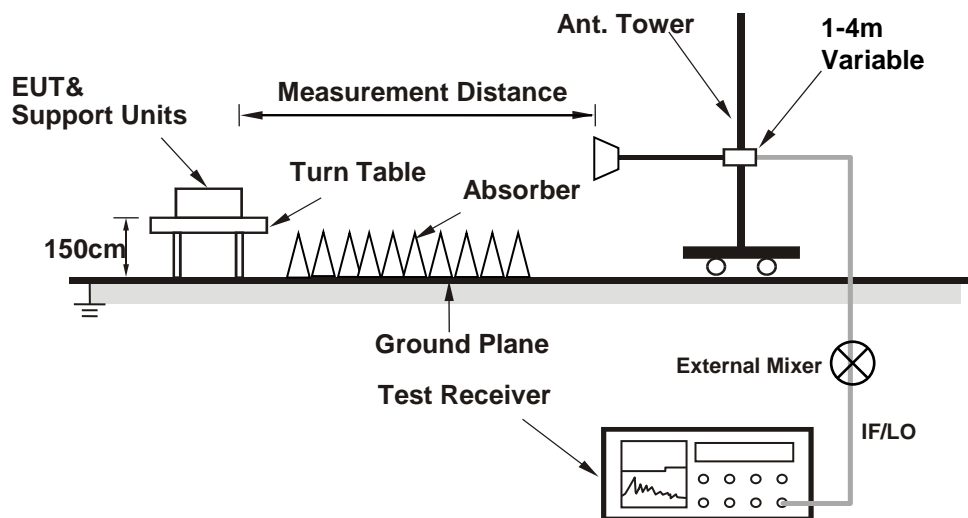

For the actual test configuration, please refer to the attached file (Test Setup Photo).

4.1.6 EUT Operating Conditions

- Placed the EUT on the testing table.
- Controlling software (Qualcomm Radio Control Toolkit v4.0-00158) has been activated to set the EUT under transmission condition continuously at specific channel frequency.

4.1.7 Test Results

Above 1GHz Data:
For 1~18 GHz

Channel	CH 1 : 58.32 GHz		
Frequency Range	1GHz ~ 18GHz	Detector Function	Peak (PK) Average (AV)

Antenna Polarity & Test Distance : Horizontal at 3 m								
No	Frequency (MHz)	Emission Level (dBuV/m)	Limit (dBuV/m)	Margin (dB)	Antenna Height (m)	Table Angle (Degree)	Raw Value (dBuV)	Correction Factor (dB/m)
1	#2426.25	44.1 PK	74.0	-29.9	1.50 H	228	45.6	-1.5
2	#2426.25	34.6 AV	54.0	-19.4	1.50 H	228	36.1	-1.5
3	7498.32	46.0 PK	74.0	-28.0	2.50 H	273	36.1	9.9
4	7498.32	35.6 AV	54.0	-18.4	2.50 H	273	25.7	9.9
5	17968.18	60.0 PK	74.0	-14.0	3.50 H	274	37.2	22.8
6	17968.18	50.1 AV	54.0	-3.9	3.50 H	274	27.3	22.8

Remarks:

1. Emission Level(dBuV/m) = Raw Value(dBuV) + Correction Factor(dB/m)
2. Correction Factor(dB/m) = Antenna Factor(dB/m) + Cable Factor(dB) – Pre-Amplifier Factor(dB)
3. Margin value = Emission Level – Limit value
4. The other emission levels were very low against the limit.
5. "#": The radiated frequency is out of the restricted band.

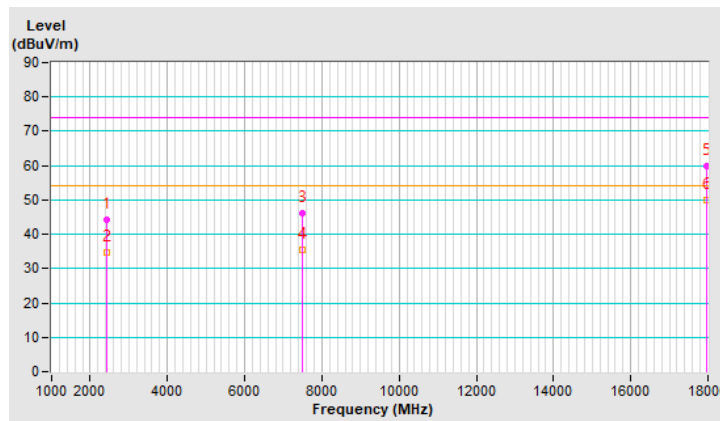

Channel	CH 1 : 58.32 GHz		
Frequency Range	1GHz ~ 18GHz	Detector Function	Peak (PK) Average (AV)

Antenna Polarity & Test Distance : Vertical at 3 m								
No	Frequency (MHz)	Emission Level (dBuV/m)	Limit (dBuV/m)	Margin (dB)	Antenna Height (m)	Table Angle (Degree)	Raw Value (dBuV)	Correction Factor (dB/m)
1	2486.25	42.2 PK	74.0	-31.8	3.50 V	73	43.6	-1.4
2	2486.25	32.7 AV	54.0	-21.3	3.50 V	73	34.1	-1.4
3	3663.47	45.3 PK	74.0	-28.7	3.00 V	38	44.3	1.0
4	3663.47	36.1 AV	54.0	-17.9	3.00 V	38	35.1	1.0
5	17974.37	59.8 PK	74.0	-14.2	1.00 V	167	37.0	22.8
6	17974.37	49.3 AV	54.0	-4.7	1.00 V	167	26.5	22.8

Remarks:

1. Emission Level(dBuV/m) = Raw Value(dBuV) + Correction Factor(dB/m)
2. Correction Factor(dB/m) = Antenna Factor(dB/m) + Cable Factor(dB) – Pre-Amplifier Factor(dB)
3. Margin value = Emission Level – Limit value
4. The other emission levels were very low against the limit.

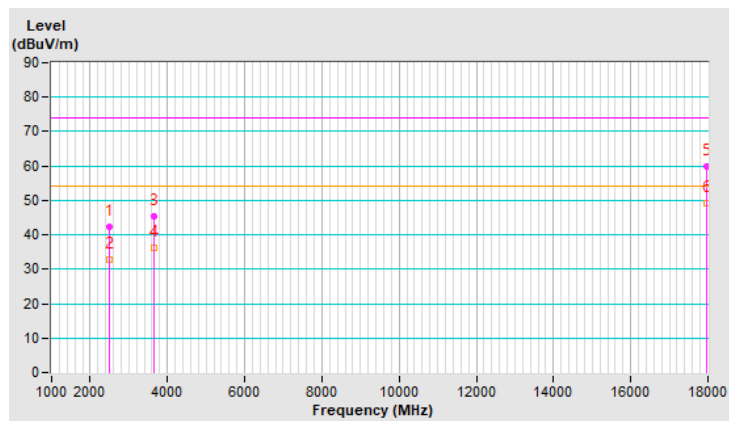

Channel	CH 2 : 60.48 GHz		
Frequency Range	1GHz ~ 18GHz	Detector Function	Peak (PK) Average (AV)

Antenna Polarity & Test Distance : Horizontal at 3 m								
No	Frequency (MHz)	Emission Level (dBuV/m)	Limit (dBuV/m)	Margin (dB)	Antenna Height (m)	Table Angle (Degree)	Raw Value (dBuV)	Correction Factor (dB/m)
1	#2424.31	44.2 PK	74.0	-29.8	1.50 H	234	45.6	-1.4
2	#2424.31	34.6 AV	54.0	-19.4	1.50 H	234	36.0	-1.4
3	7495.73	46.0 PK	74.0	-28.0	2.50 H	247	36.1	9.9
4	7495.73	35.5 AV	54.0	-18.5	2.50 H	247	25.6	9.9
5	17967.32	60.1 PK	74.0	-13.9	3.50 H	223	37.3	22.8
6	17967.32	50.1 AV	54.0	-3.9	3.50 H	223	27.3	22.8

Remarks:

1. Emission Level(dBuV/m) = Raw Value(dBuV) + Correction Factor(dB/m)
2. Correction Factor(dB/m) = Antenna Factor(dB/m) + Cable Factor(dB) – Pre-Amplifier Factor(dB)
3. Margin value = Emission Level – Limit value
4. The other emission levels were very low against the limit.
5. " # ": The radiated frequency is out of the restricted band.

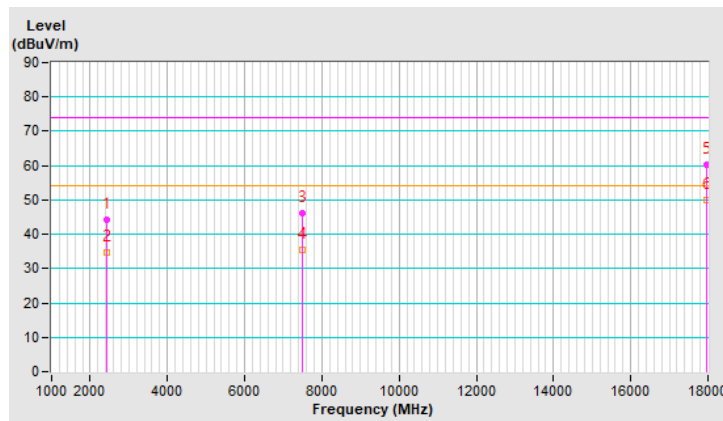

Channel	CH 2 : 60.48 GHz		
Frequency Range	1GHz ~ 18GHz	Detector Function	Peak (PK) Average (AV)

Antenna Polarity & Test Distance : Vertical at 3 m								
No	Frequency (MHz)	Emission Level (dBuV/m)	Limit (dBuV/m)	Margin (dB)	Antenna Height (m)	Table Angle (Degree)	Raw Value (dBuV)	Correction Factor (dB/m)
1	#2483.32	42.3 PK	74.0	-31.7	3.50 V	43	43.7	-1.4
2	#2483.32	32.8 AV	54.0	-21.2	3.50 V	43	34.2	-1.4
3	3661.81	45.2 PK	74.0	-28.8	3.00 V	79	44.2	1.0
4	3661.81	36.0 AV	54.0	-18.0	3.00 V	79	35.0	1.0
5	17971.21	59.9 PK	74.0	-14.1	1.00 V	192	37.1	22.8
6	17971.21	49.3 AV	54.0	-4.7	1.00 V	192	26.5	22.8

Remarks:

1. Emission Level(dBuV/m) = Raw Value(dBuV) + Correction Factor(dB/m)
2. Correction Factor(dB/m) = Antenna Factor(dB/m) + Cable Factor(dB) – Pre-Amplifier Factor(dB)
3. Margin value = Emission Level – Limit value
4. The other emission levels were very low against the limit.
5. " # ": The radiated frequency is out of the restricted band.

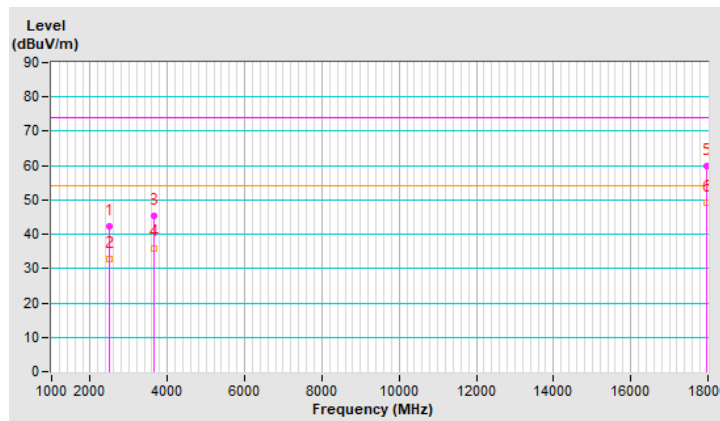

Channel	CH 3 : 62.64 GHz		
Frequency Range	1GHz ~ 18GHz	Detector Function	Peak (PK) Average (AV)

Antenna Polarity & Test Distance : Horizontal at 3 m								
No	Frequency (MHz)	Emission Level (dBuV/m)	Limit (dBuV/m)	Margin (dB)	Antenna Height (m)	Table Angle (Degree)	Raw Value (dBuV)	Correction Factor (dB/m)
1	#2421.49	44.1 PK	74.0	-29.9	1.50 H	268	45.5	-1.4
2	#2421.49	34.5 AV	54.0	-19.5	1.50 H	268	35.9	-1.4
3	7493.64	45.8 PK	74.0	-28.2	2.50 H	206	35.9	9.9
4	7493.64	35.4 AV	54.0	-18.6	2.50 H	206	25.5	9.9
5	17968.58	60.0 PK	74.0	-14.0	3.50 H	241	37.2	22.8
6	17968.58	50.0 AV	54.0	-4.0	3.50 H	241	27.2	22.8

Remarks:

1. Emission Level(dBuV/m) = Raw Value(dBuV) + Correction Factor(dB/m)
2. Correction Factor(dB/m) = Antenna Factor(dB/m) + Cable Factor(dB) – Pre-Amplifier Factor(dB)
3. Margin value = Emission Level – Limit value
4. The other emission levels were very low against the limit.
5. " # ": The radiated frequency is out of the restricted band.

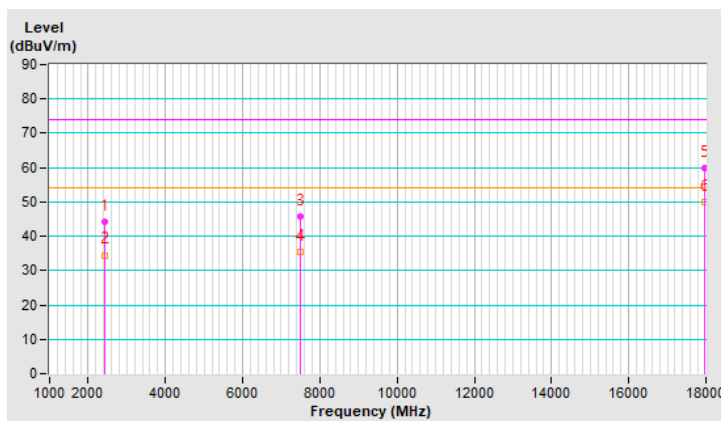

Channel	CH 3 : 62.64 GHz		
Frequency Range	1GHz ~ 18GHz	Detector Function	Peak (PK) Average (AV)

Antenna Polarity & Test Distance : Vertical at 3 m								
No	Frequency (MHz)	Emission Level (dBuV/m)	Limit (dBuV/m)	Margin (dB)	Antenna Height (m)	Table Angle (Degree)	Raw Value (dBuV)	Correction Factor (dB/m)
1	2487.67	42.4 PK	74.0	-31.6	3.50 V	57	43.8	-1.4
2	2487.67	32.8 AV	54.0	-21.2	3.50 V	57	34.2	-1.4
3	3664.63	45.3 PK	74.0	-28.7	3.00 V	63	44.3	1.0
4	3664.63	36.1 AV	54.0	-17.9	3.00 V	63	35.1	1.0
5	17973.42	60.0 PK	74.0	-14.0	1.00 V	158	37.2	22.8
6	17973.42	49.4 AV	54.0	-4.6	1.00 V	158	26.6	22.8

Remarks:

1. Emission Level(dBuV/m) = Raw Value(dBuV) + Correction Factor(dB/m)
2. Correction Factor(dB/m) = Antenna Factor(dB/m) + Cable Factor(dB) – Pre-Amplifier Factor(dB)
3. Margin value = Emission Level – Limit value
4. The other emission levels were very low against the limit.

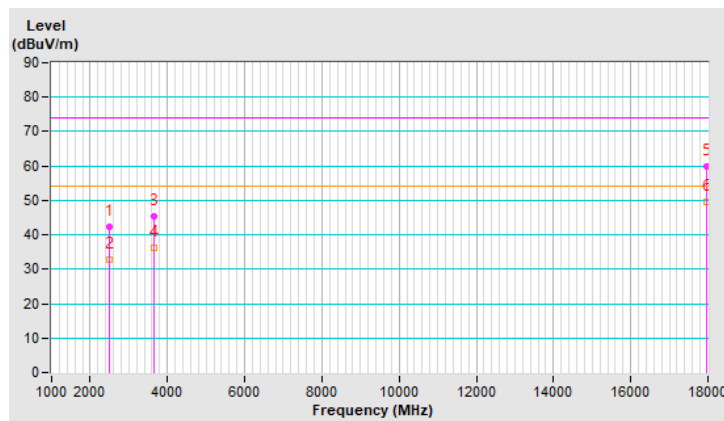

Channel	CH 4 : 64.8 GHz		
Frequency Range	1GHz ~ 18GHz	Detector Function	Peak (PK) Average (AV)

Antenna Polarity & Test Distance : Horizontal at 3 m								
No	Frequency (MHz)	Emission Level (dBuV/m)	Limit (dBuV/m)	Margin (dB)	Antenna Height (m)	Table Angle (Degree)	Raw Value (dBuV)	Correction Factor (dB/m)
1	#2419.63	44.2 PK	74.0	-29.8	1.50 H	279	45.6	-1.4
2	#2419.63	34.5 AV	54.0	-19.5	1.50 H	279	35.9	-1.4
3	7491.37	46.0 PK	74.0	-28.0	2.50 H	199	36.1	9.9
4	7491.37	35.5 AV	54.0	-18.5	2.50 H	199	25.6	9.9
5	17969.22	60.1 PK	74.0	-13.9	3.50 H	253	37.3	22.8
6	17969.22	50.0 AV	54.0	-4.0	3.50 H	253	27.2	22.8

Remarks:

1. Emission Level(dBuV/m) = Raw Value(dBuV) + Correction Factor(dB/m)
2. Correction Factor(dB/m) = Antenna Factor(dB/m) + Cable Factor(dB) – Pre-Amplifier Factor(dB)
3. Margin value = Emission Level – Limit value
4. The other emission levels were very low against the limit.
5. " # ": The radiated frequency is out of the restricted band.

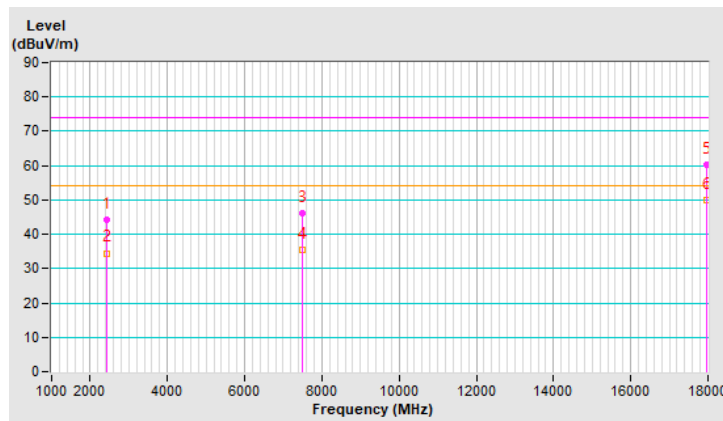

Channel	CH 4 : 64.8 GHz		
Frequency Range	1GHz ~ 18GHz	Detector Function	Peak (PK) Average (AV)

Antenna Polarity & Test Distance : Vertical at 3 m								
No	Frequency (MHz)	Emission Level (dBuV/m)	Limit (dBuV/m)	Margin (dB)	Antenna Height (m)	Table Angle (Degree)	Raw Value (dBuV)	Correction Factor (dB/m)
1	2493.47	42.5 PK	74.0	-31.5	3.50 V	41	43.9	-1.4
2	2493.47	32.8 AV	54.0	-21.2	3.50 V	41	34.2	-1.4
3	3662.85	45.3 PK	74.0	-28.7	3.00 V	49	44.3	1.0
4	3662.85	36.0 AV	54.0	-18.0	3.00 V	49	35.0	1.0
5	17976.28	60.1 PK	74.0	-13.9	1.00 V	147	37.3	22.8
6	17976.28	49.5 AV	54.0	-4.5	1.00 V	147	26.7	22.8

Remarks:

1. Emission Level(dBuV/m) = Raw Value(dBuV) + Correction Factor(dB/m)
2. Correction Factor(dB/m) = Antenna Factor(dB/m) + Cable Factor(dB) – Pre-Amplifier Factor(dB)
3. Margin value = Emission Level – Limit value
4. The other emission levels were very low against the limit.

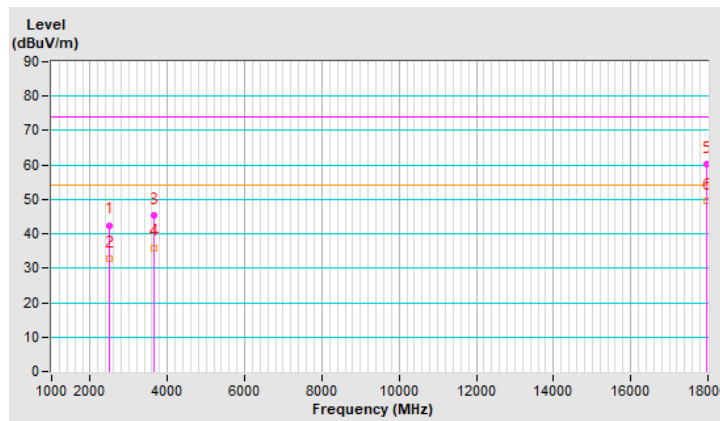

For 18~40 GHz

Channel	CH 1 : 58.32 GHz		
Frequency Range	18GHz ~ 40GHz	Detector Function	Peak (PK) Average (AV)

Antenna Polarity & Test Distance : Horizontal at 3 m								
No	Frequency (MHz)	Emission Level (dBuV/m)	Limit (dBuV/m)	Margin (dB)	Antenna Height (m)	Table Angle (Degree)	Raw Value (dBuV)	Correction Factor (dB/m)
1	19182.47	38.7 PK	74.0	-35.3	1.24 H	63	45.4	-6.7
2	19182.47	34.5 AV	54.0	-19.5	1.24 H	63	41.2	-6.7
3	#26981.76	42.4 PK	74.0	-31.6	1.77 H	158	43.4	-1.0
4	#26981.76	37.2 AV	54.0	-16.8	1.77 H	158	38.2	-1.0
5	39622.98	44.0 PK	74.0	-30.0	2.54 H	206	37.2	6.8
6	39622.98	38.4 AV	54.0	-15.6	2.54 H	206	31.6	6.8

Remarks:

1. Emission Level(dBuV/m) = Raw Value(dBuV) + Correction Factor(dB/m)
2. Correction Factor(dB/m) = Antenna Factor(dB/m) + Cable Factor(dB) – Pre-Amplifier Factor(dB)
3. Margin value = Emission Level – Limit value
4. The other emission levels were very low against the limit.
5. " # ": The radiated frequency is out of the restricted band.

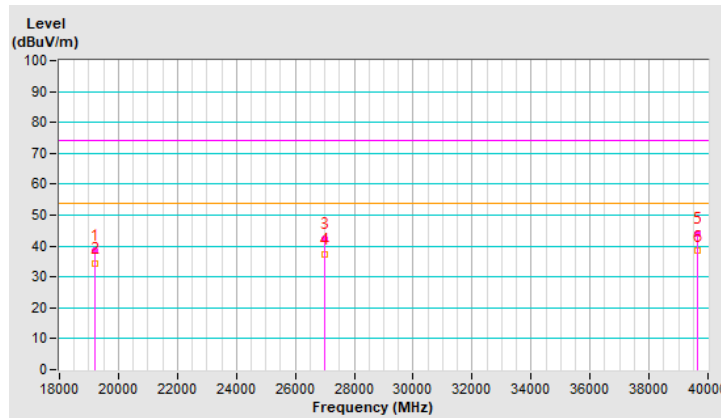

Channel	CH 1 : 58.32 GHz		
Frequency Range	18GHz ~ 40GHz	Detector Function	Peak (PK) Average (AV)

Antenna Polarity & Test Distance : Vertical at 3 m								
No	Frequency (MHz)	Emission Level (dBuV/m)	Limit (dBuV/m)	Margin (dB)	Antenna Height (m)	Table Angle (Degree)	Raw Value (dBuV)	Correction Factor (dB/m)
1	18542.81	39.0 PK	74.0	-35.0	1.37 V	82	45.9	-6.9
2	18542.81	34.5 AV	54.0	-19.5	1.37 V	82	41.4	-6.9
3	#28111.93	42.9 PK	74.0	-31.1	1.99 V	294	44.9	-2.0
4	#28111.93	37.5 AV	54.0	-16.5	1.99 V	294	39.5	-2.0
5	38817.58	43.2 PK	74.0	-30.8	1.79 V	221	38.8	4.4
6	38817.58	36.3 AV	54.0	-17.7	1.79 V	221	31.9	4.4

Remarks:

1. Emission Level(dBuV/m) = Raw Value(dBuV) + Correction Factor(dB/m)
2. Correction Factor(dB/m) = Antenna Factor(dB/m) + Cable Factor(dB) – Pre-Amplifier Factor(dB)
3. Margin value = Emission Level – Limit value
4. The other emission levels were very low against the limit.
5. "#": The radiated frequency is out of the restricted band.

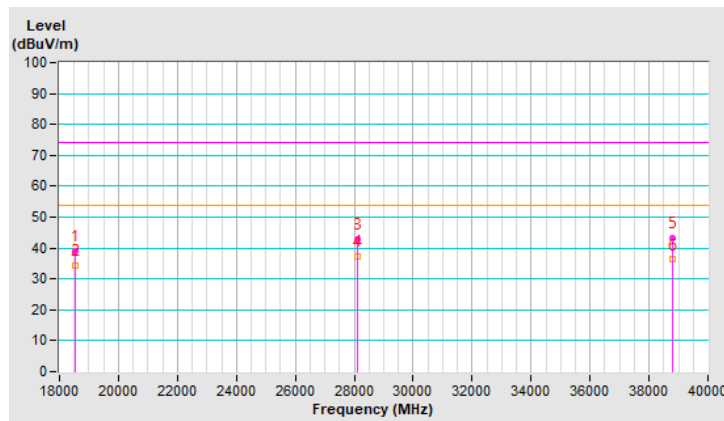

Channel	CH 2 : 60.48 GHz		
Frequency Range	18GHz ~ 40GHz	Detector Function	Peak (PK) Average (AV)

Antenna Polarity & Test Distance : Horizontal at 3 m								
No	Frequency (MHz)	Emission Level (dBuV/m)	Limit (dBuV/m)	Margin (dB)	Antenna Height (m)	Table Angle (Degree)	Raw Value (dBuV)	Correction Factor (dB/m)
1	19185.96	38.8 PK	74.0	-35.2	1.32 H	88	45.5	-6.7
2	19185.96	34.6 AV	54.0	-19.4	1.32 H	88	41.3	-6.7
3	#26989.53	42.6 PK	74.0	-31.4	1.63 H	129	43.5	-0.9
4	#26989.53	37.4 AV	54.0	-16.6	1.63 H	129	38.3	-0.9
5	39625.23	44.2 PK	74.0	-29.8	2.43 H	187	37.5	6.7
6	39625.23	38.5 AV	54.0	-15.5	2.43 H	187	31.8	6.7

Remarks:

1. Emission Level(dBuV/m) = Raw Value(dBuV) + Correction Factor(dB/m)
2. Correction Factor(dB/m) = Antenna Factor(dB/m) + Cable Factor(dB) – Pre-Amplifier Factor(dB)
3. Margin value = Emission Level – Limit value
4. The other emission levels were very low against the limit.
5. "#": The radiated frequency is out of the restricted band.

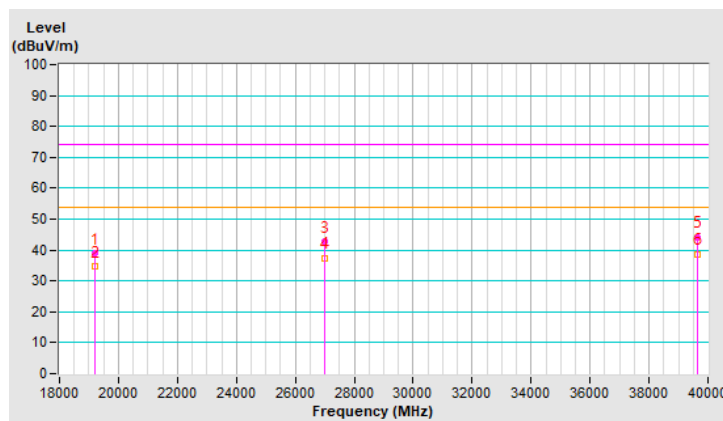

Channel	CH 2 : 60.48 GHz		
Frequency Range	18GHz ~ 40GHz	Detector Function	Peak (PK) Average (AV)

Antenna Polarity & Test Distance : Vertical at 3 m								
No	Frequency (MHz)	Emission Level (dBuV/m)	Limit (dBuV/m)	Margin (dB)	Antenna Height (m)	Table Angle (Degree)	Raw Value (dBuV)	Correction Factor (dB/m)
1	18545.29	39.2 PK	74.0	-34.8	1.42 V	69	46.2	-7.0
2	18545.29	34.6 AV	54.0	-19.4	1.42 V	69	41.6	-7.0
3	#28114.63	43.1 PK	74.0	-30.9	1.74 V	307	45.1	-2.0
4	#28114.63	37.6 AV	54.0	-16.4	1.74 V	307	39.6	-2.0
5	38819.45	43.4 PK	74.0	-30.6	1.97 V	243	39.0	4.4
6	38819.45	36.4 AV	54.0	-17.6	1.97 V	243	32.0	4.4

Remarks:

1. Emission Level(dBuV/m) = Raw Value(dBuV) + Correction Factor(dB/m)
2. Correction Factor(dB/m) = Antenna Factor(dB/m) + Cable Factor(dB) – Pre-Amplifier Factor(dB)
3. Margin value = Emission Level – Limit value
4. The other emission levels were very low against the limit.
5. "#": The radiated frequency is out of the restricted band.

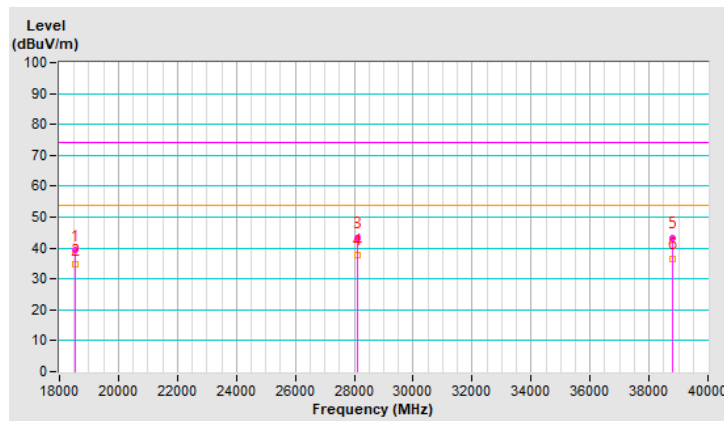

Channel	CH 3 : 62.64 GHz		
Frequency Range	18GHz ~ 40GHz	Detector Function	Peak (PK) Average (AV)

Antenna Polarity & Test Distance : Horizontal at 3 m								
No	Frequency (MHz)	Emission Level (dBuV/m)	Limit (dBuV/m)	Margin (dB)	Antenna Height (m)	Table Angle (Degree)	Raw Value (dBuV)	Correction Factor (dB/m)
1	19183.72	38.7 PK	74.0	-35.3	1.43 H	96	45.4	-6.7
2	19183.72	34.5 AV	54.0	-19.5	1.43 H	96	41.2	-6.7
3	#26991.26	42.5 PK	74.0	-31.5	1.77 H	143	43.4	-0.9
4	#26991.26	37.3 AV	54.0	-16.7	1.77 H	143	38.2	-0.9
5	39624.63	44.1 PK	74.0	-29.9	2.52 H	167	37.4	6.7
6	39624.63	38.4 AV	54.0	-15.6	2.52 H	167	31.7	6.7

Remarks:

1. Emission Level(dBuV/m) = Raw Value(dBuV) + Correction Factor(dB/m)
2. Correction Factor(dB/m) = Antenna Factor(dB/m) + Cable Factor(dB) – Pre-Amplifier Factor(dB)
3. Margin value = Emission Level – Limit value
4. The other emission levels were very low against the limit.
5. "#": The radiated frequency is out of the restricted band.

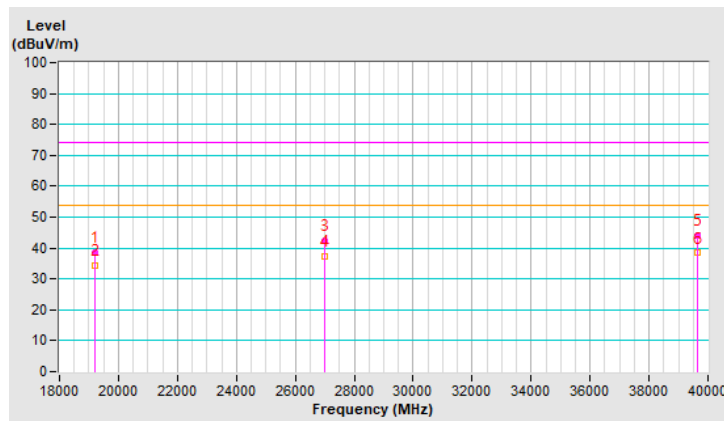

Channel	CH 3 : 62.64 GHz		
Frequency Range	18GHz ~ 40GHz	Detector Function	Peak (PK) Average (AV)

Antenna Polarity & Test Distance : Vertical at 3 m								
No	Frequency (MHz)	Emission Level (dBuV/m)	Limit (dBuV/m)	Margin (dB)	Antenna Height (m)	Table Angle (Degree)	Raw Value (dBuV)	Correction Factor (dB/m)
1	18547.57	39.1 PK	74.0	-34.9	1.36 V	79	46.1	-7.0
2	18547.57	34.5 AV	54.0	-19.5	1.36 V	79	41.5	-7.0
3	#28115.37	43.0 PK	74.0	-31.0	1.48 V	334	45.0	-2.0
4	#28115.37	37.5 AV	54.0	-16.5	1.48 V	334	39.5	-2.0
5	38821.24	43.2 PK	74.0	-30.8	2.21 V	206	38.8	4.4
6	38821.24	36.3 AV	54.0	-17.7	2.21 V	206	31.9	4.4

Remarks:

1. Emission Level(dBuV/m) = Raw Value(dBuV) + Correction Factor(dB/m)
2. Correction Factor(dB/m) = Antenna Factor(dB/m) + Cable Factor(dB) – Pre-Amplifier Factor(dB)
3. Margin value = Emission Level – Limit value
4. The other emission levels were very low against the limit.
5. " # ": The radiated frequency is out of the restricted band.

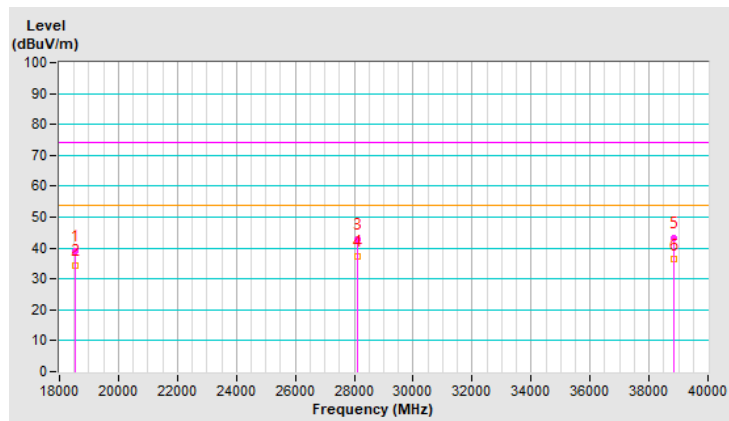

Channel	CH 4 : 64.8 GHz		
Frequency Range	18GHz ~ 40GHz	Detector Function	Peak (PK) Average (AV)

Antenna Polarity & Test Distance : Horizontal at 3 m								
No	Frequency (MHz)	Emission Level (dBuV/m)	Limit (dBuV/m)	Margin (dB)	Antenna Height (m)	Table Angle (Degree)	Raw Value (dBuV)	Correction Factor (dB/m)
1	19184.37	38.9 PK	74.0	-35.1	1.27 H	112	45.6	-6.7
2	19184.37	34.6 AV	54.0	-19.4	1.27 H	112	41.3	-6.7
3	#26993.43	42.4 PK	74.0	-31.6	1.83 H	157	43.3	-0.9
4	#26993.43	37.2 AV	54.0	-16.8	1.83 H	157	38.1	-0.9
5	39627.34	44.2 PK	74.0	-29.8	2.46 H	183	37.5	6.7
6	39627.34	38.5 AV	54.0	-15.5	2.46 H	183	31.8	6.7

Remarks:

1. Emission Level(dBuV/m) = Raw Value(dBuV) + Correction Factor(dB/m)
2. Correction Factor(dB/m) = Antenna Factor(dB/m) + Cable Factor(dB) – Pre-Amplifier Factor(dB)
3. Margin value = Emission Level – Limit value
4. The other emission levels were very low against the limit.
5. "#": The radiated frequency is out of the restricted band.

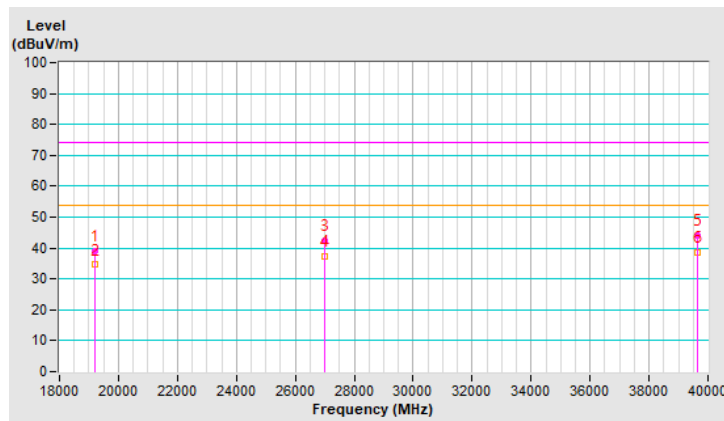

Channel	CH 4 : 64.8 GHz		
Frequency Range	18GHz ~ 40GHz	Detector Function	Peak (PK) Average (AV)

Antenna Polarity & Test Distance : Vertical at 3 m								
No	Frequency (MHz)	Emission Level (dBuV/m)	Limit (dBuV/m)	Margin (dB)	Antenna Height (m)	Table Angle (Degree)	Raw Value (dBuV)	Correction Factor (dB/m)
1	18544.71	39.2 PK	74.0	-34.8	1.32 V	89	46.2	-7.0
2	18544.71	34.6 AV	54.0	-19.4	1.32 V	89	41.6	-7.0
3	#28116.43	43.1 PK	74.0	-30.9	1.67 V	313	45.1	-2.0
4	#28116.43	37.5 AV	54.0	-16.5	1.67 V	313	39.5	-2.0
5	38817.97	43.3 PK	74.0	-30.7	2.26 V	187	38.9	4.4
6	38817.97	36.4 AV	54.0	-17.6	2.26 V	187	32.0	4.4

Remarks:

1. Emission Level(dBuV/m) = Raw Value(dBuV) + Correction Factor(dB/m)
2. Correction Factor(dB/m) = Antenna Factor(dB/m) + Cable Factor(dB) – Pre-Amplifier Factor(dB)
3. Margin value = Emission Level – Limit value
4. The other emission levels were very low against the limit.
5. "#": The radiated frequency is out of the restricted band.

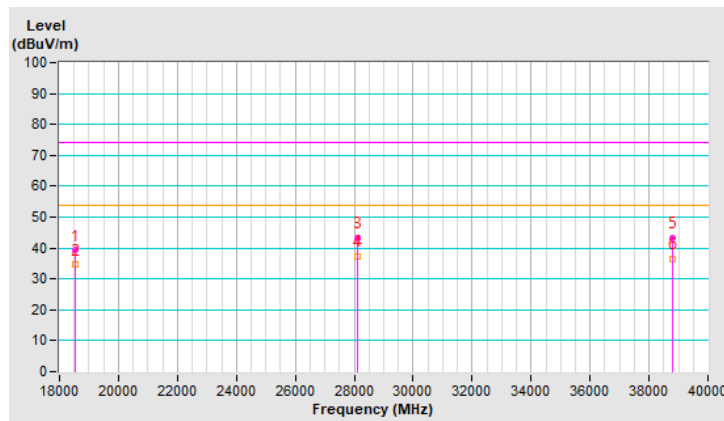

For above 40 GHz

Channel	CH 1 : 58.32 GHz		
Frequency Range	40GHz ~ 220GHz	Detector Function	Average (AV)

Antenna Polarity : Horizontal							
No.	Frequency (GHz)	E _{Meas} (dB μ V/m)	EIRP Level (dBm/MHz)	Power Density (pW/cm ²)	Power Density Limit (pW/cm ²)	Margin (pW/cm ²)	PASS/FAIL
1	41.99	78.73	-25.97	2.24	90.00	-87.76	PASS
2	55.48	85.52	-19.18	10.69	90.00	-79.31	PASS
3	74.12	71.87	-32.83	0.46	90.00	-89.54	PASS
4	102.35	74.15	-30.55	0.78	90.00	-89.22	PASS
5	116.84	86.80	-17.90	14.35	90.00	-75.65	PASS
6	194.23	78.45	-26.25	2.10	90.00	-87.90	PASS
Antenna Polarity : Vertical							
No.	Frequency (GHz)	E _{Meas} (dB μ V/m)	EIRP Level (dBm/MHz)	Power Density (pW/cm ²)	Power Density Limit (pW/cm ²)	Margin (pW/cm ²)	PASS/FAIL
1	41.82	78.84	-25.86	2.29	90.00	-87.71	PASS
2	54.98	86.15	-18.55	12.36	90.00	-77.64	PASS
3	73.64	72.23	-32.47	0.50	90.00	-89.50	PASS
4	102.85	74.89	-29.81	0.92	90.00	-89.08	PASS
5	116.58	87.39	-17.31	16.43	90.00	-73.58	PASS
6	192.22	78.51	-26.19	2.13	90.00	-87.87	PASS

Remarks:

1. The measured power level is converted to EIRP using the equation:

Follow ANSI 63.10 section 9.4 Equations to calculate and extrapolate field strength

$$E_{Meas} \text{ (dB}\mu\text{V/m)} = 126.8 - 20\log(\lambda) + P - G$$

where:

E_{Meas} is the field strength of the emission at the measurement distance, in dB μ V/m

P is the power measured at the output of the test antenna, in dBm

λ is the wavelength of the emission under investigation [300/fMHz], in m

G is the gain of the test antenna, in dBi

Follow ANSI 63.10 section 9.5 Equations to calculate EIRP

$$\text{EIRP Level (dBm/MHz)} = E_{Meas} \text{ (dB}\mu\text{V/m)} + 20 \cdot \log(d_{Meas}) - 104.7$$

E_{Meas} is the field strength of the emission at the measurement distance, in dB μ V/m

d_{Meas} is the measurement distance, in m

Measurements made at 1 meter distance.

2. Power density formula as follows

Follow ANSI 63.10 section 9.6 Equations to calculate power density

$$PD = \text{EIRP}_{Linear} / 4 \pi d^2$$

PD is the power density at the distance specified by the limit, in W/m²

EIRP_{Linear} is the equivalent isotropically radiated power, in watts

d is the 3m distance.

3. The far-field boundary is given in ANSI 63.10 as:

$$R \text{ far field} = (2 * L^2) / \lambda$$

L is the Largest Antenna Dimension of measurement antenna, including the reflector

λ is the wavelength

Frequency (GHz)	L (m)	Lambda (m)	R (Far Field) (m)
40	0.03	0.0075	0.240
50	0.03	0.0060	0.300

Frequency (GHz)	L (m)	Lambda (m)	R (Far Field) (m)
50	0.025	0.0060	0.208
75	0.025	0.0040	0.313

Frequency (GHz)	L (m)	Lambda (m)	R (Far Field) (m)
75	0.018	0.0040	0.162
110	0.018	0.0027	0.238

Frequency (GHz)	L (m)	Lambda (m)	R (Far Field) (m)
110	0.012	0.0027	0.106
170	0.012	0.0018	0.163

Frequency (GHz)	L (m)	Lambda (m)	R (Far Field) (m)
170	0.008	0.0018	0.073
260	0.008	0.0012	0.111

Channel	CH 2 : 60.48 GHz		
Frequency Range	40GHz ~ 220GHz	Detector Function	Average (AV)

Antenna Polarity : Horizontal							
No.	Frequency (GHz)	E _{Meas} (dBμV/m)	EIRP Level (dBm/MHz)	Power Density (pW/cm ²)	Power Density Limit (pW/cm ²)	Margin (pW/cm ²)	PASS/FAIL
1	42.24	78.78	-25.92	2.26	90.00	-87.74	PASS
2	55.09	85.85	-18.85	11.54	90.00	-78.46	PASS
3	73.78	71.81	-32.89	0.45	90.00	-89.55	PASS
4	102.44	74.17	-30.53	0.78	90.00	-89.22	PASS
5	116.94	86.53	-18.17	13.48	90.00	-76.52	PASS
6	194.20	78.37	-26.33	2.06	90.00	-87.94	PASS
Antenna Polarity : Vertical							
No.	Frequency (GHz)	E _{Meas} (dBμV/m)	EIRP Level (dBm/MHz)	Power Density (pW/cm ²)	Power Density Limit (pW/cm ²)	Margin (pW/cm ²)	PASS/FAIL
1	41.68	79.28	-25.42	2.54	90.00	-87.46	PASS
2	55.11	86.46	-18.24	13.27	90.00	-76.73	PASS
3	73.32	72.36	-32.34	0.52	90.00	-89.48	PASS
4	102.37	93.66	-11.04	69.62	90.00	-20.38	PASS
5	116.44	87.23	-17.47	15.83	90.00	-74.17	PASS
6	192.48	78.48	-26.22	2.11	90.00	-87.89	PASS

Remarks:

1. The measured power level is converted to EIRP using the equation:

Follow ANSI 63.10 section 9.4 Equations to calculate and extrapolate field strength

$$E_{Meas} \text{ (dB}\mu\text{V/m)} = 126.8 - 20\log(\lambda) + P - G$$

where:

E_{Meas} is the field strength of the emission at the measurement distance, in dBμV/m

P is the power measured at the output of the test antenna, in dBm

λ is the wavelength of the emission under investigation [300/fMHz], in m

G is the gain of the test antenna, in dBi

Follow ANSI 63.10 section 9.5 Equations to calculate EIRP

$$\text{EIRP Level (dBm/MHz)} = E_{Meas} \text{ (dB}\mu\text{V/m)} + 20 \cdot \log(d_{Meas}) - 104.7$$

E_{Meas} is the field strength of the emission at the measurement distance, in dBμV/m

d_{Meas} is the measurement distance, in m

Measurements made at 1 meter distance.

2. Power density formula as follows

Follow ANSI 63.10 section 9.6 Equations to calculate power density

$$PD = \text{EIRP}_{\text{Linear}} / 4 \pi d^2$$

PD is the power density at the distance specified by the limit, in W/m²

EIRP_{Linear} is the equivalent isotropically radiated power, in watts

d is the 3m distance.

3. The far-field boundary is given in ANSI 63.10 as:

$$R \text{ far field} = (2 * L^2) / \lambda$$

L is the Largest Antenna Dimension of measurement antenna, including the reflector

λ is the wavelength

Frequency (GHz)	L (m)	Lambda (m)	R (Far Field) (m)
40	0.03	0.0075	0.240
50	0.03	0.0060	0.300

Frequency (GHz)	L (m)	Lambda (m)	R (Far Field) (m)
50	0.025	0.0060	0.208
75	0.025	0.0040	0.313

Frequency (GHz)	L (m)	Lambda (m)	R (Far Field) (m)
75	0.018	0.0040	0.162
110	0.018	0.0027	0.238

Frequency (GHz)	L (m)	Lambda (m)	R (Far Field) (m)
110	0.012	0.0027	0.106
170	0.012	0.0018	0.163

Frequency (GHz)	L (m)	Lambda (m)	R (Far Field) (m)
170	0.008	0.0018	0.073
260	0.008	0.0012	0.111

Channel	CH 3 : 62.64 GHz		
Frequency Range	40GHz ~ 220GHz	Detector Function	Average (AV)

Antenna Polarity : Horizontal							
No.	Frequency (GHz)	E _{Meas} (dB μ V/m)	EIRP Level (dBm/MHz)	Power Density (pW/cm ²)	Power Density Limit (pW/cm ²)	Margin (pW/cm ²)	PASS/FAIL
1	42.38	78.80	-25.90	2.27	90.00	-87.73	PASS
2	55.26	85.42	-19.28	10.45	90.00	-79.55	PASS
3	74.19	71.71	-32.99	0.44	90.00	-89.56	PASS
4	102.58	74.08	-30.62	0.77	90.00	-89.23	PASS
5	117.21	86.59	-18.11	13.67	90.00	-76.33	PASS
6	194.04	78.36	-26.34	2.05	90.00	-87.95	PASS
Antenna Polarity : Vertical							
No.	Frequency (GHz)	E _{Meas} (dB μ V/m)	EIRP Level (dBm/MHz)	Power Density (pW/cm ²)	Power Density Limit (pW/cm ²)	Margin (pW/cm ²)	PASS/FAIL
1	41.71	78.92	-25.78	2.34	90.00	-87.66	PASS
2	54.90	86.27	-18.43	12.70	90.00	-77.30	PASS
3	73.53	72.15	-32.55	0.49	90.00	-89.51	PASS
4	102.52	94.15	-10.55	77.93	90.00	-12.07	PASS
5	116.52	87.24	-17.46	15.87	90.00	-74.13	PASS
6	192.41	78.70	-26.00	2.22	90.00	-87.78	PASS

Remarks:

1. The measured power level is converted to EIRP using the equation:

Follow ANSI 63.10 section 9.4 Equations to calculate and extrapolate field strength

$$E_{Meas} \text{ (dB}\mu\text{V/m)} = 126.8 - 20\log(\lambda) + P - G$$

where:

E_{Meas} is the field strength of the emission at the measurement distance, in dB μ V/m

P is the power measured at the output of the test antenna, in dBm

λ is the wavelength of the emission under investigation [300/fMHz], in m

G is the gain of the test antenna, in dBi

Follow ANSI 63.10 section 9.5 Equations to calculate EIRP

$$\text{EIRP Level (dBm/MHz)} = E_{Meas} \text{ (dB}\mu\text{V/m)} + 20 \cdot \log(d_{Meas}) - 104.7$$

E_{Meas} is the field strength of the emission at the measurement distance, in dB μ V/m

d_{Meas} is the measurement distance, in m

Measurements made at 1 meter distance.

2. Power density formula as follows

Follow ANSI 63.10 section 9.6 Equations to calculate power density

$$PD = \text{EIRP}_{\text{Linear}} / 4 \pi d^2$$

PD is the power density at the distance specified by the limit, in W/m²

EIRP_{Linear} is the equivalent isotropically radiated power, in watts

d is the 3m distance.

3. The far-field boundary is given in ANSI 63.10 as:

$$R \text{ far field} = (2 * L^2) / \lambda$$

L is the Largest Antenna Dimension of measurement antenna, including the reflector

λ is the wavelength

Frequency (GHz)	L (m)	Lambda (m)	R (Far Field) (m)
40	0.03	0.0075	0.240
50	0.03	0.0060	0.300

Frequency (GHz)	L (m)	Lambda (m)	R (Far Field) (m)
50	0.025	0.0060	0.208
75	0.025	0.0040	0.313

Frequency (GHz)	L (m)	Lambda (m)	R (Far Field) (m)
75	0.018	0.0040	0.162
110	0.018	0.0027	0.238

Frequency (GHz)	L (m)	Lambda (m)	R (Far Field) (m)
110	0.012	0.0027	0.106
170	0.012	0.0018	0.163

Frequency (GHz)	L (m)	Lambda (m)	R (Far Field) (m)
170	0.008	0.0018	0.073
260	0.008	0.0012	0.111

Channel	CH 4 : 64.8 GHz		
Frequency Range	40GHz ~ 220GHz	Detector Function	Average (AV)

Antenna Polarity : Horizontal							
No.	Frequency (GHz)	E _{Meas} (dB μ V/m)	EIRP Level (dBm/MHz)	Power Density (pW/cm ²)	Power Density Limit (pW/cm ²)	Margin (pW/cm ²)	PASS/FAIL
1	42.15	78.84	-25.86	2.30	90.00	-87.70	PASS
2	55.13	85.57	-19.13	10.82	90.00	-79.18	PASS
3	74.26	71.89	-32.81	0.46	90.00	-89.54	PASS
4	102.38	74.19	-30.51	0.79	90.00	-89.21	PASS
5	116.89	86.86	-17.84	14.55	90.00	-75.45	PASS
6	194.47	78.60	-26.10	2.17	90.00	-87.83	PASS
Antenna Polarity : Vertical							
No.	Frequency (GHz)	E _{Meas} (dB μ V/m)	EIRP Level (dBm/MHz)	Power Density (pW/cm ²)	Power Density Limit (pW/cm ²)	Margin (pW/cm ²)	PASS/FAIL
1	41.87	79.20	-25.50	2.49	90.00	-87.51	PASS
2	55.20	86.28	-18.42	12.73	90.00	-77.27	PASS
3	73.16	71.95	-32.75	0.47	90.00	-89.53	PASS
4	102.83	93.81	-10.89	72.07	90.00	-17.93	PASS
5	116.72	87.46	-17.24	16.69	90.00	-73.31	PASS
6	192.26	78.61	-26.09	2.18	90.00	-87.82	PASS

Remarks:

1. The measured power level is converted to EIRP using the equation:

Follow ANSI 63.10 section 9.4 Equations to calculate and extrapolate field strength

$$E_{Meas} \text{ (dB}\mu\text{V/m)} = 126.8 - 20\log(\lambda) + P - G$$

where:

E_{Meas} is the field strength of the emission at the measurement distance, in dB μ V/m

P is the power measured at the output of the test antenna, in dBm

λ is the wavelength of the emission under investigation [300/fMHz], in m

G is the gain of the test antenna, in dBi

Follow ANSI 63.10 section 9.5 Equations to calculate EIRP

$$\text{EIRP Level (dBm/MHz)} = E_{Meas} \text{ (dB}\mu\text{V/m)} + 20 \cdot \log(d_{Meas}) - 104.7$$

E_{Meas} is the field strength of the emission at the measurement distance, in dB μ V/m

d_{Meas} is the measurement distance, in m

Measurements made at 1 meter distance.

2. Power density formula as follows

Follow ANSI 63.10 section 9.6 Equations to calculate power density

$$PD = \text{EIRP}_{\text{Linear}} / 4 \pi d^2$$

PD is the power density at the distance specified by the limit, in W/m²

EIRP_{Linear} is the equivalent isotropically radiated power, in watts

d is the 3m distance.

3. The far-field boundary is given in ANSI 63.10 as:

$$R \text{ far field} = (2 * L^2) / \lambda$$

L is the Largest Antenna Dimension of measurement antenna, including the reflector

λ is the wavelength

Frequency (GHz)	L (m)	Lambda (m)	R (Far Field) (m)
40	0.03	0.0075	0.240
50	0.03	0.0060	0.300

Frequency (GHz)	L (m)	Lambda (m)	R (Far Field) (m)
50	0.025	0.0060	0.208
75	0.025	0.0040	0.313

Frequency (GHz)	L (m)	Lambda (m)	R (Far Field) (m)
75	0.018	0.0040	0.162
110	0.018	0.0027	0.238

Frequency (GHz)	L (m)	Lambda (m)	R (Far Field) (m)
110	0.012	0.0027	0.106
170	0.012	0.0018	0.163

Frequency (GHz)	L (m)	Lambda (m)	R (Far Field) (m)
170	0.008	0.0018	0.073
260	0.008	0.0012	0.111

Below 1GHz Data:

Channel	CH 1 : 58.32 GHz		
Frequency Range	9kHz ~ 1GHz	Detector Function	Quasi-Peak (QP)

Antenna Polarity & Test Distance : Horizontal at 3 m								
No	Frequency (MHz)	Emission Level (dBuV/m)	Limit (dBuV/m)	Margin (dB)	Antenna Height (m)	Table Angle (Degree)	Raw Value (dBuV)	Correction Factor (dB/m)
1	31.93	29.2 QP	40.0	-10.8	1.00 H	13	38.0	-8.8
2	86.64	33.5 QP	40.0	-6.5	3.50 H	146	46.6	-13.1
3	121.17	30.3 QP	43.5	-13.2	3.00 H	127	39.2	-8.9
4	176.59	35.0 QP	43.5	-8.5	1.50 H	241	43.1	-8.1
5	249.92	31.0 QP	46.0	-15.0	1.50 H	63	39.0	-8.0
6	374.97	33.0 QP	46.0	-13.0	1.00 H	15	36.7	-3.7

Remarks:

1. Emission Level(dBuV/m) = Raw Value(dBuV) + Correction Factor(dB/m)
2. Correction Factor(dB/m) = Antenna Factor(dB/m) + Cable Factor(dB) – Pre-Amplifier Factor(dB)
3. Margin value = Emission Level – Limit value
4. The other emission levels were very low against the limit of frequency range 30MHz~1000MHz.
5. The emission levels were very low against the limit of frequency range 9kHz~30MHz: the amplitude of spurious emissions attenuated more than 20 dB below the permissible value to be report.

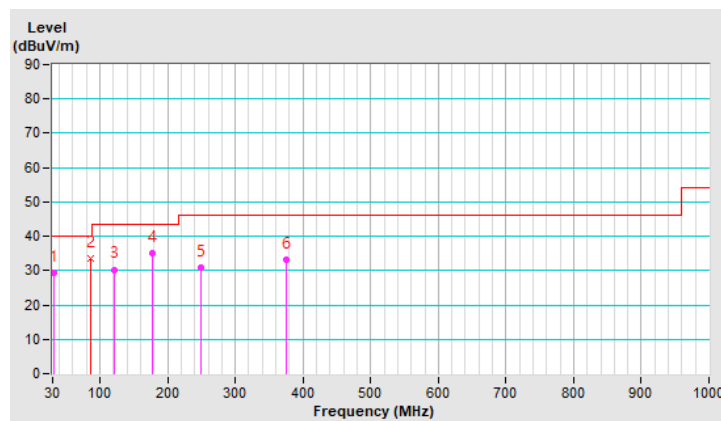

Channel	CH 1 : 58.32 GHz		
Frequency Range	9kHz ~ 1GHz	Detector Function	Quasi-Peak (QP)

Antenna Polarity & Test Distance : Vertical at 3 m								
No	Frequency (MHz)	Emission Level (dBuV/m)	Limit (dBuV/m)	Margin (dB)	Antenna Height (m)	Table Angle (Degree)	Raw Value (dBuV)	Correction Factor (dB/m)
1	43.19	34.3 QP	40.0	-5.7	1.00 V	258	42.2	-7.9
2	82.79	35.2 QP	40.0	-4.8	1.00 V	44	48.1	-12.9
3	121.12	30.4 QP	43.5	-13.1	2.00 V	132	39.3	-8.9
4	175.33	36.2 QP	43.5	-7.3	3.00 V	77	44.2	-8.0
5	208.33	30.6 QP	43.5	-12.9	1.00 V	147	40.6	-10.0
6	874.98	31.1 QP	46.0	-14.9	2.00 V	351	24.1	7.0

Remarks:

1. Emission Level(dBuV/m) = Raw Value(dBuV) + Correction Factor(dB/m)
2. Correction Factor(dB/m) = Antenna Factor(dB/m) + Cable Factor(dB) – Pre-Amplifier Factor(dB)
3. Margin value = Emission Level – Limit value
4. The other emission levels were very low against the limit of frequency range 30MHz~1000MHz.
5. The emission levels were very low against the limit of frequency range 9kHz~30MHz: the amplitude of spurious emissions attenuated more than 20 dB below the permissible value to be report.

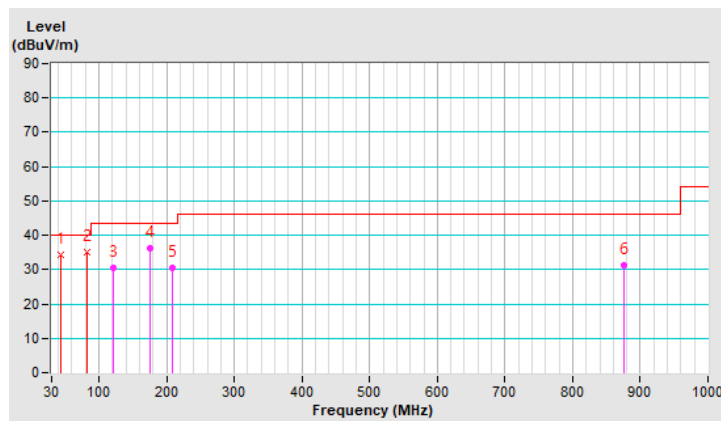

Channel	CH 2 : 60.48 GHz		
Frequency Range	9kHz ~ 1GHz	Detector Function	Quasi-Peak (QP)

Antenna Polarity & Test Distance : Horizontal at 3 m								
No	Frequency (MHz)	Emission Level (dBUV/m)	Limit (dBUV/m)	Margin (dB)	Antenna Height (m)	Table Angle (Degree)	Raw Value (dBUV)	Correction Factor (dB/m)
1	31.89	29.1 QP	40.0	-10.9	1.00 H	24	37.9	-8.8
2	86.60	33.3 QP	40.0	-6.7	3.50 H	128	46.4	-13.1
3	121.13	30.2 QP	43.5	-13.3	3.00 H	162	39.1	-8.9
4	176.52	34.7 QP	43.5	-8.8	1.50 H	268	42.8	-8.1
5	249.87	30.8 QP	46.0	-15.2	1.50 H	82	38.8	-8.0
6	374.92	32.8 QP	46.0	-13.2	1.00 H	42	36.5	-3.7

Remarks:

1. Emission Level(dBUV/m) = Raw Value(dBUV) + Correction Factor(dB/m)
2. Correction Factor(dB/m) = Antenna Factor(dB/m) + Cable Factor(dB) – Pre-Amplifier Factor(dB)
3. Margin value = Emission Level – Limit value
4. The other emission levels were very low against the limit of frequency range 30MHz~1000MHz.
5. The emission levels were very low against the limit of frequency range 9kHz~30MHz: the amplitude of spurious emissions attenuated more than 20 dB below the permissible value to be report.

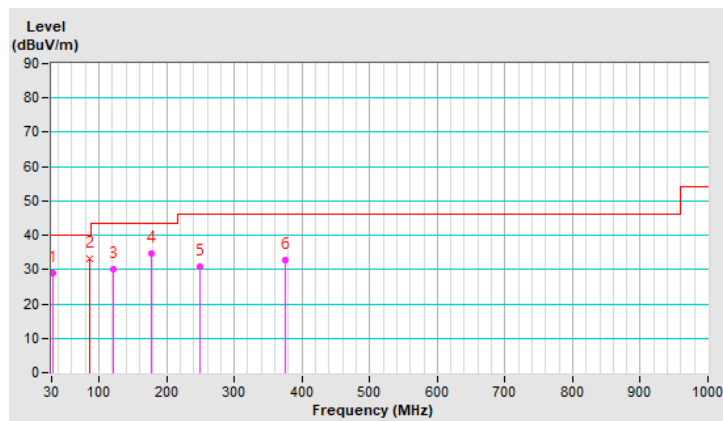

Channel	CH 2 : 60.48 GHz		
Frequency Range	9kHz ~ 1GHz	Detector Function	Quasi-Peak (QP)

Antenna Polarity & Test Distance : Vertical at 3 m								
No	Frequency (MHz)	Emission Level (dBUV/m)	Limit (dBUV/m)	Margin (dB)	Antenna Height (m)	Table Angle (Degree)	Raw Value (dBUV)	Correction Factor (dB/m)
1	43.13	34.2 QP	40.0	-5.8	1.00 V	236	42.1	-7.9
2	82.75	35.1 QP	40.0	-4.9	1.00 V	82	48.0	-12.9
3	121.07	30.2 QP	43.5	-13.3	2.00 V	147	39.1	-8.9
4	175.28	36.1 QP	43.5	-7.4	3.00 V	89	44.1	-8.0
5	208.27	30.4 QP	43.5	-13.1	1.00 V	177	40.4	-10.0
6	875.02	31.0 QP	46.0	-15.0	1.50 V	333	24.0	7.0

Remarks:

1. Emission Level(dBuV/m) = Raw Value(dBuV) + Correction Factor(dB/m)
2. Correction Factor(dB/m) = Antenna Factor(dB/m) + Cable Factor(dB) – Pre-Amplifier Factor(dB)
3. Margin value = Emission Level – Limit value
4. The other emission levels were very low against the limit of frequency range 30MHz~1000MHz.
5. The emission levels were very low against the limit of frequency range 9kHz~30MHz: the amplitude of spurious emissions attenuated more than 20 dB below the permissible value to be report.

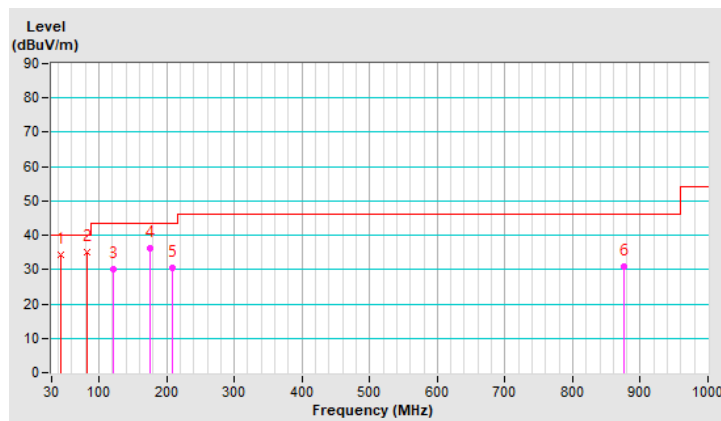

Channel	CH 3 : 62.64 GHz		
Frequency Range	9kHz ~ 1GHz	Detector Function	Quasi-Peak (QP)

Antenna Polarity & Test Distance : Horizontal at 3 m								
No	Frequency (MHz)	Emission Level (dBUV/m)	Limit (dBUV/m)	Margin (dB)	Antenna Height (m)	Table Angle (Degree)	Raw Value (dBUV)	Correction Factor (dB/m)
1	31.85	29.0 QP	40.0	-11.0	1.00 H	48	37.8	-8.8
2	86.57	33.1 QP	40.0	-6.9	3.50 H	143	46.2	-13.1
3	121.08	30.0 QP	43.5	-13.5	2.50 H	147	38.9	-8.9
4	176.47	34.5 QP	43.5	-9.0	1.50 H	296	42.6	-8.1
5	249.83	30.7 QP	46.0	-15.3	1.50 H	74	38.7	-8.0
6	374.87	32.6 QP	46.0	-13.4	1.00 H	58	36.3	-3.7

Remarks:

1. Emission Level(dBuV/m) = Raw Value(dBuV) + Correction Factor(dB/m)
2. Correction Factor(dB/m) = Antenna Factor(dB/m) + Cable Factor(dB) – Pre-Amplifier Factor(dB)
3. Margin value = Emission Level – Limit value
4. The other emission levels were very low against the limit of frequency range 30MHz~1000MHz.
5. The emission levels were very low against the limit of frequency range 9kHz~30MHz: the amplitude of spurious emissions attenuated more than 20 dB below the permissible value to be report.

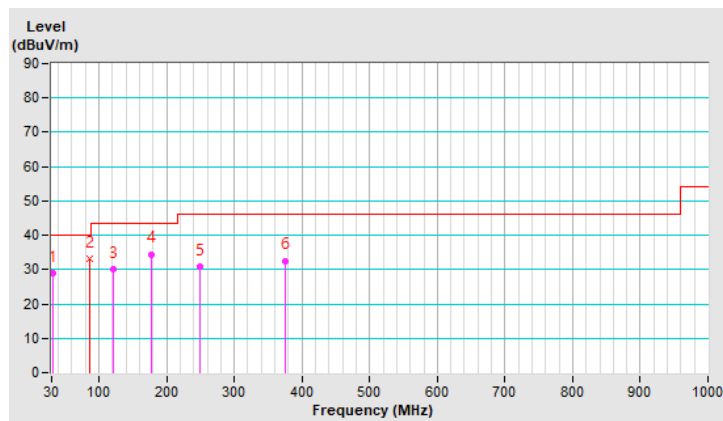

Channel	CH 3 : 62.64 GHz		
Frequency Range	9kHz ~ 1GHz	Detector Function	Quasi-Peak (QP)

Antenna Polarity & Test Distance : Vertical at 3 m								
No	Frequency (MHz)	Emission Level (dBUV/m)	Limit (dBUV/m)	Margin (dB)	Antenna Height (m)	Table Angle (Degree)	Raw Value (dBUV)	Correction Factor (dB/m)
1	43.09	34.0 QP	40.0	-6.0	1.00 V	228	41.9	-7.9
2	82.70	35.0 QP	40.0	-5.0	1.00 V	65	47.9	-12.9
3	121.01	30.0 QP	43.5	-13.5	2.00 V	181	38.9	-8.9
4	175.22	36.0 QP	43.5	-7.5	3.00 V	111	44.0	-8.0
5	208.20	30.2 QP	43.5	-13.3	1.00 V	158	40.2	-10.0
6	875.00	31.1 QP	46.0	-14.9	1.50 V	289	24.1	7.0

Remarks:

1. Emission Level(dBuV/m) = Raw Value(dBuV) + Correction Factor(dB/m)
2. Correction Factor(dB/m) = Antenna Factor(dB/m) + Cable Factor(dB) – Pre-Amplifier Factor(dB)
3. Margin value = Emission Level – Limit value
4. The other emission levels were very low against the limit of frequency range 30MHz~1000MHz.
5. The emission levels were very low against the limit of frequency range 9kHz~30MHz: the amplitude of spurious emissions attenuated more than 20 dB below the permissible value to be report.

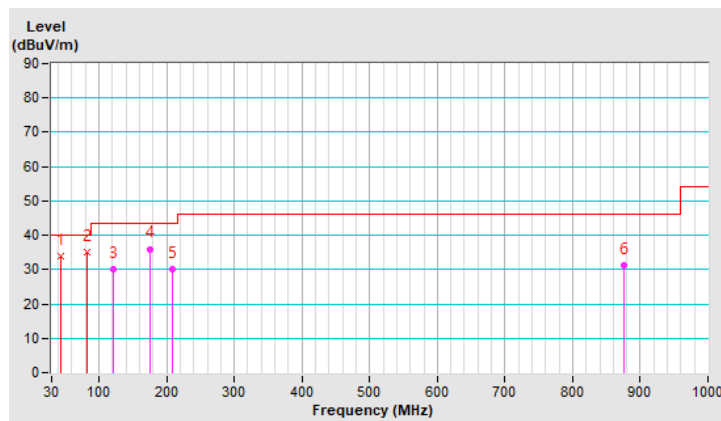

Channel	CH 4 : 64.8 GHz		
Frequency Range	9kHz ~ 1GHz	Detector Function	Quasi-Peak (QP)

Antenna Polarity & Test Distance : Horizontal at 3 m								
No	Frequency (MHz)	Emission Level (dBuV/m)	Limit (dBuV/m)	Margin (dB)	Antenna Height (m)	Table Angle (Degree)	Raw Value (dBuV)	Correction Factor (dB/m)
1	31.93	29.3 QP	40.0	-10.7	1.00 H	71	38.1	-8.8
2	86.62	33.3 QP	40.0	-6.7	3.50 H	172	46.4	-13.1
3	121.16	30.4 QP	43.5	-13.1	2.50 H	171	39.3	-8.9
4	176.55	34.8 QP	43.5	-8.7	1.50 H	257	42.9	-8.1
5	249.91	30.9 QP	46.0	-15.1	1.50 H	61	38.9	-8.0
6	374.94	32.8 QP	46.0	-13.2	1.00 H	44	36.5	-3.7

Remarks:

1. Emission Level(dBuV/m) = Raw Value(dBuV) + Correction Factor(dB/m)
2. Correction Factor(dB/m) = Antenna Factor(dB/m) + Cable Factor(dB) – Pre-Amplifier Factor(dB)
3. Margin value = Emission Level – Limit value
4. The other emission levels were very low against the limit of frequency range 30MHz~1000MHz.
5. The emission levels were very low against the limit of frequency range 9kHz~30MHz: the amplitude of spurious emissions attenuated more than 20 dB below the permissible value to be report.

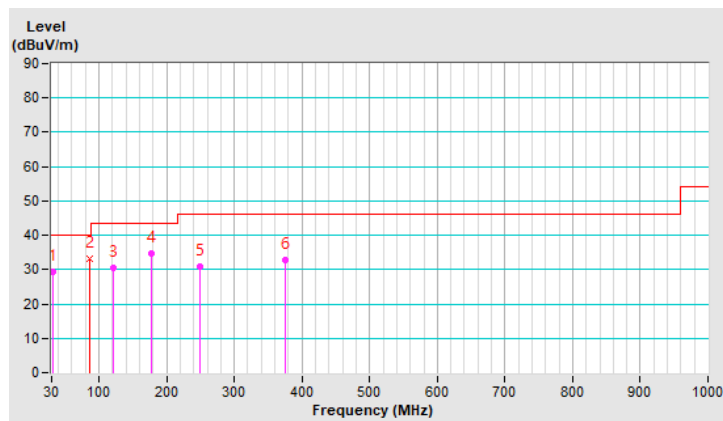

Channel	CH 4 : 64.8 GHz		
Frequency Range	9kHz ~ 1GHz	Detector Function	Quasi-Peak (QP)

Antenna Polarity & Test Distance : Vertical at 3 m								
No	Frequency (MHz)	Emission Level (dBUV/m)	Limit (dBUV/m)	Margin (dB)	Antenna Height (m)	Table Angle (Degree)	Raw Value (dBUV)	Correction Factor (dB/m)
1	43.14	34.3 QP	40.0	-5.7	1.00 V	238	42.2	-7.9
2	82.76	35.3 QP	40.0	-4.7	1.00 V	93	48.2	-12.9
3	121.07	30.3 QP	43.5	-13.2	2.00 V	158	39.2	-8.9
4	175.28	36.3 QP	43.5	-7.2	3.00 V	134	44.3	-8.0
5	208.27	30.5 QP	43.5	-13.0	1.00 V	129	40.5	-10.0
6	875.02	31.3 QP	46.0	-14.7	1.50 V	276	24.3	7.0

Remarks:

1. Emission Level(dBUV/m) = Raw Value(dBUV) + Correction Factor(dB/m)
2. Correction Factor(dB/m) = Antenna Factor(dB/m) + Cable Factor(dB) – Pre-Amplifier Factor(dB)
3. Margin value = Emission Level – Limit value
4. The other emission levels were very low against the limit of frequency range 30MHz~1000MHz.
5. The emission levels were very low against the limit of frequency range 9kHz~30MHz: the amplitude of spurious emissions attenuated more than 20 dB below the permissible value to be report.

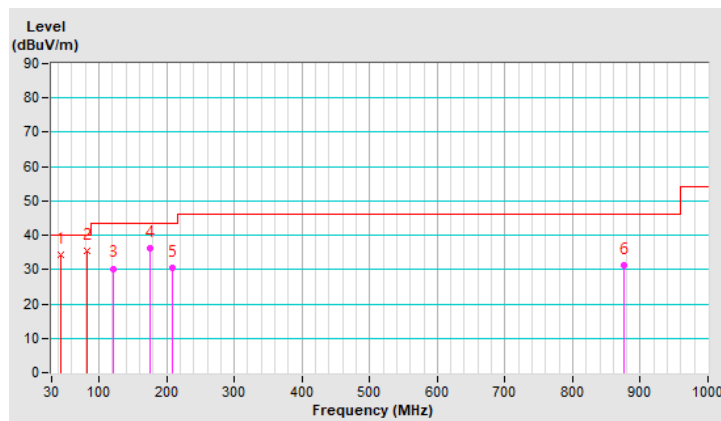

4.2 Conducted Emission Measurement

4.2.1 Limits of Conducted Emission Measurement

Frequency (MHz)	Conducted Limit (dBuV)	
	Quasi-peak	Average
0.15 - 0.5	66 - 56	56 - 46
0.50 - 5.0	56	46
5.0 - 30.0	60	50

Note: 1. The lower limit shall apply at the transition frequencies.

2. The limit decreases in line with the logarithm of the frequency in the range of 0.15 to 0.50MHz.

4.2.2 Test Instruments

DESCRIPTION & MANUFACTURER	MODEL NO.	SERIAL NO.	CALIBRATED DATE	CALIBRATED UNTIL
Test Receiver R&S	ESCS 30	847124/029	Oct. 20, 2020	Oct. 19, 2021
Line-Impedance Stabilization Network (for EUT) R&S	ESH3-Z5	848773/004	Oct. 27, 2020	Oct. 26, 2021
Line-Impedance Stabilization Network (for Peripheral) R&S	ESH3-Z5	835239/001	Mar. 19, 2020	Mar. 18, 2021
50 ohms Terminator	50	3	Oct. 26, 2020	Oct. 25, 2021
RF Cable	5D-FB	COCCAB-001	Sep. 26, 2020	Sep. 25, 2021
Fixed attenuator EMCI	STI02-2200-10	005	Aug. 29, 2020	Aug. 28, 2021
Software BVADT	BVADT_Cond_ V7.3.7.4	NA	NA	NA

Note:

1. The calibration interval of the above test instruments are 12 months and the calibrations are traceable to NML/ROC and NIST/USA.
2. The test was performed in Conduction 1.
- 3 Tested Date: Dec. 05, 2020

4.2.3 Test Procedures

- The EUT was placed 0.4 meters from the conducting wall of the shielded room with EUT being connected to the power mains through a line impedance stabilization network (LISN). Other support units were connected to the power mains through another LISN. The two LISNs provide 50 ohm/ 50uH of coupling impedance for the measuring instrument.
- Both lines of the power mains connected to the EUT were checked for maximum conducted interference.
- The frequency range from 150kHz to 30MHz was searched. Emission levels under (Limit - 20dB) was not recorded.

Note: The resolution bandwidth and video bandwidth of test receiver is 9kHz for quasi-peak detection (QP) and average detection (AV) at frequency 0.15MHz-30MHz.

4.2.4 Deviation from Test Standard

No deviation.

4.2.5 Test Setup

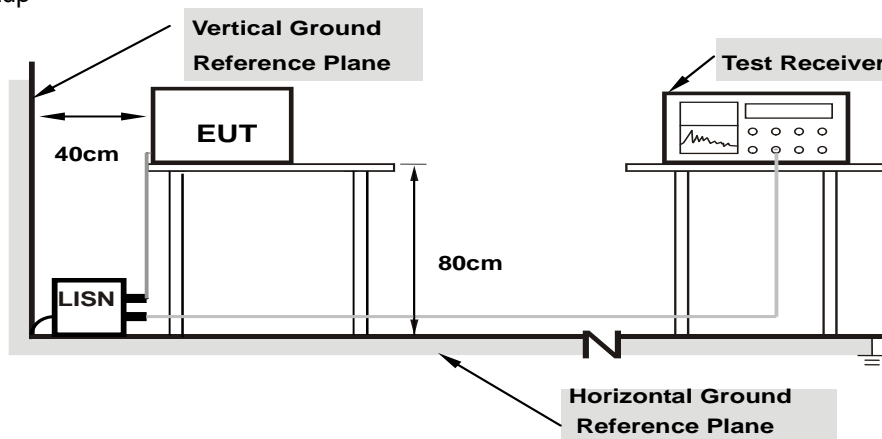

Note: 1.Support units were connected to second LISN.

For the actual test configuration, please refer to the attached file (Test Setup Photo).

4.2.6 EUT Operating Conditions

Same as 4.1.6.

4.2.7 Test Results

Channel	CH 1 : 58.32 GHz		
Frequency Range	150kHz ~ 30MHz	Detector Function & Bandwidth	Quasi-Peak (QP) / Average (AV), 9kHz

Phase Of Power : Line (L)										
No	Frequency (MHz)	Correction Factor (dB)	Reading Value (dBuV)		Emission Level (dBuV)		Limit (dBuV)		Margin (dB)	
			Q.P.	AV.	Q.P.	AV.	Q.P.	AV.	Q.P.	AV.
1	0.15781	9.95	42.08	23.23	52.03	33.18	65.58	55.58	-13.55	-22.40
2	0.16953	9.96	41.38	27.03	51.34	36.99	64.98	54.98	-13.64	-17.99
3	0.54031	10.00	40.59	30.85	50.59	40.85	56.00	46.00	-5.41	-5.15
4	3.14063	10.13	26.63	18.01	36.76	28.14	56.00	46.00	-19.24	-17.86
5	11.98047	10.65	32.92	26.50	43.57	37.15	60.00	50.00	-16.43	-12.85
6	13.80469	10.76	34.15	27.90	44.91	38.66	60.00	50.00	-15.09	-11.34

Remarks:

1. Q.P. and AV. are abbreviations of quasi-peak and average individually.
2. The emission levels of other frequencies were very low against the limit.
3. Margin value = Emission level – Limit value
4. Correction factor = Insertion loss + Cable loss
5. Emission Level = Correction Factor + Reading Value

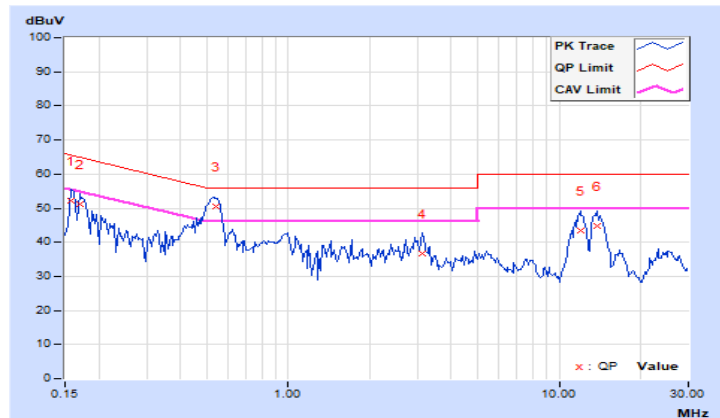

Channel	CH 1 : 58.32 GHz		
Frequency Range	150kHz ~ 30MHz	Detector Function & Bandwidth	Quasi-Peak (QP) / Average (AV), 9kHz

Phase Of Power : Neutral (N)										
No	Frequency (MHz)	Correction Factor (dB)	Reading Value (dBuV)		Emission Level (dBuV)		Limit (dBuV)		Margin (dB)	
			Q.P.	AV.	Q.P.	AV.	Q.P.	AV.	Q.P.	AV.
1	0.16172	9.93	42.63	25.87	52.56	35.80	65.38	55.38	-12.82	-19.58
2	0.53672	9.97	41.21	31.55	51.18	41.52	56.00	46.00	-4.82	-4.48
3	0.99375	10.00	28.06	17.29	38.06	27.29	56.00	46.00	-17.94	-18.71
4	3.10938	10.08	27.57	18.94	37.65	29.02	56.00	46.00	-18.35	-16.98
5	12.26563	10.51	33.53	27.16	44.04	37.67	60.00	50.00	-15.96	-12.33
6	13.66797	10.58	35.43	29.05	46.01	39.63	60.00	50.00	-13.99	-10.37

Remarks:

1. Q.P. and AV. are abbreviations of quasi-peak and average individually.
2. The emission levels of other frequencies were very low against the limit.
3. Margin value = Emission level – Limit value
4. Correction factor = Insertion loss + Cable loss
5. Emission Level = Correction Factor + Reading Value

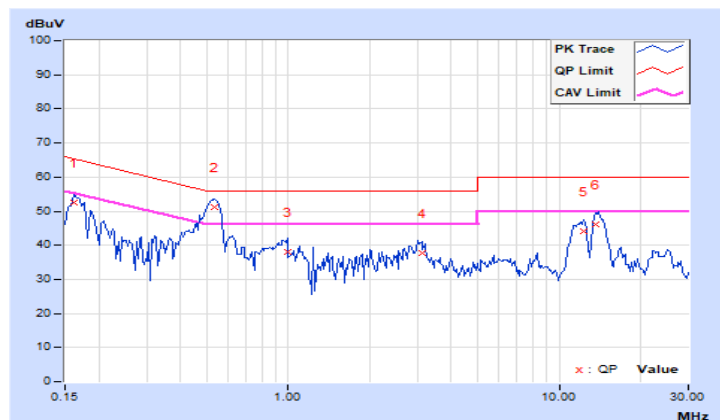

Channel	CH 2 : 60.48 GHz		
Frequency Range	150kHz ~ 30MHz	Detector Function & Bandwidth	Quasi-Peak (QP) / Average (AV), 9kHz

Phase Of Power : Line (L)										
No	Frequency (MHz)	Correction Factor (dB)	Reading Value (dBuV)		Emission Level (dBuV)		Limit (dBuV)		Margin (dB)	
			Q.P.	AV.	Q.P.	AV.	Q.P.	AV.	Q.P.	AV.
1	0.16562	9.96	41.28	26.98	51.24	36.94	65.18	55.18	-13.94	-18.24
2	0.52891	10.00	41.30	31.93	51.30	41.93	56.00	46.00	-4.70	-4.07
3	0.61875	10.00	32.14	23.17	42.14	33.17	56.00	46.00	-13.86	-12.83
4	3.02344	10.12	27.71	19.16	37.83	29.28	56.00	46.00	-18.17	-16.72
5	11.69141	10.63	31.55	25.04	42.18	35.67	60.00	50.00	-17.82	-14.33
6	14.14453	10.78	36.00	29.86	46.78	40.64	60.00	50.00	-13.22	-9.36

Remarks:

1. Q.P. and AV. are abbreviations of quasi-peak and average individually.
2. The emission levels of other frequencies were very low against the limit.
3. Margin value = Emission level – Limit value
4. Correction factor = Insertion loss + Cable loss
5. Emission Level = Correction Factor + Reading Value

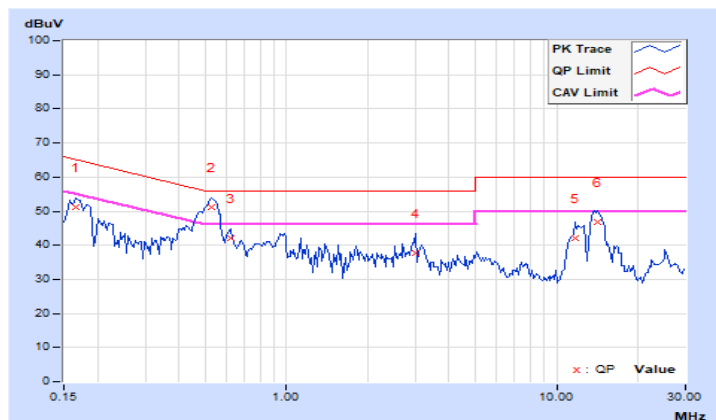

Channel	CH 2 : 60.48 GHz		
Frequency Range	150kHz ~ 30MHz	Detector Function & Bandwidth	Quasi-Peak (QP) / Average (AV), 9kHz

Phase Of Power : Neutral (N)										
No	Frequency (MHz)	Correction Factor (dB)	Reading Value (dBuV)		Emission Level (dBuV)		Limit (dBuV)		Margin (dB)	
			Q.P.	AV.	Q.P.	AV.	Q.P.	AV.	Q.P.	AV.
1	0.15781	9.92	41.20	21.31	51.12	31.23	65.58	55.58	-14.46	-24.35
2	0.52500	9.97	41.30	31.95	51.27	41.92	56.00	46.00	-4.73	-4.08
3	0.97422	10.00	28.34	17.98	38.34	27.98	56.00	46.00	-17.66	-18.02
4	3.10938	10.08	27.69	18.86	37.77	28.94	56.00	46.00	-18.23	-17.06
5	11.96484	10.50	33.64	27.31	44.14	37.81	60.00	50.00	-15.86	-12.19
6	13.93359	10.59	36.27	30.29	46.86	40.88	60.00	50.00	-13.14	-9.12

Remarks:

1. Q.P. and AV. are abbreviations of quasi-peak and average individually.
2. The emission levels of other frequencies were very low against the limit.
3. Margin value = Emission level – Limit value
4. Correction factor = Insertion loss + Cable loss
5. Emission Level = Correction Factor + Reading Value

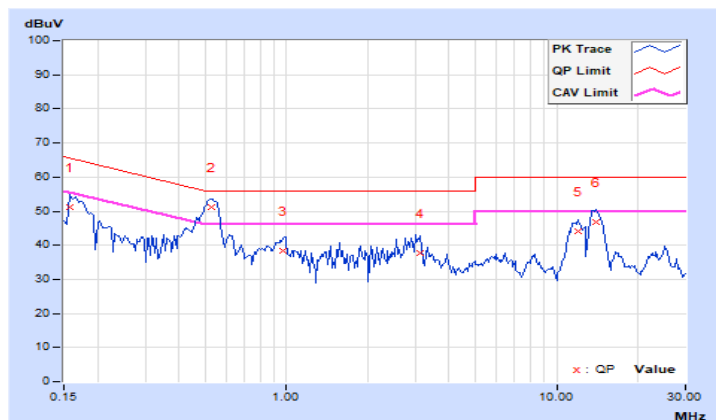

Channel	CH 3 : 62.64 GHz		
Frequency Range	150kHz ~ 30MHz	Detector Function & Bandwidth	Quasi-Peak (QP) / Average (AV), 9kHz

Phase Of Power : Line (L)										
No	Frequency (MHz)	Correction Factor (dB)	Reading Value (dBUV)		Emission Level (dBUV)		Limit (dBUV)		Margin (dB)	
			Q.P.	AV.	Q.P.	AV.	Q.P.	AV.	Q.P.	AV.
1	0.16562	9.96	41.61	27.54	51.57	37.50	65.18	55.18	-13.61	-17.68
2	0.52500	10.00	41.41	32.16	51.41	42.16	56.00	46.00	-4.59	-3.84
3	0.97813	10.03	29.65	19.34	39.68	29.37	56.00	46.00	-16.32	-16.63
4	3.04688	10.12	28.06	18.99	38.18	29.11	56.00	46.00	-17.82	-16.89
5	12.20703	10.66	32.44	25.90	43.10	36.56	60.00	50.00	-16.90	-13.44
6	13.96875	10.77	36.42	30.24	47.19	41.01	60.00	50.00	-12.81	-8.99

Remarks:

1. Q.P. and AV. are abbreviations of quasi-peak and average individually.
2. The emission levels of other frequencies were very low against the limit.
3. Margin value = Emission level – Limit value
4. Correction factor = Insertion loss + Cable loss
5. Emission Level = Correction Factor + Reading Value

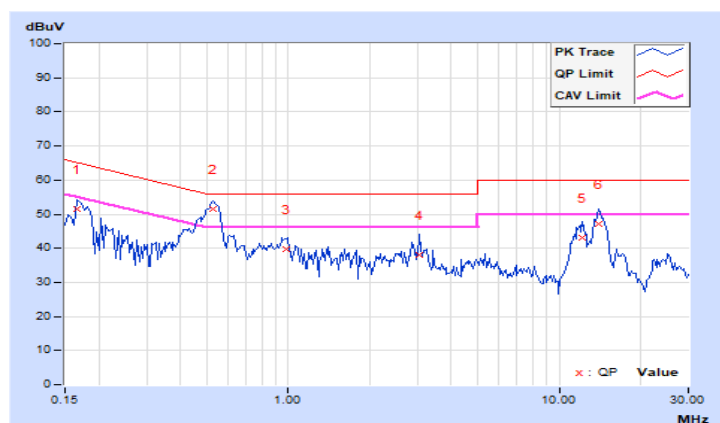

Channel	CH 3 : 62.64 GHz		
Frequency Range	150kHz ~ 30MHz	Detector Function & Bandwidth	Quasi-Peak (QP) / Average (AV), 9kHz

Phase Of Power : Neutral (N)										
No	Frequency (MHz)	Correction Factor (dB)	Reading Value (dBuV)		Emission Level (dBuV)		Limit (dBuV)		Margin (dB)	
			Q.P.	AV.	Q.P.	AV.	Q.P.	AV.	Q.P.	AV.
1	0.16562	9.93	41.61	27.02	51.54	36.95	65.18	55.18	-13.64	-18.23
2	0.53281	9.97	41.39	31.92	51.36	41.89	56.00	46.00	-4.64	-4.11
3	0.97031	10.00	28.08	17.98	38.08	27.98	56.00	46.00	-17.92	-18.02
4	2.82031	10.07	27.46	19.05	37.53	29.12	56.00	46.00	-18.47	-16.88
5	11.97656	10.50	33.38	27.35	43.88	37.85	60.00	50.00	-16.12	-12.15
6	13.85547	10.58	36.43	30.35	47.01	40.93	60.00	50.00	-12.99	-9.07

Remarks:

1. Q.P. and AV. are abbreviations of quasi-peak and average individually.
2. The emission levels of other frequencies were very low against the limit.
3. Margin value = Emission level – Limit value
4. Correction factor = Insertion loss + Cable loss
5. Emission Level = Correction Factor + Reading Value

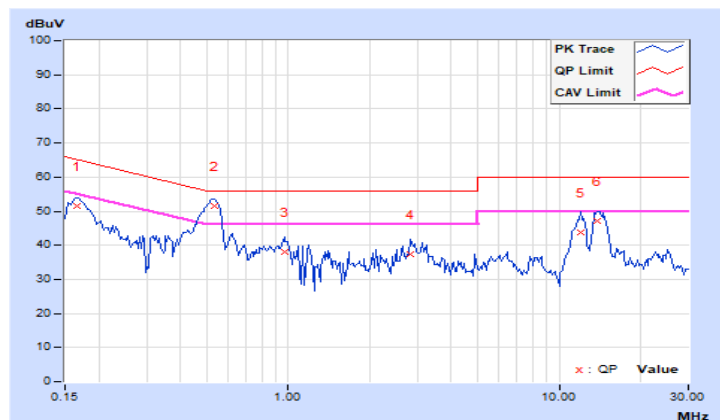

Channel	CH 4 : 64.8 GHz		
Frequency Range	150kHz ~ 30MHz	Detector Function & Bandwidth	Quasi-Peak (QP) / Average (AV), 9kHz

Phase Of Power : Line (L)										
No	Frequency (MHz)	Correction Factor (dB)	Reading Value (dBuV)		Emission Level (dBuV)		Limit (dBuV)		Margin (dB)	
			Q.P.	AV.	Q.P.	AV.	Q.P.	AV.	Q.P.	AV.
1	0.16953	9.96	41.26	27.05	51.22	37.01	64.98	54.98	-13.76	-17.97
2	0.53281	10.00	41.43	32.12	51.43	42.12	56.00	46.00	-4.57	-3.88
3	0.98203	10.03	30.12	19.57	40.15	29.60	56.00	46.00	-15.85	-16.40
4	2.87500	10.11	27.13	19.12	37.24	29.23	56.00	46.00	-18.76	-16.77
5	12.03906	10.65	32.27	25.85	42.92	36.50	60.00	50.00	-17.08	-13.50
6	13.99609	10.77	36.63	30.54	47.40	41.31	60.00	50.00	-12.60	-8.69

Remarks:

1. Q.P. and AV. are abbreviations of quasi-peak and average individually.
2. The emission levels of other frequencies were very low against the limit.
3. Margin value = Emission level – Limit value
4. Correction factor = Insertion loss + Cable loss
5. Emission Level = Correction Factor + Reading Value

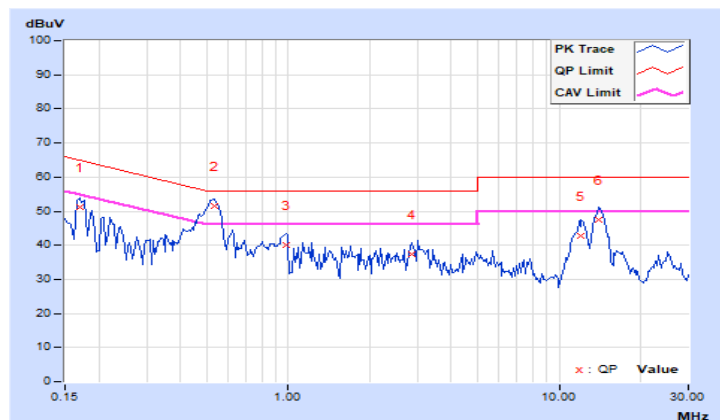

Channel	CH 4 : 64.8 GHz		
Frequency Range	150kHz ~ 30MHz	Detector Function & Bandwidth	Quasi-Peak (QP) / Average (AV), 9kHz

Phase Of Power : Neutral (N)										
No	Frequency (MHz)	Correction Factor (dB)	Reading Value (dBuV)		Emission Level (dBuV)		Limit (dBuV)		Margin (dB)	
			Q.P.	AV.	Q.P.	AV.	Q.P.	AV.	Q.P.	AV.
1	0.15000	9.92	32.03	10.81	41.95	20.73	66.00	56.00	-24.05	-35.27
2	0.16562	9.93	41.34	26.59	51.27	36.52	65.18	55.18	-13.91	-18.66
3	0.53281	9.97	41.39	31.92	51.36	41.89	56.00	46.00	-4.64	-4.11
4	2.98438	10.08	28.40	19.38	38.48	29.46	56.00	46.00	-17.52	-16.54
5	11.98828	10.50	33.34	27.23	43.84	37.73	60.00	50.00	-16.16	-12.27
6	13.67188	10.58	36.09	29.75	46.67	40.33	60.00	50.00	-13.33	-9.67

Remarks:

1. Q.P. and AV. are abbreviations of quasi-peak and average individually.
2. The emission levels of other frequencies were very low against the limit.
3. Margin value = Emission level – Limit value
4. Correction factor = Insertion loss + Cable loss
5. Emission Level = Correction Factor + Reading Value

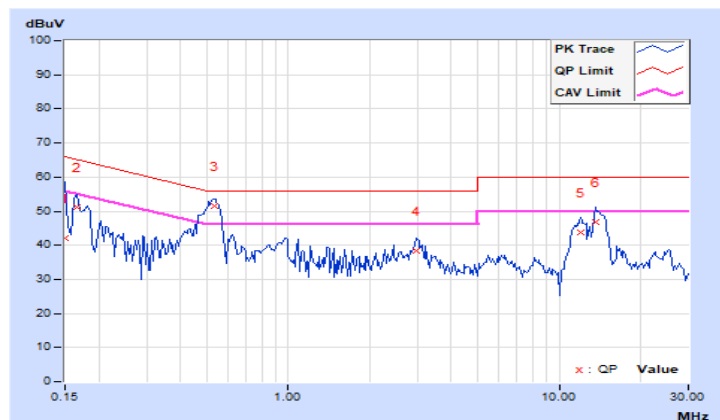

4.3 6dB Bandwidth Measurement

4.3.1 Limits of 6dB Bandwidth Measurement

None: For reporting purposes only.

4.3.2 Test Setup

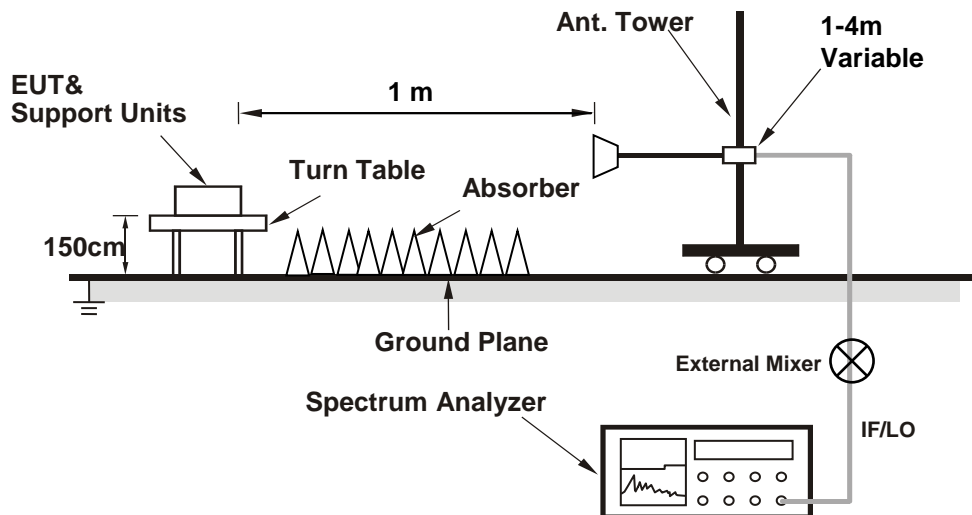

4.3.3 Test Instruments

Refer to section 4.1.2 to get information of above instrument.

4.3.4 Test Procedure

- Set resolution bandwidth (RBW) = 100kHz
- Set the video bandwidth (VBW) $\geq 3 \times$ RBW, Detector = Peak.
- Trace mode = max hold.
- Sweep = auto couple.
- Measure the maximum width of the emission that is constrained by the frequencies associated with the two amplitude points (upper and lower) that are attenuated by 6 dB relative to the maximum level measured in the fundamental emission

4.3.5 Deviation from Test Standard

No deviation.

4.3.6 EUT Operating Conditions

The software provided by client to enable the EUT under transmission condition continuously at lowest, middle and highest channel frequencies individually.

4.3.7 Test Result

Channel	Frequency (GHz)	6dB Bandwidth (MHz)
1	58.32	1407.00
2	60.48	1767.00
3	62.64	1587.00
4	64.8	1131.00

Spectrum Plot of Worst Value

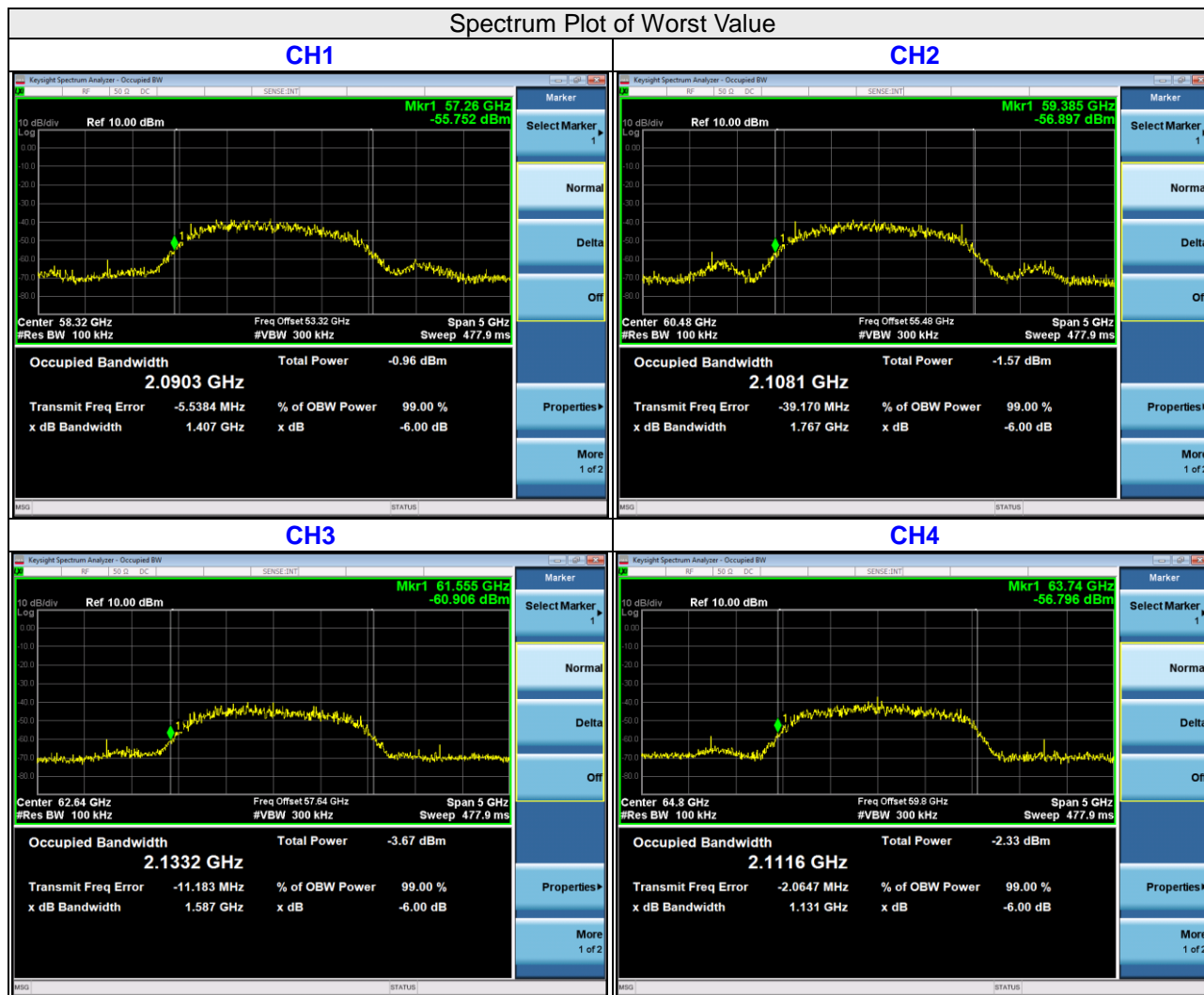

4.4 Output Power Measurement

4.4.1 Limits of Output Power Measurement

15.255 (c) & (e)

Output Power (EIRP)					
Applicable	Type		Average EIRP Power	Peak EIRP Power	
	Fixed field disturbance sensors and short-range devices for interactive motion sensing	(a)	For fixed field disturbance sensors that occupy 500 MHz or less of bandwidth and that are contained wholly within the frequency band 61.0-61.5 GHz	40dBm (*Note 3)	43dBm (*Note 3)
		(b)	For fixed field disturbance sensors other than those operating under the provisions of (a) above, and short-range devices for interactive motion sensing	-	10dBm
	Products other than fixed field disturbance sensors and short-range devices for interactive motion sensing	(c)	For fixed point-to-point transmitters located outdoors	82dBm (*Note 1)	85dBm (*Note 2)
V		(d)	For other devices	40dBm	43dBm

Note:

- The average power of any emission shall not exceed 82 dBm, and shall be reduced by 2 dB for every dB that the antenna gain is less than 51 dBi.
- The peak power of any emission shall not exceed 85 dBm, and shall be reduced by 2 dB for every dB that the antenna gain is less than 51 dBi.
- In addition, the average power of any emission outside of the 61.0-61.5 GHz band, measured during the transmit interval, but still within the 57-71 GHz band, shall not exceed 10 dBm, and the peak power of any emission shall not exceed 13 dBm.

Peak Output Power (Conducted Power)			
Applicable	Type	6dB Bandwidth	Maximum Conducted Power
	For fixed field disturbance sensors other than those operating under the provisions of (a) above, and short-range devices for interactive motion sensing	-	-10 dBm (0.1mW)
V	Other	Greater than or equal to 100 MHz	500mW
		Less than 100MHz	500mW x (B/100)

Note:

- B is 6dB Bandwidth (measured with a 100kHz resolution bandwidth)
- Peak transmitter output power shall be measured with an RF detector that has a detection bandwidth that encompasses the 57-71 GHz band and the has a video bandwidth of at least 10 MHz, or using an equivalent measurement method.
- For purposes of demonstrating compliance with this RSS, corrections to the transmitter output power may be made due to the antenna and circuit loss.

4.4.2 Test Setup

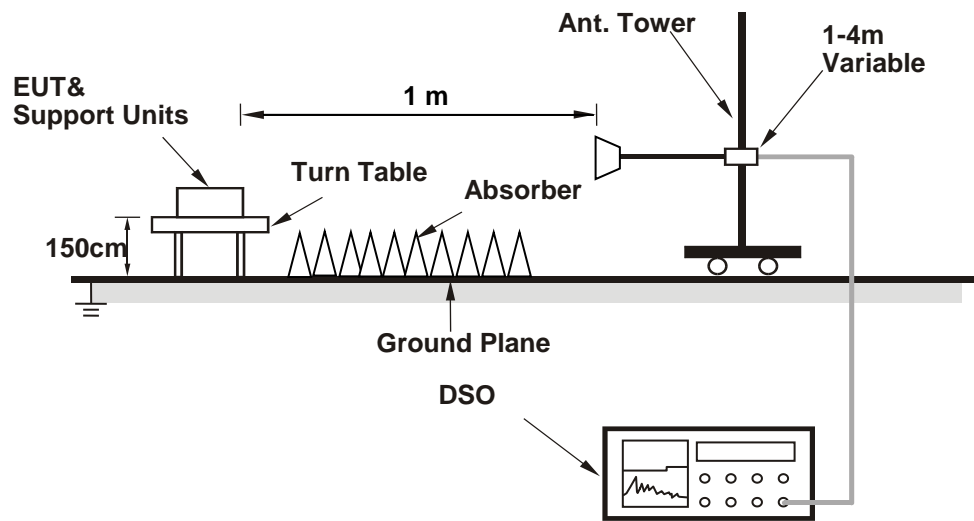

4.4.3 Test Instruments

Refer to section 4.1.2 to get information of above instrument.

4.4.4 Test Procedures

- a. Place the EUT in a continuous transmission mode.
- b. For radiated emission measurements, attach a test receive antenna for the fundamental frequency band to the RF input of an RF detector or a downconverter with an RF detector at the output.
- c. Connect the video output of the detector to the 50 ohm input of the DSO.
- d. Place the test receive antenna in the main beam of the EUT at a distance which will provide a signal within the operating range of the RF detector.
- e. Set the sampling rate of the DSO to the required value. Adjust the memory depth, the triggering and the sweep speed to obtain a display which is representative of the signal considering the type of modulation.
- f. For radiated emission measurements, calculate the distance to the far field boundary of the fundamental emission using following equation

$$R \text{ far field} = (2 * L^2) / \lambda$$

Where:

L is the Largest Antenna Dimension of either the EUT antenna or measurement antenna, including the reflector

λ is the wavelength

Frequency (GHz)	L (m)	Lambda (m)	R (Far Field) (m)
58.32	0.032	0.00514	0.398
60.48	0.032	0.00496	0.413
62.64	0.032	0.00479	0.428
64.8	0.032	0.00463	0.442

*Measurements made at 1 meter distance.

- g. Perform radiated emission measurements to keep maximize the received signal from the EUT in the far field.
- h. Record the average and peak from the DSO and the measurement distance.
- i. Disconnect the EUT from the RF input port of the instrumentation system.
- j. Connect a mm-wave source to the RF input port of the instrumentation system via a waveguide variable attenuator. The mm-wave source is unmodulated.
- k. Using substitution measurement.
- l. Measure and note the power.
- m. For conducted power measurements, calculate the conducted power using following equation

$$P_{\text{cond}} = \text{EIRP} - G_{\text{dBi}}$$

4.4.5 Deviation from Test Standard

No deviation.

4.4.6 EUT Operating Conditions

Same as Item 4.3.6.

4.4.7 Test Results

For Output Power (EIRP)

Channel	Frequency (GHz)	DSO Value (mV)	Power (dBm)	Gain of Test Antenna (dBi)	E _{Meas} (dBμV/m)	EIRP Level (dBm)	EIRP Limit (dBm)	Pass/Fail
1	58.32	12.10	-8.57	20.50	143.50	38.8 PK	43.00	Pass
		9.90	-9.23	20.50	142.84	38.14 AV	40.00	Pass
2	60.48	12.60	-7.77	20.50	144.62	39.92 PK	43.00	Pass
		10.37	-9.73	20.50	142.66	37.96 AV	40.00	Pass
3	62.64	13.70	-7.79	20.50	144.90	40.2 PK	43.00	Pass
		11.12	-9.71	20.50	142.98	38.28 AV	40.00	Pass
4	64.8	12.10	-9.41	20.50	143.58	38.88 PK	43.00	Pass
		8.98	-10.43	20.50	142.56	37.86 AV	40.00	Pass

Note:

1. The measured power level is converted to EIRP using the equation:

Follow ANSI 63.10 section 9.4 Equations to calculate and extrapolate field strength

$$E_{\text{Meas}} (\text{dB}\mu\text{V}/\text{m}) = 126.8 - 20\log(\lambda) + P - G$$

where:

E_{Meas} is the field strength of the emission at the measurement distance, in dBμV/m

P is the power measured at the output of the test antenna, in dBm

λ is the wavelength of the emission under investigation [300/fMHz], in m

G is the gain of the test antenna, in dBi

Follow ANSI 63.10 section 9.5 Equations to calculate EIRP

$$\text{EIRP Level (dBm/MHz)} = E_{\text{Meas}} (\text{dB}\mu\text{V}/\text{m}) + 20 \cdot \log(d_{\text{Meas}}) - 104.7$$

where:

EIRP is the equivalent isotropically radiated power, in dBm

E_{Meas} is the field strength of the emission at the measurement distance, in dBμV/m

d_{Meas} is the measurement distance, in m

Measurements made at 1 meter distance.

2. The EIRP was evaluated on vertical and horizontal polarization, the worst case is Vertical polarization.

For Peak Output Power (Conducted Power)

Channel	Frequency (GHz)	EIRP (dBm)	Max. Gain (dBi)	Conducted Output Power (dBm)	Conducted Output Power (mW)	Conducted Output Power limit (mW)	Pass /Fail
1	58.32	38.80	22	16.80	47.86	500	Pass
2	60.48	39.92	22	17.92	61.94	500	Pass
3	62.64	40.20	22	18.20	66.07	500	Pass
4	64.80	38.88	22	16.88	48.75	500	Pass

4.5 Frequency Stability Measurement

4.5.1 Limits of Frequency Stability Measurement

15.255(f) Fundamental emissions must be contained within the frequency bands specified in this section during all conditions of operation.

4.5.2 Test Setup

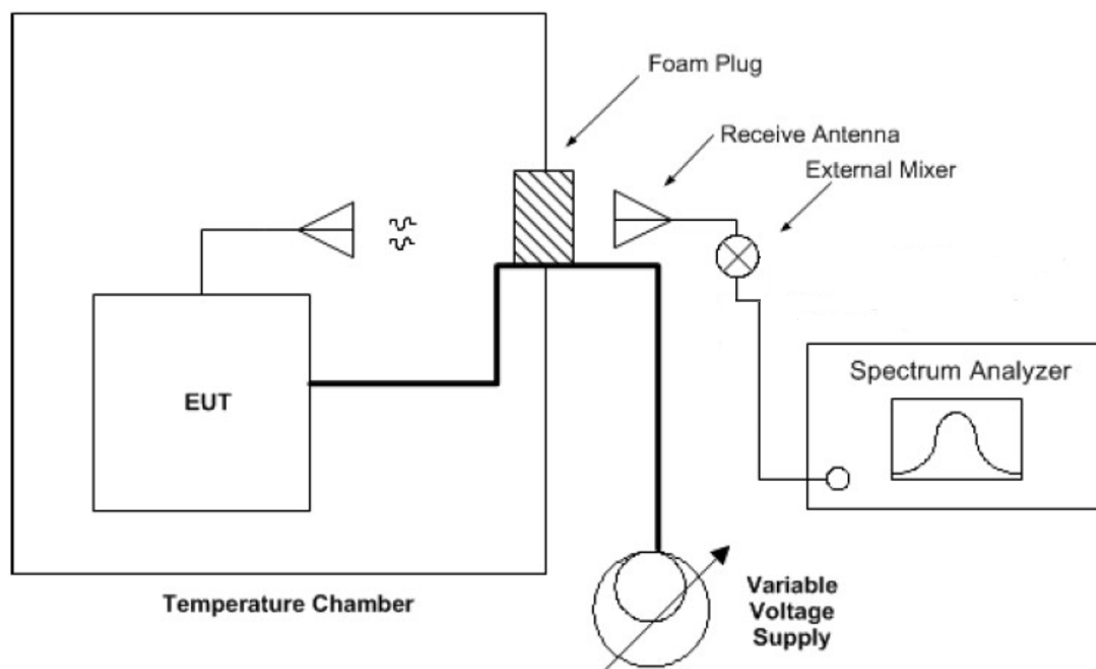

4.5.3 Test Instruments

DESCRIPTION & MANUFACTURER	MODEL NO.	SERIAL NO.	CALIBRATED DATE	CALIBRATED UNTIL
N9029AV15-DC9 - 50-75 GHz VDI Standard Downconverter with 9VDC supply Keysight	SA Extension WR15	SAX 381	CoC	CoC
*Conical Horn Antenna (50~75GHz) Keysight	WR15CH-Conical	WR15CH_001	Jan. 20, 2020	Jan. 19, 2022
Spectrum Analyzer Keysight	N9030A	MY55330160	Feb. 07, 2020	Feb. 06, 2021
DC Power Supply Topward	6603D	795558	NA	NA
Temperature & Humidity Chamber Giant Force	GTH-150-40-SP-AR	MAA0812-008	Jan. 16, 2020	Jan. 15, 2021
True RMS Clamp Meter FLUKE	325	31130711WS	June 06, 2020	June 05, 2021

- NOTE:**
1. The test was performed in Oven room 2.
 2. The calibration interval of the above test instruments is 12 months and the calibrations are traceable to NML/ROC and NIST/USA.
 3. Certificate of Conformance (CoC) which is issued by manufacturer states that the product meets the specification.
 4. Tested Date: Dec. 08, 2020

4.5.4 Test Procedure

- a. Arrange EUT and test equipment as above setup configuration.
- b. With the EUT at ambient temperature and voltage source set to the EUT nominal operating voltage (100%), record the spectrum mask of the EUT emission on the spectrum analyzer.
- c. Vary EUT power supply between 85% and 115% of nominal, and record the frequency excursion of the EUT emission mask.
- d. Set the power supply to 100% nominal setting, and raise EUT operating temperature to 55 °C. Record the frequency excursion of the EUT emission mask.
- e. Repeat step d) at each 10 °C increment down to -40 °C

4.5.5 Deviation from Test Standard

No deviation.

4.5.6 EUT Operating Condition

Same as Item 4.3.6

4.5.7 Test Results

Frequency Stability Versus Temp.													
Operating Frequency: 58320 MHz													
TEMP. (°C)	Power Supply (Vdc)	0 minutes			2 minutes			5 minutes			10 minutes		
		FL(MHz)	FH(MHz)	PASS/ FAIL	FL(MHz)	FH(MHz)	PASS/ FAIL	FL(MHz)	FH(MHz)	PASS/ FAIL	FL(MHz)	FH(MHz)	PASS/ FAIL
55	48	57244.91	59394.33	PASS	57244.90	59394.35	PASS	57244.93	59394.33	PASS	57244.93	59394.31	PASS
50	48	57245.22	59394.52	PASS	57245.25	59394.53	PASS	57245.27	59394.55	PASS	57245.23	59394.52	PASS
40	48	57244.80	59394.48	PASS	57244.85	59394.48	PASS	57244.85	59394.48	PASS	57244.82	59394.49	PASS
30	48	57245.22	59394.27	PASS	57245.17	59394.31	PASS	57245.21	59394.27	PASS	57245.22	59394.29	PASS
20	48	57245.09	59394.18	PASS	57245.13	59394.23	PASS	57245.14	59394.18	PASS	57245.11	59394.19	PASS
10	48	57244.91	59394.56	PASS	57244.90	59394.55	PASS	57244.95	59394.53	PASS	57244.94	59394.55	PASS
0	48	57245.05	59394.11	PASS	57245.04	59394.16	PASS	57245.04	59394.16	PASS	57245.02	59394.16	PASS
-10	48	57244.84	59394.46	PASS	57244.83	59394.50	PASS	57244.83	59394.49	PASS	57244.85	59394.49	PASS
-20	48	57245.02	59394.12	PASS	57244.99	59394.08	PASS	57245.03	59394.12	PASS	57245.00	59394.12	PASS
-30	48	57245.21	59394.29	PASS	57245.23	59394.32	PASS	57245.21	59394.29	PASS	57245.22	59394.30	PASS
-40	48	57245.12	59394.11	PASS	57245.13	59394.14	PASS	57245.12	59394.13	PASS	57245.12	59394.14	PASS

Frequency Stability Versus Voltage													
Operating Frequency: 58320 MHz													
TEMP. (°C)	Power Supply (Vdc)	0 minutes			2 minutes			5 minutes			10 minutes		
		FL(MHz)	FH(MHz)	PASS/ FAIL	FL(MHz)	FH(MHz)	PASS/ FAIL	FL(MHz)	FH(MHz)	PASS/ FAIL	FL(MHz)	FH(MHz)	PASS/ FAIL
20	55.2	57245.09	59360.47	PASS	57245.14	59360.50	PASS	57245.14	59360.45	PASS	57245.11	59360.48	PASS
	48	57245.09	59360.46	PASS	57245.13	59360.50	PASS	57245.14	59360.46	PASS	57245.11	59360.49	PASS
	40.8	57245.09	59360.45	PASS	57245.13	59360.49	PASS	57245.14	59360.46	PASS	57245.11	59360.48	PASS

5 Pictures of Test Arrangements

Please refer to the attached file (Test Setup Photo).

Appendix – Information of the Testing Laboratories

We, Bureau Veritas Consumer Products Services (H.K.) Ltd., Taoyuan Branch, were founded in 1988 to provide our best service in EMC, Radio, Telecom and Safety consultation. Our laboratories are FCC recognized accredited test firms and accredited according to ISO/IEC 17025.

If you have any comments, please feel free to contact us at the following:

Lin Kou EMC/RF Lab

Tel: 886-2-26052180

Fax: 886-2-26051924

Hsin Chu EMC/RF/Telecom Lab

Tel: 886-3-6668565

Fax: 886-3-6668323

Hwa Ya EMC/RF/Safety Lab

Tel: 886-3-3183232

Fax: 886-3-3270892

Email: service.adt@tw.bureauveritas.com

Web Site: www.bureauveritas-adt.com

The address and road map of all our labs can be found in our web site also.

--- END ---