



# FCC RF Test Report

**APPLICANT** : Ubiquiti Networks, Inc.  
**EQUIPMENT** : Access Point  
**BRAND NAME** : UBIQUITI  
**MODEL NAME** : UAP-IW  
**FCC ID** : SWX-UAPIW  
**STANDARD** : FCC Part 15 Subpart C §15.247  
**CLASSIFICATION** : (DTS) Digital Transmission System

The product was received on Aug. 05, 2015 and testing was completed on Aug. 26, 2015. We, SPORTON INTERNATIONAL INC., would like to declare that the tested sample has been evaluated in accordance with the test procedures and has been in compliance with the applicable technical standards.

The test results in this report apply exclusively to the tested model / sample. Without written approval of SPORTON INTERNATIONAL INC., the test report shall not be reproduced except in full.

Reviewed by: Joseph Lin / Supervisor

Approved by: Jones Tsai / Manager



**SPORTON INTERNATIONAL INC.**

No. 52, Hwa Ya 1<sup>st</sup> Rd., Hwa Ya Technology Park, Kwei-Shan District, Tao Yuan City, Taiwan, R.O.C.



# TABLE OF CONTENTS

**REVISION HISTORY ..... 3**

**SUMMARY OF TEST RESULT ..... 4**

**1 GENERAL DESCRIPTION ..... 5**

    1.1 Applicant ..... 5

    1.2 Manufacturer ..... 5

    1.3 Product Feature of Equipment Under Test ..... 5

    1.4 Product Specification subjective to this standard ..... 6

    1.5 Modification of EUT ..... 6

    1.6 Testing Location ..... 7

    1.7 Applicable Standards ..... 7

**2 TEST CONFIGURATION OF EQUIPMENT UNDER TEST ..... 8**

    2.1 Carrier Frequency Channel ..... 8

    2.2 Pre-Scanned RF Power ..... 9

    2.3 Test Mode ..... 10

    2.4 Connection Diagram of Test System ..... 11

    2.5 Support Unit used in test configuration and system ..... 12

    2.6 EUT Operation Test Setup ..... 12

    2.7 Measurement Results Explanation Example ..... 12

**3 TEST RESULT ..... 13**

    3.1 6dB and 99% Bandwidth Measurement ..... 13

    3.2 Output Power Measurement ..... 15

    3.3 Power Spectral Density Measurement ..... 17

    3.4 Conducted Band Edges and Spurious Emission Measurement ..... 19

    3.5 Radiated Band Edges and Spurious Emission Measurement ..... 32

    3.6 AC Conducted Emission Measurement ..... 36

    3.7 Antenna Requirements ..... 40

**4 LIST OF MEASURING EQUIPMENT ..... 41**

**5 UNCERTAINTY OF EVALUATION ..... 42**

**APPENDIX A. CONDUCTED TEST RESULTS**

**APPENDIX B. RADIATED TEST RESULTS**

**APPENDIX C. SETUP PHOTOGRAPHS**





### SUMMARY OF TEST RESULT

Report Section	FCC Rule	IC Rule	Description	Limit	Result	Remark
3.1	15.247(a)(2)	RSS-247 5.2(1)	6dB Bandwidth	$\geq 0.5\text{MHz}$	Pass	-
3.1	-	RSS-Gen 6.6	99% Bandwidth	-	Pass	-
3.2	15.247(b)	RSS-247 A5.4(4)	Power Output Measurement	$\leq 30\text{dBm}$	Pass	-
3.3	15.247(e)	RSS-247 5.2(2)	Power Spectral Density	$\leq 8\text{dBm}/3\text{kHz}$	Pass	-
3.4	15.247(d)	RSS-247 5.5	Conducted Band Edges	$\leq 20\text{dBc}$	Pass	-
			Conducted Spurious Emission		Pass	-
3.5	15.247(d)	RSS-247 5.5	Radiated Band Edges and Radiated Spurious Emission	15.209(a) & 15.247(d)	Pass	Under limit 0.12 dB at 4926.000 MHz
3.6	15.207	RSS-GEN 8.8	AC Conducted Emission	15.207(a)	Pass	Under limit 16.00 dB at 6.942 MHz
3.7	15.203 & 15.247(b)	N/A	Antenna Requirement	N/A	Pass	-



# 1 General Description

## 1.1 Applicant

Ubiquiti Networks, Inc.

12F, No.105, Song Ren Rd.,SinYi District, Taipei 110,Taiwan

## 1.2 Manufacturer

Ubiquiti Networks, Inc.

12F, No.105, Song Ren Rd.,SinYi District, Taipei 110,Taiwan

## 1.3 Product Feature of Equipment Under Test

Product Feature	
Equipment	Access Point
Brand Name	UBIQUITI
Model Name	UAP-IW
FCC ID	SWX-UAPIW
EUT supports Radios application	WLAN 11b/g/n HT20/HT40
EUT Stage	Identical Prototype

**Remark:** The above EUT's information was declared by manufacturer. Please refer to the specifications or user's manual for more detailed description.



### 1.4 Product Specification subjective to this standard

Product Specification subjective to this standard	
<b>Tx/Rx Channel Frequency Range</b>	802.11b/g/n : 2412 MHz ~ 2462 MHz
<b>Maximum (Peak) Output Power to Antenna</b>	802.11b : 14.67 dBm (0.0293 W) 802.11g : 20.48 dBm (0.1117 W) 802.11n HT20 : 20.39 dBm (0.1094 W) 802.11n HT40 : 19.26 dBm (0.0843 W)
<b>99% Occupied Bandwidth</b>	802.11b : 14.00MHz 802.11g : 17.05MHz 802.11n HT20 : 18.15MHz 802.11n HT40 : 37.60MHz
<b>Antenna Type</b>	802.11b/g/n : PIFA Antenna type with gain 1.00 dBi
<b>Type of Modulation</b>	802.11b : DSSS (DBPSK / DQPSK / CCK) 802.11g/n : OFDM (BPSK / QPSK / 16QAM / 64QAM)

### 1.5 Modification of EUT

No modifications are made to the EUT during all test items.



### 1.6 Testing Location

Sporton Lab is accredited to ISO 17025 by Taiwan Accreditation Foundation (TAF code : 1190) and the FCC designation No. TW1022 under the FCC 2.948(e) by Mutual Recognition Agreement (MRA) in FCC Test.

<b>Test Site</b>	SPORTON INTERNATIONAL INC.	
<b>Test Site Location</b>	No. 52, Hwa Ya 1 <sup>st</sup> Rd., Hwa Ya Technology Park, Kwei-Shan District, Tao Yuan City, Taiwan, R.O.C. TEL: +886-3-327-3456 FAX: +886-3-328-4978	
<b>Test Site No.</b>	<b>Sporton Site No.</b>	
	TH02-HY	CO05-HY

**Note:** The test site complies with ANSI C63.4 2009 requirement.

<b>Test Site Location</b>	No. 52, Hwa Ya 1 <sup>st</sup> Rd., Hwa Ya Technology Park, Kwei-Shan District, Tao Yuan City, Taiwan, R.O.C. TEL: +886-3-3273456 / FAX: +886-3-3284978	
<b>Test Site No.</b>	<b>Sporton Site No.</b>	
	03CH11-HY	

**Note:** The test site complies with ANSI C63.4 2009 requirement.

### 1.7 Applicable Standards

According to the specifications of the manufacturer, the EUT must comply with the requirements of the following standards:

- FCC Part 15 Subpart C §15.247
- FCC KDB Publication No. 558074 D01 DTS Meas. Guidance v03r03
- ANSI C63.10-2009

**Remark:**

1. All test items were verified and recorded according to the standards and without any deviation during the test.
2. FCC permits the use of the 1.5 meter table as an alternative in C63.10-2013 through inquiry tracking number 961829.
3. This EUT has also been tested and complied with the requirements of FCC Part 15, Subpart B, recorded in a separate test report.



## 2 Test Configuration of Equipment Under Test

The EUT has been associated with peripherals and configuration operated in a manner tended to maximize its emission characteristics in a typical application. Frequency range investigated: conducted emission (150 kHz to 30 MHz) and radiated emission (9 kHz to the 10th harmonic of the highest fundamental frequency or to 40 GHz, whichever is lower).

The final configuration from all the combinations and the worst-case data rates were investigated by measuring the maximum power across all the data rates and modulation modes under section 2.2.

Based on the worst configuration found above, the RF power setting is set individually to meet FCC compliance limit for the final conducted and radiated tests shown in section 2.3.

### 2.1 Carrier Frequency Channel

Frequency Band	Channel	Freq. (MHz)	Channel	Freq. (MHz)
2400-2483.5 MHz	1	2412	7	2442
	2	2417	8	2447
	3	2422	9	2452
	4	2427	10	2457
	5	2432	11	2462
	6	2437	-	-





## 2.2 Pre-Scanned RF Power

Preliminary tests were performed in different data rate and data rate associated with the highest power were chosen for full test shown in the following tables.

2.4GHz 802.11b mode				
Data Rate (MHz)	1M bps	2M bps	5.5M bps	11M bps
Peak Power (dBm)	14.67	14.65	14.64	14.65

2.4GHz 802.11g mode								
Data Rate (MHz)	6M bps	9M bps	12M bps	18M bps	24M bps	36M bps	48M bps	54M bps
Peak Power (dBm)	20.48	20.29	20.34	20.30	20.40	20.47	20.46	20.47

2.4GHz 802.11n HT20 mode								
Data Rate (MHz)	MCS0	MCS1	MCS2	MCS3	MCS4	MCS5	MCS6	MCS7
Peak Power (dBm)	20.39	20.15	20.31	20.30	20.35	20.38	20.37	20.37

2.4GHz 802.11n HT40 mode								
Data Rate (MHz)	MCS0	MCS1	MCS2	MCS3	MCS4	MCS5	MCS6	MCS7
Peak Power (dBm)	19.26	19.11	18.90	18.89	18.81	19.25	19.23	19.21



### 2.3 Test Mode

Final test mode of conducted test items and radiated spurious emissions are considering the modulation and worse data rates from the power table described in section 2.2.

<2.4GHz>

Modulation	Data Rate
802.11b	1 Mbps
802.11g	6 Mbps
802.11n HT20	MCS0
802.11n HT40	MCS0

Test Cases	
AC Conducted Emission	Mode 1 : WLAN Link + LAN Link + Switch + Camera

## 2.4 Connection Diagram of Test System

<WLAN Tx Mode>

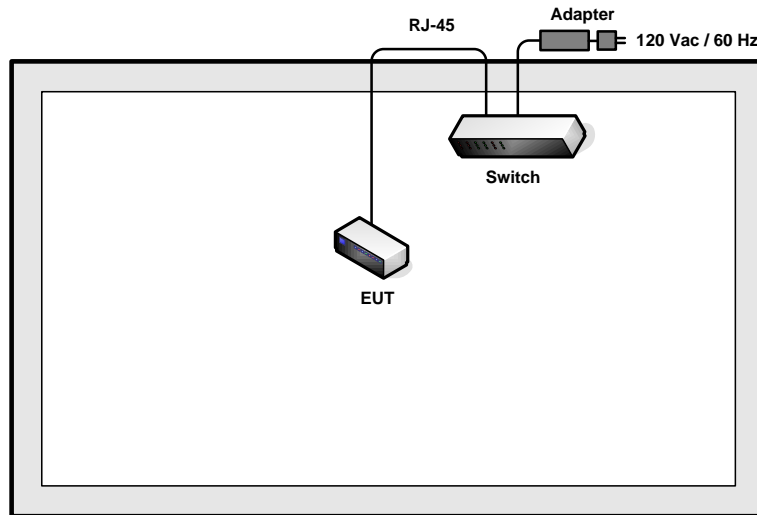

<AC Conducted Emission Mode>

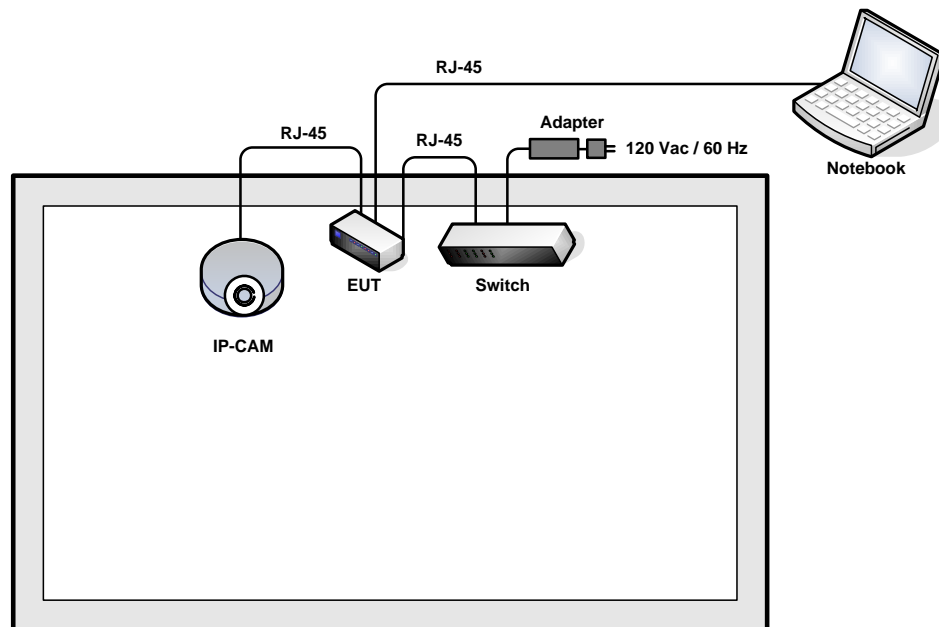



### 2.5 Support Unit used in test configuration and system

Item	Equipment	Trade Name	Model Name	FCC ID	Data Cable	Power Cord
1.	Notebook	DELL	Latitude E6320	FCC DoC/ Contains FCC ID: QDS-BRCM1054	N/A	AC I/P: Unshielded, 1.2 m DC O/P: Shielded, 1.8 m
2.	Notebook	Lenovo	M490S	QDS-BRCM1063	N/A	AC I/P: Unshielded, 1.2 m DC O/P: Shielded, 1.8 m
3.	IP-CAM	Ubiquity	G3 UVC DOME	FCC DoC	N/A	Shielded, 0.5m
4.	Switch	UBNT	ES-16-150W	N/A	N/A	Unshielded, 1.0 m

### 2.6 EUT Operation Test Setup

For WLAN function, programmed RF utility, "CMD" installed in the notebook make the EUT provide functions like channel selection and power level for continuous transmitting and receiving signals.

### 2.7 Measurement Results Explanation Example

For all conducted test items:

The offset level is set in the spectrum analyzer to compensate the RF cable loss and attenuator factor between EUT conducted output port and spectrum analyzer. With the offset compensation, the spectrum analyzer reading level is exactly the EUT RF output level.

Example :

The spectrum analyzer offset is derived from RF cable loss and attenuator factor.

*Offset = RF cable loss + attenuator factor.*

Following shows an offset computation example with cable loss 4.2 dB and 10dB attenuator.

$$\begin{aligned}
 \text{Offset(dB)} &= \text{RF cable loss(dB)} + \text{attenuator factor(dB)}. \\
 &= 4.2 + 10 = 14.2 \text{ (dB)}
 \end{aligned}$$

### 3 Test Result

#### 3.1 6dB and 99% Bandwidth Measurement

##### 3.1.1 Limit of 6dB and 99% Bandwidth

The minimum 6 dB bandwidth shall be at least 500 kHz.

##### 3.1.2 Measuring Instruments

The measuring equipment is listed in the section 4 of this test report.

##### 3.1.3 Test Procedures

1. The testing follows FCC KDB Publication No. 558074 DTS D01 Meas. Guidance v03r03.
2. The RF output of EUT was connected to the spectrum analyzer by RF cable and attenuator. The path loss was compensated to the results for each measurement.
3. Set to the maximum power setting and enable the EUT transmit continuously.
4. Make the measurement with the spectrum analyzer's resolution bandwidth (RBW) = 100 kHz. Set the Video bandwidth (VBW) = 300 kHz. In order to make an accurate measurement. The 6 dB bandwidth must be greater than 500 kHz.
5. For 99% Bandwidth Measurement, the spectrum analyzer's resolution bandwidth (RBW) = 1MHz and set the Video bandwidth (VBW) = 3MHz.
6. Measure and record the results in the test report.

##### 3.1.4 Test Setup





### 3.1.5 Test Result of 6dB and 99% Occupied Bandwidth

Please refer to Appendix A of this test report.

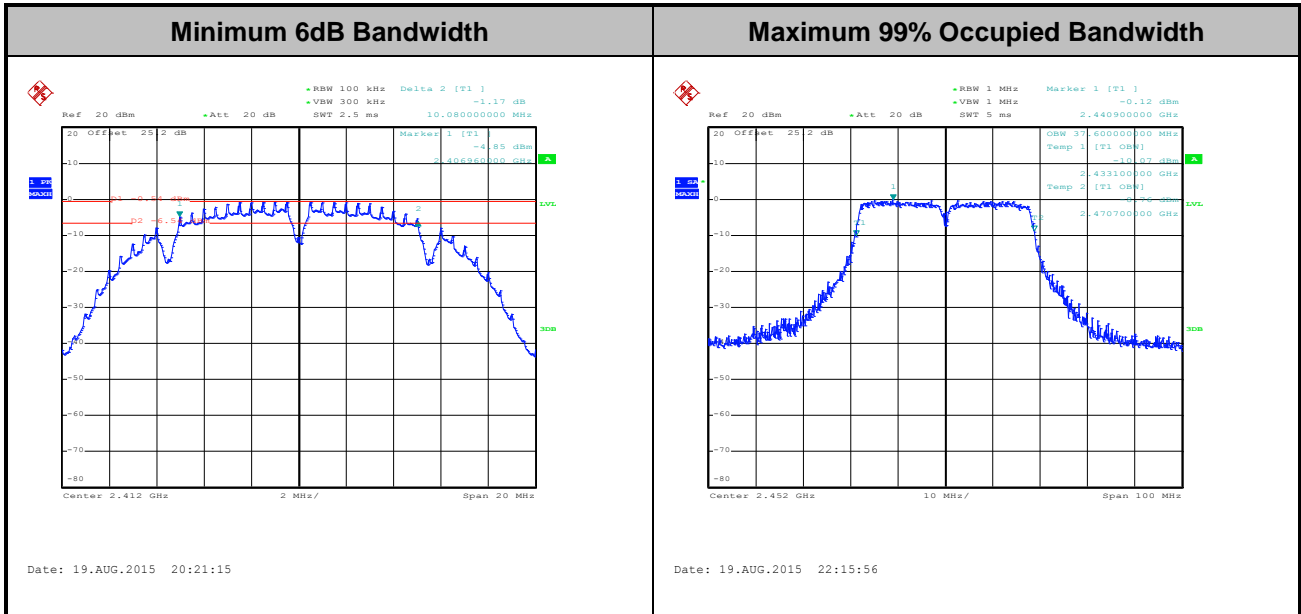

Note : The occupied channel bandwidth is maintained within the band of operation for all of the modulations.

## 3.2 Output Power Measurement

### 3.2.1 Limit of Output Power

For systems using digital modulation in the 2400-2483.5MHz, the limit for peak output power is 30dBm. If transmitting Antenna of directional gain greater than 6dBi are used the peak output power from the intentional radiator shall be reduced below the above stated value by the amount in dB that the directional gain of the Antenna exceeds 6 dBi. In case of point-to-point operation, the limit has to be reduced by 1dB for every 3dB that the directional gain of the Antenna exceeds 6dBi.

### 3.2.2 Measuring Instruments

The measuring equipment is listed in the section 4 of this test report.

### 3.2.3 Test Procedures

1. The testing follows the Measurement Procedure of FCC KDB No. 558074 DTS D01 Meas. Guidance v03r03.
2. The RF output of EUT was connected to the power meter by RF cable and attenuator. The path loss was compensated to the results for each measurement.
3. Set to the maximum power setting and enable the EUT transmit continuously.
4. Measure the conducted output power and record the results in the test report.

### 3.2.4 Test Setup

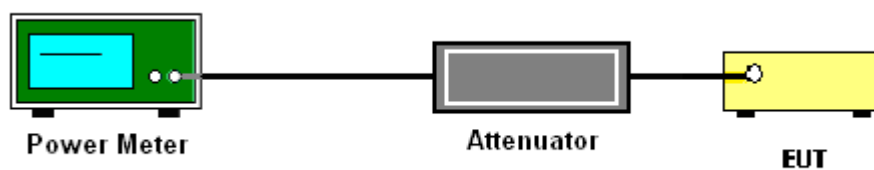



### **3.2.5 Test Result of Peak Output Power**

Please refer to Appendix A of this test report.

### **3.2.6 Test Result of Average output Power (Reporting Only)**

Please refer to Appendix A of this test report.



### 3.3 Power Spectral Density Measurement

#### 3.3.1 Limit of Power Spectral Density

The peak power spectral density shall not be greater than 8dBm in any 3kHz band at any time interval of continuous transmission.

#### 3.3.2 Measuring Instruments

The measuring equipment is listed in the section 4 of this test report.

#### 3.3.3 Test Procedures

1. The testing follows Measurement Procedure 10.2 Method PKPSD of FCC KDB Publication No. 558074 D01 DTS Meas. Guidance v03r03
2. The RF output of EUT was connected to the spectrum analyzer by RF cable and attenuator. The path loss was compensated to the results for each measurement.
3. Set to the maximum power setting and enable the EUT transmit continuously.
4. Make the measurement with the spectrum analyzer's resolution bandwidth (RBW) = 3 kHz. Video bandwidth VBW = 10 kHz In order to make an accurate measurement, set the span to 1.5 times DTS Channel Bandwidth. (6dB BW)
5. Detector = peak, Sweep time = auto couple, Trace mode = max hold, Allow trace to fully stabilize. Use the peak marker function to determine the maximum power level.
6. Measure and record the results in the test report.

#### 3.3.4 Test Setup

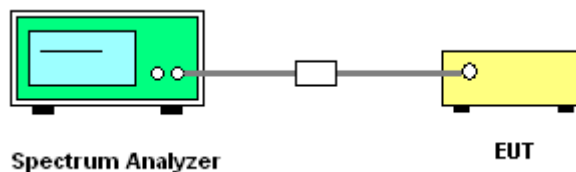



### 3.3.5 Test Result of Power Spectral Density

Please refer to Appendix A of this test report.

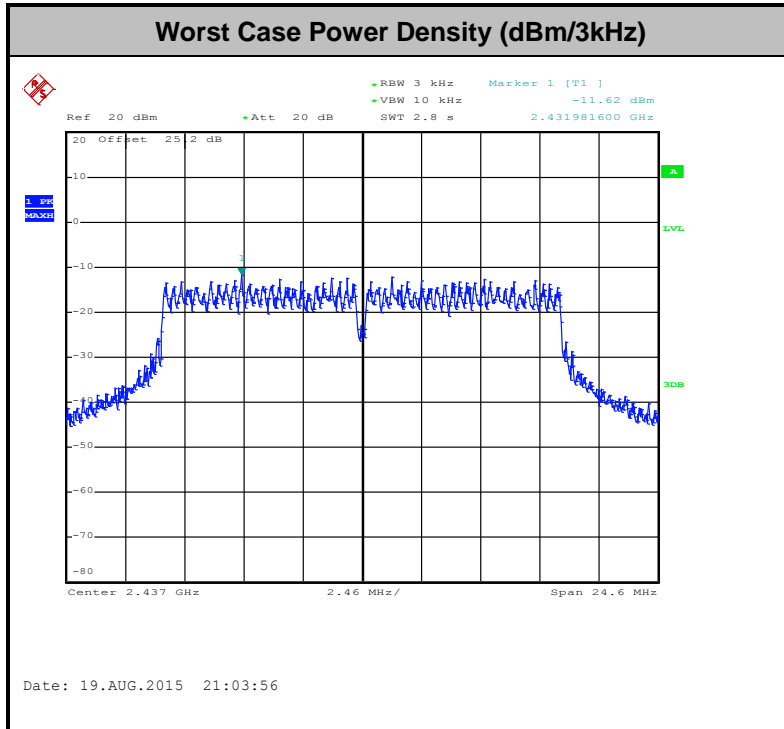

## 3.4 Conducted Band Edges and Spurious Emission Measurement

### 3.4.1 Limit of Conducted Band Edges and Spurious Emission Measurement

In any 100 kHz bandwidth outside of the authorized frequency band, the emissions which fall in the non-restricted bands shall be attenuated at least 20 dB / 30dB relative to the maximum PSD level in 100 kHz by RF conducted measurement and radiated emissions which fall in the restricted bands, as defined in Section 15.205(a), must also comply with the radiated emission limits specified in Section 15.209(a).

### 3.4.2 Measuring Instruments

The measuring equipment is listed in the section 4 of this test report.

### 3.4.3 Test Procedures

1. The testing follows FCC KDB Publication No. 558074 D01 DTS Meas. Guidance v03r03.
2. The RF output of EUT was connected to the spectrum analyzer by RF cable and attenuator. The path loss was compensated to the results for each measurement.
3. Set to the maximum power setting and enable the EUT transmit continuously.
4. Set RBW = 100 kHz, VBW=300 kHz, Peak Detector. Unwanted Emissions measured in any 100 kHz bandwidth outside of the authorized frequency band shall be attenuated by at least 20 dB relative to the maximum in-band peak PSD level in 100 kHz when maximum peak conducted output power procedure is used. If the transmitter complies with the conducted power limits based on the use of RMS averaging over a time interval, the attenuation required under this paragraph shall be 30 dB instead of 20 dB per 15.247(d).
5. Measure and record the results in the test report.
6. The RF fundamental frequency should be excluded against the limit line in the operating frequency band.

### 3.4.4 Test Setup

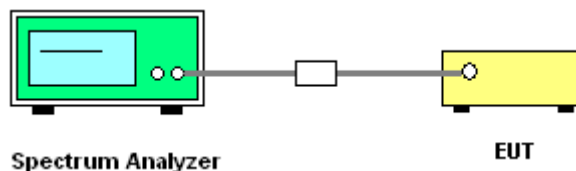



### 3.4.5 Test Result of Conducted Band Edges and Spurious Emission

Test Mode :	802.11b	Temperature :	21~25°C
Test Band :	2.4GHz Low	Relative Humidity :	51~54%
Test Channel :	01	Test Engineer :	Bill Kuo

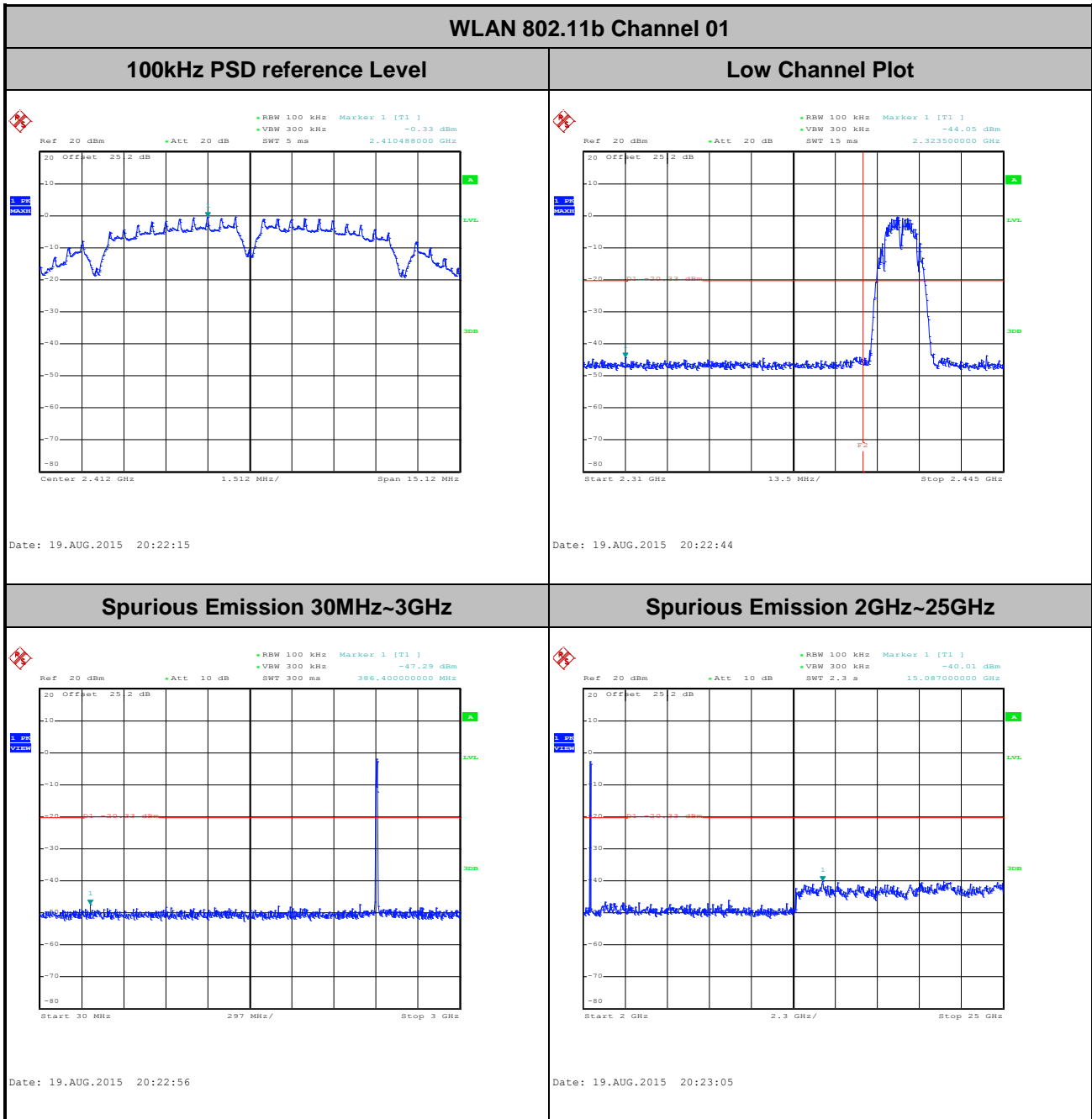



Test Mode :	802.11b	Temperature :	21~25°C
Test Band :	2.4GHz Mid	Relative Humidity :	51~54%
Test Channel :	06	Test Engineer :	Bill Kuo

WLAN 802.11b Channel 06

100kHz PSD reference Level

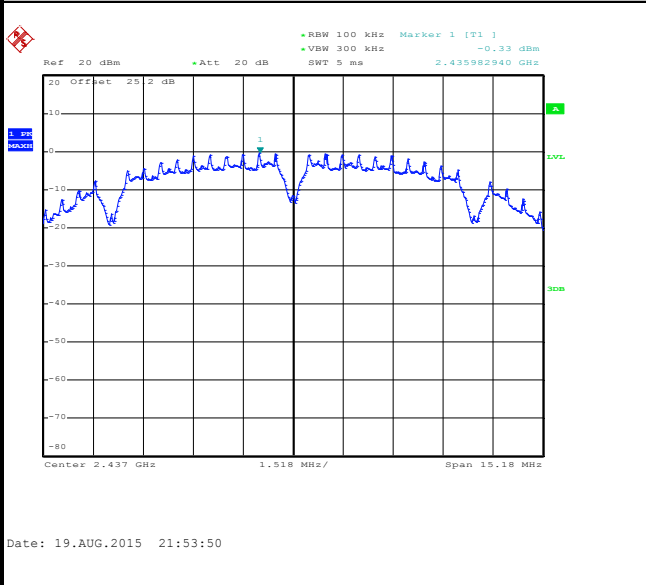

Spurious Emission 30MHz~3GHz

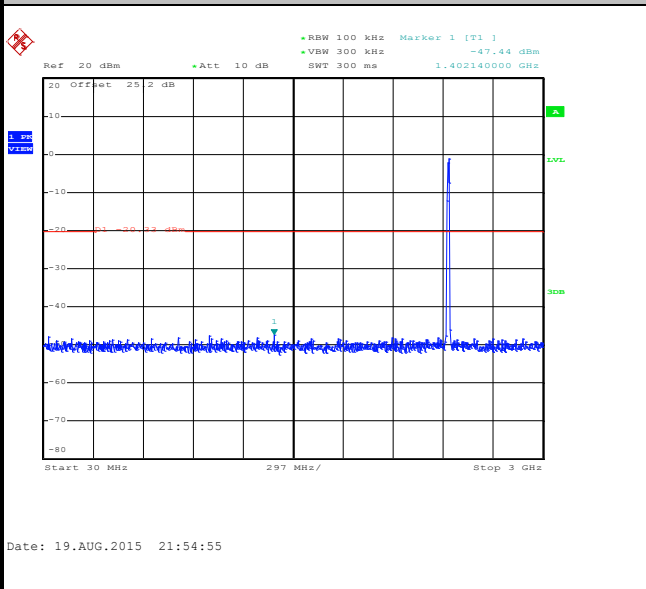

Spurious Emission 2GHz~25GHz

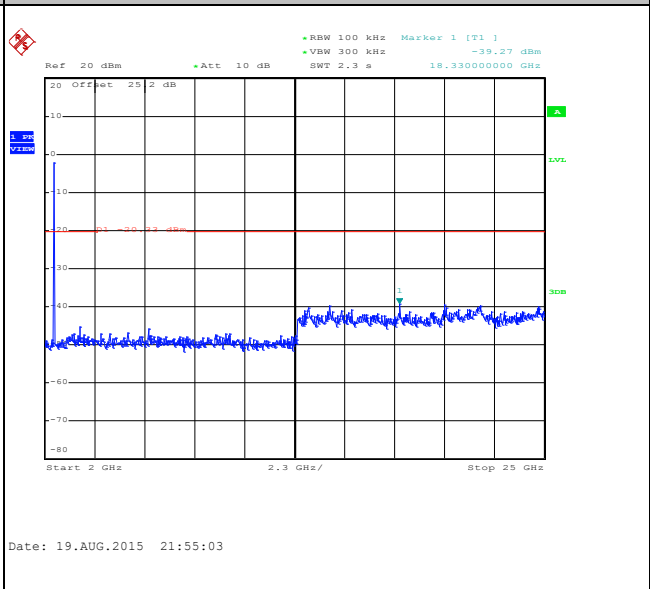



Test Mode :	802.11b	Temperature :	21~25°C
Test Band :	2.4GHz High	Relative Humidity :	51~54%
Test Channel :	11	Test Engineer :	Bill Kuo

WLAN 802.11b Channel 11

100kHz PSD reference Level

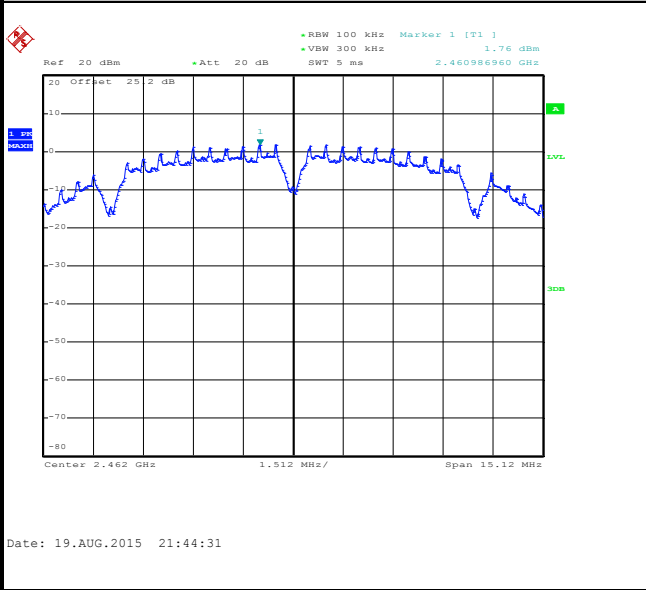

High Channel Plot

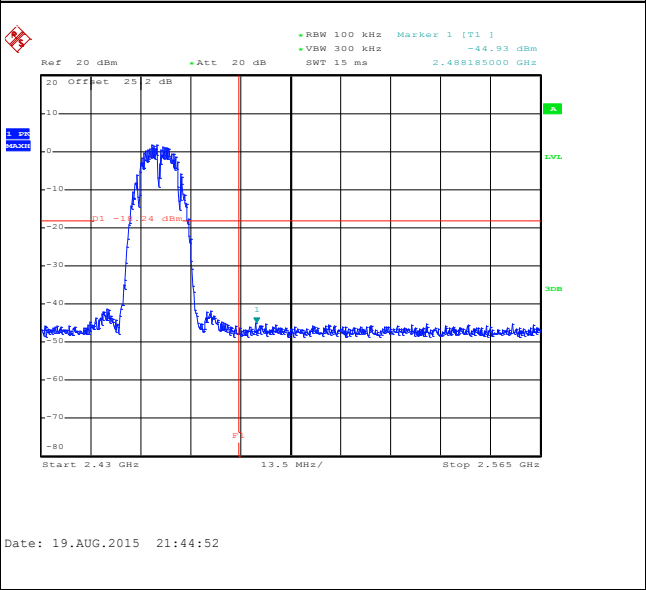

Spurious Emission 30MHz~3GHz

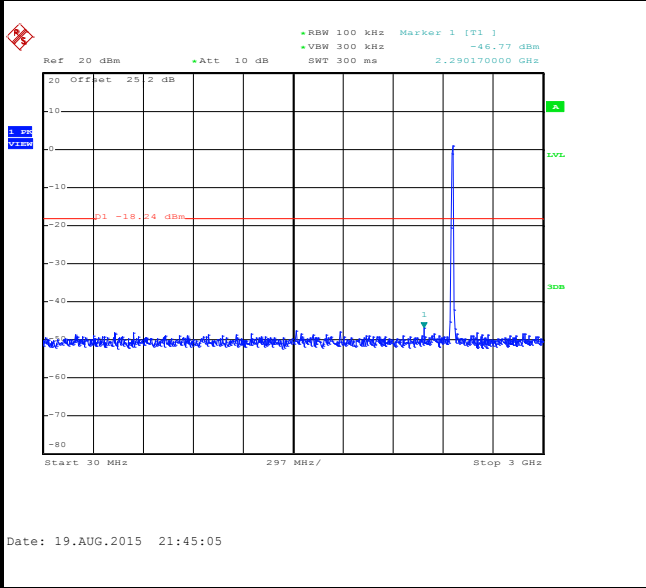

Spurious Emission 2GHz~25GHz

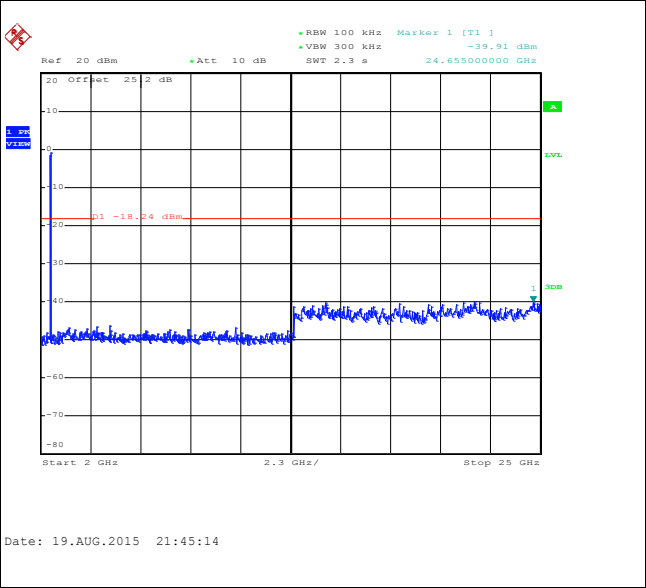



Test Mode :	802.11g	Temperature :	21~25°C
Test Band :	2.4GHz Low	Relative Humidity :	51~54%
Test Channel :	01	Test Engineer :	Bill Kuo

WLAN 802.11g Channel 01

100kHz PSD reference Level

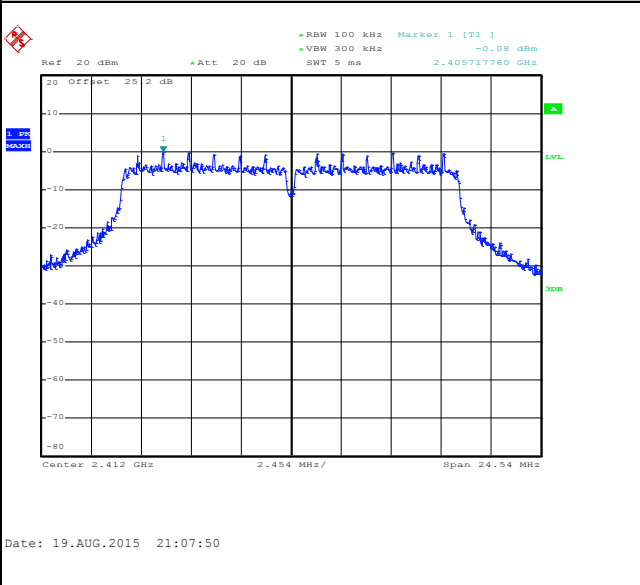

Low Channel Plot

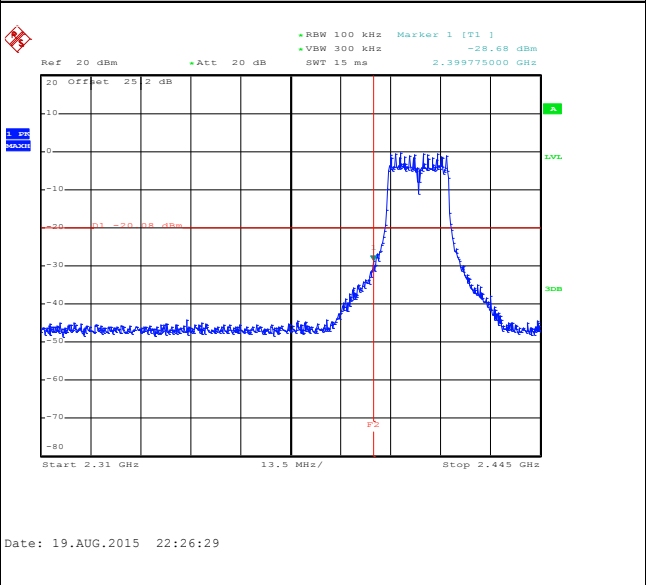

Spurious Emission 30MHz~3GHz

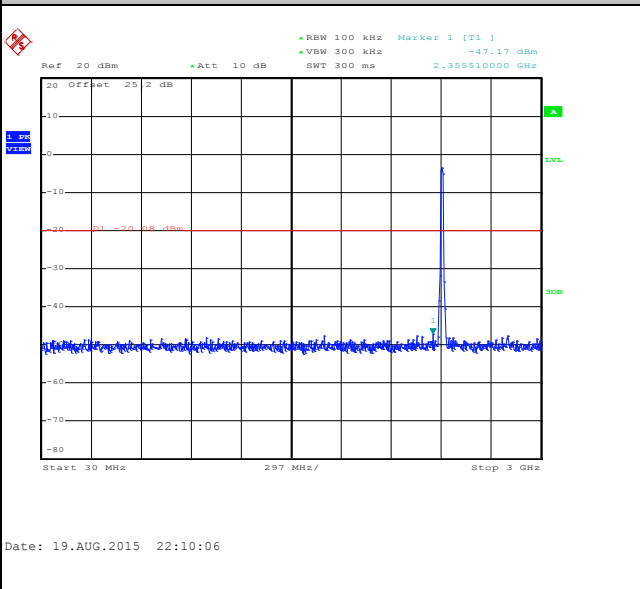

Spurious Emission 2GHz~25GHz

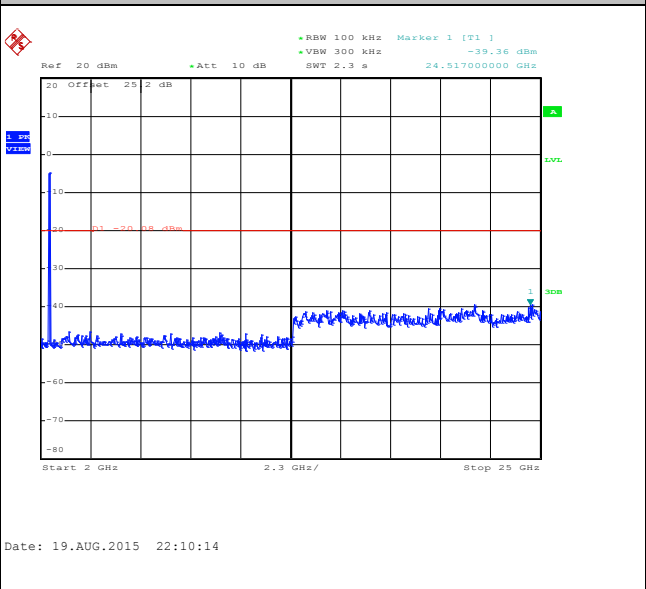



Test Mode :	802.11g	Temperature :	21~25°C
Test Band :	2.4GHz Mid	Relative Humidity :	51~54%
Test Channel :	06	Test Engineer :	Bill Kuo

WLAN 802.11g Channel 06

100kHz PSD reference Level

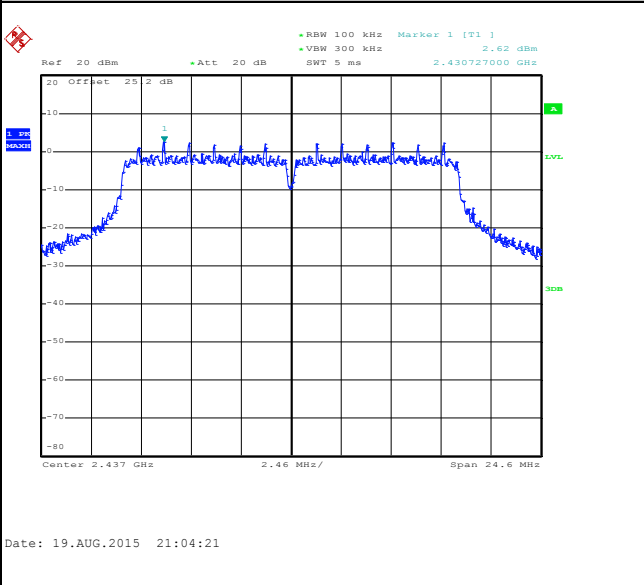

Spurious Emission 30MHz~3GHz

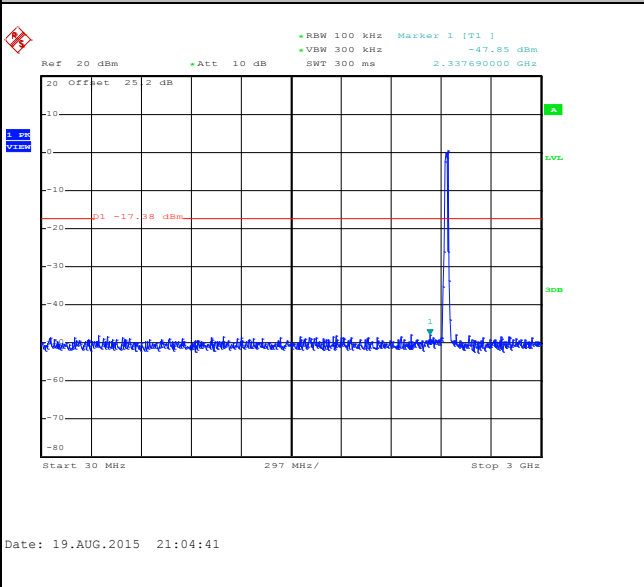

Spurious Emission 2GHz~25GHz

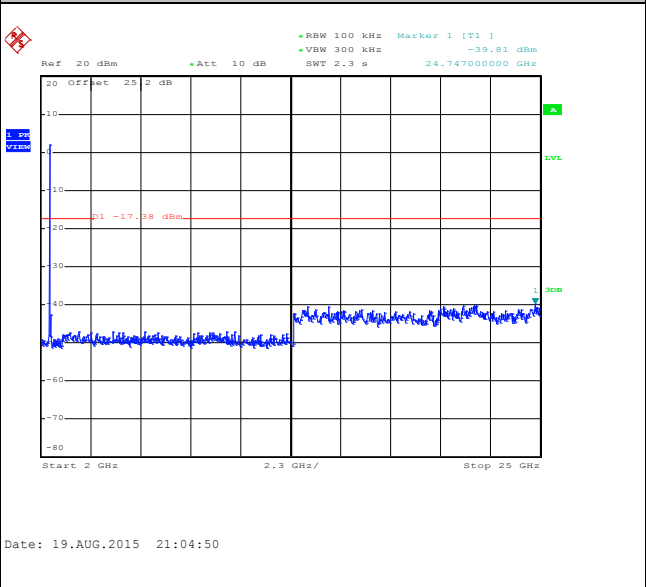





Test Mode :	802.11g	Temperature :	21~25°C
Test Band :	2.4GHz High	Relative Humidity :	51~54%
Test Channel :	11	Test Engineer :	Bill Kuo

WLAN 802.11g Channel 11

100kHz PSD reference Level

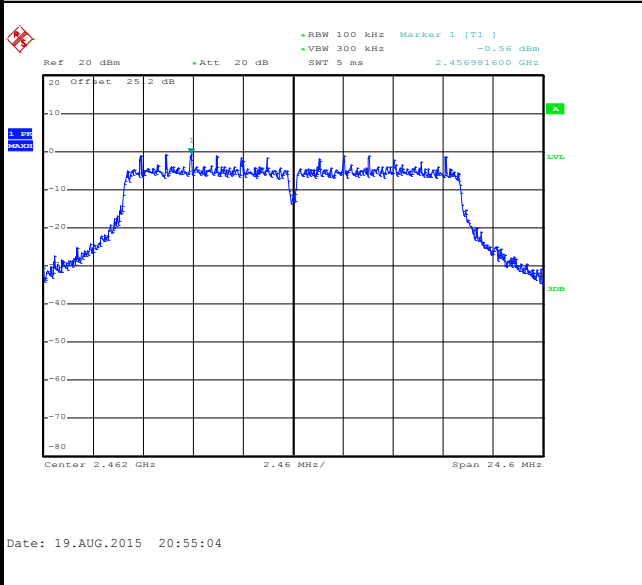

High Channel Plot

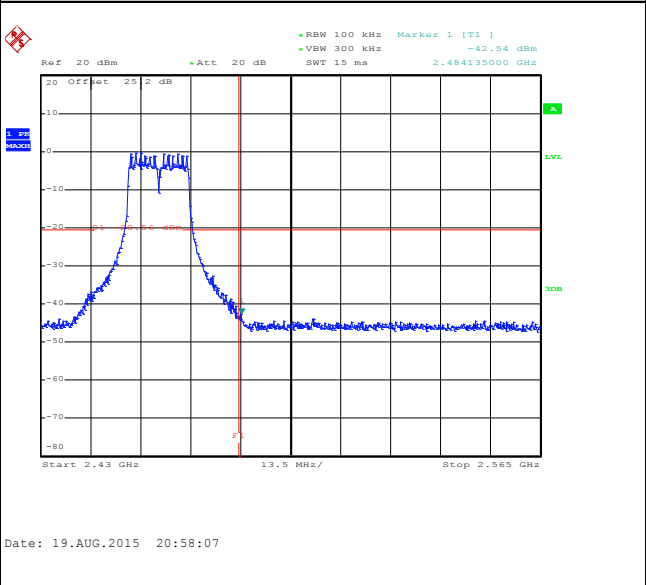

Spurious Emission 30MHz~3GHz

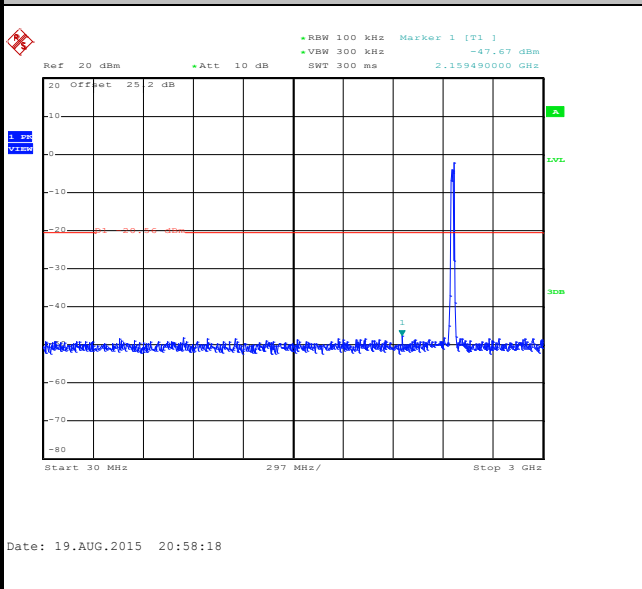

Spurious Emission 2GHz~25GHz

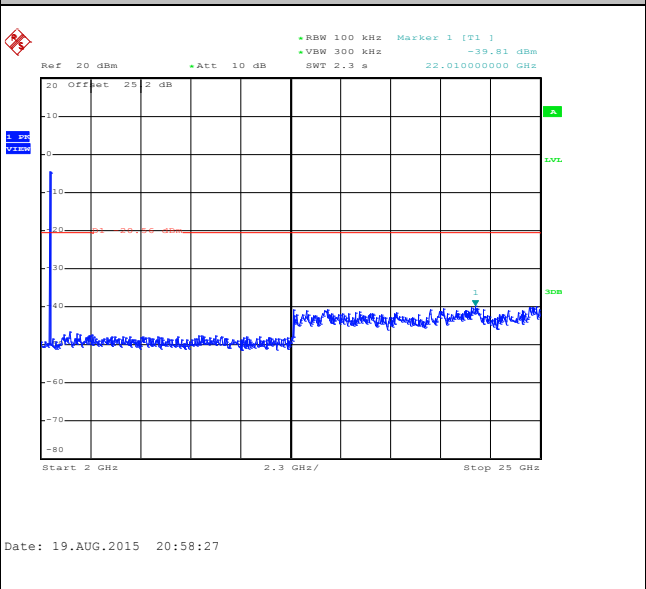



Test Mode :	802.11n HT20	Temperature :	21~25°C
Test Band :	2.4GHz Low	Relative Humidity :	51~54%
Test Channel :	01	Test Engineer :	Bill Kuo

WLAN 802.11n HT20 Channel 01

100kHz PSD reference Level

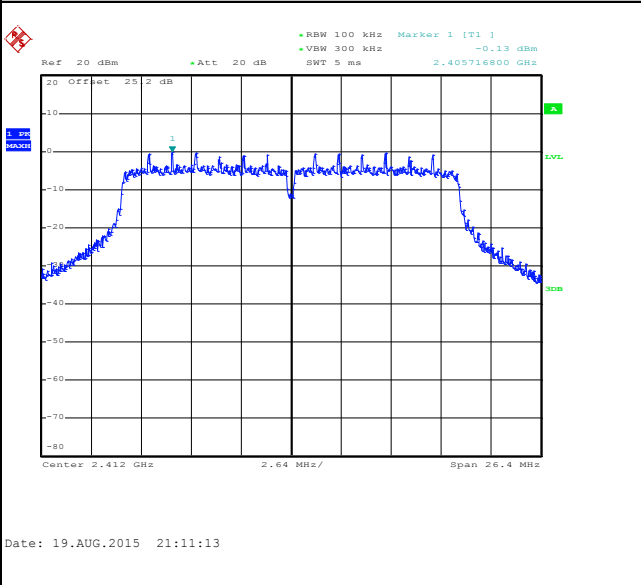

Low Channel Plot

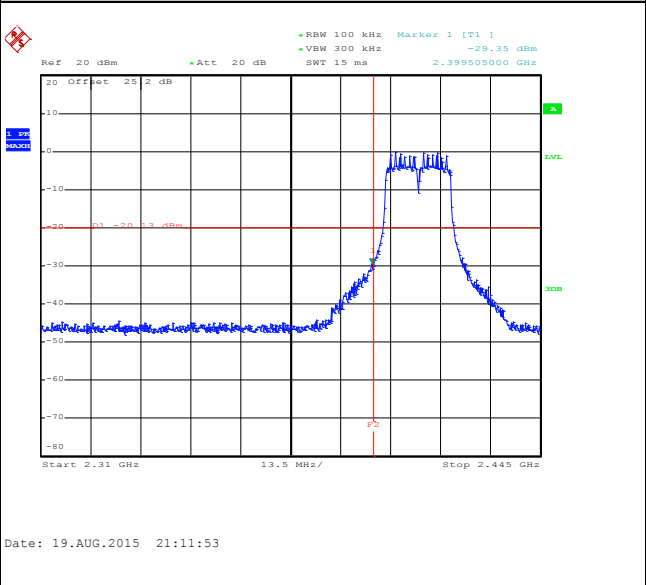

Spurious Emission 30MHz~3GHz

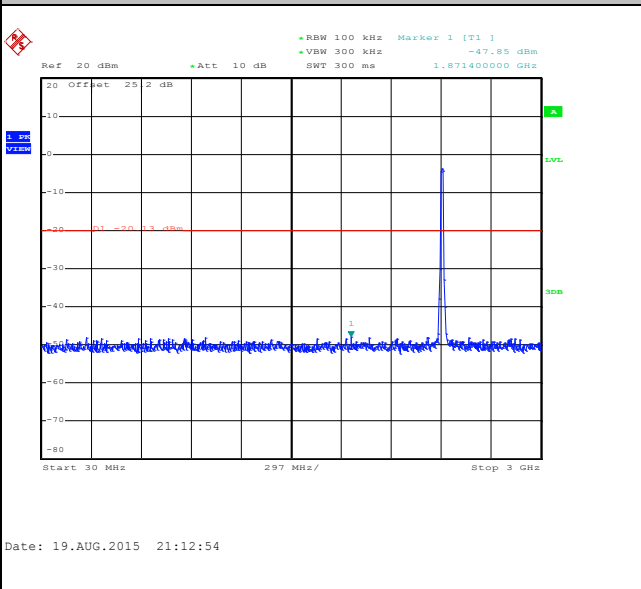

Spurious Emission 2GHz~25GHz

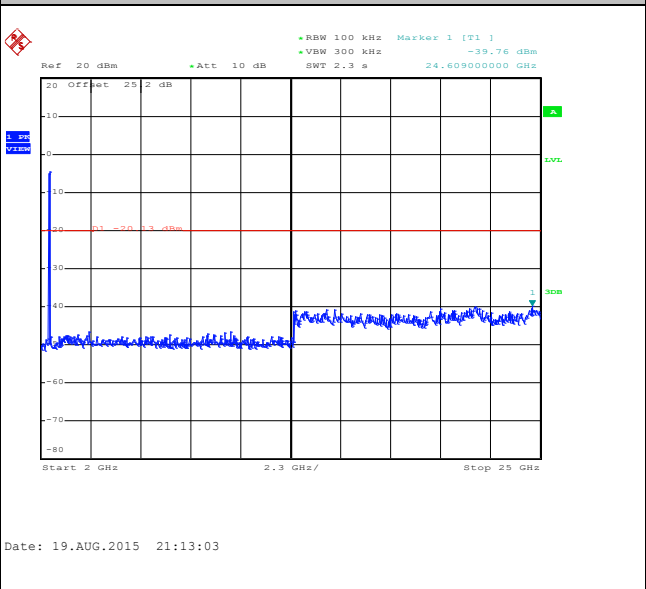



Test Mode :	802.11n HT20	Temperature :	21~25°C
Test Band :	2.4GHz Mid	Relative Humidity :	51~54%
Test Channel :	06	Test Engineer :	Bill Kuo

WLAN 802.11n HT20 Channel 06

100kHz PSD reference Level

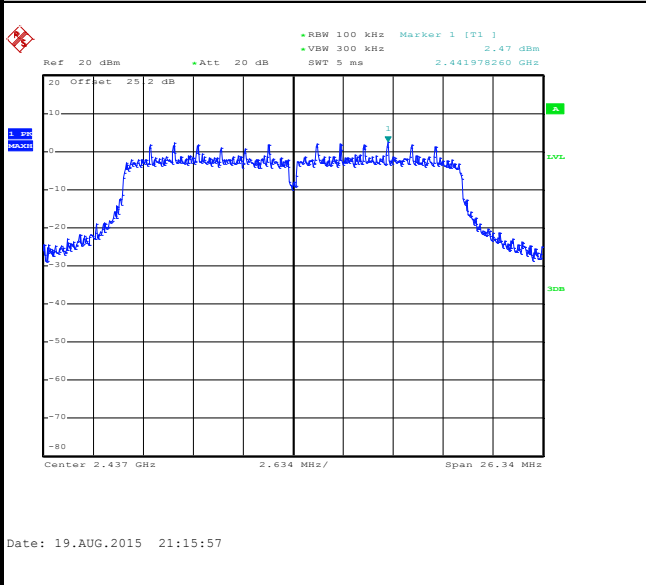

Spurious Emission 30MHz~3GHz

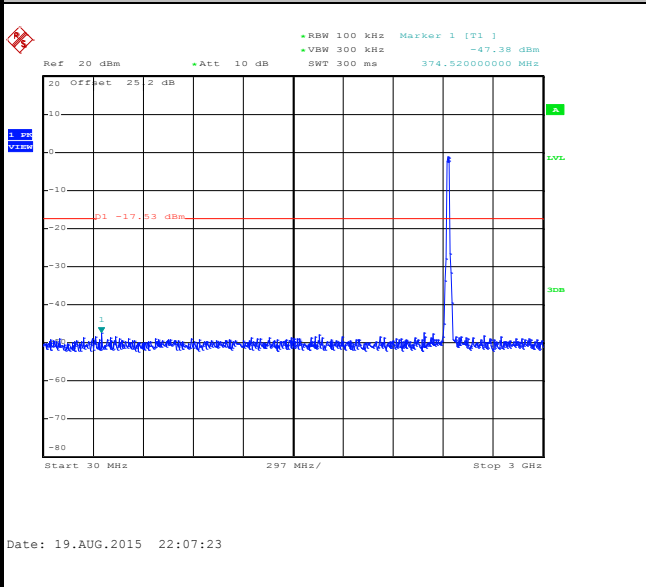

Spurious Emission 2GHz~25GHz

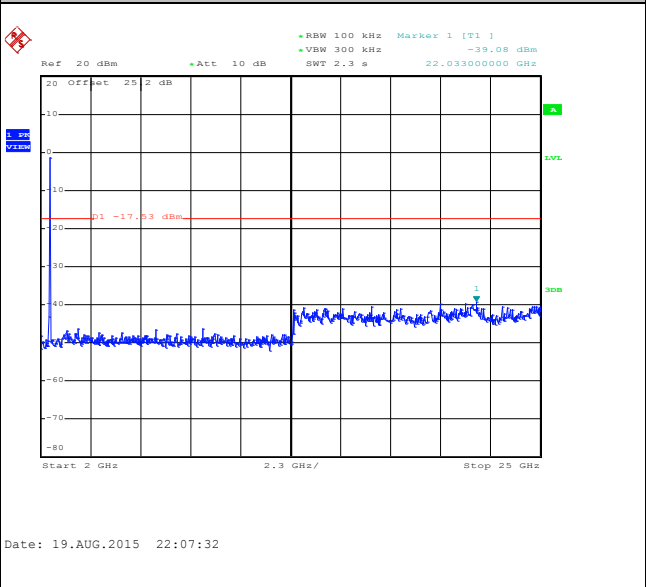



Test Mode :	802.11n HT20	Temperature :	21~25°C
Test Band :	2.4GHz High	Relative Humidity :	51~54%
Test Channel :	11	Test Engineer :	Bill Kuo

WLAN 802.11n HT20 Channel 11

100kHz PSD reference Level

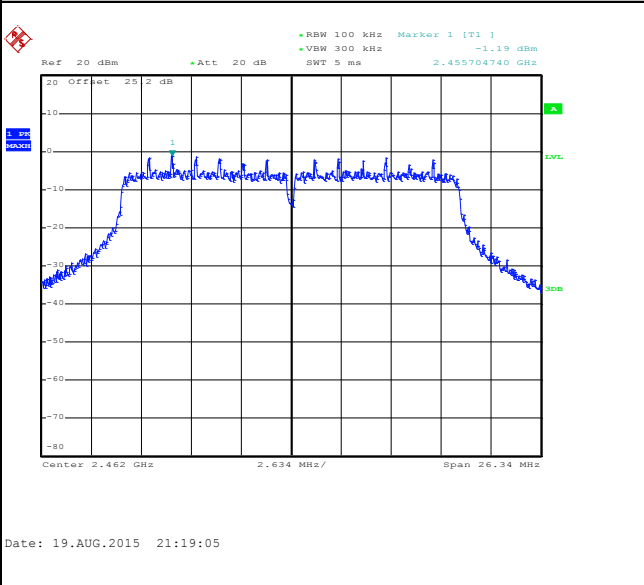

High Channel Plot

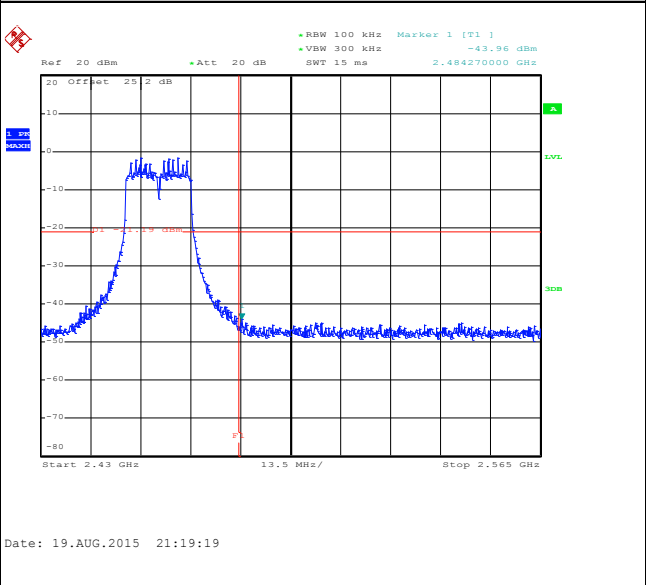

Spurious Emission 30MHz~3GHz

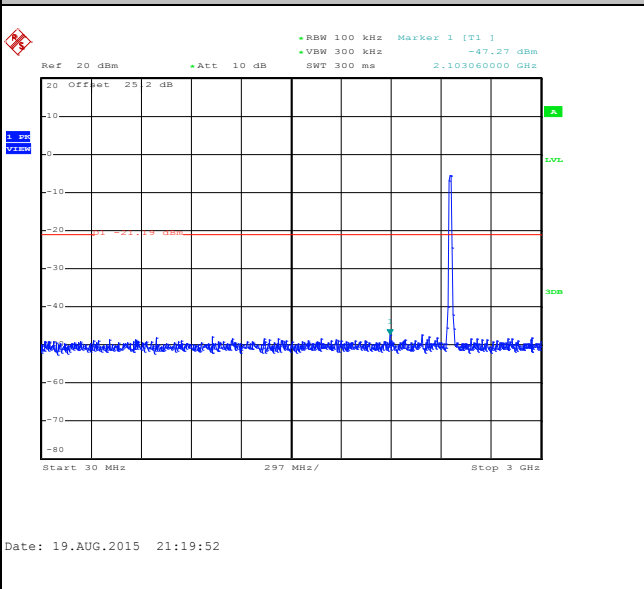

Spurious Emission 2GHz~25GHz

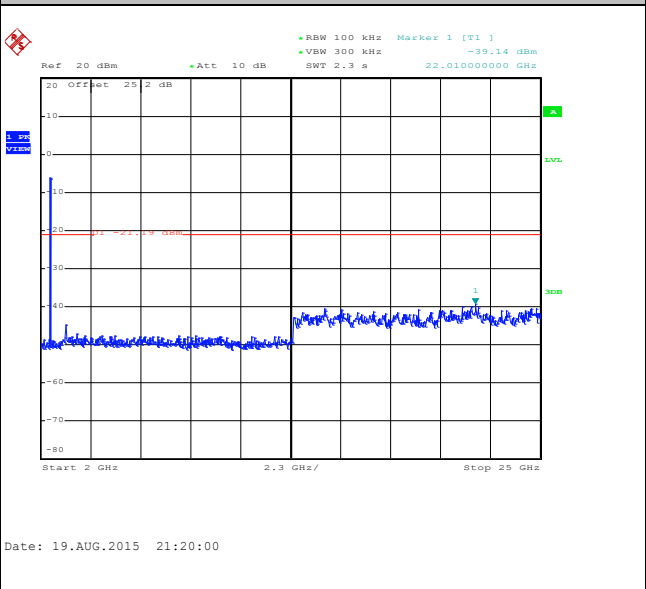



Test Mode :	802.11n HT40	Temperature :	21~25°C
Test Band :	2.4GHz Low	Relative Humidity :	51~54%
Test Channel :	03	Test Engineer :	Bill Kuo

WLAN 802.11n HT40 Channel 03

100kHz PSD reference Level

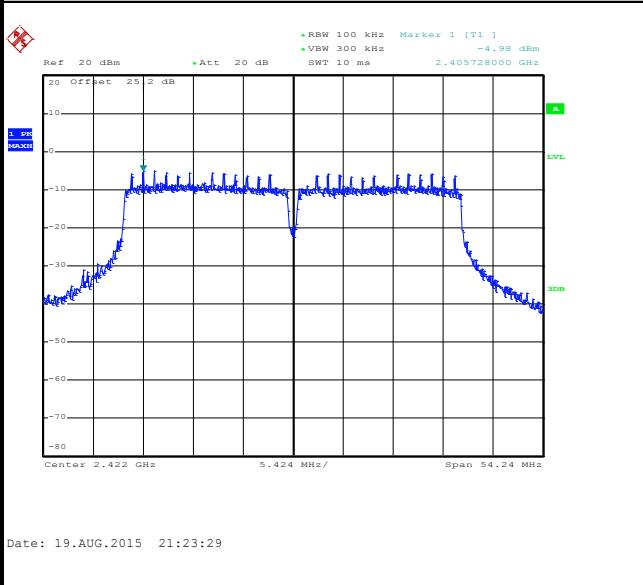

Low Channel Plot

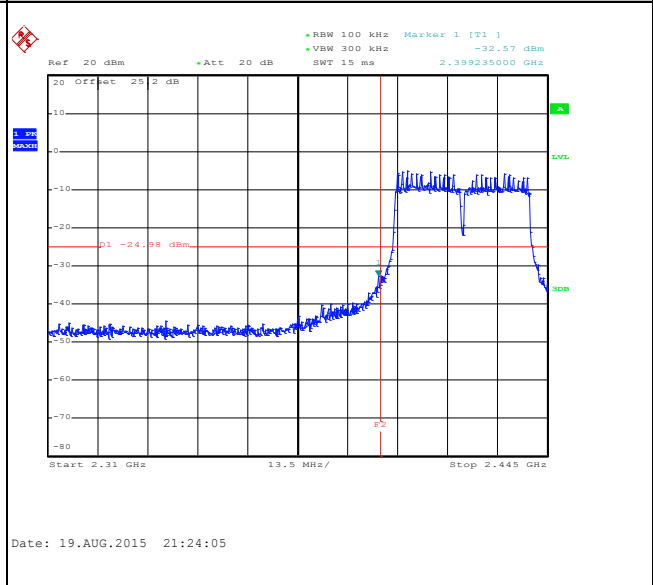

Spurious Emission 30MHz~3GHz

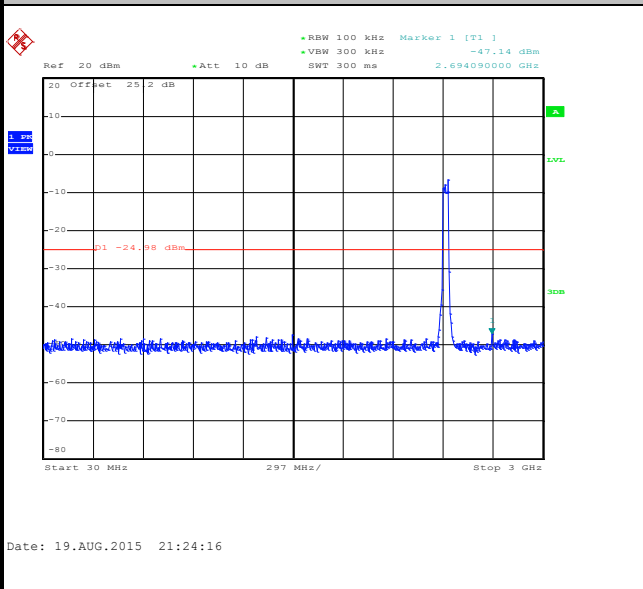

Spurious Emission 2GHz~25GHz

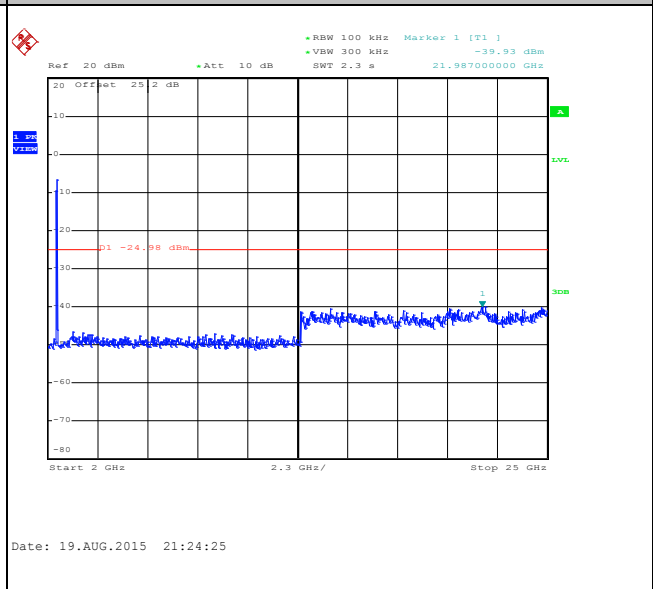



Test Mode :	802.11n HT40	Temperature :	21~25°C
Test Band :	2.4GHz Mid	Relative Humidity :	51~54%
Test Channel :	06	Test Engineer :	Bill Kuo

WLAN 802.11n HT40 Channel 06

100kHz PSD reference Level

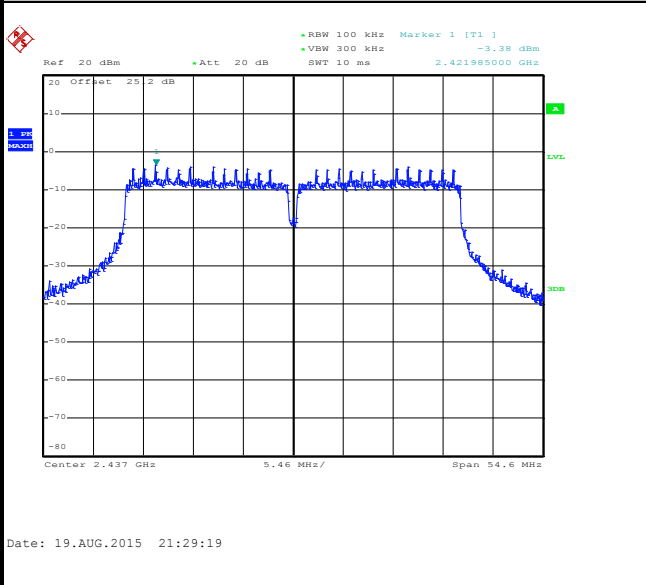

Spurious Emission 30MHz~3GHz

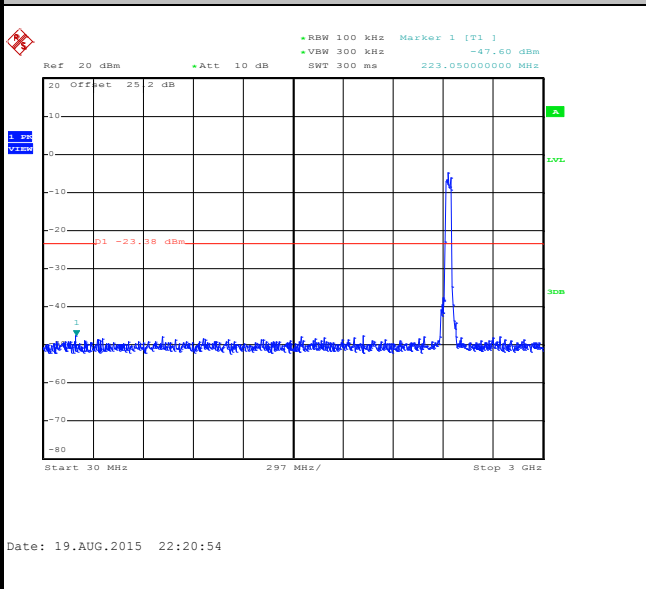

Spurious Emission 2GHz~25GHz

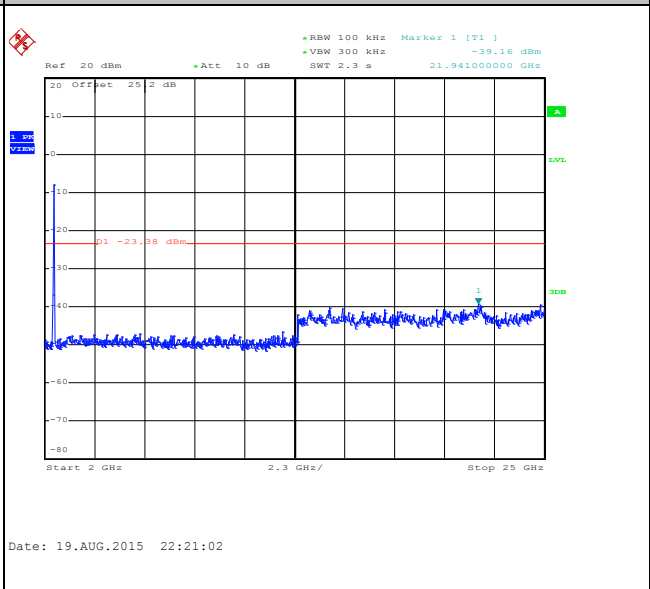



Test Mode :	802.11n HT40	Temperature :	21~25°C
Test Band :	2.4GHz High	Relative Humidity :	51~54%
Test Channel :	09	Test Engineer :	Bill Kuo

WLAN 802.11n HT40 Channel 09

100kHz PSD reference Level

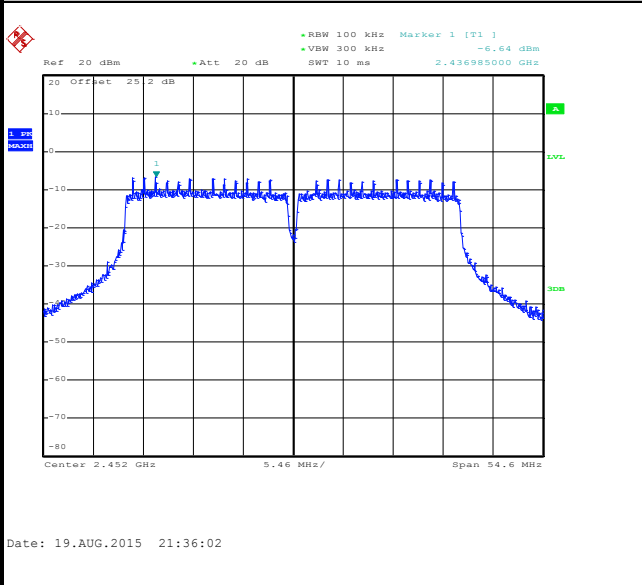

High Channel Plot

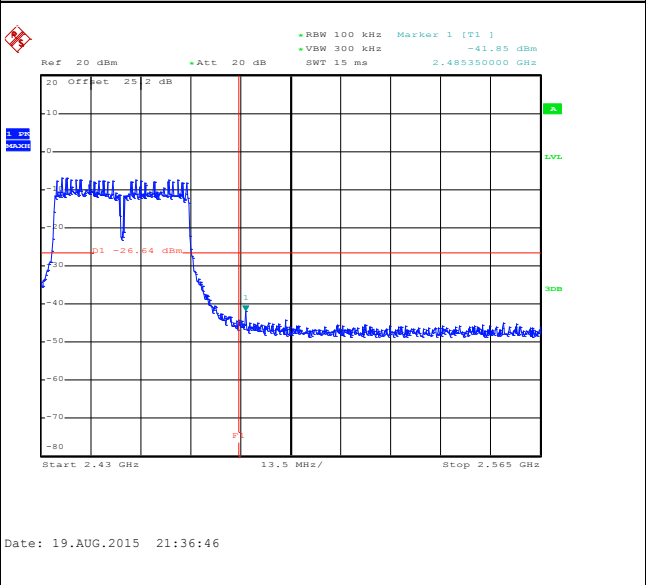

Spurious Emission 30MHz~3GHz

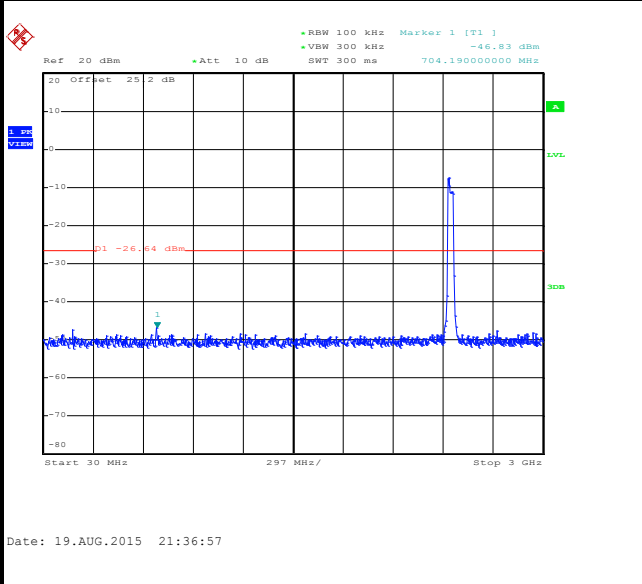

Spurious Emission 2GHz~25GHz

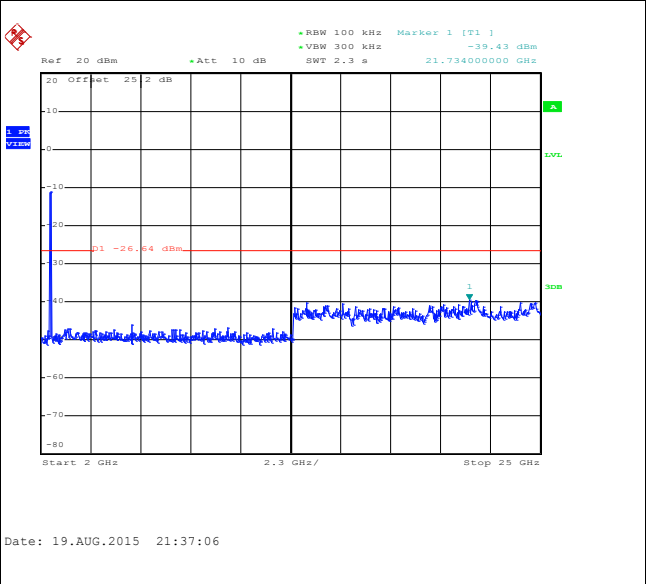



### 3.5 Radiated Band Edges and Spurious Emission Measurement

#### 3.5.1 Limit of Radiated band edge and Spurious Emission Measurement

In any 100 kHz bandwidth outside the intentional radiator frequency band, all harmonics/spurious must be at least 20 dB below the highest emission level within the authorized band. If the output power of this device was measured by spectrum analyzer, the attenuation under this paragraph shall be 30 dB instead of 20 dB. In addition, radiated emissions which fall in the restricted bands must also comply with the FCC section 15.209 limits as below.

Frequency (MHz)	Field Strength (microvolts/meter)	Measurement Distance (meters)
0.009 – 0.490	2400/F(kHz)	300
0.490 – 1.705	24000/F(kHz)	30
1.705 – 30.0	30	30
30 – 88	100	3
88 – 216	150	3
216 - 960	200	3
Above 960	500	3

#### 3.5.2 Measuring Instruments

The measuring equipment is listed in the section 4 of this test report.





3.5.3 Test Procedures

1. The testing follows FCC KDB Publication No. 558074 D01 DTS Meas. Guidance v03r03.
2. The EUT was arranged to its worst case and then tune the antenna tower (from 1 m to 4 m) and turntable (from 0 degree to 360 degrees) to find the maximum reading. A pre-amp and a high pass filter are used for the test in order to get better signal level.
3. The EUT was placed on a turntable with 0.8 meter for frequency below 1GHz and 1.5 meter for frequency above 1GHz respectively above ground.
4. The EUT was set 3 meters from the interference receiving antenna, which was mounted on the top of a variable height antenna tower.
5. Corrected Reading: Antenna Factor + Cable Loss + Read Level - Preamp Factor = Level
6. For measurement below 1GHz, If the emission level of the EUT measured by the peak detector is 3 dB lower than the applicable limit, the peak emission level will be reported. Otherwise, the emission measurement will be repeated using the quasi-peak detector and reported.
7. Use the following spectrum analyzer settings:
  - (1) Span shall wide enough to fully capture the emission being measured;
  - (2) Set RBW=100 kHz for  $f < 1 \text{ GHz}$ ;  $\text{VBW} \geq \text{RBW}$ ; Sweep = auto; Detector function = peak; Trace = max hold;
  - (3) Set RBW = 1 MHz, VBW= 3MHz for  $f \geq 1 \text{ GHz}$  for peak measurement.

For average measurement:

- $\text{VBW} = 10 \text{ Hz}$ , when duty cycle is no less than 98 percent.
- $\text{VBW} \geq 1/T$ , when duty cycle is less than 98 percent where T is the minimum transmission duration over which the transmitter is on and is transmitting at its maximum power control level for the tested mode of operation.

Band	Duty Cycle(%)	T(μs)	1/T(kHz)	VBW Setting
802.11b	100.00	-	-	10Hz
802.11g	95.78	1360	0.74	1kHz
2.4GHz 802.11n HT20	95.49	1270	0.79	1kHz
2.4GHz 802.11n HT40	93.69	624	1.60	3kHz

### 3.5.4 Test Setup

For radiated emissions below 30MHz

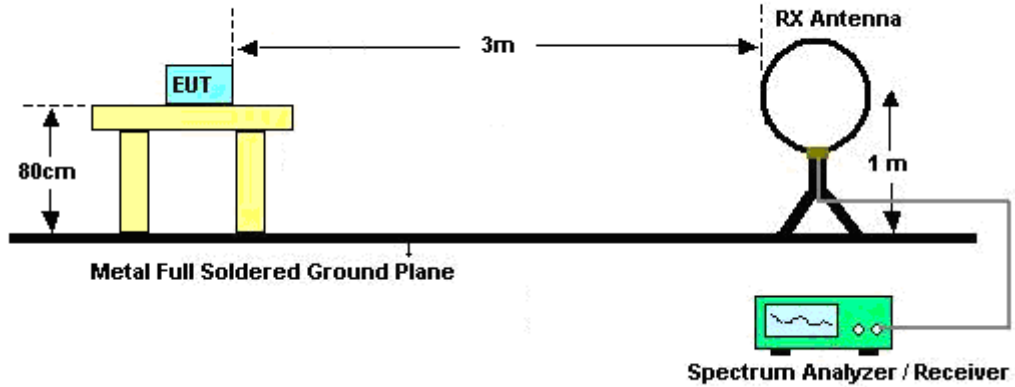

For radiated emissions from 30MHz to 1GHz

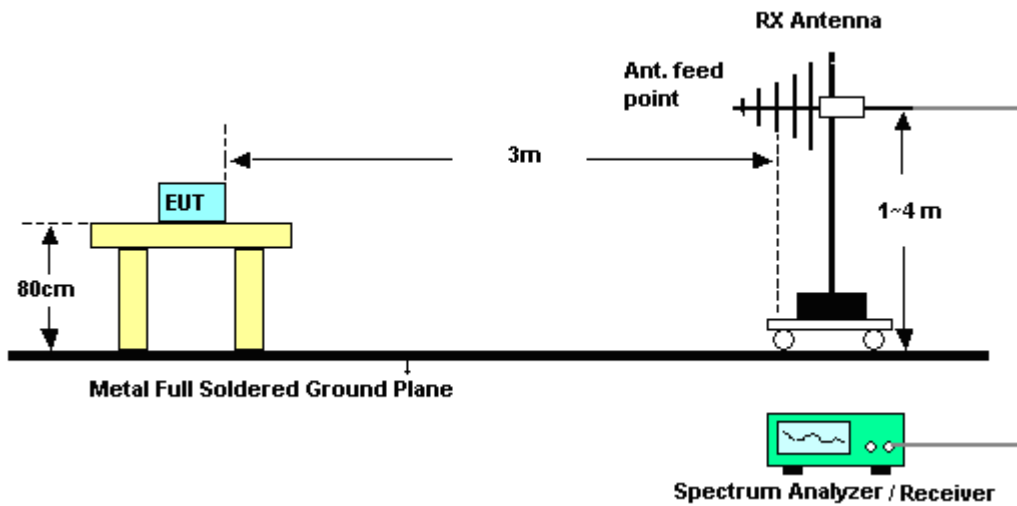

For radiated emissions above 1GHz

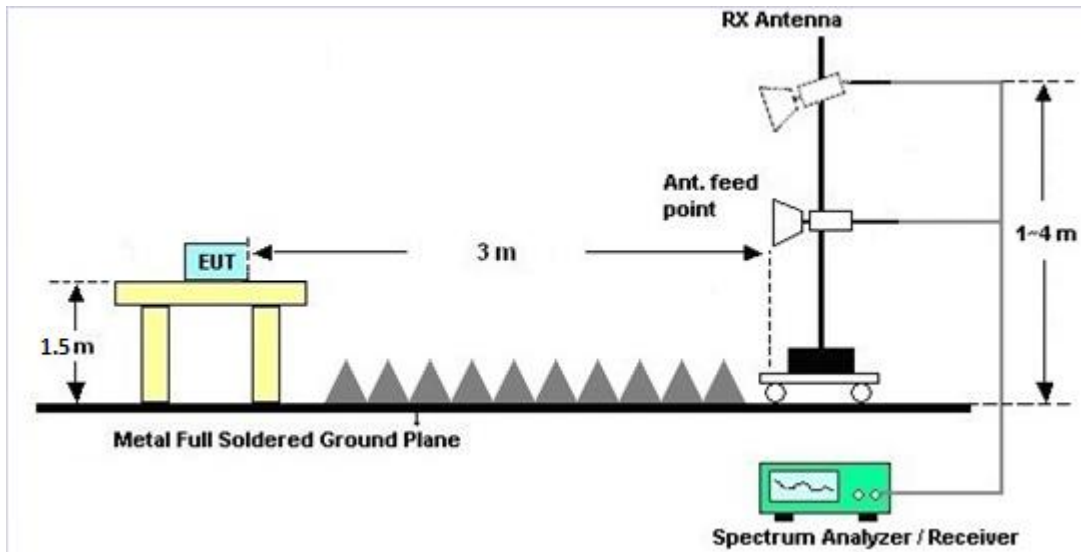

### 3.5.5 Test Results of Radiated Spurious Emissions (9kHz ~ 30MHz)

The low frequency, which started from 9 kHz to 30MHz, was pre-scanned and the result which was 20dB lower than the limit line per 15.31(o) was not reported.

### 3.5.6 Test Result of Radiated Spurious at Band Edges

Please refer to Appendix B.

### 3.5.7 Test Result of Radiated Spurious Emission (30MHz ~ 10<sup>th</sup> Harmonic)

Please refer to Appendix B.



### 3.6 AC Conducted Emission Measurement

#### 3.6.1 Limit of AC Conducted Emission

For equipment that is designed to be connected to the public utility (AC) power line, the radio frequency voltage that is conducted back onto the AC power line on any frequency or frequencies within the band 150 kHz to 30 MHz shall not exceed the limits in the following table.

Frequency of Emission (MHz)	Conducted Limit (dB $\mu$ V)	
	Quasi-Peak	Average
0.15-0.5	79	66
0.5-30	73	60

\*Decreases with the logarithm of the frequency.

#### 3.6.2 Measuring Instruments

The measuring equipment is listed in the section 4 of this test report.

#### 3.6.3 Test Procedures

1. The EUT was placed 0.4 meter from the conducting wall of the shielding room, and it was kept at least 80 centimeters from any other grounded conducting surface.
2. Connect EUT to the power mains through a line impedance stabilization network (LISN).
3. All the support units are connecting to the other LISN.
4. The LISN provides 50 ohm coupling impedance for the measuring instrument.
5. The FCC states that a 50 ohm, 50 microhenry LISN should be used.
6. Both sides of AC line were checked for maximum conducted interference.
7. The frequency range from 150 kHz to 30 MHz was searched.
8. Set the test-receiver system to Peak Detect Function and specified bandwidth (IF bandwidth = 9kHz) with Maximum Hold Mode.

### 3.6.4 Test Setup

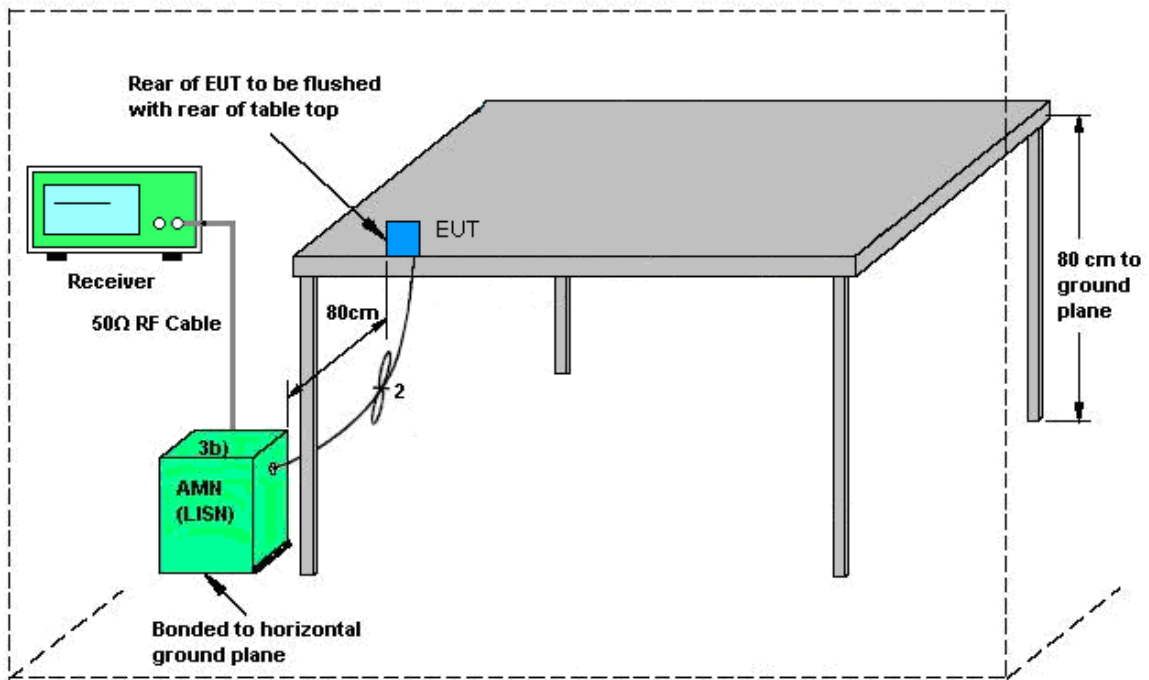

AMN = Artificial mains network (LISN)  
AE = Associated equipment  
EUT = Equipment under test  
ISN = Impedance stabilization network



3.6.5 Test Result of AC Conducted Emission

Test Mode :	Mode 1	Temperature :	23~24°C
Test Engineer :	Eric Jeng	Relative Humidity :	48~52%
Test Voltage :	120Vac / 60Hz	Phase :	Line
Function Type :	WLAN Link + LAN Link + Switch + Camera		

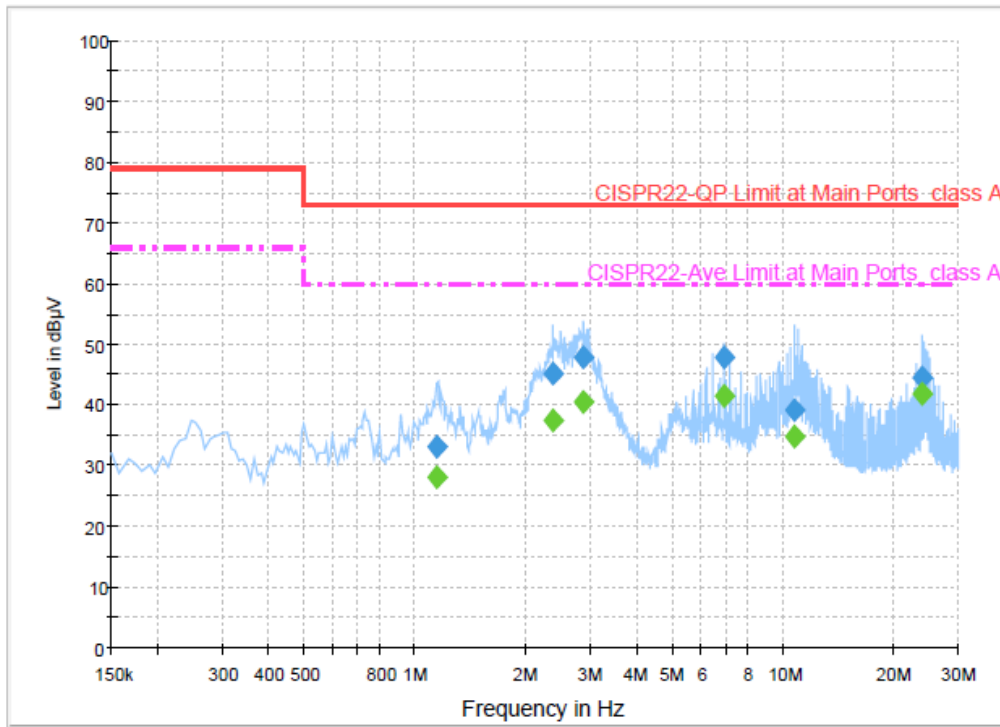

Final Result : Quasi-Peak

Frequency (MHz)	Quasi-Peak (dBµV)	Filter	Line	Corr. (dB)	Margin (dB)	Limit (dBµV)
1.150000	33.2	Off	L1	19.6	39.8	73.0
2.374000	45.3	Off	L1	19.7	27.7	73.0
2.886000	47.7	Off	L1	19.7	25.3	73.0
6.942000	47.7	Off	L1	19.8	25.3	73.0
10.734000	39.2	Off	L1	19.8	33.8	73.0
24.046000	44.6	Off	L1	20.0	28.4	73.0

Final Result : Average

Frequency (MHz)	Average (dBµV)	Filter	Line	Corr. (dB)	Margin (dB)	Limit (dBµV)
1.150000	28.1	Off	L1	19.6	31.9	60.0
2.374000	37.6	Off	L1	19.7	22.4	60.0
2.886000	40.5	Off	L1	19.7	19.5	60.0
6.942000	41.5	Off	L1	19.8	18.5	60.0
10.734000	34.8	Off	L1	19.8	25.2	60.0
24.046000	41.9	Off	L1	20.0	18.1	60.0



Test Mode :	Mode 1	Temperature :	23~24°C
Test Engineer :	Eric Jeng	Relative Humidity :	48~52%
Test Voltage :	120Vac / 60Hz	Phase :	Neutral
Function Type :	WLAN Link + LAN Link + Switch + Camera		

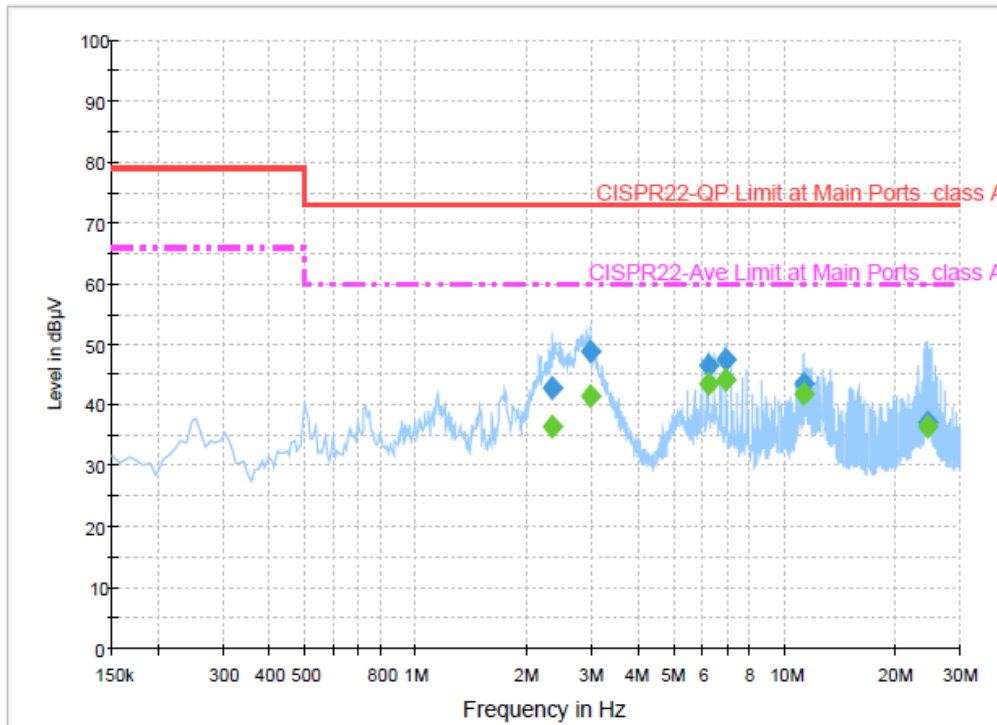

**Final Result : Quasi-Peak**

Frequency (MHz)	Quasi-Peak (dBµV)	Filter	Line	Corr. (dB)	Margin (dB)	Limit (dBµV)
2.342000	42.7	Off	N	19.7	30.3	73.0
2.982000	48.7	Off	N	19.7	24.3	73.0
6.198000	46.5	Off	N	19.8	26.5	73.0
6.942000	47.6	Off	N	19.8	25.4	73.0
11.238000	43.4	Off	N	19.9	29.6	73.0
24.534000	37.3	Off	N	20.2	35.7	73.0

**Final Result : Average**

Frequency (MHz)	Average (dBµV)	Filter	Line	Corr. (dB)	Margin (dB)	Limit (dBµV)
2.342000	36.5	Off	N	19.7	23.5	60.0
2.982000	41.5	Off	N	19.7	18.5	60.0
6.198000	43.3	Off	N	19.8	16.7	60.0
6.942000	44.0	Off	N	19.8	16.0	60.0
11.238000	41.7	Off	N	19.9	18.3	60.0
24.534000	36.4	Off	N	20.2	23.6	60.0



## **3.7 Antenna Requirements**

### **3.7.1 Standard Applicable**

If directional gain of transmitting antennas is greater than 6dBi, the power shall be reduced by the same level in dB comparing to gain minus 6dBi. For the fixed point-to-point operation, the power shall be reduced by one dB for every 3 dB that the directional gain of the antenna exceeds 6 dBi. The use of a permanently attached antenna or of an antenna that uses a unique coupling to the intentional radiator shall be considered sufficient to comply with the FCC rule.

### **3.7.2 Antenna Anti-Replacement Construction**

An embedded-in antenna design is used.

### **3.7.3 Antenna Gain**

The antenna peak gain of EUT is less than 6 dBi. Therefore, it is not necessary to reduce maximum peak output power limit.





## 4 List of Measuring Equipment

Instrument	Manufacturer	Model No.	Serial No.	Characteristics	Calibration Date	Test Date	Due Date	Remark
Power Meter	Anritsu	ML2495A	1218006	300MHz~40GHz	Oct. 18, 2014	Aug. 13, 2015 ~ Aug. 19, 2015	Oct. 17, 2015	Conducted (TH05-HY)
Power Sensor	Anritsu	MA2411B	1126017	300MHz~40GHz	Oct. 18, 2014	Aug. 13, 2015 ~ Aug. 19, 2015	Oct. 17, 2015	Conducted (TH05-HY)
Spectrum Analyzer	Rohde & Schwarz	FSP40	100055	9kHz-40GHz	Jun. 18, 2015	Aug. 13, 2015 ~ Aug. 19, 2015	Jun. 17, 2016	Conducted (TH05-HY)
EMI Test Receiver	Rohde & Schwarz	ESCS 30	100356	9kHz - 2.75GHz	Dec. 01, 2014	Aug. 26, 2015	Nov. 30, 2015	Conduction (CO05-HY)
Hygrometer	Testo	608-H1	34913912	N/A	Apr. 20, 2015	Aug. 26, 2015	Apr. 19, 2016	Conduction (CO05-HY)
LISN	Rohde & Schwarz	ENV216	100080	9kHz~30MHz	Dec. 02, 2014	Aug. 26, 2015	Dec. 01, 2015	Conduction (CO05-HY)
LISN	Rohde & Schwarz	ENV216	100081	9kHz~30MHz	Dec. 08, 2014	Aug. 26, 2015	Dec. 07, 2015	Conduction (CO05-HY)
AC Power Source()	ChainTek	APC-1000W	N/A	N/A	N/A	Aug. 26, 2015	N/A	Conduction (CO05-HY)
Horn Antenna	SCHWARZBECK	BBHA 9170	BBHA9170584	18GHz- 40GHz	Nov. 03, 2014	Aug. 05, 2015 ~ Aug. 13, 2015	Nov. 02, 2015	Radiation (03CH11-HY)
Loop Antenna	TESEQ	HLA 6120	31244	9kHz~30MHz	Feb. 02, 2015	Aug. 05, 2015 ~ Aug. 13, 2015	Feb. 01, 2016	Radiation (03CH11-HY)
EMI Test Receiver	Keysight	N9038A	MY54130085	20Hz ~ 8.4GHz	Nov. 05, 2014	Aug. 05, 2015 ~ Aug. 13, 2015	Nov. 04, 2015	Radiation (03CH11-HY)
Amplifier	SONOMA	310N	187312	9kHz~1GHz	Nov. 24, 2014	Aug. 05, 2015 ~ Aug. 13, 2015	Nov. 23, 2015	Radiation (03CH11-HY)
Bilog Antenna	TESEQ	CBL 6111D	35414	30MHz~1GHz	Oct. 24, 2014	Aug. 05, 2015 ~ Aug. 13, 2015	Oct. 23, 2015	Radiation (03CH11-HY)
Horn Antenna	SCHWARZBECK	BBHA 9120 D	9120D-1326	1GHz ~ 18GHz	Oct. 03, 2014	Aug. 05, 2015 ~ Aug. 13, 2015	Oct. 02, 2015	Radiation (03CH11-HY)
Hygrometer	TECPEL	DTN-303B	TP140325	N/A	Nov. 19, 2014	Aug. 05, 2015 ~ Aug. 13, 2015	Nov. 18, 2015	Radiation (03CH11-HY)
Preamplifier	Keysight	83017A	MY53270080	1GHz~26.5GHz	Nov. 20, 2014	Aug. 05, 2015 ~ Aug. 13, 2015	Nov. 19, 2015	Radiation (03CH11-HY)
Preamplifier	MITEQ	AMF-7D-0010 1800-30-10P	1902247	1GHz~18GHz	Jul. 01, 2015	Aug. 05, 2015 ~ Aug. 13, 2015	Jun. 30, 2016	Radiation (03CH11-HY)
Spectrum Analyzer	Keysight	N9010A	MY54200486	10Hz ~ 44GHz	Sep. 24, 2014	Aug. 05, 2015 ~ Aug. 13, 2015	Sep. 23, 2015	Radiation (03CH11-HY)
RF Cable	HUBER + SUHNER	SUCOFLEX 104	MY24967/4 MY28419/4 MY28654/4	25GHz~40GHz	Nov. 06, 2014	Aug. 05, 2015 ~ Aug. 13, 2015	Nov. 05, 2015	Radiation (03CH11-HY)
RF Cable	HUBER + SUHNER	SUCOFLEX 104	MY24967/4 MY28419/4 MY28654/4	30MHz~1GHz	Nov. 06, 2014	Aug. 05, 2015 ~ Aug. 13, 2015	Nov. 05, 2015	Radiation (03CH11-HY)
RF Cable	HUBER + SUHNER	SUCOFLEX 104	MY24967/4 MY28419/4 MY28654/4	1GHz~25GHz	Nov. 06, 2014	Aug. 05, 2015 ~ Aug. 13, 2015	Nov. 05, 2015	Radiation (03CH11-HY)
Controller	EMEC	EM 1000	N/A	Control Turn table & Ant Mast	N/A	Aug. 05, 2015 ~ Aug. 13, 2015	N/A	Radiation (03CH11-HY)



## 5 Uncertainty of Evaluation

### Uncertainty of Conducted Emission Measurement (150kHz ~ 30MHz)

Measuring Uncertainty for a Level of Confidence of 95% ( $U = 2Uc(y)$ )	2.26
---	------

### Uncertainty of Radiated Emission Measurement (30 MHz ~ 1000 MHz)

Measuring Uncertainty for a Level of Confidence of 95% ( $U = 2Uc(y)$ )	4.90
---	------



## **Appendix A. Conducted Test Results**