

FCC Test Report

Report No.: RFBFPJ-WTW-P24040063

FCC ID: SWX-UAPE

Test Model: UACC-AI-Pro-Enhancer

Series Model: UACC-AI-Pro-Enhancer-W
(Refer to item 3.1 for the more details)

Received Date: Mar. 02, 2024

Test Date: Mar. 02, 2024 ~ May 07, 2024

Issued Date: May 10, 2024

Applicant: Ubiquiti Inc.

Address: 685 Third Avenue, New York, New York 10017 USA

Issued By: Bureau Veritas Consumer Products Services (H.K.) Ltd., Taoyuan Branch
Lin Kou Laboratories

Lab Address: No. 47-2, 14th Ling, Chia Pau Vil., Lin Kou Dist., New Taipei City, Taiwan

Test Location: (1) No. 19, Hwa Ya 2nd Rd., Wen Hwa Vil., Kwei Shan Dist., Taoyuan City
33383, Taiwan
(2) No. 70, Wenming Rd., Guishan Dist., Taoyuan City 333, Taiwan (R.O.C.)

**FCC Registration /
Designation Number:** (1) 788550 / TW0003
(2) 281270 / TW0032



This report is governed by, and incorporates by reference, the Conditions of Testing as posted at the date of issuance of this report at <http://www.bureauveritas.com/home/about-us/our-business/cps/about-us/terms-conditions/> and is intended for your exclusive use. Any copying or replication of this report to or for any other person or entity, or use of our name or trademark, is permitted only with our prior written permission. This report sets forth our findings solely with respect to the test samples identified herein. The results set forth in this report are not indicative or representative of the quality or characteristics of the lot from which a test sample was taken or any similar or identical product unless specifically and expressly noted. Our report includes all of the tests requested by you and the results thereof based upon the information that you provided to us. Measurement uncertainty is only provided upon request for accredited tests. Statements of conformity are based on simple acceptance criteria without taking measurement uncertainty into account, unless otherwise requested in writing. You have 60 days from date of issuance of this report to notify us of any material error or omission caused by our negligence or if you require measurement uncertainty; provided, however, that such notice shall be in writing and shall specifically address the issue you wish to raise. A failure to raise such issue within the prescribed time shall constitute your unqualified acceptance of the completeness of this report, the tests conducted and the correctness of the report contents.

Table of Contents

Release Control Record	4
1 Certificate of Conformity	5
2 Summary of Test Results	6
2.1 Measurement Uncertainty	6
2.2 Modification Record	6
3 General Information	7
3.1 General Description of EUT	7
3.2 Description of Test Modes	8
3.2.1 Test Mode Applicability and Tested Channel Detail	8
3.3 Description of Support Units	10
3.3.1 Configuration of System under Test	10
3.4 General Description of Applied Standards	10
4 Test Types and Results	11
4.1 Radiated Emission Measurement	11
4.1.1 Limits of Radiated Emission Measurement	11
4.1.2 Test Instruments	12
4.1.3 Test Procedures	14
4.1.4 Deviation from Test Standard	15
4.1.5 Test Setup	16
4.1.6 EUT Operating Conditions	17
4.1.7 Test Results	18
4.2 Conducted Emission Measurement	26
4.2.1 Limits of Conducted Emission Measurement	26
4.2.2 Test Instruments	26
4.2.3 Test Procedures	27
4.2.4 Deviation from Test Standard	27
4.2.5 Test Setup	27
4.2.6 EUT Operating Conditions	27
4.2.7 Test Results	28
4.3 6dB Bandwidth Measurement	30
4.3.1 Limits of 6dB Bandwidth Measurement	30
4.3.2 Test Setup	30
4.3.3 Test Instruments	30
4.3.4 Test Procedure	31
4.3.5 Deviation from Test Standard	31
4.3.6 EUT Operating Conditions	31
4.3.7 Test Result	31
4.4 Occupied Bandwidth Measurement	32
4.4.1 Limits of Occupied Bandwidth Measurement	32
4.4.2 Test Setup	32
4.4.3 Test Instruments	32
4.4.4 Test Procedure	33
4.4.5 Deviation from Test Standard	33
4.4.6 EUT Operating Conditions	33
4.4.7 Test Result	33
4.5 Output Power Measurement	34
4.5.1 Limits of Output Power Measurement	34
4.5.2 Test Setup	34
4.5.3 Test Instruments	34
4.5.4 Test Procedures	35
4.5.5 Deviation from Test Standard	35
4.5.6 EUT Operating Conditions	35
4.5.7 Test Results	36

4.6	Frequency Stability Measurement.....	40
4.6.1	Limits of Frequency Stability Measurement	40
4.6.2	Test Setup.....	40
4.6.3	Test Instruments	40
4.6.4	Test Procedure	40
4.6.5	Deviation from Test Standard	40
4.6.6	EUT Operating Condition	41
4.6.7	Test Results	41
5	Pictures of Test Arrangements.....	42
	Appendix – Information of the Testing Laboratories	43

Release Control Record

Issue No.	Description	Date Issued
RFBFPJ-WTW-P24040063	Original Release	May 10, 2024

1 Certificate of Conformity

Product: AI Pro Vision Enhancer

Brand:



Test Model: UACC-AI-Pro-Enhancer

Series Model: UACC-AI-Pro-Enhancer-W
(Refer to item 3.1 for the more details)

Sample Status: Engineering Sample

Applicant: Ubiquiti Inc.

Test Date: Mar. 02, 2024 ~ May 07, 2024

Standards: 47 CFR FCC Part 15, Subpart C (Section 15.255)
ANSI C63.10-2020

The above equipment has been tested by **Bureau Veritas Consumer Products Services (H.K.) Ltd., Taoyuan Branch**, and found compliance with the requirement of the above standards. The test record, data evaluation & Equipment Under Test (EUT) configurations represented herein are true and accurate accounts of the measurements of the sample's RF characteristics under the conditions specified in this report.

Prepared by :

Vera Huang

Date:

May 10, 2024

Vera Huang / Specialist

Approved by :

Jeremy Lin

Date:

May 10, 2024

Jeremy Lin / Project Engineer

2 Summary of Test Results

47 CFR FCC Part 15, Subpart C (Section 15.255)			
FCC Clause	Test Item	Result	Remarks
15.207	AC Power Conducted Emission	Pass	Meet the requirement of limit. Minimum passing margin is -0.62 dB at 0.54114 MHz.
15.255(e)	6dB Bandwidth	-	Reference only.
-	Occupied Bandwidth	Pass	Meet the requirement of limit
15.255(c)(2)(iii)	Output Power	Pass	Meet the requirement of limit.
15.255(d) 15.205 15.209	Spurious Emissions	Pass	Meet the requirement of limit. Minimum passing margin is -1.6 dB at 310.33 MHz.
15.255(f)	Frequency Stability	Pass	Meet the requirement of limit.

Note: Determining compliance based on the results of the compliance measurement, not taking into account measurement instrumentation uncertainty.

2.1 Measurement Uncertainty

Where relevant, the following measurement uncertainty levels have been estimated for tests performed on the EUT as specified in CISPR 16-4-2:

Measurement	Frequency	Expanded Uncertainty
		(k=2) (\pm)
Conducted Emissions at mains ports	150kHz ~ 30MHz	2.88 dB
Radiated Emissions	9kHz ~ 30MHz	3.04 dB
	30MHz ~ 200MHz	3.59 dB
	200MHz ~ 1000MHz	3.60 dB
	1GHz ~ 18GHz	2.29 dB
	18GHz ~ 40GHz	2.29 dB
	40GHz ~ 66GHz	4.59 dB
	66GHz ~ 100GHz	5.37 dB
	Above 100GHz	5.40 dB

2.2 Modification Record

There were no modifications required for compliance.

3 General Information

3.1 General Description of EUT

Product	AI Pro Vision Enhancer
Brand	
Test Model	UACC-AI-Pro-Enhancer
Series Model	UACC-AI-Pro-Enhancer-W
Model Difference	Refer to Note
Sample Status	Engineering Sample
Power Supply Method	5Vdc
Modulation Type	FMCW
Operating Frequency	61~63 GHz
Output Power (EIRP)	15.91dBm (PK)

Note:

- All models are listed as below. The model UACC-AI-Pro-Enhancer was chosen for final test.

Brand	Model	Color	Difference
	UACC-AI-Pro-Enhancer	Black	Only different in Exterior color
	UACC-AI-Pro-Enhancer-W	White	

- The antenna information is listed as below.

Antenna type	Frequency Range (GHz)	Antenna Net Gain (dBi)	Connector Type
PIFA	61~63	5.2	N/A

*Only radiated measurements are used to show compliance with FCC limits for fundamental and spurious emissions.

- The above EUT information is declared by manufacturer and for more detailed features description, please refer to the manufacturer's specifications or user's manual.

3.2 Description of Test Modes

1 channel is provided for EUT.

Channel's Number	1
Frequency (GHz)	61.93

3.2.1 Test Mode Applicability and Tested Channel Detail

EUT Configure Mode	Applicable To							Description
	PLC	BW	OBW	OP	FS	RE < 1G	RE ≥ 1G	
-	√	√	√	√	√	√	√	-

Where PLC: Power Line Conducted Emission
 BW: 6dB Bandwidth
 OBW: Occupied bandwidth
 OP: Output Power
 FS: Frequency Stability
 RE < 1G: Radiated Emission below 1GHz
 RE ≥ 1G: Radiated Emission above 1GHz

Note: The EUT had been pre-tested on the positioned of each 3 axis. The worst case was found when positioned on Z-plane.

Power Line Conducted Emission Test:

- Pre-Scan has been conducted to determine the worst-case mode from all possible combinations between available modulations, data rates and antenna ports (if EUT with antenna diversity architecture).
- Following channel(s) was (were) selected for the final test as listed below.

Available Channel	Tested Channel	Modulation Type
1	1	FMCW

6dB Bandwidth Test:

- Pre-Scan has been conducted to determine the worst-case mode from all possible combinations between available modulations, data rates and antenna ports (if EUT with antenna diversity architecture).
- Following channel(s) was (were) selected for the final test as listed below.

Available Channel	Tested Channel	Modulation Type
1	1	FMCW

Occupied Bandwidth Test:

- Pre-Scan has been conducted to determine the worst-case mode from all possible combinations between available modulations, data rates and antenna ports (if EUT with antenna diversity architecture).
- Following channel(s) was (were) selected for the final test as listed below.

Available Channel	Tested Channel	Modulation Type
1	1	FMCW

Output Power Measurement:

- Pre-Scan has been conducted to determine the worst-case mode from all possible combinations between available modulations, data rates and antenna ports (if EUT with antenna diversity architecture).
- Following channel(s) was (were) selected for the final test as listed below.

Available Channel	Tested Channel	Modulation Type
1	1	FMCW

Frequency Stability Test:

- Following channel(s) was (were) selected for the final test as listed below.

Available Channel	Tested Channel	Modulation Type
1	1	FMCW

Radiated Emission Test (Below 1GHz):

- Pre-Scan has been conducted to determine the worst-case mode from all possible combinations between available modulations, data rates and antenna ports (if EUT with antenna diversity architecture).
- Following channel(s) was (were) selected for the final test as listed below.

Available Channel	Tested Channel	Modulation Type
1	1	FMCW

Radiated Emission Test (Above 1GHz):

- Pre-Scan has been conducted to determine the worst-case mode from all possible combinations between available modulations, data rates and antenna ports (if EUT with antenna diversity architecture).
- Following channel(s) was (were) selected for the final test as listed below.

Available Channel	Tested Channel	Modulation Type
1	1	FMCW

Test Condition:

Applicable To	Environmental Conditions	Input Power	Tested By
PLC	25 deg. C, 75 %RH	120Vac, 60Hz	Karl Li
BW	25 deg. C, 60 %RH	5Vdc	Wade Huang
OBW	25 deg. C, 60 %RH	5Vdc	Wade Huang
OP	25 deg. C, 60 %RH	120Vac, 60Hz	Wade Huang
FS	25 deg. C, 60 %RH	5Vdc	Wade Huang
RE<1G	23 deg. C, 67 %RH	120Vac, 60Hz	Wade Huang
RE≥1G	23 deg. C, 67 %RH	120Vac, 60Hz	Wade Huang

3.3 Description of Support Units

The EUT has been tested as an independent unit together with other necessary accessories or support units. The following support units or accessories were used to form a representative test configuration during the tests.

ID	Product	Brand	Model No.	Serial No.	FCC ID	Remarks
A.	Camera	UBIQUITI	UVC-AI-Pro	N/A	N/A	Supplied by applicant
B.	POE	UBIQUITI	GP-H480-065G	N/A	N/A	Supplied by applicant
C.	Load	N/A	N/A	N/A	N/A	Provided by Lab

ID	Descriptions	Qty.	Length (m)	Shielding (Yes/No)	Cores (Qty.)	Remarks
1.	Type C cable	1	1	YES	0	Supplied by applicant
2.	RJ-45 Cable	2	1.5	NO	0	Provided by Lab

3.3.1 Configuration of System under Test

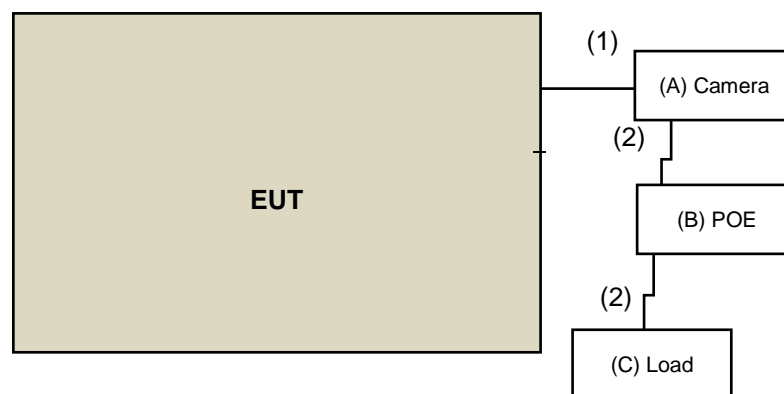

 Under Table

 Remote Site

3.4 General Description of Applied Standards

The EUT is a RF Product. According to the specifications of the manufacturer, it must comply with the requirements of the following standards:

FCC Part 15, Subpart C (15.255)

ANSI C63.10-2020

All test items have been performed and recorded as per the above standards.

4 Test Types and Results

4.1 Radiated Emission Measurement

4.1.1 Limits of Radiated Emission Measurement

Spurious Emission	
Frequency Range	Limitation
Radiated emissions below 40GHz	Part 15.209
Between 40GHz and 200GHz	90pW/cm ² (at 3 meter)

Note: The levels of the spurious emissions shall not exceed the level of the fundamental emission.

Emissions radiated outside of the specified bands, shall be according to the general radiated limits in 15.209 as following:

Frequencies (MHz)	Field strength (microvolts/meter)	Measurement distance (meters)
0.009-0.490	2400/F(kHz)	300
0.490-1.705	24000/F(kHz)	30
1.705-30.0	30	30
30-88	100	3
88-216	150	3
216-960	200	3
Above 960	500	3

Note:

1. The lower limit shall apply at the transition frequencies.
2. Emission level (dBuV/m) = 20 log Emission level (uV/m).
3. As shown in 15.35(b), for frequencies above 1000MHz, the field strength limits are based on average detector, however, the peak field strength of any emission shall not exceed the maximum permitted average limits, specified above by more than 20dB under any condition of modulation.
4. Section 15.205 restricted bands of operation shall compliance with the limits in Section 15.209.

4.1.2 Test Instruments

For Below 40GHz and Frequency Stability

Description & Manufacturer	Model No.	Serial No.	Cal. Date	Cal. Due
Test Receiver Rohde & Schwarz	ESR3	102579	Jul. 04, 2023	Jul. 03, 2024
Spectrum Analyzer KEYSIGHT	N9020B	MY60110462	Apr. 22, 2024	Apr. 21, 2025
BILOG Antenna SCHWARZBECK	VULB9168	9168-995	Oct. 16, 2023	Oct. 15, 2024
HORN Antenna SCHWARZBECK	BBHA 9120 D	9120D-404	Nov. 12, 2023	Nov. 11, 2024
HORN Antenna SCHWARZBECK	BBHA 9170	995	Nov. 12, 2023	Nov. 11, 2024
Loop Antenna EMCI	EM-6879	269	Sep. 23, 2023	Sep. 22, 2024
Preamplifier EMCI	EMC330N	980783	Jan. 15, 2024	Jan. 14, 2025
Preamplifier EMCI	EMC118A45SE	980810	Dec. 28, 2023	Dec. 27, 2024
Preamplifier EMCI	EMC184045SE	980787	Jan. 15, 2024	Jan. 14, 2025
RF signal cable EMCI	EMC104-SM-SM-(9000+2000+1000)	201230+ 201242+ 210101	Jan. 15, 2024	Jan. 14, 2025
RF signal cable EMCI	EMCCFD400-NM-NM-(9000+300+500)	201252+ 201250+ 201245	Jan. 15, 2024	Jan. 14, 2025
RF signal cable EMCI	EMC101G-KM-KM-(5000+3000+2000)	201261+201258+ 201249	Jan. 15, 2024	Jan. 14, 2025
Software BV CPS	ADT_Radiated_V7.6.15.9.5	NA	NA	NA
Turn Table Max-Full	MFT-151SS-0.5T	NA	NA	NA
Turn Table Controller Max-Full	MF-7802BS	MF780208675	NA	NA
Antenna Tower KaiTuo	NA	NA	NA	NA
Antenna Tower Controller KaiTuo	KT-2000	NA	NA	NA
Boresight Antenna Fixture	FBA-01	FBA-SIP01	NA	NA
Temperature & Humidity Chamber Terchy	MHU-225AU	920842	Jun. 17, 2023	Jun. 16, 2024
Digital Storage Oscilloscope Keysight	DSO-X 6004A	MY55190202	Jun. 20, 2023	Jun. 19, 2024

- Note: 1. The calibration interval of the above test instruments is 12 months and the calibrations are traceable to NML/ROC and NIST/USA.
 2. The test was performed in WM Chamber 7.
 3. Test date: Apr. 25, 2024 ~ May 07, 2024

For Above 40GHz:

Description & Manufacturer	Model No.	Serial No.	Cal. Date	Cal. Due
Spectrum Analyzer Keysight	N9042B	US60360159	Apr. 16, 2024	Apr. 15, 2025
*OXE89 Horn Antenna (33~55GHz) QuinStar	QWH-QPRR00	QWH-QPRR00-1	Apr. 9, 2024	Apr. 8, 2025
*Conical Horn Antenna (50~75GHz) Keysight	WR15CH-Conical	RCHO15RL-1	Apr. 9, 2024	Apr. 8, 2025
*Conical Horn Antenna (75~110GHz) Keysight	WR10CH-Conical	RCHO10RL-1	Apr. 9, 2024	Apr. 8, 2025
*Conical Horn Antenna (110~170GHz) Keysight	WR6.5CH-Conical	RCHO6RL-1	Apr. 9, 2024	Apr. 8, 2025
*Conical Horn Antenna (140~220GHz) Keysight	WR5.1CH-Conical	RCHO5RL-1	Apr. 9, 2024	Apr. 8, 2025
Extension Module_down converter (50-75GHz) 9VDC supply Keysight	N9029AV15	SAX 381	Apr. 16, 2024	Apr. 15, 2025
Extension Module_down converter (75-110GHz) 9VDC supply Keysight	N9029AV10	SAX 378	Apr. 16, 2024	Apr. 15, 2025
Extension Module_down converter (110-170GHz) 9VDC supply Keysight	N9029AV06	SAX723	Apr. 16, 2024	Apr. 15, 2025
Extension Module_down converter (140-220GHz) 9VDC supply Keysight	N9029AV05	SAX722	Apr. 16, 2024	Apr. 15, 2025
PSG analog signal generator Keysight	E8257D	MY60020399	Jan. 16, 2024	Jan. 15, 2025
*Power Meter VDI (110-325GHz)	PM5B	571V	Apr. 16, 2024	Apr. 15, 2025
*Power Meter Keysight (50-110GHz)	U8489A	US59290810	Mar. 8, 2024	Mar. 7, 2025
Boresight Antenna Tower & Turn Table Max-Full	MF-7802BS	MF780208530	NA	NA

Note:

1. The calibration interval of the above test instruments is 12 months and the calibrations are traceable to NML/ROC and NIST/USA.
2. The test was performed in WM Chamber 7.
3. Test date: May 06, 2024

4.1.3 Test Procedures

For Radiated emission below 30MHz

- a. The EUT was placed on the top of a rotating table 0.8 meters above the ground at a 3 meter chamber room. The table was rotated 360 degrees to determine the position of the highest radiation.
- b. The EUT was set 3 meters away from the interference-receiving antenna, which was mounted on the top of a variable-height antenna tower.
- c. Parallel, perpendicular, and ground-parallel orientations of the antenna are set to make the measurement.
- d. For each suspected emission, the EUT was arranged to its worst case and the rotatable table was turned from 0 degrees to 360 degrees to find the maximum reading.
- e. The test-receiver system was set to Quasi-Peak Detect Function and Specified Bandwidth with Maximum Hold Mode.

Note:

1. The resolution bandwidth and video bandwidth of test receiver/spectrum analyzer is 9kHz at frequency below 30MHz.

For Radiated emission 30MHz to 40GHz

- a. The EUT was placed on the top of a rotating table 0.8 meters (for 30MHz ~ 1GHz) / 1.5 meters (for above 1GHz) above the ground at 3 meter chamber room for test. The table was rotated 360 degrees to determine the position of the highest radiation.
- b. The EUT was set 3 meters away from the interference-receiving antenna, which was mounted on the top of a variable-height antenna tower.
- c. The height of antenna is varied from one meter to four meters above the ground to determine the maximum value of the field strength. Both horizontal and vertical polarizations of the antenna are set to make the measurement.
- d. For each suspected emission, the EUT was arranged to its worst case and then the antenna was tuned to heights from 1 meter to 4 meters and the rotatable table was turned from 0 degrees to 360 degrees to find the maximum reading.
- e. The test-receiver system was set to quasi-peak detect function and specified bandwidth with maximum hold mode when the test frequency is below 1 GHz.
- f. The test-receiver system was set to peak and average detects function and specified bandwidth with maximum hold mode when the test frequency is above 1 GHz. If the peak reading value also meets average limit, measurement with the average detector is unnecessary.

Note:

1. The resolution bandwidth and video bandwidth of test receiver/spectrum analyzer is 120kHz for Quasi-peak detection (QP) at frequency below 1GHz.
2. The resolution bandwidth of test receiver/spectrum analyzer is 1 MHz and the video bandwidth is 3 MHz for Peak detection (PK) and Average detection (AV) at frequency above 1GHz.
3. All modes of operation were investigated and the worst-case emissions are reported.

For Radiated emission above 40GHz

- a. Connect the test antenna covering the appropriate frequency range to a spectrum analyzer via an external mixer to the spectrum analyzer.
- b. Set spectrum analyzer RBW = 1 MHz, VBW = 3 MHz, average detector.
- c. Calculate the distance to the far field boundary and determine the maximum measurement distance.
- d. Perform an exploratory search for emissions and determine the approximate direction at which each observed emission emanates from the EUT.
- e. Exploratory measurements be made at a closer distance than the validated maximum measurement distance.
- f. Perform a final measurement; begin with the test antenna at the approximate position where the maximum level occurred during the exploratory scan.
- g. Slowly scan the test antenna around this position, slowly vary the test antenna polarization by rotating through at least 0° to 180°, and slowly vary the orientation of the test antenna to find the final position, polarization, and orientation at which the maximum level of the emission is observed.
- h. Record the measured reading with the test antenna fixed at this maximized position, polarization, and orientation. Record the measurement distance.
- i. Calculate the maximum field strength of the emission at the measurement distance and the adjusted/corrected power at the output of the test antenna.
- j. Calculate the EIRP from the measured field strength and then convert to the linear.
- k. Calculate the power density at the distance specified by the limit from the field strength at the distance specified by the limit.
- l. Repeat the preceding sequence for every emission observed in the frequency band under investigation.

4.1.4 Deviation from Test Standard

No deviation.

4.1.5 Test Setup

For Radiated emission below 30MHz

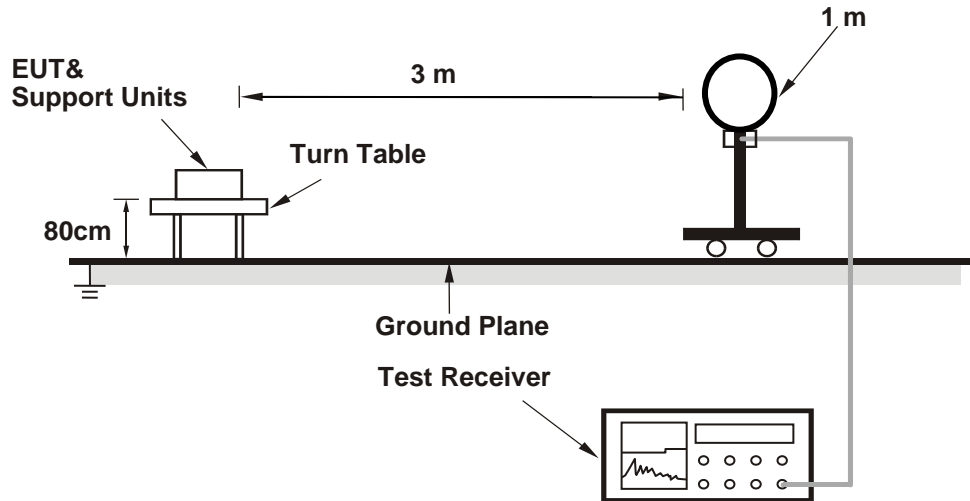

For Radiated emission 30MHz to 1GHz

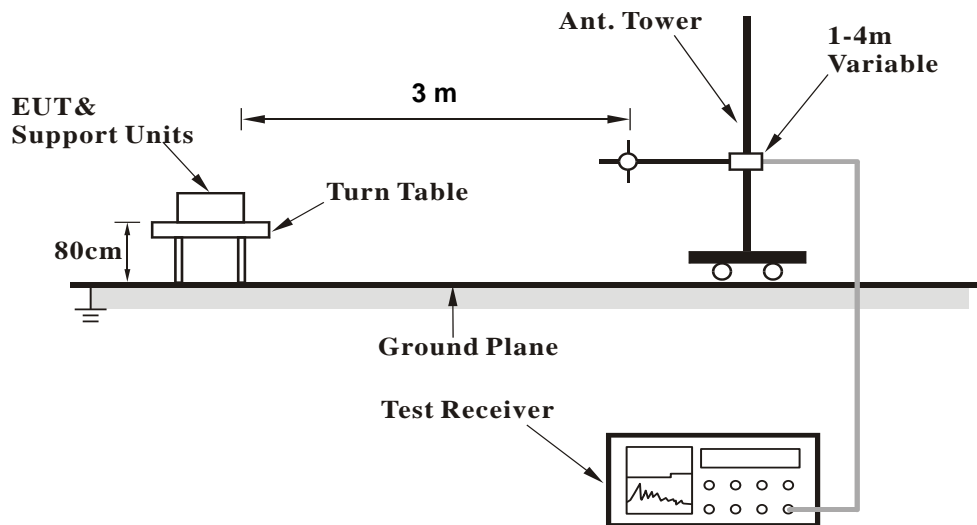

For Radiated emission 1GHz to 50GHz

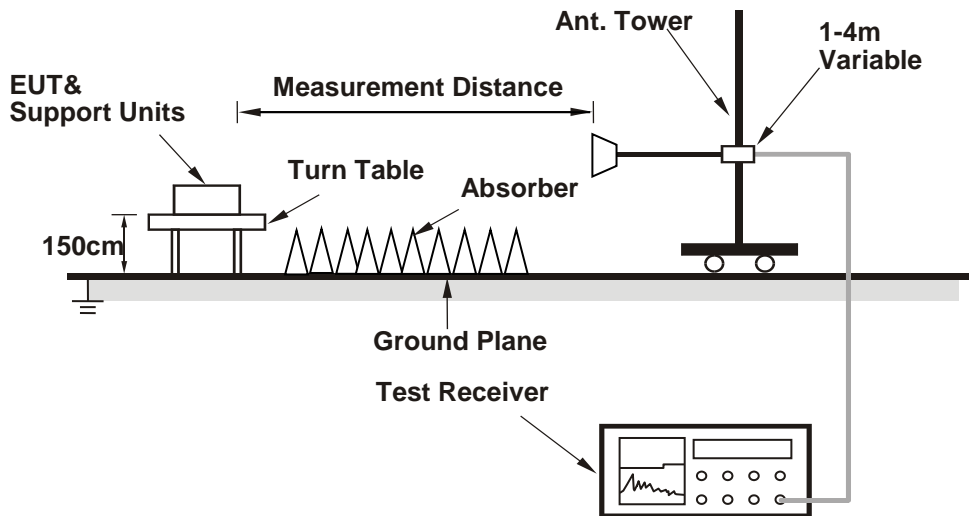

For Radiated emission above 50GHz

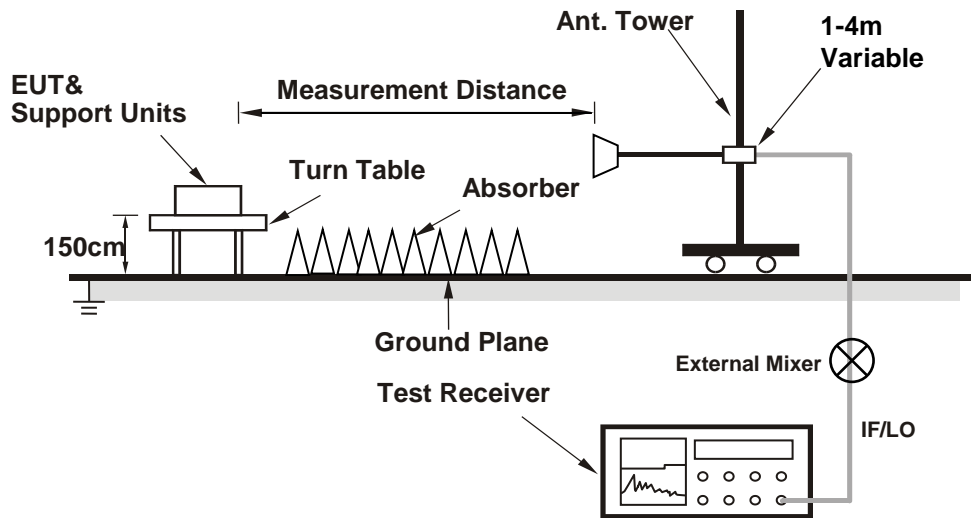

For the actual test configuration, please refer to the attached file (Test Setup Photo).

4.1.6 EUT Operating Conditions

- a. Placed the EUT on the testing table.
- b. The EUT is connected to the simulator at low, middle and high frequency channel individually.

4.1.7 Test Results

Above 1GHz Data:

Channel	CH 1 : 61.93 GHz		
Frequency Range	1GHz ~ 18GHz	Detector Function	Peak (PK) Average (AV)

Antenna Polarity & Test Distance : Horizontal at 3 m								
No	Frequency (MHz)	Emission Level (dBuV/m)	Limit (dBuV/m)	Margin (dB)	Antenna Height (m)	Table Angle (Degree)	Raw Value (dBuV)	Correction Factor (dB/m)
1	16720.28	52.8 PK	74.0	-21.2	1.15 H	103	52.0	0.8
2	16720.28	41.6 AV	54.0	-12.4	1.15 H	103	40.8	0.8

Remarks:

1. Emission Level(dBuV/m) = Raw Value(dBuV) + Correction Factor(dB/m)
2. Correction Factor(dB/m) = Antenna Factor(dB/m) + Cable Factor(dB) – Pre-Amplifier Factor(dB)
3. Margin value = Emission Level – Limit value
4. The other emission levels were very low against the limit.

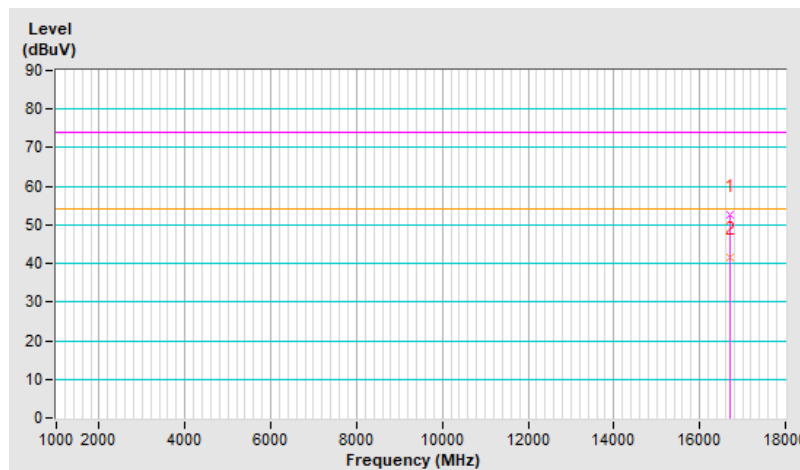

Channel	CH 1 : 61.93 GHz		
Frequency Range	1GHz ~ 18GHz	Detector Function	Peak (PK) Average (AV)

Antenna Polarity & Test Distance : Vertical at 3 m								
No	Frequency (MHz)	Emission Level (dBuV/m)	Limit (dBuV/m)	Margin (dB)	Antenna Height (m)	Table Angle (Degree)	Raw Value (dBuV)	Correction Factor (dB/m)
1	16720.28	53.1 PK	74.0	-20.9	1.62 V	45	52.3	0.8
2	16720.28	41.9 AV	54.0	-12.1	1.62 V	45	41.1	0.8

Remarks:

1. Emission Level(dBuV/m) = Raw Value(dBuV) + Correction Factor(dB/m)
2. Correction Factor(dB/m) = Antenna Factor(dB/m) + Cable Factor(dB) – Pre-Amplifier Factor(dB)
3. Margin value = Emission Level – Limit value
4. The other emission levels were very low against the limit.

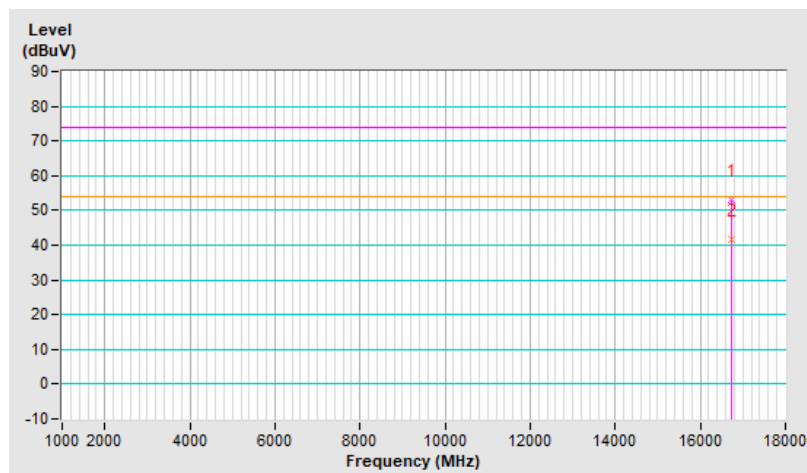

Channel	CH 1 : 61.93 GHz		
Frequency Range	18GHz ~ 40GHz	Detector Function	Peak (PK) Average (AV)

Antenna Polarity & Test Distance : Horizontal at 3 m								
No	Frequency (MHz)	Emission Level (dBuV/m)	Limit (dBuV/m)	Margin (dB)	Antenna Height (m)	Table Angle (Degree)	Raw Value (dBuV)	Correction Factor (dB/m)
1	39948.00	58.6 PK	74.0	-15.4	1.44 H	116	58.2	0.4
2	39948.00	46.8 AV	54.0	-7.2	1.44 H	116	46.4	0.4

Remarks:

1. Emission Level(dBuV/m) = Raw Value(dBuV) + Correction Factor(dB/m)
2. Correction Factor(dB/m) = Antenna Factor(dB/m) + Cable Factor(dB) – Pre-Amplifier Factor(dB)
3. Margin value = Emission Level – Limit value
4. The other emission levels were very low against the limit.

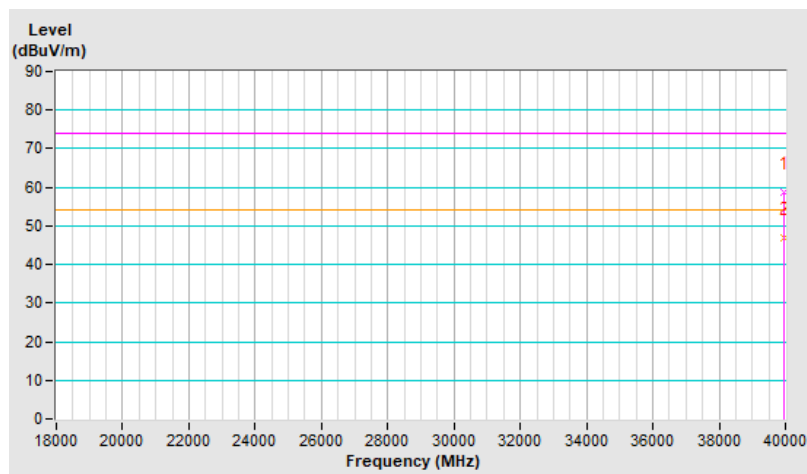

Channel	CH 1 : 61.93 GHz		
Frequency Range	18GHz ~ 40GHz	Detector Function	Peak (PK) Average (AV)

Antenna Polarity & Test Distance : Vertical at 3 m								
No	Frequency (MHz)	Emission Level (dBuV/m)	Limit (dBuV/m)	Margin (dB)	Antenna Height (m)	Table Angle (Degree)	Raw Value (dBuV)	Correction Factor (dB/m)
1	39948.00	58.5 PK	74.0	-15.5	1.76 V	255	58.1	0.4
2	39948.00	46.6 AV	54.0	-7.4	1.76 V	255	46.2	0.4

Remarks:

1. Emission Level(dBuV/m) = Raw Value(dBuV) + Correction Factor(dB/m)
2. Correction Factor(dB/m) = Antenna Factor(dB/m) + Cable Factor(dB) – Pre-Amplifier Factor(dB)
3. Margin value = Emission Level – Limit value
4. The other emission levels were very low against the limit.

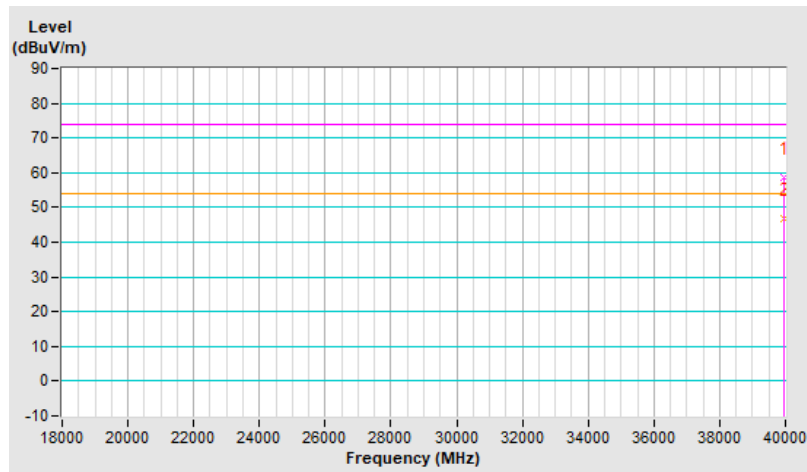

Channel	CH 1 : 61.93 GHz		
Frequency Range	40GHz ~ 200GHz	Detector Function	Average (AV)

Antenna Polarity: Horizontal									
No.	Frequency (GHz)	Power (dBm)	Gain of test Antenna (dBi)	E _{Meas} (dB μ V/m)	EIRP Level (dBm/MHz)	Power Density (pW/cm ²)	Power Density Limit (pW/cm ²)	Margin (pW/cm ²)	PASS/ FAIL
1	49.80	-73.70	22.50	75.00	-29.70	0.95	90.00	-89.05	PASS
2	52.56	-81.70	21.50	68.47	-36.23	0.21	90.00	-89.79	PASS
3	64.04	-90.97	21.50	60.92	-43.78	0.04	90.00	-89.96	PASS
4	81.99	-99.15	21.60	54.78	-49.92	0.01	90.00	-89.99	PASS
5	110.97	-105.85	22.00	50.31	-54.39	0.00	90.00	-90.00	PASS
6	170.09	-103.17	21.30	57.40	-47.30	0.02	90.00	-89.98	PASS
Antenna Polarity : Vertical									
No.	Frequency (GHz)	Power (dBm)	Gain of test Antenna (dBi)	E _{Meas} (dB μ V/m)	EIRP Level (dBm/MHz)	Power Density (pW/cm ²)	Power Density Limit (pW/cm ²)	Margin (pW/cm ²)	PASS/ FAIL
1	49.82	-73.14	22.50	75.57	-29.13	1.08	90.00	-88.92	PASS
2	52.56	-89.27	21.50	60.90	-43.80	0.04	90.00	-89.96	PASS
3	64.03	-91.00	21.50	60.89	-43.81	0.04	90.00	-89.96	PASS
4	82.00	-99.12	21.60	54.81	-49.89	0.01	90.00	-89.99	PASS
5	110.99	-105.78	22.00	50.38	-54.32	0.00	90.00	-90.00	PASS
6	186.44	-103.16	21.30	58.21	-46.49	0.02	90.00	-89.98	PASS

Remarks:

1. The measured power level is converted to EIRP using the equation:

Follow ANSI 63.10 section 9.4 Equations to calculate and extrapolate field strength

$$E_{Meas} \text{ (dB}\mu\text{V/m)} = 126.8 - 20\log(\lambda) + P - G$$

where:

E_{Meas} is the field strength of the emission at the measurement distance, in dB μ V/m

P is the power measured at the output of the test antenna, in dBm

λ is the wavelength of the emission under investigation [300/fMHz], in m

G is the gain of the test antenna, in dBi

Follow ANSI 63.10 section 9.5 Equations to calculate EIRP

$$\text{EIRP Level (dBm/MHz)} = E_{Meas} \text{ (dB}\mu\text{V/m)} + 20 \cdot \log(d_{Meas}) - 104.7$$

E_{Meas} is the field strength of the emission at the measurement distance, in dB μ V/m

d_{Meas} is the measurement distance, in m

Measurements made at 1 meter distance.

2. Power density formula as follows

Follow ANSI 63.10 section 9.6 Equations to calculate power density

$$PD = EIRP_{Linear} / 4 \pi d^2$$

PD is the power density at the distance specified by the limit, in W/m²

EIRP_{Linear} is the equivalent isotropically radiated power, in watts

d is the 3m distance.

3. The far-field boundary is given in ANSI 63.10 as:

$$R \text{ far field} = (2 * L^2) / \lambda$$

L is the Largest Antenna Dimension of measurement antenna, including the reflector

λ is the wavelength

Frequency (GHz)	L (m)	Lambda (m)	R (Far Field) (m)
40	0.03	0.0075	0.240
50	0.03	0.0060	0.300

Frequency (GHz)	L (m)	Lambda (m)	R (Far Field) (m)
50	0.025	0.0060	0.208
75	0.025	0.0040	0.313

Frequency (GHz)	L (m)	Lambda (m)	R (Far Field) (m)
75	0.018	0.0040	0.162
110	0.018	0.0027	0.238

Frequency (GHz)	L (m)	Lambda (m)	R (Far Field) (m)
110	0.012	0.0027	0.106
170	0.012	0.0018	0.163

Frequency (GHz)	L (m)	Lambda (m)	R (Far Field) (m)
170	0.008	0.0018	0.073
260	0.008	0.0012	0.111

Below 1GHz Data:

Channel	CH 1 : 61.93 GHz		
Frequency Range	9kHz ~ 1GHz	Detector Function	Quasi-Peak (QP)

Antenna Polarity & Test Distance : Horizontal at 3 m								
No	Frequency (MHz)	Emission Level (dBuV/m)	Limit (dBuV/m)	Margin (dB)	Antenna Height (m)	Table Angle (Degree)	Raw Value (dBuV)	Correction Factor (dB/m)
1	101.78	40.3 QP	43.5	-3.2	1.99 H	318	57.3	-17.0
2	310.33	44.4 QP	46.0	-1.6	1.00 H	74	56.5	-12.1
3	709.97	41.8 QP	46.0	-4.2	1.00 H	108	45.3	-3.5
4	735.19	42.6 QP	46.0	-3.4	1.00 H	93	45.9	-3.3
5	759.44	43.1 QP	46.0	-2.9	1.00 H	130	45.7	-2.6
6	783.69	40.8 QP	46.0	-5.2	1.50 H	134	43.1	-2.3

Remarks:

1. Emission Level(dBuV/m) = Raw Value(dBuV) + Correction Factor(dB/m)
2. Correction Factor(dB/m) = Antenna Factor(dB/m) + Cable Factor(dB) – Pre-Amplifier Factor(dB)
3. Margin value = Emission Level – Limit value
4. The other emission levels were very low against the limit of frequency range 30MHz~1000MHz.
5. The frequency range 9 kHz ~ 30 MHz: all emissions are more than 20 dB below the limit, therefore do not be recorded in this report.

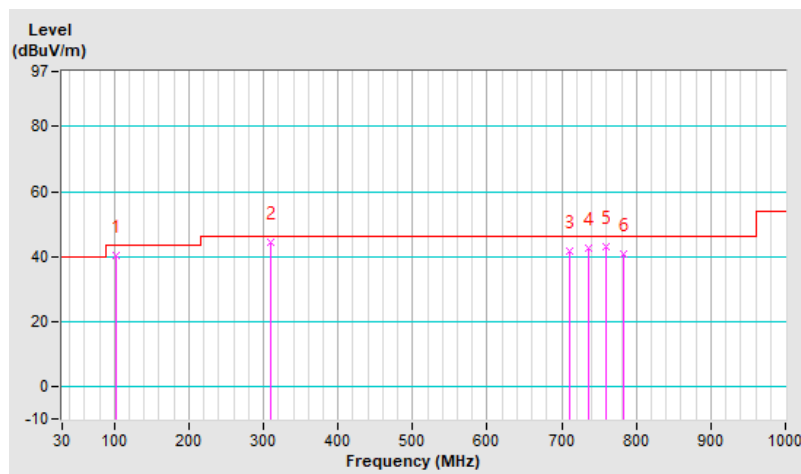

Channel	CH 1 : 61.93 GHz		
Frequency Range	9kHz ~ 1GHz	Detector Function	Quasi-Peak (QP)

Antenna Polarity & Test Distance : Vertical at 3 m								
No	Frequency (MHz)	Emission Level (dBuV/m)	Limit (dBuV/m)	Margin (dB)	Antenna Height (m)	Table Angle (Degree)	Raw Value (dBuV)	Correction Factor (dB/m)
1	37.16	35.4 QP	40.0	-4.6	1.00 V	323	49.1	-13.7
2	68.29	32.1 QP	40.0	-7.9	1.00 V	2	46.9	-14.8
3	310.33	41.3 QP	46.0	-4.7	1.00 V	231	53.4	-12.1
4	735.19	42.6 QP	46.0	-3.4	1.49 V	156	45.9	-3.3
5	759.44	42.8 QP	46.0	-3.2	1.49 V	160	45.4	-2.6
6	783.69	41.6 QP	46.0	-4.4	1.49 V	165	43.9	-2.3

Remarks:

1. Emission Level(dBuV/m) = Raw Value(dBuV) + Correction Factor(dB/m)
2. Correction Factor(dB/m) = Antenna Factor(dB/m) + Cable Factor(dB) – Pre-Amplifier Factor(dB)
3. Margin value = Emission Level – Limit value
4. The other emission levels were very low against the limit of frequency range 30MHz~1000MHz.
5. The frequency range 9 kHz ~ 30 MHz: all emissions are more than 20 dB below the limit, therefore do not be recorded in this report.

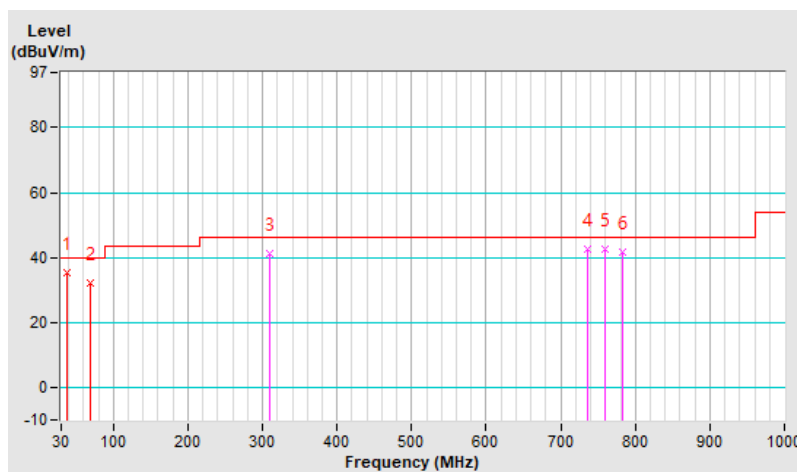

4.2 Conducted Emission Measurement

4.2.1 Limits of Conducted Emission Measurement

Frequency (MHz)	Conducted Limit (dBuV)	
	Quasi-peak	Average
0.15 - 0.5	66 - 56	56 - 46
0.50 - 5.0	56	46
5.0 - 30.0	60	50

Note: 1. The lower limit shall apply at the transition frequencies.

2. The limit decreases in line with the logarithm of the frequency in the range of 0.15 to 0.50MHz.

4.2.2 Test Instruments

Description Manufacturer	Model No.	Serial No.	Calibrated Date	Calibrated Until
50 ohm terminal resistance HUBER+SUHNER	E1-011315	13	2023/11/22	2024/11/21
50 ohm terminal resistance	E1-011279	04	2023/11/22	2024/11/21
	E1-011280	05	2023/11/22	2024/11/21
DC-LISN Schwarzbeck	NNBM 8126G	8126G-069	2023/11/7	2024/11/6
EMI Test Receiver R&S	ESCI	100613	2023/12/4	2024/12/3
Fixed Attenuator Mini-Circuits	HAT-10+	PAD-COND1-01	2024/1/6	2025/1/5
LISN R&S	ENV216	101826	2024/3/25	2025/3/24
	ESH3-Z5	100311	2023/9/6	2024/9/5
RF Coaxial Cable Woken	5D-FB	Cable-cond1-01	2024/1/6	2025/1/5
Software BVADT	BVADT_Cond_ V7.3.7.4	N/A	N/A	N/A
V-LISN Schwarzbeck	NNBL 8226-2	8226-142	2023/8/31	2024/8/30

Note: 1. The calibration interval of the above test instruments is 12 months and the calibrations are traceable to NML/ROC and NIST/USA.

2. The test was performed in HwaYa Shielded Room 1 (Conduction 1).

3. The VCCI Site Registration No. is C-12040.

4. Test date: Apr. 24, 2024

4.2.3 Test Procedures

- The EUT was placed 0.4 meters from the conducting wall of the shielded room with EUT being connected to the power mains through a line impedance stabilization network (LISN). Other support units were connected to the power mains through another LISN. The two LISNs provide 50 ohm/ 50uH of coupling impedance for the measuring instrument.
- Both lines of the power mains connected to the EUT were checked for maximum conducted interference.
- The frequency range from 150kHz to 30MHz was searched. Emission levels under (Limit - 20dB) was not recorded.

Note: The resolution bandwidth and video bandwidth of test receiver is 9kHz for quasi-peak detection (QP) and average detection (AV) at frequency 0.15MHz-30MHz.

4.2.4 Deviation from Test Standard

No deviation.

4.2.5 Test Setup

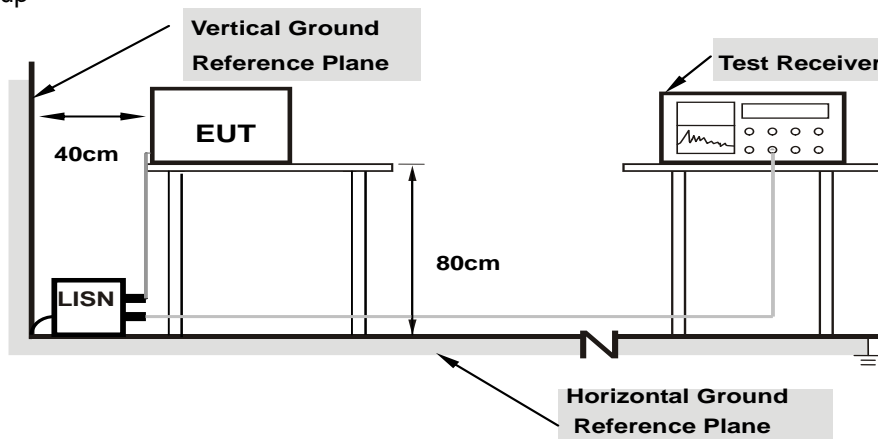

Note: 1.Support units were connected to second LISN.

For the actual test configuration, please refer to the attached file (Test Setup Photo).

4.2.6 EUT Operating Conditions

Same as 4.1.6.

4.2.7 Test Results

Channel	CH 1 : 61.93 GHz		
Frequency Range	150kHz ~ 30MHz	Detector Function & Bandwidth	Quasi-Peak (QP) / Average (AV), 9kHz

Phase Of Power : Line (L)										
No	Frequency (MHz)	Correction Factor (dB)	Reading Value (dBuV)		Emission Level (dBuV)		Limit (dBuV)		Margin (dB)	
			Q.P.	AV.	Q.P.	AV.	Q.P.	AV.	Q.P.	AV.
1	0.18133	9.72	36.91	25.19	46.63	34.91	64.42	54.42	-17.79	-19.51
2	0.31800	9.78	27.89	18.57	37.67	28.35	59.76	49.76	-22.09	-21.41
3	0.54114	9.84	42.76	35.46	52.60	45.30	56.00	46.00	-3.40	-0.70
4	1.15400	9.89	27.80	21.04	37.69	30.93	56.00	46.00	-18.31	-15.07
5	2.93800	9.99	26.71	18.91	36.70	28.90	56.00	46.00	-19.30	-17.10
6	13.35800	10.23	37.56	31.50	47.79	41.73	60.00	50.00	-12.21	-8.27

Remarks:

1. Q.P. and AV. are abbreviations of quasi-peak and average individually.
2. The emission levels of other frequencies were very low against the limit.
3. Margin value = Emission level – Limit value
4. Correction factor = Insertion loss + Cable loss
5. Emission Level = Correction Factor + Reading Value

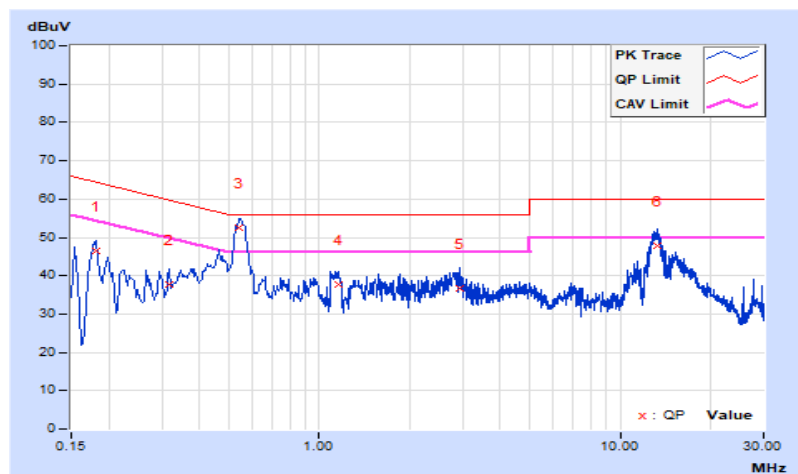

Channel	CH 1 : 61.93 GHz		
Frequency Range	150kHz ~ 30MHz	Detector Function & Bandwidth	Quasi-Peak (QP) / Average (AV), 9kHz

Phase Of Power : Neutral (N)										
No	Frequency (MHz)	Correction Factor (dB)	Reading Value (dBuV)		Emission Level (dBuV)		Limit (dBuV)		Margin (dB)	
			Q.P.	AV.	Q.P.	AV.	Q.P.	AV.	Q.P.	AV.
1	0.17755	9.70	38.01	25.47	47.71	35.17	64.60	54.60	-16.89	-19.43
2	0.54114	9.88	42.79	35.50	52.67	45.38	56.00	46.00	-3.33	-0.62
3	1.17800	9.94	24.66	16.72	34.60	26.66	56.00	46.00	-21.40	-19.34
4	2.82600	10.00	28.60	21.16	38.60	31.16	56.00	46.00	-17.40	-14.84
5	5.83000	10.10	24.13	18.90	34.23	29.00	60.00	50.00	-25.77	-21.00
6	13.23400	10.33	38.29	32.53	48.62	42.86	60.00	50.00	-11.38	-7.14

Remarks:

1. Q.P. and AV. are abbreviations of quasi-peak and average individually.
2. The emission levels of other frequencies were very low against the limit.
3. Margin value = Emission level – Limit value
4. Correction factor = Insertion loss + Cable loss
5. Emission Level = Correction Factor + Reading Value

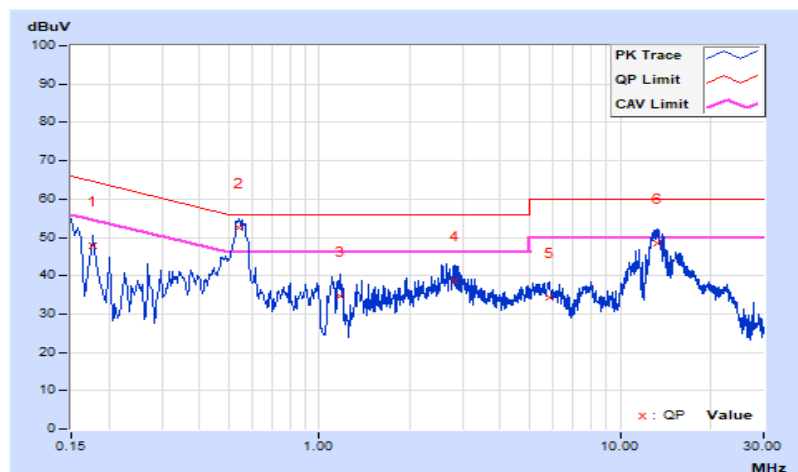

4.3 6dB Bandwidth Measurement

4.3.1 Limits of 6dB Bandwidth Measurement

None: For reporting purposes only.

4.3.2 Test Setup

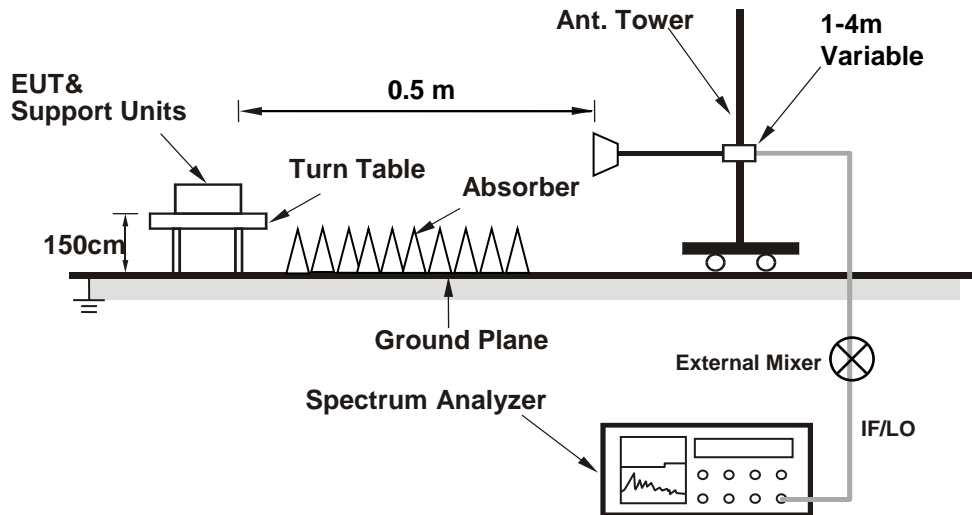

4.3.3 Test Instruments

Description & Manufacturer	Model No.	Serial No.	Cal. Date	Cal. Due
Spectrum Analyzer Agilent	N9010A	MY52220314	Dec. 14, 2023	Dec. 13, 2024
Spectrum Analyzer (50~110GHz) Keysight	N9030A	MY55330160	Jan. 31, 2024	Jan. 30, 2025
Conical Horn Antenna (50~75GHz) Keysight	WR15CH-Conical	RCH015RL-2	Apr. 25, 2023	Apr. 24, 2024
DC Power Supply TOPWARD	6306A	727263	NA	NA
Temperature & Humidity Chamber TERCHY	HRM-120RF	931022	Dec. 19, 2023	Dec. 18, 2024

Note:

- The calibration interval of the above test instruments is 12 months and the calibrations are traceable to NML/ROC and NIST/USA.
- Tested date: Mar. 02, 2024

4.3.4 Test Procedure

- Set resolution bandwidth (RBW) = 100kHz
- Set the video bandwidth (VBW) $\geq 3 \times$ RBW, Detector = Peak.
- Trace mode = max hold.
- Sweep = auto couple.
- Measure the maximum width of the emission that is constrained by the frequencies associated with the two amplitude points (upper and lower) that are attenuated by 6 dB relative to the maximum level measured in the fundamental emission

4.3.5 Deviation from Test Standard

No deviation.

4.3.6 EUT Operating Conditions

Same as 4.1.6.

4.3.7 Test Result

Channel	Frequency (GHz)	6dB Bandwidth (MHz)
1	61.93	1800

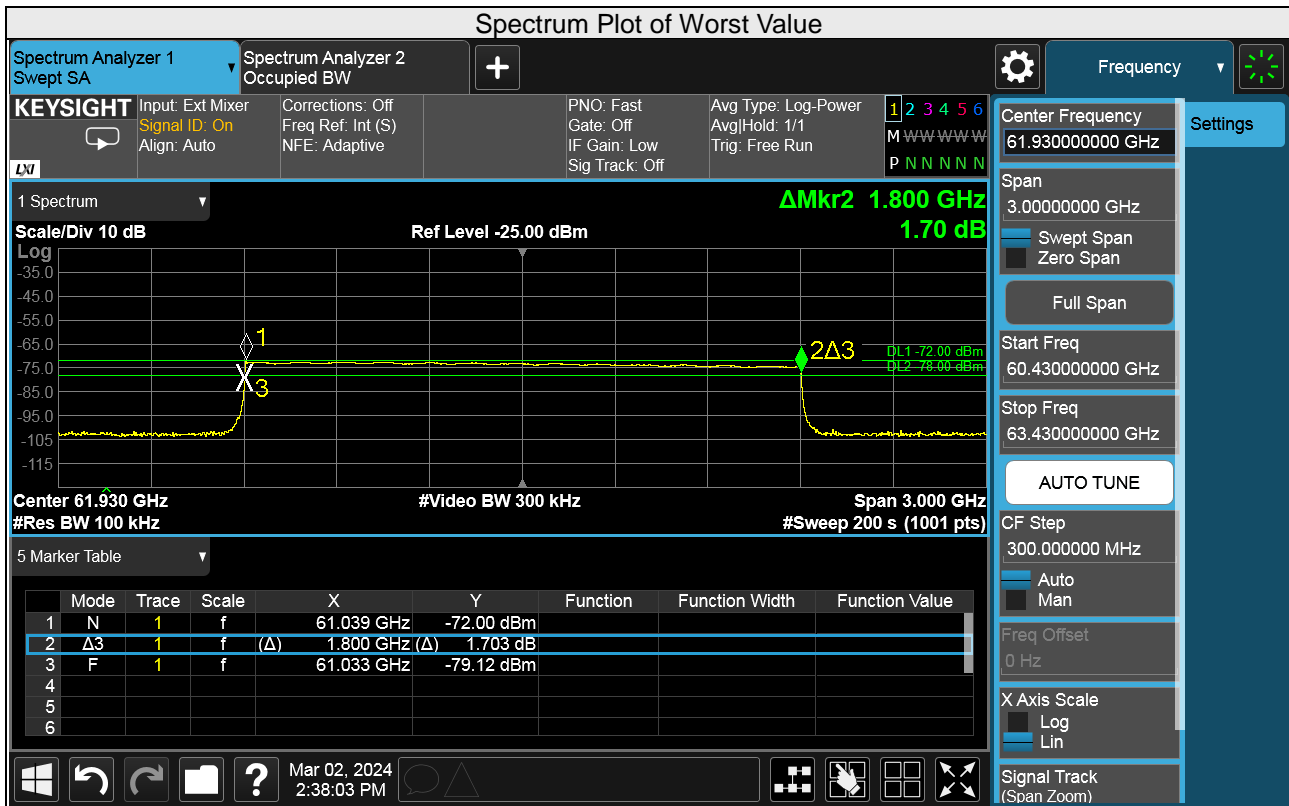

4.4 Occupied Bandwidth Measurement

4.4.1 Limits of Occupied Bandwidth Measurement

None: For reporting purposes only.

4.4.2 Test Setup

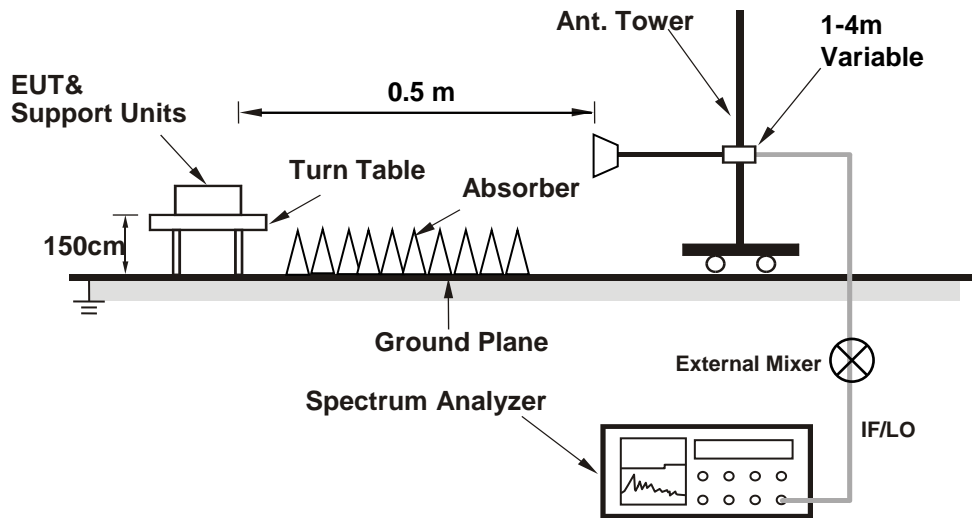

4.4.3 Test Instruments

Description & Manufacturer	Model No.	Serial No.	Cal. Date	Cal. Due
Spectrum Analyzer Agilent	N9010A	MY52220314	Dec. 14, 2023	Dec. 13, 2024
Spectrum Analyzer (50~110GHz) Keysight	N9030A	MY55330160	Jan. 31, 2024	Jan. 30, 2025
Conical Horn Antenna (50~75GHz) Keysight	WR15CH-Conical	RCH015RL-2	Apr. 25, 2023	Apr. 24, 2024
DC Power Supply TOPWARD	6306A	727263	NA	NA
Temperature & Humidity Chamber TERCHY	HRM-120RF	931022	Dec. 19, 2023	Dec. 18, 2024

Note:

- The calibration interval of the above test instruments is 12 months and the calibrations are traceable to NML/ROC and NIST/USA.
- Tested date: Mar. 02, 2024

4.4.4 Test Procedure

1. Set Span=1.5 times the OBW
2. Set RBW = 1~5% of the OBW, or minimum of 1MHz if the this is not possible due to a large OBW.
3. Set the VBW approximately 3 x RBW.
4. Detector = Peak.
5. Trace mode = max hold.
6. The EUT shall be transmitting at its maximum data rate, Allow the trace to stabilize.

4.4.5 Deviation from Test Standard

No deviation.

4.4.6 EUT Operating Conditions

Same as 4.1.6.

4.4.7 Test Result

Channel	Frequency (GHz)	Occupied Bandwidth (GHz)	Pass/Fail
1	61.93	1.7862	Pass

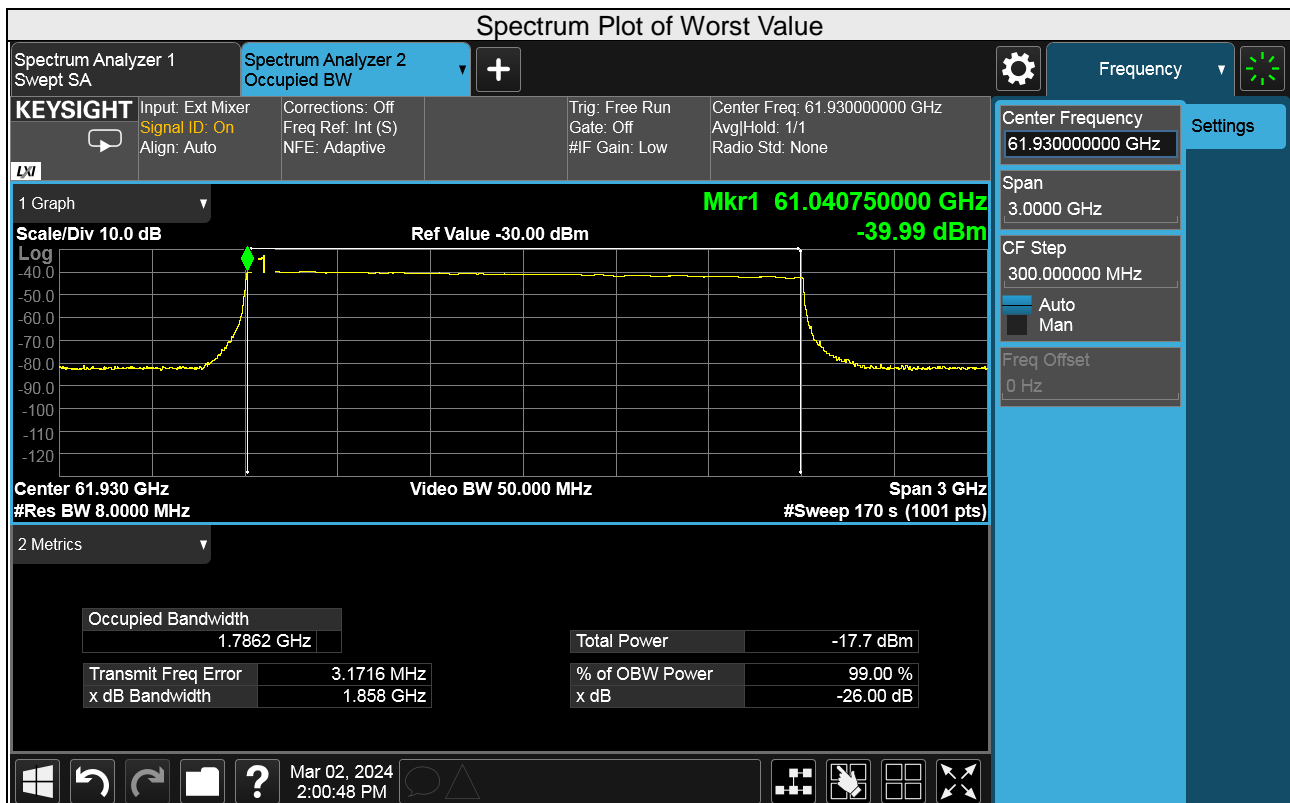

4.5 Output Power Measurement

4.5.1 Limits of Output Power Measurement

for 15.255(c)(2)(iii)

The peak EIRP shall not exceed 20 dBm, and the sum of continuous transmitter off-times of at least two milliseconds shall equal at least 16.5 milliseconds within any contiguous interval of 33 milliseconds when operated outdoors:

for 15.255(e)(2)

Devices other than field disturbance sensors/ radars with an emission bandwidth of less than 100 megahertz must limit their peak transmitter conducted output power to the product of 500 mW times their emission bandwidth divided by 100 megahertz. For the purposes of this paragraph, emission bandwidth is defined as the instantaneous frequency range occupied by a steady state radiated signal with modulation, outside which the radiated power spectral density never exceeds 6 dB below the maximum radiated power spectral density in the band, as measured with a 100 kilohertz resolution bandwidth spectrum analyzer.

4.5.2 Test Setup

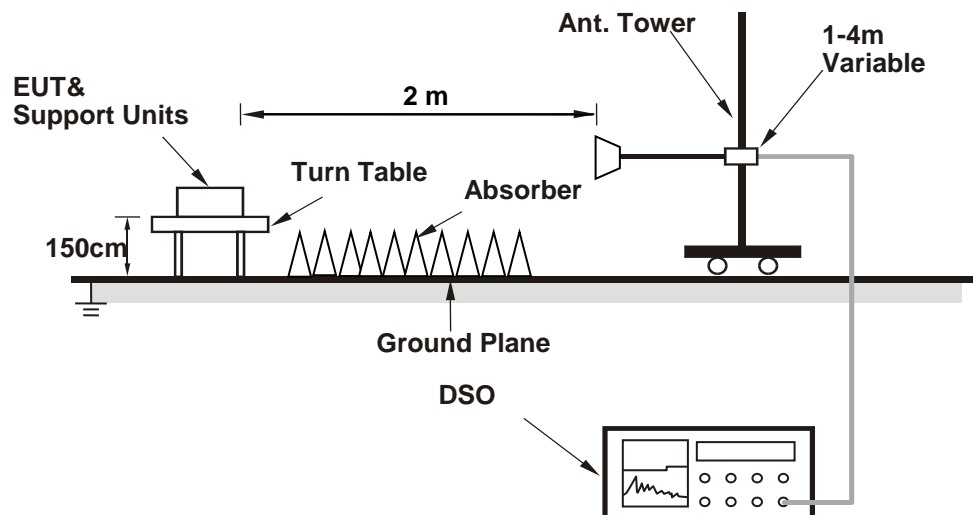

4.5.3 Test Instruments

Same as Item 4.1.2.

4.5.4 Test Procedures

- a. Place the EUT in a continuous transmission mode.
- b. For radiated emission measurements, attach a test receive antenna for the fundamental frequency band to the RF input of an RF detector or a downconverter with an RF detector at the output.
- c. Connect the video output of the detector to the 50 ohm input of the DSO.
- d. Place the test receive antenna in the main beam of the EUT at a distance which will provide a signal within the operating range of the RF detector.
- e. Set the sampling rate of the DSO to the required value. Adjust the memory depth, the triggering and the sweep speed to obtain a display which is representative of the signal considering the type of modulation.
- f. For radiated emission measurements, calculate the distance to the far field boundary of the fundamental emission using following equation

$$R \text{ far field} = (2 * L^2) / \lambda$$

Where:

L is the Largest Antenna Dimension of either the EUT antenna or measurement antenna, including the reflector

λ is the wavelength

Frequency (GHz)	L (m)	Lambda (m)	R (Far Field) (m)
61.93	0.007	0.00484	0.02

*Measurements made at 2 meter distance.

- g. Perform radiated emission measurements to keep maximize the received signal from the EUT in the far field.
- h. Record the average and peak from the DSO and the measurement distance.
- i. Disconnect the EUT from the RF input port of the instrumentation system.
- j. Connect a mm-wave source to the RF input port of the instrumentation system via a waveguide variable attenuator. The mm-wave source is unmodulated.
- k. Using substitution measurement.
- l. Measure and note the power.

4.5.5 Deviation from Test Standard

No deviation.

4.5.6 EUT Operating Conditions

Same as 4.1.6.

4.5.7 Test Results

For Output Power (EIRP)

Antenna Polarity								
Channel	Frequency (GHz)	DSO Value (mV)	Power (dBm)	Gain of Test Antenna (dBi)	E _{Meas} (dB μ V/m)	EIRP Level (dBm)	EIRP Limit (dBm)	Pass/Fail
1	61.93	482.00	-37.01	21.50	114.59	15.91 PK	20.00	PASS

Note:

1. The measured power level is converted to EIRP using the equation:

Follow ANSI 63.10 section 9.4 Equations to calculate and extrapolate field strength

$$E_{Meas} \text{ (dB}\mu\text{V/m)} = 126.8 - 20\log(\lambda) + P - G$$

where:

E_{Meas} is the field strength of the emission at the measurement distance, in dB μ V/m

P is the power measured at the output of the test antenna, in dBm

λ is the wavelength of the emission under investigation [300/fMHz], in m

G is the gain of the test antenna, in dBi

Follow ANSI 63.10 section 9.5 Equations to calculate EIRP

$$\text{EIRP Level (dBm/MHz)} = E_{Meas} \text{ (dB}\mu\text{V/m)} + 20 \cdot \log(d_{Meas}) - 104.7$$

where:

EIRP is the equivalent isotropically radiated power, in dBm

E_{Meas} is the field strength of the emission at the measurement distance, in dB μ V/m

d_{Meas} is the measurement distance, in m

Measurements made at 2 meter distance.

For conducted power

Channel	Frequency (GHz)	Peak EIRP Power (dBm)	Antenna Gain (dBi)	Peak Output Power (dBm)	Peak Output Power (mW)	6dBc BandWidth (MHz)	Peak Output Power Limit (mW)	Peak Output Power PASS / FAIL
1	61.93	15.91	5.2	10.71	11.78	1800	500	PASS

For continuous transmitter time

Tx On Duration(ms)	Tx Off Duration(ms)	Period (ms)	Tx Off Limit (ms)	Result
16.2	16.8	33	16.5	PASS

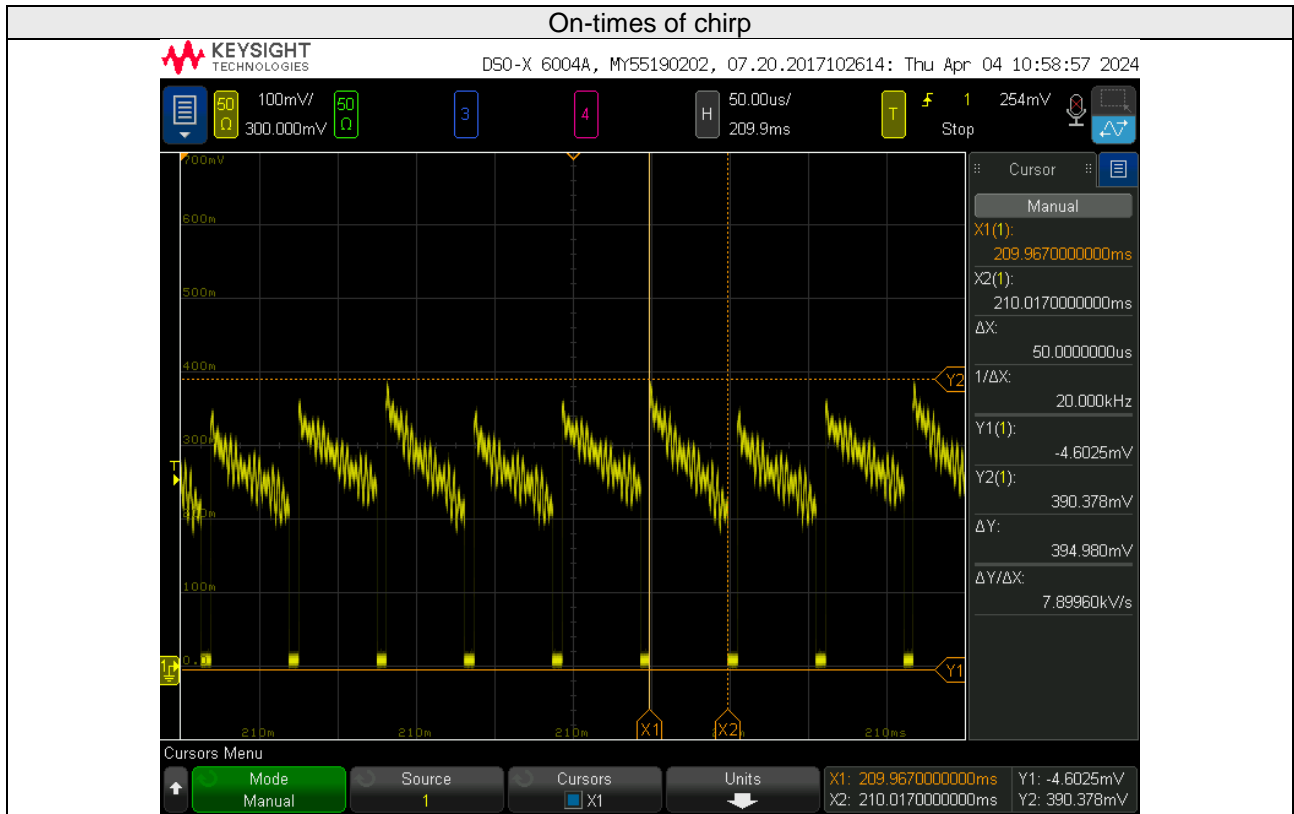

Off-time of chirp = Repetition time of chirps within burst - on-times of chip
 $6\mu s = 56\mu s - 50\mu s < 2ms$

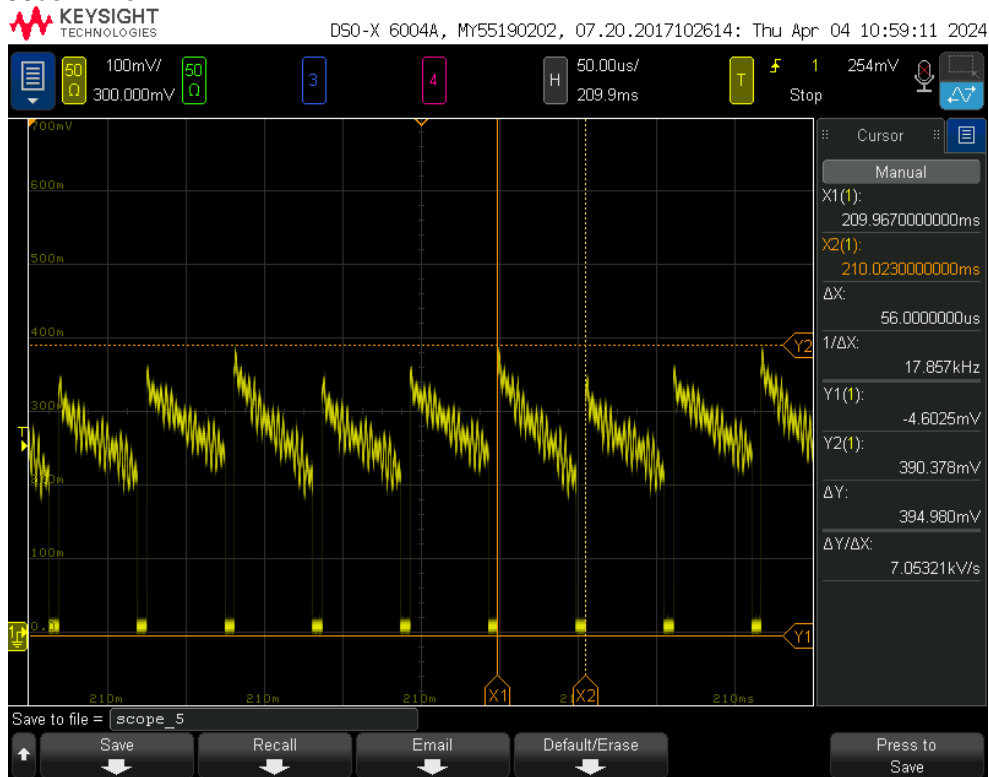

On-time of chirp sequence (frame on time)

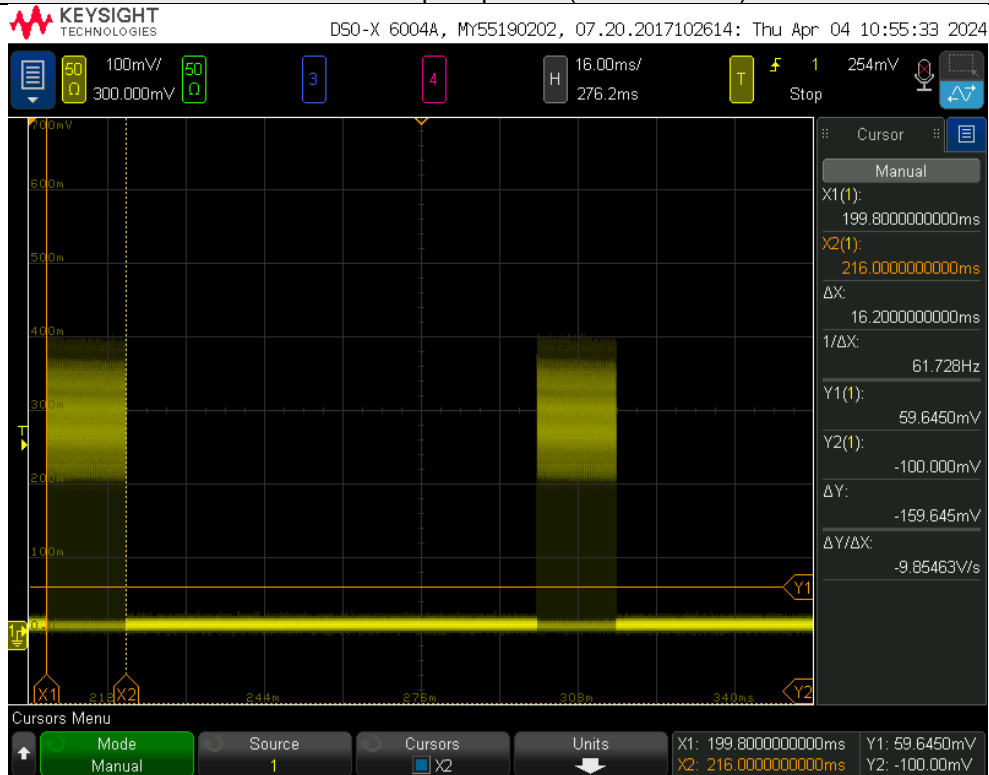

On-time of chirp sequence (frame on time)/33ms

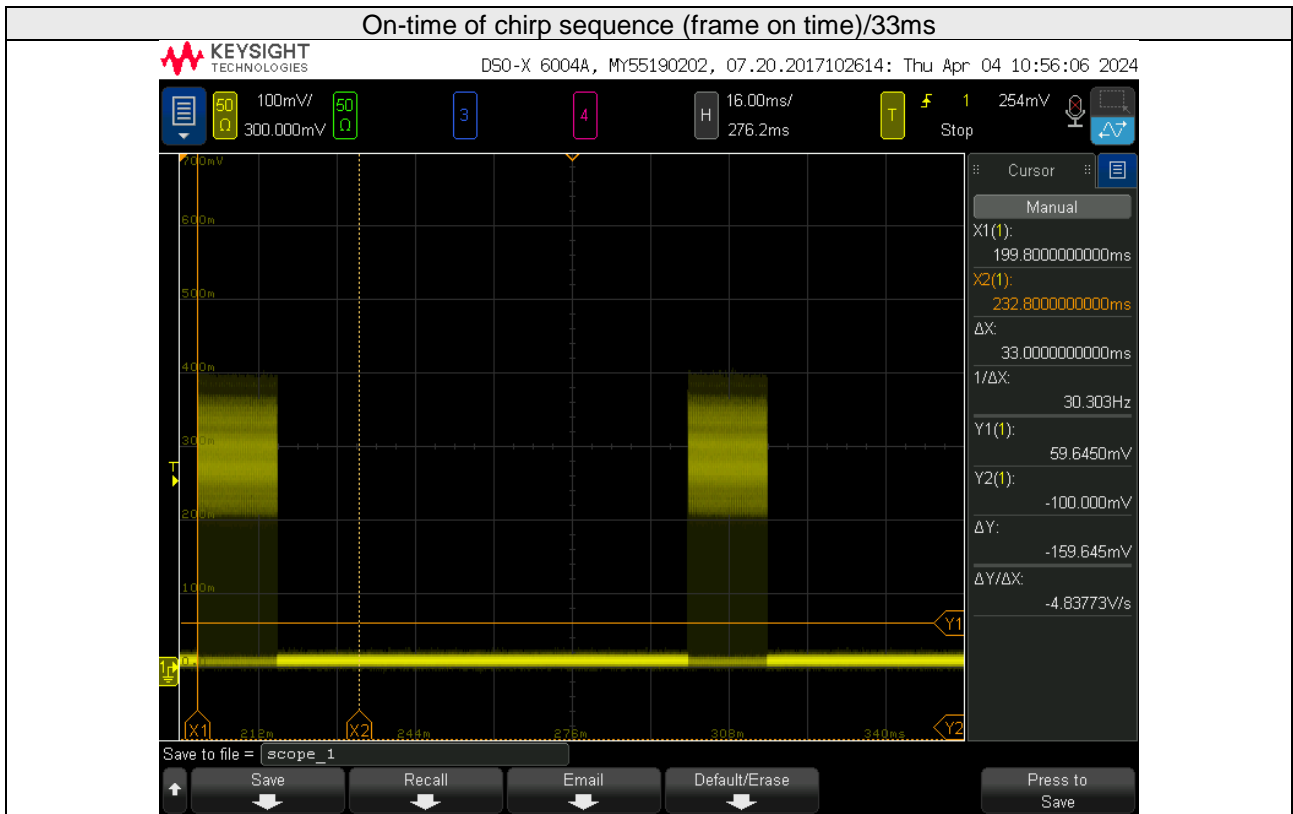

4.6 Frequency Stability Measurement

4.6.1 Limits of Frequency Stability Measurement

15.255(f) Fundamental emissions must be contained within the frequency bands specified in this section during all conditions of operation.

4.6.2 Test Setup

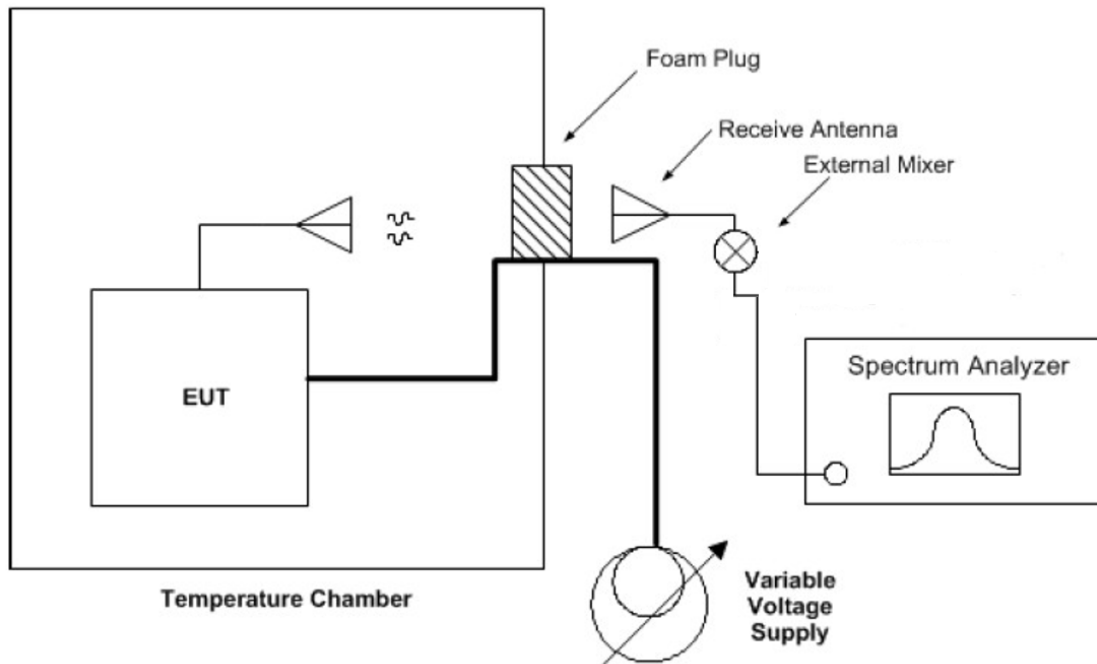

4.6.3 Test Instruments

Same as Item 4.2.3.

4.6.4 Test Procedure

- Arrange EUT and test equipment as above setup configuration.
- With the EUT at ambient temperature and voltage source set to the EUT nominal operating voltage (100%), record the spectrum mask of the EUT emission on the spectrum analyzer.
- Vary EUT power supply between 85% and 115% of nominal, and record the frequency excursion of the EUT emission mask.
- Set the power supply to 100% nominal setting, and raise EUT operating temperature to 50 °C. Record the frequency excursion of the EUT emission mask.
- Repeat step d) at each 10 °C increment down to -20 °C

4.6.5 Deviation from Test Standard

No deviation.

4.6.6 EUT Operating Condition

Same as 4.1.6.

4.6.7 Test Results

Frequency Stability Versus Temperature									
Operating Frequency: 61930 MHz									
Temp. (°C)	Power Supply (Vdc)	0 Minute		2 Minutes		5 Minutes		10 Minutes	
		FL	FH	FL	FH	FL	FH	FL	FH
50	5	61.03703	62.82323	61.03701	62.82321	61.03704	62.82324	61.03703	62.82323
40	5	61.03687	62.82307	61.03688	62.82308	61.03686	62.82306	61.03686	62.82306
30	5	61.03675	62.82295	61.03679	62.82299	61.03681	62.82301	61.03676	62.82296
20	5	61.03689	62.82309	61.03691	62.82311	61.03689	62.82309	61.0369	62.8231
10	5	61.03709	62.82329	61.03709	62.82329	61.03708	62.82328	61.0371	62.8233
0	5	61.037	62.8232	61.03703	62.82323	61.03699	62.82319	61.037	62.8232
-10	5	61.03662	62.82282	61.03662	62.82282	61.03664	62.82284	61.0366	62.8228
-20	5	61.03662	62.82282	61.03664	62.82284	61.03661	62.82281	61.03665	62.82285
-30	5	61.03717	62.82337	61.03719	62.82339	61.03715	62.82335	61.03721	62.82341

Frequency Stability Versus Voltage									
Operating Frequency: 61930 MHz									
Temp. (°C)	Power Supply (Vdc)	0 Minute		2 Minutes		5 Minutes		10 Minutes	
		FL	FH	FL	FH	FL	FH	FL	FH
20	5.75	61.03694	62.82314	61.03695	62.82315	61.03695	62.82315	61.03695	62.82315
	5	61.03689	62.82309	61.03691	62.82311	61.03689	62.82309	61.0369	62.8231
	4.25	61.03691	62.82311	61.0369	62.8231	61.03691	62.82311	61.03694	62.82314

5 Pictures of Test Arrangements

Please refer to the attached file (Test Setup Photo).

Appendix – Information of the Testing Laboratories

We, Bureau Veritas Consumer Products Services (H.K.) Ltd., Taoyuan Branch, were founded in 1988 to provide our best service in EMC, Radio, Telecom and Safety consultation. Our laboratories are FCC recognized accredited test firms and accredited according to ISO/IEC 17025.

If you have any comments, please feel free to contact us at the following:

Linko EMC/RF Lab

Tel: 886-2-26052180

Fax: 886-2-26051924

Hsin Chu EMC/RF/Telecom Lab

Tel: 886-3-6668565

Fax: 886-3-6668323

Hwa Ya EMC/RF/Safety Lab

Tel: 886-3-3183232

Fax: 886-3-3270892

Email: service.adt@tw.bureauveritas.com

Web Site: <http://ee.bureauveritas.com.tw>

The address and road map of all our labs can be found in our web site also.

--- END ---