



FCC RADIO TEST REPORT

Applicant : Ubiquiti Inc.
Address : 685 Third Avenue, New York, New York 10017, USA
Equipment : UniFi Access Reader G2 Pro
Model No. : UA-G2-Pro
Trade Name : UBIQUITI
FCC ID : SWX-UAG2P

I HEREBY CERTIFY THAT :

The sample was received on Dec. 21, 2022 and the testing was completed on Dec. 28, 2022 at CerpPASS Technology Corp. The test result refers exclusively to the test presented test model / sample. Without written approval of CerpPASS Technology Corp., the test report shall not be reproduced except in full.

Approved by:

Mark Liao / Supervisor

Laboratory Accreditation:

CerpPASS Technology Corporation Test Laboratory





Contents

1. Summary of Test Procedure and Test Results	4
1.1. Applicable Standards	4
2. Test Configuration of Equipment under Test	5
2.1. Feature of Equipment under Test	5
2.2. Carrier Frequency of Channels	5
2.3. Test Mode and Test Software	6
2.4. Description of Test System	7
2.5. General Information of Test	8
2.6. Measurement Uncertainty	8
3. Test Equipment and Ancillaries Used for Tests	9
4. Antenna Requirements	11
4.1. Standard Applicable	11
4.2. Antenna Construction and Directional Gain	11
5. Test of AC Power Line Conducted Emission	12
5.1. Test Limit	12
5.2. Test Procedures	12
5.3. Typical Test Setup	13
5.4. Test Result and Data	14
5.5. Test Photographs	16
6. Test of Radiated Emission	18
6.1. Test Limit	18
6.2. Test Procedures	19
6.3. Typical Test Setup Layout of Radiated Emission	20
6.4. Test Result and Data	21
6.5. 20dB Bandwidth	27
6.6. Test Photographs (9kHz ~ 30MHz)	28
6.7. Test Photographs (30MHz ~ 1GHz)	29
7. Frequency Stability	30
7.1. Test Procedure	30
7.2. Test Setup Layout	30
7.3. Test Result and Data	31
8. Radio Frequency Exposure	32
8.1. Applicable Standards	32
8.2. EUT Specification	33
8.3. Test Results	33



1. Summary of Test Procedure and Test Results

1.1. Applicable Standards

ANSI C63.10:2013

FCC Rules and Regulations Part 15 Subpart C §15.225

FCC Rule	Description of Test	Result
15.203	Antenna Requirement	PASS
15.207	AC Power Line Conducted Emission	PASS
15.209 15.225	Radiated Emission	PASS
15.225	20dB Bandwidth	PASS
15.225(e)	Frequency Stability	PASS

*The lab has reduced the uncertainty risk factor from test equipment, environment and staff technicians which according to the standard on contract. Therefore, the test result will only be determined by standard requirement.



2. Test Configuration of Equipment under Test

2.1. Feature of Equipment under Test

Operation Frequency Range	NFC: 13.553MHz ~ 13.567MHz BLE: 2400MHz ~ 2483.5MHz
Center Frequency Range	NFC: 13.56MHz BLE: 2402MHz ~ 2480MHz
Modulation Type	NFC: ASK BLE: GFSK
Modulation Technology	BLE: DTS
Data Rate	BLE: 1Mbps
Antenna Type	NFC: PCB ANT BLE: PIFA ANT
Antenna Gain	NFC: 0 dBi BLE: 1 dBi

Note: For more details, please refer to the User’s manual of the EUT.

2.2. Carrier Frequency of Channels

Channel	Frequency(MHz)
*1	13.56

Note: Channel remarked “*” is selected to perform test.



2.3. Test Mode and Test Software

- a. During testing, the interface cables and equipment positions were varied according to ANSI C63.10.
- b. The complete test system included NFC Card, PoE and EUT for RF test.
- c. Hardware control was executed to transmit and receive data via NFC.
- d. The test mode of RF test as follow:

Conducted Emissions from the AC mains power ports	
Test Mode	Operating Description
1	NFC-A ISO14443A, TX Mode
2	NFC-B ISO14443B, TX Mode
3	NFC-V ISO15693, TX Mode
caused "Test Mode 1" generated the worst case, it was reported as the final data.	
Radiation Emissions (9kHz ~ 30MHz)	
Test Mode	Operating Description
1	NFC-A ISO14443A, TX Mode
2	NFC-B ISO14443B, TX Mode
3	NFC-V ISO15693, TX Mode
caused "Test Mode 1" generated the worst case, it was reported as the final data.	
Radiation Emissions (30MHz ~ 1GHz)	
Test Mode	Operating Description
1	NFC-A ISO14443A, TX Mode
2	NFC-B ISO14443B, TX Mode
3	NFC-V ISO15693, TX Mode
caused "Test Mode 1" generated the worst case, it was reported as the final data.	
Note: There are two kinds of test voltage: AC 120V / 60Hz & AC 240V / 60Hz from PoE. For conducted emissions test, AC 240V / 60Hz is the worst case. For radiation emission (9kHz ~ 30MHz), AC 120V / 60Hz is the worst case. For radiation emission (30MHz ~ 1GHz), AC 240V / 60Hz is the worst case.	



2.4. Description of Test System

Radiated Emissions				
Equipment	Brand	Model	Length/Type	Power cord/ Length/Type
NFC Card	Tiananxin	NFC Tag Kit	N/A	N/A
POE	UBIQUITI	GP-H480-050G	N/A	N/A
RJ45 Cable	TE CONNECTIVITY	CAT5E	1.2m / NS	N/A

AC Power Line Conducted Emission				
Equipment	Brand	Model	Length/Type	Power cord/ Length/Type
NFC Card	Tiananxin	NFC Tag Kit	N/A	N/A
POE	UBIQUITI	GP-V480-032G	N/A	N/A
RJ45 Cable	TE CONNECTIVITY	CAT5E	1.2m / NS	N/A



2.5. General Information of Test

Test Site	CerpPASS Technology Corporation Test Laboratory Address: No.10, Ln. 2, Lianfu St., Luzhu Dist., Taoyuan City 33848, Taiwan (R.O.C.) Tel:+886-3-3226-888 Fax:+886-3-3226-881	
	FCC	TW1439, TW1079
	IC	4934E-1, 4934E-2
	VCCI	T-2205 for Telecommunication test C-4663 for Conducted emission test R-4218 for Radiated emission test G-10812, G-10813 for radiated disturbance above 1GHz
Frequency Range Investigated:	Conducted: from 150kHz to 30 MHz Radiation: from 30 MHz to 1,000MHz	
Test Distance:	The test distance of radiated emission from antenna to EUT is 3 M.	

Test Item	Test Site	Test period	Environmental Conditions	Tested By
Frequency Stability	RFCON01-NK	2022/12/28	20.3°C / 48%	Leon Huang
Radiated Emissions	3M02-NK	2022/12/26	17°C / 41%	Leon Huang
AC Power Line Conducted Emission	CON01-NK	2022/12/27	23°C / 60%	Leon Huang

2.6. Measurement Uncertainty

ISO/IEC 17025 requires that an estimate of the measurement uncertainties associated with the emissions test results be included in the report. The measurement uncertainties given below are based on a 95% confidence level (based on a coverage factor (k=2))

Measurement Item	Uncertainty
Radiated Spurious Emission(9KHz~30MHz)	±3.4dB
Radiated Spurious Emission(30MHz~1GHz)	±5.7dB
20dB Bandwidth	±4.4%
Occupied Bandwidth	±4.4%
Frequency Stability	±0.21KHz



3. Test Equipment and Ancillaries Used for Tests

Test Item	Radiated Emissions				
Test Site	Semi Anechoic Room(3M02-NK)				
Instrument	Manufacturer	Model No	Serial No	Calibration Date	Valid Date
Bilog Antenna	Schwarzbeck	VULB9168	369	2022/04/22	2023/04/21
Active Loop Antenna	EMCO	6507	40855	2022/05/25	2023/05/24
Horn Antenna	EMCO	3115	31601	2022/10/12	2023/10/11
Horn Antenna	EMCO	3116	31970	2022/03/18	2023/03/17
EMI Receiver	R&S	ESCI	101423	2022/07/05	2023/07/04
Spectrum Analyzer	R&S	FSV 40-N	101329	2022/07/20	2023/07/19
Preamplifier	Agilent	8449B	3008A01954	2022/03/17	2023/03/16
Preamplifier	EMC INSTRUMENTS	EMC184045	980065	2022/11/11	2023/11/10
Preamplifier	EM Electronics corp.	EM330	60660	2022/04/08	2023/04/07
Cable-6m (9k~300M)	NA	EMC5D-BM-BM-6	130605	2022/09/06	2023/09/05
Cable-3in1 (30M-1G)	HARBOUR INDUSTRIES	LL142	CCE1315	2022/03/21	2023/03/20
Cable-0.5m (30M-40G)	HUBER SUHNER	SUCOFLEX 102	28420/2	2022/04/09	2023/04/08
Cable-3m (30M-40G)	HUBER SUHNER	SUCOFLEX 102	MY2608/2	2022/04/09	2023/04/08
Cable-0.5m (1G-40G)	Rapidtek	40GHZ 50CM	38MS-38MS50314	2022/04/09	2023/04/08
Cable-3m (1G-40G)	Rapidtek	40GHZ 300CM	38MS-38MS300314	2022/04/09	2023/04/08
Cable-0.5m (1G-40G)	HUBER SUHNER	SUCOFLEX 104	805443/4	2022/01/11	2023/01/10
Cable-3m (1G-40G)	HUBER SUHNER	SUCOFLEX 104	805796/4	2022/01/11	2023/01/10
Cable-8m (1G-26.5G)	WOKEN	WCBA-WCA203SM	CCE1374	2022/04/25	2023/04/24
E3	AUDIX	v8.2014-8-6	RK-000529	NA	NA

Test Item	Frequency Stability				
Test Site	RFCON01-NK				
Instrument	Manufacturer	Model No	Serial No	Calibration Date	Valid Date
EXA Signal Analyzer	KEYSIGHT	N9010A	MY54200207	2022/04/19	2022/04/20
TEMP & HUMIDITY CHAMBER	T-MACHINE	TMJ-9712	T-12-040111	2022/08/15	2023/08/14



Test Item	AC Power Line Conducted Emission				
Test Site	CON02-NK				
Instrument	Manufacturer	Model No	Serial No	Calibration Date	Valid Date
EMI Receiver	R&S	ESCI	101423	2022/07/05	2023/07/04
TWO-LINE V-NETWORK	R&S	ENV216	102185	2022/08/24	2023/08/23
Pulse Limiter	R&S	ESH3-Z2	101933	2022/09/29	2023/09/28
Cable-6m (9k~300M)	NA	EMC5D-BM-B M-6	130605	2022/09/06	2023/09/05
E3	AUDIX	v8.2014-8-6	RK-000531	NA	NA



4. Antenna Requirements

4.1. Standard Applicable

For intentional device, according to FCC 47 CFR Section 15.203, an intentional radiator shall be designed to ensure that no antenna other than that furnished by the responsible party shall be used with the device.

And according to FCC 47 CFR Section 15.249, if transmitting antennas of directional gain greater than 6dBi are used, the power shall be reduced by the amount in dB that the directional gain of the antenna exceeds 6dBi.

4.2. Antenna Construction and Directional Gain

Antenna Type	PCB Antenna
Antenna Gain	0 dBi



5. Test of AC Power Line Conducted Emission

5.1. Test Limit

Conducted Emissions were measured from 150 kHz to 30 MHz with a bandwidth of 9 KHz, according to the methods defined in ANSI C63.10-2013. The EUT was placed on a nonmetallic stand in a shielded room 0.8 meters above the ground plane. The interface cables and equipment positioning were varied within limits of reasonable applications to determine the position produced maximum conducted emissions.

Frequency (MHz)	Quasi Peak (dB μ V)	Average (dB μ V)
0.15 – 0.5	66-56*	56-46*
0.5 – 5.0	56	46
5.0 – 30.0	60	50

*Decreases with the logarithm of the frequency.

5.2. Test Procedures

- a. The EUT was placed 0.4 meter from the conducting wall of the shielding room was kept at least 80 centimeters from any other grounded conducting surface.
- b. Connect EUT to the power mains through a line impedance stabilization network (LISN).
- c. All the support units are connecting to the other LISN.
- d. The LISN provides 50 ohm coupling impedance for the measuring instrument.
- e. The FCC states that a 50 ohm, 50 micro-Henry LISN should be used.
- f. Both sides of AC line were checked for maximum conducted interference.
- g. The frequency range from 150 kHz to 30 MHz was searched.
- h. Set the test-receiver system to Peak Detect Function and Specified Bandwidth with Maximum Hold Mode.



5.3. Typical Test Setup

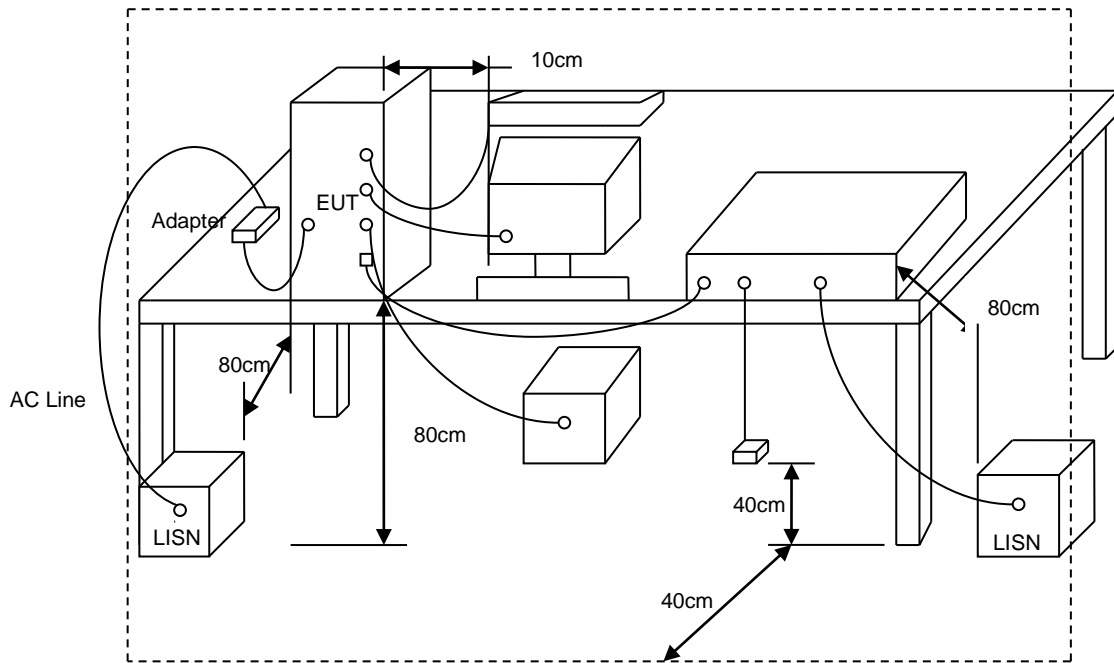



5.4. Test Result and Data

Power	: DC 48V From PoE (AC 240V / 60Hz)	Pol/Phase	: LINE
Test Mode	: Mode 1		:

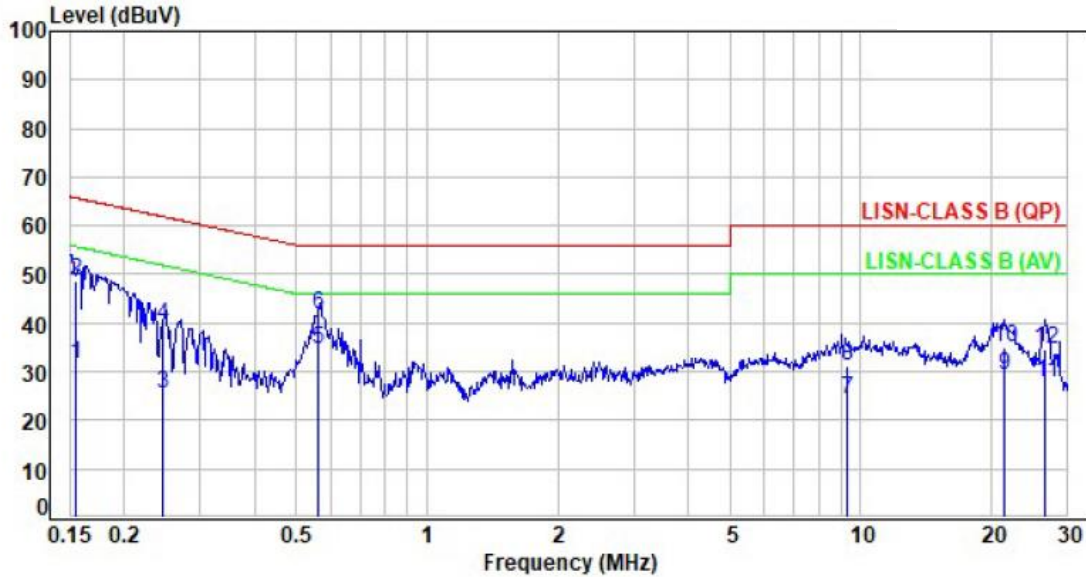

No.	Frequency (MHz)	Factor (dB)	Reading (dBuV)	Level (dBuV)	Limit (dBuV)	Margin (dB)	Detector	P/F
1	0.15	19.51	11.94	31.45	55.74	-24.29	Average	P
2	0.15	19.51	29.02	48.53	65.74	-17.21	QP	P
3	0.25	19.49	6.04	25.53	51.89	-26.36	Average	P
4	0.25	19.49	20.00	39.49	61.89	-22.40	QP	P
5	0.56	19.51	15.07	34.58	46.00	-11.42	Average	P
6	0.56	19.51	22.28	41.79	56.00	-14.21	QP	P
7	9.32	19.81	4.49	24.30	50.00	-25.70	Average	P
8	9.32	19.81	11.21	31.02	60.00	-28.98	QP	P
9	21.35	19.94	9.28	29.22	50.00	-20.78	Average	P
10	21.35	19.94	15.20	35.14	60.00	-24.86	QP	P
11	26.67	19.95	7.77	27.72	50.00	-22.28	Average	P
12	26.67	19.95	14.61	34.56	60.00	-25.44	QP	P

Note: Level=Reading+Factor
 Margin=Level-Limit
 Factor=(LISN or ISN or Current Probe)Factor + Cable Loss



Power	: DC 48V From PoE (AC 240V / 60Hz)	Pol/Phase	: NEUTRAL
Test Mode	: Mode 1		

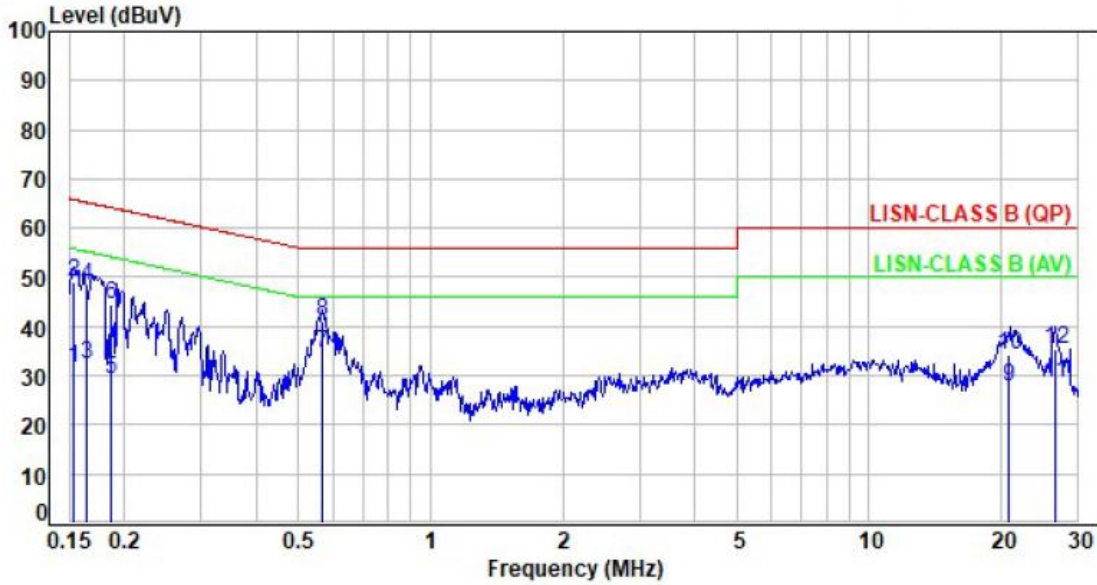

No.	Frequency (MHz)	Factor (dB)	Reading (dBuV)	Level (dBuV)	Limit (dBuV)	Margin (dB)	Detector	P/F
1	0.15	19.51	12.19	31.70	55.80	-24.10	Average	P
2	0.15	19.51	29.65	49.16	65.80	-16.64	QP	P
3	0.16	19.51	12.84	32.35	55.26	-22.91	Average	P
4	0.16	19.51	28.75	48.26	65.26	-17.00	QP	P
5	0.19	19.50	9.86	29.36	54.15	-24.79	Average	P
6	0.19	19.50	25.12	44.62	64.15	-19.53	QP	P
7	0.57	19.51	14.90	34.41	46.00	-11.59	Average	P
8	0.57	19.51	21.45	40.96	56.00	-15.04	QP	P
9	20.86	19.96	7.62	27.58	50.00	-22.42	Average	P
10	20.86	19.96	14.21	34.17	60.00	-25.83	QP	P
11	26.60	20.00	8.40	28.40	50.00	-21.60	Average	P
12	26.60	20.00	15.52	35.52	60.00	-24.48	QP	P

Note: Level=Reading+Factor
 Margin=Level-Limit
 Factor=(LISN or ISN or Current Probe)Factor + Cable Loss



6. Test of Radiated Emission

6.1. Test Limit

- (a) The field strength of any emissions within the band 13.553-13.567 MHz shall not exceed 15,848 microvolts/meter at 30 meters.
- (b) Within the bands 13.410-13.553 MHz and 13.567-13.710 MHz, the field strength of any emissions shall not exceed 334 microvolts/meter at 30 meters.
- (c) Within the bands 13.110-13.410 MHz and 13.710-14.010 MHz the field strength of any emissions shall not exceed 106 microvolts/meter at 30 meters.
- (d) The field strength of any emissions appearing outside of the 13.110-14.010 MHz band shall not exceed the general radiated emission limits in §15.209.

Frequency (MHz)	Distance	Limit (µV/ m)
0.09 ~ 0.490	300m	2400/F(kHz)
0.490 ~ 1.705	30m	24000/ F(kHz)
1.705 ~ 30	30m	30
30 ~ 88	3m	100
88 ~ 216	3m	150
216 ~ 960	3m	200
Above 960	3m	500

15.215 Additional provisions to the general radiated emission limitations.:

- (c) Intentional radiators operating under the alternative provisions to the general emission limits, as contained in §§15.217 through 15.257 and in subpart E of this part, must be designed to ensure that the 20 dB bandwidth of the emission, or whatever bandwidth may otherwise be specified in the specific rule section under which the equipment operates, is contained within the frequency band designated in the rule section under which the equipment is operated.



6.2. Test Procedures

- a. The EUT was placed on a rotatable table top 0.8 meter above ground.
- b. The EUT was set 3 meters from the interference receiving antenna which was mounted on the top of a variable height antenna tower.
- c. The table was rotated 360 degrees to determine the position of the highest radiation.
- d. The antenna is a broadband antenna and its height is varied between one meter and four meters above ground to find the maximum value of the field strength both horizontal polarization and vertical polarization of the antenna are set to make the measurement.
- e. For each suspected emission the EUT was arranged to its worst case and then tune the antenna tower (from 1 M to 4 M) and turn table (from 0 degree to 360 degrees) to find the maximum reading.
- f. Set the test-receiver system to Peak or CISPR quasi-peak Detect Function and specified bandwidth with Maximum Hold Mode.
- g. If the emission level of the EUT in peak mode was 3 dB lower than the limit specified, then testing will be stopped and peak values of EUT will be reported, otherwise, the emissions which do not have 3 dB margin will be repeated one by one using the quasi-peak method and reported.
- h. "Cone of radiation" has been considered to be 3dB beamwidth of the measurement antenna.

Note:

1. The resolution bandwidth of test receiver/spectrum analyzer is 300Hz or CISPS 200Hz(QP detector) at frequency Below 150 kHz.
2. The resolution bandwidth of test receiver/spectrum analyzer is 10KHz or CISPS 9KHz(QP detector) at frequency 150 kHz to 30 MHz.
3. The resolution bandwidth and video bandwidth of test receiver/spectrum analyzer is 120kHz for Peak detection (PK) and Quasi-peak detection (QP) at frequency below 1GHz.

Note: The supporting fixture shall permit orientation of the EUT in each of three orthogonal axis positions such that emissions from the EUT are maximized. (Y-AXIS is the worst.)



6.3. Typical Test Setup Layout of Radiated Emission

Below 30MHz test setup

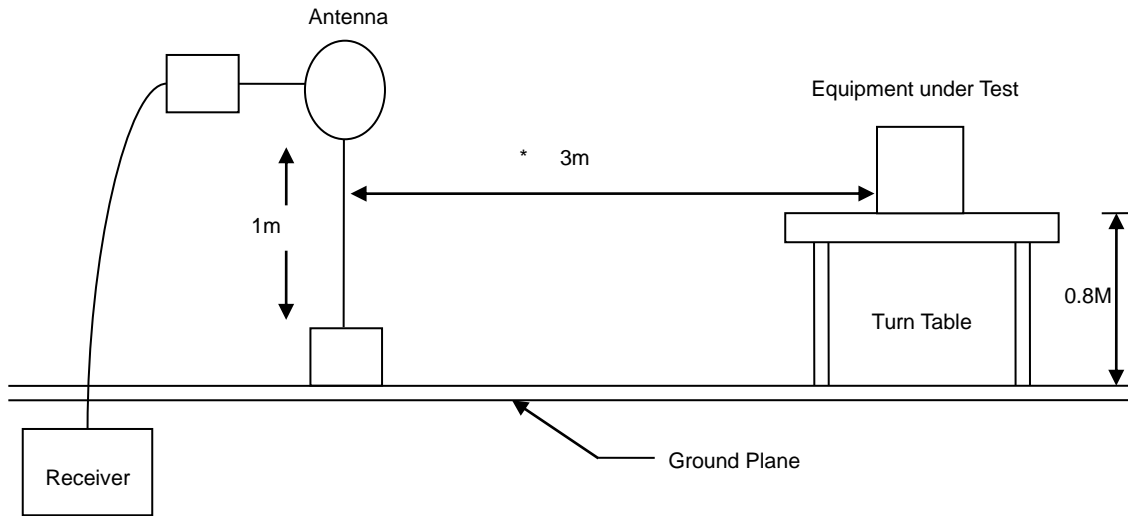

30MHz- 1GHz Test Setup

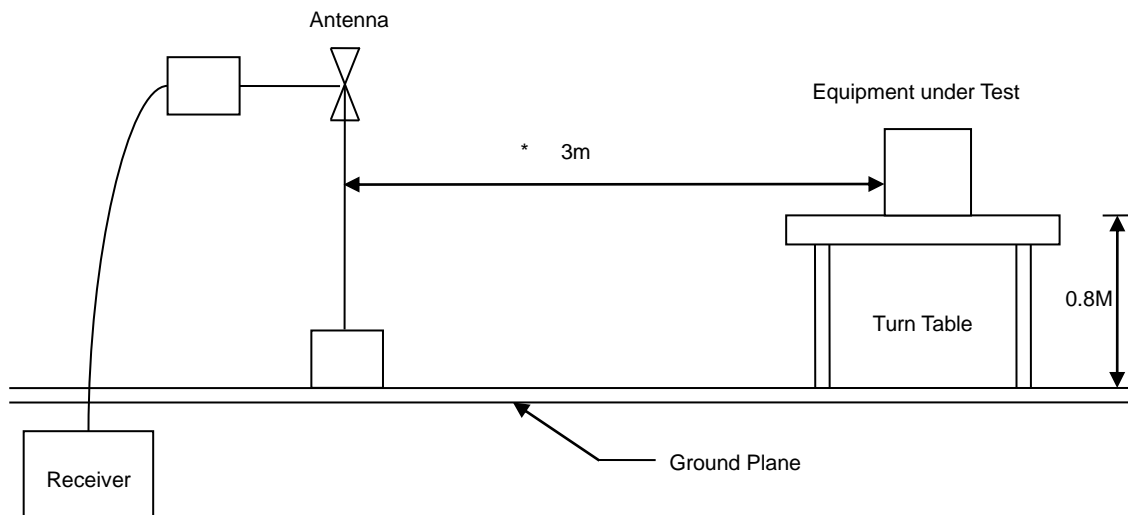



6.4. Test Result and Data

6.4.1. Test Result of Fundamental Emission

Power	: DC 48V From PoE (AC 120V / 60Hz)	Pol/Phase	: Open
Test Mode	: Mode 1		:

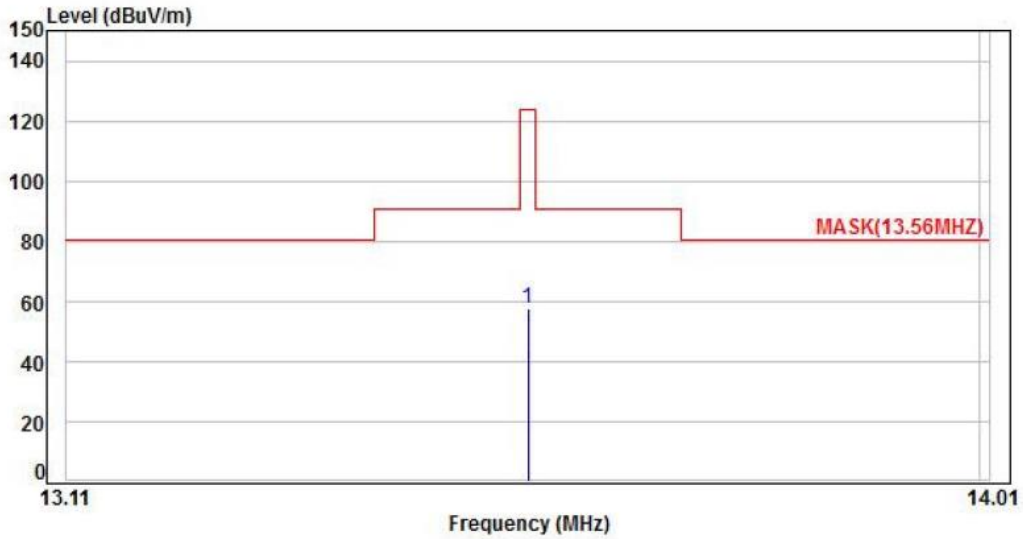

No.	Frequency (MHz)	Factor (dB)	Reading (dBuV)	Level (dBuV/m)	Limit (dBuV/m)	Margin (dB)	Detector	Height (cm)	Azimuth (deg)	P/F
1	13.56	17.23	40.25	57.48	124.00	-66.52	Peak	100	360	P

Note: Level=Reading+Factor
Margin=Level-Limit
Factor=Antenna Factor + cable loss - Amplifier Factor



Power	: DC 48V From PoE (AC 120V / 60Hz)	Pol/Phase	: Close
Test Mode	: Mode 1		:

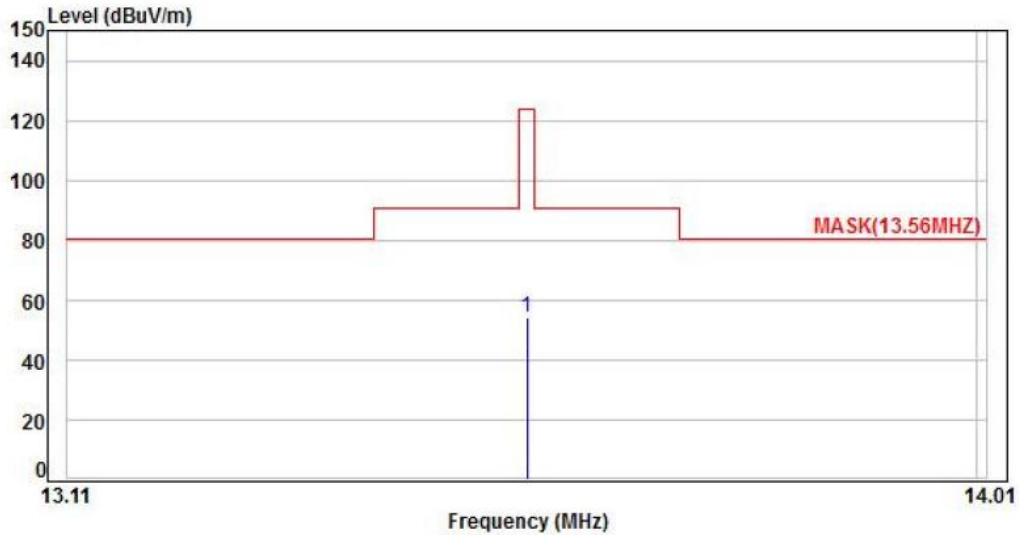

No.	Frequency (MHz)	Factor (dB)	Reading (dBuV)	Level (dBuV/m)	Limit (dBuV/m)	Margin (dB)	Detector	Height (cm)	Azimuth (deg)	P/F
1	13.56	17.23	37.15	54.38	124.00	-69.62	Peak	100	269	P

Note: Level=Reading+Factor
Margin=Level-Limit
Factor=Antenna Factor + cable loss - Amplifier Factor



6.4.2. Test Result of Unwanted Spurious emission (9KHz ~ 30MHz)

Power	: DC 48V From PoE (AC 120V / 60Hz)	Pol/Phase	: Open
Test Mode	: Mode 1		:

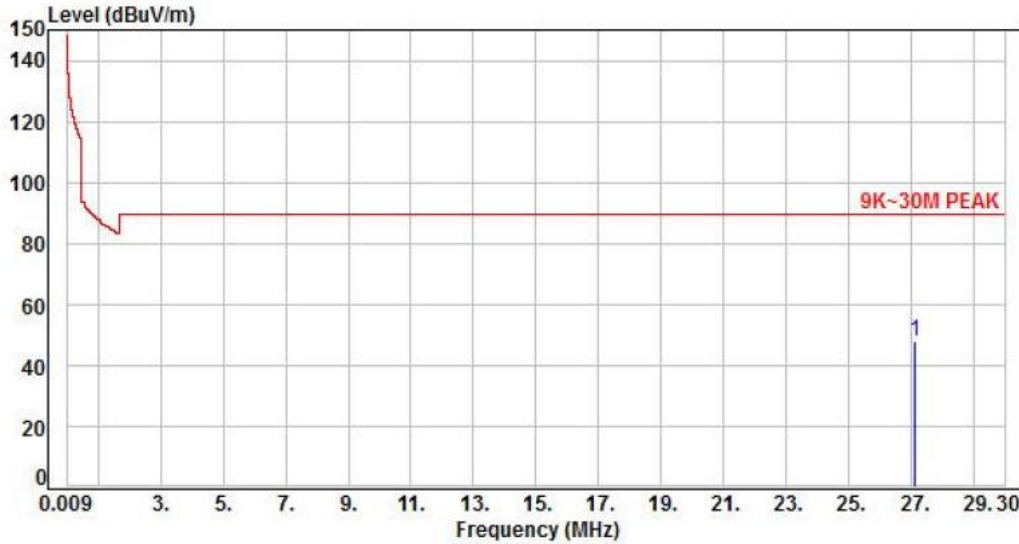

No.	Frequency (MHz)	Factor (dB)	Reading (dBuV)	Level (dBuV/m)	Limit (dBuV/m)	Margin (dB)	Detector	Height (cm)	Azimuth (deg)	P/F
1	27.12	16.40	31.47	47.87	89.54	-41.67	Peak	100	141	P

Note: Level=Reading+Factor
Margin=Level-Limit
Factor=Antenna Factor + cable loss - Amplifier Factor



Power	: DC 48V From PoE (AC 120V / 60Hz)	Pol/Phase	: Close
Test Mode	: Mode 1		:

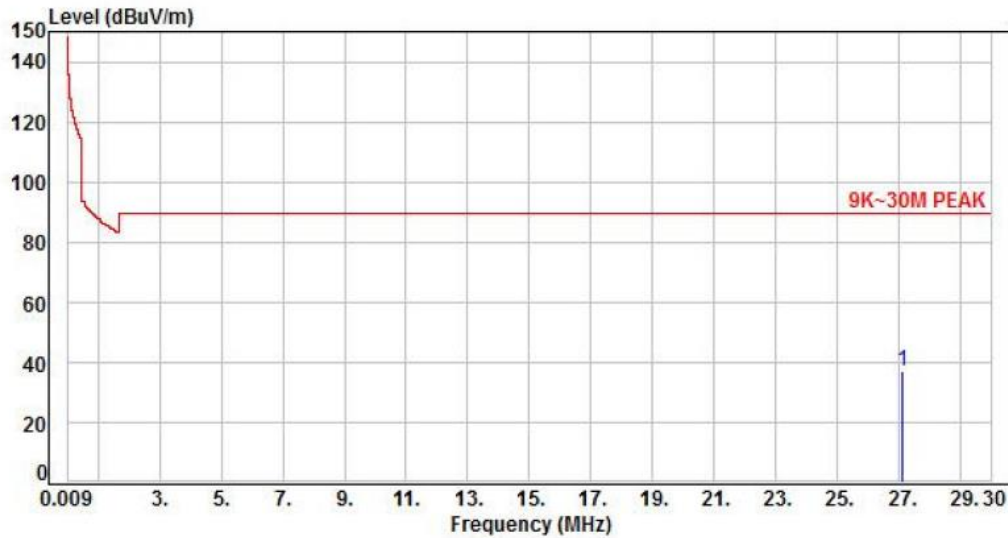

No.	Frequency (MHz)	Factor (dB)	Reading (dBuV)	Level (dBuV/m)	Limit (dBuV/m)	Margin (dB)	Detector	Height (cm)	Azimuth (deg)	P/F
1	27.12	16.40	20.77	37.17	89.54	-52.37	Peak	100	48	P

Note: Level=Reading+Factor
Margin=Level-Limit
Factor=Antenna Factor + cable loss - Amplifier Factor



6.4.3. Test Result of Unwanted Spurious emission (30GHz ~ 1GHz)

Power	: DC 48V From PoE (AC 240V / 60Hz)	Pol/Phase	: VERTICAL
Test Mode	: Mode 1		:

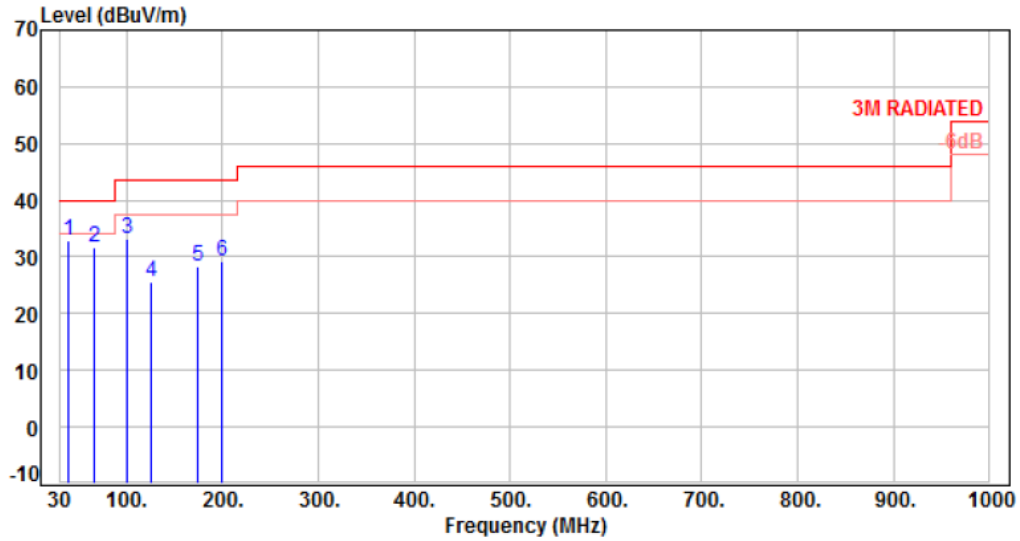

No.	Frequency (MHz)	Factor (dB)	Reading (dBUV)	Level (dBUV/m)	Limit (dBUV/m)	Margin (dB)	Detector	Height (cm)	Azimuth (deg)	P/F
1	39.70	-9.13	42.15	33.02	40.00	-6.98	QP	100	286	P
2	66.86	-11.24	42.82	31.58	40.00	-8.42	Peak	100	360	P
3	99.84	-13.96	47.17	33.21	43.50	-10.29	Peak	100	360	P
4	125.06	-10.92	36.54	25.62	43.50	-17.88	Peak	100	360	P
5	173.56	-9.86	38.06	28.20	43.50	-15.30	Peak	100	360	P
6	198.78	-11.97	41.15	29.18	43.50	-14.32	Peak	100	360	P

Note: Level=Reading+Factor
 Margin=Level-Limit
 Factor=Antenna Factor + cable loss - Amplifier Factor



Power	: DC 48V From PoE (AC 240V / 60Hz)	Pol/Phase	: HORIZONTAL
Test Mode	: Mode 1		:

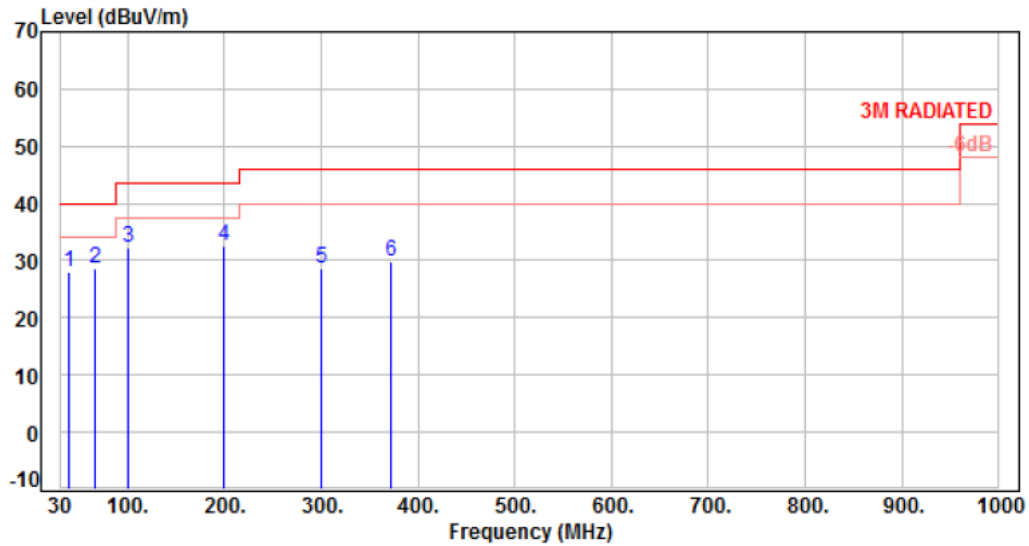

No.	Frequency (MHz)	Factor (dB)	Reading (dBuV)	Level (dBuV/m)	Limit (dBuV/m)	Margin (dB)	Detector	Height (cm)	Azimuth (deg)	P/F
1	39.70	-9.13	37.19	28.06	40.00	-11.94	Peak	100	0	P
2	66.86	-11.24	39.92	28.68	40.00	-11.32	Peak	100	0	P
3	99.84	-13.96	46.33	32.37	43.50	-11.13	Peak	100	0	P
4	198.78	-11.97	44.53	32.56	43.50	-10.94	Peak	100	0	P
5	299.66	-8.28	37.06	28.78	46.00	-17.22	Peak	100	0	P
6	371.44	-6.30	36.13	29.83	46.00	-16.17	Peak	100	0	P

Note: Level=Reading+Factor
Margin=Level-Limit
Factor=Antenna Factor + cable loss - Amplifier Factor



6.5. 20dB Bandwidth

Modulation Mode	Freq. (MHz)	20dB Bandwidth (kHz)	F _L at 20dB BW (MHz)	F _H at 20dB BW (MHz)
RFID	13.56	2.62	13.5588	13.56142
Limit		N/A	13.553	13.567
Result		Pass		

20dB Bandwidth 13.56 MHz

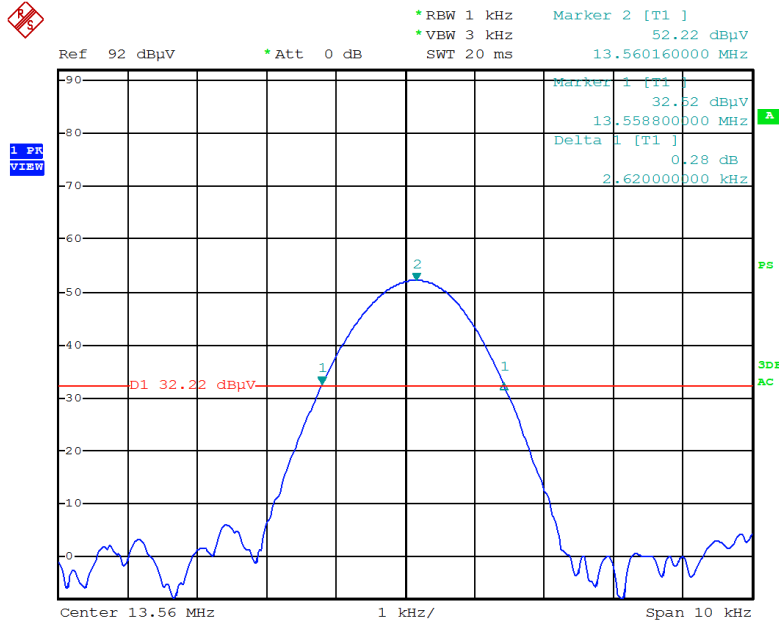



7. Frequency Stability

7.1. Test Procedure

According to the methods defined in ANSI C63.10-2013 Section 6.8

1. The EUT was placed inside the Temperature and Humidity chamber.
2. The transmitter output was connected to spectrum analyzer.
3. Turn the EUT on and couple its output to a spectrum analyzer.
4. Turn the EUT off and set the chamber to the highest temperature specified.
5. Allow sufficient time (approximately 30 min) for the temperature of the chamber to stabilize, turn the EUT on and measure the operating frequency after 2, 5, and 10 minutes.
6. Repeat step 2 and 3 with the temperature chamber set to the lowest temperature.
7. The test chamber was allowed to stabilize at +20 degree C for a minimum of 30 minutes. The supply voltage was then adjusted on the EUT from 85% to 115% and the frequency record.

7.2. Test Setup Layout

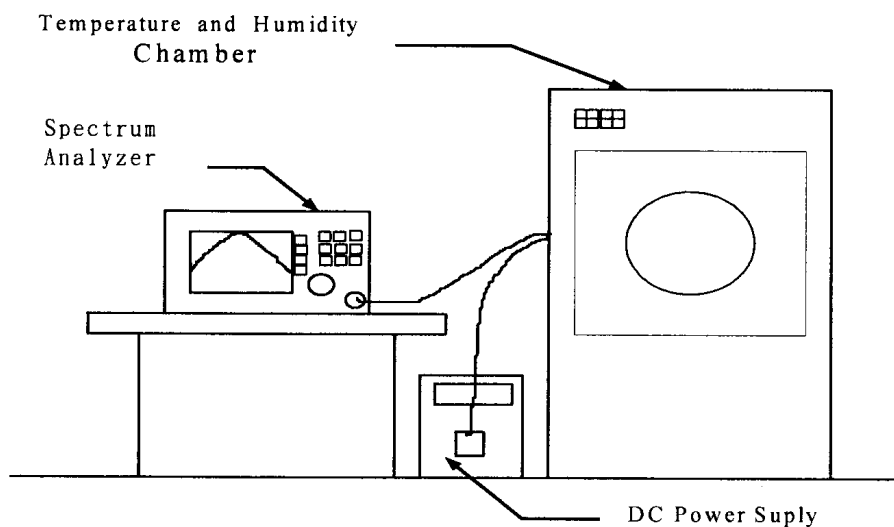



7.3. Test Result and Data

Operating frequency:13.56MHz

NFC-A ISO14443A									
Temp (°C)	Power supply (V)	0 minute		2 minute		5 minute		10 minute	
		(MHz)	(%)	(MHz)	(%)	(MHz)	(%)	(MHz)	(%)
40	40.8	13.56010	0.00074	13.56008	0.00059	13.56010	0.00074	13.56008	0.00059
	48	13.56008	0.00059	13.56008	0.00059	13.56008	0.00059	13.56008	0.00059
	55.2	13.56008	0.00059	13.56008	0.00059	13.56008	0.00059	13.56008	0.00059
30	40.8	13.56010	0.00074	13.56010	0.00074	13.56010	0.00074	13.56010	0.00074
	48	13.56010	0.00074	13.56010	0.00074	13.56010	0.00074	13.56010	0.00074
	55.2	13.56010	0.00074	13.56010	0.00074	13.56010	0.00074	13.56010	0.00074
20	40.8	13.56012	0.00088	13.56012	0.00088	13.56012	0.00088	13.56012	0.00088
	48	13.56012	0.00088	13.56014	0.00103	13.56012	0.00088	13.56012	0.00088
	55.2	13.56012	0.00088	13.56012	0.00088	13.56012	0.00088	13.56012	0.00088
10	40.8	13.56014	0.00103	13.56016	0.00118	13.56016	0.00118	13.56014	0.00103
	48	13.56014	0.00103	13.56016	0.00118	13.56016	0.00118	13.56016	0.00118
	55.2	13.56014	0.00103	13.56016	0.00118	13.56016	0.00118	13.56016	0.00118
0	40.8	13.56016	0.00118	13.56016	0.00118	13.56016	0.00118	13.56016	0.00118
	48	13.56016	0.00118	13.56016	0.00118	13.56016	0.00118	13.56016	0.00118
	55.2	13.56016	0.00118	13.56016	0.00118	13.56014	0.00103	13.56016	0.00118
-10	40.8	13.56016	0.00118	13.56016	0.00118	13.56016	0.00118	13.56016	0.00118
	48	13.56016	0.00118	13.56016	0.00118	13.56016	0.00118	13.56016	0.00118
	55.2	13.56016	0.00118	13.56016	0.00118	13.56016	0.00118	13.56016	0.00118