



427 West 12800 South  
Draper, UT 84020

## Test Report Attachment

<b>FCC ID</b>	SWX-U7PROM
<b>ISED ID</b>	6545A-U7PROM
<b>Equipment Under Test</b>	U7-Pro-Max
<b>Test Report Serial Number</b>	TR8803_01
<b>Date of Tests</b>	12 January 2024
<b>Report Issue Date</b>	9 February 2024

### Test Personnel

<b>Testing performed by</b>	Evan Hartzell
-----------------------------	---------------

### Test Location

Testing was performed at the Unified Compliance Laboratory located at 427 West 12800 South, Draper, UT 84020. Unified Compliance Laboratory is accredited by National Voluntary Laboratory Accreditation Program (NVLAP); NVLAP Code 600241-0 which is effective until 30 June 2024. This site has also been registered with Innovations, Science and Economic Development (ISED) department as was accepted under Appendix B, Phase 1 procedures of the APEC Tel MRA for Canadian recognition. ISED No.: 25346, effective until 30 June 2024. Unified Compliance Laboratory has been assigned Conformity Assessment Number US0223 by ISED and MRA US5037.



# 1 Table of Contents

Test Personnel.....	1
Test Location .....	1
2 UNII-2 Band .....	3
2.1 2A.....	3
2.1.1 a Mode .....	3
2.1.2 ax Mode.....	15
2.2 2C.....	38
2.2.1 a Mode .....	38
2.2.2 ax Mode.....	49

## 2 UNII-2 Band

### 2.1 2A

#### 2.1.1 a Mode

#### Summary

Test	Frequency (MHz)	Nominal Power (dBm)	Nominal Bandwidth (MHz)	Result
Emission Bandwidth 26 dB	5260.000	24.0	20.000000	PASS
RF output power	5260.000	24.0	20.000000	PASS
Power Spectral Density	5260.000	24.0	20.000000	PASS
Occupied Channel Bandwidth 99%	5260.000	24.0	20.000000	PASS
Emission Bandwidth 26 dB	5280.000	24.0	20.000000	PASS
Power Spectral Density	5280.000	24.0	20.000000	PASS
Occupied Channel Bandwidth 99%	5280.000	24.0	20.000000	PASS
Emission Bandwidth 26 dB	5320.000	24.0	20.000000	PASS
Power Spectral Density	5320.000	24.0	20.000000	PASS
Occupied Channel Bandwidth 99%	5320.000	24.0	20.000000	PASS

### Emission Bandwidth 26 dB (5260 MHz; 24.000 dBm; 20 MHz)

Customized settings.

#### 26 dB Bandwidth

DUT Frequency (MHz)	Bandwidth (MHz)	Limit Min (MHz)	Limit Max (MHz)	Band Edge Left (MHz)	Band Edge Right (MHz)
5260.000000	22.600000	---	---	5248.750000	5271.350000

(continuation of the "26 dB Bandwidth" table from column 6 ...)

DUT Frequency (MHz)	Max Level (dBm)	Result
5260.000000	4.2	PASS

26 dB Bandwidth

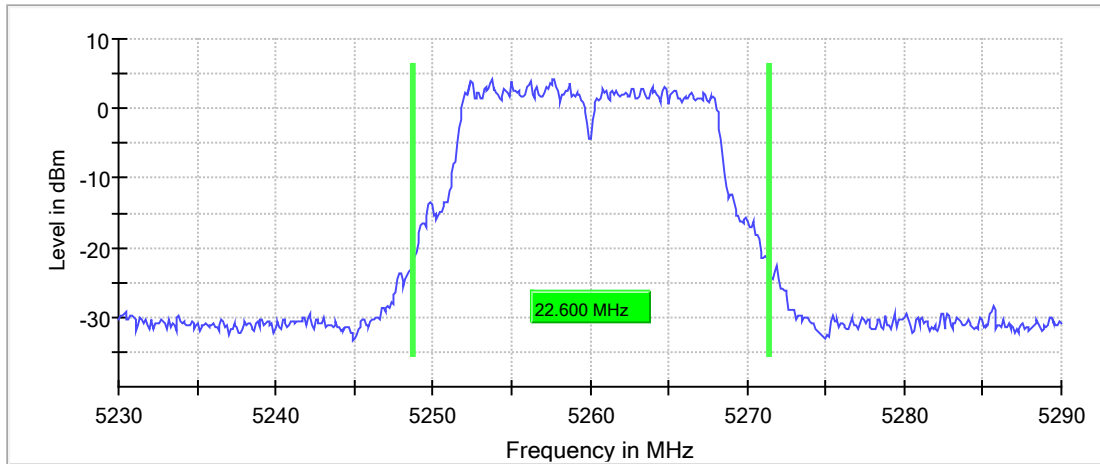

Bandwidth

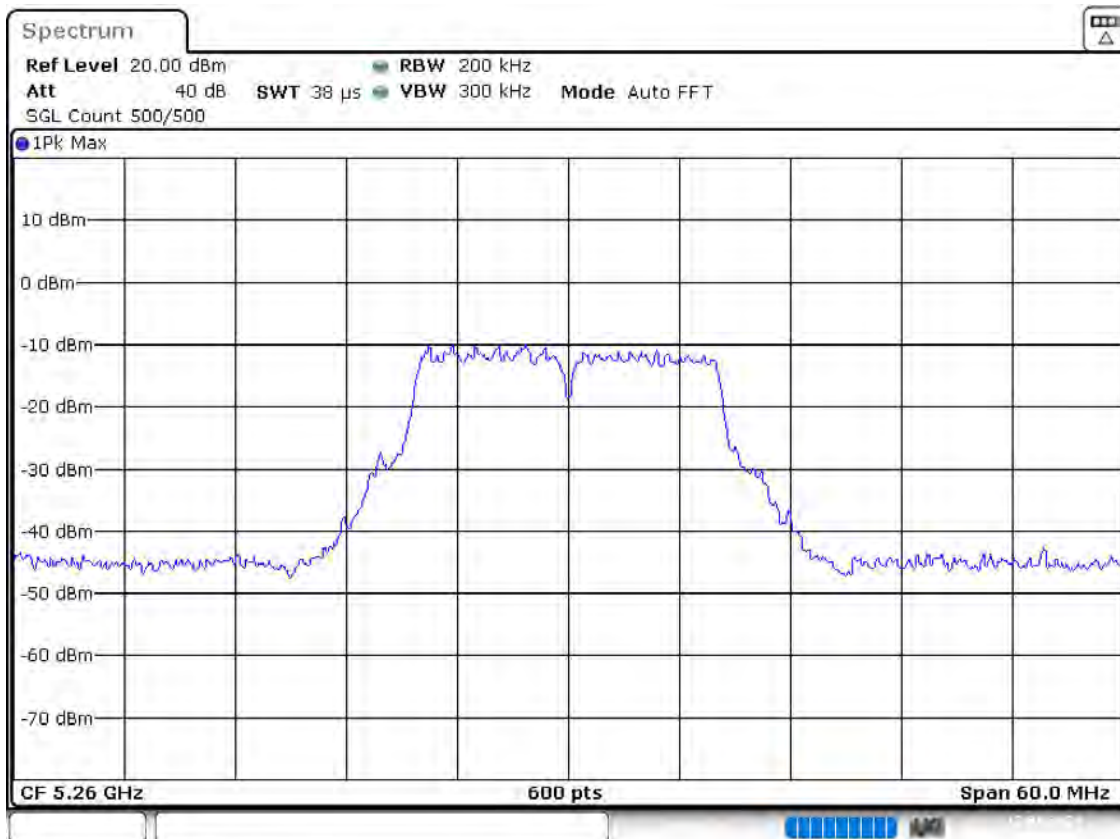

Date: 12.JAN.2024 02:04:49

## Measurement

Setting	Instrument Value	Target Value
Start Frequency	5.23000 GHz	5.23000 GHz
Stop Frequency	5.29000 GHz	5.29000 GHz
Span	60.000 MHz	60.000 MHz
RBW	200.000 kHz	~ 200.000 kHz
VBW	300.000 kHz	>= 240.000 kHz
SweepPoints	600	~ 600
SweepTime	37.969 $\mu$ s	AUTO
Reference Level	20.000 dBm	20.000 dBm
Attenuation	40.000 dB	AUTO
Detector	MaxPeak	MaxPeak
SweepCount	500	500
Filter	3 dB	3 dB
Trace Mode	Max Hold	Max Hold
SweepType	FFT	AUTO
Preamp	off	off

## RF output power (5260 MHz; 24.000 dBm; 20 MHz)

Customized settings.

## Result

DUT Frequency (MHz)	Gated RMS (dBm)	Limit Max (dBm)	Gated EIRP (dBm)	DutyCycle (%)	Result
5260.000000	23.5	24.0	23.5	99.226	PASS

## OSP PowerMeter settings

Setting	Instrument Value	Target Value
Measurement Time	1.000 s	1.000 s
Points	1000000	1000000
Time resolution	1.000 $\mu$ s	1.000 $\mu$ s

## Power Spectral Density (5260 MHz; 24.000 dBm; 20 MHz)

Customized settings.

### Result

DUT Frequency (MHz)	Frequency (MHz)	PSD (dBm)	Limit Max (dBm)	Result
5260.000000	5261.980198	8.467	11.0	PASS

### Ports

Port	State
1	used
2	used
3	used
4	used

Power Spectral Density

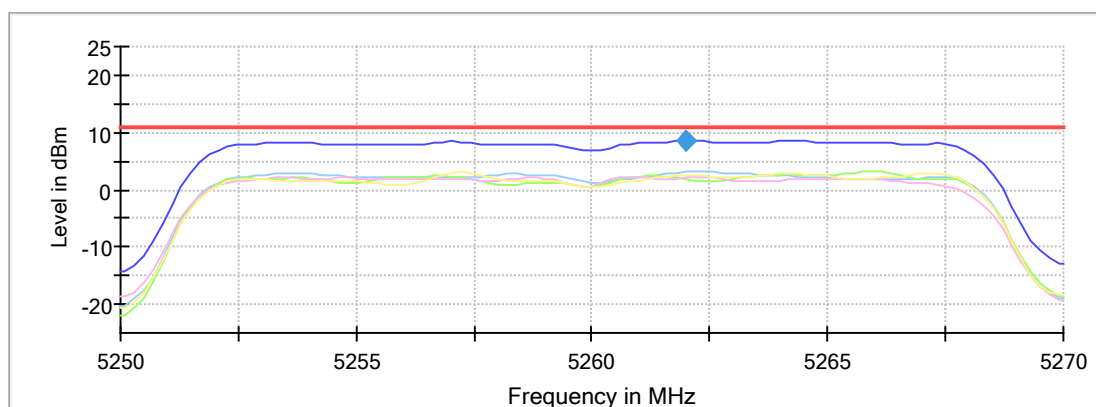

— Connector 1    — Connector 2    — Connector 3    — Connector 4  
— Sum Level    — Limit    ◆ PSD

### Measurement

Setting	Instrument Value	Target Value
Start Frequency	5.25000 GHz	5.25000 GHz
Stop Frequency	5.27000 GHz	5.27000 GHz
Span	20.000 MHz	20.000 MHz
RBW	1.000 MHz	<= 1.000 MHz
VBW	3.000 MHz	>= 3.000 MHz
SweepPoints	101	~ 40
Sweeptime	3.788 $\mu$ s	AUTO
Reference Level	20.000 dBm	20.000 dBm
Attenuation	40.000 dB	AUTO
Detector	RMS	RMS
SweepCount	100	100
Filter	3 dB	3 dB
Trace Mode	Average Power	Average Power
SweepType	FFT	AUTO
Preamp	off	off

## Occupied Channel Bandwidth 99% (5260 MHz; 24.000 dBm; 20 MHz)

Customized settings.

### 99 % Bandwidth

DUT Frequency (MHz)	Bandwidth (MHz)	Limit Min (MHz)	Limit Max (MHz)	Band Edge Left (MHz)	Band Edge Right (MHz)
5260.000000	16.900000	---	---	5251.450000	5268.350000

(continuation of the "99 % Bandwidth" table from column 6 ...)

DUT Frequency (MHz)	Result
5260.000000	PASS

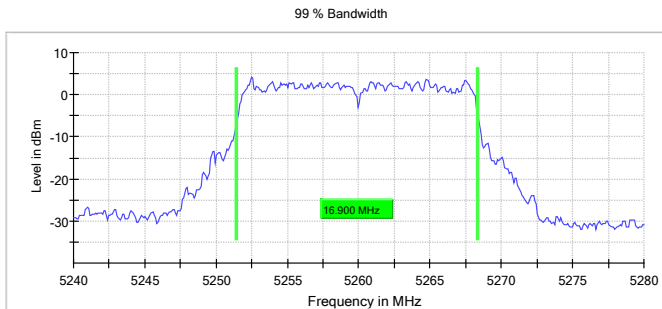

### Bandwidth

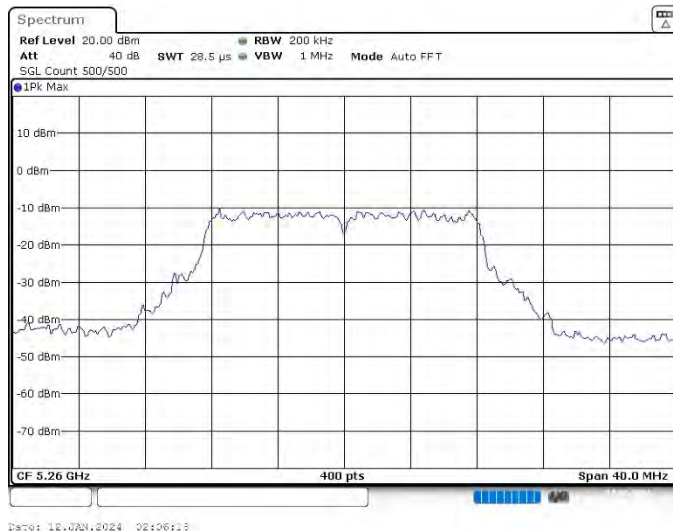

## Measurement

Setting	Instrument Value	Target Value
Start Frequency	5.24000 GHz	5.24000 GHz
Stop Frequency	5.28000 GHz	5.28000 GHz
Span	40.000 MHz	40.000 MHz
RBW	200.000 kHz	>= 200.000 kHz
VBW	1.000 MHz	>= 600.000 kHz
SweepPoints	400	~ 400
SweepTime	28.477 $\mu$ s	AUTO
Reference Level	20.000 dBm	20.000 dBm
Attenuation	40.000 dB	AUTO
Detector	MaxPeak	MaxPeak
SweepCount	500	500
Filter	3 dB	3 dB
Trace Mode	Max Hold	Max Hold
SweepType	FFT	AUTO
Preamp	off	off

## Emission Bandwidth 26 dB (5280 MHz; 24.000 dBm; 20 MHz)

Customized settings.

### 26 dB Bandwidth

DUT Frequency (MHz)	Bandwidth (MHz)	Limit Min (MHz)	Limit Max (MHz)	Band Edge Left (MHz)	Band Edge Right (MHz)
5280.000000	22.300000	---	---	5268.950000	5291.250000

(continuation of the "26 dB Bandwidth" table from column 6 ...)

DUT Frequency (MHz)	Max Level (dBm)	Result
5280.000000	3.4	PASS



26 dB Bandwidth

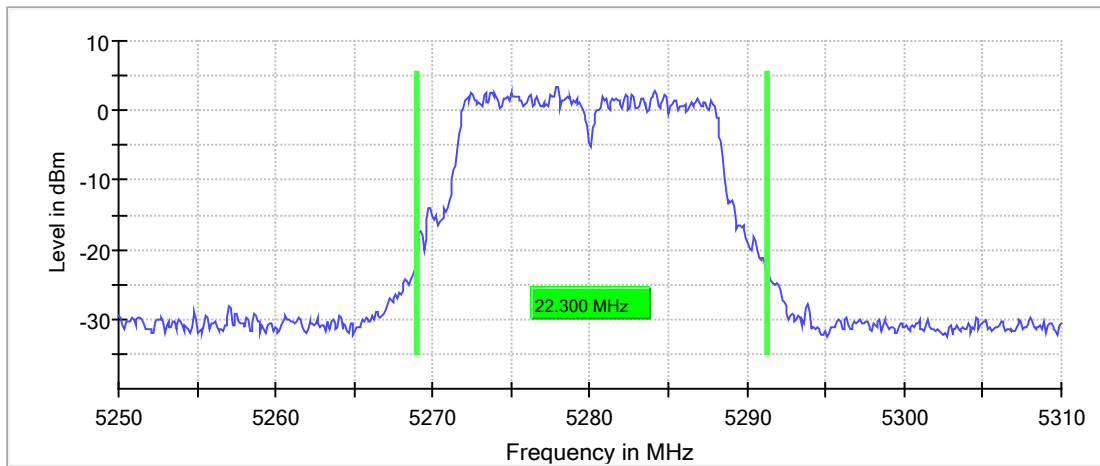

Bandwidth

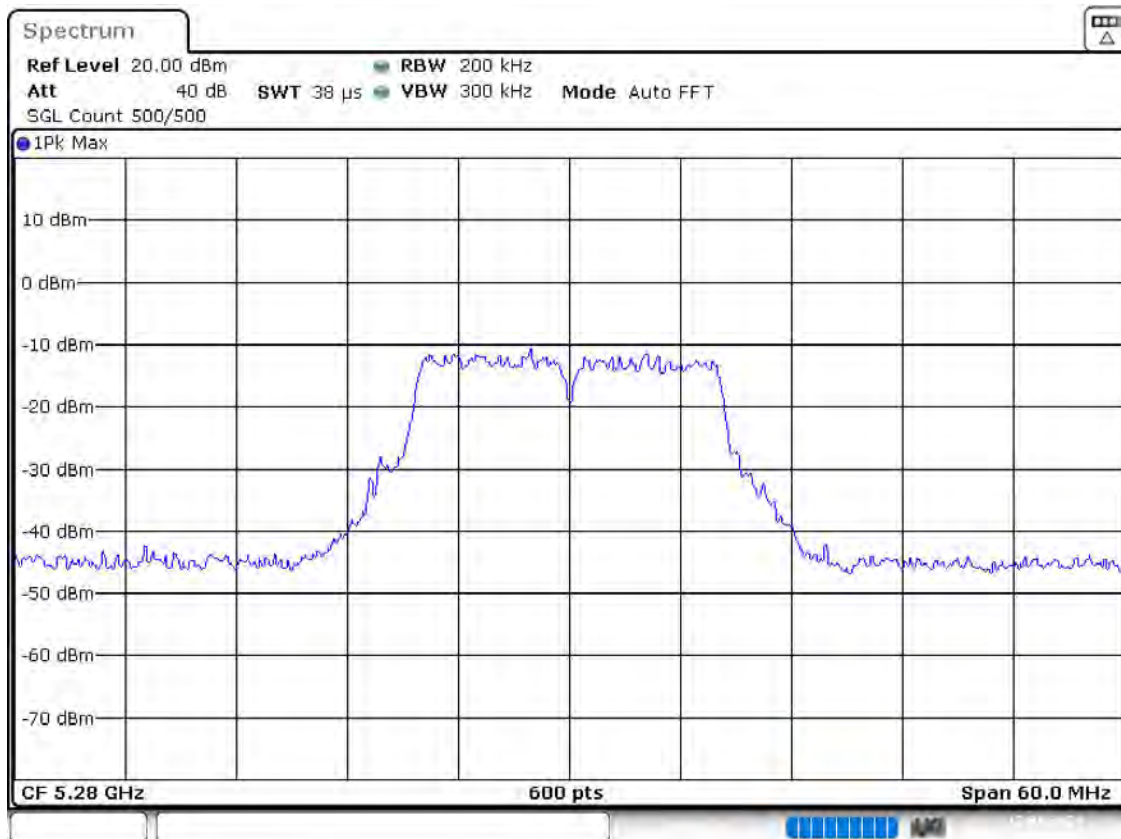

Date: 12.JAN.2024 02:06:45

## Power Spectral Density (5280 MHz; 24.000 dBm; 20 MHz)

Customized settings.

### Result

DUT Frequency (MHz)	Frequency (MHz)	PSD (dBm)	Limit Max (dBm)	Result
5280.000000	5277.425743	7.869	11.0	PASS

### Ports

Port	State
1	used
2	used
3	used
4	used

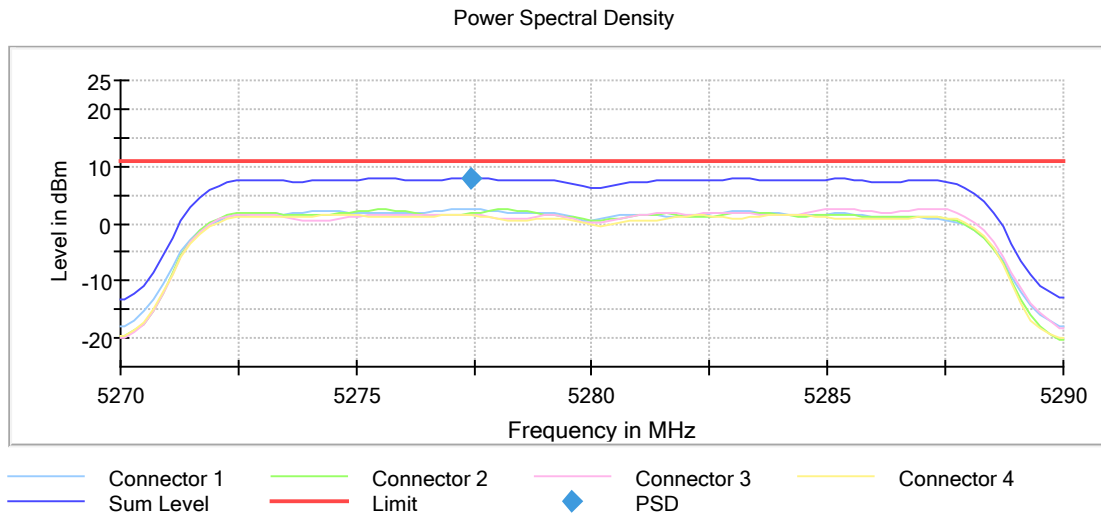

## Occupied Channel Bandwidth 99% (5280 MHz; 24.000 dBm; 20 MHz)

Customized settings.

### 99 % Bandwidth

DUT Frequency (MHz)	Bandwidth (MHz)	Limit Min (MHz)	Limit Max (MHz)	Band Edge Left (MHz)	Band Edge Right (MHz)
5280.000000	16.900000	---	---	5271.450000	5288.350000

(continuation of the "99 % Bandwidth" table from column 6 ...)

DUT Frequency (MHz)	Result
5280.000000	PASS

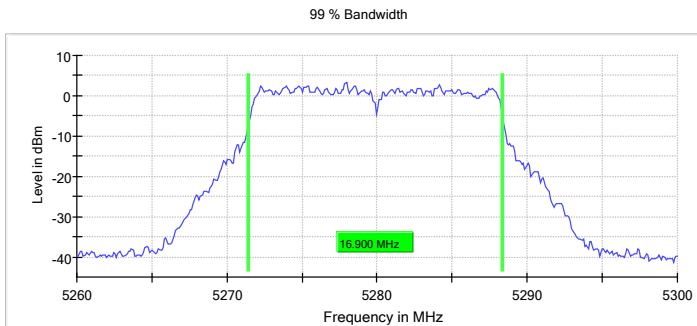

### Bandwidth



Date: 12.JAN.2024 02:06:16

## Emission Bandwidth 26 dB (5320 MHz; 24.000 dBm; 20 MHz)

Customized settings.

### 26 dB Bandwidth

DUT Frequency (MHz)	Bandwidth (MHz)	Limit Min (MHz)	Limit Max (MHz)	Band Edge Left (MHz)	Band Edge Right (MHz)
5320.000000	22.500000	---	---	5308.750000	5331.250000

(continuation of the "26 dB Bandwidth" table from column 6 ...)

DUT Frequency (MHz)	Max Level (dBm)	Result
5320.000000	3.2	PASS

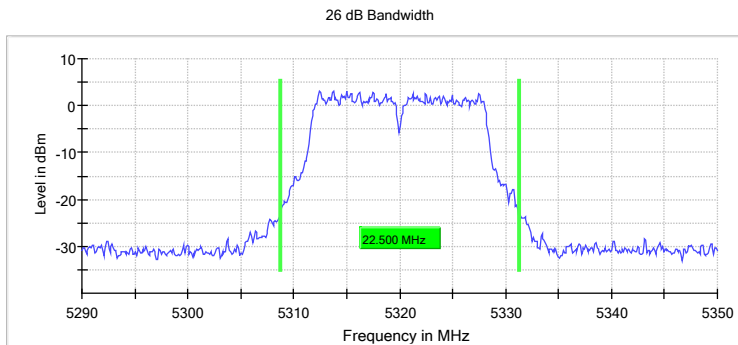

### Bandwidth



Date: 19, JAN, 2020 02:15:53

## Power Spectral Density (5320 MHz; 24.000 dBm; 20 MHz)

Customized settings.

### Result

DUT Frequency (MHz)	Frequency (MHz)	PSD (dBm)	Limit Max (dBm)	Result
5320.000000	5312.871287	8.020	11.0	PASS

### Ports

Port	State
1	used
2	used
3	used
4	used

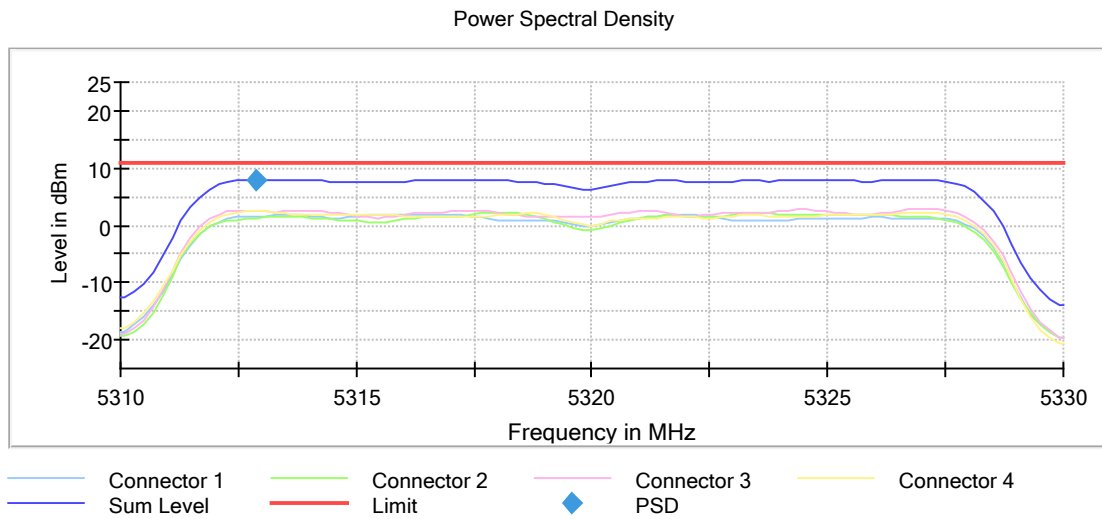

## Occupied Channel Bandwidth 99% (5320 MHz; 24.000 dBm; 20 MHz)

Customized settings.

### 99 % Bandwidth

DUT Frequency (MHz)	Bandwidth (MHz)	Limit Min (MHz)	Limit Max (MHz)	Band Edge Left (MHz)	Band Edge Right (MHz)
5320.000000	16.900000	---	---	5311.450000	5328.350000

(continuation of the "99 % Bandwidth" table from column 6 ...)

DUT Frequency (MHz)	Result
5320.000000	PASS

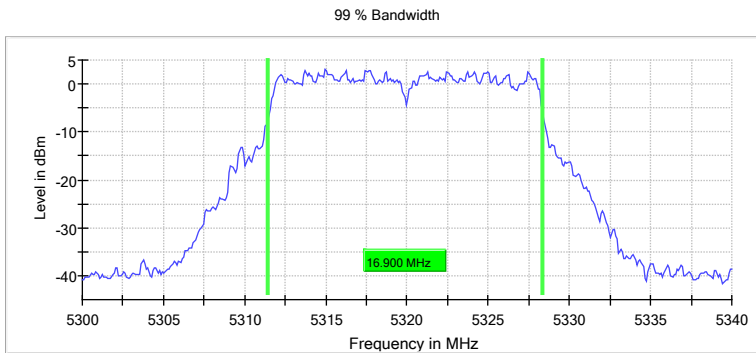

### Bandwidth



Date: 12.JAN.2024 02:16:23

## 2.1.2 ax Mode

### Summary

Test	Frequency (MHz)	Nominal Power (dBm)	Nominal Bandwidth (MHz)	Result
Emission Bandwidth 26 dB	5260.000	24.0	20.000000	PASS
RF output power	5260.000	24.0	20.000000	PASS
Power Spectral Density	5260.000	24.0	20.000000	PASS
Occupied Channel Bandwidth 99%	5260.000	24.0	20.000000	PASS
Emission Bandwidth 26 dB	5280.000	24.0	20.000000	PASS
Power Spectral Density	5280.000	24.0	20.000000	PASS
Occupied Channel Bandwidth 99%	5280.000	24.0	20.000000	PASS
Emission Bandwidth 26 dB	5320.000	24.0	20.000000	PASS
Power Spectral Density	5320.000	24.0	20.000000	PASS
Occupied Channel Bandwidth 99%	5320.000	24.0	20.000000	PASS
Emission Bandwidth 26 dB	5270.000	24.0	40.000000	PASS
Power Spectral Density	5270.000	24.0	40.000000	PASS
Occupied Channel Bandwidth 99%	5270.000	24.0	40.000000	PASS
Emission Bandwidth 26 dB	5310.000	24.0	40.000000	PASS
Power Spectral Density	5310.000	24.0	40.000000	PASS
Occupied Channel Bandwidth 99%	5310.000	24.0	40.000000	PASS
Emission Bandwidth 26 dB	5290.000	24.0	80.000000	PASS
Power Spectral Density	5290.000	24.0	80.000000	PASS
Occupied Channel Bandwidth 99%	5290.000	24.0	80.000000	PASS
Emission Bandwidth 26 dB	5250.000	24.0	160.000000	PASS
Power Spectral Density	5250.000	24.0	160.000000	PASS
Occupied Channel Bandwidth 99%	5250.000	24.0	160.000000	PASS

### Emission Bandwidth 26 dB (5260 MHz; 24.000 dBm; 20 MHz)

Customized settings.

### 26 dB Bandwidth

DUT Frequency (MHz)	Bandwidth (MHz)	Limit Min (MHz)	Limit Max (MHz)	Band Edge Left (MHz)	Band Edge Right (MHz)
5260.000000	22.400000	---	---	5248.850000	5271.250000

(continuation of the "26 dB Bandwidth" table from column 6 ...)

DUT Frequency (MHz)	Max Level (dBm)	Result
5260.000000	3.7	PASS

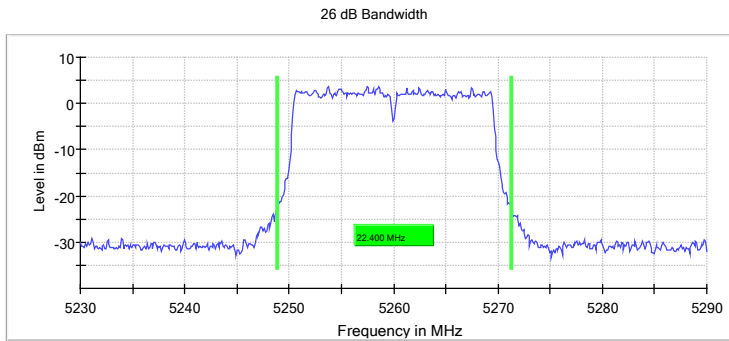

### Bandwidth



Date: 12-JAN-2024 02:22:24

### Measurement

Setting	Instrument Value	Target Value
Start Frequency	5.23000 GHz	5.23000 GHz
Stop Frequency	5.29000 GHz	5.29000 GHz
Span	60.000 MHz	60.000 MHz
RBW	200.000 kHz	~ 200.000 kHz
VBW	300.000 kHz	>= 240.000 kHz
SweepPoints	600	~ 600
SweepTime	37.969 $\mu$ s	AUTO
Reference Level	20.000 dBm	20.000 dBm
Attenuation	40.000 dB	AUTO
Detector	MaxPeak	MaxPeak
SweepCount	500	500
Filter	3 dB	3 dB
Trace Mode	Max Hold	Max Hold
SweepType	FFT	AUTO
Preamp	off	off



## RF output power (5260 MHz; 24.000 dBm; 20 MHz)

Customized settings.

### Result

DUT Frequency (MHz)	Gated RMS (dBm)	Limit Max (dBm)	Gated EIRP (dBm)	DutyCycle (%)	Result
5260.000000	23.6	24.0	23.6	99.708	PASS

### OSP PowerMeter settings

Setting	Instrument Value	Target Value
Measurement Time	1.000 s	1.000 s
Points	1000000	1000000
Time resolution	1.000 $\mu$ s	1.000 $\mu$ s

## Power Spectral Density (5260 MHz; 24.000 dBm; 20 MHz)

Customized settings.

### Result

DUT Frequency (MHz)	Frequency (MHz)	PSD (dBm)	Limit Max (dBm)	Result
5260.000000	5251.485149	7.889	11.0	PASS

### Ports

Port	State
1	used
2	used
3	used
4	used

Power Spectral Density

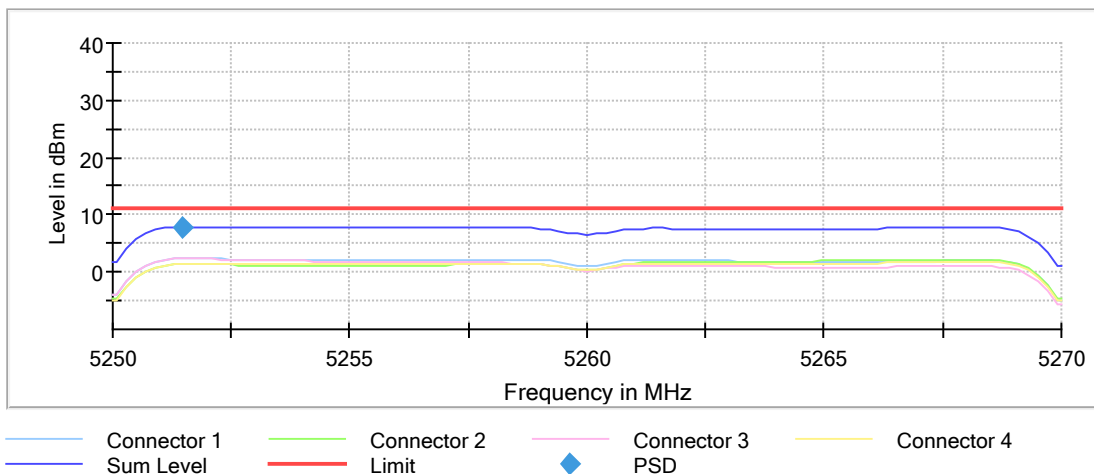

**Measurement**

Setting	Instrument Value	Target Value
Start Frequency	5.25000 GHz	5.25000 GHz
Stop Frequency	5.27000 GHz	5.27000 GHz
Span	20.000 MHz	20.000 MHz
RBW	1.000 MHz	<= 1.000 MHz
VBW	3.000 MHz	>= 3.000 MHz
SweepPoints	101	~ 40
Sweeptime	2.020 ms	2.020 ms
Reference Level	20.000 dBm	20.000 dBm
Attenuation	40.000 dB	AUTO
Detector	RMS	RMS
SweepCount	100	100
Filter	3 dB	3 dB
Trace Mode	Average Power	Average Power
SweepType	FFT	AUTO
Preamp	off	off

**Occupied Channel Bandwidth 99% (5260 MHz; 24.000 dBm; 20 MHz)**

Customized settings.

**99 % Bandwidth**

DUT Frequency (MHz)	Bandwidth (MHz)	Limit Min (MHz)	Limit Max (MHz)	Band Edge Left (MHz)	Band Edge Right (MHz)
5260.000000	19.100000	---	---	5250.450000	5269.550000

(continuation of the "99 % Bandwidth" table from column 6 ...)

DUT Frequency (MHz)	Result
5260.000000	PASS

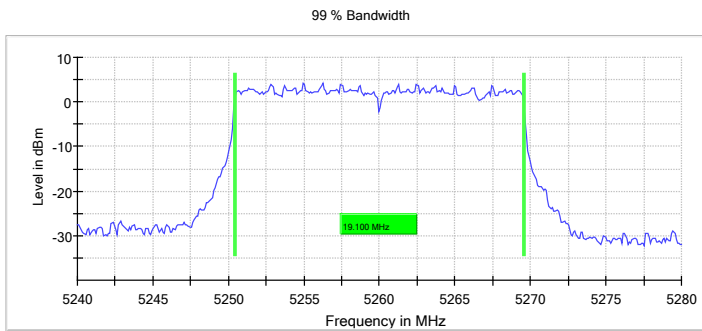

**Bandwidth**

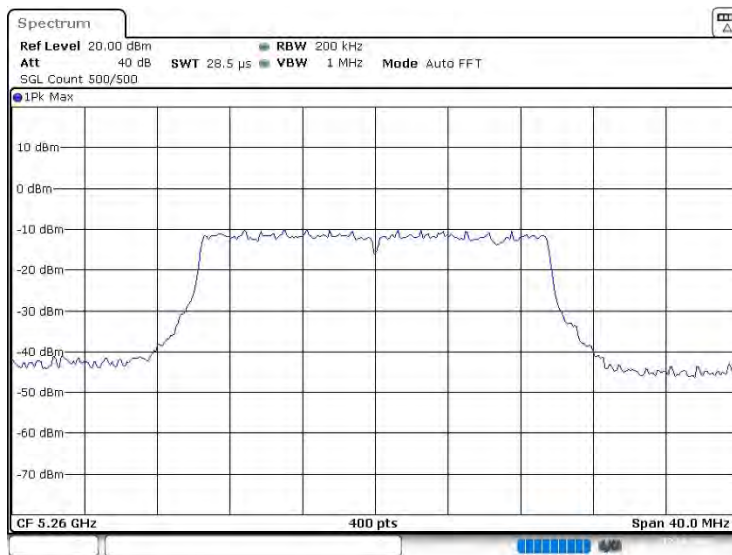

Date: 12 JUN 2024 02:23:58

**Measurement**

Setting	Instrument Value	Target Value
Start Frequency	5.24000 GHz	5.24000 GHz
Stop Frequency	5.28000 GHz	5.28000 GHz
Span	40.000 MHz	40.000 MHz
RBW	200.000 kHz	>= 200.000 kHz
VBW	1.000 MHz	>= 600.000 kHz
SweepPoints	400	~ 400
SweepTime	28.477 $\mu$ s	AUTO
Reference Level	20.000 dBm	20.000 dBm
Attenuation	40.000 dB	AUTO
Detector	MaxPeak	MaxPeak
SweepCount	500	500
Filter	3 dB	3 dB
Trace Mode	Max Hold	Max Hold
SweepType	FFT	AUTO
Preamp	off	off

## Emission Bandwidth 26 dB (5280 MHz; 24.000 dBm; 20 MHz)

Customized settings.

### 26 dB Bandwidth

DUT Frequency (MHz)	Bandwidth (MHz)	Limit Min (MHz)	Limit Max (MHz)	Band Edge Left (MHz)	Band Edge Right (MHz)
5280.000000	22.500000	---	---	5268.650000	5291.150000

(continuation of the "26 dB Bandwidth" table from column 6 ...)

DUT Frequency (MHz)	Max Level (dBm)	Result
5280.000000	3.2	PASS

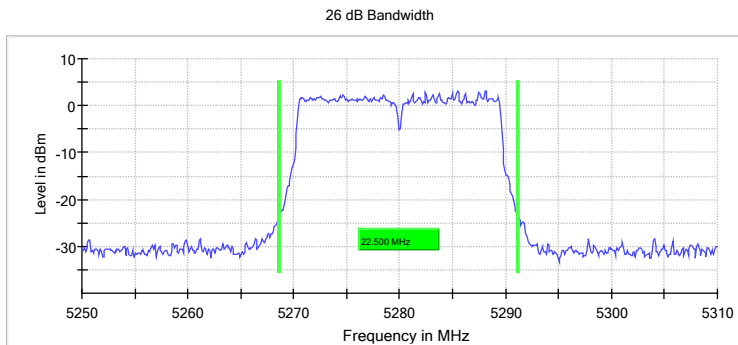

### Bandwidth



Date: 13 JAN 2024 02:24:15

## Power Spectral Density (5280 MHz; 24.000 dBm; 20 MHz)

Customized settings.

### Result

DUT Frequency (MHz)	Frequency (MHz)	PSD (dBm)	Limit Max (dBm)	Result
5280.000000	5271.485149	7.409	11.0	PASS

### Ports

Port	State
1	used
2	used
3	used
4	used

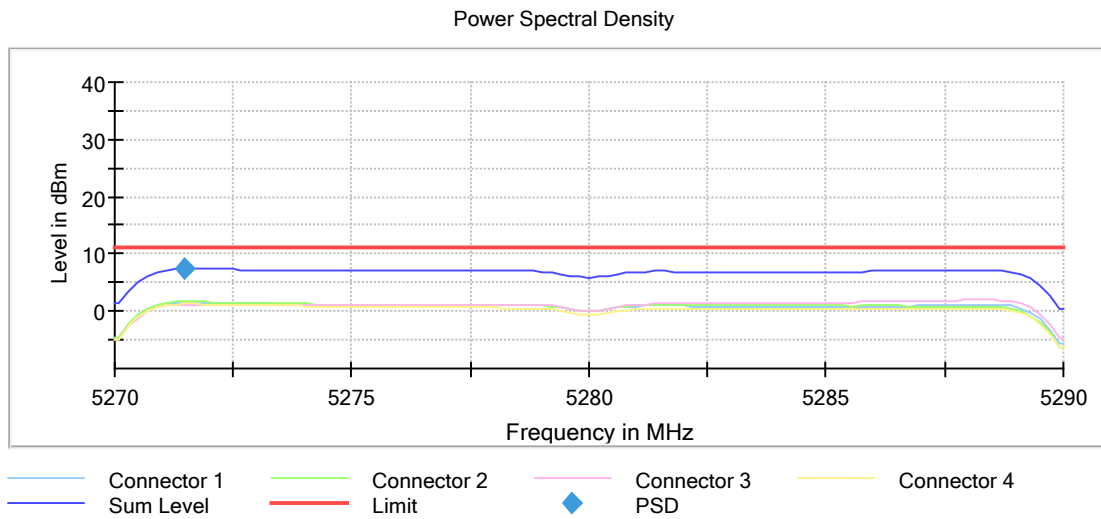

## Occupied Channel Bandwidth 99% (5280 MHz; 24.000 dBm; 20 MHz)

Customized settings.

### 99 % Bandwidth

DUT Frequency (MHz)	Bandwidth (MHz)	Limit Min (MHz)	Limit Max (MHz)	Band Edge Left (MHz)	Band Edge Right (MHz)
5280.000000	19.200000	---	---	5270.350000	5289.550000

(continuation of the "99 % Bandwidth" table from column 6 ...)

DUT Frequency (MHz)	Result
5280.000000	PASS

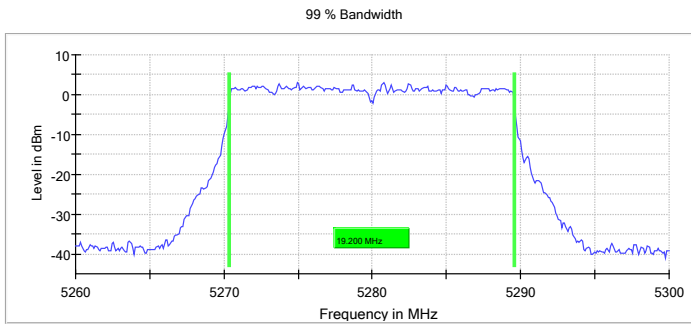

### Bandwidth



Date: 12.30N.2024 02:12:46

## Emission Bandwidth 26 dB (5320 MHz; 24.000 dBm; 20 MHz)

Customized settings.

### 26 dB Bandwidth

DUT Frequency (MHz)	Bandwidth (MHz)	Limit Min (MHz)	Limit Max (MHz)	Band Edge Left (MHz)	Band Edge Right (MHz)
5320.000000	23.000000	---	---	5308.450000	5331.450000

(continuation of the "26 dB Bandwidth" table from column 6 ...)

DUT Frequency (MHz)	Max Level (dBm)	Result
5320.000000	3.1	PASS

26 dB Bandwidth

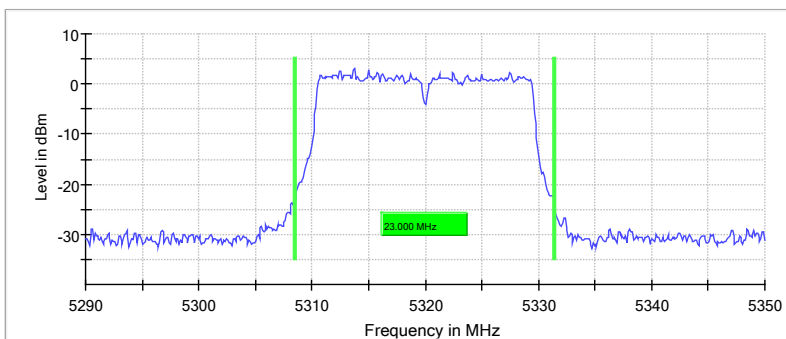

### Bandwidth



Date: 12.JAN.2024 02:26:17

## Power Spectral Density (5320 MHz; 24.000 dBm; 20 MHz)

Customized settings.

### Result

DUT Frequency (MHz)	Frequency (MHz)	PSD (dBm)	Limit Max (dBm)	Result
5320.000000	5328.316832	7.393	11.0	PASS

### Ports

Port	State
1	used
2	used
3	used
4	used

Power Spectral Density

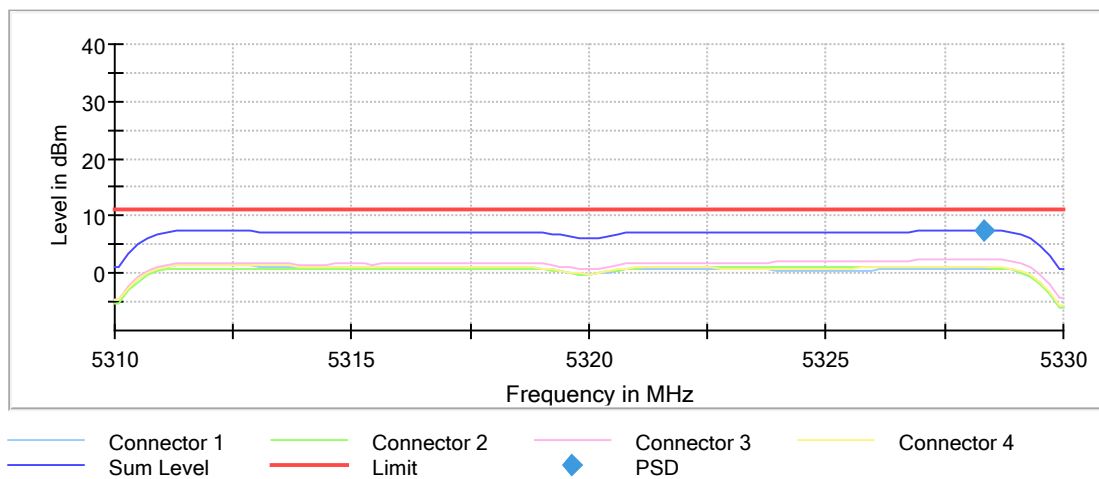



## Occupied Channel Bandwidth 99% (5320 MHz; 24.000 dBm; 20 MHz)

Customized settings.

### 99 % Bandwidth

DUT Frequency (MHz)	Bandwidth (MHz)	Limit Min (MHz)	Limit Max (MHz)	Band Edge Left (MHz)	Band Edge Right (MHz)
5320.000000	19.200000	---	---	5310.350000	5329.550000

(continuation of the "99 % Bandwidth" table from column 6 ...)

DUT Frequency (MHz)	Result
5320.000000	PASS

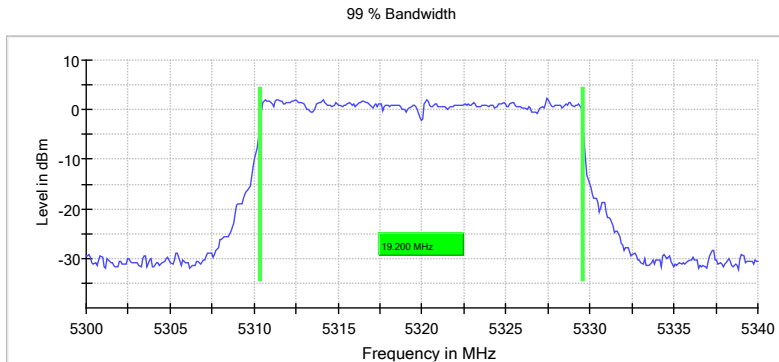

### Bandwidth

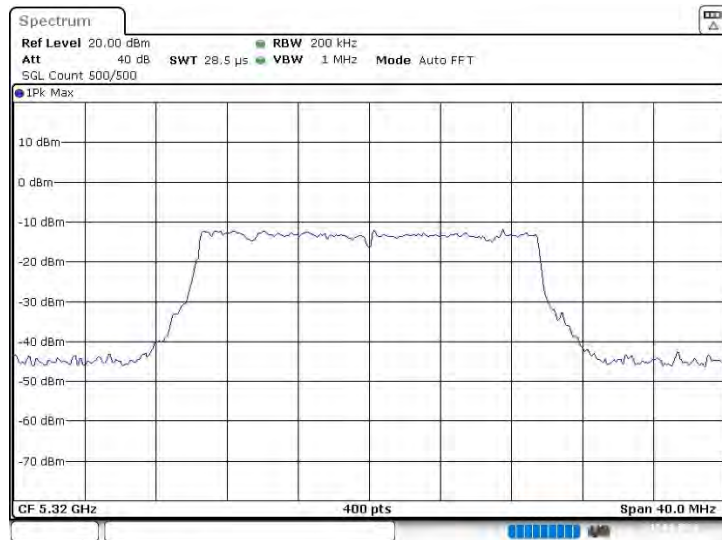

Date: 13.JAN.2024 02:27:50

## Emission Bandwidth 26 dB (5270 MHz; 24.000 dBm; 40 MHz)

Customized settings.

### 26 dB Bandwidth

DUT Frequency (MHz)	Bandwidth (MHz)	Limit Min (MHz)	Limit Max (MHz)	Band Edge Left (MHz)	Band Edge Right (MHz)
5270.000000	43.500000	---	---	5247.875000	5291.375000

(continuation of the "26 dB Bandwidth" table from column 6 ...)

DUT Frequency (MHz)	Max Level (dBm)	Result
5270.000000	4.2	PASS

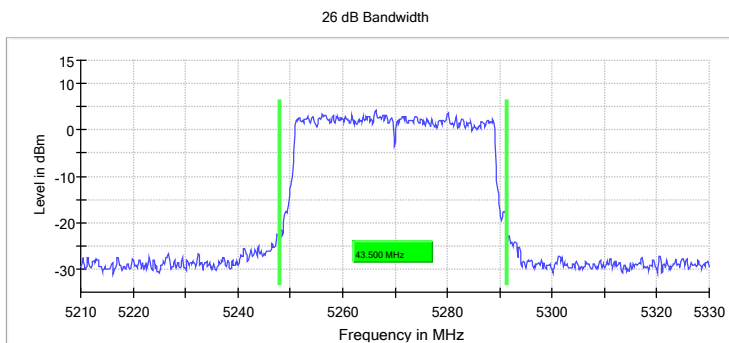

### Bandwidth

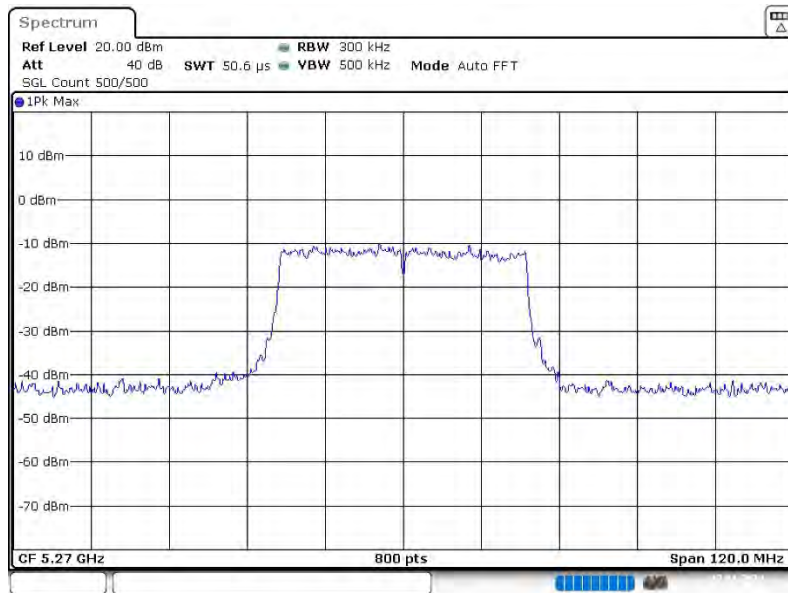

Date: 12.JAN.2024 09:28:11

## Power Spectral Density (5270 MHz; 24.000 dBm; 40 MHz)

Customized settings.

### Result

DUT Frequency (MHz)	Frequency (MHz)	PSD (dBm)	Limit Max (dBm)	Result
5270.000000	5252.178218	4.806	11.0	PASS

### Ports

Port	State
1	used
2	used
3	used
4	used

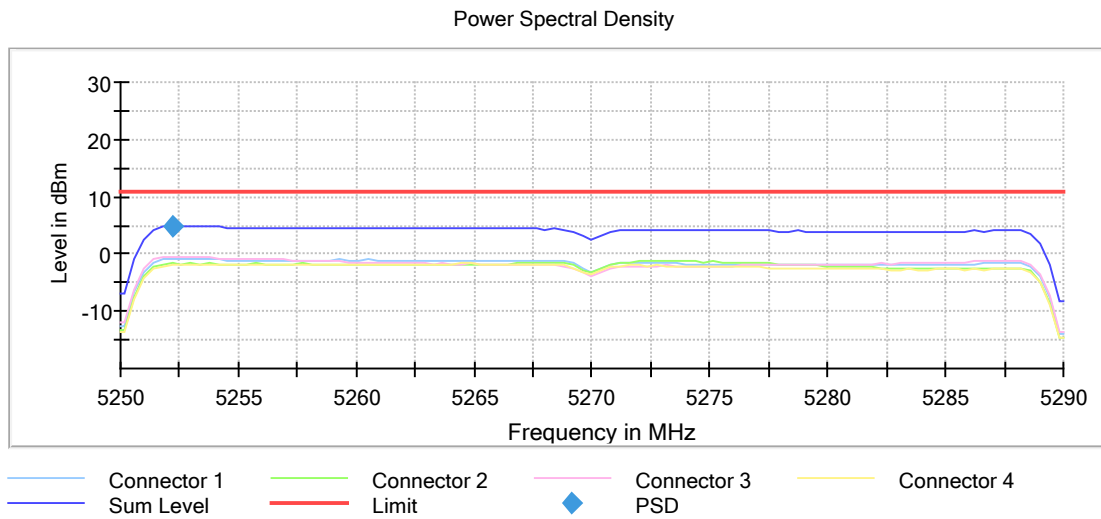

## Occupied Channel Bandwidth 99% (5270 MHz; 24.000 dBm; 40 MHz)

Customized settings.

### 99 % Bandwidth

DUT Frequency (MHz)	Bandwidth (MHz)	Limit Min (MHz)	Limit Max (MHz)	Band Edge Left (MHz)	Band Edge Right (MHz)
5270.000000	38.250000	---	---	5250.875000	5289.125000

(continuation of the "99 % Bandwidth" table from column 6 ...)

DUT Frequency (MHz)	Result
5270.000000	PASS

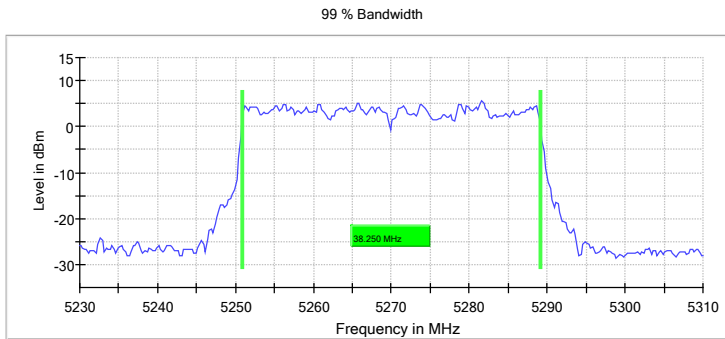

### Bandwidth

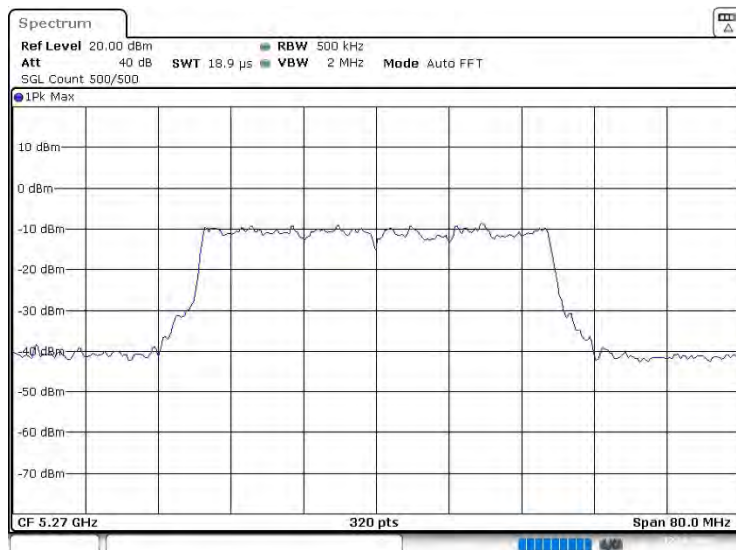

Date: 12-09-2024 02:30:51

## Emission Bandwidth 26 dB (5310 MHz; 24.000 dBm; 40 MHz)

Customized settings.

### 26 dB Bandwidth

DUT Frequency (MHz)	Bandwidth (MHz)	Limit Min (MHz)	Limit Max (MHz)	Band Edge Left (MHz)	Band Edge Right (MHz)
5310.000000	43.500000	---	---	5288.325000	5331.825000

(continuation of the "26 dB Bandwidth" table from column 6 ...)

DUT Frequency (MHz)	Max Level (dBm)	Result
5310.000000	2.3	PASS

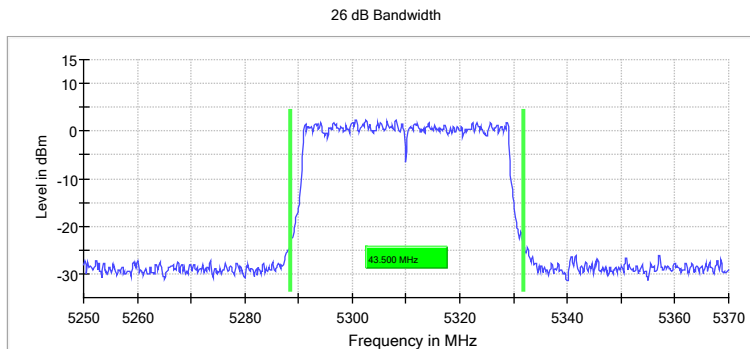

### Bandwidth

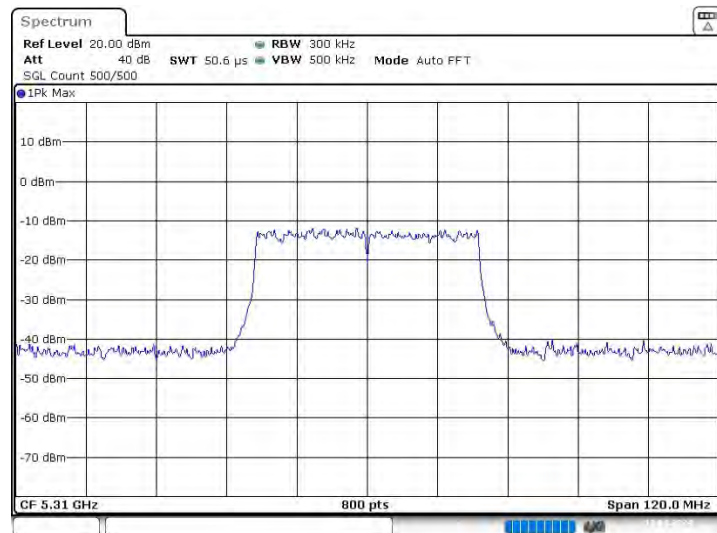

Date: 12.JAN.2024 02:31:11

## Power Spectral Density (5310 MHz; 24.000 dBm; 40 MHz)

Customized settings.

### Result

DUT Frequency (MHz)	Frequency (MHz)	PSD (dBm)	Limit Max (dBm)	Result
5310.000000	5311.584158	4.285	11.0	PASS

### Ports

Port	State
1	used
2	used
3	used
4	used

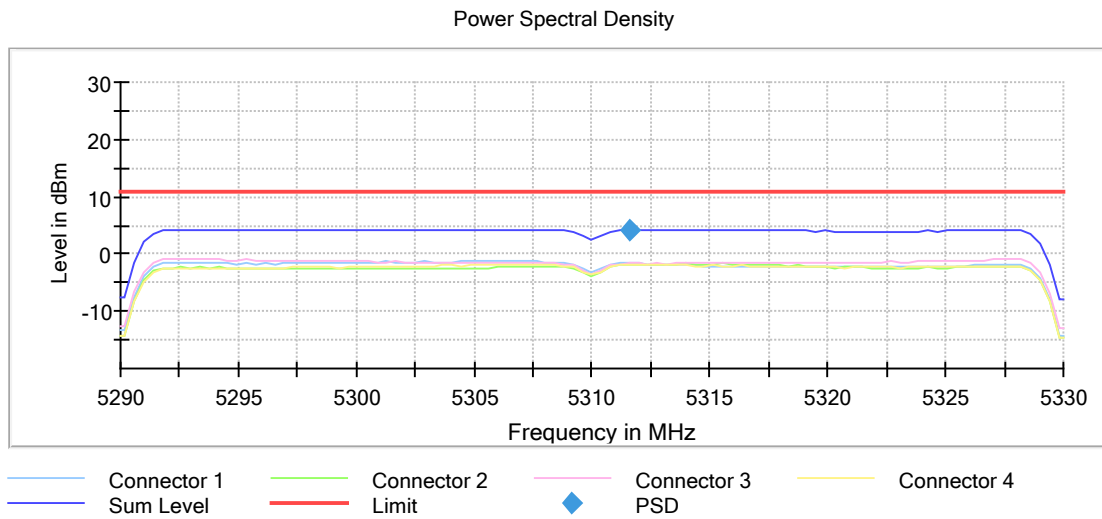

## Occupied Channel Bandwidth 99% (5310 MHz; 24.000 dBm; 40 MHz)

Customized settings.

### 99 % Bandwidth

DUT Frequency (MHz)	Bandwidth (MHz)	Limit Min (MHz)	Limit Max (MHz)	Band Edge Left (MHz)	Band Edge Right (MHz)
5310.000000	38.250000	---	---	5290.875000	5329.125000

(continuation of the "99 % Bandwidth" table from column 6 ...)

DUT Frequency (MHz)	Result
5310.000000	PASS

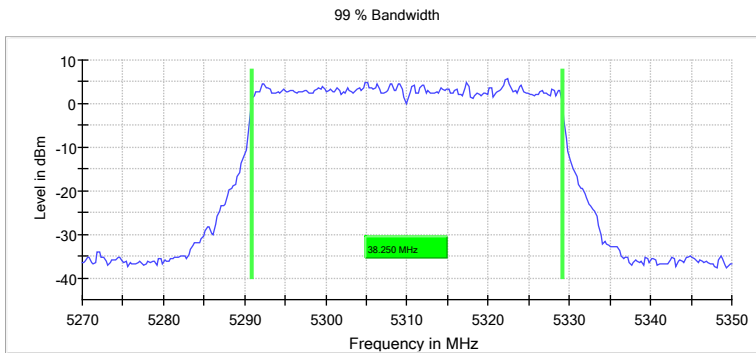

### Bandwidth

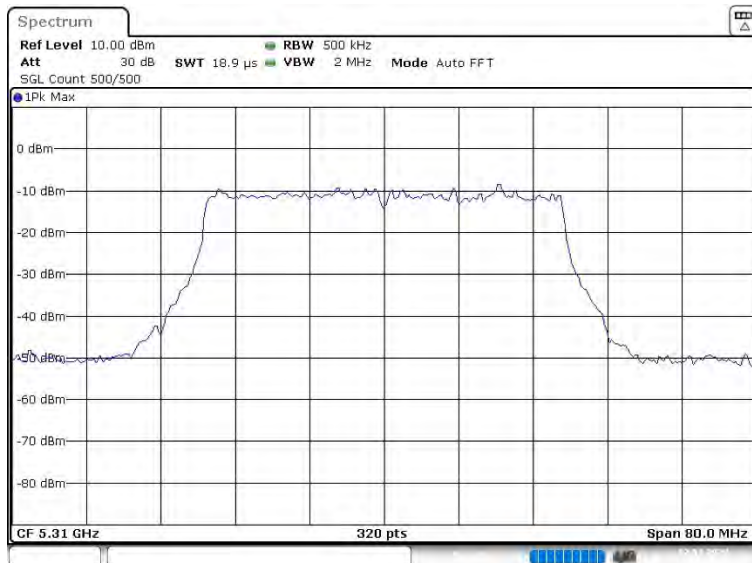

Date: 12 JAN 2024 02:32:63

## Emission Bandwidth 26 dB (5290 MHz; 24.000 dBm; 80 MHz)

Customized settings.

### 26 dB Bandwidth

DUT Frequency (MHz)	Bandwidth (MHz)	Limit Min (MHz)	Limit Max (MHz)	Band Edge Left (MHz)	Band Edge Right (MHz)
5290.000000	95.500000	---	---	5240.750000	5336.250000

(continuation of the "26 dB Bandwidth" table from column 6 ...)

DUT Frequency (MHz)	Max Level (dBm)	Result
5290.000000	4.9	PASS

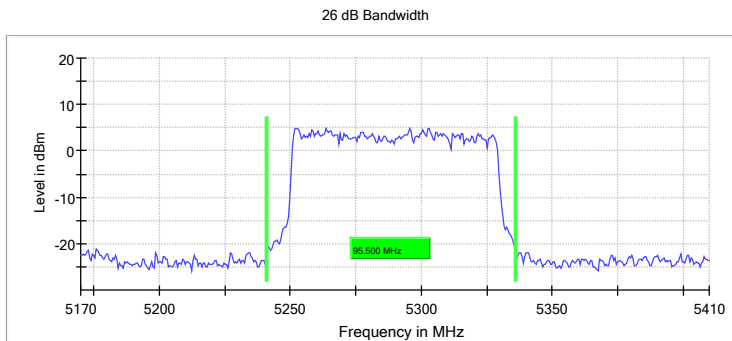

### Bandwidth

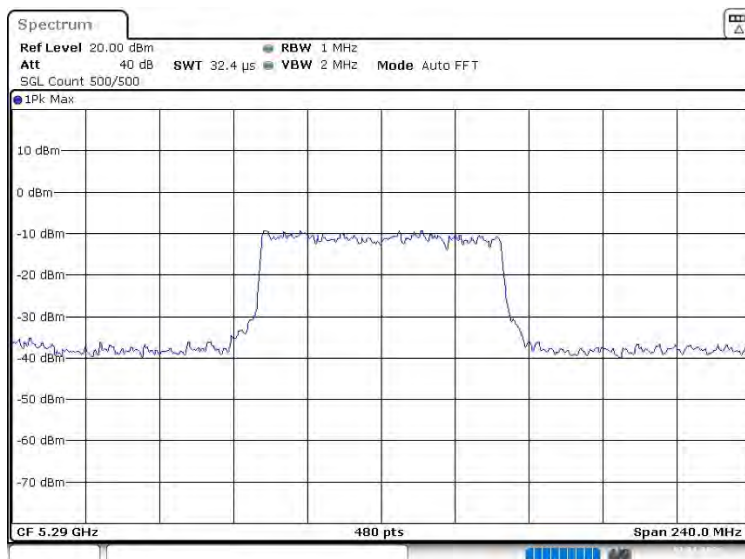

Date: 12, JAN, 2024 02:30:44



## Power Spectral Density (5290 MHz; 24.000 dBm; 80 MHz)

Customized settings.

### Result

DUT Frequency (MHz)	Frequency (MHz)	PSD (dBm)	Limit Max (dBm)	Result
5290.000000	5252.250000	1.437	11.0	PASS

### Ports

Port	State
1	used
2	used
3	used
4	used

Power Spectral Density

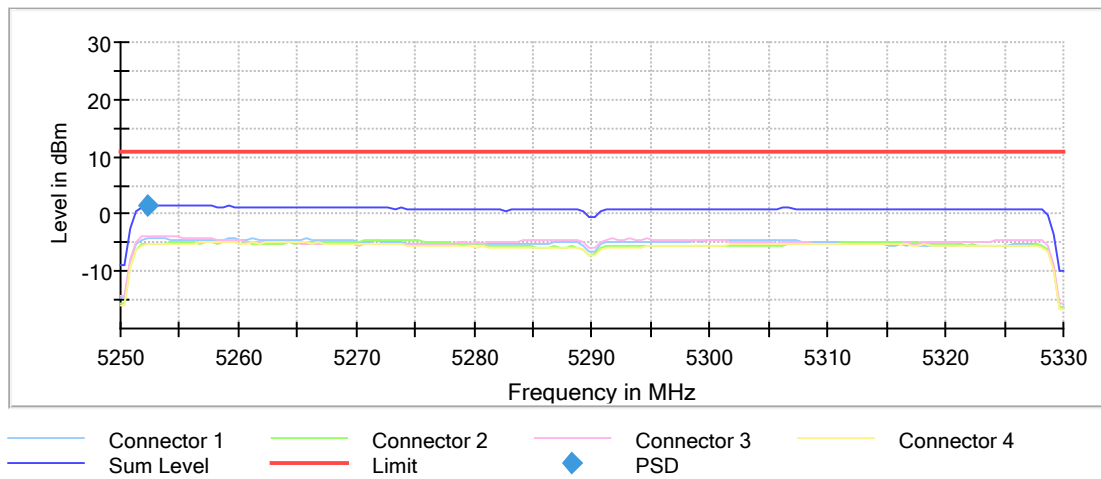

## Occupied Channel Bandwidth 99% (5290 MHz; 24.000 dBm; 80 MHz)

Customized settings.

### 99 % Bandwidth

DUT Frequency (MHz)	Bandwidth (MHz)	Limit Min (MHz)	Limit Max (MHz)	Band Edge Left (MHz)	Band Edge Right (MHz)
5290.000000	78.000000	---	---	5250.750000	5328.750000

(continuation of the "99 % Bandwidth" table from column 6 ...)

DUT Frequency (MHz)	Result
5290.000000	PASS

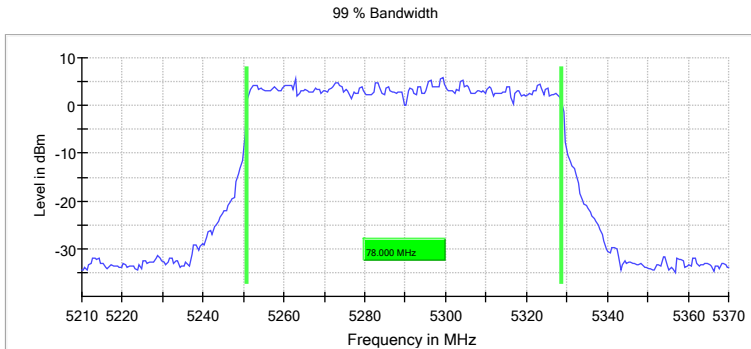

### Bandwidth

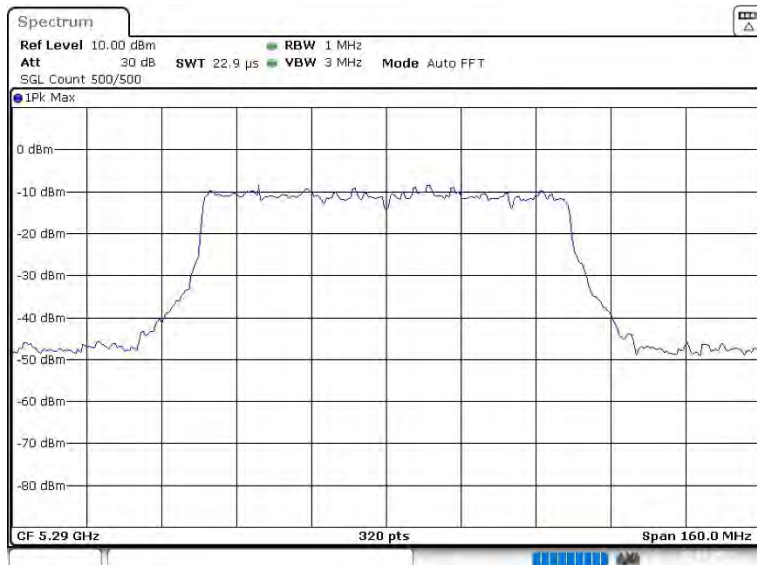

Date: 12 JAN 2024 02:37:44

## Emission Bandwidth 26 dB (5250 MHz; 24.000 dBm; 160 MHz)

Customized settings.

### 26 dB Bandwidth

DUT Frequency (MHz)	Bandwidth (MHz)	Limit Min (MHz)	Limit Max (MHz)	Band Edge Left (MHz)	Band Edge Right (MHz)
5250.000000	449.000000	---	---	5033.500000	5482.500000

(continuation of the "26 dB Bandwidth" table from column 6 ...)

DUT Frequency (MHz)	Max Level (dBm)	Result
5250.000000	6.8	PASS

26 dB Bandwidth

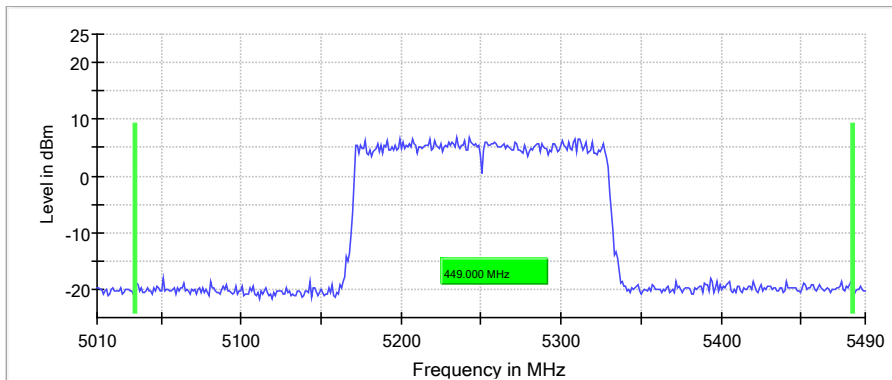

### Bandwidth

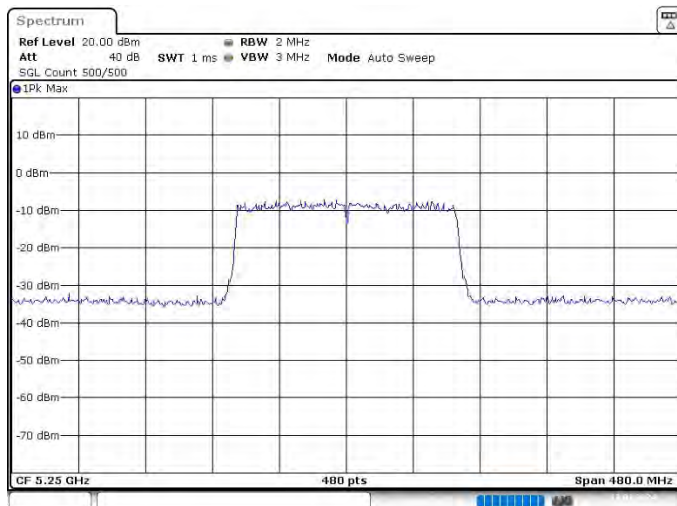

Date: 12.07.2024 02:09:01

## Power Spectral Density (5250 MHz; 24.000 dBm; 160 MHz)

Customized settings.

### Result

DUT Frequency (MHz)	Frequency (MHz)	PSD (dBm)	Limit Max (dBm)	Result
5250.000000	5216.250000	-0.632	11.0	PASS

### Ports

Port	State
1	used
2	used
3	used
4	used

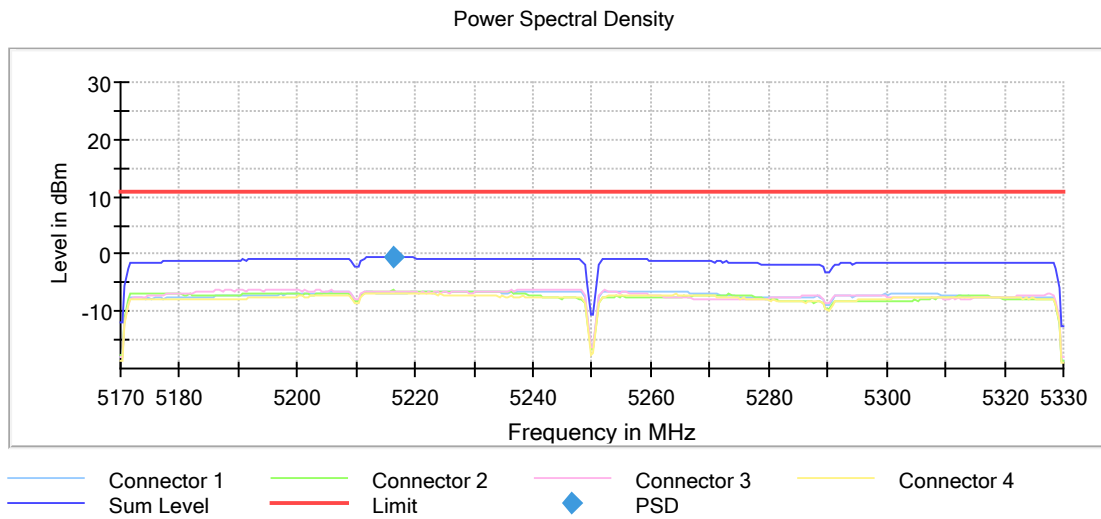

## Occupied Channel Bandwidth 99% (5250 MHz; 24.000 dBm; 160 MHz)

Customized settings.

### 99 % Bandwidth

DUT Frequency (MHz)	Bandwidth (MHz)	Limit Min (MHz)	Limit Max (MHz)	Band Edge Left (MHz)	Band Edge Right (MHz)
5250.000000	158.000000	---	---	5170.500000	5328.500000

(continuation of the "99 % Bandwidth" table from column 6 ...)

DUT Frequency (MHz)	Result
5250.000000	PASS

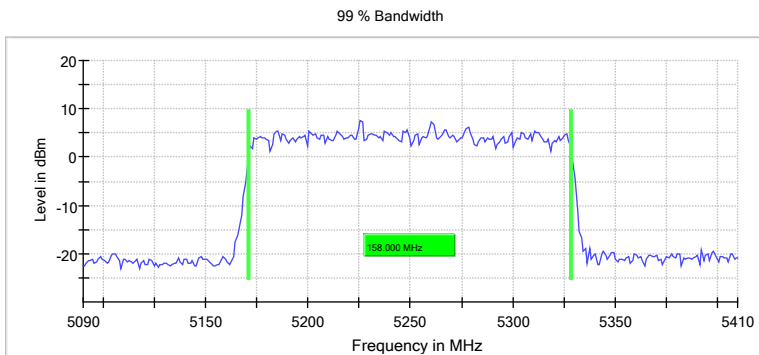

### Bandwidth

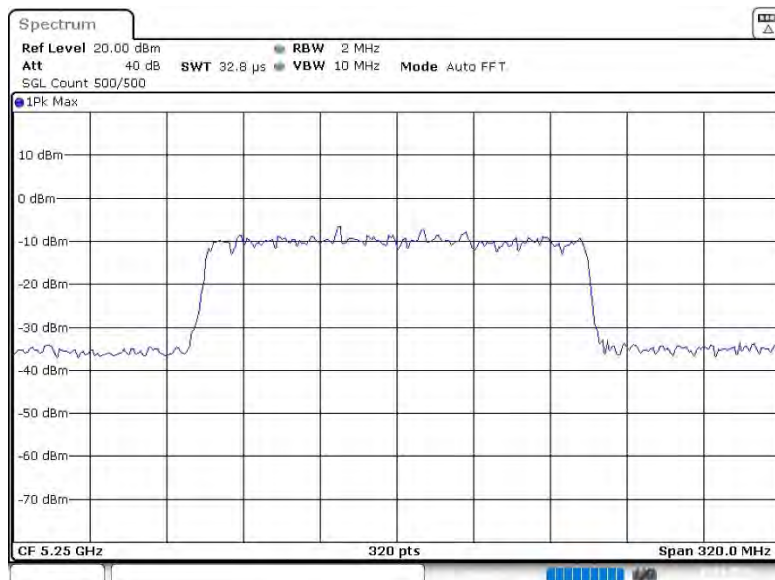

Date: 12.JAN.2024 02:40:02

## 2.2 2C

### 2.2.1 a Mode

### Summary

Test	Frequency (MHz)	Nominal Power (dBm)	Nominal Bandwidth (MHz)	Result
Emission Bandwidth 26 dB	5500.000	24.0	20.000000	PASS
RF output power	5500.000	24.0	20.000000	PASS
Power Spectral Density	5500.000	24.0	20.000000	PASS
Occupied Channel Bandwidth 99%	5500.000	24.0	20.000000	PASS
Emission Bandwidth 26 dB	5600.000	24.0	20.000000	PASS
Power Spectral Density	5600.000	24.0	20.000000	PASS
Occupied Channel Bandwidth 99%	5600.000	24.0	20.000000	PASS
Emission Bandwidth 26 dB	5720.000	24.0	20.000000	PASS
Power Spectral Density	5720.000	24.0	20.000000	PASS
Occupied Channel Bandwidth 99%	5720.000	24.0	20.000000	PASS

### Emission Bandwidth 26 dB (5500 MHz; 24.000 dBm; 20 MHz)

Customized settings.

### 26 dB Bandwidth

DUT Frequency (MHz)	Bandwidth (MHz)	Limit Min (MHz)	Limit Max (MHz)	Band Edge Left (MHz)	Band Edge Right (MHz)
5500.000000	22.500000	---	---	5488.850000	5511.350000

(continuation of the "26 dB Bandwidth" table from column 6 ...)

DUT Frequency (MHz)	Max Level (dBm)	Result
5500.000000	3.1	PASS

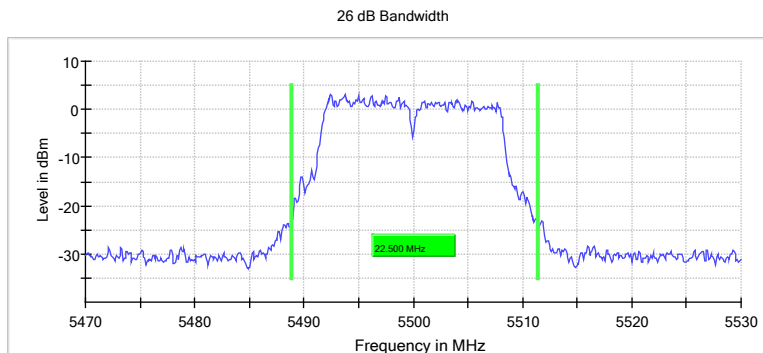

Bandwidth

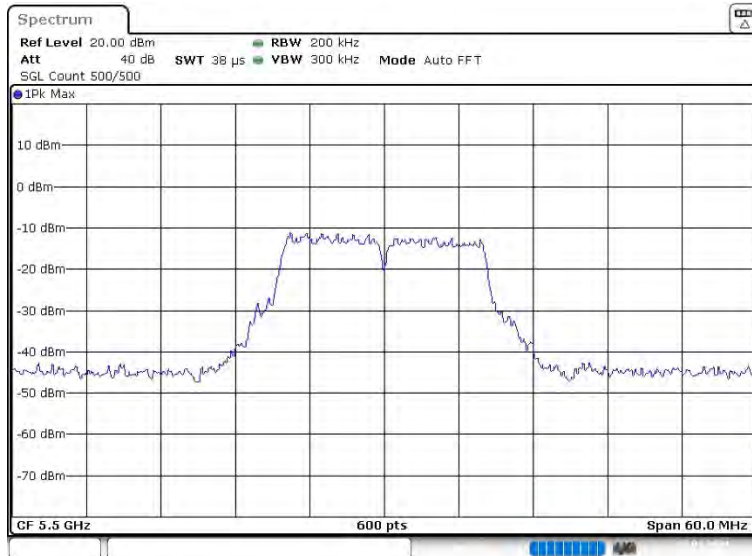

Date: 22 JAN 2024 02:47:51

## Measurement

Setting	Instrument Value	Target Value
Start Frequency	5.47000 GHz	5.47000 GHz
Stop Frequency	5.53000 GHz	5.53000 GHz
Span	60.000 MHz	60.000 MHz
RBW	200.000 kHz	~ 200.000 kHz
VBW	300.000 kHz	>= 240.000 kHz
SweepPoints	600	~ 600
SweepTime	37.969 $\mu$ s	AUTO
Reference Level	20.000 dBm	20.000 dBm
Attenuation	40.000 dB	AUTO
Detector	MaxPeak	MaxPeak
SweepCount	500	500
Filter	3 dB	3 dB
Trace Mode	Max Hold	Max Hold
SweepType	FFT	AUTO
Preamp	off	off

## RF output power (5500 MHz; 24.000 dBm; 20 MHz)

Customized settings.

## Result

DUT Frequency (MHz)	Gated RMS (dBm)	Limit Max (dBm)	Gated EIRP (dBm)	DutyCycle (%)	Result
5500.000000	23.1	24.0	23.1	99.235	PASS

## OSP PowerMeter settings

Setting	Instrument Value	Target Value
Measurement Time	1.000 s	1.000 s
Points	1000000	1000000
Time resolution	1.000 $\mu$ s	1.000 $\mu$ s

## Power Spectral Density (5500 MHz; 24.000 dBm; 20 MHz)

Customized settings.

## Result

DUT Frequency (MHz)	Frequency (MHz)	PSD (dBm)	Limit Max (dBm)	Result
5500.000000	5492.871287	7.798	11.0	PASS

## Ports

Port	State
1	used
2	used
3	used
4	used

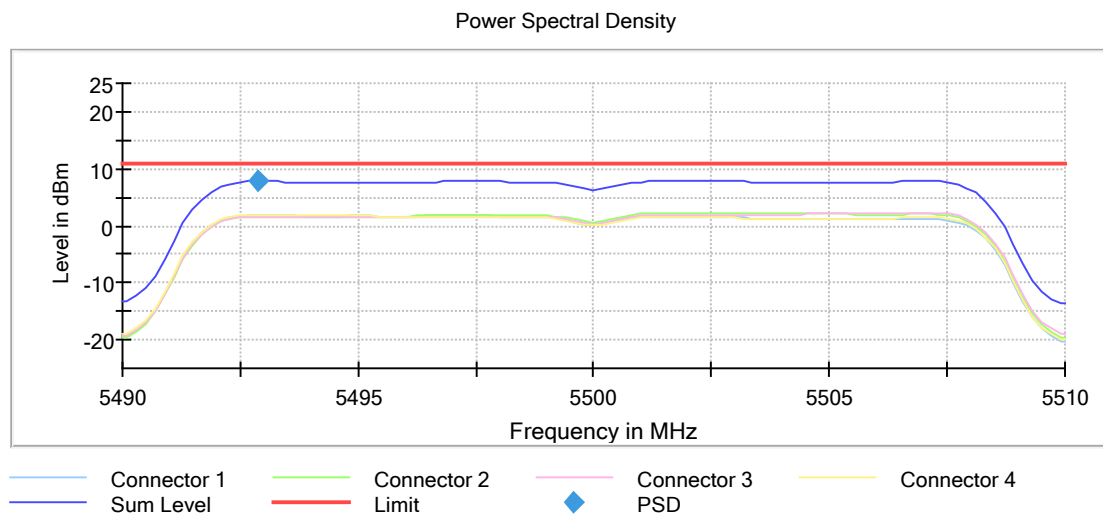



## Measurement

Setting	Instrument Value	Target Value
Start Frequency	5.49000 GHz	5.49000 GHz
Stop Frequency	5.51000 GHz	5.51000 GHz
Span	20.000 MHz	20.000 MHz
RBW	1.000 MHz	<= 1.000 MHz
VBW	3.000 MHz	>= 3.000 MHz
SweepPoints	101	~ 40
SweepTime	2.020 ms	2.020 ms
Reference Level	10.000 dBm	10.000 dBm
Attenuation	30.000 dB	AUTO
Detector	RMS	RMS
SweepCount	100	100
Filter	3 dB	3 dB
Trace Mode	Average Power	Average Power
SweepType	FFT	AUTO
Preamp	off	off

## Occupied Channel Bandwidth 99% (5500 MHz; 24.000 dBm; 20 MHz)

Customized settings.

### 99 % Bandwidth

DUT Frequency (MHz)	Bandwidth (MHz)	Limit Min (MHz)	Limit Max (MHz)	Band Edge Left (MHz)	Band Edge Right (MHz)
5500.000000	16.900000	---	---	5491.450000	5508.350000

(continuation of the "99 % Bandwidth" table from column 6 ...)

DUT Frequency (MHz)	Result
5500.000000	PASS

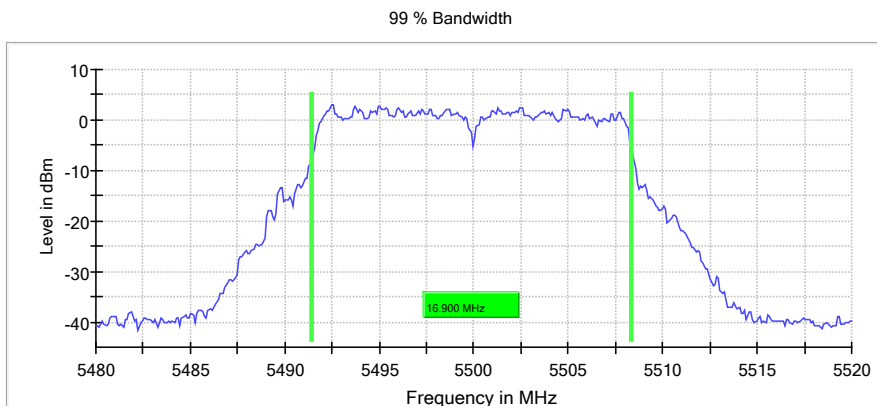

Bandwidth



Date: 12 JAN 2024 02:49:25

## Measurement

Setting	Instrument Value	Target Value
Start Frequency	5.48000 GHz	5.48000 GHz
Stop Frequency	5.52000 GHz	5.52000 GHz
Span	40.000 MHz	40.000 MHz
RBW	200.000 kHz	$\geq$ 200.000 kHz
VBW	1.000 MHz	$\geq$ 600.000 kHz
SweepPoints	400	$\sim$ 400
Sweptime	28.477 $\mu$ s	AUTO
Reference Level	10.000 dBm	10.000 dBm
Attenuation	30.000 dB	AUTO
Detector	MaxPeak	MaxPeak
SweepCount	500	500
Filter	3 dB	3 dB
Trace Mode	Max Hold	Max Hold
SweepType	FFT	AUTO
Preamp	off	off

## Emission Bandwidth 26 dB (5600 MHz; 24.000 dBm; 20 MHz)

Customized settings.

### 26 dB Bandwidth

DUT Frequency (MHz)	Bandwidth (MHz)	Limit Min (MHz)	Limit Max (MHz)	Band Edge Left (MHz)	Band Edge Right (MHz)
5600.000000	22.500000	---	---	5588.750000	5611.250000

(continuation of the "26 dB Bandwidth" table from column 6 ...)

DUT Frequency (MHz)	Max Level (dBm)	Result
5600.000000	3.0	PASS

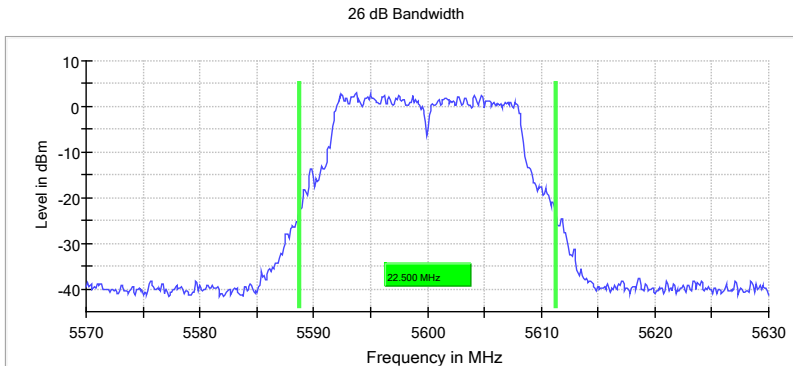

### Bandwidth



Date: 12, JAN, 2024 02:51:18

## Power Spectral Density (5600 MHz; 24.000 dBm; 20 MHz)

Customized settings.

### Result

DUT Frequency (MHz)	Frequency (MHz)	PSD (dBm)	Limit Max (dBm)	Result
5600.000000	5602.970297	8.267	11.0	PASS

### Ports

Port	State
1	used
2	used
3	used
4	used

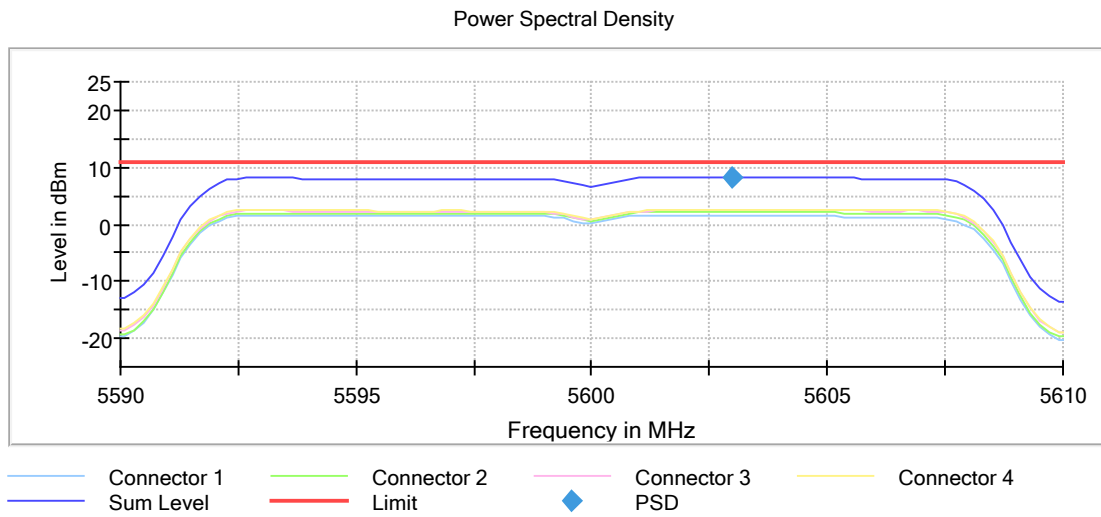

## Occupied Channel Bandwidth 99% (5600 MHz; 24.000 dBm; 20 MHz)

Customized settings.

### 99 % Bandwidth

DUT Frequency (MHz)	Bandwidth (MHz)	Limit Min (MHz)	Limit Max (MHz)	Band Edge Left (MHz)	Band Edge Right (MHz)
5600.000000	16.800000	---	---	5591.550000	5608.350000

(continuation of the "99 % Bandwidth" table from column 6 ...)

DUT Frequency (MHz)	Result
5600.000000	PASS

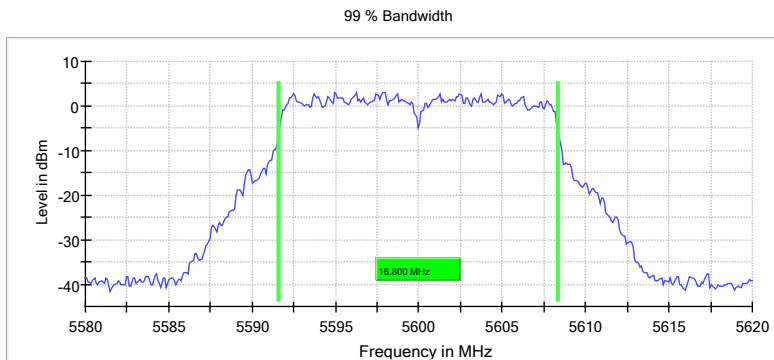

### Bandwidth



Date: 12 JAN 2024 02:52:19

## Emission Bandwidth 26 dB (5720 MHz; 24.000 dBm; 20 MHz)

Customized settings.

### 26 dB Bandwidth

DUT Frequency (MHz)	Bandwidth (MHz)	Bandwidth U-NII 2C (MHz)	Bandwidth U-NII 3 (MHz)	Limit Min (MHz)	Limit Max (MHz)
5720.000000	22.000000	15.750000	6.250000	---	---

(continuation of the "26 dB Bandwidth" table from column 6 ...)

DUT Frequency (MHz)	Band Edge Left (MHz)	Band Edge Right (MHz)	Max Level (dBm)	Result
5720.000000	5709.250000	5731.250000	3.0	PASS

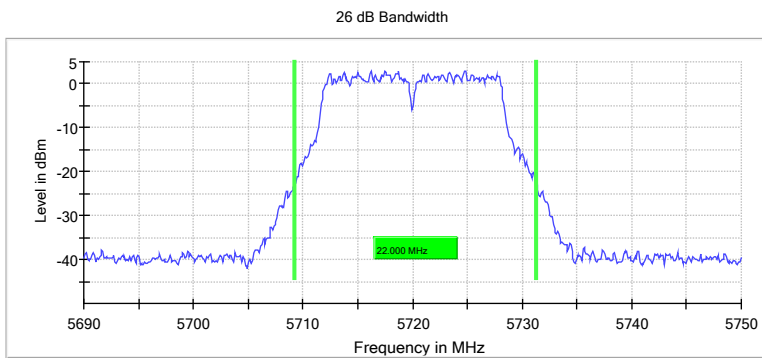

### Bandwidth



Date: 22.JAN.2024 02:53:05

## Power Spectral Density (5720 MHz; 24.000 dBm; 20 MHz)

Customized settings.

### Result

DUT Frequency (MHz)	Frequency (MHz)	PSD (dBm)	Limit Max (dBm)	Result
5720.000000	5727.128713	8.091	11.0	PASS

### Ports

Port	State
1	used
2	used
3	used
4	used

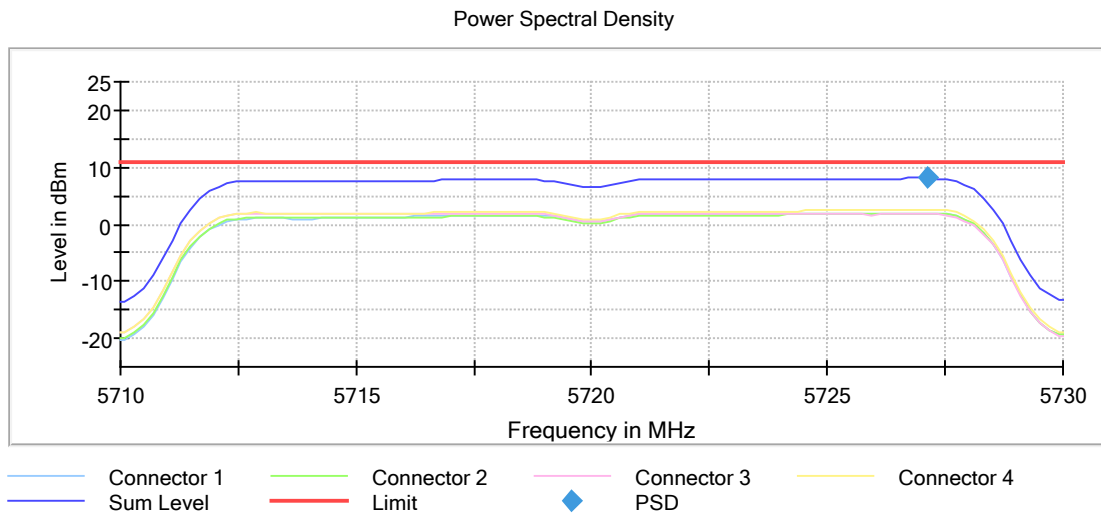

## Occupied Channel Bandwidth 99% (5720 MHz; 24.000 dBm; 20 MHz)

Customized settings.

### 99 % Bandwidth

DUT Frequency (MHz)	Bandwidth (MHz)	Bandwidth U-NII 2C (MHz)	Bandwidth U-NII 3 (MHz)	Limit Min (MHz)	Limit Max (MHz)
5720.000000	16.900000	13.450000	3.450000	---	---

(continuation of the "99 % Bandwidth" table from column 6 ...)

DUT Frequency (MHz)	Band Edge Left (MHz)	Band Edge Right (MHz)	Result
5720.000000	5711.550000	5728.450000	PASS

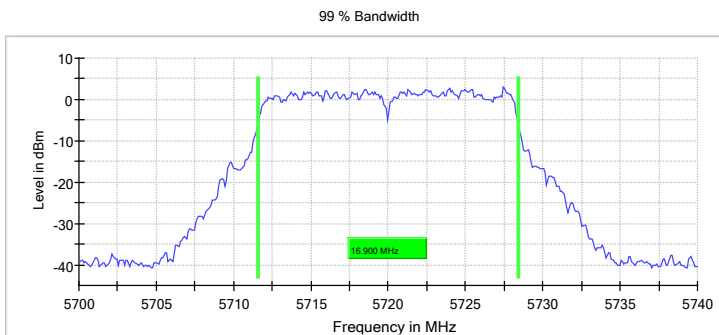

### Bandwidth





## 2.2.2 ax Mode

### Summary

Test	Frequency (MHz)	Nominal Power (dBm)	Nominal Bandwidth (MHz)	Result
Emission Bandwidth 26 dB	5500.000	24.0	20.000000	PASS
RF output power	5500.000	24.0	20.000000	PASS
Power Spectral Density	5500.000	24.0	20.000000	PASS
Occupied Channel Bandwidth 99%	5500.000	24.0	20.000000	PASS
Emission Bandwidth 26 dB	5600.000	24.0	20.000000	PASS
Power Spectral Density	5600.000	24.0	20.000000	PASS
Occupied Channel Bandwidth 99%	5600.000	24.0	20.000000	PASS
Emission Bandwidth 26 dB	5720.000	24.0	20.000000	PASS
Power Spectral Density	5720.000	24.0	20.000000	PASS
Occupied Channel Bandwidth 99%	5720.000	24.0	20.000000	PASS
Emission Bandwidth 26 dB	5510.000	24.0	40.000000	PASS
Power Spectral Density	5510.000	24.0	40.000000	PASS
Occupied Channel Bandwidth 99%	5510.000	24.0	40.000000	PASS
Emission Bandwidth 26 dB	5590.000	24.0	40.000000	PASS
Power Spectral Density	5590.000	24.0	40.000000	PASS
Occupied Channel Bandwidth 99%	5590.000	24.0	40.000000	PASS
Emission Bandwidth 26 dB	5710.000	24.0	40.000000	PASS
Power Spectral Density	5710.000	24.0	40.000000	PASS
Occupied Channel Bandwidth 99%	5710.000	24.0	40.000000	PASS
Emission Bandwidth 26 dB	5530.000	24.0	80.000000	PASS
Power Spectral Density	5530.000	24.0	80.000000	PASS
Occupied Channel Bandwidth 99%	5530.000	24.0	80.000000	PASS
Emission Bandwidth 26 dB	5610.000	24.0	80.000000	PASS
Power Spectral Density	5610.000	24.0	80.000000	PASS
Occupied Channel Bandwidth 99%	5610.000	24.0	80.000000	PASS
Emission Bandwidth 26 dB	5690.000	24.0	80.000000	PASS
Power Spectral Density	5690.000	24.0	80.000000	PASS
Occupied Channel Bandwidth 99%	5690.000	24.0	80.000000	PASS
Emission Bandwidth 26 dB	5570.000	24.0	160.000000	PASS
Power Spectral Density	5570.000	24.0	160.000000	PASS
Occupied Channel Bandwidth 99%	5570.000	24.0	160.000000	PASS

### Emission Bandwidth 26 dB (5500 MHz; 24.000 dBm; 20 MHz)

Customized settings.

### 26 dB Bandwidth

DUT Frequency (MHz)	Bandwidth (MHz)	Limit Min (MHz)	Limit Max (MHz)	Band Edge Left (MHz)	Band Edge Right (MHz)
5500.000000	22.400000	---	---	5488.750000	5511.150000

(continuation of the "26 dB Bandwidth" table from column 6 ...)

DUT Frequency (MHz)	Max Level (dBm)	Result
5500.000000	3.0	PASS

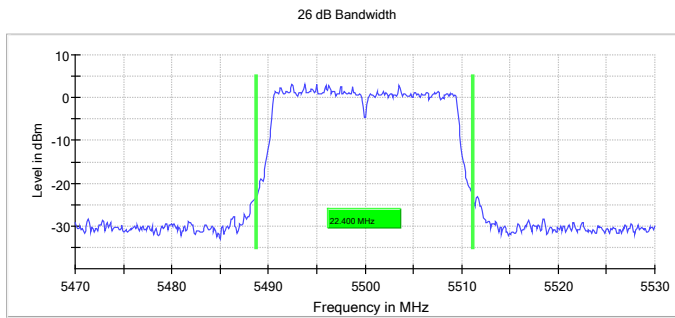

### Bandwidth



Date: 12, JAN, 2024 03:32:41

### Measurement

Setting	Instrument Value	Target Value
Start Frequency	5.47000 GHz	5.47000 GHz
Stop Frequency	5.53000 GHz	5.53000 GHz
Span	60.000 MHz	60.000 MHz
RBW	200.000 kHz	~ 200.000 kHz
VBW	300.000 kHz	$\geq$ 240.000 kHz
SweepPoints	600	~ 600
SweepTime	37.969 $\mu$ s	AUTO
Reference Level	20.000 dBm	20.000 dBm
Attenuation	40.000 dB	AUTO
Detector	MaxPeak	MaxPeak
SweepCount	500	500
Filter	3 dB	3 dB
Trace Mode	Max Hold	Max Hold
SweepType	FFT	AUTO
Preamp	off	off

## RF output power (5500 MHz; 24.000 dBm; 20 MHz)

Customized settings.

### Result

DUT Frequency (MHz)	Gated RMS (dBm)	Limit Max (dBm)	Gated EIRP (dBm)	DutyCycle (%)	Result
5500.000000	23.1	24.0	23.1	99.712	PASS

### OSP PowerMeter settings

Setting	Instrument Value	Target Value
Measurement Time	1.000 s	1.000 s
Points	1000000	1000000
Time resolution	1.000 $\mu$ s	1.000 $\mu$ s

## Power Spectral Density (5500 MHz; 24.000 dBm; 20 MHz)

Customized settings.

### Result

DUT Frequency (MHz)	Frequency (MHz)	PSD (dBm)	Limit Max (dBm)	Result
5500.000000	5491.683168	7.295	11.0	PASS

### Ports

Port	State
1	used
2	used
3	used
4	used

Power Spectral Density

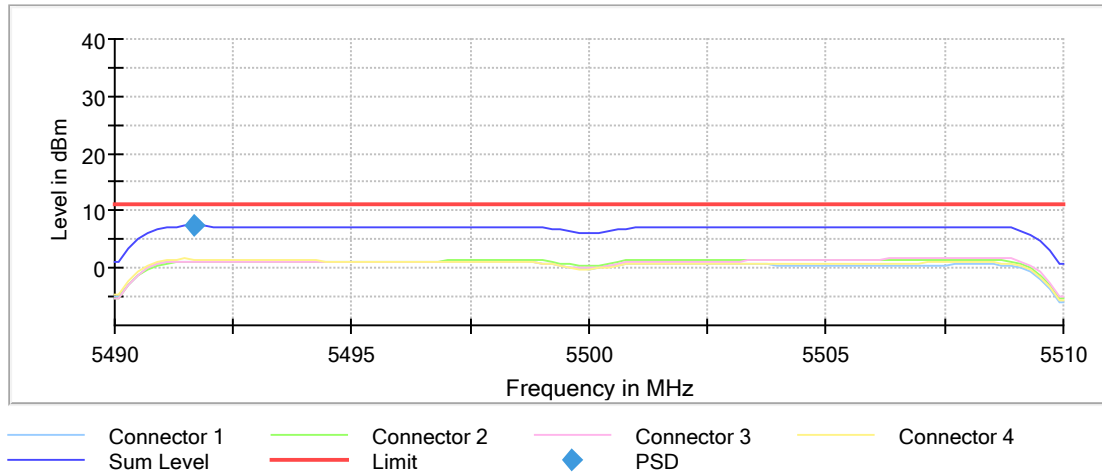

### Measurement

Setting	Instrument Value	Target Value
Start Frequency	5.49000 GHz	5.49000 GHz
Stop Frequency	5.51000 GHz	5.51000 GHz
Span	20.000 MHz	20.000 MHz
RBW	1.000 MHz	<= 1.000 MHz
VBW	3.000 MHz	>= 3.000 MHz
SweepPoints	101	~ 40
SweepTime	2.020 ms	2.020 ms
Reference Level	10.000 dBm	10.000 dBm
Attenuation	30.000 dB	AUTO
Detector	RMS	RMS
SweepCount	100	100
Filter	3 dB	3 dB
Trace Mode	Average Power	Average Power
SweepType	FFT	AUTO
Preamp	off	off

## Occupied Channel Bandwidth 99% (5500 MHz; 24.000 dBm; 20 MHz)

Customized settings.

### 99 % Bandwidth

DUT Frequency (MHz)	Bandwidth (MHz)	Limit Min (MHz)	Limit Max (MHz)	Band Edge Left (MHz)	Band Edge Right (MHz)
5500.000000	19.100000	---	---	5490.450000	5509.550000

(continuation of the "99 % Bandwidth" table from column 6 ...)

DUT Frequency (MHz)	Result
5500.000000	PASS

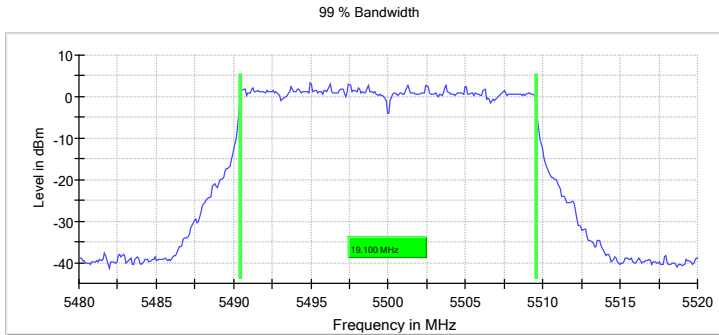

### Bandwidth



Date: 12.JAN.2024 09:34:13

## Measurement

Setting	Instrument Value	Target Value
Start Frequency	5.48000 GHz	5.48000 GHz
Stop Frequency	5.52000 GHz	5.52000 GHz
Span	40.000 MHz	40.000 MHz
RBW	200.000 kHz	>= 200.000 kHz
VBW	1.000 MHz	>= 600.000 kHz
SweepPoints	400	~ 400
SweepTime	28.477 $\mu$ s	AUTO
Reference Level	10.000 dBm	10.000 dBm
Attenuation	30.000 dB	AUTO
Detector	MaxPeak	MaxPeak
SweepCount	500	500
Filter	3 dB	3 dB
Trace Mode	Max Hold	Max Hold
SweepType	FFT	AUTO
Preamp	off	off

## Emission Bandwidth 26 dB (5600 MHz; 24.000 dBm; 20 MHz)

Customized settings.

### 26 dB Bandwidth

DUT Frequency (MHz)	Bandwidth (MHz)	Limit Min (MHz)	Limit Max (MHz)	Band Edge Left (MHz)	Band Edge Right (MHz)
5600.000000	22.900000	---	---	5588.550000	5611.450000

(continuation of the "26 dB Bandwidth" table from column 6 ...)

DUT Frequency (MHz)	Max Level (dBm)	Result
5600.000000	2.7	PASS

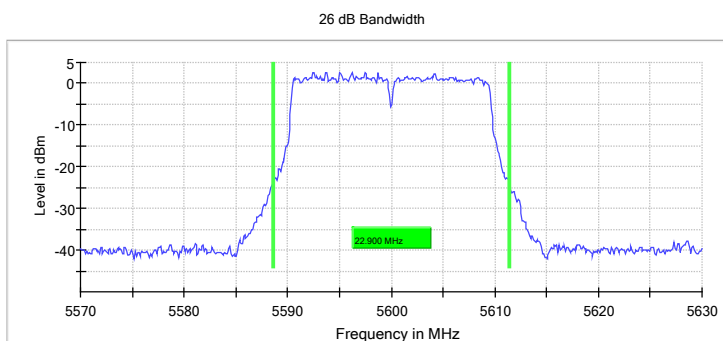

Bandwidth

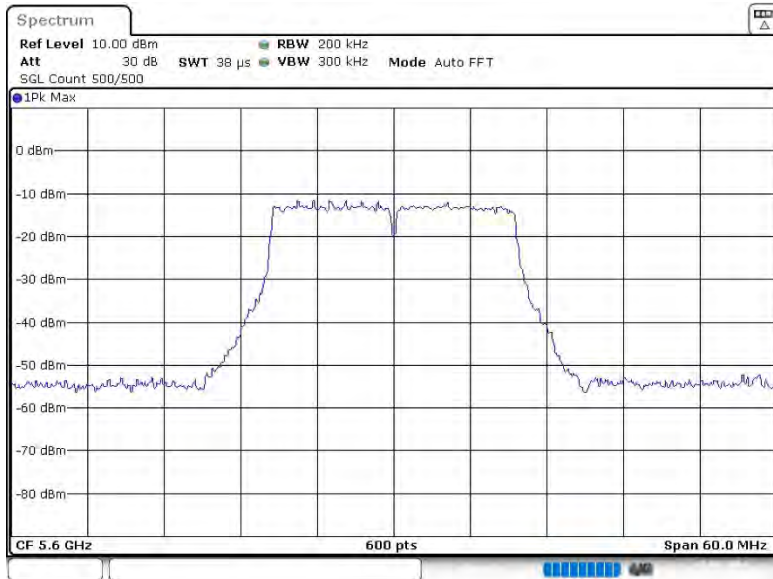

Date: 12.JAN.2024 03:36:00

### Power Spectral Density (5600 MHz; 24.000 dBm; 20 MHz)

Customized settings.

### Result

DUT Frequency (MHz)	Frequency (MHz)	PSD (dBm)	Limit Max (dBm)	Result
5600.000000	5591.683168	7.649	11.0	PASS

### Ports

Port	State
1	used
2	used
3	used
4	used

Power Spectral Density

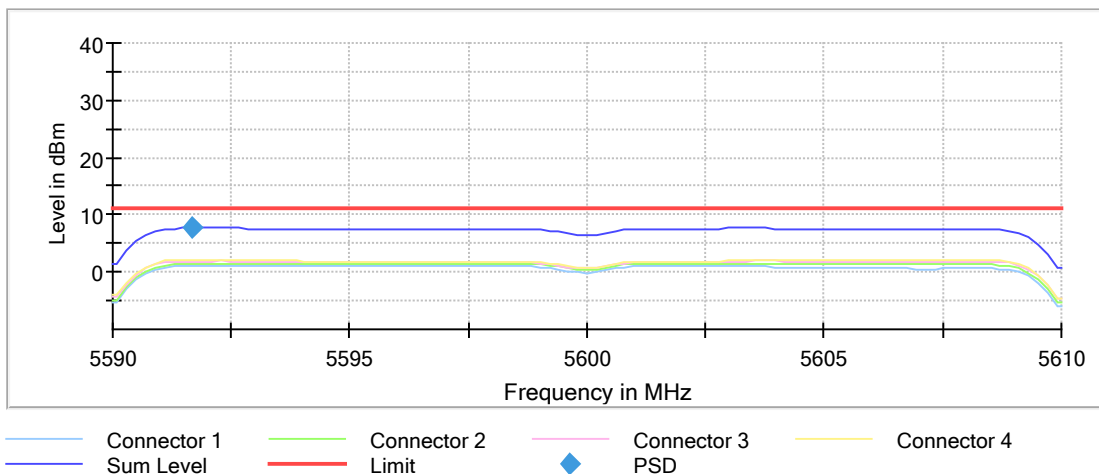

**Occupied Channel Bandwidth 99% (5600 MHz; 24.000 dBm; 20 MHz)**

Customized settings.

**99 % Bandwidth**

DUT Frequency (MHz)	Bandwidth (MHz)	Limit Min (MHz)	Limit Max (MHz)	Band Edge Left (MHz)	Band Edge Right (MHz)
5600.000000	19.100000	---	---	5590.450000	5609.550000

(continuation of the "99 % Bandwidth" table from column 6 ...)

DUT Frequency (MHz)	Result
5600.000000	PASS

99 % Bandwidth

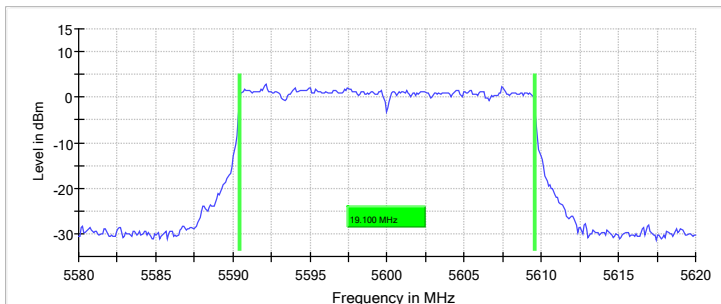

Bandwidth





Date: 12.07AN.2024 03:37:32

## Emission Bandwidth 26 dB (5720 MHz; 24.000 dBm; 20 MHz)

Customized settings.

### 26 dB Bandwidth

DUT Frequency (MHz)	Bandwidth (MHz)	Bandwidth U-NII 2C (MHz)	Bandwidth U-NII 3 (MHz)	Limit Min (MHz)	Limit Max (MHz)
5720.000000	22.700000	16.450000	6.250000	---	---

(continuation of the "26 dB Bandwidth" table from column 6 ...)

DUT Frequency (MHz)	Band Edge Left (MHz)	Band Edge Right (MHz)	Max Level (dBm)	Result
5720.000000	5708.550000	5731.250000	2.4	PASS

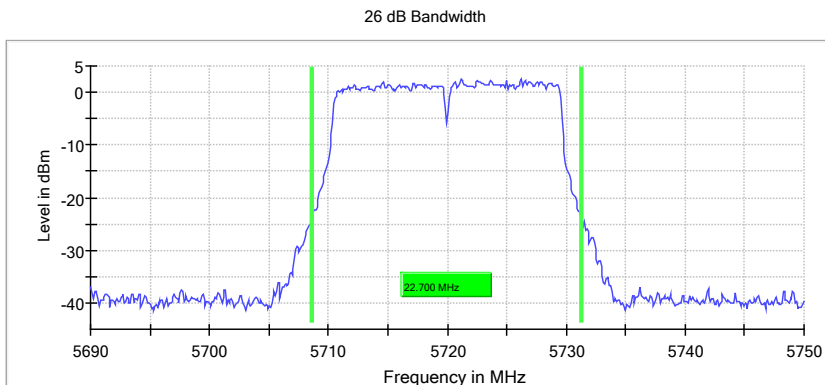

**Bandwidth**

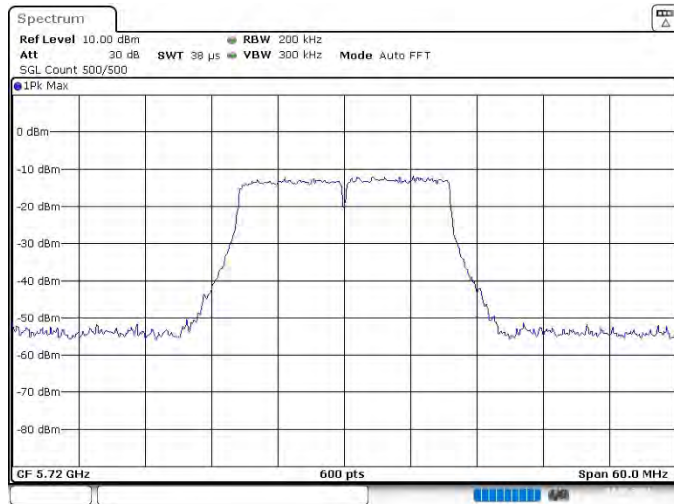

**Power Spectral Density (5720 MHz; 24.000 dBm; 20 MHz)**

Customized settings.

**Result**

DUT Frequency (MHz)	Frequency (MHz)	PSD (dBm)	Limit Max (dBm)	Result
5720.000000	5728.316832	7.678	11.0	PASS

**Ports**

Port	State
1	used
2	used
3	used
4	used

Power Spectral Density

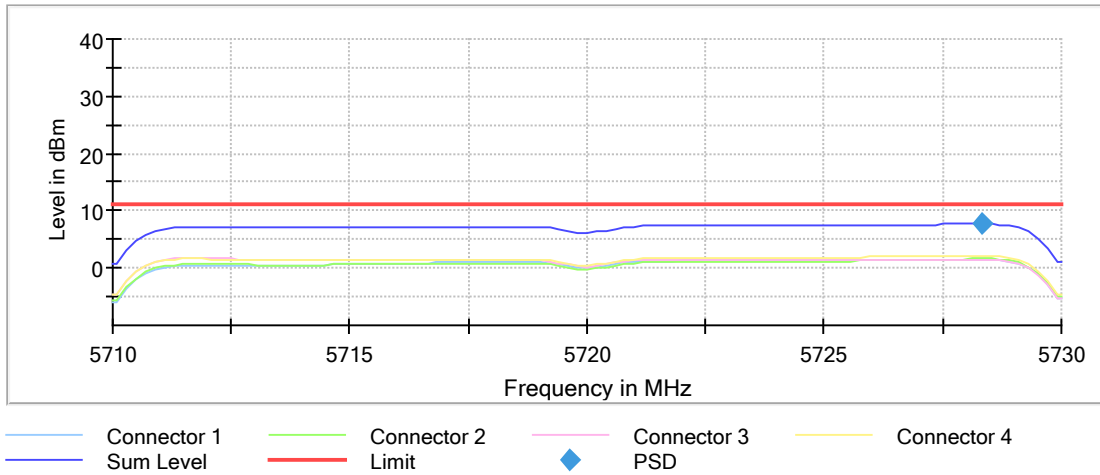

**Occupied Channel Bandwidth 99% (5720 MHz; 24.000 dBm; 20 MHz)**

Customized settings.

**99 % Bandwidth**

DUT Frequency (MHz)	Bandwidth (MHz)	Bandwidth U-NII 2C (MHz)	Bandwidth U-NII 3 (MHz)	Limit Min (MHz)	Limit Max (MHz)
5720.000000	19.100000	14.550000	4.550000	---	---

(continuation of the "99 % Bandwidth" table from column 6 ...)

DUT Frequency (MHz)	Band Edge Left (MHz)	Band Edge Right (MHz)	Result
5720.000000	5710.450000	5729.550000	PASS

99 % Bandwidth

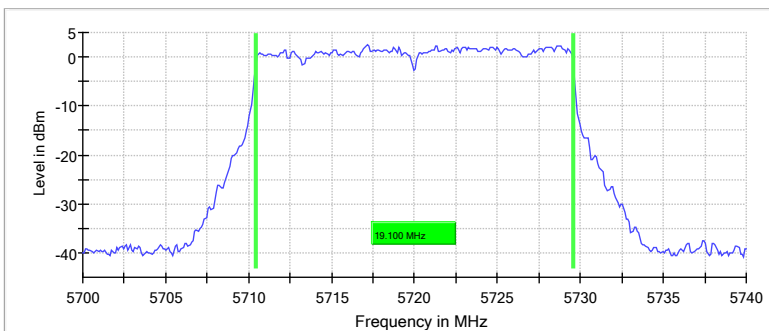

Bandwidth



Date: 12 JAN 2024 03:39:22

## Emission Bandwidth 26 dB (5510 MHz; 24.000 dBm; 40 MHz)

Customized settings.

### 26 dB Bandwidth

DUT Frequency (MHz)	Bandwidth (MHz)	Limit Min (MHz)	Limit Max (MHz)	Band Edge Left (MHz)	Band Edge Right (MHz)
5510.000000	45.150000	---	---	5487.725000	5532.875000

(continuation of the "26 dB Bandwidth" table from column 6 ...)

DUT Frequency (MHz)	Max Level (dBm)	Result
5510.000000	1.8	PASS

26 dB Bandwidth

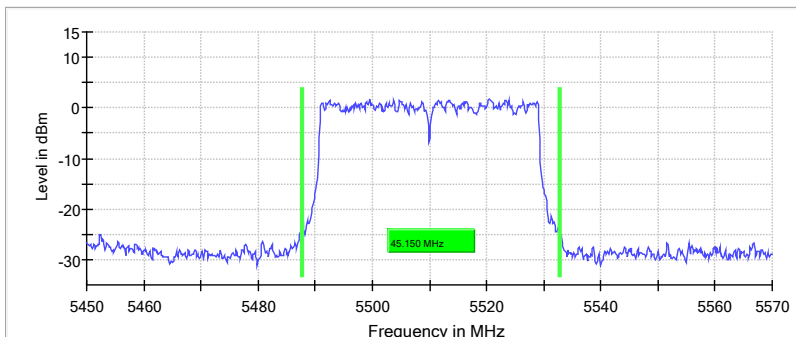

**Bandwidth**

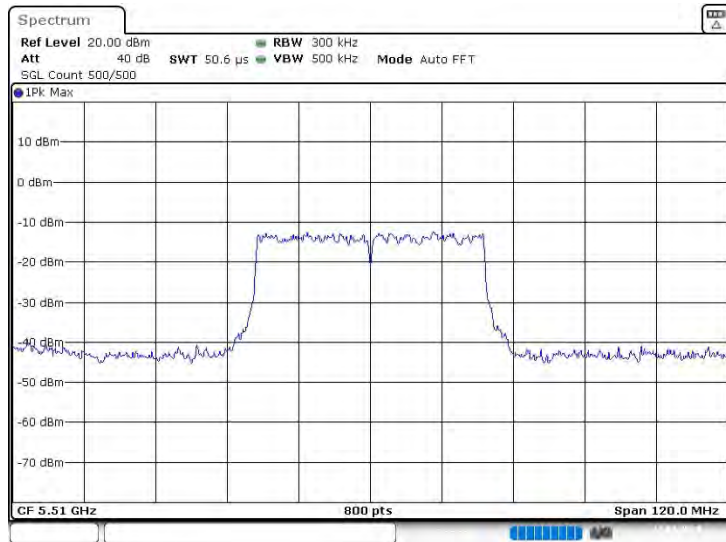

Date: 12, JAN, 2024 05:51:57

**Power Spectral Density (5510 MHz; 24.000 dBm; 40 MHz)**

Customized settings.

**Result**

DUT Frequency (MHz)	Frequency (MHz)	PSD (dBm)	Limit Max (dBm)	Result
5510.000000	5527.821782	4.458	11.0	PASS

**Ports**

Port	State
1	used
2	used
3	used
4	used

Power Spectral Density

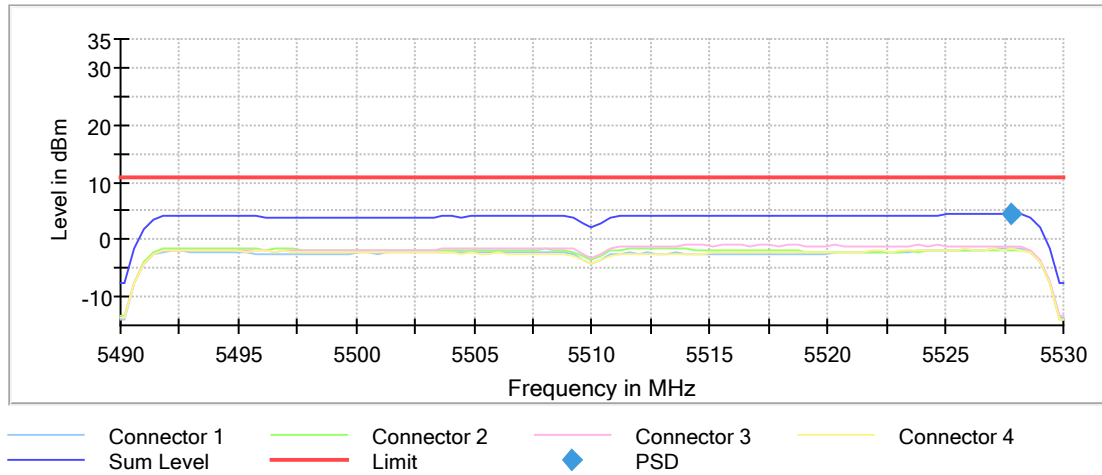

**Occupied Channel Bandwidth 99% (5510 MHz; 24.000 dBm; 40 MHz)**

Customized settings.

**99 % Bandwidth**

DUT Frequency (MHz)	Bandwidth (MHz)	Limit Min (MHz)	Limit Max (MHz)	Band Edge Left (MHz)	Band Edge Right (MHz)
5510.000000	38.250000	---	---	5490.875000	5529.125000

(continuation of the "99 % Bandwidth" table from column 6 ...)

DUT Frequency (MHz)	Result
5510.000000	PASS

99 % Bandwidth

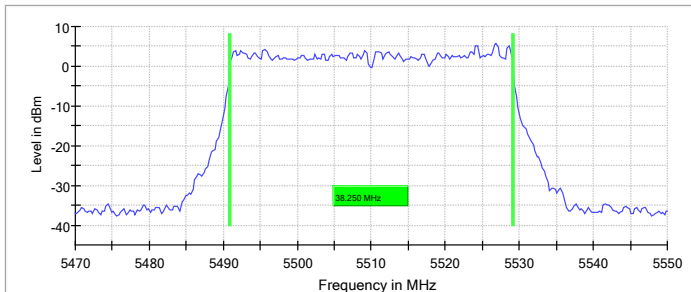

Bandwidth

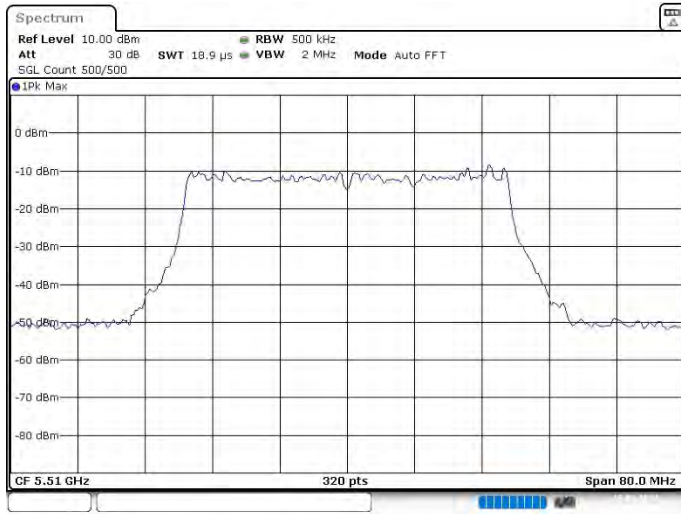

Date: 12/23/2024 03:53:29

## Emission Bandwidth 26 dB (5590 MHz; 24.000 dBm; 40 MHz)

Customized settings.

### 26 dB Bandwidth

DUT Frequency (MHz)	Bandwidth (MHz)	Limit Min (MHz)	Limit Max (MHz)	Band Edge Left (MHz)	Band Edge Right (MHz)
5590.000000	44.100000	---	---	5567.875000	5611.975000

(continuation of the "26 dB Bandwidth" table from column 6 ...)

DUT Frequency (MHz)	Max Level (dBm)	Result
5590.000000	1.9	PASS

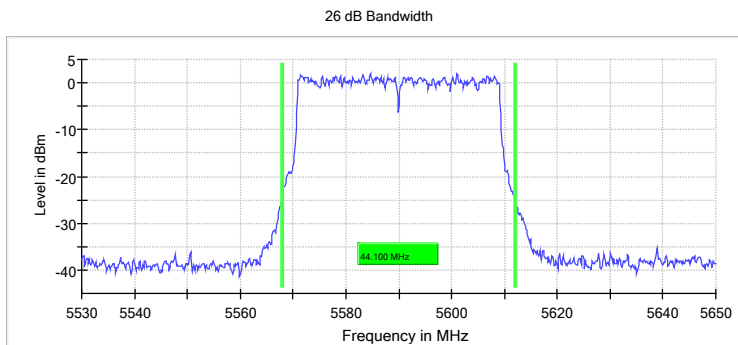

Bandwidth

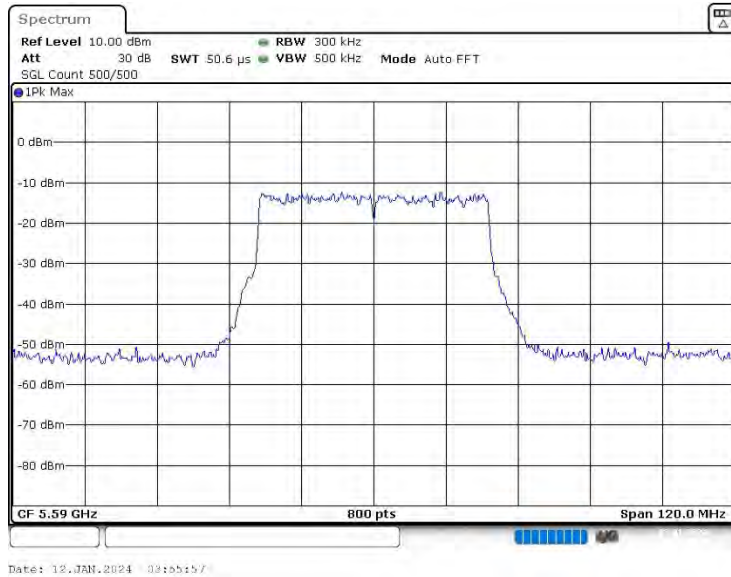

## Power Spectral Density (5590 MHz; 24.000 dBm; 40 MHz)

Customized settings.

### Result

DUT Frequency (MHz)	Frequency (MHz)	PSD (dBm)	Limit Max (dBm)	Result
5590.000000	5587.623762	4.408	11.0	PASS

### Ports

Port	State
1	used
2	used
3	used
4	used



Power Spectral Density

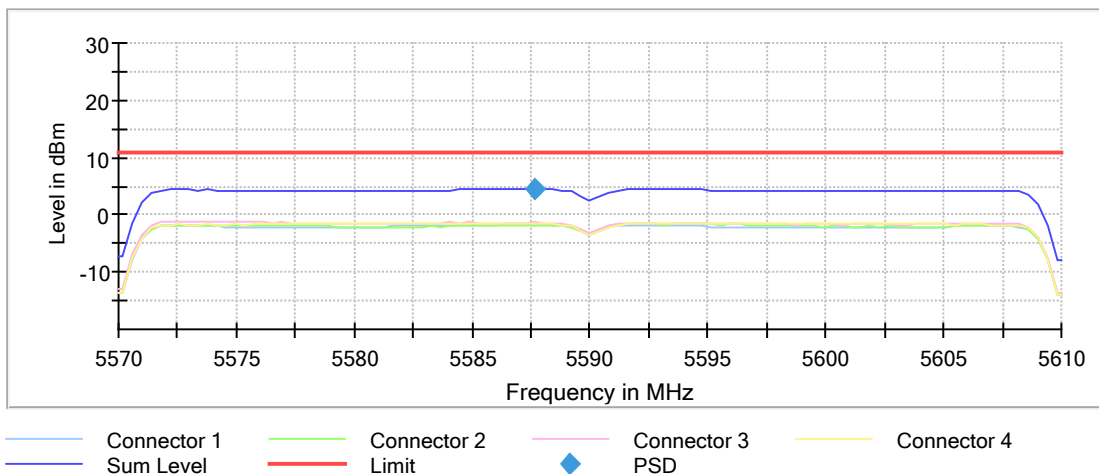

**Occupied Channel Bandwidth 99% (5590 MHz; 24.000 dBm; 40 MHz)**

Customized settings.

**99 % Bandwidth**

DUT Frequency (MHz)	Bandwidth (MHz)	Limit Min (MHz)	Limit Max (MHz)	Band Edge Left (MHz)	Band Edge Right (MHz)
5590.000000	38.250000	---	---	5570.875000	5609.125000

(continuation of the "99 % Bandwidth" table from column 6 ...)

DUT Frequency (MHz)	Result
5590.000000	PASS

99 % Bandwidth

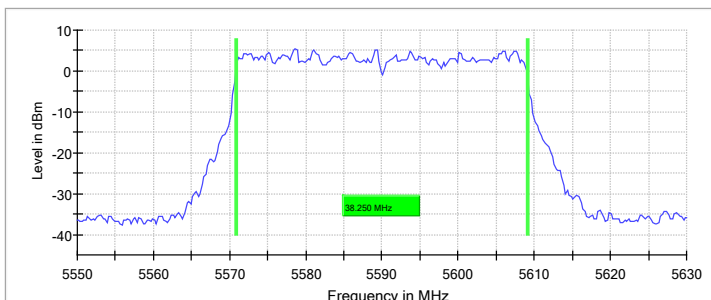

Bandwidth



Date: 12-JUN-2024 03:37:23

## Emission Bandwidth 26 dB (5710 MHz; 24.000 dBm; 40 MHz)

Customized settings.

### 26 dB Bandwidth

DUT Frequency (MHz)	Bandwidth (MHz)	Bandwidth U-NII 2C (MHz)	Bandwidth U-NII 3 (MHz)	Limit Min (MHz)	Limit Max (MHz)
5710.000000	43.500000	36.375000	7.125000	---	---

(continuation of the "26 dB Bandwidth" table from column 6 ...)

DUT Frequency (MHz)	Band Edge Left (MHz)	Band Edge Right (MHz)	Max Level (dBm)	Result
5710.000000	5688.625000	5732.125000	2.7	PASS

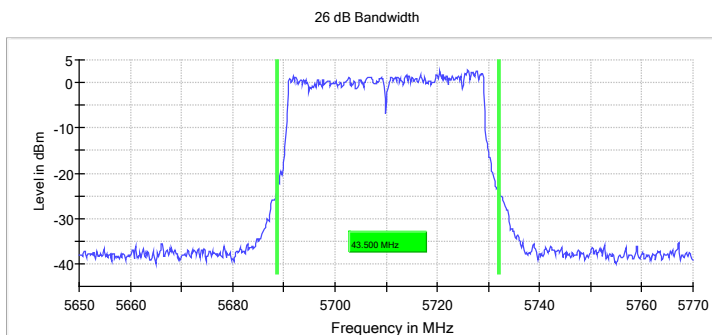

### Bandwidth



Date: 12.JAN.2024 03:59:49

### Power Spectral Density (5710 MHz; 24.000 dBm; 40 MHz)

Customized settings.

### Result

DUT Frequency (MHz)	Frequency (MHz)	PSD (dBm)	Limit Max (dBm)	Result
5710.000000	5727.821782	4.816	11.0	PASS

### Ports

Port	State
1	used
2	used
3	used
4	used

Power Spectral Density

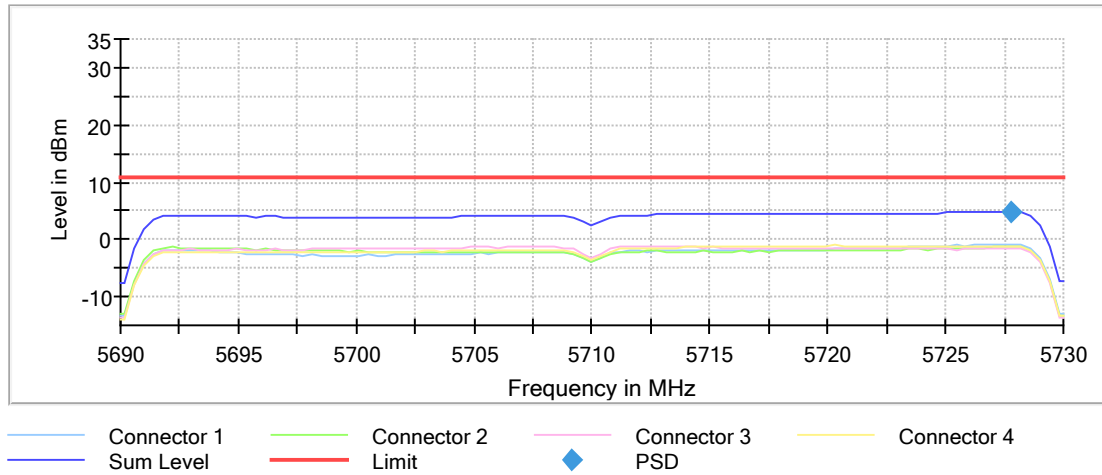

**Occupied Channel Bandwidth 99% (5710 MHz; 24.000 dBm; 40 MHz)**

Customized settings.

**99 % Bandwidth**

DUT Frequency (MHz)	Bandwidth (MHz)	Bandwidth U-NII 2C (MHz)	Bandwidth U-NII 3 (MHz)	Limit Min (MHz)	Limit Max (MHz)
5710.000000	38.250000	34.125000	4.125000	---	---

(continuation of the "99 % Bandwidth" table from column 6 ...)

DUT Frequency (MHz)	Band Edge Left (MHz)	Band Edge Right (MHz)	Result
5710.000000	5690.875000	5729.125000	PASS

99 % Bandwidth

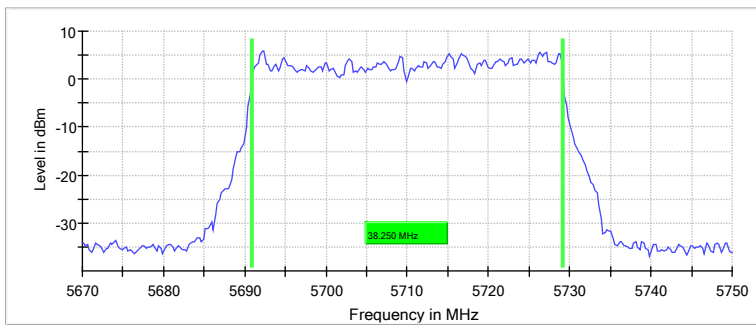

Bandwidth

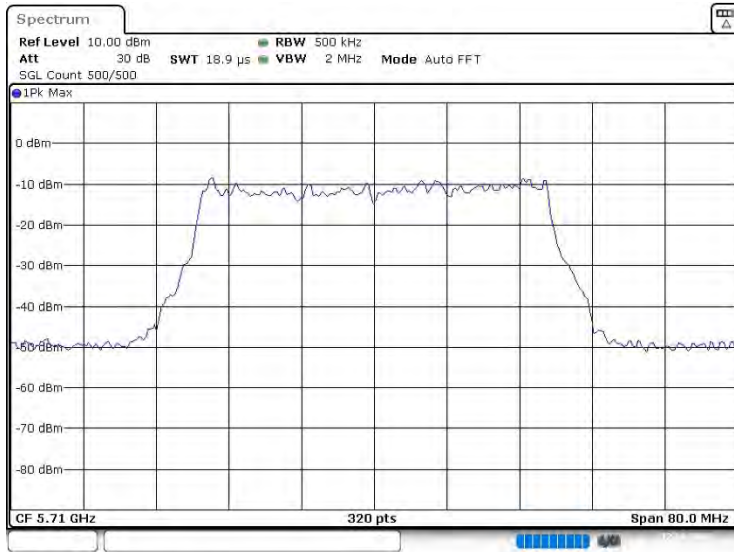

Date: 12, JAN, 2024 03:59:18

## Emission Bandwidth 26 dB (5530 MHz; 24.000 dBm; 80 MHz)

Customized settings.

### 26 dB Bandwidth

DUT Frequency (MHz)	Bandwidth (MHz)	Limit Min (MHz)	Limit Max (MHz)	Band Edge Left (MHz)	Band Edge Right (MHz)
5530.000000	138.000000	---	---	5460.750000	5598.750000

(continuation of the "26 dB Bandwidth" table from column 6 ...)

DUT Frequency (MHz)	Max Level (dBm)	Result
5530.000000	4.6	PASS

26 dB Bandwidth

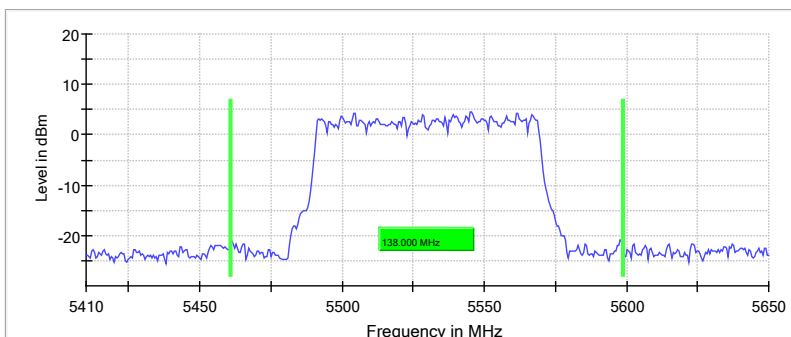

Bandwidth

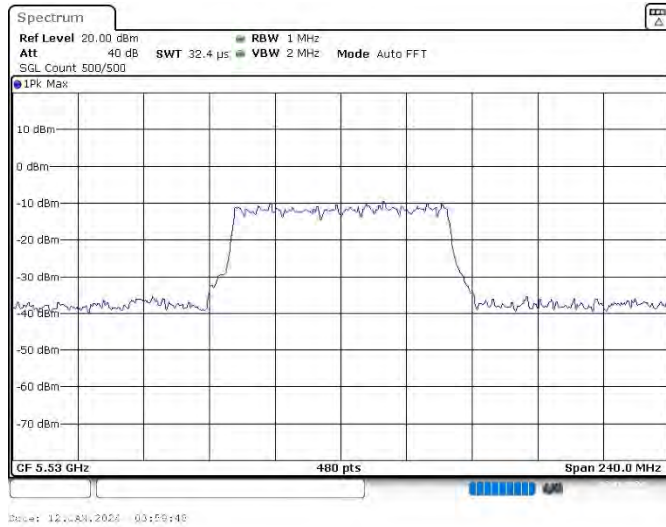

## Power Spectral Density (5530 MHz; 24.000 dBm; 80 MHz)

Customized settings.

## Result

DUT Frequency (MHz)	Frequency (MHz)	PSD (dBm)	Limit Max (dBm)	Result
5530.000000	5567.250000	1.572	11.0	PASS

## Ports

Port	State
1	used
2	used
3	used
4	used

Power Spectral Density

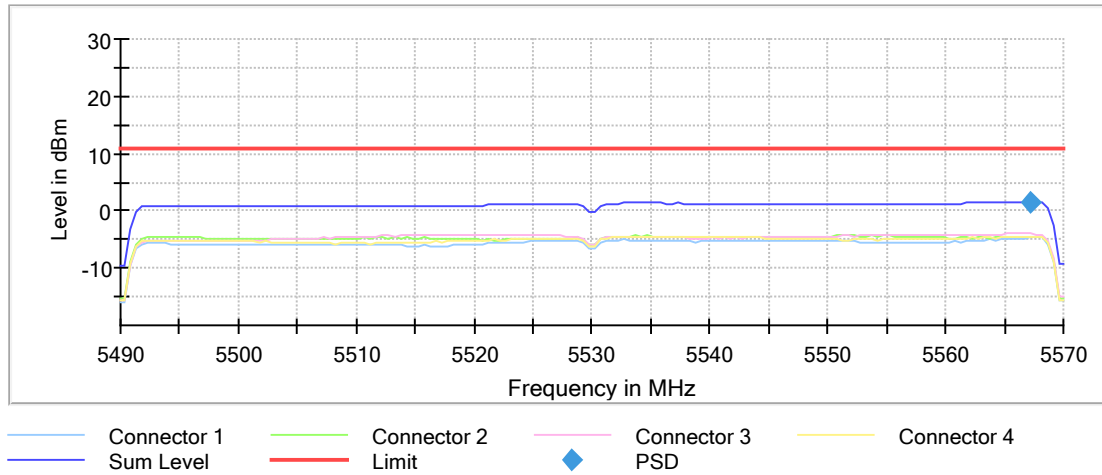

**Occupied Channel Bandwidth 99% (5530 MHz; 24.000 dBm; 80 MHz)**

Customized settings.

**99 % Bandwidth**

DUT Frequency (MHz)	Bandwidth (MHz)	Limit Min (MHz)	Limit Max (MHz)	Band Edge Left (MHz)	Band Edge Right (MHz)
5530.000000	77.500000	---	---	5491.250000	5568.750000

(continuation of the "99 % Bandwidth" table from column 6 ...)

DUT Frequency (MHz)	Result
5530.000000	PASS

99 % Bandwidth

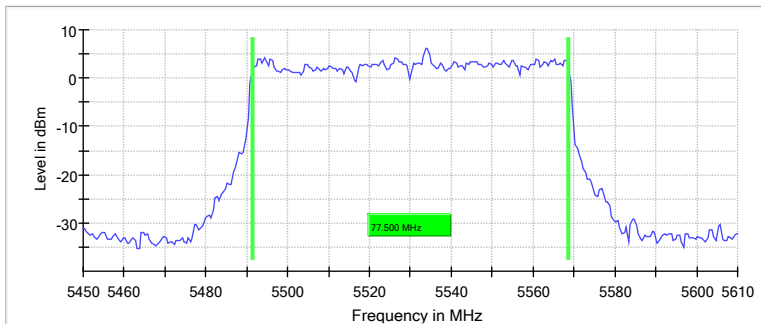

Bandwidth

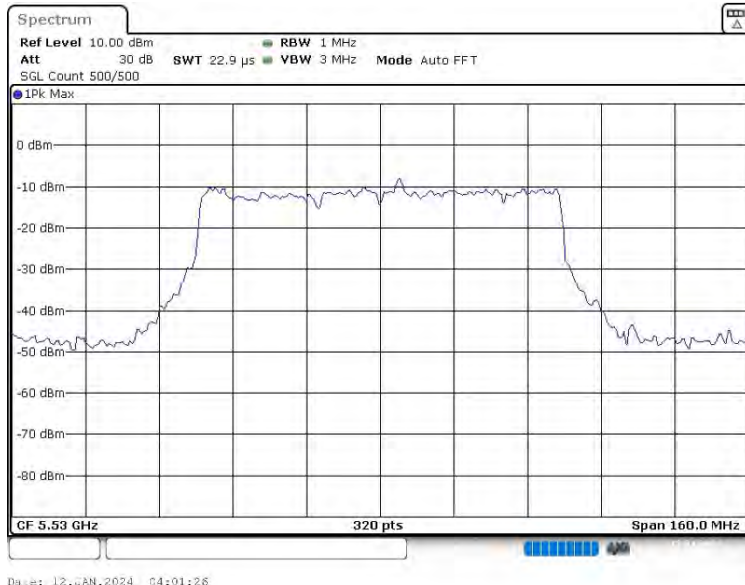

## Emission Bandwidth 26 dB (5610 MHz; 24.000 dBm; 80 MHz)

Customized settings.

### 26 dB Bandwidth

DUT Frequency (MHz)	Bandwidth (MHz)	Limit Min (MHz)	Limit Max (MHz)	Band Edge Left (MHz)	Band Edge Right (MHz)
5610.000000	88.000000	---	---	5566.250000	5654.250000

(continuation of the "26 dB Bandwidth" table from column 6 ...)

DUT Frequency (MHz)	Max Level (dBm)	Result
5610.000000	5.8	PASS

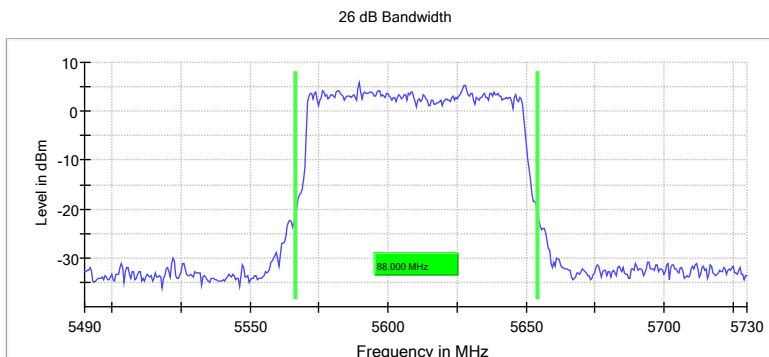



### Bandwidth



### Power Spectral Density (5610 MHz; 24.000 dBm; 80 MHz)

Customized settings.

### Result

DUT Frequency (MHz)	Frequency (MHz)	PSD (dBm)	Limit Max (dBm)	Result
5610.000000	5592.750000	1.518	11.0	PASS

### Ports

Port	State
1	used
2	used
3	used
4	used

Power Spectral Density

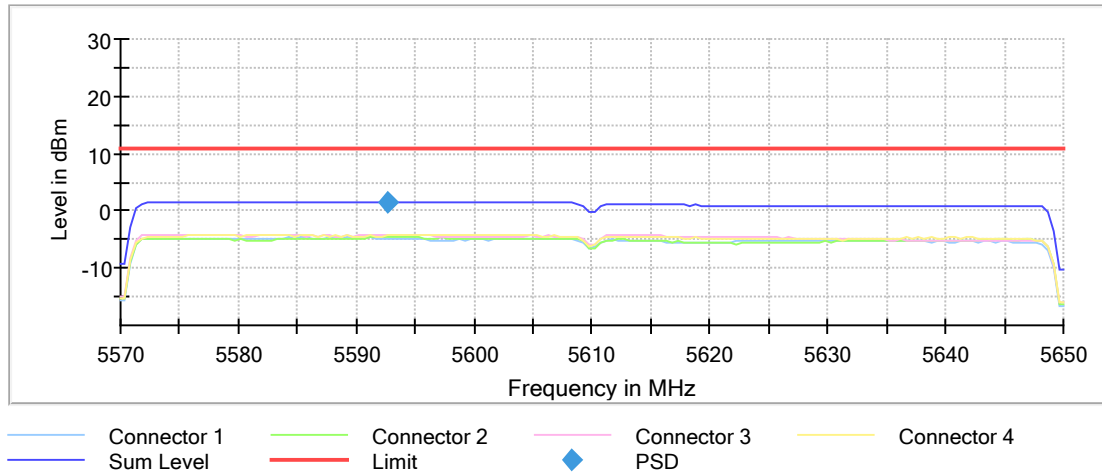

**Occupied Channel Bandwidth 99% (5610 MHz; 24.000 dBm; 80 MHz)**

Customized settings.

**99 % Bandwidth**

DUT Frequency (MHz)	Bandwidth (MHz)	Limit Min (MHz)	Limit Max (MHz)	Band Edge Left (MHz)	Band Edge Right (MHz)
5610.000000	78.000000	---	---	5570.750000	5648.750000

(continuation of the "99 % Bandwidth" table from column 6 ...)

DUT Frequency (MHz)	Result
5610.000000	PASS

99 % Bandwidth

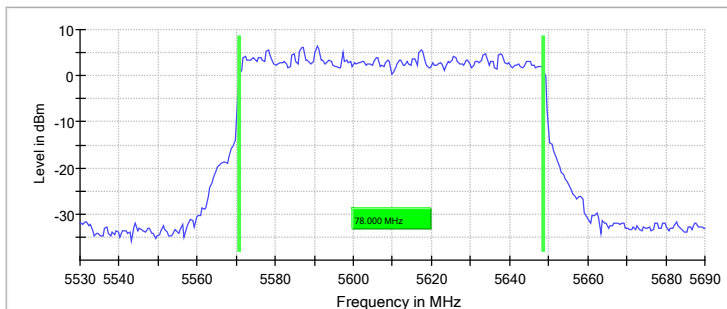

Bandwidth

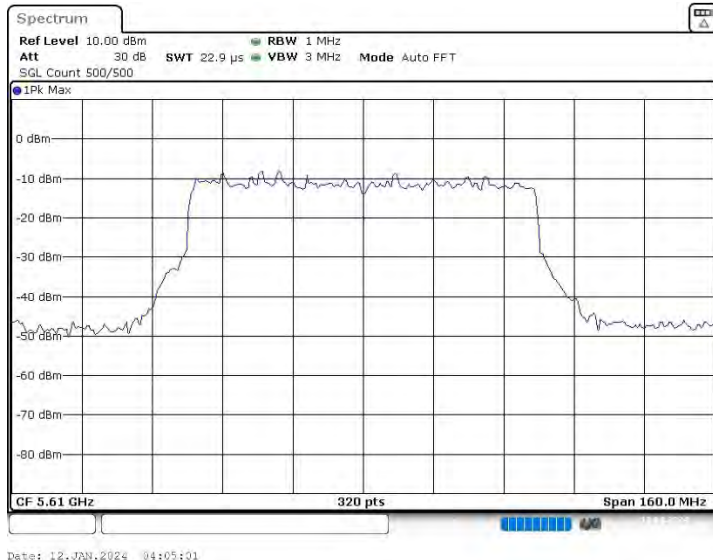

## Emission Bandwidth 26 dB (5690 MHz; 24.000 dBm; 80 MHz)

Customized settings.

### 26 dB Bandwidth

DUT Frequency (MHz)	Bandwidth (MHz)	Bandwidth U-NII 2C (MHz)	Bandwidth U-NII 3 (MHz)	Limit Min (MHz)	Limit Max (MHz)
5690.000000	86.500000	78.750000	7.750000	---	---

(continuation of the "26 dB Bandwidth" table from column 6 ...)

DUT Frequency (MHz)	Band Edge Left (MHz)	Band Edge Right (MHz)	Max Level (dBm)	Result
5690.000000	5646.250000	5732.750000	6.5	PASS

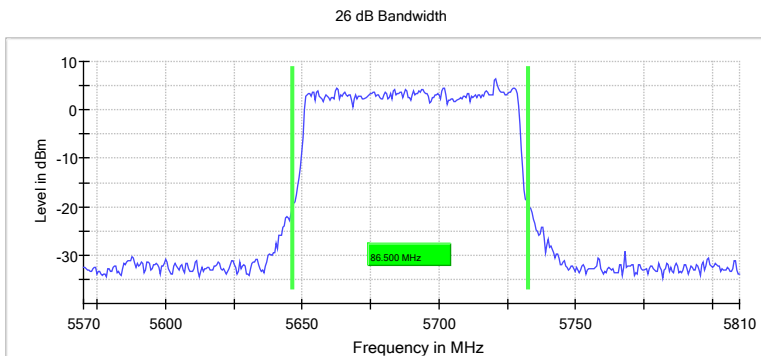

Bandwidth

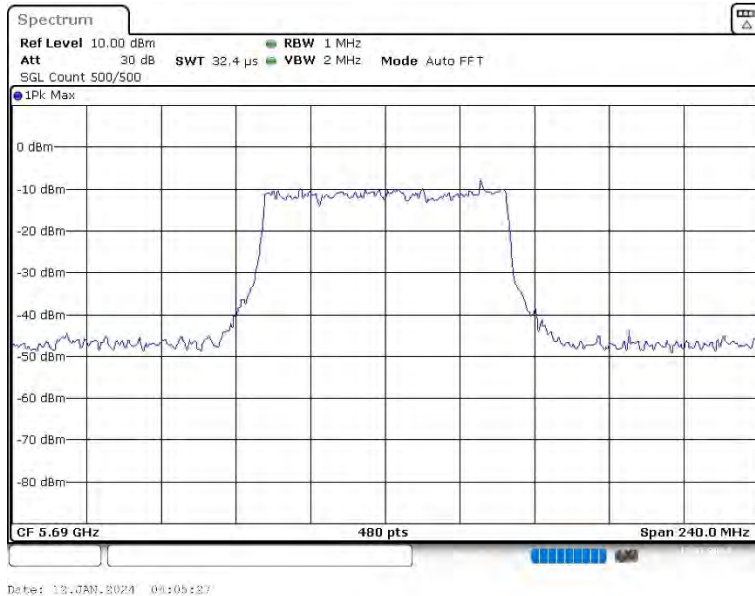

## Power Spectral Density (5690 MHz; 24.000 dBm; 80 MHz)

Customized settings.

## Result

DUT Frequency (MHz)	Frequency (MHz)	PSD (dBm)	Limit Max (dBm)	Result
5690.000000	5727.750000	1.847	11.0	PASS

## Ports

Port	State
1	used
2	used
3	used
4	used

Power Spectral Density

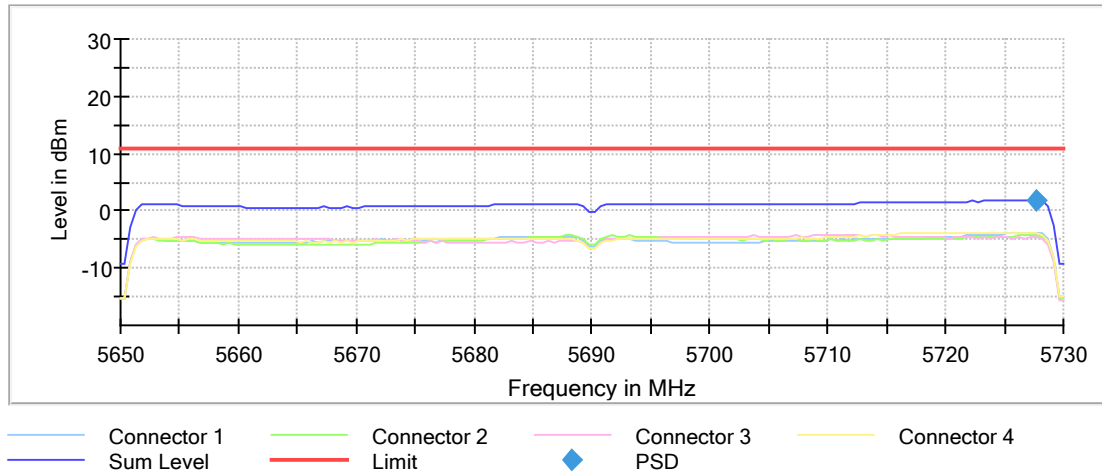

**Occupied Channel Bandwidth 99% (5690 MHz; 24.000 dBm; 80 MHz)**

Customized settings.

**99 % Bandwidth**

DUT Frequency (MHz)	Bandwidth (MHz)	Bandwidth U-NII 2C (MHz)	Bandwidth U-NII 3 (MHz)	Limit Min (MHz)	Limit Max (MHz)
5690.000000	78.500000	74.250000	4.250000	---	---

(continuation of the "99 % Bandwidth" table from column 6 ...)

DUT Frequency (MHz)	Band Edge Left (MHz)	Band Edge Right (MHz)	Result
5690.000000	5650.750000	5729.250000	PASS

99 % Bandwidth

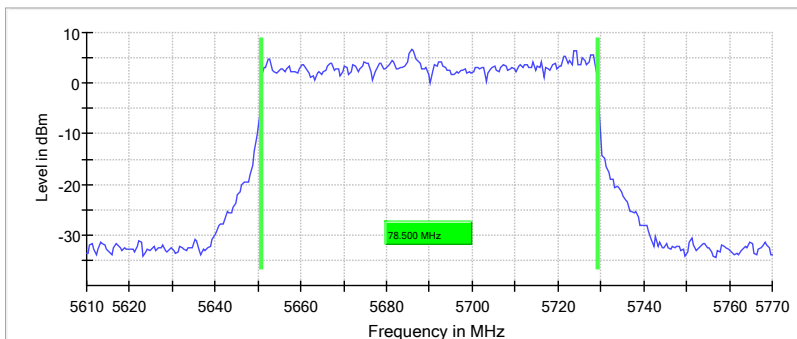

Bandwidth

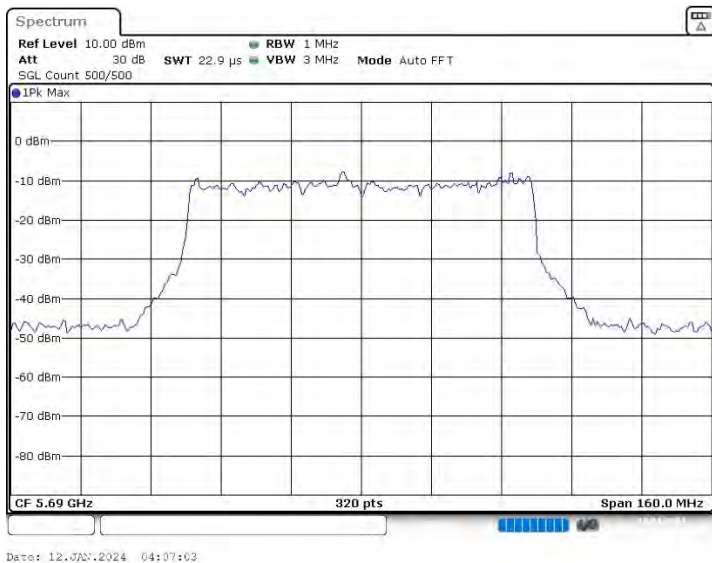

## Emission Bandwidth 26 dB (5570 MHz; 24.000 dBm; 160 MHz)

Customized settings.

### 26 dB Bandwidth

DUT Frequency (MHz)	Bandwidth (MHz)	Bandwidth U-NII 2C (MHz)	Bandwidth U-NII 3 (MHz)	Limit Min (MHz)	Limit Max (MHz)
5570.000000	170.000000	170.000000	0.000000	---	---

(continuation of the "26 dB Bandwidth" table from column 6 ...)

DUT Frequency (MHz)	Band Edge Left (MHz)	Band Edge Right (MHz)	Max Level (dBm)	Result
5570.000000	5484.500000	5654.500000	8.1	PASS

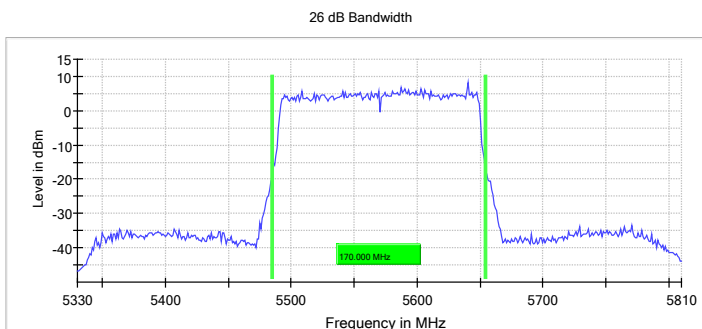

**Bandwidth**

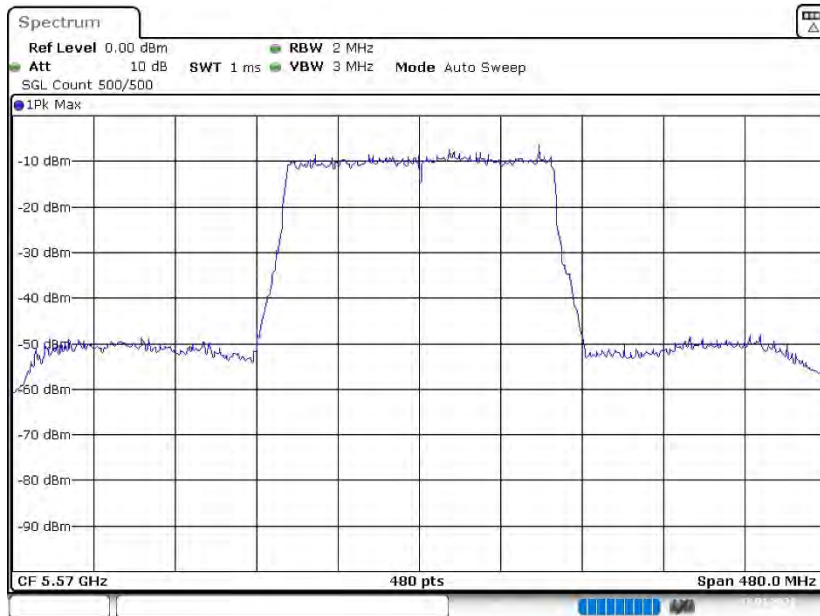

Date: 12.JAN.2024 04:08:09

**Power Spectral Density (5570 MHz; 24.000 dBm; 160 MHz)**

Customized settings.

**Result**

DUT Frequency (MHz)	Frequency (MHz)	PSD (dBm)	Limit Max (dBm)	Result
5570.000000	5574.750000	-0.626	11.0	PASS

**Ports**

Port	State
1	used
2	used
3	used
4	used

Power Spectral Density

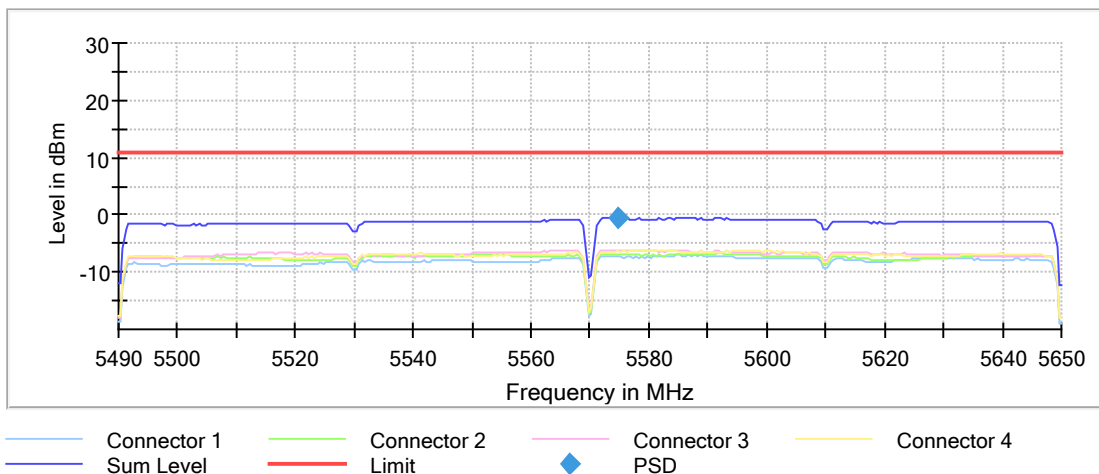

**Occupied Channel Bandwidth 99% (5570 MHz; 24.000 dBm; 160 MHz)**

Customized settings.

**99 % Bandwidth**

DUT Frequency (MHz)	Bandwidth (MHz)	Bandwidth U-NII 2C (MHz)	Bandwidth U-NII 3 (MHz)	Limit Min (MHz)	Limit Max (MHz)
5570.000000	159.000000	159.000000	0.000000	---	---

(continuation of the "99 % Bandwidth" table from column 6 ...)

DUT Frequency (MHz)	Band Edge Left (MHz)	Band Edge Right (MHz)	Result
5570.000000	5490.500000	5649.500000	PASS

99 % Bandwidth

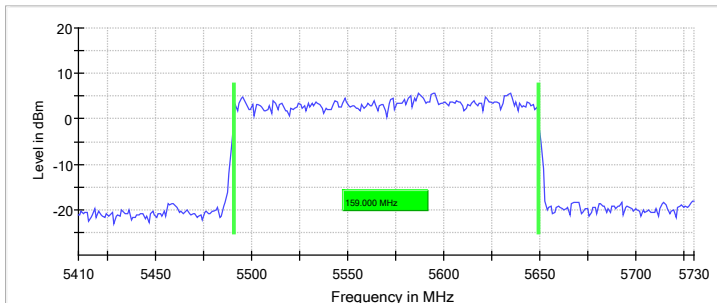

Bandwidth



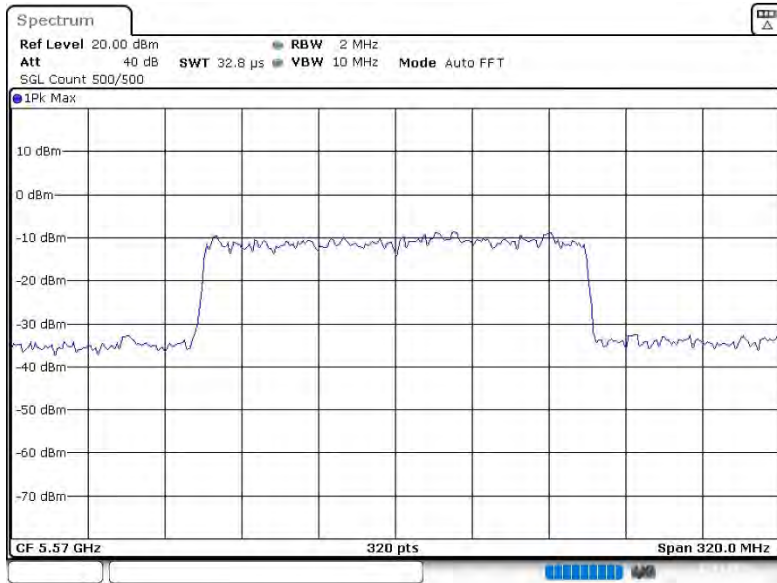

Date: 12.JAN.2024 06:10:08

-- End of Report --