



427 West 12800 South
Draper, UT 84020

Test Report Certification

FCC ID	SWX-U6EPIW
ISED ID	6545A-U6EPIW
Equipment Under Test	U6-Enterprise-IW
Test Report Serial Number	TR7179_03
Date of Test(s)	8, 11, 15, 16 November 2021; 4 January and 6 May 2022
Report Issue Date	8 June 2022

Test Specification	Applicant
47 CFR FCC Part 15, Subpart E	Ubiquiti Inc. 685 Third Avenue New York, NY 10017 U.S.A.



NVLAP LAB CODE 600241-0

Certification of Engineering Report

This report has been prepared by Unified Compliance Laboratory (UCL) to document compliance of the device described below with the requirement of Federal Communication Commissions (FCC) Part 15, Subpart E. This report may be reproduced in full. Partial reproduction of this report may only be made with the written consent of the laboratory. The results in this report apply only to the sample tested.

Applicant	Ubiquiti Inc.
Manufacturer	Ubiquiti Inc.
Brand Name	UniFi
Model Number	U6-Enterprise-IW
FCC ID	SWX-U6EPIW
ISED ID	6545A-U6EPIW

On this 8th day of June 2022, I individually and for Unified Compliance Laboratory certify that the statements made in this engineering report are true, complete and correct to the best of my knowledge and are made in good faith.

Although NVLAP has accredited the Unified Compliance Laboratory testing facilities, this report must not be used to claim product certification, approval, or endorsement by NVLAP, NIST or any agency of the U.S. federal government.

Unified Compliance Laboratory



Written By: Joseph W. Jackson



Reviewed By:

Revision History		
Revision	Description	Date
01	Original Report Release	16 May 2022
02	Added test setup info to CBP section and statement on RU's	8 June 2022
03	Added EIRP column	10 June 2022

Table of Contents

1	Client Information.....	5
1.1	Applicant.....	5
1.2	Manufacturer.....	5
2	Equipment Under Test (EUT).....	6
2.1	Identification of EUT	6
2.2	Description of EUT	6
2.3	EUT and Support Equipment.....	6
2.4	Interface Ports on EUT	7
2.5	Operating Environment.....	7
2.6	Operating Modes.....	7
2.7	EUT Exercise Software.....	7
2.8	Block Diagram of Test Configuration	8
2.9	Modification Incorporated/Special Accessories on EUT.....	8
2.10	Deviation, Opinions Additional Information or Interpretations from Test Standard.....	8
3	Test Specification, Method and Procedures.....	9
3.1	Test Specification.....	9
3.2	Methods & Procedures.....	9
3.3	FCC Part 15, Subpart E.....	9
3.4	Results.....	9
3.5	Test Location	10
4	Test Equipment	11
4.1	Conducted Emissions at Mains Ports.....	11
4.2	Direct Connect at the Antenna Port Tests.....	12
4.3	Radiated Emissions.....	13
4.4	Contention Based Protocol.....	14
4.5	Equipment Calibration	15
4.6	Measurement Uncertainty.....	15
5	Test Results	16
5.1	§15.203 Antenna Requirements.....	16
5.2	Conducted Emissions at Mains Ports Data	16
5.3	§15.403(i) 26 dB Emissions Bandwidth	18
5.4	§15.407(a)(3) Maximum Average Output Power	19
5.5	§15.407(b)(7) Spurious Emissions.....	20
5.6	§15.407(a) Maximum Power Spectral Density.....	26
5.7	§15.407(d) Contention Based Protocol.....	27

1 Client Information

1.1 Applicant

Company	Ubiquiti Inc. 685 Third Avenue New York, NY 10017 U.S.A.
Contact Name	Mark Feil
Title	Compliance Manager

1.2 Manufacturer

Company	Ubiquiti Inc. 685 Third Avenue New York, NY 10017 U.S.A.
Contact Name	Mark Feil
Title	Compliance Manager

2 Equipment Under Test (EUT)

2.1 Identification of EUT

Brand Name	UniFi
Model Number	U6-Enterprise-IW
Serial Number	68D79A0505E9
Dimensions (cm)	16.0 x 15.7 x 3.4

2.2 Description of EUT

The U6-Enterprise-IW is an in-wall mounted access point with four-stream WiFi 6 that provides up to 5.3+ Gbps aggregate throughput rate. The U6-Enterprise-IW has 2.4 GHz (2x2), 5 GHz (4x4) and 6 GHz (4x4) transmitters. The U6-Enterprise-IW has an Ethernet port for data transfer and is powered by an 802.3at PoE Power Adapter. The U6-Enterprise-IW has a Bluetooth management radio to achieve setup and operation. The U6-Enterprise-IW is designed for indoor use.

This report covers the circuitry of the device subject to FCC Part 15, Subpart E. The circuitry of the device subject to FCC Part 15 Subpart B was found to be compliant and is covered under a separate Unified Compliance Laboratory test report.

The table below show the channels used within the different modulation bandwidths.

Band	Modulation Bandwidth	Frequency (MHz)	Maximum Power Setting
UNII-8	ax (HE20)	6895	TP24
		7015, 7115	TP26
	ax (HE40)	6925, 7005	TP30
		7095	TP31
	ax (HE80)	6945	TP37
		7025	TP38
ax (HE160)	6985	TP41	

2.3 EUT and Support Equipment

The EUT and support equipment used during the test are listed below.

Brand Name Model Number Serial Number	Description	Name of Interface Ports / Interface Cables
BN: UniFi MN: U6-Enterprise-IW (Note 1) SN: 68D79A0505E9	WiFi Access Point	See Section 2.4

BN: Ubiquiti MN: UPOE-at SN: N/A	PoE Power Adapter	Shielded or Un-Shielded Cat 5e cable (Note 2)
BN: Dell MN: XPS 13 SN: N/A	Laptop Personal Computer	Shielded or Un-Shielded Cat 5e cable (Note 2)

Notes: (1) EUT

(2) Interface port connected to EUT (See Section 2.4)

The support equipment listed above was not modified in order to achieve compliance with this standard.

2.4 Interface Ports on EUT

Name of Ports	No. of Ports Fitted to EUT	Cable Description/Length
PoE	1	Shielded or Un-Shielded Cat 5e Cable/> 3 Meters
Data	1	Shielded or Un-Shielded Cat 5e Cable/> 3 Meters

2.5 Operating Environment

Power Supply	120 Volts ac to 48 Volts PoE Power
AC Mains Frequency	60 Hz
Temperature	22.1 – 22.9 °C
Humidity	16.9 – 30.4 %
Barometric Pressure	1007 mBar

2.6 Operating Modes

The U6-Enterprise-IW was tested using test software in order to enable to constant transmission. The measurements within this report are corrected to reference a 100% duty cycle. All emission modes of 802.11ax were investigated. All measurements are reported with the worst-case mode (802.11ax) unless otherwise stated.

2.7 EUT Exercise Software

EUT firmware version 1.0 was used to operate the transmitter using a constant transmit mode.

2.8 Block Diagram of Test Configuration

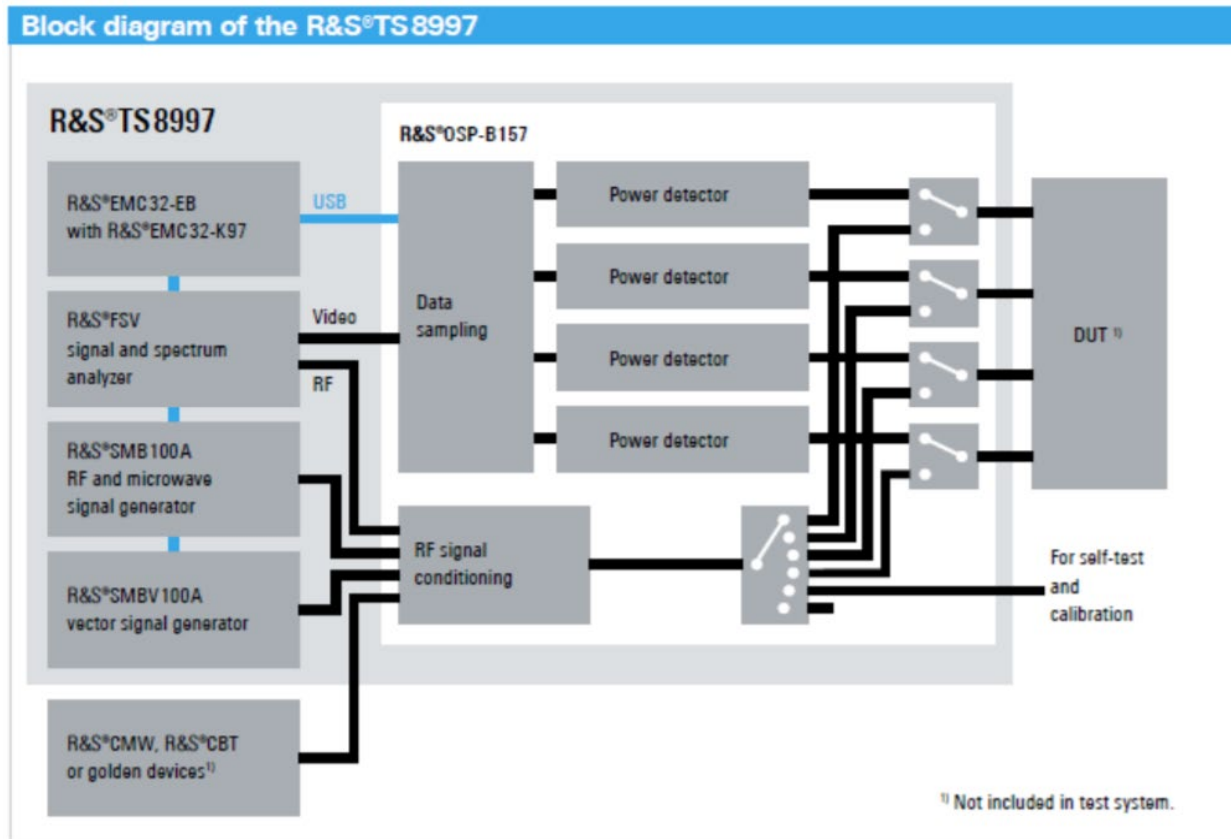

Diagram 1: Test Configuration Block Diagram

2.9 Modification Incorporated/Special Accessories on EUT

There were no modifications made to the EUT during testing to comply with the specification.

2.10 Deviation, Opinions Additional Information or Interpretations from Test Standard

There were no deviations, opinions, additional information or interpretations from the test specification.

3 Test Specification, Method and Procedures

3.1 Test Specification

Title	47 CFR FCC Part 15, Subpart E, Section 15.407 Limits and methods of measurement of radio interference characteristics of Unlicensed National Information Infrastructure Devices
Purpose of Test	The tests were performed to demonstrate initial compliance

3.2 Methods & Procedures

3.2.1 47 CFR FCC Part 15 Section 15.407

See test standard for details.

3.3 FCC Part 15, Subpart E

3.3.1 Summary of Tests

FCC Section	ISED Section	Environmental Phenomena	Frequency Range (MHZ)	Result
15.203	N/A	Antenna requirements	Structural Requirement	Compliant
15.207	RSS-Gen	Conducted Disturbance at Mains Port	0.15 to 30	Compliant
15.407(c)	RSS-247 §6.2.2, §6.2.3	Bandwidth Requirement	6875 to 7115	Compliant
15.407(e)	RSS-247 §6.2.2, §6.2.3	Peak Output Power ¹	6875 to 7115	Compliant
15.407(f)	RSS-247 §6.2.2, §6.2.3	Antenna Conducted Spurious Emissions ¹	0.009 to 40000	N/A
15.407(g)	RSS-247 §6.2.2, §6.2.3	Radiated Spurious Emissions	0.009 to 40000	Compliant
15.407(h)	RSS-247 §6.2.2, §6.2.3	Peak Power Spectral Density ¹	6875 to 7115	Compliant
15.407(d)	RSS-247 §6.2.2, §6.2.3	Contention Based Protocol	6875 to 7115	Compliant

The testing was performed according to the procedures in ANSI C63.10-2013, KDB 789033, KDB 987594 and 47 CFR Part 15. Where applicable, KDB 662911 was followed to sum required measurements.

Note ¹: Various RU modes were considered for RF Power, PSD, and Spurious Emissions, and the "single client" RU mode is the worst case - the results herein are "single client" RU mode.

3.4 Results

In the configuration tested, the EUT complied with the requirements of the specification.

3.5 Test Location

Testing was performed at the Unified Compliance Laboratory 3-Meter and 10-Meter chambers located at 427 West 12800 South, Draper, UT 84020. Unified Compliance Laboratory is accredited by National Voluntary Laboratory Accreditation Program (NVLAP); NVLAP Code 600241-0 which is effective until 30 June 2022. This site has also been registered with Innovations, Science and Economic Development (ISED) department as was accepted under Appendix B, Phase 1 procedures of the APEC Tel MRA for Canadian recognition. ISED No.: 25346, effective until 30 June 2022. Unified Compliance Laboratory has been assigned Conformity Assessment Number US0223 by ISED.

4 Test Equipment

4.1 Conducted Emissions at Mains Ports

Type of Equipment	Manufacturer	Model Number	Asset Number	Date of Last Calibration	Due Date of Calibration
EMI Receiver	AFJ	FFT3010	UCL-6754	12/8/2021	12/8/2022
LISN	AFJ	LS16C/10	UCL-6749	12/6/2021	12/6/2023
Cat6 ISN	Teseq	ISN T8-Cat6	UCL-2971	5/18/2020	5/18/2022
ISN	Teseq	ISN T800	UCL-2974	6/4/2021	6/4/2022
LISN	Com-Power	LIN-120C	UCL-2612	1/6/2022	1/6/2023
AC Power Source	Laplace Instruments	AC1000A	UCL-2857	N/A	N/A
Test Software	UCL	Revision 1	UCL-3107	N/A	N/A

Table 1: List of equipment used for Conducted Emissions Testing at Mains Port

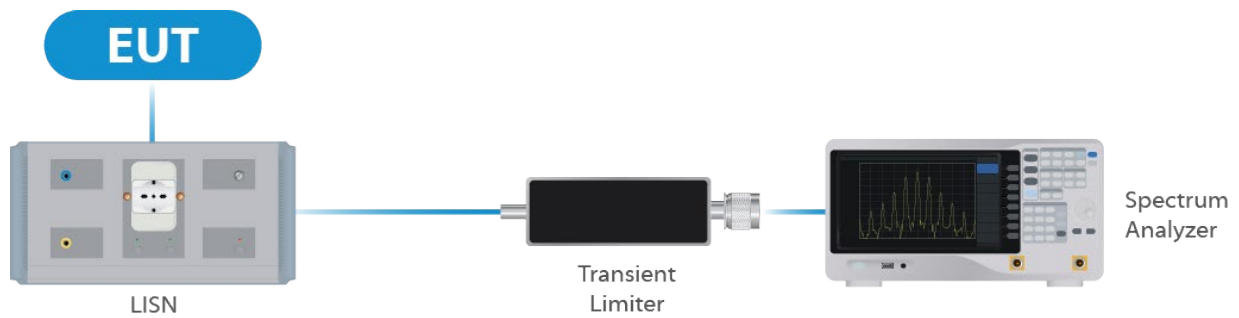

Figure 1: Conducted Emissions Test

4.2 Direct Connect at the Antenna Port Tests

Type of Equipment	Manufacturer	Model Number	Asset Number	Date of Last Calibration	Due Date of Calibration
Spectrum Analyzer	R&S	FSV40	UCL-2861	1/03/2022	1/03/2023
Signal Generator	R&S	SMB100A	UCL-2864	N/A	N/A
Vector Signal Generator	R&S	SMBV100A	UCL-2873	N/A	N/A
Switch Extension	R&S	OSP-B157WX	UCL-2867	1/03/2022	1/03/2023
Switch Extension	R&S	OSP-150W	UCL-2870	1/03/2022	1/03/2023

Table 2: List of equipment used for Direct Connect at the Antenna Port

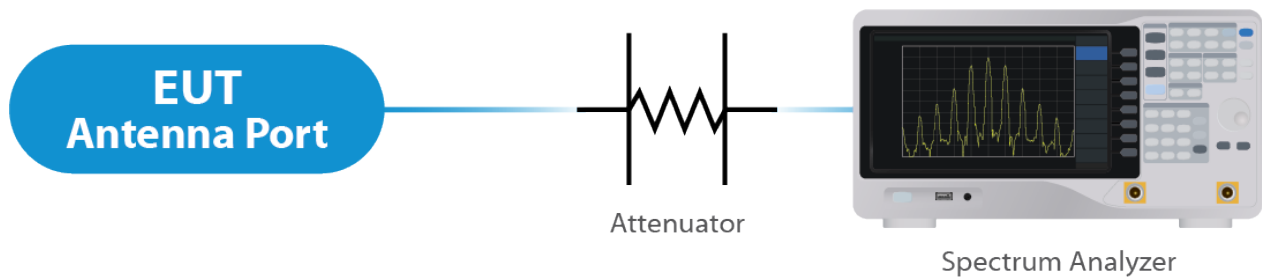

Figure 2: Direct Connect at the Antenna Port Test

4.3 Radiated Emissions

Type of Equipment	Manufacturer	Model Number	Asset Number	Date of Last Calibration	Due Date of Calibration
EMI Receiver	Keysight	N9038A	UCL-2778	6/21/2021	6/21/2022
Pre-Amplifier 9 kHz – 1 GHz	Sonoma Instruments	310N	UCL-2889	10/7/2021	10/7/2022
Broadband Antenna	Scwarzbeck	VULB 9163	UCL-3062	8/28/2020	8/27/2022
Broadband Antenna	Scwarzbeck	VULB 9163	UCL-3071	5/19/2020	5/19/2022
Double Ridge Horn Antenna	Scwarzbeck	BBHA 9120D	UCL-3065	7/8/2021	7/8/2022
Log Periodic	Scwarzbeck	STLP 9129	UCL-3068	11/16/2020	11/16/2022
15 - 40 GHz Horn Antenna	Scwarzbeck	BBHA 9170	UCL-2487	5/21/2020	5/21/2022
1 – 18 GHz Amplifier	Com-Power	PAM 118A	UCL-3833	10/7/2021	10/7/2022
Test Software	UCL	Revision 1	UCL-3108	N/A	N/A

Table 3: List of equipment used for Radiated Emissions

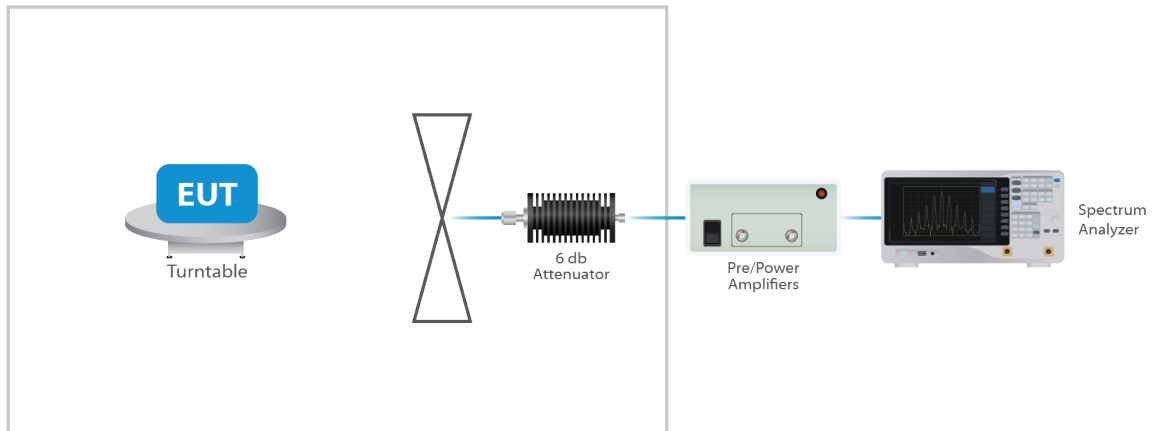

Figure 3: Radiated Emissions Test

4.4 Contention Based Protocol

Type of Equipment	Manufacturer	Model Number	Asset Number	Date of Last Calibration	Due Date of Calibration
Signal Generator	Keysight	MXG-B	UCL-6291	7/3/2021	7/3/2022
Spectrum Analyzer	Keysight	N9010B	UCL-7069	4/25/2022	4/25/2023
Splitter	Pasternack	PE2031	UCL-7203	Verify Before Use	Verify Before Use
Splitter	Mini-Circuits	ZN2PD-9G-S+	UCL-7025	Verify Before Use	Verify Before Use

Table 4: List of equipment used for Radiated Emissions

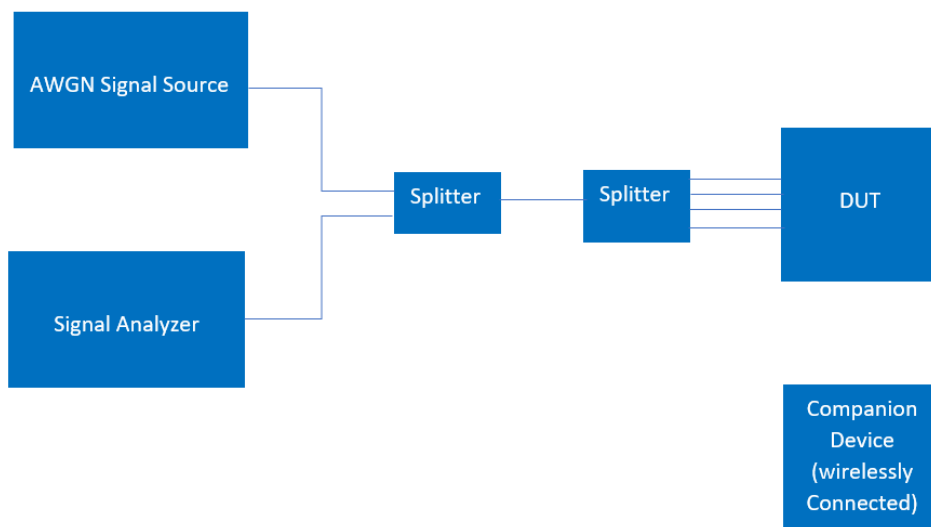

Figure 4: Contention Based Protocol Test

4.5 Equipment Calibration

All applicable equipment is calibrated using either an independent calibration laboratory or Unified Compliance Laboratory personnel at intervals defined in ANSI C63.4:2014 following outlined calibration procedures. All measurement instrumentation is traceable to the National Institute of Standards and Technology (NIST). Supporting documentation relative to traceability is on file and is available for examination upon request.

4.6 Measurement Uncertainty

Test	Uncertainty (\pm dB)	Confidence (%)
Conducted Emissions	1.44	95
Radiated Emissions (9 kHz to 30 MHz)	2.50	95
Radiated Emissions (30 MHz to 1 GHz)	4.38	95
Radiated Emissions (1 GHz to 18 GHz)	4.37	95
Radiated Emissions (18 GHz to 40 GHz)	3.93	95
Direct Connect Tests	K Factor	Value
Emissions Bandwidth	2	2.0%
Output Power	2	1.0 dB
Peak Power Spectral Density	2	1.3 dB
Band Edge	2	0.8 dB
Transmitter Spurious Emissions	2	1.8 dB

5 Test Results

5.1 §15.203 Antenna Requirements

The EUT uses an integral folding antenna structure. The Maximum gain of the antenna per chain is 5.8 dBi. This is an 802.11 device and utilizes CDD as described in KDB 662911 D01. The antenna is not user replaceable.

For power measurements on IEEE 802.11 devices, Array Gain = 0 dB for $NANT \leq 4$;

For PSD measurements when $Nss=1$: Array Gain = $10 \log(NANT/NSS)$ dB = 6.02 dB

Results

The EUT complied with the specification

5.2 Conducted Emissions at Mains Ports Data

5.2.1 Line

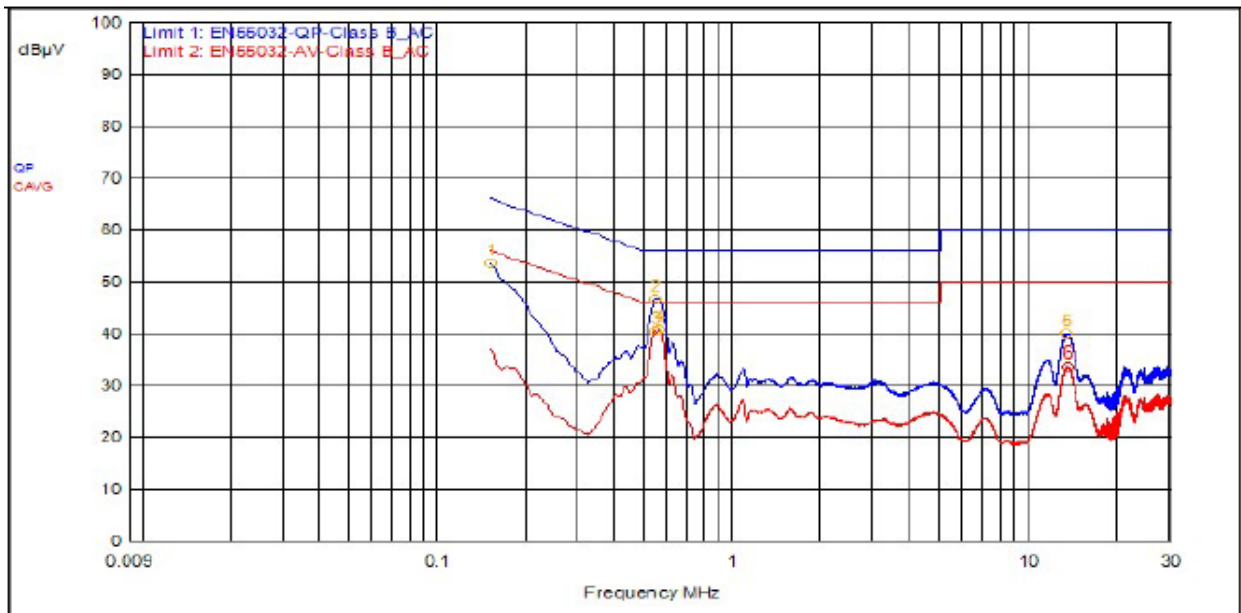

ID	Frequency	Probe	Cable	Atten.	Detector	Meter Read	Meas Level	Limit 1	Limit 1 Dist.	Limit 2	Limit 2 Dist.
2	543,000kHz	9.5	0.1		QPeak	37.1	46.7	56.0	-9.3		
1	150,000kHz	9.5	0.0		QPeak	44.2	53.7	66.0	-12.3		
5	13.161MHz	9.6	0.3		QPeak	30.0	39.9	60.0	-20.1		
3	540,000kHz	9.5	0.1		C_AVG	30.8	40.5			46.0	-5.5
4	558,000kHz	9.5	0.1		C_AVG	31.0	40.7			46.0	-5.3
6	13.260MHz	9.6	0.3		C_AVG	23.6	33.5			50.0	-16.5

5.2.2 Neutral

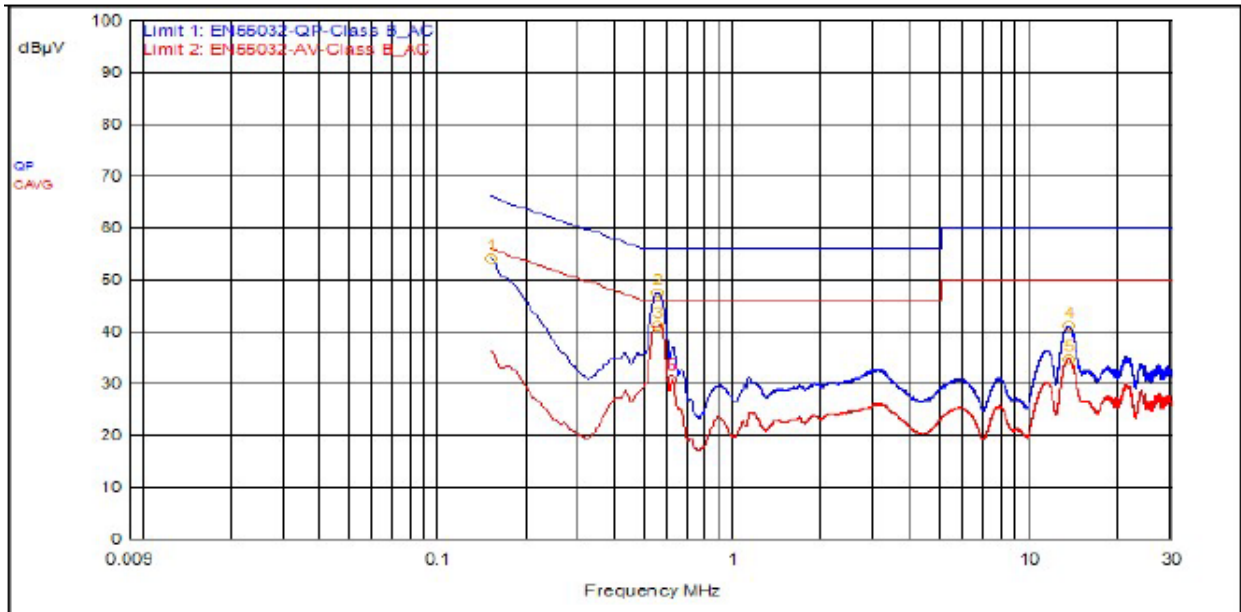

ID	Frequency	Probe	Cable	Atten.	Detector	Meter Read	Meas Level	Limit 1	Limit 1 Dist.	Limit 2	Limit 2 Dist.
2	549,000kHz	9.5	0.1		QPeak	37.9	47.5	56.0	-8.5		
1	150,000kHz	9.5	0.0		QPeak	44.6	54.1	66.0	-11.9		
4	13.266MHz	9.6	0.3		QPeak	31.1	41.0	60.0	-19.0		
3	549,000kHz	9.5	0.1		C_AVG	31.5	41.2			46.0	-4.8
5	13.260MHz	9.6	0.3		C_AVG	24.9	34.8			50.0	-15.2
6	612,000kHz	9.5	0.2		C_AVG	21.0	30.7			46.0	-15.3

Result

The EUT complied with the specification limit.

5.3 §15.403(i) 26 dB Emissions Bandwidth

All chains were measured under the guidance of KDB 789033 Section II.C. and KDB 66291 D01. Please see associated annex for details on instrument settings.

Nominal BW (MHz)	Frequency (MHz)	99% Bandwidth (MHz)	26 dB Bandwidth (MHz)
20	6895	19.2	21.5
20	7015	19.1	21.7
20	7115	19.1	21.9
40	6925	38.0	40.4
40	7005	37.8	40.2
40	7085	36.3	39.8
80	6945	75.5	82.5
80	7025	75.5	82.5
160	6985	156.0	164.0

Result

All chains were tested and the highest bandwidth per chain is reported above.

The 26 dB bandwidths are reported for information purposes. Please see Annex for all bandwidth measurements.

5.4 §15.407(a)(3) Maximum Average Output Power

All chains were measured and summed under the guidance of KDB 789033 Section II. E.2. and KDB 66291 D01. Please see associated annex for details on instrument settings.

The maximum average RF conducted output power measured for this device was 23.22 dBm or 209.89 mW. The maximum EIRP is 29.02 dBm or 797.99 mW. The limit is 30 dBm EIRP, or 1 Watt EIRP. The antenna has a gain of 5.8 dBi.

Modulation (BW)	Frequency (MHz)	Data Rate	TP Setting	Conducted Output Power *	EIRP	Measured PSD
HE20	6895	Mcs0_Nss4	24	15.13	20.93	-1.31
HE20	7015	Mcs0_Nss4	26	15.47	21.27	-0.98
HE20	7115	Mcs0_Nss4	26	14.65	20.45	-1.29
HE40	6925	Mcs0_Nss4	30	18.17	23.97	-1.05
HE40	7005	Mcs0_Nss4	30	17.83	23.63	-1.31
HE40	7085	Mcs0_Nss4	31	17.56	23.36	-1.16
HE80	6945	Mcs0_Nss4	37	21.08	26.88	-0.96
HE80	7025	Mcs0_Nss4	38	21.17	26.97	-0.88
HE160	6985	Mcs0_Nss4	41	23.22	29.02	-1.25

Modulation (BW)	Frequency (MHz)	Data Rate	TP Setting	Conducted Output Power *	EIRP	Measured PSD
HE20	6895	Mcs0_Nss1	12	9.30	15.1	-6.95
HE20	7015	Mcs0_Nss1	12	8.82	14.62	-7.32
HE20	7115	Mcs0_Nss1	13	8.24	14.04	-7.36
HE40	6925	Mcs0_Nss1	19	12.28	18.08	-6.97
HE40	7005	Mcs0_Nss1	19	12.00	17.8	-7.19
HE40	7085	Mcs0_Nss1	19	11.53	17.33	-7.31
HE80	6945	Mcs0_Nss1	25	15.03	20.83	-7.04
HE80	7025	Mcs0_Nss1	25	14.59	20.39	-7.39
HE160	6985	Mcs0_Nss1	29	17.22	23.02	-7.34

Result

In the configuration tested, the maximum average RF outpower was less than 1 watt EIRP; therefore, the EUT complied with the requirements of the specification (see spectrum analyzer plots in attached Annex).

5.5 §15.407(b)(7) Spurious Emissions

5.5.1 Conducted Spurious Emissions

The frequency range from the lowest frequency generated or used in the device to the tenth harmonic of the highest fundamental frequency was investigated to measure any antenna-conducted emissions. The graphs show the measurement data from spurious emissions noted across the frequency range when transmitting at the lowest frequency, middle frequency and upper frequency. Shown below are plots with the EUT turned to the upper and lower channels with the antenna gain of 5.8 dBi accounted for. These demonstrate compliance with the provisions of this section at the band edges.

The emissions must be remain below -27 dBm EIRP.

Result

Conducted spurious emissions were attenuated below the limit; therefore, the EUT complies with the specification.

5.5.2 Radiated Spurious Emissions in the Restricted Bands of § 15.205

The EUT uses various power settings based on the channel in use. In order to reduce test time, the radiated spurious emissions at the lowest, middle, and highest channel were measured at the maximum power of TP41.

Correction Factor = Antenna Factor + Cable Loss - Pre-Amplifier Gain, and is added to the Receiver reading.

Result

All emissions in the restricted bands of § 15.205 met the limits specified in § 15.209; therefore, the EUT complies with the specification. See Annex for Conducted Band edge plots.

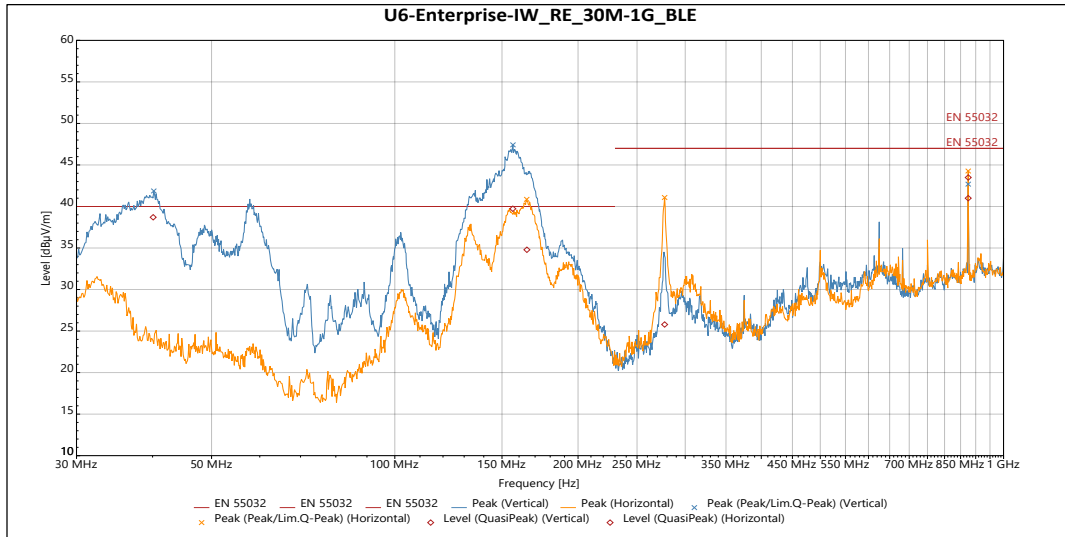

QuasiPeak

Frequency	Level (dBµV/m)	Limit (dBµV/m)	Margin	Azimuth (°)	Height	Pol.	Correction (dB)
40.093 MHz	38.695	40	-1.305	323	1.134	Vertical	-6.283
156.27 MHz	39.728	40	-0.272	183	1	Vertical	-12.25
875 MHz	41.003	47	-5.997	207	1.858	Vertical	2.897
164.82 MHz	34.788	40	-5.212	186	2.602	Horizontal	-11.693
277.52 MHz	25.79	47	-21.21	66	3.292	Horizontal	-7.248
875.02 MHz	43.49	47	-3.51	97	2.246	Horizontal	2.897

Table 5: Radiated Emissions 30 – 1000 MHz

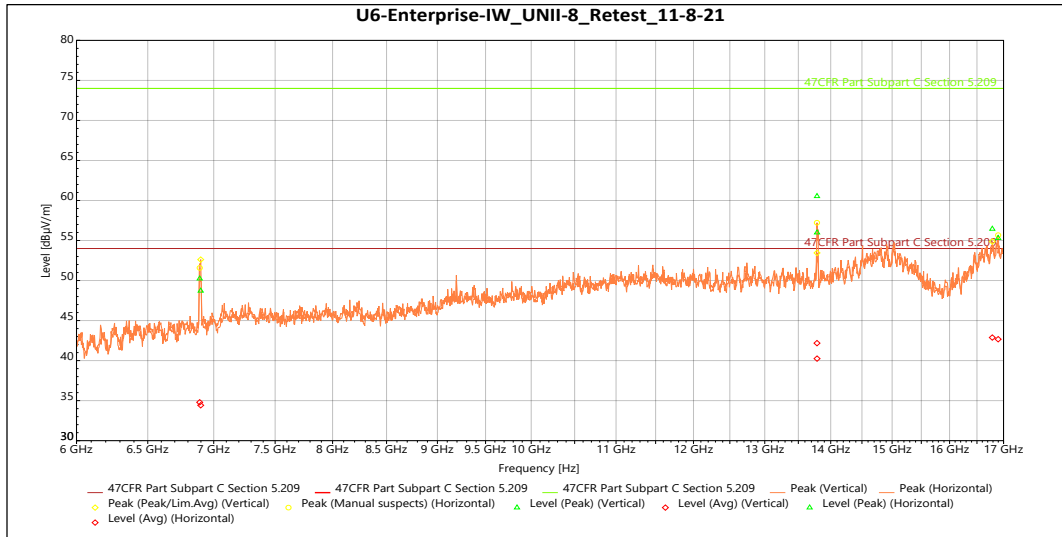

Peak

Frequency	Level (dBµV/m)	Limit (dBµV/m)	Margin (dB)	Azimuth (°)	Height (m)	Pol.	Correction (dB)
6.8984 GHz	48.718	74	-25.282	313	3.793	Vertical	-3.942
13.787 GHz	55.994	74	-18.006	298	3.793	Vertical	5.308
16.787 GHz	56.449	74	-17.551	53	3.798	Vertical	11.591
6.8906 GHz	50.244	74	-23.756	31	3.157	Horizontal	-3.99
13.786 GHz	60.53	74	-13.47	302	3.302	Horizontal	5.297
16.898 GHz	55.299	74	-18.701	357	3.793	Horizontal	11.865

Avg

Frequency	Level (dBµV/m)	Limit (dBµV/m)	Margin (dB)	Azimuth (°)	Height (m)	Pol.	Correction (dB)
6.8984 GHz	34.416	54	-19.584	313	3.793	Vertical	-3.942
13.787 GHz	40.252	54	-13.748	298	3.793	Vertical	5.308
16.787 GHz	42.882	54	-11.118	53	3.798	Vertical	11.591
6.8906 GHz	34.789	54	-19.211	31	3.157	Horizontal	-3.99
13.786 GHz	42.182	54	-11.818	302	3.302	Horizontal	5.297
16.898 GHz	42.673	54	-11.327	357	3.793	Horizontal	11.865

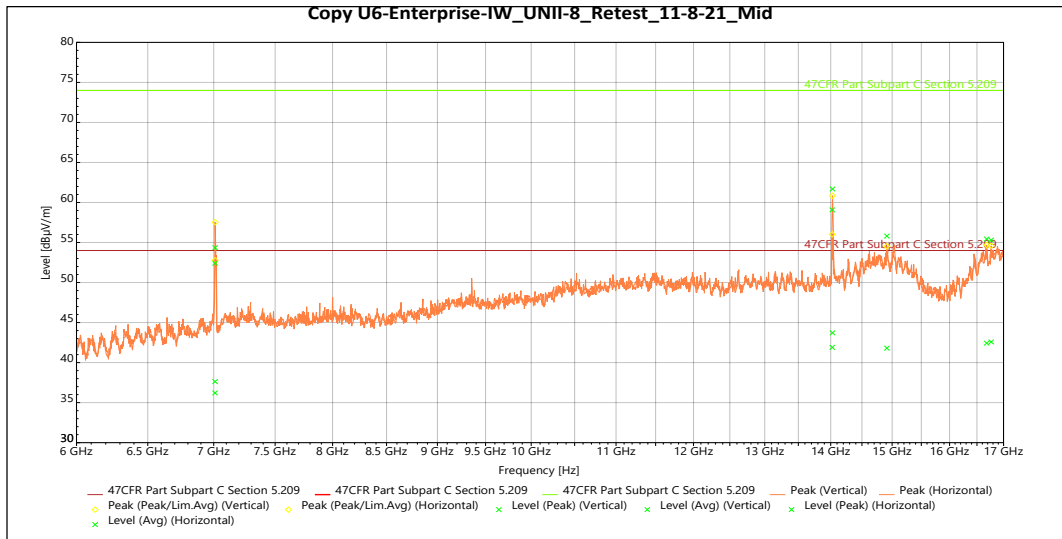
Table 6: Radiated Emissions on the Lowest Frequency 6895 MHz 1 – 17 GHz



Peak

Frequency	Level (dBµV/m)	Limit (dBµV/m)	Margin (dB)	Azimuth (°)	Height (m)	Pol.	Correction (dB)
7.0108 GHz	54.352	74	-19.648	15	1.5	Vertical	-3.502
14.024 GHz	59.079	74	-14.921	312	3.162	Vertical	5.743
16.681 GHz	55.44	74	-18.56	154	3.793	Vertical	11.313
7.0106 GHz	52.414	74	-21.586	25	3.776	Horizontal	-3.498
14.028 GHz	61.688	74	-12.312	300	3.281	Horizontal	5.76
14.912 GHz	55.796	74	-18.204	45	2.299	Horizontal	9.975
16.766 GHz	55.301	74	-18.699	207	2.173	Horizontal	11.546

Avg

Frequency	Level (dBµV/m)	Limit (dBµV/m)	Margin (dB)	Azimuth (°)	Height (m)	Pol.	Correction (dB)
7.0108 GHz	37.633	54	-16.367	15	1.5	Vertical	-3.502
14.024 GHz	41.896	54	-12.104	312	3.162	Vertical	5.743
16.681 GHz	42.43	54	-11.57	154	3.793	Vertical	11.313
7.0106 GHz	36.213	54	-17.787	25	3.776	Horizontal	-3.498
14.028 GHz	43.721	54	-10.279	300	3.281	Horizontal	5.76
14.912 GHz	41.803	54	-12.197	45	2.299	Horizontal	9.975
16.766 GHz	42.582	54	-11.418	207	2.173	Horizontal	11.546

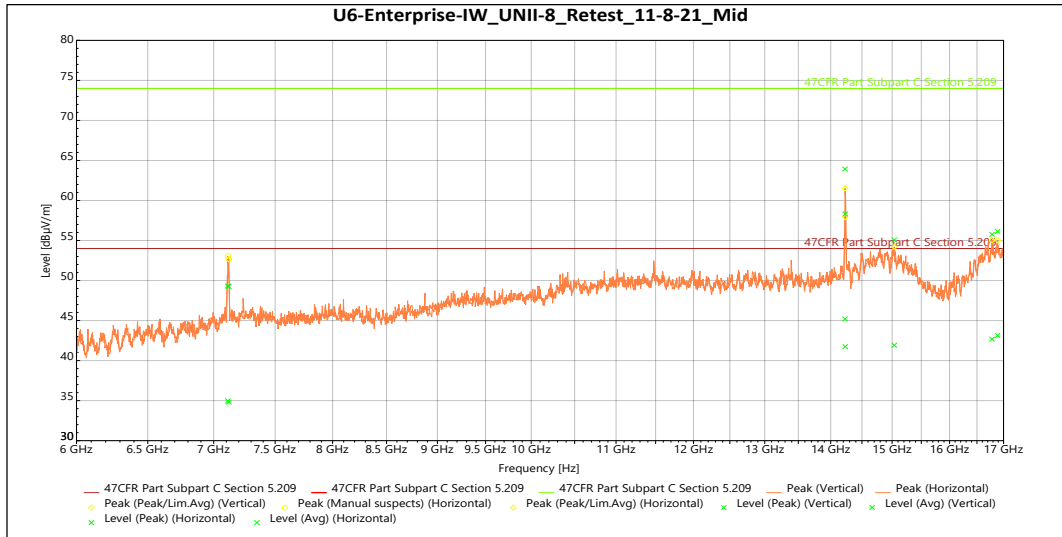
Table 7: Radiated Emissions on the Middle Frequency 7015 MHz 1 – 17 GHz



Peak

Frequency	Level (dBµV/m)	Limit (dBµV/m)	Margin (dB)	Azimuth (°)	Height (m)	Pol.	Correction (dB)
7.1196 GHz	49.256	74	-24.744	27	1.5	Vertical	-2.126
14.231 GHz	58.321	74	-15.679	354	2.659	Vertical	6.004
15.037 GHz	55.067	74	-18.933	32	1.647	Vertical	9.741
16.888 GHz	56.142	74	-17.858	40	1.643	Vertical	12.03
7.1119 GHz	49.321	74	-24.679	350	2.807	Horizontal	-2.08
14.227 GHz	63.929	74	-10.071	319	2.808	Horizontal	5.785
16.782 GHz	55.755	74	-18.245	30	3.294	Horizontal	11.581

Avg

Frequency	Level (dBµV/m)	Limit (dBµV/m)	Margin (dB)	Azimuth (°)	Height (m)	Pol.	Correction (dB)
7.1196 GHz	34.829	54	-19.171	27	1.5	Vertical	-2.126
14.231 GHz	41.737	54	-12.263	354	2.659	Vertical	6.004
15.037 GHz	41.922	54	-12.078	32	1.647	Vertical	9.741
16.888 GHz	43.128	54	-10.872	40	1.643	Vertical	12.03
7.1119 GHz	34.969	54	-19.031	350	2.807	Horizontal	-2.08
14.227 GHz	45.206	54	-8.794	319	2.808	Horizontal	5.785
16.782 GHz	42.677	54	-11.323	30	3.294	Horizontal	11.581

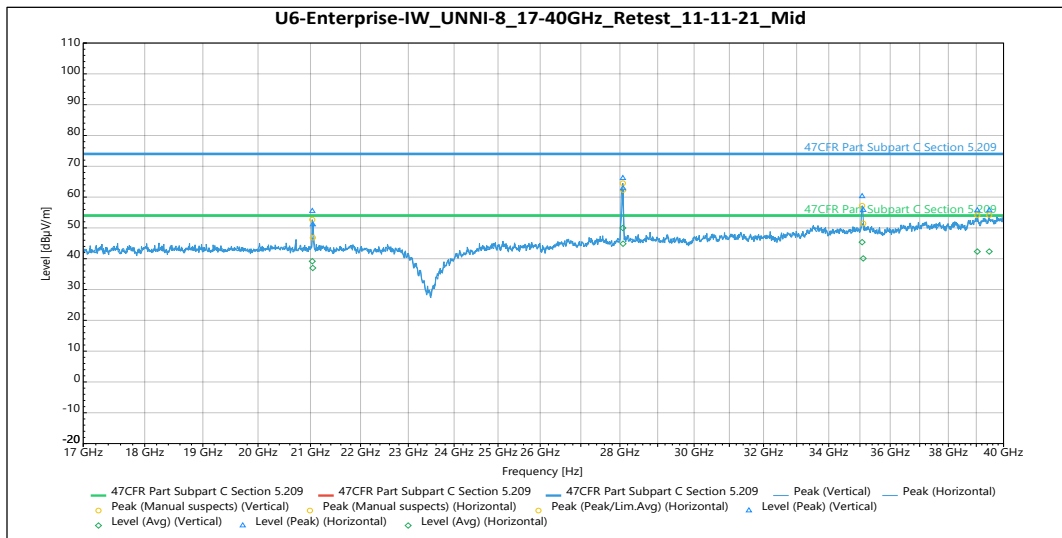
Table 8: Radiated Emissions on the Highest Frequency 7115 MHz 1 – 17 GHz

Peak

Frequency	Level (dBµV/m)	Limit (dBµV/m)	Margin (dB)	Azimuth (°)	Pol.	Correction (dB)
21.035 GHz	55.465	74	-18.535	353	Vertical	-5.701
28.077 GHz	66.135	74	-7.865	264	Vertical	-5.402
35.072 GHz	60.248	74	-13.752	276	Vertical	1.235
39.037 GHz	55.676	74	-18.324	189	Vertical	3.23
21.045 GHz	51.088	74	-22.912	295	Horizontal	-5.655
28.082 GHz	62.823	74	-11.177	288	Horizontal	-5.372
35.108 GHz	55.769	74	-18.231	322	Horizontal	1.084
39.473 GHz	55.668	74	-18.332	236	Horizontal	3.247

Avg

Frequency	Level (dBµV/m)	Limit (dBµV/m)	Margin (dB)	Azimuth (°)	Pol.	Correction (dB)
21.035 GHz	39.171	54	-14.829	353	Vertical	-5.701
28.077 GHz	49.966	54	-4.034	264	Vertical	-5.402
35.072 GHz	45.371	54	-8.629	276	Vertical	1.235
39.037 GHz	42.325	54	-11.675	189	Vertical	3.23
21.045 GHz	36.994	54	-17.006	295	Horizontal	-5.655
28.082 GHz	44.865	54	-9.135	288	Horizontal	-5.372
35.108 GHz	40.09	54	-13.91	322	Horizontal	1.084
39.473 GHz	42.326	54	-11.674	236	Horizontal	3.247

Table 9: Radiated Emissions on the Middle Frequency 7015 MHz 17 – 40 GHz (worse case)

5.6 §15.407(a) Maximum Power Spectral Density

All chains were measured and summed under the guidance of KDB 789033 Section II. F. and KDB 66291 D01. Please see associated annex for details on instrument settings.

The maximum average power spectral density conducted from the intentional radiator of the antenna shall not be greater than 5 dBm EIRP in any 1 MHz band during any time interval of continuous transmission. As per KDB 662911, When the EUT is using spatial-multiplexing in HE modes, there is not additional array gain to accommodate. When the EUT uses Nss=1 data rates, the antenna gain is 5.8 dBi + Array gain of 6.02 dB which is a total of 11.02 dBi. Results of this testing are summarized.

Modulation (BW)	Frequency (MHz)	Data Rate	TP Setting	Conducted Output Power *	Measured PSD
HE20	6895	Mcs0_Nss4	24	15.13	-1.31
HE20	7015	Mcs0_Nss4	26	15.47	-0.98
HE20	7115	Mcs0_Nss4	26	14.65	-1.29
HE40	6925	Mcs0_Nss4	30	18.17	-1.05
HE40	7005	Mcs0_Nss4	30	17.83	-1.31
HE40	7085	Mcs0_Nss4	31	17.56	-1.16
HE80	6945	Mcs0_Nss4	37	21.08	-0.96
HE80	7025	Mcs0_Nss4	38	21.17	-0.88
HE160	6985	Mcs0_Nss4	41	23.22	-1.25

Modulation (BW)	Frequency (MHz)	Data Rate	TP Setting	Conducted Output Power *	Measured PSD
HE20	6895	Mcs0_Nss1	12	9.30	-6.95
HE20	7015	Mcs0_Nss1	12	8.82	-7.32
HE20	7115	Mcs0_Nss1	13	8.24	-7.36
HE40	6925	Mcs0_Nss1	19	12.28	-6.97
HE40	7005	Mcs0_Nss1	19	12.00	-7.19
HE40	7085	Mcs0_Nss1	19	11.53	-7.31
HE80	6945	Mcs0_Nss1	25	15.03	-7.04
HE80	7025	Mcs0_Nss1	25	14.59	-7.39
HE160	6985	Mcs0_Nss1	29	17.22	-7.34

Result

The maximum average power spectral density was less than the limit of 5 dBm EIRP; therefore, the EUT complies with the specification.

5.7 §15.407(d) Contention Based Protocol

This product was tested and found to be compliant with the requirements of Contention-based Protocol as specified in FCC Part 15.407 and KDB 987594 D02.

Initially the test setup was connected directly to the signal source with all splitters (splitters terminated with a 50-ohm loads on unused ports) and cables in place to verify the AWGN signal is 10MHz wide at a signal level of less than or equal to -82dBm. The level at the signal generator required to achieve the required signal level at the DUT was recorded for use during testing.

The DUT was connected as shown in figure 4 above and set to transmit at a constant duty cycle at each frequency and bandwidth noted in the table below and verified to be communicating with the companion device as intended.

Starting at the levels established above, the AWGN signal was introduced to the DUT and increased to determine a threshold level at where the DUT will terminate with at least a 90% detection rate. The level at the DUT, which the 90% detection rate was achieved was recorded as the “Sensitivity Level” below.

Testing shall be repeated at each applicable channel and bandwidth as noted in Table 1 of KDB 987594 D02.

Start Level (Sig. Gen. Output)	Start Level (at EUT)
-58	< -82
Threshold Level (Sig. Gen. Output)	Threshold Level (at EUT)
-38	-62

Table 10: Level Details

Device Frequency (MHz)	Interference Signal Frequency (MHz)	Sensitivity Level (dbm)	Sensitivity Requirement (dbm)	Trial #										Detection Rate (%)
				1	2	3	4	5	6	7	8	9	10	
Bandwidth: 20M MHz				1	2	3	4	5	6	7	8	9	10	
6115	6115	-80.4	-62	X	X	X	X	X	X	X	X	X	X	100
6435	6435	-79.93	-62	X	X	X	X	X	X	X	X	X	X	100
6535	6535	-80.61	-62	X	X	X	X	X	X	X	X	X	X	100
6895	6895	-70.94	-62	X	X	X	X	X	X	X	X	X	X	100
Bandwidth: 160 MHz				1	2	3	4	5	6	7	8	9	10	
6185	6115	-73.13	-62	X	X	X	X	No	X	X	X	X	X	90
6505	6435	-79.93	-62	X	X	X	X	X	X	X	X	X	X	100
6665	6595	-78.08	-62	X	X	X	X	X	X	X	X	X	X	100
6985	6915	-73.6	-62	X	X	X	X	X	X	No	X	X	X	90
6185	6185	-72.37	-62	X	X	X	X	X	X	X	X	X	X	100
6505	6505	-72.39	-62	X	X	X	X	X	X	X	X	X	X	100
6665	6665	-73.11	-62	X	X	X	X	X	X	X	X	X	X	100
6985	6985	-67.46	-62	X	X	No	X	X	X	X	X	X	X	90
6185	6255	-71.33	-62	X	X	X	X	X	X	X	X	X	X	100
6505	6575	-65.6	-62	X	X	X	X	X	X	No	X	X	X	90
6665	6735	-74.11	-62	X	X	X	X	X	X	X	X	X	X	100
6985	7055	-76.22	-62	X	X	X	X	X	X	X	No	X	X	90

Table 11: Trial Table.

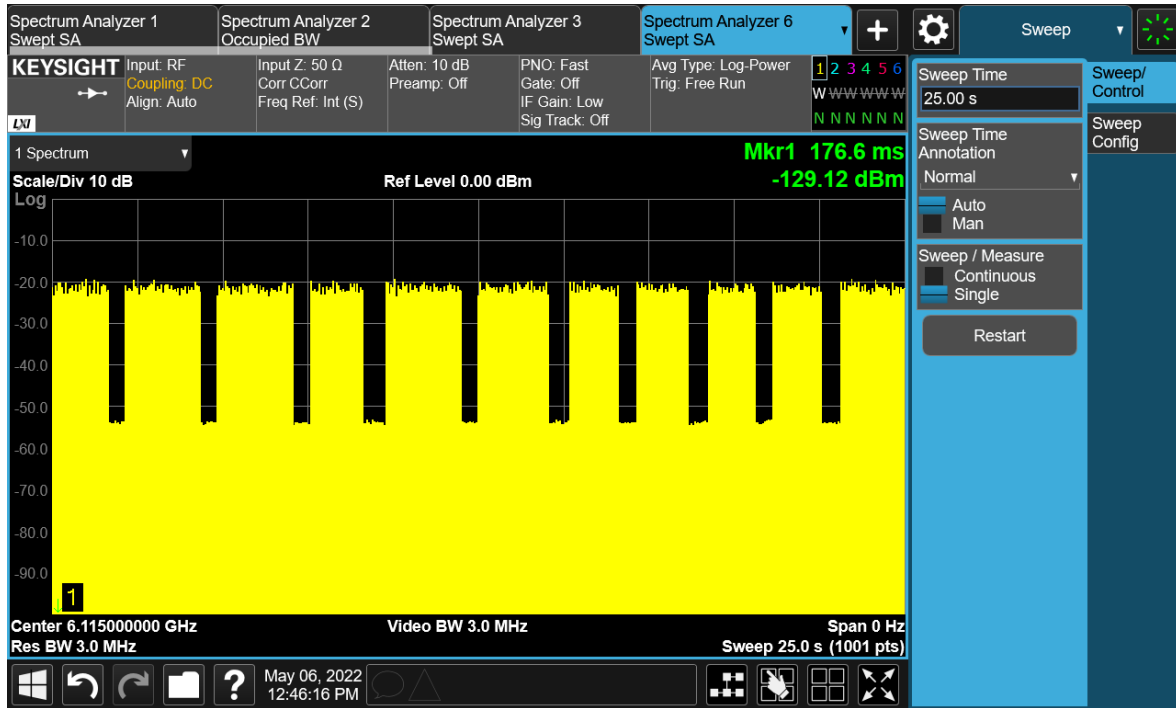

Plot 1: 20MHz Example Detection Trace

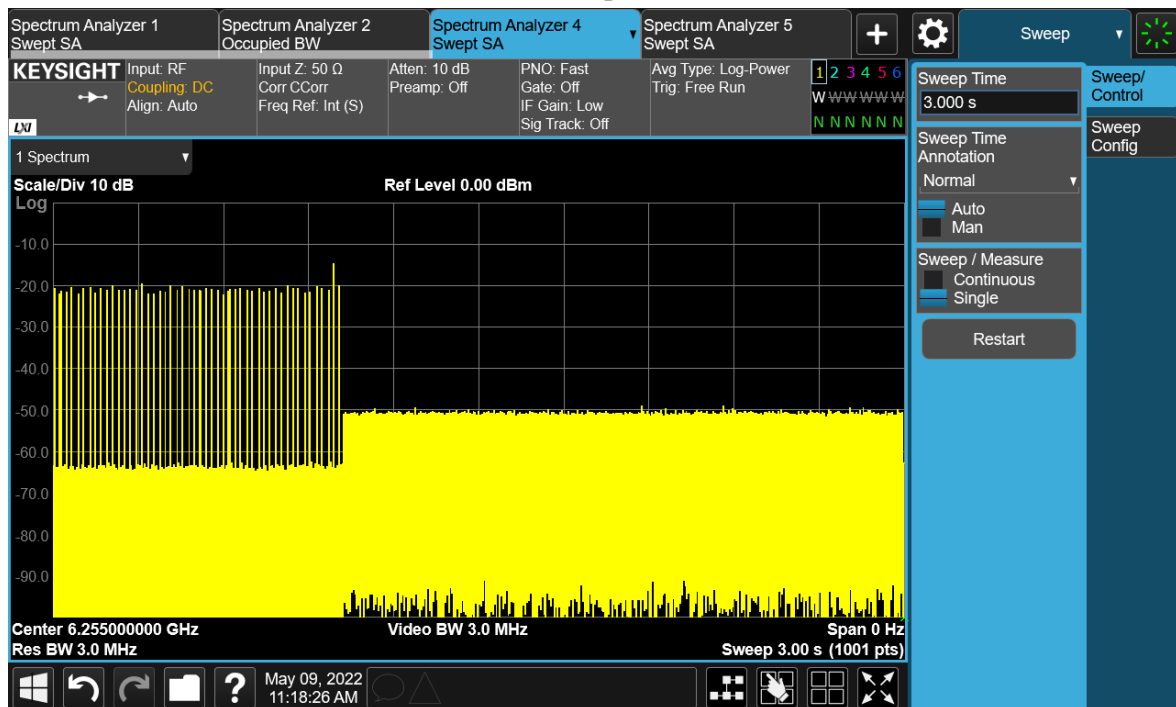

Plot 2: 160MHz Example Detection Trace

Result

The EUT complies with the specification.

-- End of Test Report --