



427 West 12800 South
Draper, UT 84020

Test Report Certification

FCC ID	SWX-U6EPIW
ISED ID	6545A-U6EPIW
Equipment Under Test	U6-Enterprise-IW
Test Report Serial Number	TR7177_03
Date of Test(s)	9, 11, 12, 15 November 2021; 4 January and 6 May 2022
Report Issue Date	16 May 2022

Test Specification	Applicant
47 CFR FCC Part 15, Subpart E	Ubiquiti Inc. 685 Third Avenue New York, NY 10017 U.S.A.



NVLAP LAB CODE 600241-0

Certification of Engineering Report

This report has been prepared by Unified Compliance Laboratory (UCL) to document compliance of the device described below with the requirement of Federal Communication Commissions (FCC) Part 15, Subpart E. This report may be reproduced in full. Partial reproduction of this report may only be made with the written consent of the laboratory. The results in this report apply only to the sample tested.

Applicant	Ubiquiti Inc.
Manufacturer	Ubiquiti Inc.
Brand Name	UniFi
Model Number	U6-Enterprise-IW
FCC ID	SWX-U6EPIW
ISED ID	6545A-U6EPIW

On this 8th day of June 2022, I individually and for Unified Compliance Laboratory certify that the statements made in this engineering report are true, complete, and correct to the best of my knowledge and are made in good faith.

Although NVLAP has accredited the Unified Compliance Laboratory testing facilities, this report must not be used to claim product certification, approval, or endorsement by NVLAP, NIST or any agency of the U.S. federal government.

Unified Compliance Laboratory



Written By: Joseph W. Jackson



Reviewed By: Richard L. Winter

Revision History		
Revision	Description	Date
01	Original Report Release	16 May 2022
02	Added test setup info to CBP section and statement on RU's	8 June 2022
03	Added EIRP column	10 June 2022

Table of Contents

1	Client Information.....	5
1.1	Applicant.....	5
1.2	Manufacturer.....	5
2	Equipment Under Test (EUT).....	6
2.1	Identification of EUT	6
2.2	Description of EUT	6
2.3	EUT and Support Equipment.....	6
2.4	Interface Ports on EUT	7
2.5	Operating Environment.....	7
2.6	Operating Modes.....	7
2.7	EUT Exercise Software.....	7
2.8	Block Diagram of Test Configuration	8
2.9	Modification Incorporated/Special Accessories on EUT.....	8
2.10	Deviation, Opinions Additional Information or Interpretations from Test Standard.....	8
3	Test Specification, Method and Procedures.....	9
3.1	Test Specification.....	9
3.2	Methods & Procedures.....	9
3.3	FCC Part 15, Subpart E.....	9
3.4	Results.....	9
3.5	Test Location	10
4	Test Equipment	11
4.1	Conducted Emissions at Mains Ports.....	11
4.2	Direct Connect at the Antenna Port Tests.....	12
4.3	Radiated Emissions.....	13
4.4	Contention Based Protocol.....	14
4.5	Equipment Calibration	15
4.6	Measurement Uncertainty.....	15
5	Test Results	16
5.1	§15.203 Antenna Requirements.....	16
5.2	Conducted Emissions at Mains Ports Data	16
5.3	§15.403(i) 26 dB Emissions Bandwidth	18
5.4	§15.407(a)(3) Maximum Average Output Power	19
5.5	§15.407(b)(7) Spurious Emissions.....	20
5.6	§15.407(a) Maximum Power Spectral Density.....	26
5.7	§15.407(d) Contention Based Protocol.....	27

1 Client Information

1.1 Applicant

Company	Ubiquiti Inc. 685 Third Avenue New York, NY 10017 U.S.A.
Contact Name	Mark Feil
Title	Compliance Manager

1.2 Manufacturer

Company	Ubiquiti Inc. 685 Third Avenue New York, NY 10017 U.S.A.
Contact Name	Mark Feil
Title	Compliance Manager

2 Equipment Under Test (EUT)

2.1 Identification of EUT

Brand Name	UniFi
Model Number	U6-Enterprise-IW
Serial Number	68D79A0505E9
Dimensions (cm)	16.0 x 15.7 x 3.4

2.2 Description of EUT

The U6-Enterprise-IW is an in-wall mounted access point with four-stream WiFi 6 that provides up to 5.3+ Gbps aggregate throughput rate. The U6-Enterprise-IW has 2.4 GHz (2x2), 5 GHz (4x4) and 6 GHz (4x4) transmitters. The U6-Enterprise-IW has an Ethernet port for data transfer and is powered by an 802.3at PoE Power Adapter. The U6-Enterprise-IW has a Bluetooth management radio to achieve setup and operation. The U6-Enterprise-IW is designed for indoor use.

This report covers the circuitry of the device subject to FCC Part 15, Subpart E. The circuitry of the device subject to FCC Part 15 Subpart B was found to be compliant and is covered under a separate Unified Compliance Laboratory test report.

The table below show the channels used within the different modulation bandwidths.

Band	Modulation Bandwidth	Frequency (MHz)	Maximum Power Setting
UNII-6	ax (HE20)	6435, 6475, 6515	TP24
	ax (HE40)	6445, 6485	TP29
	ax (HE80)	6465	TP36
	ax (HE160)	6505	TP40

2.3 EUT and Support Equipment

The EUT and support equipment used during the test are listed below.

Brand Name Model Number Serial Number	Description	Name of Interface Ports / Interface Cables
BN: UniFi MN: U6-Enterprise-IW (Note 1) SN: 68D79A0505E9	WiFi Access Point	See Section 2.4
BN: Ubiquiti MN: UPOE-at SN: N/A	PoE Power Adapter	Shielded or Un-Shielded Cat 5e cable (Note 2)

BN: Dell MN: XPS 13 SN: N/A	Laptop Personal Computer	Shielded or Un-Shielded Cat 5e cable (Note 2)
-----------------------------------	--------------------------	---

Notes: (1) EUT

(2) Interface port connected to EUT (See Section 2.4)

The support equipment listed above was not modified in order to achieve compliance with this standard.

2.4 Interface Ports on EUT

Name of Ports	No. of Ports Fitted to EUT	Cable Description/Length
PoE	1	Shielded or Un-Shielded Cat 5e Cable/> 3 Meters
Data	1	Shielded or Un-Shielded Cat 5e Cable/> 3 Meters

2.5 Operating Environment

Power Supply	120 Volts ac to 48 Volts PoE Power
AC Mains Frequency	60 Hz
Temperature	22.1 – 23.2 °C
Humidity	16.9 – 30.7 %
Barometric Pressure	1011 mBar

2.6 Operating Modes

The U6-Enterprise-IW was tested using test software in order to enable to constant transmission. The measurements within this report are corrected to reference a 100% duty cycle. All emission modes of 802.11ax were investigated. All measurements are reported with the worst-case mode (802.11ax) unless otherwise stated.

2.7 EUT Exercise Software

EUT firmware version 1.0 was used to operate the transmitter using a constant transmit mode.

2.8 Block Diagram of Test Configuration

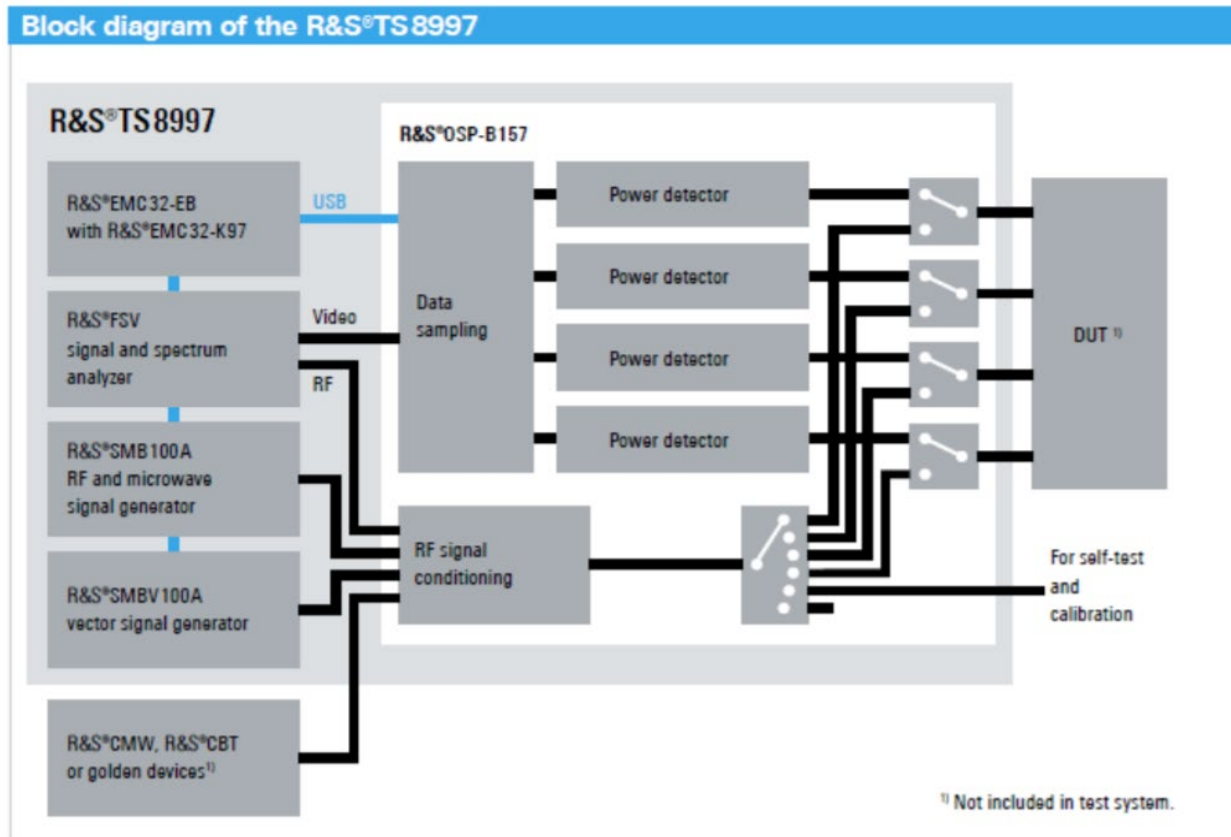

Diagram 1: Test Configuration Block Diagram

2.9 Modification Incorporated/Special Accessories on EUT

There were no modifications made to the EUT during testing to comply with the specification.

2.10 Deviation, Opinions Additional Information or Interpretations from Test Standard

There were no deviations, opinions, additional information or interpretations from the test specification.

3 Test Specification, Method and Procedures

3.1 Test Specification

Title	47 CFR FCC Part 15, Subpart E, Section 15.407 Limits and methods of measurement of radio interference characteristics of Unlicensed National Information Infrastructure Devices
Purpose of Test	The tests were performed to demonstrate initial compliance

3.2 Methods & Procedures

3.2.1 47 CFR FCC Part 15 Section 15.407

See test standard for details.

3.3 FCC Part 15, Subpart E

3.3.1 Summary of Tests

FCC Section	ISED Section	Environmental Phenomena	Frequency Range (MHZ)	Result
15.203	N/A	Antenna requirements	Structural Requirement	Compliant
15.207	RSS-Gen	Conducted Disturbance at Mains Port	0.15 to 30	Compliant
15.407(c)	RSS-247 §6.2.2, §6.2.3	Bandwidth Requirement	6435 to 6515	Compliant
15.407(e)	RSS-247 §6.2.2, §6.2.3	Peak Output Power ¹	6435 to 6515	Compliant
15.407(f)	RSS-247 §6.2.2, §6.2.3	Antenna Conducted Spurious Emissions ¹	0.009 to 40000	N/A
15.407(g)	RSS-247 §6.2.2, §6.2.3	Radiated Spurious Emissions	0.009 to 40000	Compliant
15.407(h)	RSS-247 §6.2.2, §6.2.3	Peak Power Spectral Density ¹	6435 to 6515	Compliant
15.407(d)	RSS-247 §6.2.2, §6.2.3	Contention Based Protocol	6435 to 6515	Compliant

The testing was performed according to the procedures in ANSI C63.10-2013, KDB 789033, KDB 987594 and 47 CFR Part 15. Where applicable, KDB 662911 was followed to sum required measurements.

Note ¹: Various RU modes were considered for RF Power, PSD, and Spurious Emissions, and the "single client" RU mode is the worst case - the results herein are "single client" RU mode.

3.4 Results

In the configuration tested, the EUT complied with the requirements of the specification.

3.5 Test Location

Testing was performed at the Unified Compliance Laboratory 3-Meter and 10-Meter# chambers located at 427 West 12800 South, Draper, UT 84020. Unified Compliance Laboratory is accredited by National Voluntary Laboratory Accreditation Program (NVLAP); NVLAP Code 600241-0 which is effective until 30 June 2022. This site has also been registered with Innovations, Science and Economic Development (ISED) department as was accepted under Appendix B, Phase 1 procedures of the APEC Tel MRA for Canadian recognition. ISED No.: 25346, effective until 30 June 2022. Unified Compliance Laboratory has been assigned Conformity Assessment Number US0223 by ISED.

4 Test Equipment

4.1 Conducted Emissions at Mains Ports

Type of Equipment	Manufacturer	Model Number	Asset Number	Date of Last Calibration	Due Date of Calibration
EMI Receiver	AFJ	FFT3010	UCL-6754	12/8/2021	12/8/2022
LISN	AFJ	LS16C/10	UCL-6749	12/6/2021	12/6/2023
Cat6 ISN	Teseq	ISN T8-Cat6	UCL-2971	5/18/2020	5/18/2022
ISN	Teseq	ISN T800	UCL-2974	6/4/2021	6/4/2022
LISN	Com-Power	LIN-120C	UCL-2612	1/6/2022	1/6/2023
AC Power Source	Laplace Instruments	AC1000A	UCL-2857	N/A	N/A
Test Software	UCL	Revision 1	UCL-3107	N/A	N/A

Table 1: List of equipment used for Conducted Emissions Testing at Mains Port

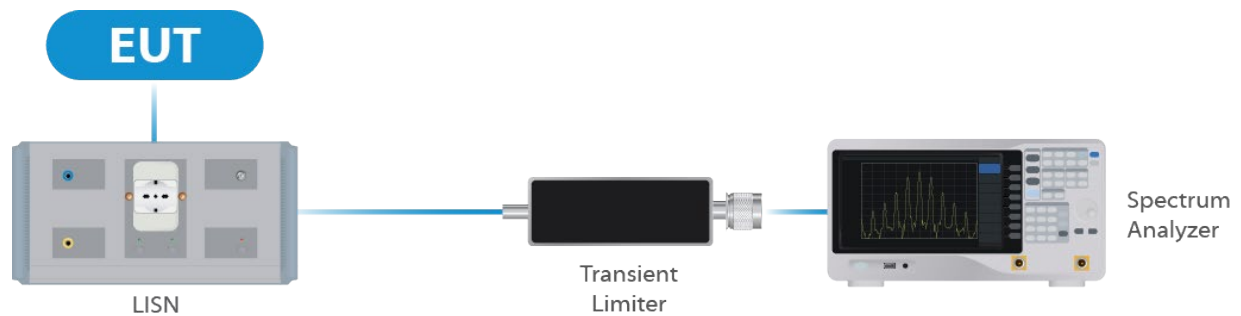

Figure 1: Conducted Emissions Test

4.2 Direct Connect at the Antenna Port Tests

Type of Equipment	Manufacturer	Model Number	Asset Number	Date of Last Calibration	Due Date of Calibration
Spectrum Analyzer	R&S	FSV40	UCL-2861	1/03/2022	1/03/2023
Signal Generator	R&S	SMB100A	UCL-2864	N/A	N/A
Vector Signal Generator	R&S	SMBV100A	UCL-2873	N/A	N/A
Switch Extension	R&S	OSP-B157WX	UCL-2867	1/03/2022	1/03/2023
Switch Extension	R&S	OSP-150W	UCL-2870	1/03/2022	1/03/2023

Table 2: List of equipment used for Direct Connect at the Antenna Port

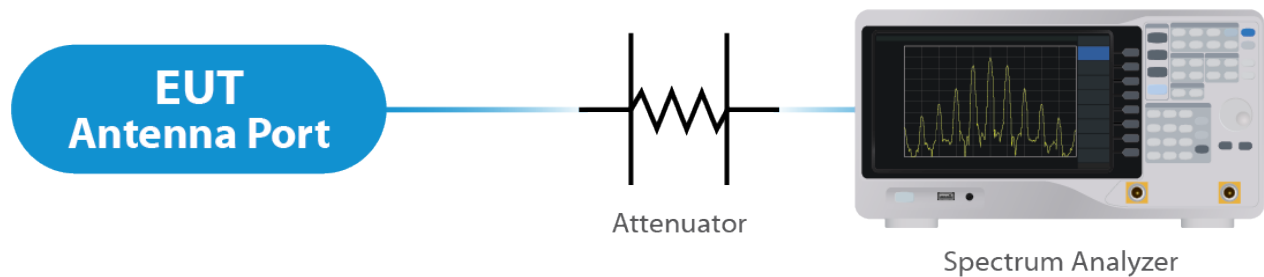

Figure 2: Direct Connect at the Antenna Port Test

4.3 Radiated Emissions

Type of Equipment	Manufacturer	Model Number	Asset Number	Date of Last Calibration	Due Date of Calibration
EMI Receiver	Keysight	N9038A	UCL-2778	6/21/2021	6/21/2022
Pre-Amplifier 9 kHz – 1 GHz	Sonoma Instruments	310N	UCL-2889	10/7/2021	10/7/2022
Broadband Antenna	Scwarzbeck	VULB 9163	UCL-3062	8/28/2020	8/27/2022
Broadband Antenna	Scwarzbeck	VULB 9163	UCL-3071	5/19/2020	5/19/2022
Double Ridge Horn Antenna	Scwarzbeck	BBHA 9120D	UCL-3065	7/8/2021	7/8/2022
Log Periodic	Scwarzbeck	STLP 9129	UCL-3068	11/16/2020	11/16/2022
15 - 40 GHz Horn Antenna	Scwarzbeck	BBHA 9170	UCL-2487	5/21/2020	5/21/2022
1 – 18 GHz Amplifier	Com-Power	PAM 118A	UCL-3833	10/7/2021	10/7/2022
Test Software	UCL	Revision 1	UCL-3108	N/A	N/A

Table 3: List of equipment used for Radiated Emissions

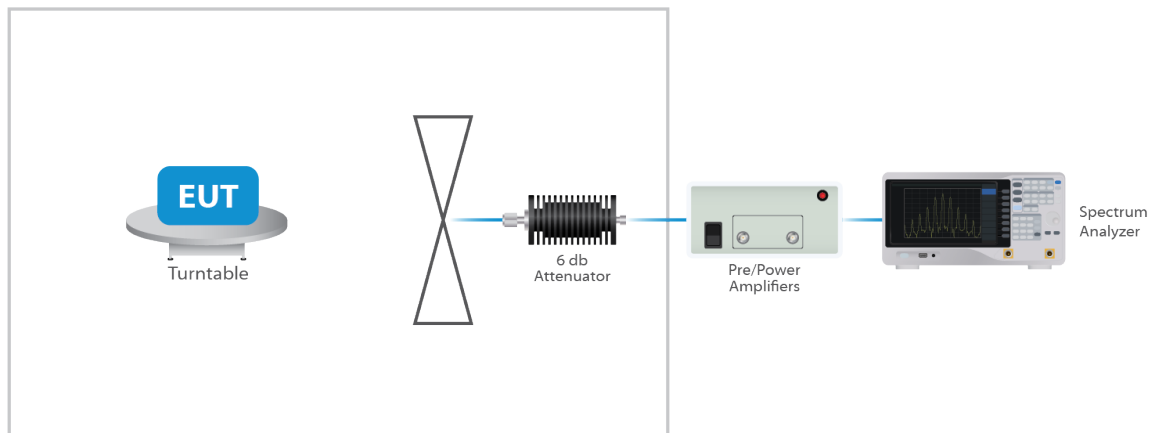

Figure 3: Radiated Emissions Test

4.4 Contention Based Protocol

Type of Equipment	Manufacturer	Model Number	Asset Number	Date of Last Calibration	Due Date of Calibration
Signal Generator	Keysight	MXG-B	UCL-6291	7/3/2021	7/3/2022
Spectrum Analyzer	Keysight	N9010B	UCL-7069	4/25/2022	4/25/2023
Splitter	Pasternack	PE2031	UCL-7203	Verify Before Use	Verify Before Use
Splitter	Mini-Circuits	ZN2PD-9G-S+	UCL-7025	Verify Before Use	Verify Before Use

Table 4: List of equipment used for Radiated Emissions

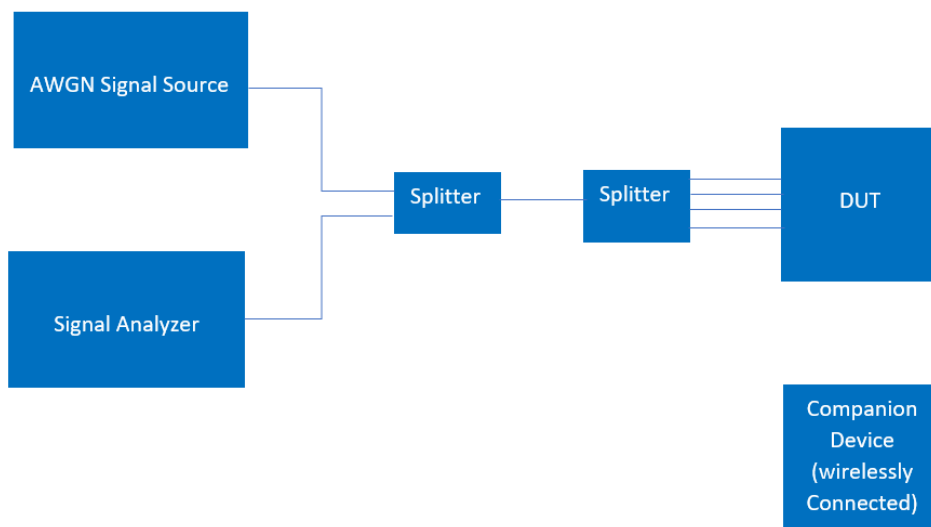

Figure 4: Contention Based Protocol Test

4.5 Equipment Calibration

All applicable equipment is calibrated using either an independent calibration laboratory or Unified Compliance Laboratory personnel at intervals defined in ANSI C63.4:2014 following outlined calibration procedures. All measurement instrumentation is traceable to the National Institute of Standards and Technology (NIST). Supporting documentation relative to traceability is on file and is available for examination upon request.

4.6 Measurement Uncertainty

Test	Uncertainty (\pm dB)	Confidence (%)
Conducted Emissions	1.44	95
Radiated Emissions (9 kHz to 30 MHz)	2.50	95
Radiated Emissions (30 MHz to 1 GHz)	4.38	95
Radiated Emissions (1 GHz to 18 GHz)	4.37	95
Radiated Emissions (18 GHz to 40 GHz)	3.93	95
Direct Connect Tests	K Factor	Value
Emissions Bandwidth	2	2.0%
Output Power	2	1.0 dB
Peak Power Spectral Density	2	1.3 dB
Band Edge	2	0.8 dB
Transmitter Spurious Emissions	2	1.8 dB

5 Test Results

5.1 §15.203 Antenna Requirements

The EUT uses an integral folding antenna structure. The Maximum gain of the antenna per chain is 5.8 dBi. This is an 802.11 device and utilizes CDD as described in KDB 662911 D01. The antenna is not user replaceable.

For power measurements on IEEE 802.11 devices, Array Gain = 0 dB for NANT ≤ 4;

For PSD measurements when Nss=1: Array Gain = 10 log(NANT/NSS) dB = 6.02dB

Results

The EUT complied with the specification

5.2 Conducted Emissions at Mains Ports Data

5.2.1 Line

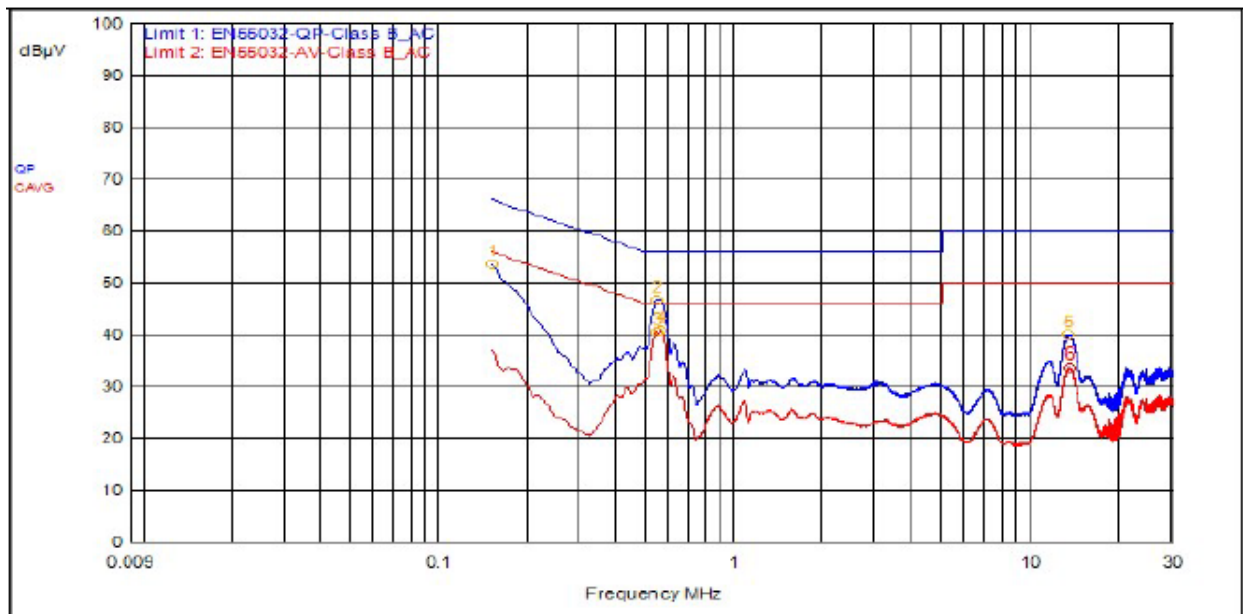

ID	Frequency	Probe	Cable	Atten.	Detector	Meter Read	Meas Level	Limit 1	Limit 1 Dist.	Limit 2	Limit 2 Dist.
2	543,000kHz	9.5	0.1		QPeak	37.1	46.7	56.0	-9.3		
1	150,000kHz	9.5	0.0		QPeak	44.2	53.7	66.0	-12.3		
5	13.161MHz	9.6	0.3		QPeak	30.0	39.9	60.0	-20.1		
3	540,000kHz	9.5	0.1		C_AVG	30.8	40.5			46.0	-5.5
4	558,000kHz	9.5	0.1		C_AVG	31.0	40.7			46.0	-5.3
6	13.260MHz	9.6	0.3		C_AVG	23.6	33.5			50.0	-16.5

5.2.2 Neutral

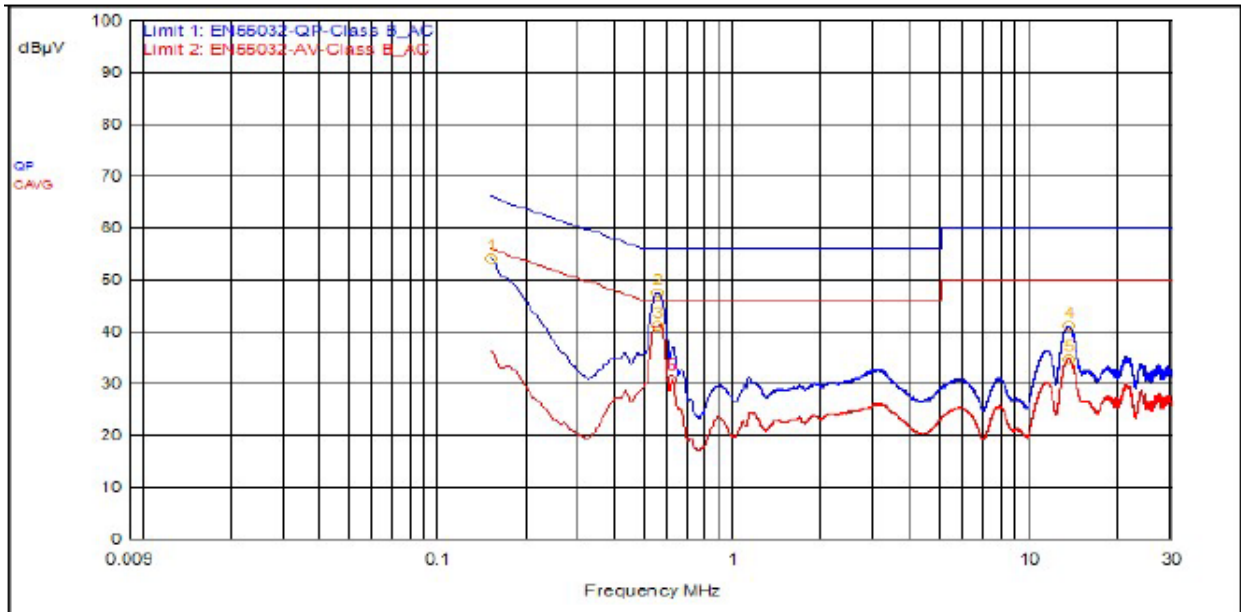

ID	Frequency	Probe	Cable	Atten.	Detector	Meter Read	Meas Level	Limit 1	Limit 1 Dist.	Limit 2	Limit 2 Dist.
2	549,000kHz	9.5	0.1		QPeak	37.9	47.5	56.0	-8.5		
1	150,000kHz	9.5	0.0		QPeak	44.6	54.1	66.0	-11.9		
4	13.266MHz	9.6	0.3		QPeak	31.1	41.0	60.0	-19.0		
3	549,000kHz	9.5	0.1		C_AVG	31.5	41.2			46.0	-4.8
5	13.260MHz	9.6	0.3		C_AVG	24.9	34.8			50.0	-15.2
6	612,000kHz	9.5	0.2		C_AVG	21.0	30.7			46.0	-15.3

Result

The EUT complied with the specification limit.

5.3 §15.403(i) 26 dB Emissions Bandwidth

All chains were measured under the guidance of KDB 789033 Section II.C. and KDB 66291 D01. Please see associated annex for details on instrument settings.

Nominal BW (MHz)	Frequency (MHz)	99% Bandwidth (MHz)	26 dB Bandwidth (MHz)
20	6435	17.8	21.1
20	6475	17.9	21.3
20	6515	17.8	20.8
40	6445	36.3	39.6
40	6485	36.3	39.3
80	6465	75.5	82.5
160	6505	155.0	166.0

Result

All chains were tested and the highest bandwidth per chain is reported above.

The 26 dB bandwidths are reported for information purposes. Please see Annex for all bandwidth measurements.

5.4 §15.407(a)(3) Maximum Average Output Power

All chains were measured and summed under the guidance of KDB 789033 Section II. E.2. and KDB 66291 D01. Please see associated annex for details on instrument settings.

The maximum average RF conducted output power measured for this device was 23.74 dBm or 236.59 mW. The maximum EIRP is 29.54 dBm or 899.49 mW. The limit is 30 dBm EIRP, or 1 Watt EIRP. The antenna has a gain of 5.8 dBi.

Modulation (BW)	Frequency (MHz)	Data Rate	TP Setting	Conducted Output Power	EIRP	Measured PSD
HE20	6435	Mcs0_Nss4	24	14.80	20.6	-1.21
HE20	6475	Mcs0_Nss4	24	15.00	20.8	-1.14
HE20	6515	Mcs0_Nss4	24	15.26	21.06	-1.04
HE40	6445	Mcs0_Nss4	28	17.88	23.68	-1.36
HE40	6485	Mcs0_Nss4	29	18.05	23.85	-1.33
HE80	6465	Mcs0_Nss4	36	21.20	27	-1.13
HE160	6505	Mcs0_Nss4	40	23.74	29.54	-1.19

Modulation (BW)	Frequency (MHz)	Data Rate	TP Setting	Conducted Output Power	EIRP	Measured PSD
HE20	6435	Mcs0_Nss1	12	14.17	19.97	-7.22
HE20	6475	Mcs0_Nss1	12	14.62	20.42	-7.31
HE20	6515	Mcs0_Nss1	12	15.15	20.95	-6.97
HE40	6445	Mcs0_Nss1	18	17.87	23.67	7.21
HE40	6485	Mcs0_Nss1	18	18.06	23.86	-7.09
HE80	6465	Mcs0_Nss1	24	21.02	26.82	-7.34
HE160	6505	Mcs0_Nss1	28	23.52	29.32	-7.06

Result

In the configuration tested, the maximum average RF outpower was less than 1 watt EIRP; therefore, the EUT complied with the requirements of the specification (see spectrum analyzer plots in attached Annex).

5.5 §15.407(b)(7) Spurious Emissions

5.5.1 Conducted Spurious Emissions

The frequency range from the lowest frequency generated or used in the device to the tenth harmonic of the highest fundamental frequency was investigated to measure any antenna-conducted emissions. The graphs show the measurement data from spurious emissions noted across the frequency range when transmitting at the lowest frequency, middle frequency and upper frequency. Shown below are plots with the EUT turned to the upper and lower channels with the antenna gain of 5.8 dBi accounted for. These demonstrate compliance with the provisions of this section at the band edges.

The emissions must be remain below -27 dBm EIRP.

Result

Conducted spurious emissions were attenuated below the limit; therefore, the EUT complies with the specification.

5.5.2 Radiated Spurious Emissions in the Restricted Bands of § 15.205

The EUT uses various power settings based on the channel in use. In order to reduce test time, the radiated spurious emissions at the lowest, middle, and highest channel were measured at the maximum power of TP40.

Correction Factor = Antenna Factor + Cable Loss - Pre-Amplifier Gain, and is added to the Receiver reading.

Result

All emissions in the restricted bands of § 15.205 met the limits specified in § 15.209; therefore, the EUT complies with the specification. See Annex for Conducted Band edge plots.

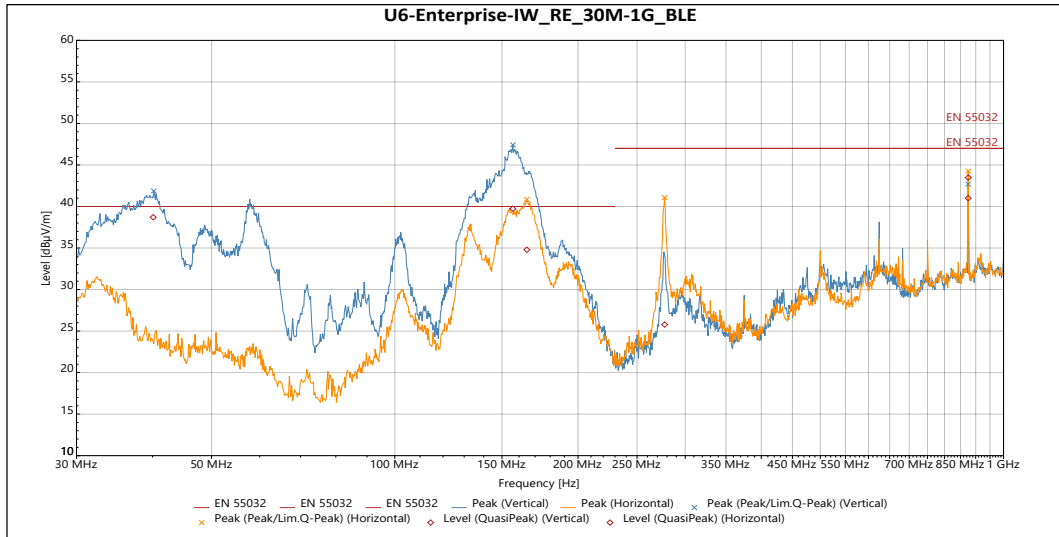

QuasiPeak

Frequency	Level (dBµV/m)	Limit (dBµV/m)	Margin	Azimuth (°)	Height	Pol.	Correction (dB)
40.093 MHz	38.695	40	-1.305	323	1.134	Vertical	-6.283
156.27 MHz	39.728	40	-0.272	183	1	Vertical	-12.25
875 MHz	41.003	47	-5.997	207	1.858	Vertical	2.897
164.82 MHz	34.788	40	-5.212	186	2.602	Horizontal	-11.693
277.52 MHz	25.79	47	-21.21	66	3.292	Horizontal	-7.248
875.02 MHz	43.49	47	-3.51	97	2.246	Horizontal	2.897

Table 5: Radiated Emissions 30 – 1000 MHz

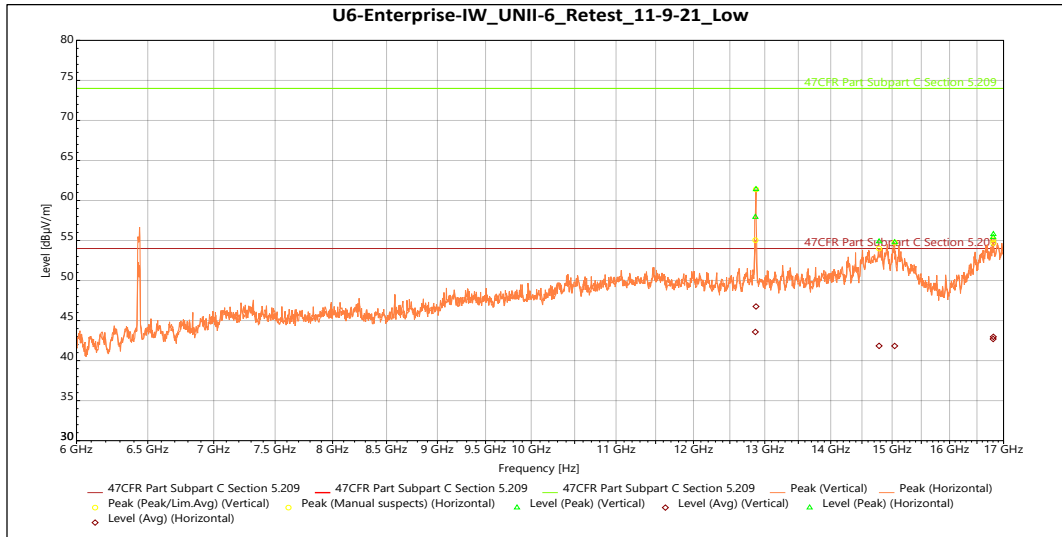

Peak

Frequency	Level (dBµV/m)	Limit (dBµV/m)	Margin (dB)	Azimuth (°)	Height (m)	Pol.	Correction (dB)
12.864 GHz	57.941	74	-16.059	241	2.65	Vertical	5.499
14.782 GHz	54.878	74	-19.122	132	3.662	Vertical	9.222
16.807 GHz	55.794	74	-18.206	326	1.5	Vertical	11.378
12.873 GHz	61.396	74	-12.604	329	2.32	Horizontal	5.244
15.043 GHz	54.773	74	-19.227	16	1.647	Horizontal	9.444
16.803 GHz	55.411	74	-18.589	212	2.654	Horizontal	11.444

Avg

Frequency	Level (dBµV/m)	Limit (dBµV/m)	Margin (dB)	Azimuth (°)	Height (m)	Pol.	Correction (dB)
12.864 GHz	43.582	54	-10.418	241	2.65	Vertical	5.499
14.782 GHz	41.843	54	-12.157	132	3.662	Vertical	9.222
16.807 GHz	42.974	54	-11.026	326	1.5	Vertical	11.378
12.873 GHz	46.761	54	-7.239	329	2.32	Horizontal	5.244
15.043 GHz	41.834	54	-12.166	16	1.647	Horizontal	9.444
16.803 GHz	42.696	54	-11.304	212	2.654	Horizontal	11.444

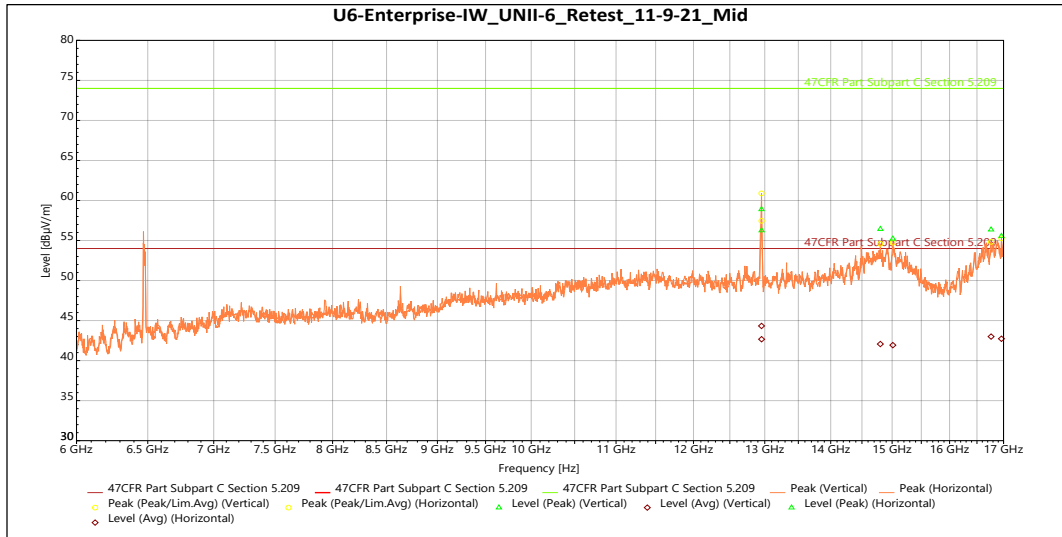
Table 6: Radiated Emissions Lowest Frequency 6435 MHz 1 – 17 GHz



Peak

Frequency	Level (dBµV/m)	Limit (dBµV/m)	Margin (dB)	Azimuth (°)	Height (m)	Pol.	Correction (dB)
12.954 GHz	56.257	74	-17.743	270	2.321	Vertical	5.981
14.803 GHz	56.431	74	-17.569	178	2.146	Vertical	9.506
16.96 GHz	55.564	74	-18.436	333	1.647	Vertical	11.098
12.953 GHz	58.898	74	-15.102	337	2.812	Horizontal	6.003
15.012 GHz	55.224	74	-18.776	353	3.798	Horizontal	9.873
16.764 GHz	56.359	74	-17.641	325	1.829	Horizontal	11.542

Avg

Frequency	Level (dBµV/m)	Limit (dBµV/m)	Margin (dB)	Azimuth (°)	Height (m)	Pol.	Correction (dB)
12.954 GHz	42.674	54	-11.326	270	2.321	Vertical	5.981
14.803 GHz	42.066	54	-11.934	178	2.146	Vertical	9.506
16.96 GHz	42.727	54	-11.273	333	1.647	Vertical	11.098
12.953 GHz	44.331	54	-9.669	337	2.812	Horizontal	6.003
15.012 GHz	41.927	54	-12.073	353	3.798	Horizontal	9.873
16.764 GHz	43.004	54	-10.996	325	1.829	Horizontal	11.542

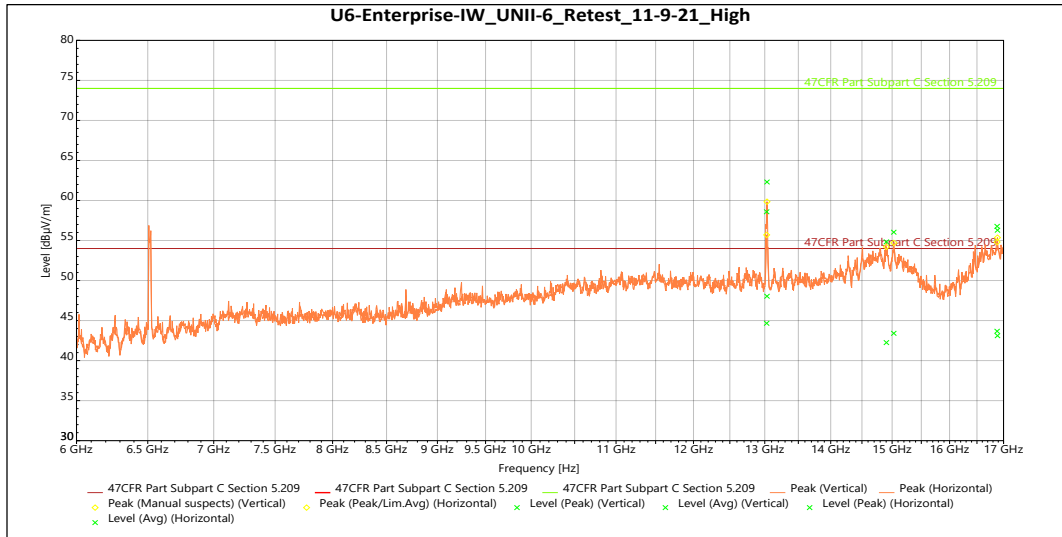
Table 7: Radiated Emissions Middle Frequency 6475 MHz 1 – 17 GHz



Peak

Frequency	Level (dBµV/m)	Limit (dBµV/m)	Margin (dB)	Azimuth (°)	Height (m)	Pol.	Correction (dB)
13.028 GHz	58.586	74	-15.414	216	3.798	Vertical	5.877
15.028 GHz	56.041	74	-17.959	66	1.829	Vertical	10.23
16.878 GHz	56.773	74	-17.227	21	4	Vertical	12.165
13.033 GHz	62.315	74	-11.685	334	1.5	Horizontal	5.902
14.904 GHz	54.825	74	-19.175	228	1.643	Horizontal	10.004
16.885 GHz	56.293	74	-17.707	319	4	Horizontal	12.07

Avg

Frequency	Level (dBµV/m)	Limit (dBµV/m)	Margin (dB)	Azimuth (°)	Height (m)	Pol.	Correction (dB)
13.028 GHz	44.659	54	-9.341	216	3.798	Vertical	5.877
15.028 GHz	43.406	54	-10.594	66	1.829	Vertical	10.23
16.878 GHz	43.669	54	-10.331	21	4	Vertical	12.165
13.033 GHz	48.043	54	-5.957	334	1.5	Horizontal	5.902
14.904 GHz	42.246	54	-11.754	228	1.643	Horizontal	10.004
16.885 GHz	43.113	54	-10.887	319	4	Horizontal	12.07

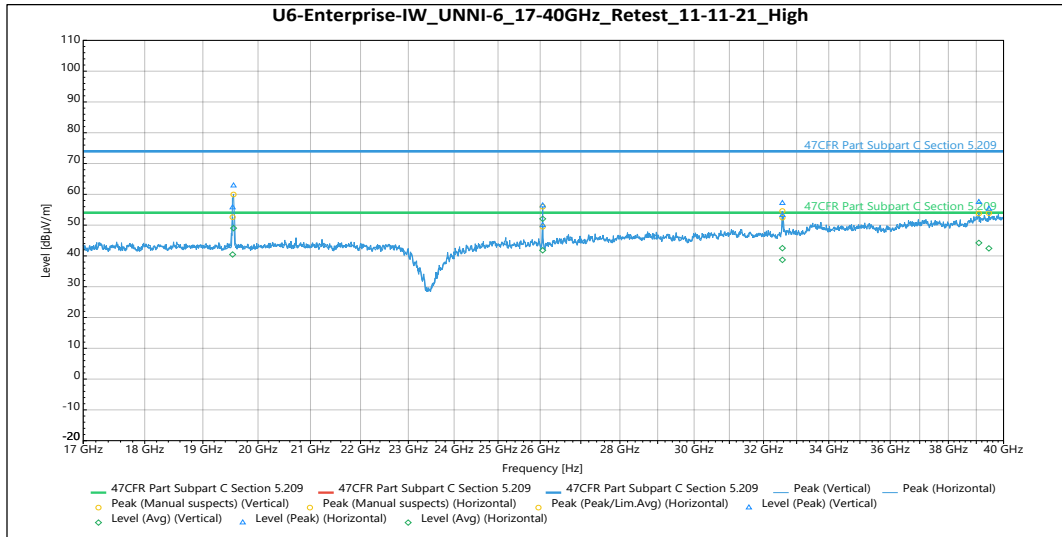
Table 8: Radiated Emissions Highest Frequency 6515 MHz 1 – 17 GHz

Peak

Frequency	Level (dBµV/m)	Limit (dBµV/m)	Margin (dB)	Azimuth (°)	Pol.	Correction (dB)
19.55 GHz	62.828	74	-11.172	280	Vertical	-6.17
26.06 GHz	56.359	74	-17.641	1	Vertical	-5.674
32.566 GHz	57.144	74	-16.856	279	Vertical	0.113
39.459 GHz	55.268	74	-18.732	59	Vertical	3.418
19.533 GHz	55.735	74	-18.265	319	Horizontal	-6.257
26.06 GHz	49.965	74	-24.035	315	Horizontal	-5.674
32.567 GHz	53.262	74	-20.738	288	Horizontal	0.104
39.093 GHz	57.451	74	-16.549	277	Horizontal	3.267

Avg

Frequency	Level (dBµV/m)	Limit (dBµV/m) (dBµV/m)	Margin (dB)	Azimuth (°)	Pol.	Correction (dB)
19.55 GHz	49.015	54	-4.985	280	Vertical	-6.17
26.06 GHz	52.053	54	-1.947	1	Vertical	-5.674
32.566 GHz	42.518	54	-11.482	279	Vertical	0.113
39.459 GHz	42.45	54	-11.55	59	Vertical	3.418
19.533 GHz	40.463	54	-13.537	319	Horizontal	-6.257
26.06 GHz	41.82	54	-12.18	315	Horizontal	-5.674
32.567 GHz	38.707	54	-15.293	288	Horizontal	0.104
39.093 GHz	44.234	54	-9.766	277	Horizontal	3.267

Table 9: Radiated Emissions Highest Frequency 6515 MHz 17 – 40 GHz (worse case)

5.6 §15.407(a) Maximum Power Spectral Density

All chains were measured and summed under the guidance of KDB 789033 Section II. F. and KDB 66291 D01. Please see associated annex for details on instrument settings.

The maximum average power spectral density conducted from the intentional radiator of the antenna shall not be greater than 5 dBm EIRP in any 1 MHz band during any time interval of continuous transmission. As per KDB 662911, When the EUT is using spatial-multiplexing in HE modes, there is not additional array gain to accommodate. When the EUT uses Nss=1 data rates, the antenna gain is 5.8 dBi + Array gain of 6.02 dB which is a total of 11.02 dBi

Results of this testing are summarized.

Modulation (BW)	Frequency (MHz)	Data Rate	TP Setting	Conducted Output Power	Measured PSD
HE20	6435	Mcs0_NSS4	24	14.80	-1.21
HE20	6475	Mcs0_NSS4	24	15.00	-1.14
HE20	6515	Mcs0_NSS4	24	15.26	-1.04
HE40	6445	Mcs0_NSS4	28	17.88	-1.36
HE40	6485	Mcs0_NSS4	29	18.05	-1.33
HE80	6465	Mcs0_NSS4	36	21.20	-1.13
HE160	6505	Mcs0_NSS4	40	23.74	-1.19

Modulation (BW)	Frequency (MHz)	Data Rate	TP Setting	Conducted Output Power	Measured PSD
HE20	6435	Mcs0_NSS1	12	14.17	-7.22
HE20	6475	Mcs0_NSS1	12	14.62	-7.31
HE20	6515	Mcs0_NSS1	12	15.15	-6.97
HE40	6445	Mcs0_NSS1	18	17.87	7.21
HE40	6485	Mcs0_NSS1	18	18.06	-7.09
HE80	6465	Mcs0_NSS1	24	21.02	-7.34
HE160	6505	Mcs0_NSS1	28	23.52	-7.06

Result

The maximum average power spectral density was less than the limit of 5 dBm EIRP; therefore, the EUT complies with the specification.

5.7 §15.407(d) Contention Based Protocol

This product was tested and found to be compliant with the requirements of Contention-based Protocol as specified in FCC Part 15.407 and KDB 987594 D02.

Initially the test setup was connected directly to the signal source with all splitters (splitters terminated with a 50-ohm loads on unused ports) and cables in place to verify the AWGN signal is 10MHz wide at a signal level of less than or equal to -82dBm. The level at the signal generator required to achieve the required signal level at the DUT was recorded for use during testing.

The DUT was connected as shown in figure 4 above and set to transmit at a constant duty cycle at each frequency and bandwidth noted in the table below and verified to be communicating with the companion device as intended.

Starting at the levels established above, the AWGN signal was introduced to the DUT and increased to determine a threshold level at where the DUT will terminate with at least a 90% detection rate. The level at the DUT, which the 90% detection rate was achieved was recorded as the “Sensitivity Level” below.

Testing shall be repeated at each applicable channel and bandwidth as noted in Table 1 of KDB 987594 D02.

Start Level (Sig. Gen. Output)	Start Level (at EUT)
-58	< -82
Threshold Level (Sig. Gen. Output)	Threshold Level (at EUT)
-38	-62

Table 10: Level Details

Device Frequency (MHz)	Interference Signal Frequency (MHz)	Sensitivity Level (dbm)	Sensitivity Requirement (dbm)	Trial #										Detection Rate (%)
				1	2	3	4	5	6	7	8	9	10	
Bandwidth: 20M MHz				1	2	3	4	5	6	7	8	9	10	
6115	6115	-80.4	-62	X	X	X	X	X	X	X	X	X	X	100
6435	6435	-79.93	-62	X	X	X	X	X	X	X	X	X	X	100
6535	6535	-80.61	-62	X	X	X	X	X	X	X	X	X	X	100
6895	6895	-70.94	-62	X	X	X	X	X	X	X	X	X	X	100
Bandwidth: 160 MHz				1	2	3	4	5	6	7	8	9	10	
6185	6115	-73.13	-62	X	X	X	X	No	X	X	X	X	X	90
6505	6435	-79.93	-62	X	X	X	X	X	X	X	X	X	X	100
6665	6595	-78.08	-62	X	X	X	X	X	X	X	X	X	X	100
6985	6915	-73.6	-62	X	X	X	X	X	X	No	X	X	X	90
6185	6185	-72.37	-62	X	X	X	X	X	X	X	X	X	X	100
6505	6505	-72.39	-62	X	X	X	X	X	X	X	X	X	X	100
6665	6665	-73.11	-62	X	X	X	X	X	X	X	X	X	X	100
6985	6985	-67.46	-62	X	X	No	X	X	X	X	X	X	X	90
6185	6255	-71.33	-62	X	X	X	X	X	X	X	X	X	X	100
6505	6575	-65.6	-62	X	X	X	X	X	X	No	X	X	X	90
6665	6735	-74.11	-62	X	X	X	X	X	X	X	X	X	X	100
6985	7055	-76.22	-62	X	X	X	X	X	X	X	No	X	X	90

Table 11: Trial Table.

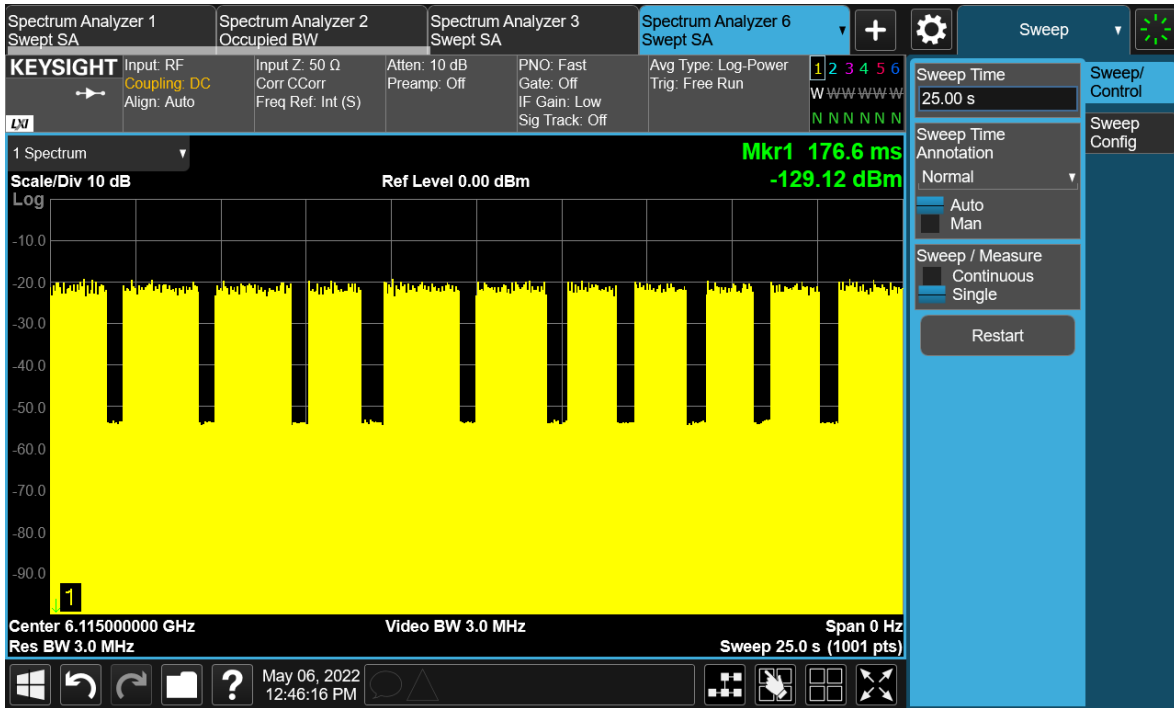

Plot 1: 20MHz Example Detection Trace

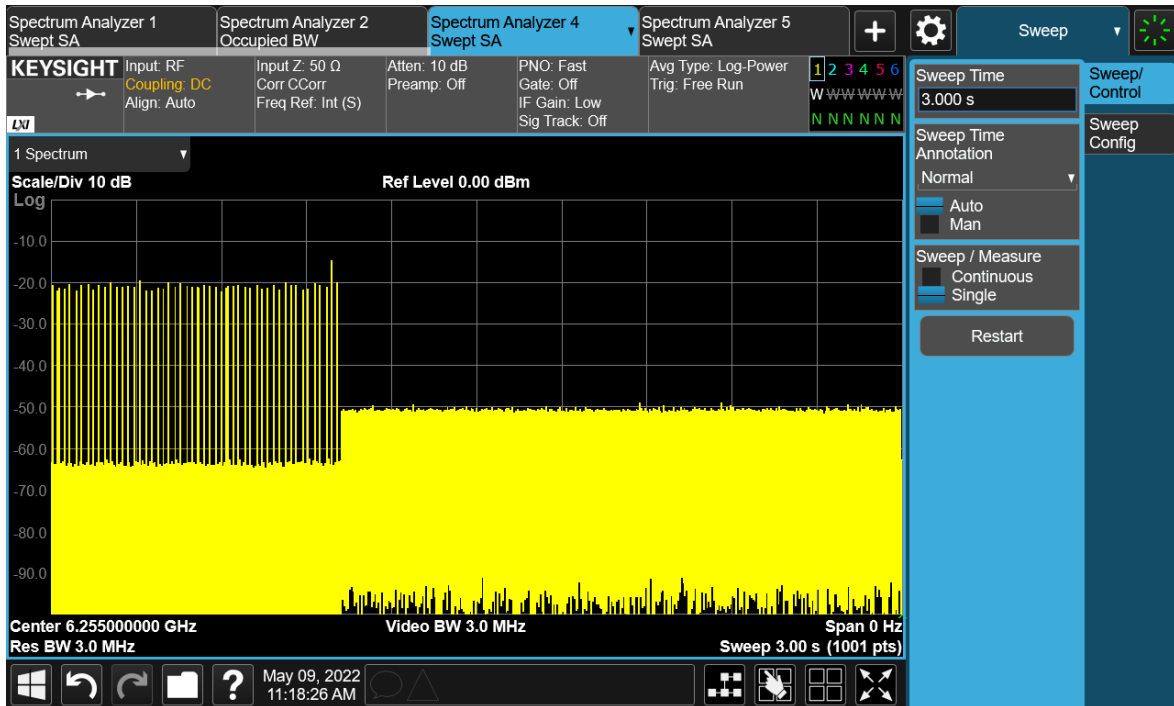

Plot 2: 160MHz Example Detection Trace

Result

The EUT complies with the specification.

-- End of Test Report --