



427 West 12800 South
Draper, UT 84020

Test Report Certification

FCC ID	SWX-U6EP
ISED ID	6545A-U6EP
Equipment Under Test	U6-Enterprise
Test Report Serial Number	TR6140_02
Date of Test(s)	10, 17, 18 and 25 May 2021
Report Issue Date	9 June 2021

Test Specification	Applicant
47 CFR FCC Part 15, Subpart E	Ubiquiti Inc. 685 Third Avenue New York, NY 10019 U.S.A.



NVLAP LAB CODE 600241-0

Certification of Engineering Report

This report has been prepared by Unified Compliance Laboratory (UCL) to document compliance of the device described below with the requirement of Federal Communication Commissions (FCC) Part 15, Subpart E. This report may be reproduced in full. Partial reproduction of this report may only be made with the written consent of the laboratory. The results in this report apply only to the sample tested.

Applicant	Ubiquiti Inc.
Manufacturer	Ubiquiti Inc.
Brand Name	UniFi
Model Number	U6-Enterprise
FCC ID	SWX-U6EP
ISED ID	6545A-U6EP

On this 9th day of June 2021, I individually and for Unified Compliance Laboratory certify that the statements made in this engineering report are true, complete, and correct to the best of my knowledge and are made in good faith.

Although NVLAP has accredited the Unified Compliance Laboratory testing facilities, this report must not be used to claim product certification, approval, or endorsement by NVLAP, NIST or any agency of the U.S. federal government.

Unified Compliance Laboratory



Written By: Joseph W. Jackson



Reviewed By: Alex Macon

Revision History		
Revision	Description	Date
01	Original Report Release	9 June 2021
02	Amended Sections 3.3.1 and 5.4	11 June 2021

Table of Contents

1	Client Information.....	5
1.1	Applicant.....	5
1.2	Manufacturer.....	5
2	Equipment Under Test (EUT).....	6
2.1	Identification of EUT.....	6
2.2	Description of EUT.....	6
2.3	EUT and Support Equipment.....	7
2.4	Interface Ports on EUT.....	7
2.5	Operating Environment.....	7
2.6	Operating Modes.....	7
2.7	EUT Exercise Software.....	8
2.8	Block Diagram of Test Configuration.....	8
2.9	Modification Incorporated/Special Accessories on EUT.....	8
2.10	Deviation, Opinions Additional Information or Interpretations from Test Standard.....	8
3	Test Specification, Method and Procedures.....	9
3.1	Test Specification.....	9
3.2	Methods & Procedures.....	9
3.3	FCC Part 15, Subpart E.....	9
3.4	Results.....	9
3.5	Test Location.....	10
4	Test Equipment.....	11
4.1	Conducted Emissions at Mains Ports.....	11
4.2	Direct Connect at the Antenna Port Tests.....	11
4.3	Radiated Emissions.....	12
4.4	Equipment Calibration.....	13
4.5	Measurement Uncertainty.....	13
5	Test Results.....	14
5.1	§15.203 Antenna Requirements.....	14
5.2	Conducted Emissions at Mains Ports Data.....	14
5.3	§15.403(i) 26 dB Emissions Bandwidth.....	16
5.4	§15.403(a)(3) Maximum Average Output Power.....	17
5.5	§15.407(b)(7) Spurious Emissions.....	18
5.6	§15.407(a) Maximum Power Spectral Density.....	22
5.7	§15.407(d) Contention Based Protocol.....	23

1 Client Information

1.1 Applicant

Company	Ubiquiti Inc. 685 Third Avenue New York, NY 10017 U.S.A.
Contact Name	Mark Feil
Title	Compliance Manager

1.2 Manufacturer

Company	Ubiquiti Inc. 685 Third Avenue New York, NY 10017 U.S.A.
Contact Name	Mark Feil
Title	Compliance Manager

2 Equipment Under Test (EUT)

2.1 Identification of EUT

Brand Name	UniFi
Model Number	U6-Enterprise
Serial Number	68D79A1F0D5A
Dimensions (cm)	22.0 x 22.0 x 4.8

2.2 Description of EUT

The U6-Enterprise is a four-stream WiFi 6 access point that provides up to 2.4 Gbps aggregate radio rate with 2.4 GHz (2x2), 5 GHz (4x4) and 6 GHz (4x4) radios. The U6-Enterprise is designed for indoor use. The U6-Enterprise has an Ethernet port for data transfer and is powered by an 803.2at PoE power adapter. The U6-Enterprise has a Bluetooth management radio to achieve setup and operation.

The table below show the channels used within the different modulation bandwidths.

Band	Modulation Bandwidth	Frequency (MHz)	Maximum Power Setting
UNII-8	ax (HEW20)	6895, 6915, 6935, 6955, 6975, 6995, 7015, 7035, 7055, 7075, 7095	TP23
		7115	TP24
	ax (HEW40)	6925, 6945, 6965, 6985	TP30
		7005, 7025, 7045, 7065, 7085	TP29
	ax (HEW80)	6945, 7025	TP35
	ax (HEW160)	6985	TP41

This report covers the circuitry of the device subject to FCC Part 15, Subpart E. The circuitry of the device subject to FCC Part 15 Subpart B was found to be compliant and is covered under a separate Unified Compliance Laboratory test report.

2.3 EUT and Support Equipment

The EUT and support equipment used during the test are listed below.

Brand Name Model Number Serial Number	Description	Name of Interface Ports / Interface Cables
BN: UniFi MN: U6-Enterprise SN: 68D79A1F0D5A	WiFi Access Point	See Section 2.4
BN: Ubiquiti MN: UPOE-at SN: N/A	PoE Power Adapter	Shielded or Un-Shielded Cat 5e cable (Note 2)
BN: Dell MN: XPS 13 SN: N/A	Laptop Personal Computer	Shielded or Un-Shielded Cat 5e cable (Note 2)

Notes: (1) EUT

(2) Interface port connected to EUT (See Section 2.4)

The support equipment listed above was not modified in order to achieve compliance with this standard.

2.4 Interface Ports on EUT

Name of Ports	No. of Ports Fitted to EUT	Cable Description/Length
PoE	1	Shielded or Un-Shielded Cat 5e Cable/> 3 meters
Data	1	Shielded or Un-Shielded Cat 5e Cable/> 3 Meters

2.5 Operating Environment

Power Supply	120 Volts ac to 48 Volts PoE Power
AC Mains Frequency	60 Hz
Temperature	21.3 – 21.8 °C
Humidity	22.0 – 24.7 %
Barometric Pressure	1019 mBar

2.6 Operating Modes

The U6-Enterprise was tested using test software in order to enable to constant transmission of over 98% All emission modes of 802.11ax were investigated. All measurements are reported with the worst-case mode (802.11ax) unless otherwise stated.

2.7 EUT Exercise Software

EUT firmware version 1.0 was used to operate the transmitter using a constant transmit mode.

2.8 Block Diagram of Test Configuration

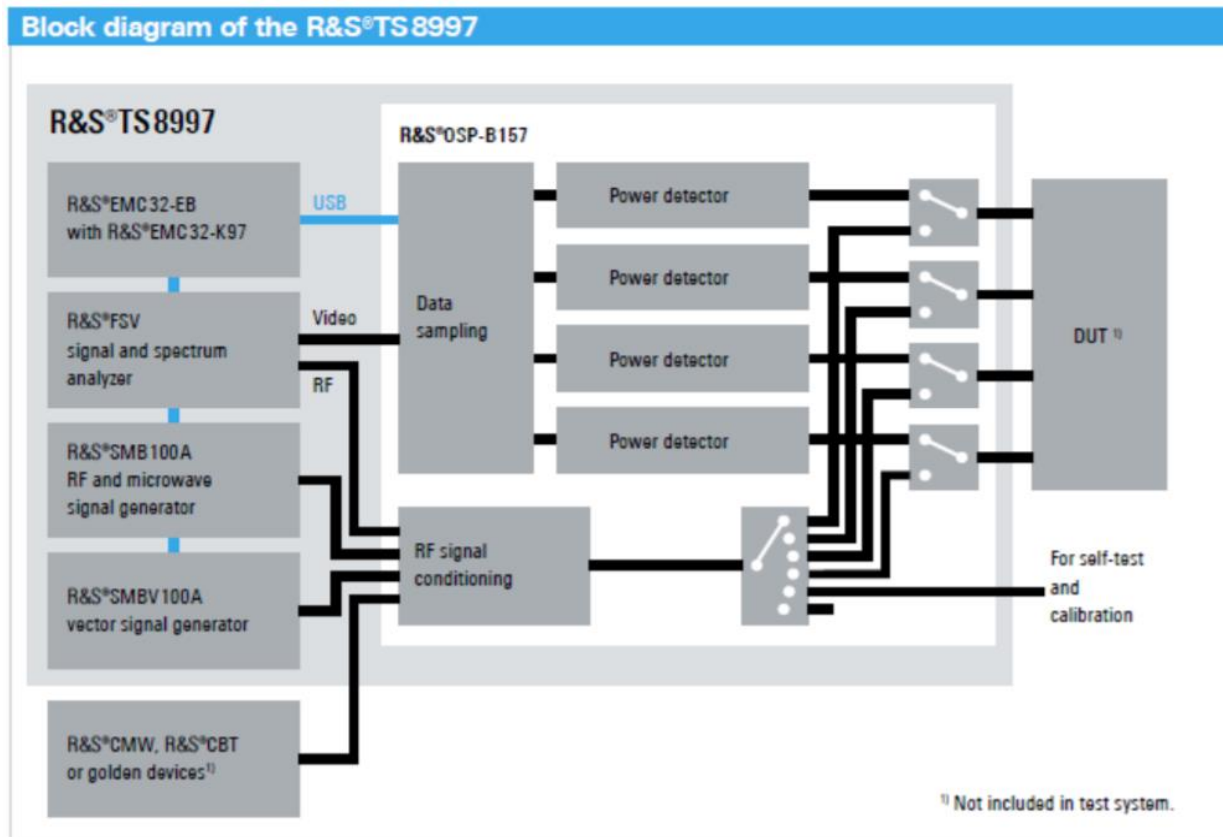

Diagram 1: Test Configuration Block Diagram

2.9 Modification Incorporated/Special Accessories on EUT

There were no modifications made to the EUT during testing to comply with the specification.

2.10 Deviation, Opinions Additional Information or Interpretations from Test Standard

There were no deviations, opinions, additional information or interpretations from the test specification.

3 Test Specification, Method and Procedures

3.1 Test Specification

Title	47 CFR FCC Part 15, Subpart E, Section 15.407 Limits and methods of measurement of radio interference characteristics of Unlicensed National Information Infrastructure Devices
Purpose of Test	The tests were performed to demonstrate initial compliance

3.2 Methods & Procedures

3.2.1 47 CFR FCC Part 15 Section 15.407

See test standard for details.

3.3 FCC Part 15, Subpart E

3.3.1 Summary of Tests

FCC Section	ISED Section	Environmental Phenomena	Frequency Range (MHZ)	Result
15.203	N/A	Antenna requirements	Structural Requirement	Compliant
15.207	RSS-Gen	Conducted Disturbance at Mains Port	0.15 to 30	Compliant
15.407(a)	RSS-247 §6.2.2, §6.2.3	Bandwidth Requirement	6875 to 7115	Compliant
15.407(a)	RSS-247 §6.2.2, §6.2.3	Peak Output Power	6875 to 7115	Compliant
15.407(f)	RSS-247 §6.2.2, §6.2.3	Antenna Conducted Spurious Emissions	0.009 to 40000	N/A
15.407(a)	RSS-247 §6.2.2, §6.2.3	Radiated Spurious Emissions	0.009 to 40000	Compliant
15.407(a)	RSS-247 §6.2.2, §6.2.3	Peak Power Spectral Density	6875 to 7115	Compliant
15.407(d)	RSS-247 §6.2.2, §6.2.3	Contention Based Protocol	6875 to 7115	Compliant

The testing was performed according to the procedures in ANSI C63.10-2013, KDB 789033 and 47 CFR Part 15. Where applicable, KDB 662911 was followed to sum required measurements.

3.4 Results

In the configuration tested, the EUT complied with the requirements of the specification.

3.5 Test Location

Testing was performed at the Unified Compliance Laboratory 3-Meter and 10-Meter chambers located at 427 West 12800 South, Draper, UT 84020. Unified Compliance Laboratory is accredited by National Voluntary Laboratory Accreditation Program (NVLAP); NVLAP Code 600241-0 which is effective until 30 June 2021. This site has also been registered with Innovations, Science and Economic Development (ISED) department as was accepted under Appendix B, Phase 1 procedures of the APEC Tel MRA for Canadian recognition. ISED No.: 25346, effective until June 30, 2021. Unified Compliance Laboratory has been assigned Conformity Assessment Number US0223 by ISED.

4 Test Equipment

4.1 Conducted Emissions at Mains Ports

Type of Equipment	Manufacturer	Model Number	Asset Number	Date of Last Calibration	Due Date of Calibration
EMI Receiver	AFJ	FFT3010	UCL-2500	9/18/2020	9/17/2021
LISN	AFJ	LS16C/10	UCL-2512	5/26/2020	5/26/2022
Cat6 ISN	Teseq	ISN T8-Cat6	UCL-2971	5/18/2020	5/18/2022
ISN	Teseq	ISN T800	UCL-2974	6/1/2020	6/1/2021
LISN	Com-Power	LIN-120C	UCL-2612	5/19/2021	5/19/2022
AC Power Source	Laplace Instruments	AC1000A	UCL-2857	N/A	N/A
Test Software	UCL	Revision 1	UCL-3107	N/A	N/A

Table 1: List of equipment used for Conducted Emissions Testing at Mains Port

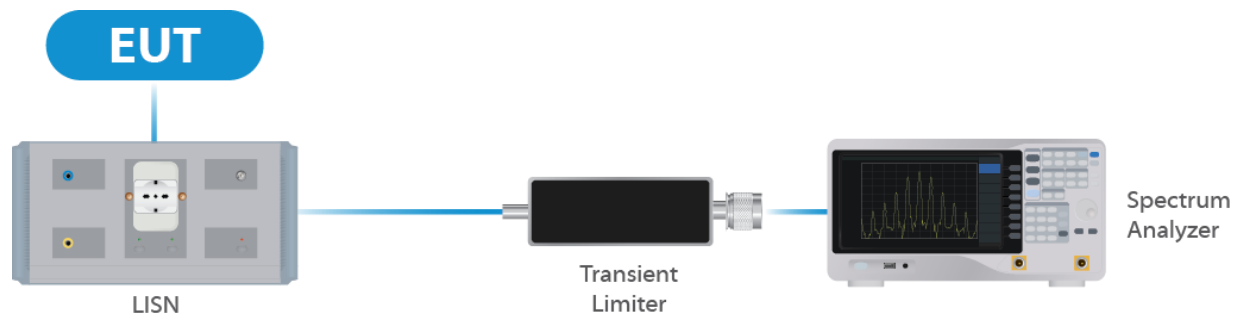

Figure 1: Conducted Emissions Test

4.2 Direct Connect at the Antenna Port Tests

Type of Equipment	Manufacturer	Model Number	Asset Number	Date of Last Calibration	Due Date of Calibration
Spectrum Analyzer	R&S	FSV40	UCL-2861	8/24/2020	8/24/2021
Signal Generator	R&S	SMB100A	UCL-2864	N/A	N/A
Vector Signal Generator	R&S	SMBV100A	UCL-2873	N/A	N/A
Switch Extension	R&S	OSP-B157WX	UCL-2867	9/8/2020	9/8/2021
Switch Extension	R&S	OSP-150W	UCL-2870	3/3/2021	3/3/2022

Table 2: List of equipment used for Direct Connect at the Antenna Port

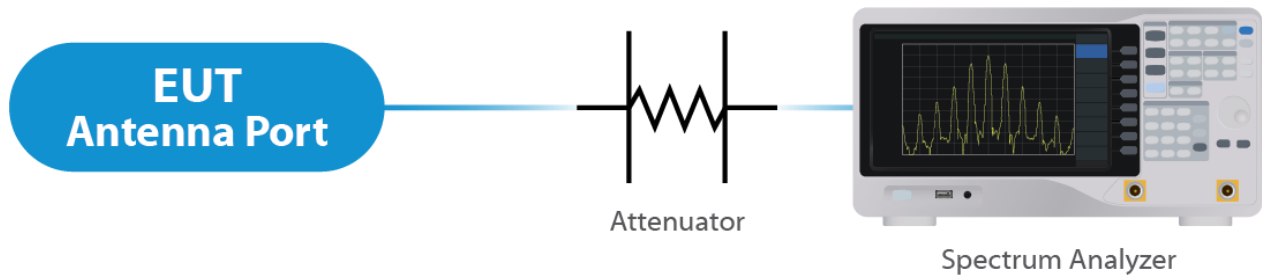

Figure 2: Direct Connect at the Antenna Port Test

4.3 Radiated Emissions

Type of Equipment	Manufacturer	Model Number	Asset Number	Date of Last Calibration	Due Date of Calibration
EMI Receiver	Keysight	N9038A	UCL-2778	6/1/2020	8/1/2021
Pre-Amplifier 9 kHz – 1 GHz	Sonoma Instruments	310N	UCL-2889	9/10/2020	9/10/2021
Double Ridge Horn Antenna	Scwarzbeck	BBHA 9120D	UCL-3065	7/8/2020	7/8/2021
Log Periodic	Scwarzbeck	STLP 9129	UCL-3068	11/16/2020	11/16/2021
15 - 40 GHz Horn Antenna	Scwarzbeck	BBHA 9170	UCL-2487	5/21/2020	5/21/2022
1 – 18 GHz Amplifier	Com-Power	PAM 118A	UCL-3833	9/29/2020	9/29/2021
Test Software	UCL	Revision 1	UCL-3108	N/A	N/A

Table 3:List of equipment used for Radiated Emissions

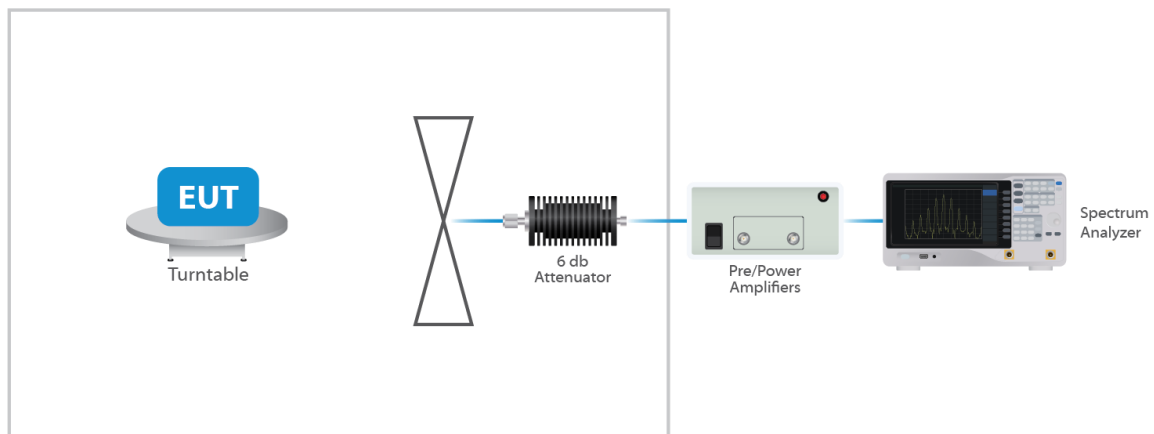

Figure 3: Radiated Emissions Test

4.4 Equipment Calibration

All applicable equipment is calibrated using either an independent calibration laboratory or Unified Compliance Laboratory personnel at intervals defined in ANSI C63.4:2014 following outlined calibration procedures. All measurement instrumentation is traceable to the National Institute of Standards and Technology (NIST). Supporting documentation relative to traceability is on file and is available for examination upon request.

4.5 Measurement Uncertainty

Test	Uncertainty (\pm dB)	Confidence (%)
Conducted Emissions	1.44	95
Radiated Emissions (9 kHz to 30 MHz)	2.50	95
Radiated Emissions (30 MHz to 1 GHz)	4.38	95
Radiated Emissions (1 GHz to 18 GHz)	4.37	95
Radiated Emissions (18 GHz to 40 GHz)	3.93	95
Direct Connect Tests	K Factor	Value
Emissions Bandwidth	2	2.0%
Output Power	2	1.0 dB
Peak Power Spectral Density	2	1.3 dB
Band Edge	2	0.8 dB
Transmitter Spurious Emissions	2	1.8 dB

5 Test Results

5.1 §15.203 Antenna Requirements

The EUT uses an integral antenna. The Maximum gain of the antenna is 6.0 dBi. The antenna is not user replaceable.

Results

The EUT complied with the specification

5.2 Conducted Emissions at Mains Ports Data

5.2.1 Line

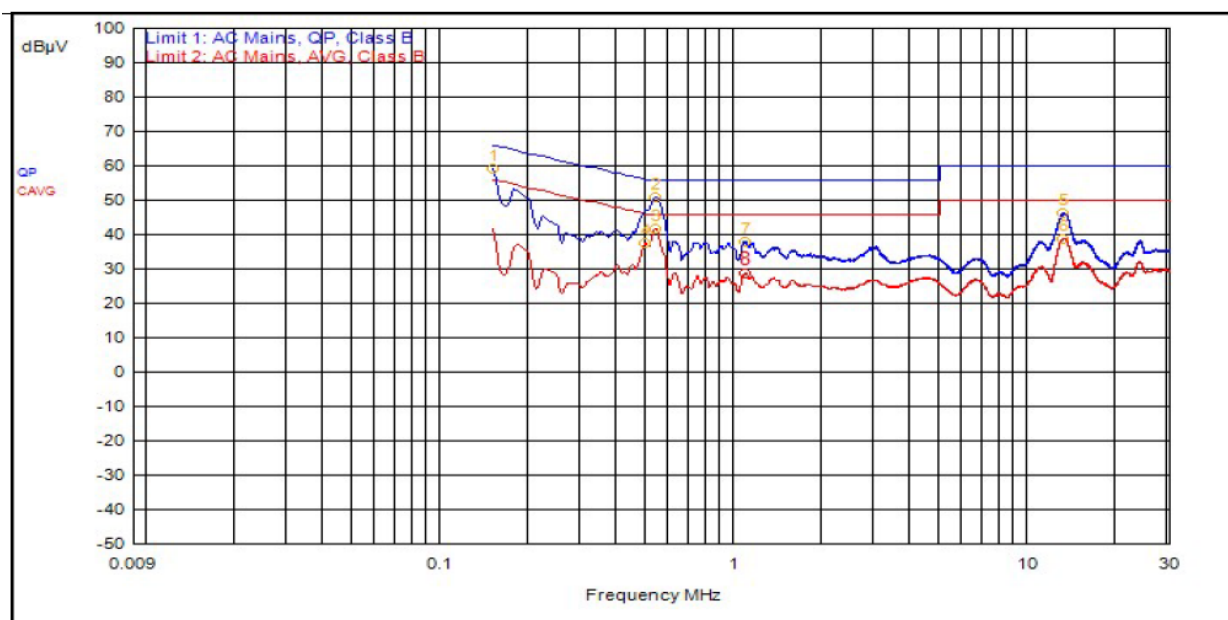

ID	Frequency	Probe	Cable	Atten.	Detector	Meter Read	Meas Level	Limit 1	Limit 1 Dist.	Limit 2	Limit 2 Dist.
2	534,000kHz	12.4			QPeak	38.3	50.7	56.0	-5.3		
1	150,000kHz	12.4			QPeak	46.8	59.2	66.0	-6.8		
5	13.041MHz	12.4			QPeak	33.7	46.2	60.0	-13.8		
7	1.083MHz	12.4			QPeak	25.4	37.8	56.0	-18.2		
3	537,000kHz	12.4			C_AVG	29.2	41.6			46.0	-4.4
4	495,000kHz	12.4			C_AVG	25.1	37.5			46.1	-8.6
6	13.041MHz	12.4			C_AVG	26.4	38.8			50.0	-11.2
8	1.083MHz	12.4			C_AVG	16.3	28.7			46.0	-17.3

5.2.2 Neutral

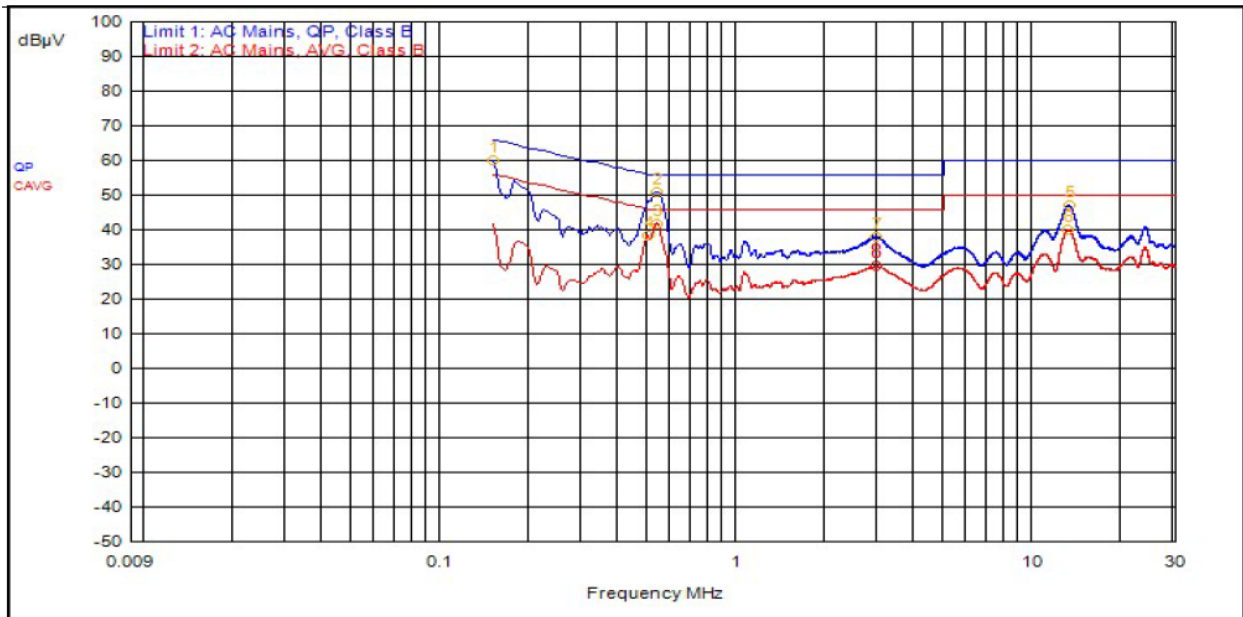

ID	Frequency	Probe	Cable	Atten.	Detector	Meter Read	Meas Level	Limit 1	Limit 1 Dist.	Limit 2	Limit 2 Dist.
2	531,000kHz	12.4			QPeak	38.4	50.8	56.0	-5.2		
1	150,000kHz	12.4			QPeak	47.5	59.9	66.0	-6.1		
5	13.080MHz	12.4			QPeak	34.5	46.9	60.0	-13.1		
7	2.940MHz	12.3			QPeak	25.7	38.0	56.0	-18.0		
3	531,000kHz	12.4			C_AVG	29.4	41.8			46.0	-4.2
4	498,000kHz	12.4			C_AVG	25.9	38.3			46.0	-7.8
6	12.963MHz	12.4			C_AVG	27.5	39.9			50.0	-10.1
8	2.928MHz	12.3			C_AVG	17.2	29.5			46.0	-16.5

Result

The EUT complied with the specification limit.

5.3 §15.403(i) 26 dB Emissions Bandwidth

Nominal BW (MHz)	Frequency (MHz)	99% Bandwidth (MHz)	26 dB Bandwidth (MHz)
20	6895	19.1	22.5
20	7015	19.1	22.2
20	7115	19.1	22.1
40	6925	38.0	40.1
40	7005	37.8	40.5
40	7085	36.3	41.0
80	6945	75.5	81.5
80	7025	75.5	82.5
160	6985	156.0	163.0

Result

The 26 dB bandwidths are reported for information purposes. Please see Annex for all bandwidth measurements.

5.4 §15.403(a)(3) Maximum Average Output Power

The maximum average RF conducted output power measured for this device was 23.28 dBm or 212.81 mW. The limit is 30 dBm EIRP, or 1 Watt EIRP. The antenna has a gain of 6.0 dBi.

Modulation (BW)	Frequency (MHz)	Data Rate	TP Setting	Conducted Output Power *	Output Power EIRP	Measured PSD
HE20	6895	Mcs0	23	14.40	20.40	-1.55
HE20	7015	Mcs0	23	14.77	20.77	-1.22
HE20	7115	Mcs0	24	14.94	20.94	-1.00
HE40	6925	Mcs0	30	18.16	24.16	-1.11
HE40	7005	Mcs0	29	17.82	23.82	-1.29
HE40	7085	Mcs0	29	17.28	23.28	-1.40
HE80	6945	Mcs0	35	20.40	26.40	-1.28
HE80	7025	Mcs0	35	20.60	26.60	-1.31
HE160	6985	Mcs0	41	23.28	29.28	-1.13

Result

In the configuration tested, the maximum average RF outpower was less than 1 watt EIRP; therefore, the EUT complied with the requirements of the specification (see spectrum analyzer plots in attached Annex).

* Gated EIRP shown in the Annex is the conducted measurement

5.5 §15.407(b)(7) Spurious Emissions

5.5.1 Conducted Spurious Emissions

The frequency range from the lowest frequency generated or used in the device to the tenth harmonic of the highest fundamental frequency was investigated to measure any antenna-conducted emissions. The graphs show the measurement data from spurious emissions noted across the frequency range when transmitting at the lowest frequency, middle frequency and upper frequency. Shown below are plots with the EUT turned to the upper and lower channels with the antenna gain of 12 dBi accounted for. These demonstrate compliance with the provisions of this section at the band edges.

The emissions must remain below -27 dBm EIRP.

Result

Conducted spurious emissions were attenuated below the limit; therefore, the EUT complies with the specification.

5.5.2 Radiated Spurious Emissions in the Restricted Bands of § 15.205

The EUT uses various power settings based on the channel in use. In order to reduce test time, the radiated spurious emissions at the lowest, middle, and highest channel were measured at the maximum power of TP41.

Result

All emissions in the restricted bands of § 15.205 met the limits specified in § 15.209; therefore, the EUT complies with the specification. See Annex for Conducted Band edge plots.

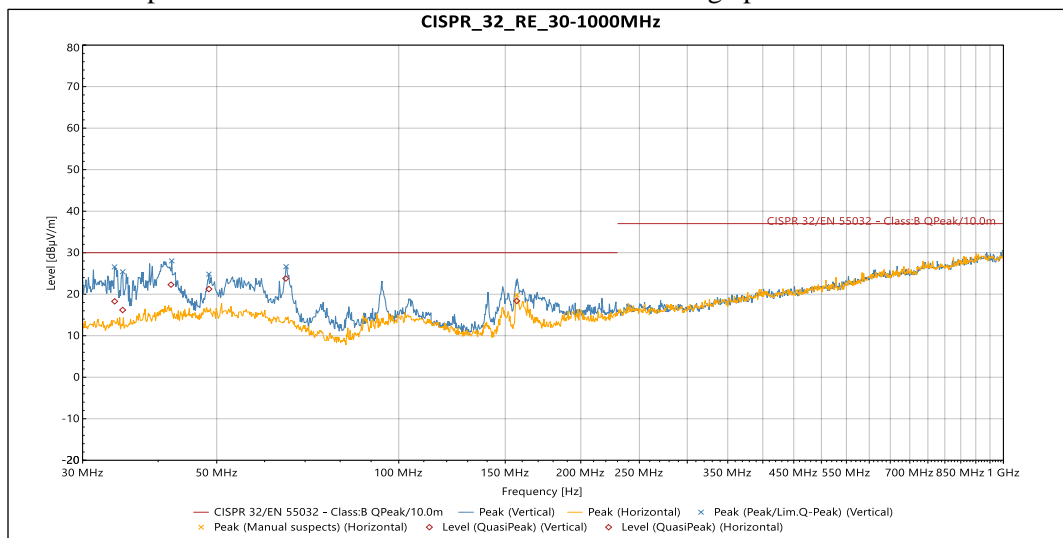

Vertical

Source	Frequency	Level (dBµV/m)	Limit (dBµV/m)	Margin	Azimuth (°)	Height	Pol.	Correction (dB)
QuasiPeak	33.896 MHz	18.279	30	-11.721	81	1.106	Vertical	-15.184
QuasiPeak	34.945 MHz	16.188	30	-13.812	319	1.946	Vertical	-14.833
QuasiPeak	42.009 MHz	22.297	30	-7.703	73	2.164	Vertical	-12.832
QuasiPeak	48.534 MHz	21.24	30	-8.76	20	2.62	Vertical	-12.359
QuasiPeak	65.031 MHz	23.786	30	-6.214	108	2.835	Vertical	-14.684

Horizontal

Source	Frequency	Level (dBμV/m)	Limit (dBμV/m)	Margin	Azimuth (°)	Height	Pol.	Correction (dB)
QuasiPeak	156.72 MHz	18.377	30	-11.623	235	3.995	Horizontal	-17.354

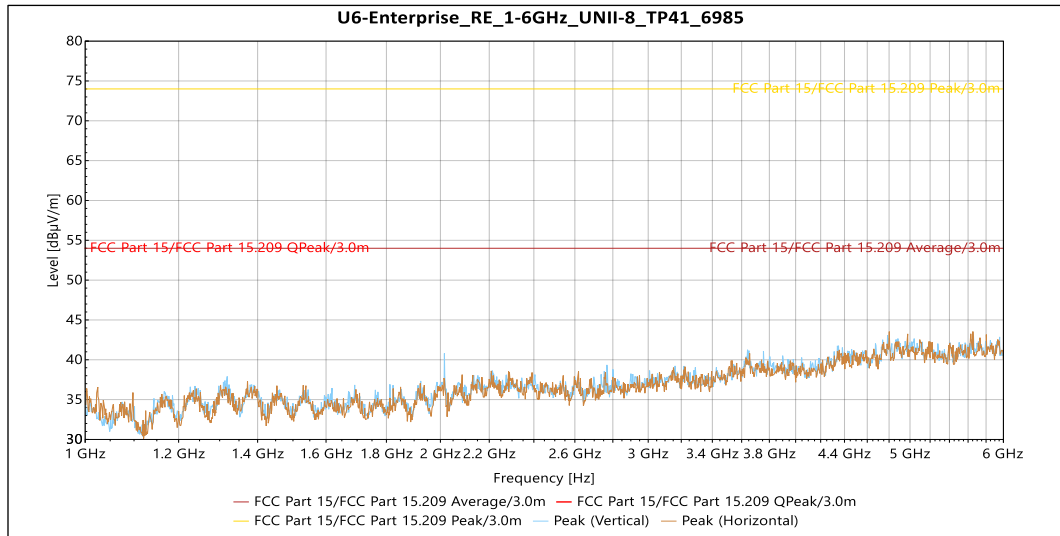
Table 4: Radiated Emissions 30 – 1000 MHz

Vertical – No significant emissions were observed from 1 – 6 GHz

Horizontal – No significant emissions were observed from 1 – 6 GHz

Table 5: Transmit Frequency 6985 MHz – 1 – 6 GHz (Worse Case)

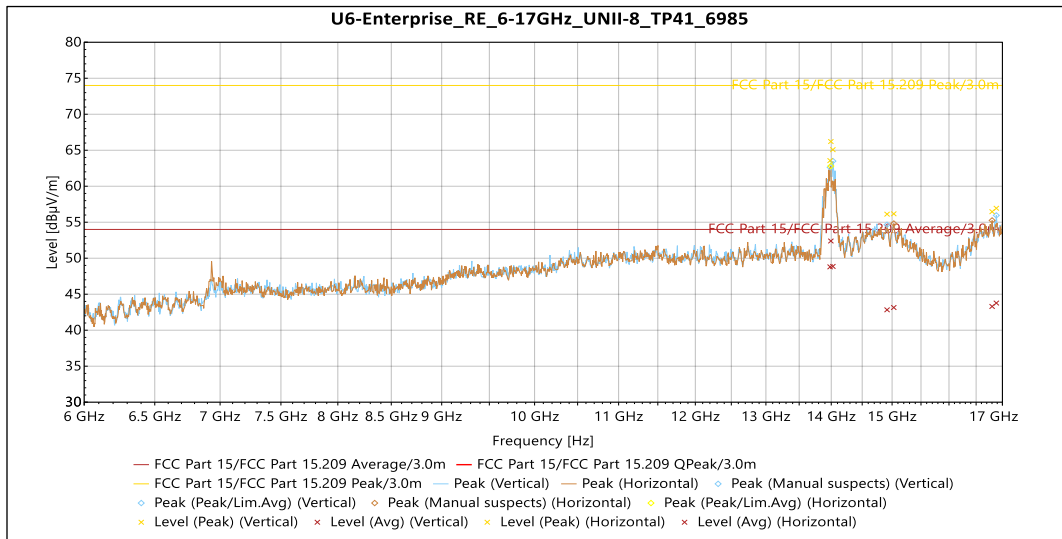
Vertical

Source	Frequency	Level (dBµV/m)	Limit (dBµV/m)	Margin (dB)	Azimuth (°)	Height (m)	Pol.	Correction (dB)
Peak	13.982 GHz	63.562	74	-10.438	1	1.825	Vertical	5.83
Peak	14.026 GHz	65.078	74	-8.922	29	2.65	Vertical	5.752
Peak	14.915 GHz	56.117	74	-17.883	351	1.647	Vertical	9.904
Peak	16.883 GHz	56.936	74	-17.064	221	2.658	Vertical	12.097

Source	Frequency	Level (dBµV/m)	Limit (dBµV/m)	Margin (dB)	Azimuth (°)	Height (m)	Pol.	Correction (dB)
Avg	13.982 GHz	48.798	54	-5.202	1	1.825	Vertical	5.83
Avg	14.026 GHz	48.856	54	-5.144	29	2.65	Vertical	5.752
Avg	14.915 GHz	42.833	54	-11.167	351	1.647	Vertical	9.904
Avg	16.883 GHz	43.771	54	-10.229	221	2.658	Vertical	12.097

Horizontal

Source	Frequency	Level (dBµV/m)	Limit (dBµV/m)	Margin (dB)	Azimuth (°)	Height (m)	Pol.	Correction (dB)
Peak	13.994 GHz	66.209	74	-7.791	36	2.316	Horizontal	5.778
Peak	15.029 GHz	56.169	74	-17.831	160	1.647	Horizontal	10.174
Peak	16.802 GHz	56.463	74	-17.537	210	2.65	Horizontal	11.461

Source	Frequency	Level (dBµV/m)	Limit (dBµV/m)	Margin (dB)	Azimuth (°)	Height (m)	Pol.	Correction (dB)
Avg	13.994 GHz	52.393	54	-1.607	36	2.316	Horizontal	5.778
Avg	15.029 GHz	43.147	54	-10.853	160	1.647	Horizontal	10.174
Avg	16.802 GHz	43.3	54	-10.7	210	2.65	Horizontal	11.461

Table 6: Transmit Frequency 6985 MHz – 6 – 17 GHz (Worse Case)

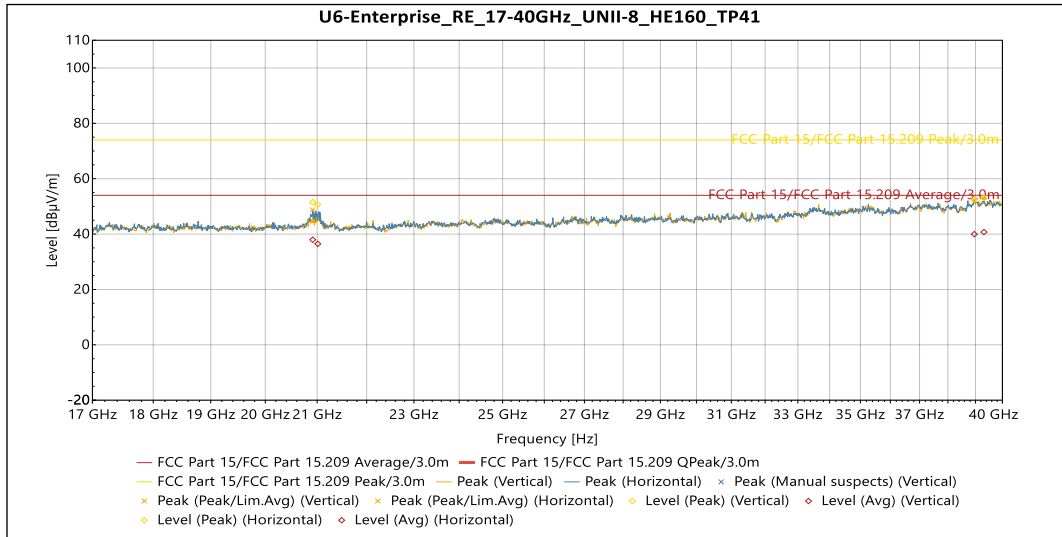
Vertical

Source	Frequency	Level (dBµV/m)	Limit (dBµV/m)	Margin (dB)	Azimuth (°)	Pol.	Correction (dB)
Peak	21.012 GHz	50.693	74	-23.307	9	Vertical	-5.637
Peak	39.311 GHz	53.08	74	-20.92	304	Vertical	3.299

Source	Frequency	Level (dBµV/m)	Limit (dBµV/m)	Margin (dB)	Azimuth (°)	Pol.	Correction (dB)
Avg	21.012 GHz	36.461	54	-17.539	9	Vertical	-5.637
Avg	39.311 GHz	40.719	54	-13.281	304	Vertical	3.299

Horizontal

Source	Frequency	Level (dBµV/m)	Limit (dBµV/m)	Margin (dB)	Azimuth (°)	Pol.	Correction (dB)
Peak	20.912 GHz	51.513	74	-22.487	16	Horizontal	-5.529
Peak	38.956 GHz	52.421	74	-21.579	355	Horizontal	2.974

Source	Frequency	Level (dBµV/m)	Limit (dBµV/m)	Margin (dB)	Azimuth (°)	Pol.	Correction (dB)
Avg	20.912 GHz	37.949	54	-16.051	16	Horizontal	-5.529
Avg	38.956 GHz	39.962	54	-14.038	355	Horizontal	2.974

Table 7: Transmit Frequency 6985 MHz – 17 – 40 GHz

5.6 §15.407(a) Maximum Power Spectral Density

The maximum average power spectral density conducted from the intentional radiator of the antenna shall not be greater than 5 dBm in any 1 MHz band during any time interval of continuous transmission.

Results of this testing are summarized.

Modulation (BW)	Frequency (MHz)	Data Rate	TP Setting	Conducted Output Power	Measured PSD	PSD EIRP
HE20	6895	Mcs0	23	14.40	-1.55	4.45
HE20	7015	Mcs0	23	14.77	-1.22	4.78
HE20	7115	Mcs0	24	14.94	-1.00	5.00
HE40	6925	Mcs0	30	18.16	-1.11	4.89
HE40	7005	Mcs0	29	17.82	-1.29	4.71
HE40	7085	Mcs0	29	17.28	-1.40	4.60
HE80	6945	Mcs0	35	20.40	-1.28	4.72
HE80	7025	Mcs0	35	20.60	-1.31	4.69
HE160	6985	Mcs0	41	23.28	-1.13	4.87

Result

The maximum average power spectral density was less than the limit of 5 dBm EIRP; therefore, the EUT complies with the specification.

5.7 §15.407(d) Contention Based Protocol

This product was tested and found to be compliant with the requirements of Contention-based Protocol as specified in FCC Part 15.407 and KDB 987594 D02.

Frequency (MHz)	Sensitivity Level (dBm)	Sensitivity Requirement (dBm)	Trial #									
			1	2	3	4	5	6	7	8	9	10
Bandwidth: 20 MHz			1	2	3	4	5	6	7	8	9	10
6115	-80.39	-62	X	X	X	X	X	X	X	X	X	X
6435	-78.78	-62	X	X	X	X	X	X	X	X	X	X
6535	-79.11	-62	X	X	X	X	X	X	X	X	X	X
6895	-78.55	-62	X	X	X	X	X	X	X	X	X	X
Bandwidth: 160 MHz			1	2	3	4	5	6	7	8	9	10
6112.5 (L)	-67.95	-62	X	X	X	X	X	X	X	X	X	X
6185 (M)	-71.56	-62	X	X	X	X	X	X	X	X	X	X
6257.5 (H)	-67.78	-62	X	X	X	X	X	X	X	X	X	X
6432.5 (L)	-66.32	-62	X	X	X	X	X	X	X	X	X	X
6505 (M)	-72.62	-62	X	X	X	X	X	X	X	X	X	X
6577.5 (H)	-70.22	-62	X	X	X	X	X	X	X	X	X	X
6592.5 (L)	-66.99	-62	X	X	X	X	X	X	X	X	X	X
6665 (M)	-69.63	-62	X	X	X	X	X	X	X	X	X	X
6737.5 (H)	-67.56	-62	X	X	X	X	X	X	X	X	X	X
6912.5 (L)	-65.04	-62	X	X	X	X	X	X	X	X	X	X
6985 (M)	-71.27	-62	X	X	X	X	X	X	X	X	X	X
7057.5 (H)	-70.73	-62	X	X	X	X	X	X	X	X	X	X

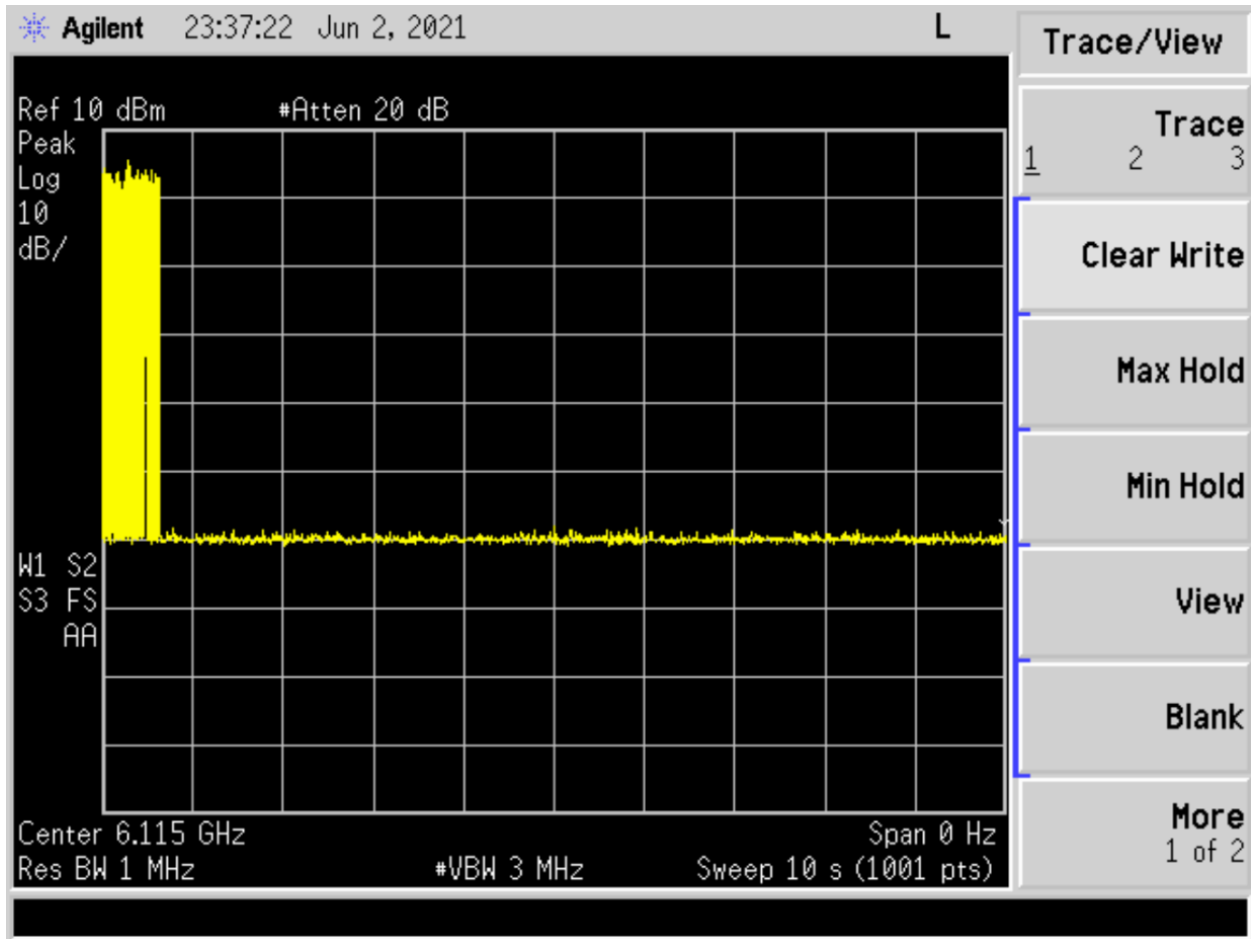

Plot 1: Example Detection Trace

Result

The EUT complies with the specification.

-- End of Test Report --