



FCC RF Test Report

APPLICANT : Ubiquiti Networks, Inc.
EQUIPMENT : PRISM Station AC
BRAND NAME : UBIQUITI
MODEL NAME : PS-5AC
FCC ID : SWX-PS5AC
STANDARD : FCC Part 15 Subpart E §15.407
CLASSIFICATION : (NII) Unlicensed National Information Infrastructure

The product was received on Dec. 24, 2016 and testing was completed on Mar. 08, 2017. We, SPORTON INTERNATIONAL INC., would like to declare that the tested sample has been evaluated in accordance with the test procedures and has been in compliance with the applicable technical standards.

The test results in this report apply exclusively to the tested model / sample. Without written approval of SPORTON INTERNATIONAL INC., the test report shall not be reproduced except in full.

Reviewed by: Joseph Lin / Supervisor

Approved by: Jones Tsai / Manager



SPORTON INTERNATIONAL INC.

No. 52, Hwa Ya 1st Rd., Hwa Ya Technology Park, Kwei-Shan District, Tao Yuan City, Taiwan, R.O.C.

SPORTON INTERNATIONAL INC.

TEL : 886-3-327-3456

FAX : 886-3-328-4978

FCC ID : SWX-PS5AC

Page Number : 1 of 31

Report Issued Date : Mar. 29, 2017

Report Version : Rev. 02

Report Template No.: BU5-FR15EWLAC MA Version 2.0



TABLE OF CONTENTS

REVISION HISTORY..... 3

SUMMARY OF TEST RESULT 4

1 GENERAL DESCRIPTION 5

 1.1 Applicant 5

 1.2 Manufacturer 5

 1.3 Product Feature of Equipment Under Test 5

 1.4 Modification of EUT 5

 1.5 Testing Location 6

 1.6 Applicable Standards 7

2 TEST CONFIGURATION OF EQUIPMENT UNDER TEST 8

 2.1 Test Mode 8

 2.2 Connection Diagram of Test System 10

 2.3 Support Unit used in test configuration and system 10

 2.4 EUT Operation Test Setup 11

 2.5 Measurement Results Explanation Example 11

3 TEST RESULT 12

 3.1 26dB & 99% Occupied Bandwidth Measurement 12

 3.2 Maximum Conducted Output Power Measurement 15

 3.3 Power Spectral Density Measurement 17

 3.4 Unwanted Emissions Measurement 20

 3.5 AC Conducted Emission Measurement 24

 3.6 Frequency Stability Measurement 26

 3.7 Automatically Discontinue Transmission 27

 3.8 Antenna Requirements 28

4 LIST OF MEASURING EQUIPMENT 30

5 UNCERTAINTY OF EVALUATION 31

APPENDIX A. CONDUCTED TEST RESULTS

APPENDIX B. AC CONDUCTED EMISSION TEST RESULT

APPENDIX C. RADIATED SPURIOUS EMISSION

APPENDIX D. RADIATED SPURIOUS EMISSION PLOTS

APPENDIX E. DUTY CYCLE PLOTS

APPENDIX F. SETUP PHOTOGRAPHS



REVISION HISTORY

REPORT NO.	VERSION	DESCRIPTION	ISSUED DATE
FR6N2223-01B	Rev. 01	Initial issue of report	Mar. 24, 2017
FR6N2223-01B	Rev. 02	Adding description of PoE adapter in section 2.1	Mar. 29, 2017



SUMMARY OF TEST RESULT

Report Section	FCC Rule	Description	Limit	Result	Remark
3.1	2.1049 15.403(i)	26dB & 99% Bandwidth	-	Pass	-
3.2	15.407(a)	Maximum Conducted Output Power	≤ 30 dBm (depend on band)	Pass	-
3.3	15.407(a)	Power Spectral Density	≤ 17 dBm (depend on band)	Pass	-
3.4	15.407(b)	Unwanted Emissions	≤ -17, -27 dBm (depend on band)&15.209(a)	Pass	Under limit 0.19 dB at 5149.760 MHz
3.5	15.207	AC Conducted Emission	15.207(a)	Pass	Under limit 7.20 dB at 0.150 MHz
3.6	15.407(g)	Frequency Stability	Within Operation Band	Pass	-
3.7	15.407(c)	Automatically Discontinue Transmission	Discontinue Transmission	Pass	-
3.8	15.203 & 15.407(a)	Antenna Requirement	N/A	Pass	-



1 General Description

1.1 Applicant

Ubiquiti Networks, Inc.
2580 Orchard Parkway San Jose, CA 95131

1.2 Manufacturer

Ubiquiti Networks, Inc.
2580 Orchard Parkway San Jose, CA 95131

1.3 Product Feature of Equipment Under Test

Wi-Fi 2.4GHz 802.11b/g/n, Wi-Fi 5GHz 802.11a/n/ac, and GPS

Product Specification subjective to this standard	
Antenna Type	WLAN 2.4GHz: Internal Antenna WLAN 5GHz: Horn Antenna GPS: Patch Antenna

1.4 Modification of EUT

No modifications are made to the EUT during all test items.



1.5 Testing Location

Sporton Lab is accredited to ISO 17025 by Taiwan Accreditation Foundation (TAF code : 1190) and the FCC designation No. TW0007 under the FCC 2.948(e) by Mutual Recognition Agreement (MRA) in FCC Test.

Test Site	SPORTON INTERNATIONAL INC.	
Test Site Location	No. 52, Hwa Ya 1 st Rd., Hwa Ya Technology Park, Kwei-Shan District, Tao Yuan City, Taiwan, R.O.C. TEL: +886-3-327-3456 FAX: +886-3-328-4978	
Test Site No.	Sporton Site No.	
	TH05-HY	CO05-HY

Note: The test site complies with ANSI C63.4 2014 requirement.

Test Site	SPORTON INTERNATIONAL INC.	
Test Site Location	No.58, Aly. 75, Ln. 564, Wenhua 3rd Rd. Guishan Dist, Taoyuan City, Taiwan (R.O.C.) TEL: +886-3-327-0868 FAX: +886-3-327-0855	
Test Site No.	Sporton Site No. :	
	03CH10-HY	

Note: The test site complies with ANSI C63.4 2014 requirement.



1.6 Applicable Standards

According to the specifications of the manufacturer, the EUT must comply with the requirements of the following standards:

- ♦ FCC Part 15 Subpart E
- ♦ FCC KDB 789033 D02 General UNII Test Procedures New Rules v01r03.
- ♦ FCC KDB 662911 D01 Multiple Transmitter Output v02r01.
- ♦ FCC KDB 644545 D03 Guidance for IEEE 802 11ac New Rules v01.
- ♦ ANSI C63.10-2013

Remark:

1. All test items were verified and recorded according to the standards and without any deviation during the test.
2. This EUT has also been tested and complied with the requirements of FCC Part 15, Subpart B, recorded in a separate test report.



2 Test Configuration of Equipment Under Test

- a. The EUT has been associated with peripherals and configuration operated in a manner tended to maximize its emission characteristics in a typical application. Frequency range investigated: conduction emission (150 kHz to 30 MHz), radiation emission (9 kHz to the 10th harmonic of the highest fundamental frequency or to 40 GHz, whichever is lower). For radiated measurement, pre-scanned in three orthogonal panels, X, Y, Z. The worst cases (Y plane) were recorded in this report.
- b. AC power line Conducted Emission was tested under maximum output power.

2.1 Test Mode

Final test mode of conducted test items and radiated spurious emissions are considering the modulation and worse data rates as below table.

MIMO Antenna

Modulation	Data Rate
802.11ac VHT10	VHT0
802.11ac VHT20	VHT0
802.11ac VHT30	VHT0
802.11ac VHT40	VHT0
802.11ac VHT50	VHT0
802.11ac VHT60	VHT0
802.11ac VHT80	VHT0

Remark: For radiated spurious emissions, all tests were performed with PoE adapter 1.

Test Cases	
AC Conducted Emission	Mode 1 : WLAN (2.4GHz) Idle + WLAN (5GHz) Link + LAN Link + PoE Adapter 1 + GPS Rx



Ch. #		Band I : 5150-5250 MHz			
		802.11ac VHT10	802.11ac VHT20	802.11ac VHT30	802.11ac VHT40
L	Low	32	33	34	35
M	Middle	40	40	40	40
H	High	49	48	47	46

Ch. #		Band I : 5150-5250 MHz			
		802.11ac VHT50	802.11ac VHT60	802.11ac VHT80	-
L	Low	36	37	38	-
M	Middle	40	40	40	-
H	High	45	44	42	-

2.2 Connection Diagram of Test System

<WLAN Tx Mode>

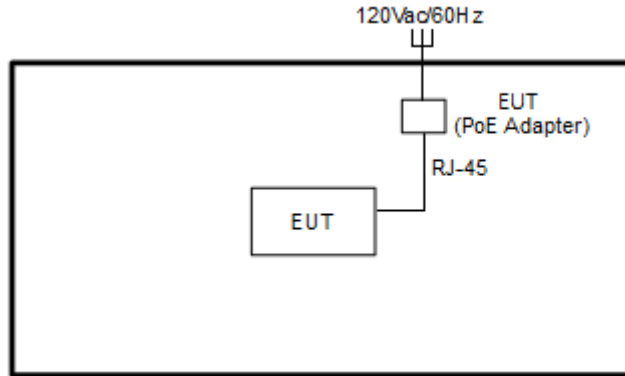

<AC Conducted Emission>

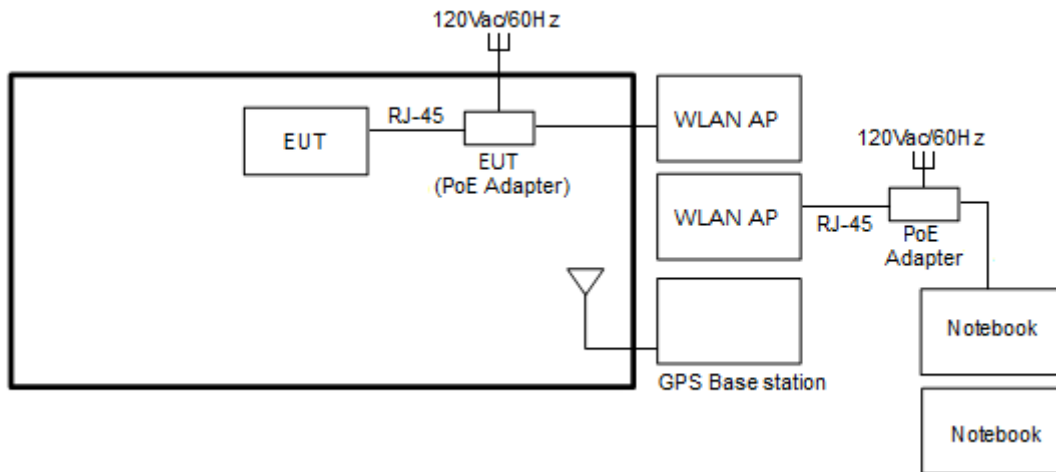

2.3 Support Unit used in test configuration and system

Item	Equipment	Trade Name	Model Name	FCC ID	Data Cable	Power Cord
1.	AP	Ubiquiti	RP-5AC-GEN2	N/A	N/A	Unshielded, 1.8 m
2.	GPS Station	Pendulum	GSG-54	N/A	N/A	Unshielded, 1.8 m
3.	Notebook	DELL	P20G	FCC DoC/ Contains FCC ID: QDS-BRCM1051	N/A	AC I/P: Unshielded, 1.2 m DC O/P: Shielded, 1.8 m
4.	Notebook	DELL	Latitude E6320	FCC DoC/ Contains FCC ID: QDS-BRCM1054	N/A	AC I/P: Unshielded, 1.2 m DC O/P: Shielded, 1.8 m
5.	Antenna	N/A	N/A	N/A	N/A	N/A



2.4 EUT Operation Test Setup

For WLAN function, programmed RF utility, "CMD" installed in the notebook make the EUT provide functions like channel selection and power level for continuous transmitting and receiving signals.

2.5 Measurement Results Explanation Example

For all conducted test items:

The offset level is set in the spectrum analyzer to compensate the RF cable loss and attenuator factor between EUT conducted output port and spectrum analyzer. With the offset compensation, the spectrum analyzer reading level is exactly the EUT RF output level.

Example :

The spectrum analyzer offset is derived from RF cable loss and attenuator factor.

Offset = RF cable loss + attenuator factor.

Following shows an offset computation example with cable loss 4.2 dB and 10dB attenuator.

$$\begin{aligned} \text{Offset(dB)} &= \text{RF cable loss(dB)} + \text{attenuator factor(dB)}. \\ &= 4.2 + 10 = 14.2 \text{ (dB)} \end{aligned}$$

3 Test Result

3.1 26dB & 99% Occupied Bandwidth Measurement

3.1.1 Description of 26dB & 99% Occupied Bandwidth

This section is for reporting purpose only.

There is no restriction limits for bandwidth.

3.1.2 Measuring Instruments

The measuring equipment is listed in the section 4 of this test report.

3.1.3 Test Procedures

1. The testing follows FCC KDB 789033 D02 General UNII Test Procedures New Rules v01r03.
Section C) Emission bandwidth
2. Set RBW = approximately 1% of the emission bandwidth.
3. Set the VBW > RBW.
4. Detector = Peak.
5. Trace mode = max hold
6. Measure the maximum width of the emission that is 26 dB down from the peak of the emission.
Compare this with the RBW setting of the analyzer. Readjust RBW and repeat measurement as needed until the RBW/EBW ratio is approximately 1%.
7. For 99% Bandwidth Measurement, the spectrum analyzer's resolution bandwidth (RBW) is set 1MHz and set the Video bandwidth (VBW) $\geq 3 * RBW$.
8. Measure and record the results in the test report.

3.1.4 Test Setup

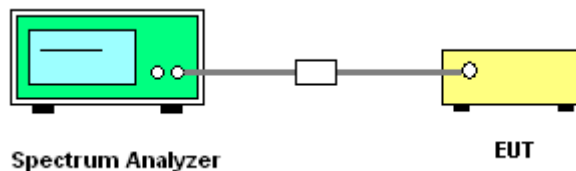

3.1.5 Test Result of 26dB & 99% Occupied Bandwidth

Please refer to Appendix A.



<PTP>

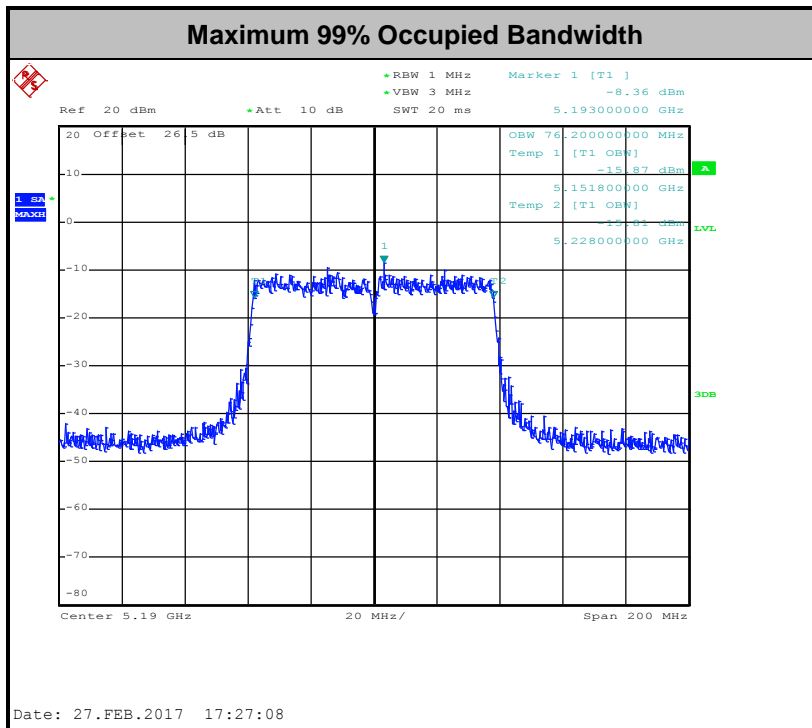
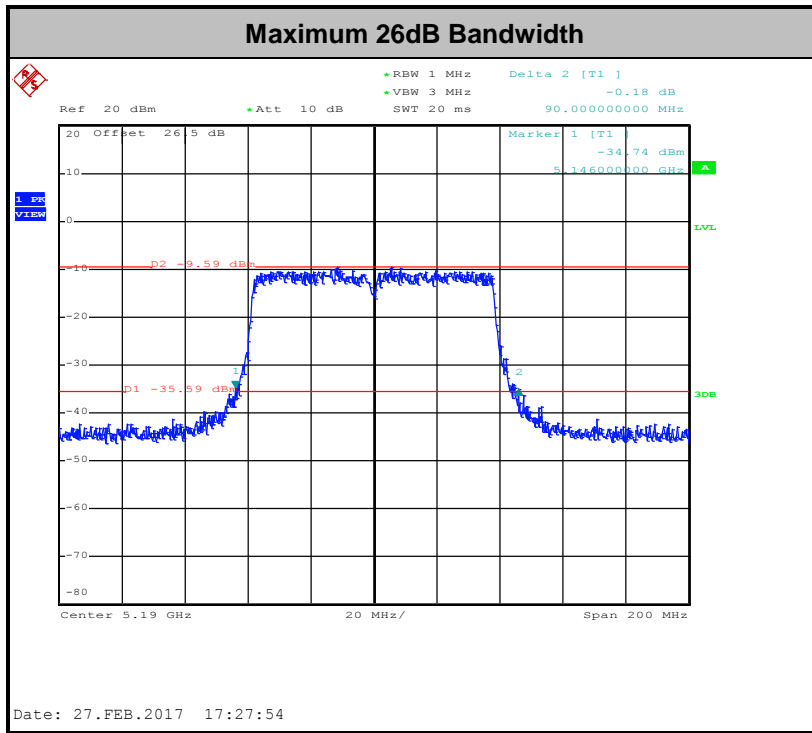

Note: The occupied channel bandwidth is maintained within the band of operation for all of the modulations.



<PTMP>

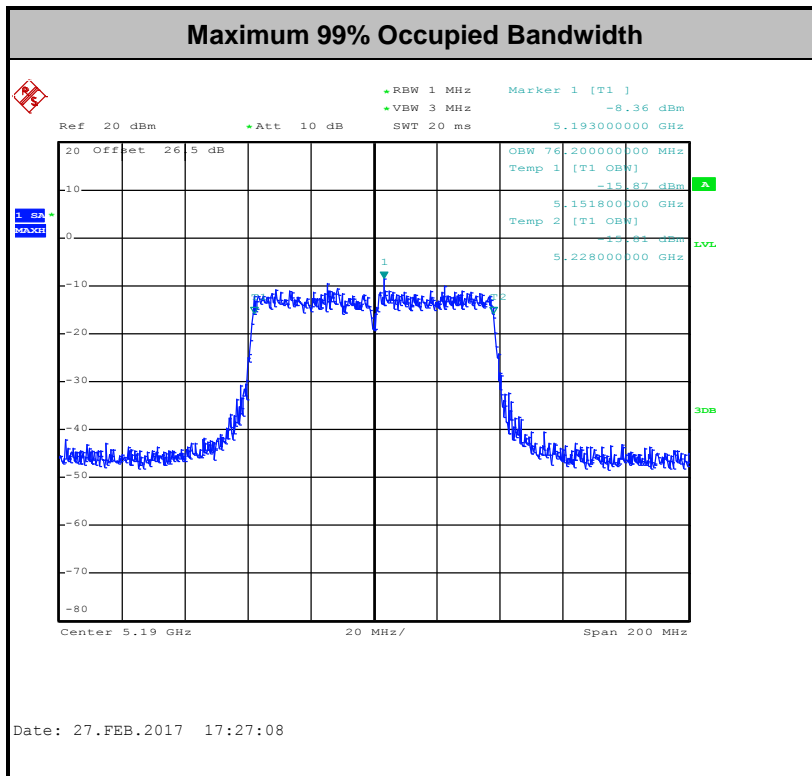
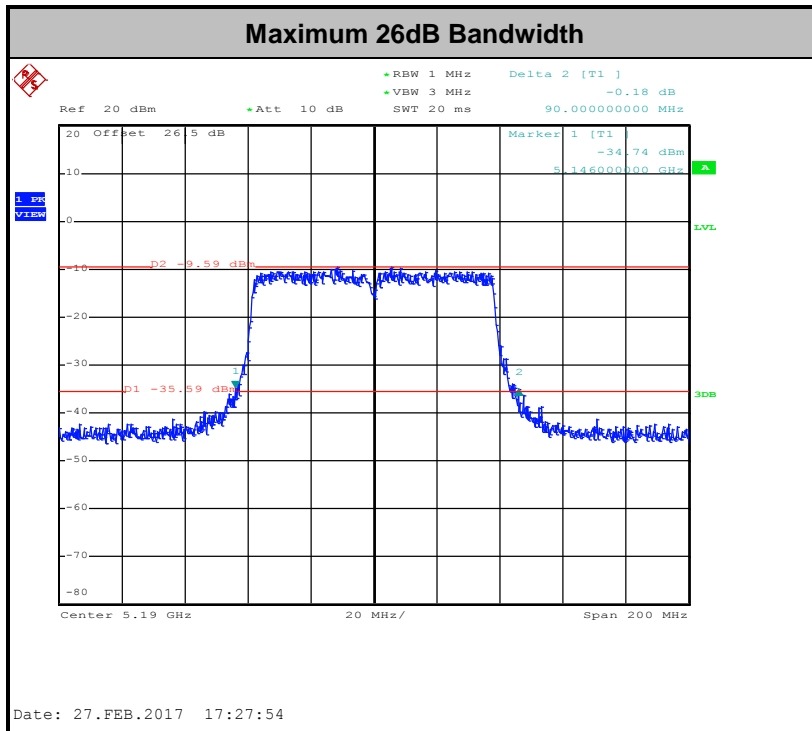

Note: The occupied channel bandwidth is maintained within the band of operation for all of the modulations.



3.2 Maximum Conducted Output Power Measurement

3.2.1 Limit of Maximum Conducted Output Power

PTP

For fixed point-to-point access points operating in the band 5.15-5.25 GHz, the maximum conducted output power over the frequency band of operation shall not exceed 1 W.

Fixed point-to-point U-NII devices may employ antennas with directional gain up to 23 dBi without any corresponding reduction in the maximum conducted output power.

For fixed point-to-point transmitters that employ a directional antenna gain greater than 23 dBi, a 1 dB reduction in maximum conducted output power is required for each 1 dB of antenna gain in excess of 23 dBi.

PTMP

For an outdoor access point operating in the band 5.15-5.25 GHz, the maximum conducted output power over the frequency band of operation shall not exceed 1 W provided the maximum antenna gain does not exceed 6 dBi.

If transmitting antennas of directional gain greater than 6 dBi are used, the peak output power shall be reduced by the amount in dB that the directional gain of the antenna exceeds 6 dBi.

The maximum e.i.r.p. at any elevation angle above 30 degrees as measured from the horizon must not exceed 125 mW (21 dBm).

Note that U-NII-2 band, devices with a maximum e.i.r.p. greater than 500 mW shall implement TPC in order to have the capability to operate at least 6 dB below the maximum permitted e.i.r.p. of 1 W.

3.2.2 Measuring Instruments

The measuring equipment is listed in the section 4 of this test report.

3.2.3 Test Procedures

The testing follows Method PM of FCC KDB 789033 D02 General UNII Test Procedures New Rules v01r03 for CDD modes.

Method PM (Measurement using an RF average power meter):

1. Measurement is performed using a wideband RF power meter.
2. The EUT is configured to transmit continuously with a consistent duty cycle at its maximum power control level.
3. Measure the average power of the transmitter, and the average power is corrected with duty factor, $10 \log(1/x)$, where x is the duty cycle.

3.2.4 Test Setup

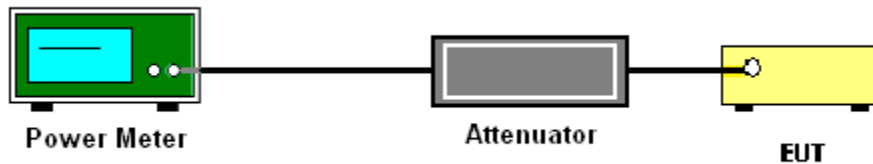

3.2.5 Test Result of Maximum Conducted Output Power

Please refer to Appendix A.



3.3 Power Spectral Density Measurement

3.3.1 Limit of Power Spectral Density

PTP

For fixed point-to-point access points operating in the band 5.15-5.25 GHz, the maximum power spectral density shall not exceed 17 dBm in any 1 megahertz band. Fixed point-to-point U-NII devices may employ antennas with directional gain up to 23 dBi without any corresponding reduction in the maximum power spectral density. For fixed point-to-point transmitters that employ a directional antenna gain greater than 23 dBi, a 1 dB reduction in maximum power spectral density is required for each 1 dB of antenna gain in excess of 23 dBi.

PTMP

For an outdoor access point operating in the band 5.15-5.25 GHz, the maximum power spectral density shall not exceed 17 dBm in any 1 megahertz band. If transmitting antennas of directional gain greater than 6 dBi are used, the peak output power shall be reduced by the amount in dB that the directional gain of the antenna exceeds 6 dBi.

3.3.2 Measuring Instruments

The measuring equipment is listed in the section 4 of this test report.

3.3.3 Test Procedures

The testing follows FCC KDB 789033 D02 General UNII Test Procedures New Rules v01r03. Section F) Maximum power spectral density.

Method SA-2

(trace averaging across on and off times of the EUT transmissions, followed by duty cycle correction).

- Measure the duty cycle.
- Set span to encompass the entire emission bandwidth (EBW) of the signal.
- Set RBW = 1 MHz.
- Set VBW \geq 3 MHz.
- Number of points in sweep \geq 2 Span / RBW.
- Sweep time = auto.
- Detector = RMS
- Trace average at least 100 traces in power averaging mode.
- Add $10 \log(1/x)$, where x is the duty cycle, to the measured power in order to compute the average power during the actual transmission times. For example, add $10 \log(1/0.25) = 6$ dB if the duty cycle is 25 percent.

1. The RF output of EUT was connected to the spectrum analyzer by a low loss cable.
2. Each plot has already offset with cable loss, and attenuator loss. Measure the PPSD and record it.
3. For MIMO mode, calculation method follows FCC KDB 662911 D01 Multiple Transmitter Output v02r01.

Method (a): Measure and sum the spectra across the outputs.

The total final Power Spectral Density is from a device with 2 transmitter outputs. The spectrum measurements of the individual outputs are all performed with the same span and number of points, the spectrum value in the first spectral bin of output 1 is summed with that in the first spectral bin of output 2 to obtain the value for the first frequency bin of the summed spectrum.

3.3.4 Test Setup

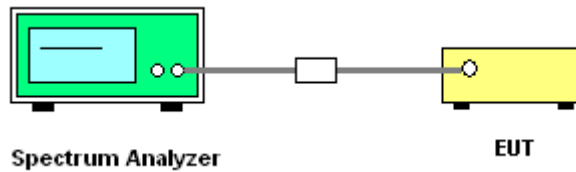

3.3.5 Test Result of Power Spectral Density

Please refer to Appendix A.



<PTP>

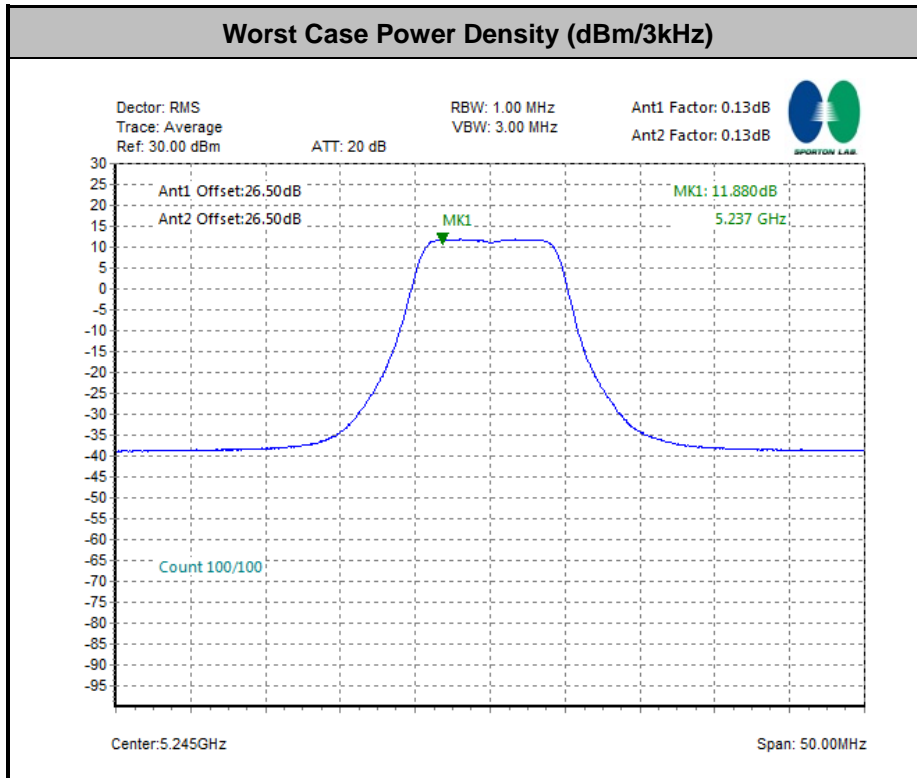

<PTMP>

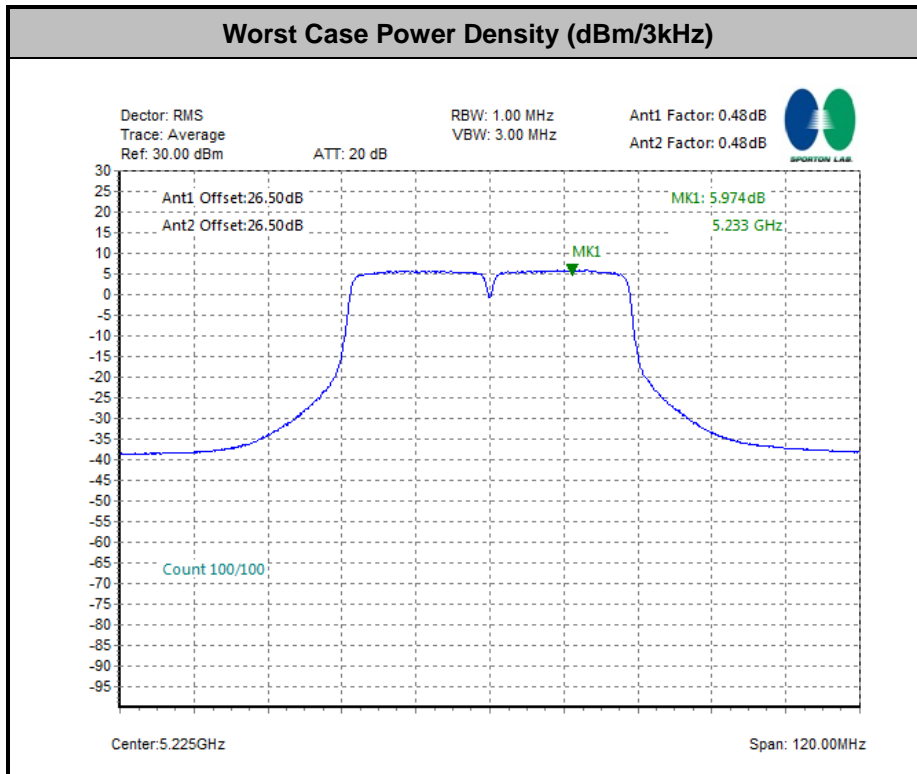



3.4 Unwanted Emissions Measurement

This section as specified in FCC Part 15.407(b) is to measure unwanted emissions through radiated measurement for band edge spurious emissions and out of band emissions measurement. The unwanted emissions shall comply with 15.407(b)(1) to (6), and restricted bands per FCC Part15.205.

3.4.1 Limit of Unwanted Emissions

- (1) For transmitters operating in the 5150-5250 MHz band: all emissions outside of the 5150-5350 MHz band shall not exceed an EIRP of -27dBm/MHz.
- (2) Unwanted spurious emissions fallen in restricted bands per FCC Part15.205 shall comply with the general field strength limits set forth in § 15.209 as below table,

Frequency (MHz)	Field Strength (microvolts/meter)	Measurement Distance (meters)
0.009 – 0.490	2400/F(kHz)	300
0.490 – 1.705	24000/F(kHz)	30
1.705 – 30.0	30	30
30 – 88	100	3
88 – 216	150	3
216 - 960	200	3
Above 960	500	3

Note: The following formula is used to convert the EIRP to field strength.

$$E = \frac{1000000\sqrt{30P}}{3} \mu\text{V/m, where P is the eirp (Watts)}$$

EIRP (dBm)	Field Strength at 3m (dBµV/m)
-17	78.3
- 27	68.3

- (3) KDB789033 D02 v01r03 G)2)c) As specified in 15.407(b), emissions above 1000 MHz that are outside of the restricted bands are subject to a peak emission limit of -27 dBm/MHz (or -17 dBm/MHz as specified in 15.407(b)(4)). However, an out-of-band emission that complies with both the average and peak limits of 15.209 is not required to satisfy the -27 dBm/MHz or -17 dBm/MHz peak emission limit.

3.4.2 Measuring Instruments

The measuring equipment is listed in the section 4 of this test report.



3.4.3 Test Procedures

1. The testing follows FCC KDB 789033 D02 General UNII Test Procedures New Rules v01r03. Section G) Unwanted emissions measurement.
 - (1) Procedure for Unwanted Emissions Measurements Below 1000MHz
 - RBW = 120 kHz
 - VBW = 300 kHz
 - Detector = Peak
 - Trace mode = max hold
 - (2) Procedure for Peak Unwanted Emissions Measurements Above 1000 MHz
 - RBW = 1 MHz
 - VBW \geq 3 MHz
 - Detector = Peak
 - Sweep time = auto
 - Trace mode = max hold
 - (3) Procedures for Average Unwanted Emissions Measurements Above 1000MHz
 - RBW = 1 MHz
 - VBW = 10 Hz, when duty cycle is no less than 98 percent.
 - VBW \geq 1/T, when duty cycle is less than 98 percent where T is the minimum transmission duration over which the transmitter is on and is transmitting at its maximum power control level for the tested mode of operation.
2. The EUT was placed on a turntable with 0.8 meter for frequency below 1GHz and 1.5 meter for frequency above 1GHz respectively above ground.
3. The EUT was set 3 meters from the interference receiving antenna which was mounted on the top of a variable height antenna tower.
4. The antenna is a broadband antenna and its height is adjusted between one meter and four meters above ground to find the maximum value of the field strength for both horizontal polarization and vertical polarization of the antenna.
5. For each suspected emission, the EUT was arranged to its worst case and then adjust the antenna tower (from 1 m to 4 m) and turntable (from 0 degree to 360 degrees) to find the maximum reading.
6. For testing below 1GHz, if the emission level of the EUT in peak mode was 3 dB lower than the limit specified, then peak values of EUT will be reported, otherwise, the emissions will be repeated one by one using the CISPR quasi-peak method and reported.
7. For testing above 1GHz, the emission level of the EUT in peak mode was 20dB lower than average limit (that means the emission level in average mode also complies with the limit in average mode), then peak values of EUT will be reported, otherwise, the emissions will be measured in average mode again and reported.

3.4.4 Test Setup

For radiated emissions below 30MHz

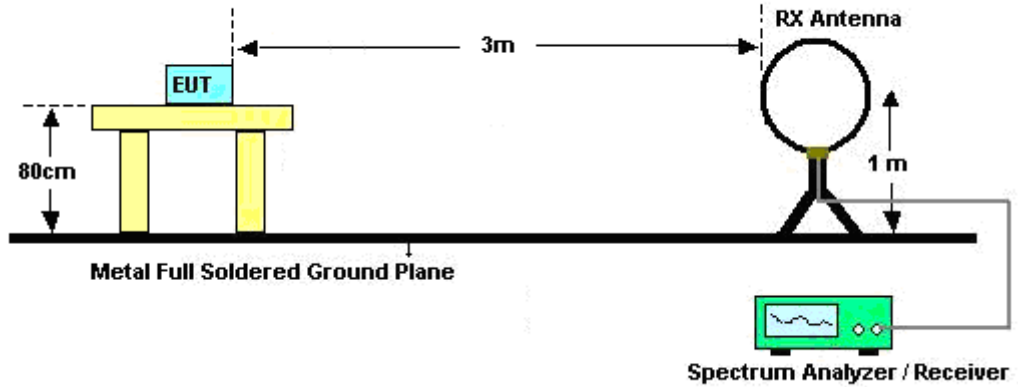

For radiated emissions from 30MHz to 1GHz

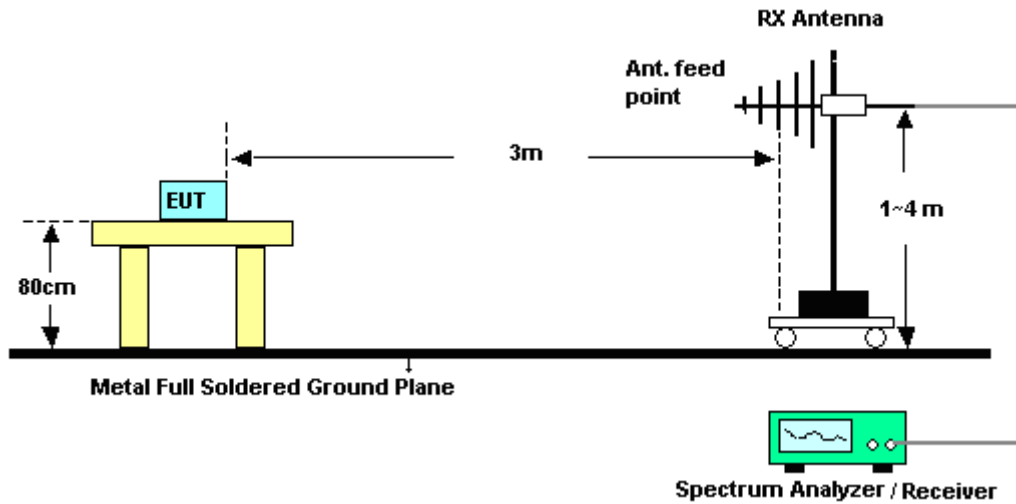

For radiated emissions above 1GHz

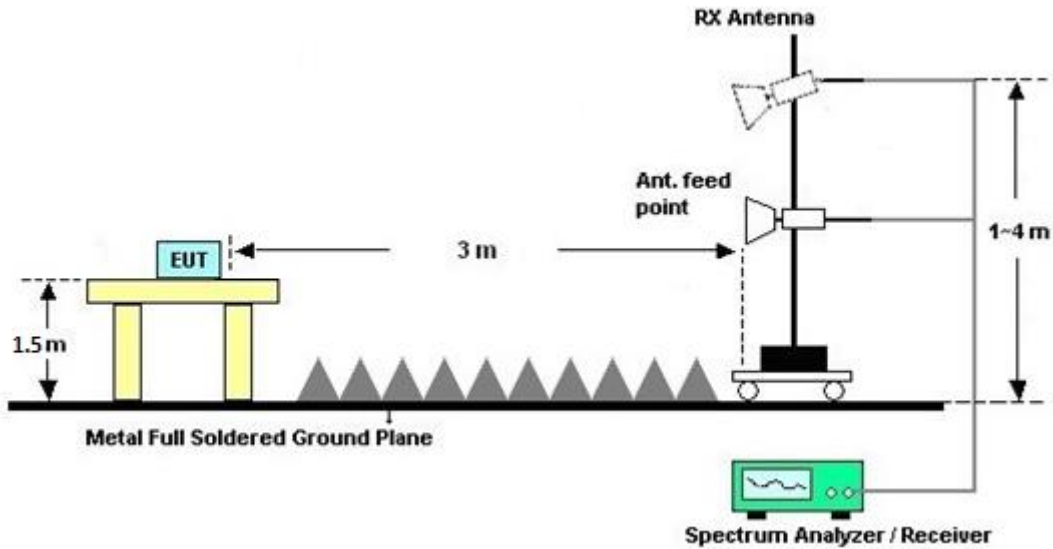

3.4.5 Test Results of Radiated Spurious Emissions (9 kHz ~ 30 MHz)

The low frequency, which started from 9 kHz to 30MHz, was pre-scanned and the result which was 20dB lower than the limit line per 15.31(o) was not reported.

3.4.6 Test Result of Radiated Spurious at Band Edges

Please refer to Appendix C and D.

3.4.7 Duty Cycle

Please refer to Appendix E.

3.4.8 Test Result of Radiated Spurious Emissions (30MHz ~ 10th Harmonic)

Please refer to Appendix C and D.



3.5 AC Conducted Emission Measurement

3.5.1 Limit of AC Conducted Emission

For equipment that is designed to be connected to the public utility (AC) power line, the radio frequency voltage that is conducted back onto the AC power line on any frequency or frequencies within the band 150 kHz to 30 MHz shall not exceed the limits in the following table.

Frequency of emission (MHz)	Conducted limit (dB μ V)	
	Quasi-peak	Average
0.15-0.5	66 to 56*	56 to 46*
0.5-5	56	46
5-30	60	50

*Decreases with the logarithm of the frequency.

3.5.2 Measuring Instruments

The measuring equipment is listed in the section 4 of this test report.

3.5.3 Test Procedures

1. The EUT was placed 0.4 meter from the conducting wall of the shielding room was kept at least 80 centimeters from any other grounded conducting surface.
2. Connect EUT to the power mains through a line impedance stabilization network (LISN).
3. All the support units are connecting to the other LISN.
4. The LISN provides 50 ohm coupling impedance for the measuring instrument.
5. The FCC states that a 50 ohm, 50 microhenry LISN should be used.
6. Both sides of AC line were checked for maximum conducted interference.
7. The frequency range from 150 kHz to 30 MHz was searched.
8. Set the test-receiver system to Peak Detect Function and specified bandwidth with Maximum Hold Mode.

3.5.4 Test Setup

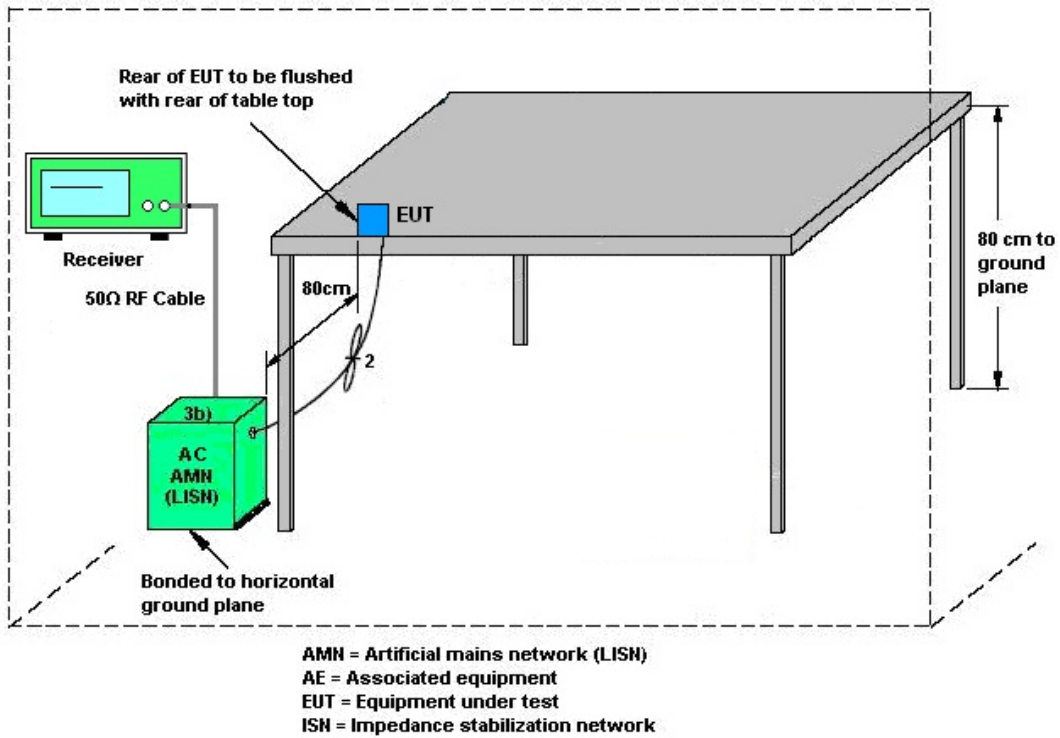

3.5.5 Test Result of AC Conducted Emission

Please refer to Appendix B.

3.6 Frequency Stability Measurement

3.6.1 Limit of Frequency Stability

Manufacturers of U-NII devices are responsible for ensuring frequency stability such that an emission is maintained within the band of operation under all conditions of normal operation as specified in the user's manual.

3.6.2 Measuring Instruments

The measuring equipment is listed in the section 4 of this test report.

3.6.3 Test Procedures

1. To ensure emission at the band edge is maintained within the authorized band, those values shall be measured by radiation emissions at upper and lower frequency points, and finally compensated by frequency deviation as procedures below.
2. The EUT was operated at the maximum output power, and connected to the spectrum analyzer, which is set to maximum hold function and peak detector. The peak value of the power envelope was measured and noted. The upper and lower frequency points were respectively measured relatively 10dB lower than the measured peak value.
3. The frequency deviation was calculated by adding the upper frequency point and the lower frequency point divided by two. Those detailed values of frequency deviation are provided in table below.

3.6.4 Test Setup



3.6.5 Test Result of Frequency Stability

Please refer to Appendix A.



3.7 Automatically Discontinue Transmission

3.7.1 Limit of Automatically Discontinue Transmission

The device shall automatically discontinue transmission in case of either absence of information to transmit or operational failure. These provisions are not intended to preclude the transmission of control or signaling information or the use of repetitive codes used by certain digital technologies to complete frame or burst intervals. Applicants shall include in their application for equipment authorization to describe how this requirement is met.

3.7.2 Measuring Instruments

The measuring equipment is listed in the section 4 of this test report.

3.7.3 Test Result of Automatically Discontinue Transmission

While the EUT is not transmitting any information, the EUT can automatically discontinue transmission and become standby mode for power saving. The EUT can detect the controlling signal of ACK message transmitting from remote device and verify whether it shall resend or discontinue transmission.



3.8 Antenna Requirements

3.8.1 Standard Applicable

According to FCC 47 CFR Section 15.407(a)(1)(2) ,if transmitting antenna directional gain is greater than 6 dBi, both the peak transmit power and the peak power spectral density shall be reduced by the amount in dB that the directional gain of the antenna exceeds 6 dBi.

3.8.2 Antenna Anti-Replacement Construction

An embedded-in antenna design is used.

3.8.3 Antenna Gain

FCC KDB 662911 D01 Multiple Transmitter Output v02r01

For CDD transmissions, directional gain is calculated as

Directional gain = G_{ANT} + Array Gain, where Array Gain is as follows.

For power spectral density (PSD) measurements on all devices,

Array Gain = $10 \log(N_{ANT}/N_{SS}=1)$ dB.

For power measurements on IEEE 802.11 devices,

Array Gain = 0 dB (i.e., no array gain) for $N_{ANT} \leq 4$.

Directional gain may be calculated by using the formulas applicable to equal gain antennas with G_{ANT} set equal to the gain of the antenna having the highest gain;

The EUT supports CDD mode.

For power, the directional gain G_{ANT} is set equal to the antenna having the highest gain, i.e., F)2)f)i).

For PSD, the directional gain calculation is following F)2)f)ii) of KDB 662911 D01 v02r01.

The power and PSD limit should be modified if the directional gain of EUT is over 6 dBi,

The directional gain "DG" is calculated as following table.

<PTP>

			DG	DG	Power	PSD
			for	for	Limit	Limit
	Ant 1	Ant 2	Power	PSD	Reduction	Reduction
	(dBi)	(dBi)	(dBi)	(dBi)	(dB)	(dB)
Band I	14.00	14.00	14.00	17.01	0.00	0.00



<PTMP>

			DG	DG	Power	PSD
			for	for	Limit	Limit
	Ant 1	Ant 2	Power	PSD	Reduction	Reduction
	(dBi)	(dBi)	(dBi)	(dBi)	(dB)	(dB)
Band I	14.00	14.00	14.00	17.01	8.00	11.01

Power limit reduction = Composite gain – 6dBi, (min = 0)

PSD limit reduction = Composite gain + PSD Array gain – 6dBi, (min = 0)



4 List of Measuring Equipment

Instrument	Manufacturer	Model No.	Serial No.	Characteristics	Calibration Date	Test Date	Due Date	Remark
Power Meter	Anritsu	ML2495A	0932001	300MHz~40GHz	Sep. 29, 2016	Feb. 23, 2017 ~ Mar. 08, 2017	Sep. 28, 2017	Conducted (TH05-HY)
Power Sensor	Anritsu	MA2411B	0846202	300MHz~40GHz	Sep. 29, 2016	Feb. 23, 2017 ~ Mar. 08, 2017	Sep. 28, 2017	Conducted (TH05-HY)
Spectrum Analyzer	Rohde & Schwarz	FSP40	100055	9kHz-40GHz	Jul. 17, 2016	Feb. 23, 2017 ~ Mar. 08, 2017	Jul. 16, 2017	Conducted (TH05-HY)
Temperature Chamber	ESPEC	SH-641	92013720	-40°C ~90°C	Sep. 01, 2016	Feb. 23, 2017 ~ Mar. 08, 2017	Aug. 31, 2017	Conducted (TH05-HY)
AC Power Source	ChainTek	APC-1000W	N/A	N/A	N/A	Feb. 17, 2017	N/A	Conduction (CO05-HY)
EMI Test Receiver	Rohde & Schwarz	ESCI 7	100724	9kHz~7GHz	Aug. 30, 2016	Feb. 17, 2017	Aug. 29, 2017	Conduction (CO05-HY)
LISN	Rohde & Schwarz	ENV216	100080	9kHz~30MHz	Nov. 29, 2016	Feb. 17, 2017	Nov. 28, 2017	Conduction (CO05-HY)
LISN	Rohde & Schwarz	ENV216	100081	9kHz~30MHz	Dec. 06, 2016	Feb. 17, 2017	Dec. 05, 2017	Conduction (CO05-HY)
Amplifier	SONOMA	310N	187311	9kHz~1GHz	Oct. 26, 2016	Feb. 13, 2017 ~ Mar. 06, 2017	Oct. 25, 2017	Radiation (03CH10-HY)
Bilog Antenna	TESEQ	CBL 6111D&00800 N1D01N-06	35413&02	30MHz~1GHz	Jan. 07, 2017	Feb. 13, 2017 ~ Mar. 06, 2017	Jan. 06, 2018	Radiation (03CH10-HY)
Horn Antenna	SCHWARZBECK	BBHA 9120 D	9120D-1325	1GHz ~ 18GHz	Sep. 30, 2016	Feb. 13, 2017 ~ Mar. 06, 2017	Sep. 29, 2017	Radiation (03CH10-HY)
Preamplifier	Keysight	83017A	MY53270078	1GHz~26.5GHz	Oct. 26, 2016	Feb. 13, 2017 ~ Mar. 06, 2017	Oct. 25, 2017	Radiation (03CH10-HY)
Spectrum Analyzer	Keysight	N9010A	MY54200485	10Hz ~ 44GHz	Oct. 17, 2016	Feb. 13, 2017 ~ Mar. 06, 2017	Oct. 16, 2017	Radiation (03CH10-HY)
Antenna Mast	EMEC	AM-BS-4500-B	N/A	1~4m	N/A	Feb. 13, 2017 ~ Mar. 06, 2017	N/A	Radiation (03CH10-HY)
Turn Table	EMEC	TT 2200	N/A	0~360 Degree	N/A	Feb. 13, 2017 ~ Mar. 06, 2017	N/A	Radiation (03CH10-HY)
Loop Antenna	Rohde & Schwarz	HFH2-Z2	100488	9 kHz~30 MHz	Oct. 20, 2016	Feb. 13, 2017 ~ Mar. 06, 2017	Oct. 19, 2018	Radiation (03CH10-HY)
Preamplifier	Jet-Power	JPA00101800-30-10P	1601180002	1GHz~18GHz	Jul. 27, 2016	Feb. 13, 2017 ~ Mar. 06, 2017	Jul. 26, 2017	Radiation (03CH10-HY)
SHF-EHF Horn Antenna	SCHWARZBECK	BBHA 9170	BBHA9170576	18GHz ~ 40GHz	Apr. 15, 2016	Feb. 13, 2017 ~ Mar. 06, 2017	Apr. 14, 2017	Radiation (03CH10-HY)
EMI Test Receiver	Keysight	N9038A(MXE)	MY55420170	N/A	Mar. 10, 2016	Feb. 13, 2017 ~ Mar. 06, 2017	Mar. 09, 2017	Radiation (03CH10-HY)
Preamplifier	MITEQ	JS44-1800400-0-33-8P	1840917	18GHz ~ 40GHz	Jun. 14, 2016	Feb. 13, 2017 ~ Mar. 06, 2017	Jun. 13, 2017	Radiation (03CH10-HY)
Preamplifier	MITEQ	AMF-7D-00101800	2025787	1GHZ~18GHZ	Feb. 13, 2017	Feb. 13, 2017 ~ Mar. 06, 2017	Feb. 12, 2018	Radiation (03CH10-HY)



5 Uncertainty of Evaluation

Uncertainty of Conducted Emission Measurement (150kHz ~ 30MHz)

Measuring Uncertainty for a Level of Confidence of 95% ($U = 2Uc(y)$)	2.7
---	-----

Uncertainty of Radiated Emission Measurement (30 MHz ~ 1000 MHz)

Measuring Uncertainty for a Level of Confidence of 95% ($U = 2Uc(y)$)	5.6
---	-----

Uncertainty of Radiated Emission Measurement (1000 MHz ~ 18000 MHz)

Measuring Uncertainty for a Level of Confidence of 95% ($U = 2Uc(y)$)	5.9
---	-----

Uncertainty of Radiated Emission Measurement (18000 MHz ~ 40000 MHz)

Measuring Uncertainty for a Level of Confidence of 95% ($U = 2Uc(y)$)	5.2
---	-----



Appendix A. Conducted Test Results

<PTP>

Test Engineer:	Kal Liao	Temperature:	21~25	°C
Test Date:	2017/2/23 ~2017/03/08	Relative Humidity:	51~54	%

TEST RESULTS DATA
26dB and 99% OBW

Band I													
Mod.	Data Rate	NTX	CH.	Freq. (MHz)	99% Bandwidth (MHz)		26 dB Bandwidth (MHz)		IC 99% Bandwidth Power Limit (dBm)		IC 99% Bandwidth EIRP Limit (dBm)		Note
					Ant 1	Ant 2	Ant 1	Ant 2	Ant 1	Ant 2	Ant 1	Ant 2	
VHT10	VT0	2	32	5160	10.08	10.08	13.70	13.40	-	-	20.03	-	
VHT10	VT0	2	40	5200	10.23	10.08	13.60	13.63	-	-	20.03	-	
VHT10	VT0	2	49	5245	10.10	10.03	14.10	14.10	-	-	20.01	-	
VHT20	VT0	2	33	5165	18.60	18.75	24.90	24.20	-	-	22.70	-	
VHT20	VT0	2	40	5200	18.70	18.80	24.70	25.05	-	-	22.72	-	
VHT20	VT0	2	48	5240	18.75	18.75	25.20	24.95	-	-	22.73	-	
VHT30	VT0	2	34	5170	27.83	27.68	36.90	36.00	-	-	23.01	-	
VHT30	VT0	2	40	5200	27.75	27.68	36.00	37.05	-	-	23.01	-	
VHT30	VT0	2	47	5235	27.90	27.60	36.15	36.60	-	-	23.01	-	
VHT40	VT0	2	35	5175	36.70	36.80	45.80	44.80	-	-	23.01	-	
VHT40	VT0	2	40	5200	36.90	36.80	45.80	44.40	-	-	23.01	-	
VHT40	VT0	2	46	5230	36.80	36.90	46.02	43.90	-	-	23.01	-	
VHT50	VT0	2	36	5180	44.88	44.88	54.75	54.00	-	-	23.01	-	
VHT50	VT0	2	40	5200	45.13	45.00	56.50	55.00	-	-	23.01	-	
VHT50	VT0	2	45	5225	44.88	45.00	55.00	56.25	-	-	23.01	-	
VHT60	VT0	2	37	5185	55.05	55.05	66.90	65.10	-	-	23.01	-	
VHT60	VT0	2	40	5200	55.20	55.50	67.20	68.40	-	-	23.01	-	
VHT60	VT0	2	44	5220	55.50	55.20	67.88	65.70	-	-	23.01	-	
VHT80	VT0	2	38	5190	76.20	76.00	90.00	88.60	-	-	23.01	-	
VHT80	VT0	2	40	5200	75.80	76.00	87.20	86.00	-	-	23.01	-	
VHT80	VT0	2	42	5210	75.60	75.80	86.00	85.20	-	-	23.01	-	

TEST RESULTS DATA
Average Power Table

FCC Band I														
Mod.	Data Rate	NTX	CH.	Freq. (MHz)	Duty Factor (dB)		Average Conducted Power (dBm)			FCC Conducted Power Limit (dBm)		DG (dBi)		Pass/Fail
					Ant 1	Ant 2	Ant 1	Ant 2	SUM	Ant 1	Ant 2	Ant 1	Ant 2	
VHT10	VT0	2	32	5160	0.13	0.13	9.79	9.83	12.83	30.00	14.00		Pass	
VHT10	VT0	2	40	5200	0.13	0.13	18.04	17.31	20.71	30.00	14.00		Pass	
VHT10	VT0	2	49	5245	0.13	0.13	18.10	17.98	21.06	30.00	14.00		Pass	
VHT20	VT0	2	33	5165	0.20	0.26	7.70	7.99	10.86	30.00	14.00		Pass	
VHT20	VT0	2	40	5200	0.20	0.26	17.99	17.40	20.72	30.00	14.00		Pass	
VHT20	VT0	2	48	5240	0.20	0.26	18.12	17.90	21.02	30.00	14.00		Pass	
VHT30	VT0	2	34	5170	0.33	0.30	2.68	2.56	5.63	30.00	14.00		Pass	
VHT30	VT0	2	40	5200	0.33	0.30	17.46	16.85	20.18	30.00	14.00		Pass	
VHT30	VT0	2	47	5235	0.33	0.30	18.23	18.03	21.14	30.00	14.00		Pass	
VHT40	VT0	2	35	5175	0.43	0.40	3.52	3.65	6.60	30.00	14.00		Pass	
VHT40	VT0	2	40	5200	0.43	0.40	21.11	20.41	23.78	30.00	14.00		Pass	
VHT40	VT0	2	46	5230	0.43	0.40	21.00	20.62	23.82	30.00	14.00		Pass	
VHT50	VT0	2	36	5180	0.48	0.48	4.68	5.10	7.90	30.00	14.00		Pass	
VHT50	VT0	2	40	5200	0.48	0.48	20.64	20.06	23.37	30.00	14.00		Pass	
VHT50	VT0	2	45	5225	0.48	0.48	21.02	20.59	23.82	30.00	14.00		Pass	
VHT60	VT0	2	37	5185	0.66	0.59	3.86	4.25	7.07	30.00	14.00		Pass	
VHT60	VT0	2	40	5200	0.66	0.59	15.20	14.76	17.99	30.00	14.00		Pass	
VHT60	VT0	2	44	5220	0.66	0.59	21.17	20.70	23.95	30.00	14.00		Pass	
VHT80	VT0	2	38	5190	0.48	0.48	0.63	1.26	3.97	30.00	14.00		Pass	
VHT80	VT0	2	40	5200	0.48	0.48	6.40	6.58	9.50	30.00	14.00		Pass	
VHT80	VT0	2	42	5210	0.66	0.59	11.87	12.03	14.96	30.00	14.00		Pass	

TEST RESULTS DATA
Power Spectral Density

FCC Band I														
Mod.	Data Rate	NTX	CH.	Freq. (MHz)	Duty Factor (dB)		Average Power Density (dBm/MHz)			Average PSD Limit (dBm/MHz)		DG (dBi)		Pass /Fail
					Ant 1	Ant 2	Ant 1	Ant 2	SUM	Ant 1	Ant 2	Ant 1	Ant 2	
VHT10	VT0	2	32	5160	0.13	0.13			3.86	17.00	17.01		Pass	
VHT10	VT0	2	40	5200	0.13	0.13			11.36	17.00	17.01		Pass	
VHT10	VT0	2	49	5245	0.13	0.13			11.88	17.00	17.01		Pass	
VHT20	VT0	2	33	5165	0.20	0.26			-1.23	17.00	17.01		Pass	
VHT20	VT0	2	40	5200	0.20	0.26			8.63	17.00	17.01		Pass	
VHT20	VT0	2	48	5240	0.20	0.26			9.13	17.00	17.01		Pass	
VHT30	VT0	2	34	5170	0.33	0.30			-8.65	17.00	17.01		Pass	
VHT30	VT0	2	40	5200	0.33	0.30			6.65	17.00	17.01		Pass	
VHT30	VT0	2	47	5235	0.33	0.30			7.57	17.00	17.01		Pass	
VHT40	VT0	2	35	5175	0.43	0.40			-8.74	17.00	17.01		Pass	
VHT40	VT0	2	40	5200	0.43	0.40			8.88	17.00	17.01		Pass	
VHT40	VT0	2	46	5230	0.43	0.40			9.05	17.00	17.01		Pass	
VHT50	VT0	2	36	5180	0.48	0.48			-8.43	17.00	17.01		Pass	
VHT50	VT0	2	40	5200	0.48	0.48			7.67	17.00	17.01		Pass	
VHT50	VT0	2	45	5225	0.48	0.48			8.36	17.00	17.01		Pass	
VHT60	VT0	2	37	5185	0.66	0.59			-10.42	17.00	17.01		Pass	
VHT60	VT0	2	40	5200	0.66	0.59			1.75	17.00	17.01		Pass	
VHT60	VT0	2	44	5220	0.66	0.59			7.72	17.00	17.01		Pass	
VHT80	VT0	2	38	5190	0.83	0.81			-14.86	17.00	17.01		Pass	
VHT80	VT0	2	40	5200	0.83	0.81			-9.31	17.00	17.01		Pass	
VHT80	VT0	2	42	5210	0.83	0.81			-3.94	17.00	17.01		Pass	

TEST RESULTS DATA
Frequency Stability

Band I										
Mod.	Data Rate	NTX	CH.	Freq. (MHz)	Center Frequency (MHz)	Frequency Deviation (MHz)	Frequency Stability (ppm)	Temperature (°C)	Voltage (V)	Note
VHT10	MCS0	1	32	5160	5159.963	-0.038	-7.27	50	3.7	
VHT10	MCS0	1	32	5160	5159.988	-0.012	-2.42	-30	3.7	
VHT10	MCS0	1	32	5160	5159.988	-0.012	-2.42	20	4.2	
VHT10	MCS0	1	32	5160	5159.988	-0.012	-2.42	20	3.2	
VHT10	MCS0	1	32	5160	5159.950	-0.050	-9.69	20	3.7	



<PTMP>

Test Engineer:	Kal Liao	Temperature:	21~25	°C
Test Date:	2017/02/23 ~2017/03/08	Relative Humidity:	51~54	%

TEST RESULTS DATA
26dB and 99% OBW

Band I													
Mod.	Data Rate	NTX	CH.	Freq. (MHz)	99% Bandwidth (MHz)		26 dB Bandwidth (MHz)		IC 99% Bandwidth Power Limit (dBm)		IC 99% Bandwidth EIRP Limit (dBm)		Note
					Ant 1	Ant 2	Ant 1	Ant 2	Ant 1	Ant 2	Ant 1	Ant 2	
VHT10	VT0	2	32	5160	10.08	10.08	13.70	13.40	-	-	20.03	-	
VHT10	VT0	2	40	5200	10.25	10.23	14.05	13.65	-	-	20.10	-	
VHT10	VT0	2	49	5245	10.25	10.10	13.65	14.03	-	-	20.04	-	
VHT20	VT0	2	33	5165	18.60	18.75	24.90	24.20	-	-	22.70	-	
VHT20	VT0	2	40	5200	18.70	18.70	25.10	25.10	-	-	22.72	-	
VHT20	VT0	2	48	5240	18.70	18.65	24.85	25.60	-	-	22.71	-	
VHT30	VT0	2	34	5170	27.83	27.68	36.90	36.00	-	-	23.01	-	
VHT30	VT0	2	40	5200	27.60	27.60	38.10	36.75	-	-	23.01	-	
VHT30	VT0	2	47	5235	27.68	27.90	36.45	37.20	-	-	23.01	-	
VHT40	VT0	2	35	5175	36.70	36.80	45.80	44.80	-	-	23.01	-	
VHT40	VT0	2	40	5200	36.90	37.00	46.40	44.80	-	-	23.01	-	
VHT40	VT0	2	46	5230	36.90	36.70	45.70	46.20	-	-	23.01	-	
VHT50	VT0	2	36	5180	44.88	44.88	54.75	54.00	-	-	23.01	-	
VHT50	VT0	2	40	5200	44.88	44.88	55.50	54.38	-	-	23.01	-	
VHT50	VT0	2	45	5225	44.88	45.00	55.25	55.25	-	-	23.01	-	
VHT60	VT0	2	37	5185	55.05	55.05	66.90	65.10	-	-	23.01	-	
VHT60	VT0	2	40	5200	55.20	55.50	67.20	68.40	-	-	23.01	-	
VHT60	VT0	2	44	5220	55.20	55.05	66.30	66.60	-	-	23.01	-	
VHT80	VT0	2	38	5190	76.20	76.00	90.00	88.60	-	-	23.01	-	
VHT80	VT0	2	40	5200	75.80	76.00	87.20	86.00	-	-	23.01	-	
VHT80	VT0	2	42	5210	75.60	75.80	86.00	85.20	-	-	23.01	-	

TEST RESULTS DATA
Average Power Table

FCC Band I														
Mod.	Data Rate	NTX	CH.	Freq. (MHz)	Duty Factor (dB)		Average Conducted Power (dBm)			FCC Conducted Power Limit (dBm)		DG (dBi)		Pass/Fail
					Ant 1	Ant 2	Ant 1	Ant 2	SUM	Ant 1	Ant 2	Ant 1	Ant 2	
VHT10	VT0	2	32	5160	0.13	0.13	9.79	9.83	12.83	22.00	14.00		Pass	
VHT10	VT0	2	40	5200	0.13	0.13	11.65	11.08	14.39	22.00	14.00		Pass	
VHT10	VT0	2	49	5245	0.13	0.13	11.57	11.17	14.39	22.00	14.00		Pass	
VHT20	VT0	2	33	5165	0.20	0.26	7.70	7.99	10.86	22.00	14.00		Pass	
VHT20	VT0	2	40	5200	0.20	0.26	14.36	13.67	17.04	22.00	14.00		Pass	
VHT20	VT0	2	48	5240	0.20	0.26	14.31	13.79	17.07	22.00	14.00		Pass	
VHT30	VT0	2	34	5170	0.33	0.30	2.68	2.56	5.63	22.00	14.00		Pass	
VHT30	VT0	2	40	5200	0.33	0.30	16.46	15.81	19.16	22.00	14.00		Pass	
VHT30	VT0	2	47	5235	0.33	0.30	16.47	16.03	19.27	22.00	14.00		Pass	
VHT40	VT0	2	35	5175	0.43	0.40	3.52	3.65	6.60	22.00	14.00		Pass	
VHT40	VT0	2	40	5200	0.43	0.40	17.61	16.98	20.32	22.00	14.00		Pass	
VHT40	VT0	2	46	5230	0.43	0.40	17.61	17.13	20.39	22.00	14.00		Pass	
VHT50	VT0	2	36	5180	0.48	0.48	4.68	5.10	7.90	22.00	14.00		Pass	
VHT50	VT0	2	40	5200	0.48	0.48	18.57	17.88	21.25	22.00	14.00		Pass	
VHT50	VT0	2	45	5225	0.48	0.48	18.50	18.09	21.31	22.00	14.00		Pass	
VHT60	VT0	2	37	5185	0.66	0.59	3.86	4.25	7.07	22.00	14.00		Pass	
VHT60	VT0	2	40	5200	0.66	0.59	15.20	14.76	17.99	22.00	14.00		Pass	
VHT60	VT0	2	44	5220	0.66	0.59	19.21	18.74	21.99	22.00	14.00		Pass	
VHT80	VT0	2	38	5190	0.48	0.48	0.63	1.26	3.97	22.00	14.00		Pass	
VHT80	VT0	2	40	5200	0.48	0.48	6.40	6.58	9.50	22.00	14.00		Pass	
VHT80	VT0	2	42	5210	0.66	0.59	11.87	12.03	14.96	22.00	14.00		Pass	

TEST RESULTS DATA
Power Spectral Density

FCC Band I														
Mod.	Data Rate	NTX	CH.	Freq. (MHz)	Duty Factor (dB)		Average Power Density (dBm/MHz)			Average PSD Limit (dBm/MHz)		DG (dBi)		Pass /Fail
					Ant 1	Ant 2	Ant 1	Ant 2	SUM	Ant 1	Ant 2	Ant 1	Ant 2	
VHT10	VT0	2	32	5160	0.13	0.13			3.86	5.99	17.01		Pass	
VHT10	VT0	2	40	5200	0.13	0.13			5.46	5.99	17.01		Pass	
VHT10	VT0	2	49	5245	0.13	0.13			5.60	5.99	17.01		Pass	
VHT20	VT0	2	33	5165	0.20	0.26			-1.23	5.99	17.01		Pass	
VHT20	VT0	2	40	5200	0.20	0.26			5.43	5.99	17.01		Pass	
VHT20	VT0	2	48	5240	0.20	0.26			5.57	5.99	17.01		Pass	
VHT30	VT0	2	34	5170	0.33	0.30			-8.65	5.99	17.01		Pass	
VHT30	VT0	2	40	5200	0.33	0.30			5.86	5.99	17.01		Pass	
VHT30	VT0	2	47	5235	0.33	0.30			5.96	5.99	17.01		Pass	
VHT40	VT0	2	35	5175	0.43	0.40			-8.74	5.99	17.01		Pass	
VHT40	VT0	2	40	5200	0.43	0.40			5.66	5.99	17.01		Pass	
VHT40	VT0	2	46	5230	0.43	0.40			5.62	5.99	17.01		Pass	
VHT50	VT0	2	36	5180	0.48	0.48			-8.43	5.99	17.01		Pass	
VHT50	VT0	2	40	5200	0.48	0.48			5.87	5.99	17.01		Pass	
VHT50	VT0	2	45	5225	0.48	0.48			5.97	5.99	17.01		Pass	
VHT60	VT0	2	37	5185	0.66	0.59			-10.42	5.99	17.01		Pass	
VHT60	VT0	2	40	5200	0.66	0.59			1.73	5.99	17.01		Pass	
VHT60	VT0	2	44	5220	0.66	0.59			5.93	5.99	17.01		Pass	
VHT80	VT0	2	38	5190	0.83	0.81			-14.86	5.99	17.01		Pass	
VHT80	VT0	2	40	5200	0.83	0.81			-9.31	5.99	17.01		Pass	
VHT80	VT0	2	42	5210	0.83	0.81			-3.94	5.99	17.01		Pass	

TEST RESULTS DATA
Frequency Stability

Band I										
Mod.	Data Rate	NTX	CH.	Freq. (MHz)	Center Frequency (MHz)	Frequency Deviation (MHz)	Frequency Stability (ppm)	Temperature (°C)	Voltage (V)	Note
VHT10	MCS0	1	32	5160	5159.963	-0.038	-7.27	50	3.7	
VHT10	MCS0	1	32	5160	5159.988	-0.012	-2.42	-30	3.7	
VHT10	MCS0	1	32	5160	5159.988	-0.012	-2.42	20	4.2	
VHT10	MCS0	1	32	5160	5159.988	-0.012	-2.42	20	3.2	
VHT10	MCS0	1	32	5160	5159.950	-0.050	-9.69	20	3.7	



Appendix B. AC Conducted Emission Test Results

Test Engineer :	Arthur Hsieh	Temperature :	20~22°C
		Relative Humidity :	50~53%

EUT Information

Report NO : 6N2223-01
 Test Mode : Mode 1
 Test Voltage : 120Vac/60Hz
 Phase : Line

ENV216 Auto Test FCC Power Bar - L

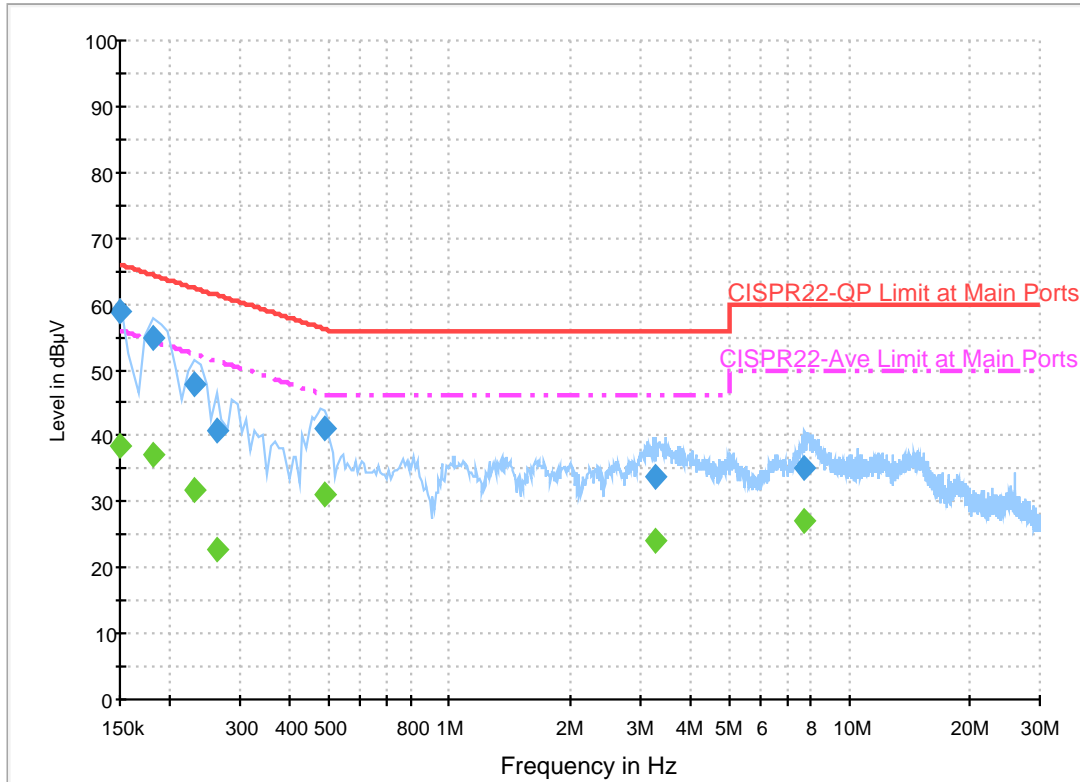

Final Result 1

Frequency (MHz)	QuasiPeak (dBµV)	Filter	Line	Corr. (dB)	Margin (dB)	Limit (dBµV)
0.150000	58.8	Off	L1	19.6	7.2	66.0
0.182000	54.9	Off	L1	19.6	9.5	64.4
0.230000	47.8	Off	L1	19.6	14.6	62.4
0.262000	40.7	Off	L1	19.6	20.7	61.4
0.486000	41.1	Off	L1	19.6	15.1	56.2
3.286000	33.9	Off	L1	19.6	22.1	56.0
7.750000	35.1	Off	L1	19.9	24.9	60.0

Final Result 2

Frequency (MHz)	Average (dBµV)	Filter	Line	Corr. (dB)	Margin (dB)	Limit (dBµV)
0.150000	38.4	Off	L1	19.6	17.6	56.0
0.182000	37.1	Off	L1	19.6	17.3	54.4
0.230000	31.7	Off	L1	19.6	20.7	52.4
0.262000	22.7	Off	L1	19.6	28.7	51.4
0.486000	31.2	Off	L1	19.6	15.0	46.2
3.286000	24.2	Off	L1	19.6	21.8	46.0
7.750000	27.0	Off	L1	19.9	23.0	50.0

EUT Information

Report NO : 6N2223-01
 Test Mode : Mode 1
 Test Voltage : 120Vac/60Hz
 Phase : Neutral

ENV216 Auto Test FCC Power Bar - N

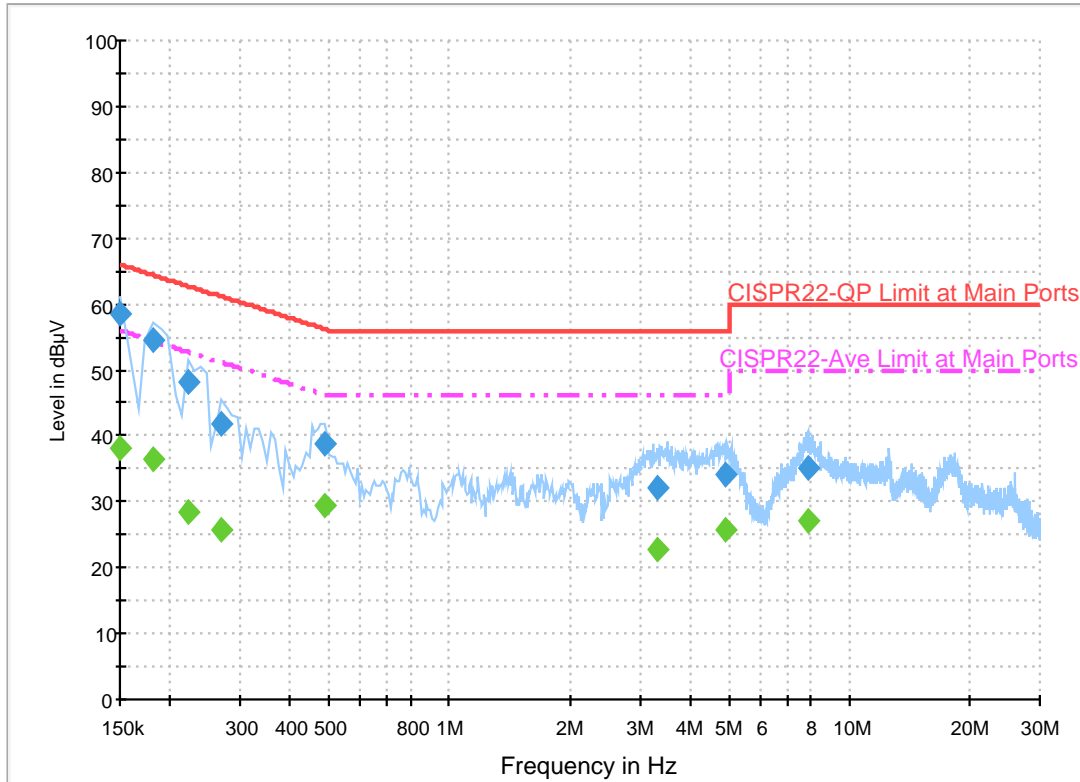

Final Result 1

Frequency (MHz)	QuasiPeak (dBµV)	Filter	Line	Corr. (dB)	Margin (dB)	Limit (dBµV)
0.150000	58.7	Off	N	19.5	7.3	66.0
0.182000	54.6	Off	N	19.5	9.8	64.4
0.222000	48.2	Off	N	19.5	14.5	62.7
0.270000	41.9	Off	N	19.5	19.2	61.1
0.486000	38.9	Off	N	19.5	17.3	56.2
3.302000	32.2	Off	N	19.6	23.8	56.0
4.902000	34.3	Off	N	19.7	21.7	56.0
7.894000	35.2	Off	N	19.9	24.8	60.0

Final Result 2

Frequency (MHz)	Average (dBµV)	Filter	Line	Corr. (dB)	Margin (dB)	Limit (dBµV)
0.150000	38.3	Off	N	19.5	17.7	56.0
0.182000	36.6	Off	N	19.5	17.8	54.4
0.222000	28.3	Off	N	19.5	24.4	52.7
0.270000	25.6	Off	N	19.5	25.5	51.1
0.486000	29.6	Off	N	19.5	16.6	46.2
3.302000	22.6	Off	N	19.6	23.4	46.0
4.902000	25.8	Off	N	19.7	20.2	46.0
7.894000	27.2	Off	N	19.9	22.8	50.0



Appendix C. Radiated Spurious Emission

Test Engineer :	Tsung Lee, Stan Hsieh, and Kyle Chuang	Temperature :	22~24°C
		Relative Humidity :	46~48%

Band 1 - 5150~5250MHz

WIFI 802.11ac VHT10 (Band Edge @ 3m)

WIFI	Note	Frequency	Level	Over	Limit	Read	Antenna	Cable	Preamp	Ant	Table	Peak	Pol.	
Ant.				Limit	Line	Level	Factor	Loss	Factor	Pos	Pos	Avg.		
1+2		(MHz)	(dBµV/m)	(dB)	(dBµV/m)	(dBµV)	(dB/m)	(dB)	(dB)	(cm)	(deg)	(P/A)	(H/V)	
802.11ac VHT10 CH 32 5160MHz		5149.5	60.03	-13.97	74	52.65	31.98	7.94	32.54	212	200	P	H	
		5150	53.36	-0.64	54	45.98	31.98	7.94	32.54	212	200	A	H	
	*	5160	106.89	-	-	99.49	32	7.94	32.54	212	200	P	H	
	*	5160	101.23	-	-	93.83	32	7.94	32.54	212	200	A	H	
													H	
													H	
													H	
													H	
													H	
													H	
			5150	56.69	-17.31	74	49.31	31.98	7.94	32.54	210	186	P	V
			5150	50.7	-3.3	54	43.32	31.98	7.94	32.54	210	186	A	V
		*	5160	106.36	-	-	98.96	32	7.94	32.54	210	186	P	V
		*	5160	100.22	-	-	92.82	32	7.94	32.54	210	186	A	V
														V
														V
													V	
													V	
													V	



WIFI Ant. 1+2	Note	Frequency (MHz)	Level (dBμV/m)	Over Limit (dB)	Limit Line (dBμV/m)	Read Level (dBμV)	Antenna Factor (dB/m)	Cable Loss (dB)	Preamp Factor (dB)	Ant Pos (cm)	Table Pos (deg)	Peak Avg. (P/A)	Pol. (H/V)	
802.11ac VTH10 CH 40 5200MHz		5127.4	53	-21	74	45.64	31.96	7.94	32.54	188	184	P	H	
		5148.72	45.24	-8.76	54	37.86	31.98	7.94	32.54	188	184	A	H	
	*	5200	116.01	-	-	108.6	32.04	7.91	32.54	188	184	P	H	
	*	5200	111.28	-	-	103.87	32.04	7.91	32.54	188	184	A	H	
		5445.84	59.47	-14.53	74	51.39	32.34	8.29	32.55	188	184	P	H	
		5416.08	51.29	-2.71	54	43.25	32.3	8.29	32.55	188	184	A	H	
														H
														H
														H
														H
														H
														H
														H
														H
														H
			5142.74	58.51	-15.49	74	51.13	31.98	7.94	32.54	221	177	P	V
			5147.42	50.16	-3.84	54	42.78	31.98	7.94	32.54	221	177	A	V
		*	5200	118.37	-	-	110.96	32.04	7.91	32.54	221	177	P	V
		*	5200	112.27	-	-	104.86	32.04	7.91	32.54	221	177	A	V
			5365.92	58.9	-15.1	74	50.91	32.24	8.29	32.54	221	177	P	V
		5350.8	51.23	-2.77	54	43.32	32.22	8.23	32.54	221	177	A	V	
													V	
													V	
													V	
													V	
													V	
													V	
													V	
													V	



WIFI Ant. 1+2	Note	Frequency (MHz)	Level (dBμV/m)	Over Limit (dB)	Limit Line (dBμV/m)	Read Level (dBμV)	Antenna Factor (dB/m)	Cable Loss (dB)	Preamp Factor (dB)	Ant Pos (cm)	Table Pos (deg)	Peak Avg. (P/A)	Pol. (H/V)	
802.11ac VTH10 CH 49 5245MHz		5140.92	53.19	-20.81	74	45.81	31.98	7.94	32.54	186	176	P	H	
		5145.6	44.82	-9.18	54	37.44	31.98	7.94	32.54	186	176	A	H	
	*	5245	118.52	-	-	110.84	32.1	8.12	32.54	186	176	P	H	
	*	5245	113.27	-	-	105.59	32.1	8.12	32.54	186	176	A	H	
		5356.56	60.06	-13.94	74	52.15	32.22	8.23	32.54	186	176	P	H	
		5354.88	52.06	-1.94	54	44.15	32.22	8.23	32.54	186	176	A	H	
														H
														H
														H
														H
			5145.6	56.17	-17.83	74	48.79	31.98	7.94	32.54	229	177	P	V
			5145.6	47.49	-6.51	54	40.11	31.98	7.94	32.54	229	177	A	V
		*	5245	117.99	-	-	110.31	32.1	8.12	32.54	229	177	P	V
		*	5245	112.77	-	-	105.09	32.1	8.12	32.54	229	177	A	V
			5356.8	58.83	-15.17	74	50.92	32.22	8.23	32.54	229	177	P	V
			5353.2	51.62	-2.38	54	43.71	32.22	8.23	32.54	229	177	A	V
														V
														V
													V	
													V	
													V	
Remark	1. No other spurious found. 2. All results are PASS against Peak and Average limit line.													



Band 4 5725~5850MHz

WIFI 802.11ac VHT10 (Harmonic @ 3m)

WIFI Ant. 1+2	Note	Frequency (MHz)	Level (dBμV/m)	Over Limit (dB)	Limit Line (dBμV/m)	Read Level (dBμV)	Antenna Factor (dB/m)	Cable Loss (dB)	Preamp Factor (dB)	Ant Pos (cm)	Table Pos (deg)	Peak Avg. (P/A)	Pol. (H/V)	
802.11ac VTH10 CH 32 5160MHz		10320	43.15	-30.85	74	53.86	39.61	11.93	62.25	100	0	P	H	
		15480	41.45	-32.55	74	50.3	38.19	14.75	61.79	100	0	P	H	
													H	
													H	
			10320	42.36	-31.64	74	53.07	39.61	11.93	62.25	100	0	P	V
			15480	40.07	-33.93	74	48.92	38.19	14.75	61.79	100	0	P	V
														V
802.11ac VTH10 CH 40 5200MHz		10400	43.22	-30.78	74	56.68	39.74	12	65.2	100	0	P	H	
		15600	40.64	-33.36	74	52.06	37.93	14.78	64.13	100	0	P	H	
													H	
													H	
			10400	44.37	-29.63	74	57.83	39.74	12	65.2	100	0	P	V
			15600	40.53	-33.47	74	51.95	37.93	14.78	64.13	100	0	P	V
														V
802.11ac VTH10 CH 49 5245MHz		10490	43.91	-30.09	74	57.18	39.87	12.06	65.2	100	0	P	H	
		15735	39.6	-34.4	74	51.51	37.71	14.81	64.43	100	0	P	H	
													H	
													H	
			10490	44.55	-29.45	74	57.82	39.87	12.06	65.2	100	0	P	V
			15735	40.55	-33.45	74	52.46	37.71	14.81	64.43	100	0	P	V
														V
Remark	1. No other spurious found.													
	2. All results are PASS against Peak and Average limit line.													



Band 4 5725~5850MHz

WIFI 802.11ac VHT20 (Band Edge @ 3m)

WIFI Ant. 1+2	Note	Frequency (MHz)	Level (dBμV/m)	Over Limit (dB)	Limit Line (dBμV/m)	Read Level (dBμV)	Antenna Factor (dB/m)	Cable Loss (dB)	Preamp Factor (dB)	Ant Pos (cm)	Table Pos (deg)	Peak Avg. (P/A)	Pol. (H/V)	
802.11ac VHT20 CH 33 5165MHz		5150	58.26	-15.74	74	50.88	31.98	7.94	32.54	159	200	P	H	
		5150	52.68	-1.32	54	45.3	31.98	7.94	32.54	159	200	A	H	
	*	5165	102.42	-	-	95.05	32	7.91	32.54	159	200	P	H	
	*	5165	96.59	-	-	89.22	32	7.91	32.54	159	200	A	H	
													H	
													H	
													H	
													H	
													H	
													H	
			5150	58.25	-15.75	74	50.87	31.98	7.94	32.54	228	183	P	V
			5150	52.11	-1.89	54	44.73	31.98	7.94	32.54	228	183	A	V
	*		5165	103.01	-	-	95.64	32	7.91	32.54	228	183	P	V
	*		5165	96.2	-	-	88.83	32	7.91	32.54	228	183	A	V
														V
														V
														V
														V



WIFI Ant. 1+2	Note	Frequency (MHz)	Level (dBμV/m)	Over Limit (dB)	Limit Line (dBμV/m)	Read Level (dBμV)	Antenna Factor (dB/m)	Cable Loss (dB)	Preamp Factor (dB)	Ant Pos (cm)	Table Pos (deg)	Peak Avg. (P/A)	Pol. (H/V)	
802.11ac VHT20 CH 40 5200MHz		5117	54.98	-19.02	74	47.61	31.94	7.96	32.53	188	186	P	H	
		5150	45.95	-8.05	54	38.57	31.98	7.94	32.54	188	186	A	H	
	*	5200	114.84	-	-	107.43	32.04	7.91	32.54	188	186	P	H	
	*	5200	107.97	-	-	100.56	32.04	7.91	32.54	188	186	A	H	
		5369.52	60.17	-13.83	74	52.18	32.24	8.29	32.54	188	186	P	H	
		5441.28	51.26	-2.74	54	43.2	32.32	8.29	32.55	188	186	A	H	
														H
														H
														H
														H
														H
														H
														H
														H
														H
			5148.46	54.68	-19.32	74	47.3	31.98	7.94	32.54	216	177	P	V
			5147.68	47.7	-6.3	54	40.32	31.98	7.94	32.54	216	177	A	V
		*	5200	115.01	-	-	107.6	32.04	7.91	32.54	216	177	P	V
		*	5200	107.66	-	-	100.25	32.04	7.91	32.54	216	177	A	V
			5381.04	58	-16	74	50	32.26	8.29	32.55	216	177	P	V
		5355.36	50.7	-3.3	54	42.79	32.22	8.23	32.54	216	177	A	V	
													V	
													V	
													V	
													V	
													V	
													V	
													V	
													V	



WIFI Ant. 1+2	Note	Frequency (MHz)	Level (dBμV/m)	Over Limit (dB)	Limit Line (dBμV/m)	Read Level (dBμV)	Antenna Factor (dB/m)	Cable Loss (dB)	Preamp Factor (dB)	Ant Pos (cm)	Table Pos (deg)	Peak Avg. (P/A)	Pol. (H/V)	
802.11ac VHT20 CH 48 5240MHz		5143.26	53.52	-20.48	74	46.14	31.98	7.94	32.54	185	189	P	H	
		5149.76	45.36	-8.64	54	37.98	31.98	7.94	32.54	185	189	A	H	
	*	5240	116.67	-	-	109.12	32.08	8.01	32.54	185	189	P	H	
	*	5240	110.44	-	-	102.89	32.08	8.01	32.54	185	189	A	H	
		5394.96	59.91	-14.09	74	51.89	32.28	8.29	32.55	185	189	P	H	
		5351.76	51.7	-2.3	54	43.79	32.22	8.23	32.54	185	189	A	H	
														H
														H
														H
														H
		5146.9	55.77	-18.23	74	48.39	31.98	7.94	32.54	205	178	P	V	
		5138.58	47.33	-6.67	54	39.97	31.96	7.94	32.54	205	178	A	V	
	*	5240	116.67	-	-	109.12	32.08	8.01	32.54	205	178	P	V	
	*	5240	109.51	-	-	101.96	32.08	8.01	32.54	205	178	A	V	
		5351.52	60.64	-13.36	74	52.73	32.22	8.23	32.54	205	178	P	V	
		5350.56	51.68	-2.32	54	43.77	32.22	8.23	32.54	205	178	A	V	
														V
														V
													V	
													V	
Remark	1. No other spurious found. 2. All results are PASS against Peak and Average limit line.													



Band 4 5725~5850MHz

WIFI 802.11ac VHT20 (Harmonic @ 3m)

WIFI Ant. 1+2	Note	Frequency (MHz)	Level (dBμV/m)	Over Limit (dB)	Limit Line (dBμV/m)	Read Level (dBμV)	Antenna Factor (dB/m)	Cable Loss (dB)	Preamp Factor (dB)	Ant Pos (cm)	Table Pos (deg)	Peak Avg. (P/A)	Pol. (H/V)	
802.11ac VHT20 CH 33 5165MHz		10330	41.85	-32.15	74	52.52	39.63	11.93	62.23	100	0	P	H	
		15495	40.07	-33.93	74	49.02	38.1	14.75	61.8	100	0	P	H	
													H	
													H	
			10330	41.88	-32.12	74	52.55	39.63	11.93	62.23	100	0	P	V
			15495	40.6	-33.4	74	49.55	38.1	14.75	61.8	100	0	P	V
														V
802.11ac VHT20 CH 40 5200MHz		10400	44.53	-29.47	74	57.99	39.74	12	65.2	100	0	P	H	
		15600	41.51	-32.49	74	52.93	37.93	14.78	64.13	100	0	P	H	
													H	
													H	
			10400	44.34	-29.66	74	57.8	39.74	12	65.2	100	0	P	V
			15600	41.85	-32.15	74	53.27	37.93	14.78	64.13	100	0	P	V
														V
802.11ac VHT20 CH 48 5240MHz		10480	44.11	-29.89	74	57.38	39.87	12.06	65.2	100	0	P	H	
		15720	40.42	-33.58	74	52.26	37.74	14.81	64.39	100	0	P	H	
													H	
													H	
			10480	44.19	-29.81	74	57.46	39.87	12.06	65.2	100	0	P	V
			15720	41.05	-32.95	74	52.89	37.74	14.81	64.39	100	0	P	V
														V
Remark	1. No other spurious found.													
	2. All results are PASS against Peak and Average limit line.													



Band 4 5725~5850MHz

WIFI 802.11ac VHT30 (Band Edge @ 3m)

WIFI Ant. 1+2	Note	Frequency (MHz)	Level (dBμV/m)	Over Limit (dB)	Limit Line (dBμV/m)	Read Level (dBμV)	Antenna Factor (dB/m)	Cable Loss (dB)	Preamp Factor (dB)	Ant Pos (cm)	Table Pos (deg)	Peak Avg. (P/A)	Pol. (H/V)	
802.11ac VHT30 CH 34 5170MHz		5149.5	57.77	-16.23	74	50.39	31.98	7.94	32.54	201	200	P	H	
		5150	53.62	-0.38	54	46.24	31.98	7.94	32.54	201	200	A	H	
	*	5170	96.06	-	-	88.69	32	7.91	32.54	201	200	P	H	
	*	5170	90.2	-	-	82.83	32	7.91	32.54	201	200	A	H	
		5360.64	52.47	-21.53	74	44.54	32.24	8.23	32.54	201	200	P	H	
		5353.2	44.86	-9.14	54	36.95	32.22	8.23	32.54	201	200	A	H	
														H
														H
														H
														H
														H
														H
														H
														H
		5147.68	57.9	-16.1	74	50.52	31.98	7.94	32.54	212	183	P	V	
		5149.76	49.7	-4.3	54	42.32	31.98	7.94	32.54	212	183	A	V	
	*	5170	94.3	-	-	86.93	32	7.91	32.54	212	183	P	V	
	*	5170	88.65	-	-	81.28	32	7.91	32.54	212	183	A	V	
		5407.92	49.69	-24.31	74	41.67	32.28	8.29	32.55	212	183	P	V	
		5360.16	42.52	-11.48	54	34.61	32.22	8.23	32.54	212	183	A	V	
													V	
													V	
													V	
													V	
													V	
													V	
													V	
													V	



WIFI Ant. 1+2	Note	Frequency (MHz)	Level (dBµV/m)	Over Limit (dB)	Limit Line (dBµV/m)	Read Level (dBµV)	Antenna Factor (dB/m)	Cable Loss (dB)	Preamp Factor (dB)	Ant Pos (cm)	Table Pos (deg)	Peak Avg. (P/A)	Pol. (H/V)	
802.11ac VHT30 CH 40 5200MHz		5130.52	53.87	-20.13	74	46.51	31.96	7.94	32.54	179	185	P	H	
		5150	46.4	-7.6	54	39.02	31.98	7.94	32.54	179	185	A	H	
	*	5200	111.69	-	-	104.28	32.04	7.91	32.54	179	185	P	H	
	*	5200	105.89	-	-	98.48	32.04	7.91	32.54	179	185	A	H	
		5424.72	59.6	-14.4	74	51.56	32.3	8.29	32.55	179	185	P	H	
		5441.28	52.05	-1.95	54	43.99	32.32	8.29	32.55	179	185	A	H	
														H
														H
														H
														H
														H
														H
														H
														H
														H
			5132.08	53.93	-20.07	74	46.57	31.96	7.94	32.54	213	180	P	V
			5148.2	46.21	-7.79	54	38.83	31.98	7.94	32.54	213	180	A	V
		*	5200	111.65	-	-	104.24	32.04	7.91	32.54	213	180	P	V
		*	5200	106	-	-	98.59	32.04	7.91	32.54	213	180	A	V
			5350.56	55.76	-18.24	74	47.85	32.22	8.23	32.54	213	180	P	V
		5356.8	48.23	-5.77	54	40.32	32.22	8.23	32.54	213	180	A	V	
													V	
													V	
													V	
													V	
													V	
													V	
													V	
													V	



WIFI Ant. 1+2	Note	Frequency (MHz)	Level (dBμV/m)	Over Limit (dB)	Limit Line (dBμV/m)	Read Level (dBμV)	Antenna Factor (dB/m)	Cable Loss (dB)	Preamp Factor (dB)	Ant Pos (cm)	Table Pos (deg)	Peak Avg. (P/A)	Pol. (H/V)	
802.11ac VHT30 CH 47 5235MHz		5118.82	54.05	-19.95	74	46.69	31.94	7.96	32.54	189	177	P	H	
		5147.42	45.71	-8.29	54	38.33	31.98	7.94	32.54	189	177	A	H	
	*	5235	114.04	-	-	106.49	32.08	8.01	32.54	189	177	P	H	
	*	5235	108.86	-	-	101.31	32.08	8.01	32.54	189	177	A	H	
		5459.28	59.79	-14.21	74	51.71	32.34	8.29	32.55	189	177	P	H	
		5352.48	52.52	-1.48	54	44.61	32.22	8.23	32.54	189	177	A	H	
														H
														H
														H
														H
														H
														H
														H
														H
			5148.46	54.91	-19.09	74	47.53	31.98	7.94	32.54	232	177	P	V
			5148.98	48.2	-5.8	54	40.82	31.98	7.94	32.54	232	177	A	V
		*	5235	113.47	-	-	105.92	32.08	8.01	32.54	232	177	P	V
		*	5235	107.89	-	-	100.34	32.08	8.01	32.54	232	177	A	V
			5352	58.9	-15.1	74	50.99	32.22	8.23	32.54	232	177	P	V
			5353.68	52.03	-1.97	54	44.12	32.22	8.23	32.54	232	177	A	H
													V	
													V	
													V	
													V	
													V	
													V	
													V	
Remark	1. No other spurious found. 2. All results are PASS against Peak and Average limit line.													



Band 4 5725~5850MHz

WIFI 802.11n HT20 (Harmonic @ 3m)

WIFI Ant. 1+2	Note	Frequency (MHz)	Level (dBμV/m)	Over Limit (dB)	Limit Line (dBμV/m)	Read Level (dBμV)	Antenna Factor (dB/m)	Cable Loss (dB)	Preamp Factor (dB)	Ant Pos (cm)	Table Pos (deg)	Peak Avg. (P/A)	Pol. (H/V)	
802.11ac VHT30 CH 34 5170MHz		10340	41.88	-32.12	74	52.55	39.63	11.93	62.23	100	0	P	H	
		15510	40.31	-33.69	74	49.28	38.07	14.75	61.79	100	0	P	H	
													H	
													H	
			10340	41.85	-32.15	74	52.52	39.63	11.93	62.23	100	0	P	V
			15510	39.68	-34.32	74	48.65	38.07	14.75	61.79	100	0	P	V
														V
802.11ac VHT30 CH 40 5200MHz		10400	44.27	-29.73	74	57.73	39.74	12	65.2	100	0	P	H	
		15600	40.88	-33.12	74	52.3	37.93	14.78	64.13	100	0	P	H	
													H	
													H	
			10400	43.49	-30.51	74	56.95	39.74	12	65.2	100	0	P	V
			15600	40.97	-33.03	74	52.39	37.93	14.78	64.13	100	0	P	V
														V
802.11ac VHT30 CH 47 5235MHz		10470	43.08	-30.92	74	56.4	39.85	12.03	65.2	100	0	P	H	
		15705	40.04	-33.96	74	51.83	37.77	14.8	64.36	100	0	P	H	
													H	
													H	
			10470	44.15	-29.85	74	57.47	39.85	12.03	65.2	100	0	P	V
			15705	40.19	-33.81	74	51.98	37.77	14.8	64.36	100	0	P	V
														V
Remark	1. No other spurious found.													
	2. All results are PASS against Peak and Average limit line.													



Band 4 5725~5850MHz

WIFI 802.11ac VHT40 (Band Edge @ 3m)

WIFI Ant. 1+2	Note	Frequency (MHz)	Level (dBμV/m)	Over Limit (dB)	Limit Line (dBμV/m)	Read Level (dBμV)	Antenna Factor (dB/m)	Cable Loss (dB)	Preamp Factor (dB)	Ant Pos (cm)	Table Pos (deg)	Peak Avg. (P/A)	Pol. (H/V)	
802.11ac VHT40 CH 35 5175MHz		5149.76	59.57	-14.43	74	52.19	31.98	7.94	32.54	201	199	P	H	
		5150	53.53	-0.47	54	46.15	31.98	7.94	32.54	201	199	A	H	
	*	5175	96.27	-	-	88.88	32.02	7.91	32.54	201	199	P	H	
	*	5175	90.07	-	-	82.68	32.02	7.91	32.54	201	199	A	H	
		5352.96	52.61	-21.39	74	44.7	32.22	8.23	32.54	201	199	P	H	
		5399.76	44.97	-9.03	54	36.95	32.28	8.29	32.55	201	199	A	H	
														H
														H
														H
														H
														H
														H
														H
														H
														H
			5147.42	59.41	-14.59	74	52.03	31.98	7.94	32.54	214	182	P	V
			5150	51.3	-2.7	54	43.92	31.98	7.94	32.54	214	182	A	V
		*	5175	96.24	-	-	88.85	32.02	7.91	32.54	214	182	P	V
	*	5175	89.99	-	-	82.6	32.02	7.91	32.54	214	182	A	V	
		5352.24	50.01	-23.99	74	42.1	32.22	8.23	32.54	214	182	P	V	
		5350.08	42.33	-11.67	54	34.42	32.22	8.23	32.54	214	182	A	V	
													V	
													V	
													V	
													V	
													V	
													V	
													V	
													V	



WIFI Ant. 1+2	Note	Frequency (MHz)	Level (dBμV/m)	Over Limit (dB)	Limit Line (dBμV/m)	Read Level (dBμV)	Antenna Factor (dB/m)	Cable Loss (dB)	Preamp Factor (dB)	Ant Pos (cm)	Table Pos (deg)	Peak Avg. (P/A)	Pol. (H/V)	
802.11ac VHT40 CH 40 5200MHz		5148.2	57.51	-16.49	74	50.13	31.98	7.94	32.54	193	177	P	H	
		5149.24	50.46	-3.54	54	43.08	31.98	7.94	32.54	193	177	A	H	
	*	5200	114.94	-	-	107.53	32.04	7.91	32.54	193	177	P	H	
	*	5200	108.56	-	-	101.15	32.04	7.91	32.54	193	177	A	H	
		5407.2	59.14	-14.86	74	51.12	32.28	8.29	32.55	193	177	P	H	
		5447.04	52.16	-1.84	54	44.08	32.34	8.29	32.55	193	177	A	H	
														H
														H
														H
														H
														H
														H
														H
														H
			5148.2	57.73	-16.27	74	50.35	31.98	7.94	32.54	216	173	P	V
			5148.72	51.12	-2.88	54	43.74	31.98	7.94	32.54	216	173	A	V
	*	5200	114.87	-	-	107.46	32.04	7.91	32.54	216	173	P	V	
	*	5200	108.43	-	-	101.02	32.04	7.91	32.54	216	173	A	V	
		5377.68	59.23	-14.77	74	51.23	32.26	8.29	32.55	216	173	P	V	
		5356.32	50.79	-3.21	54	42.88	32.22	8.23	32.54	216	173	A	V	
													V	
													V	
													V	
													V	
													V	
													V	
Remark	<ol style="list-style-type: none"> No other spurious found. All results are PASS against Peak and Average limit line. 													



WIFI Ant. 1+2	Note	Frequency (MHz)	Level (dBμV/m)	Over Limit (dB)	Limit Line (dBμV/m)	Read Level (dBμV)	Antenna Factor (dB/m)	Cable Loss (dB)	Preamp Factor (dB)	Ant Pos (cm)	Table Pos (deg)	Peak Avg. (P/A)	Pol. (H/V)	
802.11ac VHT40 CH 46 5230MHz		5134.42	53.26	-20.74	74	45.9	31.96	7.94	32.54	194	179	P	H	
		5147.94	46.33	-7.67	54	38.95	31.98	7.94	32.54	194	179	A	H	
	*	5230	115.69	-	-	108.14	32.08	8.01	32.54	194	179	P	H	
	*	5230	109.71	-	-	102.16	32.08	8.01	32.54	194	179	A	H	
		5358	59.34	-14.66	74	51.43	32.22	8.23	32.54	194	179	P	H	
		5350.56	52.38	-1.62	54	44.47	32.22	8.23	32.54	194	179	A	H	
														H
														H
														H
														H
														H
														H
														H
														H
														H
			5129.74	56.3	-17.7	74	48.94	31.96	7.94	32.54	226	179	P	V
			5143	48.74	-5.26	54	41.36	31.98	7.94	32.54	226	179	A	V
		*	5230	114.83	-	-	107.28	32.08	8.01	32.54	226	179	P	V
	*	5230	109.02	-	-	101.47	32.08	8.01	32.54	226	179	A	V	
		5447.76	58.7	-15.3	74	50.62	32.34	8.29	32.55	226	179	P	V	
		5351.28	51.97	-2.03	54	44.06	32.22	8.23	32.54	226	179	A	V	
													V	
													V	
													V	
													V	
													V	
													V	
Remark	1. No other spurious found. 2. All results are PASS against Peak and Average limit line.													



Band 4 5725~5850MHz

WIFI 802.11ac VHT40 (Harmonic @ 3m)

WIFI Ant. 1+2	Note	Frequency (MHz)	Level (dBμV/m)	Over Limit (dB)	Limit Line (dBμV/m)	Read Level (dBμV)	Antenna Factor (dB/m)	Cable Loss (dB)	Preamp Factor (dB)	Ant Pos (cm)	Table Pos (deg)	Peak Avg. (P/A)	Pol. (H/V)	
802.11ac VHT40 CH 35 5175MHz		10350	42.44	-31.56	74	53.07	39.66	11.93	62.22	100	0	P	H	
		15525	40.69	-33.31	74	49.65	38.07	14.76	61.79	100	0	P	H	
													H	
													H	
			10350	42.4	-31.6	74	53.03	39.66	11.93	62.22	100	0	P	V
			15525	40.28	-33.72	74	49.24	38.07	14.76	61.79	100	0	P	V
														V
802.11ac VHT40 CH 40 5200MHz		10400	43.54	-30.46	74	57	39.74	12	65.2	100	0	P	H	
		15600	41.87	-32.13	74	53.29	37.93	14.78	64.13	100	0	P	H	
													H	
													H	
			10400	46.26	-27.74	74	59.72	39.74	12	65.2	100	0	P	V
			15600	40.88	-33.12	74	52.3	37.93	14.78	64.13	100	0	P	V
														V
802.11ac VHT40 CH 46 5230MHz		10460	43.73	-30.27	74	57.08	39.82	12.03	65.2	100	0	P	H	
		15690	40.54	-33.46	74	52.26	37.8	14.8	64.32	100	0	P	H	
													H	
													H	
			10460	43.23	-30.77	74	56.58	39.82	12.03	65.2	100	0	P	V
			15690	39.78	-34.22	74	51.5	37.8	14.8	64.32	100	0	P	V
														V
Remark	1. No other spurious found.													
	2. All results are PASS against Peak and Average limit line.													



Band 4 5725~5850MHz

WIFI 802.11ac VHT50 (Band Edge @ 3m)

WIFI Ant. 1+2	Note	Frequency (MHz)	Level (dBμV/m)	Over Limit (dB)	Limit Line (dBμV/m)	Read Level (dBμV)	Antenna Factor (dB/m)	Cable Loss (dB)	Preamp Factor (dB)	Ant Pos (cm)	Table Pos (deg)	Peak Avg. (P/A)	Pol. (H/V)	
802.11ac VHT50 CH 36 5180MHz		5149.76	60.84	-13.16	74	53.46	31.98	7.94	32.54	211	199	P	H	
		5150	53.56	-0.44	54	46.18	31.98	7.94	32.54	211	199	A	H	
	*	5180	97.32	-	-	89.93	32.02	7.91	32.54	211	199	P	H	
	*	5180	90.61	-	-	83.22	32.02	7.91	32.54	211	199	A	H	
		5421.36	51.82	-22.18	74	43.78	32.3	8.29	32.55	211	199	P	H	
		5355.36	45.07	-8.93	54	37.16	32.22	8.23	32.54	211	199	A	H	
														H
														H
														H
														H
														H
														H
														H
														H
														H
			5148.98	59.65	-14.35	74	52.27	31.98	7.94	32.54	213	183	P	V
			5150	51.46	-2.54	54	44.08	31.98	7.94	32.54	213	183	A	V
		*	5180	97.29	-	-	89.9	32.02	7.91	32.54	213	183	P	V
	*	5180	90.35	-	-	82.96	32.02	7.91	32.54	213	183	A	V	
		5442.48	49.89	-24.11	74	41.83	32.32	8.29	32.55	213	183	P	V	
		5353.2	42.65	-11.35	54	34.74	32.22	8.23	32.54	213	183	A	V	
													V	
													V	
													V	
													V	
													V	
													V	
													V	
													V	



WIFI Ant. 1+2	Note	Frequency (MHz)	Level (dBµV/m)	Over Limit (dB)	Limit Line (dBµV/m)	Read Level (dBµV)	Antenna Factor (dB/m)	Cable Loss (dB)	Preamp Factor (dB)	Ant Pos (cm)	Table Pos (deg)	Peak Avg. (P/A)	Pol. (H/V)	
802.11ac VHT50 CH 40 5200MHz		5149.24	58.8	-15.2	74	51.42	31.98	7.94	32.54	187	178	P	H	
		5150	52.31	-1.69	54	44.93	31.98	7.94	32.54	187	178	A	H	
	*	5200	113.69	-	-	106.28	32.04	7.91	32.54	187	178	P	H	
	*	5200	107.97	-	-	100.56	32.04	7.91	32.54	187	178	A	H	
		5435.76	59.52	-14.48	74	51.46	32.32	8.29	32.55	187	178	P	H	
		5447.28	51.88	-2.12	54	43.8	32.34	8.29	32.55	187	178	A	H	
														H
														H
														H
														H
														H
														H
														H
														H
														H
			5145.34	59.18	-14.82	74	51.8	31.98	7.94	32.54	208	178	P	V
			5149.76	53.74	-0.26	54	46.36	31.98	7.94	32.54	208	178	A	V
		*	5200	112.84	-	-	105.43	32.04	7.91	32.54	208	178	P	V
	*	5200	106.54	-	-	99.13	32.04	7.91	32.54	208	178	A	V	
		5373.12	55.36	-18.64	74	47.37	32.24	8.29	32.54	208	178	P	V	
		5354.88	48.23	-5.77	54	40.32	32.22	8.23	32.54	208	178	A	V	
													V	
													V	
													V	
													V	
													V	
													V	
Remark	1. No other spurious found. 2. All results are PASS against Peak and Average limit line.													



WIFI Ant. 1+2	Note	Frequency (MHz)	Level (dBμV/m)	Over Limit (dB)	Limit Line (dBμV/m)	Read Level (dBμV)	Antenna Factor (dB/m)	Cable Loss (dB)	Preamp Factor (dB)	Ant Pos (cm)	Table Pos (deg)	Peak Avg. (P/A)	Pol. (H/V)	
802.11ac VHT50 CH 45 5225MHz		5146.64	55.05	-18.95	74	47.67	31.98	7.94	32.54	202	177	P	H	
		5150	47.12	-6.88	54	39.74	31.98	7.94	32.54	202	177	A	H	
	*	5225	115.5	-	-	107.95	32.08	8.01	32.54	202	177	P	H	
	*	5225	109.69	-	-	102.14	32.08	8.01	32.54	202	177	A	H	
		5439.84	59.53	-14.47	74	51.47	32.32	8.29	32.55	202	177	P	H	
		5351.76	52.38	-1.62	54	44.47	32.22	8.23	32.54	202	177	A	H	
														H
														H
														H
														H
														H
														H
														H
														H
														H
			5146.12	57.17	-16.83	74	49.79	31.98	7.94	32.54	221	176	P	V
			5147.16	49.44	-4.56	54	42.06	31.98	7.94	32.54	221	176	A	V
		*	5225	114.05	-	-	106.5	32.08	8.01	32.54	221	176	P	V
	*	5225	107.89	-	-	100.34	32.08	8.01	32.54	221	176	A	V	
		5361.36	58.8	-15.2	74	50.87	32.24	8.23	32.54	221	176	P	V	
		5351.04	51.75	-2.25	54	43.84	32.22	8.23	32.54	221	176	A	V	
													V	
													V	
													V	
													V	
													V	
													V	
Remark	1. No other spurious found. 2. All results are PASS against Peak and Average limit line.													



Band 4 5725~5850MHz

WIFI 802.11ac VHT50 (Harmonic @ 3m)

WIFI Ant. 1+2	Note	Frequency (MHz)	Level (dBμV/m)	Over Limit (dB)	Limit Line (dBμV/m)	Read Level (dBμV)	Antenna Factor (dB/m)	Cable Loss (dB)	Preamp Factor (dB)	Ant Pos (cm)	Table Pos (deg)	Peak Avg. (P/A)	Pol. (H/V)	
802.11ac VHT50 CH 36 5180MHz		10360	42.79	-31.21	74	53.35	39.69	11.96	62.21	100	0	P	H	
		15540	39.94	-34.06	74	48.92	38.04	14.76	61.78	100	0	P	H	
													H	
													H	
			10360	42.39	-31.61	74	52.95	39.69	11.96	62.21	100	0	P	V
			15540	41.74	-32.26	74	50.72	38.04	14.76	61.78	100	0	P	V
														V
802.11ac VHT50 CH 40 5200MHz		10400	44	-30	74	57.46	39.74	12	65.2	100	0	P	H	
		15600	41.93	-32.07	74	53.35	37.93	14.78	64.13	100	0	P	H	
													H	
													H	
			10400	44.43	-29.57	74	57.89	39.74	12	65.2	100	0	P	V
			15600	40.45	-33.55	74	51.87	37.93	14.78	64.13	100	0	P	V
														V
802.11ac VHT50 CH 45 5225MHz		10450	43.17	-30.83	74	56.52	39.82	12.03	65.2	100	0	P	H	
		15675	41.46	-32.54	74	53.13	37.82	14.79	64.28	100	0	P	H	
													H	
													H	
			10450	43.35	-30.65	74	56.7	39.82	12.03	65.2	100	0	P	V
			15675	39.96	-34.04	74	51.63	37.82	14.79	64.28	100	0	P	V
														V
Remark	1. No other spurious found.													
	2. All results are PASS against Peak and Average limit line.													



Band 4 5725~5850MHz

WIFI 802.11ac VHT60 (Band Edge @ 3m)

WIFI Ant. 1+2	Note	Frequency (MHz)	Level (dBμV/m)	Over Limit (dB)	Limit Line (dBμV/m)	Read Level (dBμV)	Antenna Factor (dB/m)	Cable Loss (dB)	Preamp Factor (dB)	Ant Pos (cm)	Table Pos (deg)	Peak Avg. (P/A)	Pol. (H/V)	
802.11ac VHT60 CH 37 5185MHz		5149.5	64.49	-9.51	74	57.11	31.98	7.94	32.54	205	196	P	H	
		5149.76	53.81	-0.19	54	46.43	31.98	7.94	32.54	205	196	A	H	
	*	5185	95.89	-	-	88.5	32.02	7.91	32.54	205	196	P	H	
	*	5185	89.54	-	-	82.15	32.02	7.91	32.54	205	196	A	H	
		5398.08	52.56	-21.44	74	44.54	32.28	8.29	32.55	205	196	P	H	
		5357.04	45.04	-8.96	54	37.13	32.22	8.23	32.54	205	196	A	H	
														H
														H
														H
														H
														H
														H
														H
														H
														H
			5145.86	57.01	-16.99	74	49.63	31.98	7.94	32.54	212	179	P	V
			5150	50.38	-3.62	54	43	31.98	7.94	32.54	212	179	A	V
		*	5185	93.71	-	-	86.32	32.02	7.91	32.54	212	179	P	V
	*	5185	87.99	-	-	80.6	32.02	7.91	32.54	212	179	A	V	
		5393.28	49.92	-24.08	74	41.92	32.26	8.29	32.55	212	179	P	V	
		5350.32	42.26	-11.74	54	34.35	32.22	8.23	32.54	212	179	A	V	
													V	
													V	
													V	
													V	
													V	
													V	
													V	
													V	



WIFI Ant. 1+2	Note	Frequency (MHz)	Level (dBμV/m)	Over Limit (dB)	Limit Line (dBμV/m)	Read Level (dBμV)	Antenna Factor (dB/m)	Cable Loss (dB)	Preamp Factor (dB)	Ant Pos (cm)	Table Pos (deg)	Peak Avg. (P/A)	Pol. (H/V)	
802.11ac VHT60 CH 40 5200MHz		5147.68	59.13	-14.87	74	51.75	31.98	7.94	32.54	190	190	P	H	
		5149.76	53.32	-0.68	54	45.94	31.98	7.94	32.54	190	190	A	H	
	*	5200	108.73	-	-	101.32	32.04	7.91	32.54	190	190	P	H	
	*	5200	102	-	-	94.59	32.04	7.91	32.54	190	190	A	H	
		5350.8	59.7	-14.3	74	51.79	32.22	8.23	32.54	190	190	P	H	
		5439.6	51.97	-2.03	54	43.91	32.32	8.29	32.55	190	190	A	H	
														H
														H
														H
														H
														H
														H
														H
														H
														H
			5147.94	59.51	-14.49	74	52.13	31.98	7.94	32.54	237	174	P	V
			5150	50.77	-3.23	54	43.39	31.98	7.94	32.54	237	174	A	V
		*	5200	106.65	-	-	99.24	32.04	7.91	32.54	237	174	P	V
	*	5200	100.87	-	-	93.46	32.04	7.91	32.54	237	174	A	V	
		5450.88	55.71	-18.29	74	47.63	32.34	8.29	32.55	237	174	P	V	
		5357.28	48.27	-5.73	54	40.36	32.22	8.23	32.54	237	174	A	V	
													V	
													V	
													V	
													V	
													V	
													V	
Remark	1. No other spurious found. 2. All results are PASS against Peak and Average limit line.													



WIFI Ant. 1+2	Note	Frequency (MHz)	Level (dBµV/m)	Over Limit (dB)	Limit Line (dBµV/m)	Read Level (dBµV)	Antenna Factor (dB/m)	Cable Loss (dB)	Preamp Factor (dB)	Ant Pos (cm)	Table Pos (deg)	Peak Avg. (P/A)	Pol. (H/V)	
802.11ac VHT60 CH 44 5220MHz		5149.24	58.42	-15.58	74	51.04	31.98	7.94	32.54	216	173	P	H	
		5150	51.46	-2.54	54	44.08	31.98	7.94	32.54	216	173	A	H	
	*	5220	114.69	-	-	107.16	32.06	8.01	32.54	216	173	P	H	
	*	5220	108.86	-	-	101.33	32.06	8.01	32.54	216	173	A	H	
		5376	59.29	-14.71	74	51.31	32.24	8.29	32.55	216	173	P	H	
		5352.72	52.34	-1.66	54	44.43	32.22	8.23	32.54	216	173	A	H	
														H
														H
														H
														H
														H
														H
														H
														H
														H
														H
														H
														H
														H
	802.11ac VHT60 CH 44 5220MHz		5149.24	58.87	-15.13	74	51.49	31.98	7.94	32.54	215	179	P	V
		5149.76	52.89	-1.11	54	45.51	31.98	7.94	32.54	215	179	A	V	
*		5220	112.9	-	-	105.37	32.06	8.01	32.54	215	179	P	V	
*		5220	107.35	-	-	99.82	32.06	8.01	32.54	215	179	A	V	
		5365.44	59.24	-14.76	74	51.25	32.24	8.29	32.54	215	179	P	V	
		5353.68	52.08	-1.92	54	44.17	32.22	8.23	32.54	215	179	A	V	
														V
														V
														V
														V
														V
														V
														V
														V
Remark	<ol style="list-style-type: none"> No other spurious found. All results are PASS against Peak and Average limit line. 													



Band 4 5725~5850MHz

WIFI 802.11ac VHT60 (Harmonic @ 3m)

WIFI Ant. 1+2	Note	Frequency (MHz)	Level (dBμV/m)	Over Limit (dB)	Limit Line (dBμV/m)	Read Level (dBμV)	Antenna Factor (dB/m)	Cable Loss (dB)	Preamp Factor (dB)	Ant Pos (cm)	Table Pos (deg)	Peak Avg. (P/A)	Pol. (H/V)	
802.11ac VHT60 CH 37 5185MHz		10370	43.31	-30.69	74	53.87	39.69	11.96	62.21	100	0	P	H	
		15555	40.59	-33.41	74	49.58	38.02	14.76	61.77	100	0	P	H	
													H	
													H	
			10370	42.26	-31.74	74	52.82	39.69	11.96	62.21	100	0	P	V
			15555	40.59	-33.41	74	49.58	38.02	14.76	61.77	100	0	P	V
														V
802.11ac VHT60 CH 40 5200MHz		10400	44.39	-29.61	74	57.85	39.74	12	65.2	100	0	P	H	
		15600	40.8	-33.2	74	52.22	37.93	14.78	64.13	100	0	P	H	
													H	
													H	
			10400	43.9	-30.1	74	57.36	39.74	12	65.2	100	0	P	V
			15600	41.13	-32.87	74	52.55	37.93	14.78	64.13	100	0	P	V
														V
802.11ac VHT60 CH 44 5220MHz		10440	43.99	-30.01	74	57.37	39.79	12.03	65.2	100	0	P	H	
		15660	40.63	-33.37	74	52.23	37.85	14.79	64.24	100	0	P	H	
													H	
													H	
			10440	43.29	-30.71	74	56.67	39.79	12.03	65.2	100	0	P	V
			15660	40.12	-33.88	74	51.72	37.85	14.79	64.24	100	0	P	V
														V
Remark	1. No other spurious found.													
	2. All results are PASS against Peak and Average limit line.													



Band 4 5725~5850MHz

WIFI 802.11ac VHT80 (Band Edge @ 3m)

WIFI Ant. 1+2	Note	Frequency (MHz)	Level (dBμV/m)	Over Limit (dB)	Limit Line (dBμV/m)	Read Level (dBμV)	Antenna Factor (dB/m)	Cable Loss (dB)	Preamp Factor (dB)	Ant Pos (cm)	Table Pos (deg)	Peak Avg. (P/A)	Pol. (H/V)	
802.11ac VHT80 CH 39 5195MHz		5149.24	57.18	-16.82	74	49.8	31.98	7.94	32.54	206	199	P	H	
		5150	53.15	-0.85	54	45.77	31.98	7.94	32.54	206	199	A	H	
	*	5195	93.57	-	-	86.16	32.04	7.91	32.54	206	199	P	H	
	*	5195	87.16	-	-	79.75	32.04	7.91	32.54	206	199	A	H	
		5382	52.9	-21.1	74	44.9	32.26	8.29	32.55	206	199	P	H	
		5351.76	46.62	-7.38	54	38.71	32.22	8.23	32.54	206	199	A	H	
														H
														H
														H
														H
														H
														H
														H
														H
														H
			5149.24	57.17	-16.83	74	49.79	31.98	7.94	32.54	221	182	P	V
			5147.42	50.65	-3.35	54	43.27	31.98	7.94	32.54	221	182	A	V
		*	5195	91.88	-	-	84.47	32.04	7.91	32.54	221	182	P	V
	*	5195	85.74	-	-	78.33	32.04	7.91	32.54	221	182	A	V	
		5373.6	49.27	-24.73	74	41.29	32.24	8.29	32.55	221	182	P	V	
		5396.16	43.47	-10.53	54	35.45	32.28	8.29	32.55	221	182	A	V	
													V	
													V	
													V	
													V	
													V	
													V	
													V	
													V	



WIFI Ant. 1+2	Note	Frequency (MHz)	Level (dBμV/m)	Over Limit (dB)	Limit Line (dBμV/m)	Read Level (dBμV)	Antenna Factor (dB/m)	Cable Loss (dB)	Preamp Factor (dB)	Ant Pos (cm)	Table Pos (deg)	Peak Avg. (P/A)	Pol. (H/V)	
802.11ac VHT80 CH 40 5200MHz		5147.42	59.48	-14.52	74	52.1	31.98	7.94	32.54	196	178	P	H	
		5149.5	53.65	-0.35	54	46.27	31.98	7.94	32.54	196	178	A	H	
	*	5200	98.49	-	-	91.08	32.04	7.91	32.54	196	178	P	H	
	*	5200	92.66	-	-	85.25	32.04	7.91	32.54	196	178	A	H	
		5422.56	53.17	-20.83	74	45.13	32.3	8.29	32.55	196	178	P	H	
		5355.12	46.5	-7.5	54	38.59	32.22	8.23	32.54	196	178	A	H	
														H
														H
														H
														H
														H
														H
														H
														H
														H
			5148.98	58.18	-15.82	74	50.8	31.98	7.94	32.54	224	182	P	V
			5149.24	53.05	-0.95	54	45.67	31.98	7.94	32.54	224	182	A	V
		*	5200	96.73	-	-	89.32	32.04	7.91	32.54	224	182	P	V
	*	5200	91.21	-	-	83.8	32.04	7.91	32.54	224	182	A	V	
		5382.96	49.72	-24.28	74	41.72	32.26	8.29	32.55	224	182	P	V	
		5350.8	43.62	-10.38	54	35.71	32.22	8.23	32.54	224	182	A	V	
													V	
													V	
													V	
													V	
													V	
													V	
Remark	1. No other spurious found. 2. All results are PASS against Peak and Average limit line.													



WIFI Ant. 1+2	Note	Frequency (MHz)	Level (dBμV/m)	Over Limit (dB)	Limit Line (dBμV/m)	Read Level (dBμV)	Antenna Factor (dB/m)	Cable Loss (dB)	Preamp Factor (dB)	Ant Pos (cm)	Table Pos (deg)	Peak Avg. (P/A)	Pol. (H/V)	
802.11ac VHT80 CH 42 5210MHz		5148.98	57.59	-16.41	74	50.21	31.98	7.94	32.54	233	177	P	H	
		5149.76	53.13	-0.87	54	45.75	31.98	7.94	32.54	233	177	A	H	
	*	5210	104.5	-	-	96.97	32.06	8.01	32.54	233	177	P	H	
	*	5210	98.55	-	-	91.02	32.06	8.01	32.54	233	177	A	H	
		5358.48	58.21	-15.79	74	50.3	32.22	8.23	32.54	233	177	P	H	
		5410.08	52.58	-1.42	54	44.56	32.28	8.29	32.55	233	177	A	H	
														H
														H
														H
														H
														H
														H
														H
														H
														H
			5143	56.23	-17.77	74	48.85	31.98	7.94	32.54	222	180	P	V
			5147.94	51.57	-2.43	54	44.19	31.98	7.94	32.54	222	180	A	V
		*	5210	103.22	-	-	95.69	32.06	8.01	32.54	222	180	P	V
	*	5210	97.06	-	-	89.53	32.06	8.01	32.54	222	180	A	V	
		5412.48	54.77	-19.23	74	46.73	32.3	8.29	32.55	222	180	P	V	
		5359.2	48.79	-5.21	54	40.88	32.22	8.23	32.54	222	180	A	V	
													V	
													V	
													V	
													V	
													V	
													V	
Remark	1. No other spurious found. 2. All results are PASS against Peak and Average limit line.													



Band 4 5725~5850MHz

WIFI 802.11ac VHT80 (Harmonic @ 3m)

WIFI Ant. 1+2	Note	Frequency (MHz)	Level (dBμV/m)	Over Limit (dB)	Limit Line (dBμV/m)	Read Level (dBμV)	Antenna Factor (dB/m)	Cable Loss (dB)	Preamp Factor (dB)	Ant Pos (cm)	Table Pos (deg)	Peak Avg. (P/A)	Pol. (H/V)	
802.11ac VHT80 CH 39 5195MHz		10390	42.34	-31.66	74	52.86	39.71	11.96	62.19	100	0	P	H	
		15585	40.91	-33.09	74	49.93	37.96	14.77	61.75	100	0	P	H	
													H	
													H	
			10390	43.09	-30.91	74	53.61	39.71	11.96	62.19	100	0	P	V
			15585	40.75	-33.25	74	49.77	37.96	14.77	61.75	100	0	P	V
														V
802.11ac VHT60 CH 40 5200MHz		10400	42.55	-31.45	74	52.99	39.74	12	62.18	100	0	P	H	
		15600	41.59	-32.41	74	50.62	37.93	14.78	61.74	100	0	P	H	
													H	
													H	
			10400	41.78	-32.22	74	52.22	39.74	12	62.18	100	0	P	V
			15600	40.33	-33.67	74	49.36	37.93	14.78	61.74	100	0	P	V
														V
802.11ac VHT80 CH 42 5210MHz		10420	43.36	-30.64	74	53.76	39.77	12	62.17	100	0	P	H	
		15630	40.99	-33.01	74	50.05	37.88	14.78	61.72	100	0	P	H	
													H	
													H	
			10420	43.22	-30.78	74	53.62	39.77	12	62.17	100	0	P	V
			15630	40.55	-33.45	74	49.61	37.88	14.78	61.72	100	0	P	V
														V
Remark	1. No other spurious found.													
	2. All results are PASS against Peak and Average limit line.													



Emission below 1GHz

5GHz WIFI 802.11ac VHT60 (LF @ 3m)

WIFI Ant. 1+2	Note	Frequency (MHz)	Level (dBμV/m)	Over Limit (dB)	Limit Line (dBμV/m)	Read Level (dBμV)	Antenna Factor (dB/m)	Cable Loss (dB)	Preamp Factor (dB)	Ant Pos (cm)	Table Pos (deg)	Peak Avg. (P/A)	Pol. (H/V)	
5GHz 802.11ac VHT60 LF		125.04	29.06	-14.44	43.5	42.59	17.9	1.33	32.76	-	-	P	H	
		145.02	29.89	-13.61	43.5	43.48	17.84	1.33	32.76	-	-	P	H	
		250.05	32.78	-13.22	46	44.95	18.8	1.76	32.73	-	-	P	H	
		374.9	51.07	5.07	46	59.88	21.81	2.13	32.75	100	66	QP	H	
		374.9	51.57	5.57	46	60.38	21.81	2.13	32.75	100	66	P	H	
		600.3	44.96	-1.04	46	49.89	25.5	2.57	33	166	47	QP	H	
		600.3	45.15	-0.85	46	50.08	25.5	2.57	33	166	47	P	H	
		874.7	45.64	-0.36	46	46.22	28.7	3.16	32.44	100	49	QP	H	
		874.7	46.35	0.35	46	46.93	28.7	3.16	32.44	100	49	P	H	
														H
														H
														H
			34.59	30.91	-9.09	40	39.71	23.3	0.65	32.75	-	-	P	V
			73.74	28.81	-11.19	40	47.56	13.07	0.93	32.75	-	-	P	V
			224.94	32.66	-13.34	46	47.18	16.6	1.62	32.74	-	-	P	V
			374.9	49.31	3.31	46	58.12	21.81	2.13	32.75	121	5	QP	V
			374.9	49.95	3.95	46	58.76	21.81	2.13	32.75	121	5	P	V
			600.3	43.6	-2.4	46	48.53	25.5	2.57	33	100	101	QP	V
			600.3	44.62	-1.38	46	49.55	25.5	2.57	33	100	101	P	V
			874.7	45.77	-0.23	46	46.35	28.7	3.16	32.44	200	18	QP	V
		874.7	47.02	1.02	46	47.6	28.7	3.16	32.44	200	18	P	V	
													V	
													V	
													V	
Remark	1. No other spurious found. 2. All results are PASS against limit line.													



Note symbol

*	Fundamental Frequency which can be ignored. However, the level of any unwanted emissions shall not exceed the level of the fundamental frequency.
!	Test result is over limit line.
P/A	Peak or Average
H/V	Horizontal or Vertical



A calculation example for radiated spurious emission is shown as below:

WIFI	Note	Frequency	Level	Over	Limit	Read	Antenna	Cable	Preamp	Ant	Table	Peak	Pol.
Ant.				Limit	Line	Level	Factor	Loss	Factor	Pos	Pos	Avg.	
1+2		(MHz)	(dBμV/m)	(dB)	(dBμV/m)	(dBμV)	(dB/m)	(dB)	(dB)	(cm)	(deg)	(P/A)	(H/V)
802.11b		2390	55.45	-18.55	74	54.51	32.22	4.58	35.86	103	308	P	H
CH 01													
2412MHz		2390	43.54	-10.46	54	42.6	32.22	4.58	35.86	103	308	A	H

- 1. Level(dBμV/m) =
Antenna Factor(dB/m) + Cable Loss(dB) + Read Level(dBμV) - Preamp Factor(dB)
- 2. Over Limit(dB) = Level(dBμV/m) – Limit Line(dBμV/m)

For Peak Limit @ 2390MHz:

- 1. Level(dBμV/m)
= Antenna Factor(dB/m) + Cable Loss(dB) + Read Level(dBμV) - Preamp Factor(dB)
= 32.22(dB/m) + 4.58(dB) + 54.51(dBμV) – 35.86 (dB)
= 55.45 (dBμV/m)
- 2. Over Limit(dB)
= Level(dBμV/m) – Limit Line(dBμV/m)
= 55.45(dBμV/m) – 74(dBμV/m)
= -18.55(dB)

For Average Limit @ 2390MHz:

- 1. Level(dBμV/m)
= Antenna Factor(dB/m) + Cable Loss(dB) + Read Level(dBμV) - Preamp Factor(dB)
= 32.22(dB/m) + 4.58(dB) + 42.6(dBμV) – 35.86 (dB)
= 43.54 (dBμV/m)
- 2. Over Limit(dB)
= Level(dBμV/m) – Limit Line(dBμV/m)
= 43.54(dBμV/m) – 54(dBμV/m)
= -10.46(dB)

Both peak and average measured complies with the limit line, so test result is “PASS”.



Appendix D. Radiated Spurious Emission Plots

Test Engineer :	Tsung Lee, Stan Hsieh, and Kyle Chuang	Temperature :	22~24°C
		Relative Humidity :	46~48%

Note symbol

-L	Low channel location
-R	High channel location



Band 1 - 5150~5250MHz
WIFI 802.11ac VHT10 (Band Edge @ 3m)

WIFI	Band 1 5150~5250MHz Band Edge @ 3m	
ANT	802.11ac VHT10 CH32 5160MHz	
1+2	Horizontal	Fundamental
<p align="center">Peak</p>	<p>Site : 03CH10-HY Condition : PEAK_BE_74 3m HORN 9120D-HF HORIZONTAL Detector : Peak Project : 6N2223-01 Mode : 1</p>	<p>Site : 03CH10-HY Condition : PEAK_74 3m HORN 9120D-HF HORIZONTAL Detector : Peak Project : 6N2223-01 Mode : 1</p>
<p align="center">Avg.</p>	<p>Site : 03CH10-HY Condition : AVG_BE_54 3m HORN 9120D-HF HORIZONTAL Detector : Peak Project : 6N2223-01 Mode : 1</p>	<p align="center">Left blank</p>



WIFI	Band 1 5150~5250MHz Band Edge @ 3m	
ANT	802.11ac VHT10 CH32 5160MHz	
1+2	Vertical	Fundamental
<p>Peak</p>	<p>Site : 03CHD-HY Condition : PEAK_BE_74 3m HORN 9120D-HF VERTICAL : RBW:1000.000KHz VBW:3000.000KHz SWT:Auto Detector : Peak Project : 6N2223-01 Mode : 1</p>	<p>Site : 03CHD-HY Condition : PEAK_74 3m HORN 9120D-HF VERTICAL : RBW:1000.000KHz VBW:3000.000KHz SWT:Auto Detector : Peak Project : 6N2223-01 Mode : 1</p>
<p>Avg.</p>	<p>Site : 03CHD-HY Condition : AVG_BE_54 3m HORN 9120D-HF VERTICAL : RBW:1000.000KHz VBW:1.000KHz SWT:Auto Detector : Peak Project : 6N2223-01 Mode : 1</p>	<p>Left blank</p>



WIFI	Band 1 5150~5250MHz Band Edge @ 3m	
ANT	802.11ac VHT10 CH40 5200MHz - L	
1+2	Horizontal	Fundamental
<p>Peak</p>	<p>Site : 03CHD-HY Condition : PEAK_BE_74 3m HORN 9120D-HF HORIZONTAL Detector : Peak Project : 6N2223-01 Mode : Z</p>	<p>Site : 03CHD-HY Condition : PEAK_74 3m HORN 9120D-HF HORIZONTAL Detector : Peak Project : 6N2223-01 Mode : Z</p>
<p>Avg.</p>	<p>Site : 03CHD-HY Condition : AVG_BE_54 3m HORN 9120D-HF HORIZONTAL Detector : Peak Project : 6N2223-01 Mode : Z</p>	<p>Left blank</p>

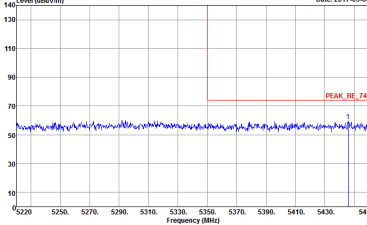

WIFI	Band 1 5150~5250MHz Band Edge @ 3m	
ANT	802.11ac VHT10 CH40 5200MHz - R	
1+2	Horizontal	Fundamental
<p>Peak</p>	 <p>Site : 03CH10-HY Condition : PEAK_BE_74 3m HORN 9120D-HF HORIZONTAL Detector : Peak Project : 6N2223-01 Mode : Z</p>	<p>Left blank</p>
<p>Avg.</p>	 <p>Site : 03CH10-HY Condition : AVG_BE_54 3m HORN 9120D-HF HORIZONTAL Detector : Peak Project : 6N2223-01 Mode : Z</p>	<p>Left blank</p>

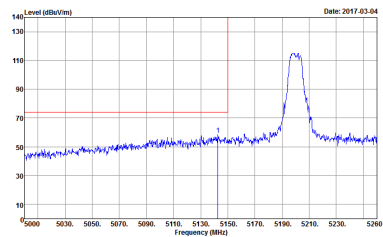
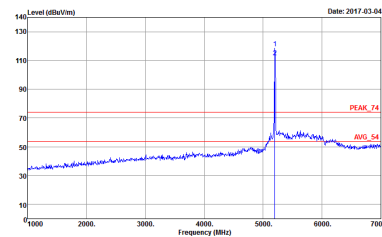
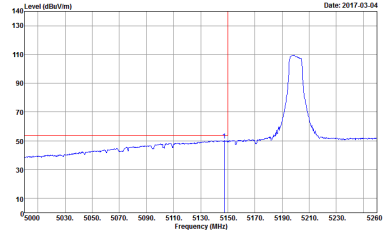

WIFI	Band 1 5150~5250MHz Band Edge @ 3m	
ANT	802.11ac VHT10 CH40 5200MHz - L	
1+2	Vertical	Fundamental
<p>Peak</p>	 <p>Site : 03CHD-HY Condition : PEAK_BE_74 3m HORN 9120D-HF VERTICAL : RBW:1000.000KHz VBW:3000.000KHz SWT:Auto Detector : Peak Project : 6N2223-01 Mode : Z</p>	 <p>Site : 03CHD-HY Condition : PEAK_74 3m HORN 9120D-HF VERTICAL : RBW:1000.000KHz VBW:3000.000KHz SWT:Auto Detector : Peak Project : 6N2223-01 Mode : Z</p>
<p>Avg.</p>	 <p>Site : 03CHD-HY Condition : AVG_BE_54 3m HORN 9120D-HF VERTICAL : RBW:1000.000KHz VBW:1.000KHz SWT:Auto Detector : Peak Project : 6N2223-01 Mode : Z</p>	<p>Left blank</p>

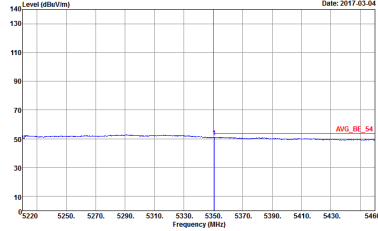

WIFI	Band 1 5150~5250MHz Band Edge @ 3m	
ANT	802.11ac VHT10 CH40 5200MHz - R	
1+2	Vertical	Fundamental
<p>Peak</p>	 <p>Site : 03CHD-HY Condition : PEAK_BE_74 3m HORN 9120D-HF VERTICAL Detector : Peak Project : 6N2223-01 Mode : Z</p>	<p>Left blank</p>
<p>Avg.</p>	 <p>Site : 03CHD-HY Condition : AVG_BE_54 3m HORN 9120D-HF VERTICAL Detector : Peak Project : 6N2223-01 Mode : Z</p>	<p>Left blank</p>



WIFI	Band 1 5150~5250MHz Band Edge @ 3m	
ANT	802.11ac VHT10 CH49 5245MHz - L	
1+2	Horizontal	Fundamental
<p>Peak</p>	<p>Site : 03CHD-HY Condition : PEAK_BE_74 3m HORN 9120D-HF HORIZONTAL : RBW:1000.000KHz VBW:3000.000KHz SWT:Auto Detector : Peak Project : 6N2223-01 Mode : 3</p>	<p>Site : 03CHD-HY Condition : PEAK_74 3m HORN 9120D-HF HORIZONTAL : RBW:1000.000KHz VBW:3000.000KHz SWT:Auto Detector : Peak Project : 6N2223-01 Mode : 3</p>
<p>Avg.</p>	<p>Site : 03CHD-HY Condition : AVG_BE_54 3m HORN 9120D-HF HORIZONTAL : RBW:1000.000KHz VBW:1.000KHz SWT:Auto Detector : Peak Project : 6N2223-01 Mode : 3</p>	<p>Left blank</p>

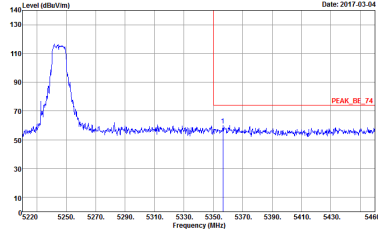
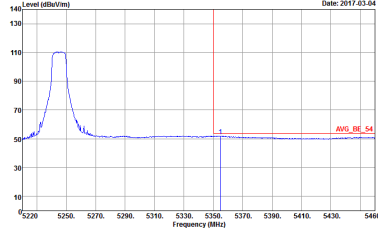

WIFI	Band 1 5150~5250MHz Band Edge @ 3m	
ANT	802.11ac VHT10 CH49 5245MHz - R	
1+2	Horizontal	Fundamental
<p>Peak</p>	 <p>Site : 03CH10-HY Condition : PEAK_BE_74 3m HORN 9120D-HF HORIZONTAL Detector : Peak Project : 6N2223-01 Mode : 3</p>	<p>Left blank</p>
<p>Avg.</p>	 <p>Site : 03CH10-HY Condition : AVG_BE_54 3m HORN 9120D-HF HORIZONTAL Detector : Peak Project : 6N2223-01 Mode : 3</p>	<p>Left blank</p>

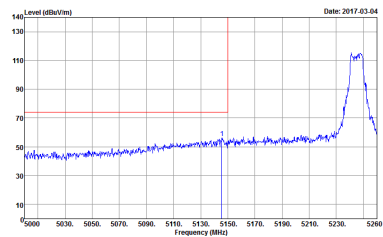
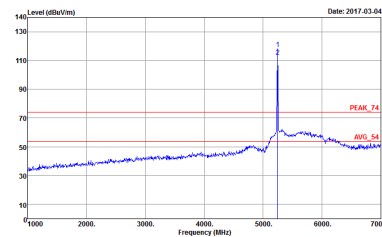
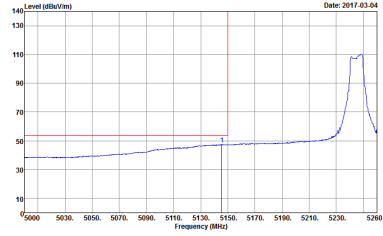

WIFI	Band 1 5150~5250MHz Band Edge @ 3m	
ANT	802.11ac VHT10 CH49 5245MHz - L	
1+2	Vertical	Fundamental
<p>Peak</p>	 <p>Site : 03CHD-HY Condition : PEAK_BE_74 3m HORN 9120D-HF VERTICAL : RBW:1000.000KHz VBW:3000.000KHz SWT:Auto Detector : Peak Project : 6N2223-01 Mode : 3</p>	 <p>Site : 03CHD-HY Condition : PEAK_74 3m HORN 9120D-HF VERTICAL : RBW:1000.000KHz VBW:3000.000KHz SWT:Auto Detector : Peak Project : 6N2223-01 Mode : 3</p>
<p>Avg.</p>	 <p>Site : 03CHD-HY Condition : AVG_BE_54 3m HORN 9120D-HF VERTICAL : RBW:1000.000KHz VBW:1.000KHz SWT:Auto Detector : Peak Project : 6N2223-01 Mode : 3</p>	<p>Left blank</p>

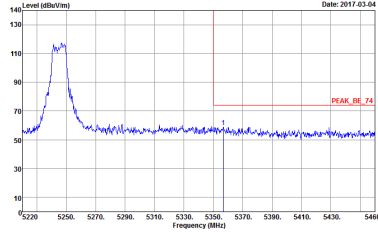
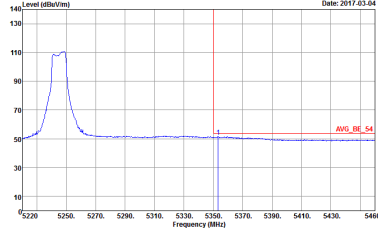

WIFI	Band 1 5150~5250MHz Band Edge @ 3m	
ANT	802.11ac VHT10 CH49 5245MHz - R	
1+2	Vertical	Fundamental
<p>Peak</p>	 <p>Site : 03CHD-HY Condition : PEAK_BE_74 3m HORN 9120D-HF VERTICAL : RBW:1000.000KHz VBW:3000.000KHz SWT:Auto Detector : Peak Project : 6N2223-01 Mode : 3</p>	<p>Left blank</p>
<p>Avg.</p>	 <p>Site : 03CHD-HY Condition : AVG_BE_54 3m HORN 9120D-HF VERTICAL : RBW:1000.000KHz VBW:1.000KHz SWT:Auto Detector : Peak Project : 6N2223-01 Mode : 3</p>	<p>Left blank</p>



Band 1 5150~5250MHz

WIFI 802.11ac VHT20 (Band Edge @ 3m)

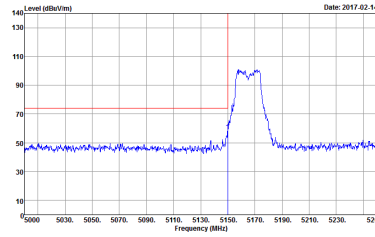
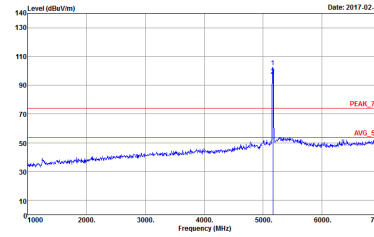
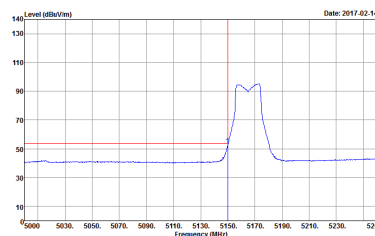
WIFI	Band 1 5150~5250MHz Band Edge @ 3m	
ANT	802.11ac VHT20 CH33 5165MHz	
1+2	Horizontal	Fundamental
Peak	 <p>Site : 03CH10-HY Condition : PEAK_BE_74 3m HORN 91200-HF HORIZONTAL : RBW:1000.000KHz VBW:3000.000KHz SWT:Auto Detector : Peak Project : 6N2223-01 Mode : 4</p>	 <p>Site : 03CH10-HY Condition : PEAK_74 3m HORN 91200-HF HORIZONTAL : RBW:1000.000KHz VBW:3000.000KHz SWT:Auto Detector : Peak Project : 6N2223-01 Mode : 4</p>
Avg.	 <p>Site : 03CH10-HY Condition : AVG_BE_54 3m HORN 91200-HF HORIZONTAL : RBW:1000.000KHz VBW:1000KHz SWT:Auto Detector : Peak Project : 6N2223-01 Mode : 4</p>	Left blank

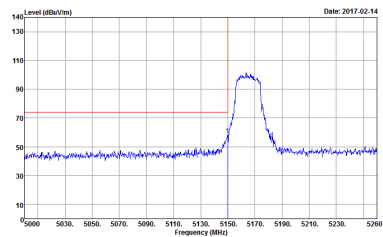
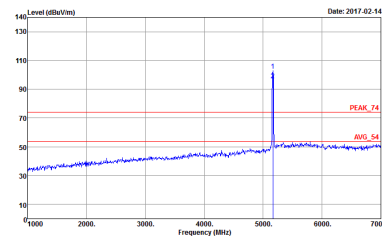
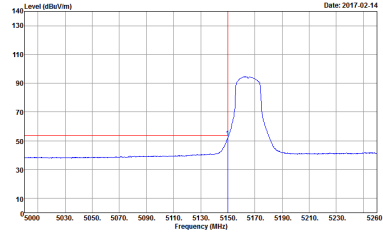

WIFI	Band 1 5150~5250MHz Band Edge @ 3m	
ANT	802.11ac VHT20 CH33 5165MHz	
1+2	Vertical	Fundamental
<p>Peak</p>	 <p>Site : 03CHD-HY Condition : PEAK_BE_74 3m HORN 9120D-HF VERTICAL : RBW:1000.000KHz VBW:3000.000KHz SWT:Auto Detector : Peak Project : 6N2223-01 Mode : 4</p>	 <p>Site : 03CHD-HY Condition : PEAK_74 3m HORN 9120D-HF VERTICAL : RBW:1000.000KHz VBW:3000.000KHz SWT:Auto Detector : Peak Project : 6N2223-01 Mode : 4</p>
<p>Avg.</p>	 <p>Site : 03CHD-HY Condition : AVG_BE_54 3m HORN 9120D-HF VERTICAL : RBW:1000.000KHz VBW:1.000KHz SWT:Auto Detector : Peak Project : 6N2223-01 Mode : 4</p>	<p>Left blank</p>

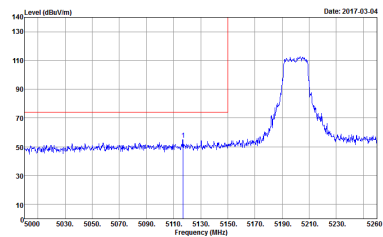
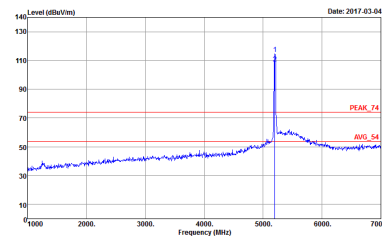
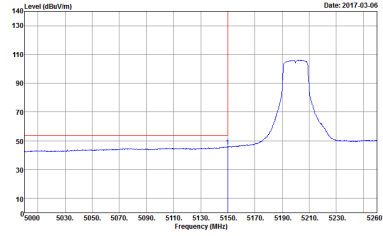

WIFI	Band 1 5150~5250MHz Band Edge @ 3m	
ANT	802.11ac VHT20 CH40 5200MHz - L	
1+2	Horizontal	Fundamental
<p>Peak</p>	 <p>Site : 03CHD-HY Condition : PEAK_BE_74 3m HORN 9120D-HF HORIZONTAL Detector : Peak Project : 6N2223-01 Mode : 5</p>	 <p>Site : 03CHD-HY Condition : PEAK_74 3m HORN 9120D-HF HORIZONTAL Detector : Peak Project : 6N2223-01 Mode : 5</p>
<p>Avg.</p>	 <p>Site : 03CHD-HY Condition : AVG_BE_54 3m HORN 9120D-HF HORIZONTAL Detector : Peak Project : 6N2223-01 Mode : 5</p>	<p>Left blank</p>

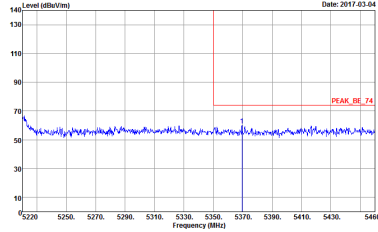
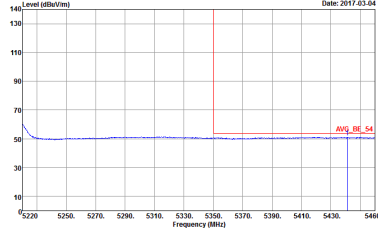

WIFI	Band 1 5150~5250MHz Band Edge @ 3m	
ANT	802.11ac VHT20 CH40 5200MHz - R	
1+2	Horizontal	Fundamental
<p>Peak</p>	 <p>Site : 03CHD-HY Condition : PEAK_BE_74 3m HORN 9120D-HF HORIZONTAL Detector : Peak Project : 6N2223-01 Mode : 5</p>	<p>Left blank</p>
<p>Avg.</p>	 <p>Site : 03CHD-HY Condition : AVG_BE_54 3m HORN 9120D-HF HORIZONTAL Detector : Peak Project : 6N2223-01 Mode : 5</p>	<p>Left blank</p>

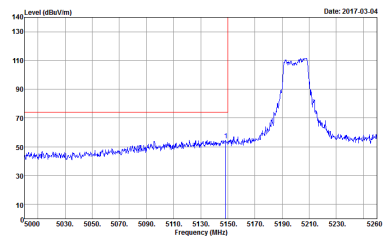
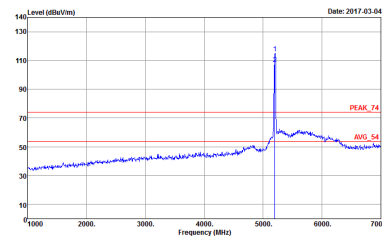
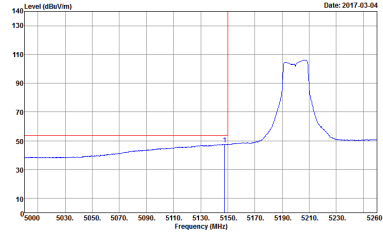

WIFI	Band 1 5150~5250MHz Band Edge @ 3m	
ANT	802.11ac VHT20 CH40 5200MHz - L	
1+2	Vertical	Fundamental
Peak	 <p>Date: 2017.03.04</p> <p>Site : 03CHD-HY Condition : PEAK_BE_74 3m HORN 9120D-HF VERTICAL : RBW:1000.000KHz VBW:3000.000KHz SWT:Auto Detector : Peak Project : 6N2223-01 Mode : 5</p>	 <p>Date: 2017.03.04</p> <p>Site : 03CHD-HY Condition : PEAK_74 3m HORN 9120D-HF VERTICAL : RBW:1000.000KHz VBW:3000.000KHz SWT:Auto Detector : Peak Project : 6N2223-01 Mode : 5</p>
Avg.	 <p>Date: 2017.03.04</p> <p>Site : 03CHD-HY Condition : AVG_BE_54 3m HORN 9120D-HF VERTICAL : RBW:1000.000KHz VBW:1000KHz SWT:Auto Detector : Peak Project : 6N2223-01 Mode : 5</p>	Left blank

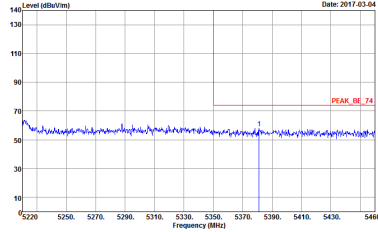

WIFI	Band 1 5150~5250MHz Band Edge @ 3m	
ANT	802.11ac VHT20 CH40 5200MHz - R	
1+2	Vertical	Fundamental
<p>Peak</p>	 <p>Site : 03CHD-HY Condition : PEAK_BE_74 3m HORN 9120D-HF VERTICAL Detector : Peak Project : 6N2223-01 Mode : 5</p>	<p>Left blank</p>
<p>Avg.</p>	 <p>Site : 03CHD-HY Condition : AVG_BE_54 3m HORN 9120D-HF VERTICAL Detector : Peak Project : 6N2223-01 Mode : 5</p>	<p>Left blank</p>

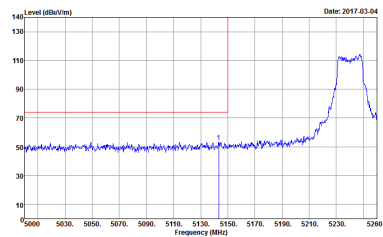
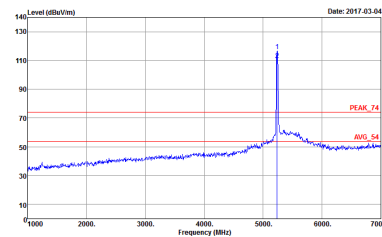
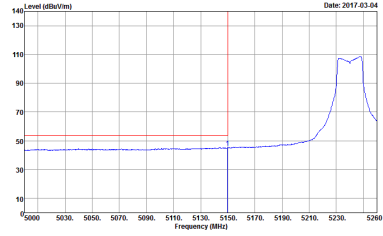

WIFI	Band 1 5150~5250MHz Band Edge @ 3m	
ANT	802.11ac VHT20 CH48 5240MHz - L	
1+2	Horizontal	Fundamental
<p>Peak</p>	 <p>Site : 03CHD-HY Condition : PEAK_BE_74 3m HORN 9120D-HF HORIZONTAL Detector : Peak Project : 6N2223-01 Mode : 6</p>	 <p>Site : 03CHD-HY Condition : PEAK_74 3m HORN 9120D-HF HORIZONTAL Detector : Peak Project : 6N2223-01 Mode : 6</p>
<p>Avg.</p>	 <p>Site : 03CHD-HY Condition : AVG_BE_54 3m HORN 9120D-HF HORIZONTAL Detector : Peak Project : 6N2223-01 Mode : 6</p>	<p>Left blank</p>

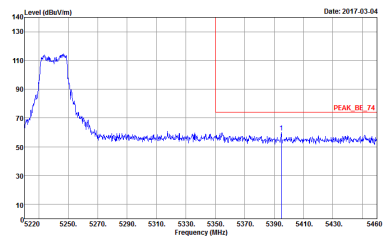
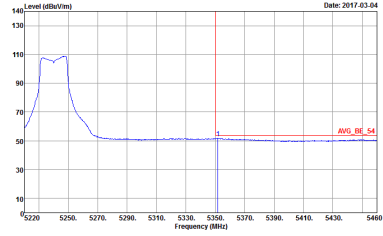

WIFI	Band 1 5150~5250MHz Band Edge @ 3m	
ANT	802.11ac VHT20 CH48 5240MHz - R	
1+2	Horizontal	Fundamental
<p>Peak</p>	 <p>Site : 03CHD-HY Condition : PEAK_BE_74 3m HORN 9120D-HF HORIZONTAL Detector : Peak Project : 6N2223-01 Mode : 6</p>	<p>Left blank</p>
<p>Avg.</p>	 <p>Site : 03CHD-HY Condition : AVG_BE_54 3m HORN 9120D-HF HORIZONTAL Detector : Peak Project : 6N2223-01 Mode : 6</p>	<p>Left blank</p>

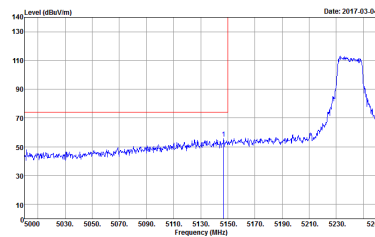
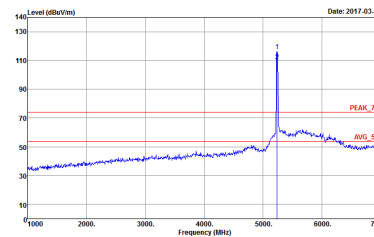
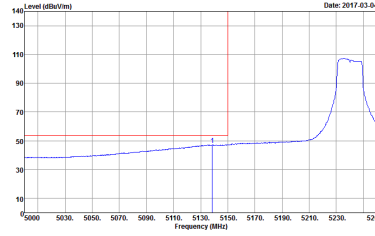

WIFI	Band 1 5150~5250MHz Band Edge @ 3m	
ANT	802.11ac VHT20 CH48 5240MHz - L	
1+2	Vertical	Fundamental
<p>Peak</p>	 <p>Site : 03CHD-HY Condition : PEAK_BE_74 3m HORN 9120D-HF VERTICAL : RBW:1000.000KHz VBW:3000.000KHz SWT:Auto Detector : Peak Project : 6N2223-01 Mode : 6</p>	 <p>Site : 03CHD-HY Condition : PEAK_74 3m HORN 9120D-HF VERTICAL : RBW:1000.000KHz VBW:3000.000KHz SWT:Auto Detector : Peak Project : 6N2223-01 Mode : 6</p>
<p>Avg.</p>	 <p>Site : 03CHD-HY Condition : AVG_BE_54 3m HORN 9120D-HF VERTICAL : RBW:1000.000KHz VBW:1000KHz SWT:Auto Detector : Peak Project : 6N2223-01 Mode : 6</p>	<p>Left blank</p>

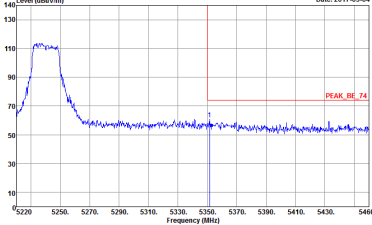
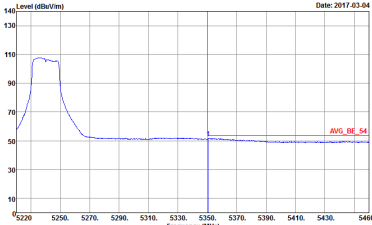

WIFI	Band 1 5150~5250MHz Band Edge @ 3m	
ANT	802.11ac VHT20 CH48 5240MHz - R	
1+2	Vertical	Fundamental
<p>Peak</p>	 <p>Site : 03CHD-HY Condition : PEAK_BE_74 3m HORN 9120D-HF VERTICAL : RBW:1000.000KHz VBW:3000.000KHz SWT:Auto Detector : Peak Project : 6N2223-01 Mode : 6</p>	<p>Left blank</p>
<p>Avg.</p>	 <p>Site : 03CHD-HY Condition : AVG_BE_54 3m HORN 9120D-HF VERTICAL : RBW:1000.000KHz VBW:1000KHz SWT:Auto Detector : Peak Project : 6N2223-01 Mode : 6</p>	<p>Left blank</p>



**Band 1 5150~5250MHz
WIFI 802.11ac VHT30 (Band Edge @ 3m)**

WIFI	Band 1 5150~5250MHz Band Edge @ 3m	
ANT	802.11ac VHT30 CH34 5170MHz - L	
1+2	Horizontal	Fundamental
Peak	<p>Site : 03CH10-HY Condition : PEAK_BE_74 3m HORN 91200-HF HORIZONTAL Detector : Peak Project : 6N2223-01 Mode : 7</p>	<p>Site : 03CH10-HY Condition : PEAK_74 3m HORN 91200-HF HORIZONTAL Detector : Peak Project : 6N2223-01 Mode : 7</p>
Avg.	<p>Site : 03CH10-HY Condition : AVG_BE_54 3m HORN 91200-HF HORIZONTAL Detector : Peak Project : 6N2223-01 Mode : 7</p>	Left blank

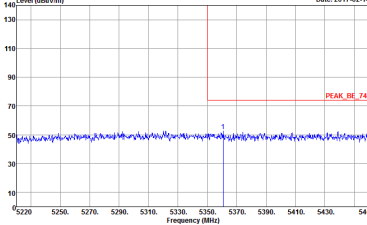
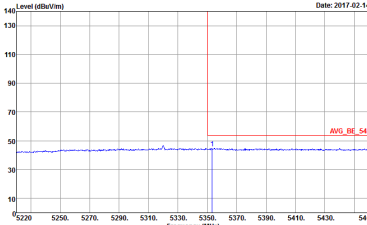

WIFI	Band 1 5150~5250MHz Band Edge @ 3m	
ANT	802.11ac VHT30 CH34 5170MHz - R	
1+2	Horizontal	Fundamental
<p>Peak</p>	 <p>Site : 03CHD-HY Condition : PEAK_BE_74 3m HORN 91200-HF HORIZONTAL Detector : Peak Project : 6N2223-01 Mode : 7</p>	<p>Left blank</p>
<p>Avg.</p>	 <p>Site : 03CHD-HY Condition : AVG_BE_54 3m HORN 91200-HF HORIZONTAL Detector : Peak Project : 6N2223-01 Mode : 7</p>	<p>Left blank</p>

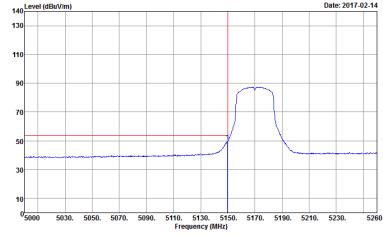

WIFI	Band 1 5150~5250MHz Band Edge @ 3m	
ANT	802.11ac VHT30 CH34 5170MHz - L	
1+2	Vertical	Fundamental
<p>Peak</p>	 <p>Site : 03CHD-HY Condition : PEAK_BE_74 3m HORN 91200-HF VERTICAL : RBW:1000.000KHz VBW:3000.000KHz SWT:Auto Detector : Peak Project : 6N2223-01 Mode : 7</p>	 <p>Site : 03CHD-HY Condition : PEAK_74 3m HORN 91200-HF VERTICAL : RBW:1000.000KHz VBW:3000.000KHz SWT:Auto Detector : Peak Project : 6N2223-01 Mode : 7</p>
<p>Avg.</p>	 <p>Site : 03CHD-HY Condition : AVG_BE_54 3m HORN 91200-HF VERTICAL : RBW:1000.000KHz VBW:3000.000KHz SWT:Auto Detector : Peak Project : 6N2223-01 Mode : 7</p>	<p>Left blank</p>



WIFI	Band 1 5150~5250MHz Band Edge @ 3m	
ANT	802.11ac VHT30 CH34 5170MHz - R	
1+2	Vertical	Fundamental
<p>Peak</p>	 <p>Site : 03CHD-HY Condition : PEAK_BE_74 3m HORN 91200-HF VERTICAL Detector : Peak Project : 6N2223-01 Mode : 7</p>	<p>Left blank</p>
<p>Avg.</p>	 <p>Site : 03CHD-HY Condition : AVG_BE_54 3m HORN 91200-HF VERTICAL Detector : Peak Project : 6N2223-01 Mode : 7</p>	<p>Left blank</p>

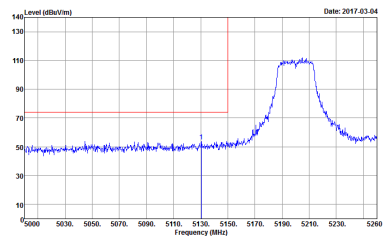
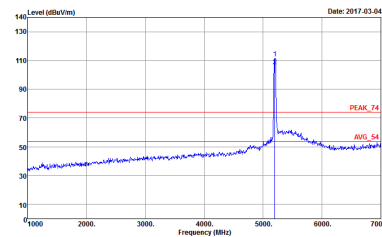
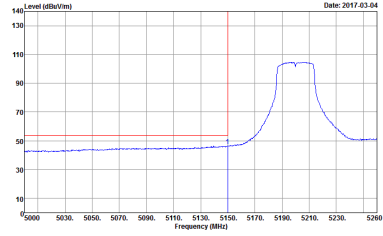

WIFI	Band 1 5150~5250MHz Band Edge @ 3m	
ANT	802.11ac VHT30 CH40 5200MHz - L	
1+2	Horizontal	Fundamental
<p>Peak</p>	 <p>Site : 03CHD-HY Condition : PEAK_BE_74 3m HORN 9120D-HF HORIZONTAL : RBW:1000.000KHz VBW:3000.000KHz SWT:Auto Detector : Peak Project : 6N2223-01 Mode : B</p>	 <p>Site : 03CHD-HY Condition : PEAK_74 3m HORN 9120D-HF HORIZONTAL : RBW:1000.000KHz VBW:3000.000KHz SWT:Auto Detector : Peak Project : 6N2223-01 Mode : B</p>
<p>Avg.</p>	 <p>Site : 03CHD-HY Condition : AVG_BE_54 3m HORN 9120D-HF HORIZONTAL : RBW:1000.000KHz VBW:3.000KHz SWT:Auto Detector : Peak Project : 6N2223-01 Mode : B</p>	<p>Left blank</p>



WIFI	Band 1 5150~5250MHz Band Edge @ 3m	
ANT	802.11ac VHT30 CH40 5200MHz - R	
1+2	Horizontal	Fundamental
Peak	<p>Site : 03CHD-HY Condition : PEAK_BE_74 3m HORN 91200-HF HORIZONTAL Detector : Peak Project : 6N2223-01 Mode : B</p>	Left blank
Avg.	<p>Site : 03CHD-HY Condition : AVG_BE_54 3m HORN 91200-HF HORIZONTAL Detector : Peak Project : 6N2223-01 Mode : B</p>	Left blank

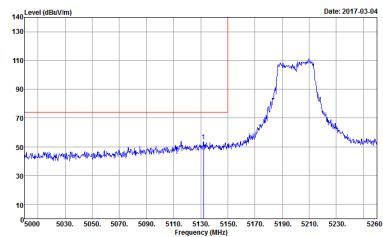
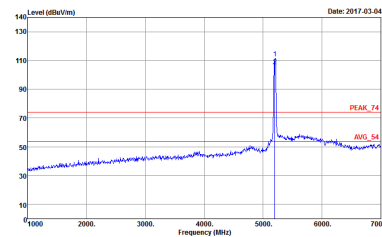
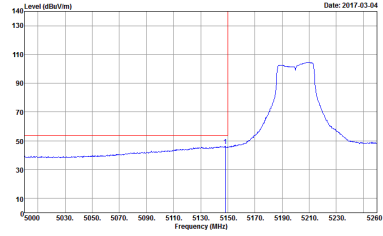

WIFI	Band 1 5150~5250MHz Band Edge @ 3m	
ANT	802.11ac VHT30 CH40 5200MHz - L	
1+2	Vertical	Fundamental
<p>Peak</p>	 <p>Site : 03CHD-HY Condition : PEAK_BE_74 3m HORN 9120D-HF VERTICAL Detector : Peak Project : 6N2223-01 Mode : B</p>	 <p>Site : 03CHD-HY Condition : PEAK_74 3m HORN 9120D-HF VERTICAL Detector : Peak Project : 6N2223-01 Mode : B</p>
<p>Avg.</p>	 <p>Site : 03CHD-HY Condition : AVG_BE_54 3m HORN 9120D-HF VERTICAL Detector : Peak Project : 6N2223-01 Mode : B</p>	<p>Left blank</p>

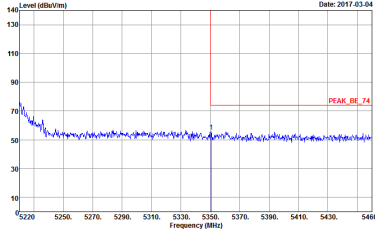
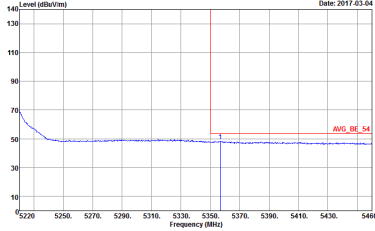

WIFI	Band 1 5150~5250MHz Band Edge @ 3m	
ANT	802.11ac VHT30 CH40 5200MHz - R	
1+2	Vertical	Fundamental
<p>Peak</p>	 <p>Site : 03CHD-HY Condition : PEAK_BE_74 3m HORN 91200-HF VERTICAL Detector : Peak Project : 6N2223-01 Mode : B</p>	<p>Left blank</p>
<p>Avg.</p>	 <p>Site : 03CHD-HY Condition : AVG_BE_54 3m HORN 91200-HF VERTICAL Detector : Peak Project : 6N2223-01 Mode : B</p>	<p>Left blank</p>



WIFI	Band 1 5150~5250MHz Band Edge @ 3m	
ANT	802.11ac VHT30 CH47 5235MHz - L	
1+2	Horizontal	Fundamental
<p>Peak</p>	<p>Site : 03CHD-HY Condition : PEAK_BE_74 3m HORN 91200-HF HORIZONTAL : RBW:1000.000KHz VBW:3000.000KHz SWT:Auto Detector : Peak Project : 6N2223-01 Mode : 9</p>	<p>Site : 03CHD-HY Condition : PEAK_74 3m HORN 91200-HF HORIZONTAL : RBW:1000.000KHz VBW:3000.000KHz SWT:Auto Detector : Peak Project : 6N2223-01 Mode : 9</p>
<p>Avg.</p>	<p>Site : 03CHD-HY Condition : AVG_BE_54 3m HORN 91200-HF HORIZONTAL : RBW:1000.000KHz VBW:3000.000KHz SWT:Auto Detector : Peak Project : 6N2223-01 Mode : 9</p>	<p>Left blank</p>

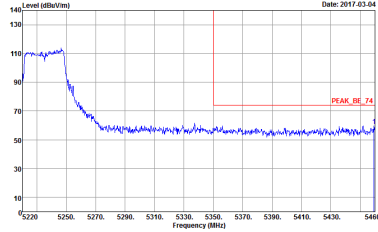
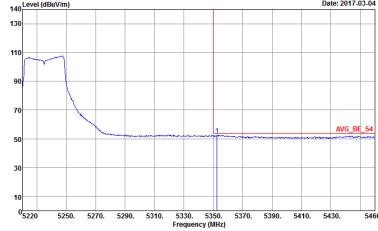

WIFI	Band 1 5150~5250MHz Band Edge @ 3m	
ANT	802.11ac VHT30 CH47 5235MHz - R	
1+2	Horizontal	Fundamental
<p>Peak</p>	 <p>Site : 03CHD-HY Condition : PEAK_BE_74 3m HORN 91200-HF HORIZONTAL : RBW:1000.000KHz VBW:3000.000KHz SWT:Auto Detector : Peak Project : 6N2223-01 Mode : 9</p>	<p>Left blank</p>
<p>Avg.</p>	 <p>Site : 03CHD-HY Condition : AVG_BE_54 3m HORN 91200-HF HORIZONTAL : RBW:1000.000KHz VBW:3000.000KHz SWT:Auto Detector : Peak Project : 6N2223-01 Mode : 9</p>	<p>Left blank</p>

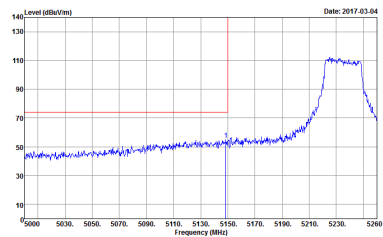
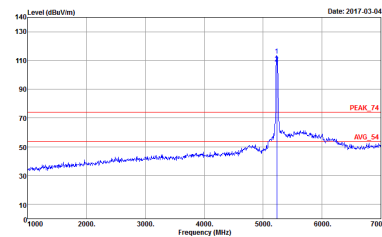
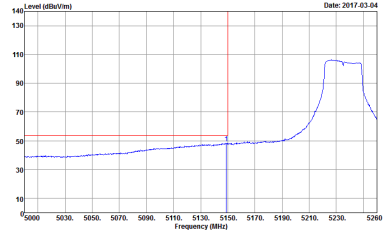

WIFI	Band 1 5150~5250MHz Band Edge @ 3m	
ANT	802.11ac VHT30 CH47 5235MHz - L	
1+2	Vertical	Fundamental
<p>Peak</p>	 <p>Site : 03CHD-HY Condition : PEAK_BE_74 3m HORN 91200-HF VERTICAL : RBW:1000.000KHz VBW:3000.000KHz SWT:Auto Detector : Peak Project : 6N2223-01 Mode : 9</p>	 <p>Site : 03CHD-HY Condition : PEAK_74 3m HORN 91200-HF VERTICAL : RBW:1000.000KHz VBW:3000.000KHz SWT:Auto Detector : Peak Project : 6N2223-01 Mode : 9</p>
<p>Avg.</p>	 <p>Site : 03CHD-HY Condition : AVG_BE_54 3m HORN 91200-HF VERTICAL : RBW:1000.000KHz VBW:3000.000KHz SWT:Auto Detector : Peak Project : 6N2223-01 Mode : 9</p>	<p>Left blank</p>

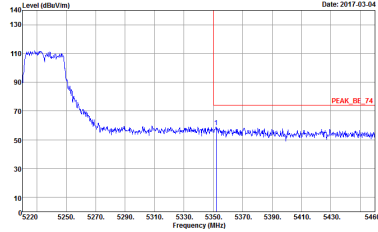
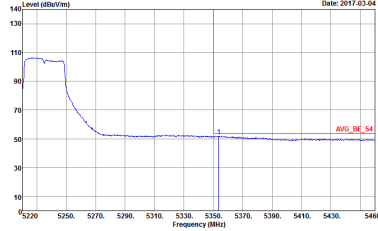

WIFI	Band 1 5150~5250MHz Band Edge @ 3m	
ANT	802.11ac VHT30 CH47 5235MHz - R	
1+2	Vertical	Fundamental
<p>Peak</p>	 <p>Site : 03CHD-HY Condition : PEAK_BE_74 3m HORN 91200-HF VERTICAL : RBW:1000.000KHz VBW:3000.000KHz SWT:Auto Detector : Peak Project : 6N2223-01 Mode : 9</p>	<p>Left blank</p>
<p>Avg.</p>	 <p>Site : 03CHD-HY Condition : AVG_BE_54 3m HORN 91200-HF VERTICAL : RBW:1000.000KHz VBW:3000.000KHz SWT:Auto Detector : Peak Project : 6N2223-01 Mode : 9</p>	<p>Left blank</p>



Band 1 5150~5250MHz

WIFI 802.11ac VHT40 (Band Edge @ 3m)

WIFI	Band 1 5150~5250MHz Band Edge @ 3m	
ANT	802.11ac VHT40 CH35 5175MHz - L	
1+2	Horizontal	Fundamental
<p>Peak</p>	<p>Site : 03CHD-HY Condition : PEAK_BE_74 3m HORN 91200-HF HORIZONTAL : RBW:1000.000KHz VBW:3000.000KHz SWT:Auto Detector : Peak Project : 6N2223-01 Mode : 10</p>	<p>Site : 03CHD-HY Condition : PEAK_74 3m HORN 91200-HF HORIZONTAL : RBW:1000.000KHz VBW:3000.000KHz SWT:Auto Detector : Peak Project : 6N2223-01 Mode : 10</p>
<p>Avg.</p>	<p>Site : 03CHD-HY Condition : AVG_BE_54 3m HORN 91200-HF HORIZONTAL : RBW:1000.000KHz VBW:3000KHz SWT:Auto Detector : Peak Project : 6N2223-01 Mode : 10</p>	<p>Left blank</p>

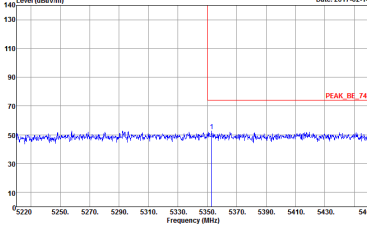
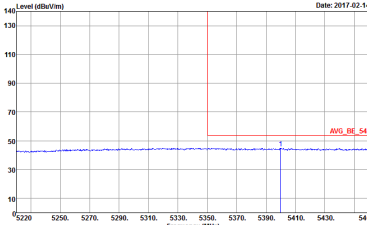

WIFI	Band 1 5150~5250MHz Band Edge @ 3m	
ANT	802.11ac VHT40 CH35 5175MHz - R	
1+2	Horizontal	Fundamental
<p>Peak</p>	 <p>Site : 03CH10-HY Condition : PEAK_BE_74 3m HORN 91200-HF HORIZONTAL Detector : Peak Project : 6N2223-01 Mode : ID</p>	<p>Left blank</p>
<p>Avg.</p>	 <p>Site : 03CH10-HY Condition : AVG_BE_54 3m HORN 91200-HF HORIZONTAL Detector : Peak Project : 6N2223-01 Mode : ID</p>	<p>Left blank</p>

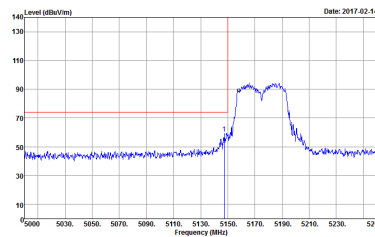
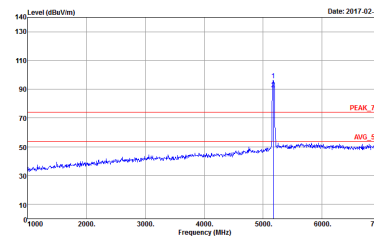
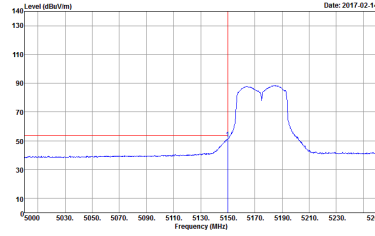

WIFI	Band 1 5150~5250MHz Band Edge @ 3m	
ANT	802.11ac VHT40 CH35 5175MHz - L	
1+2	Vertical	Fundamental
<p>Peak</p>	 <p>Site : 03CHD-HY Condition : PEAK_BE_74 3m HORN 9120D-HF VERTICAL Detector : Peak Project : 6N2223-01 Mode : 10</p>	 <p>Site : 03CHD-HY Condition : PEAK_74 3m HORN 9120D-HF VERTICAL Detector : Peak Project : 6N2223-01 Mode : 10</p>
<p>Avg.</p>	 <p>Site : 03CHD-HY Condition : AVG_BE_54 3m HORN 9120D-HF VERTICAL Detector : Peak Project : 6N2223-01 Mode : 10</p>	<p>Left blank</p>

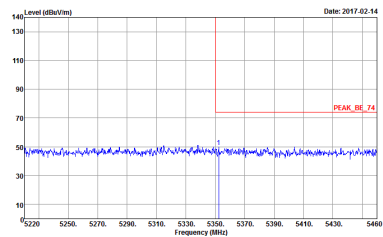
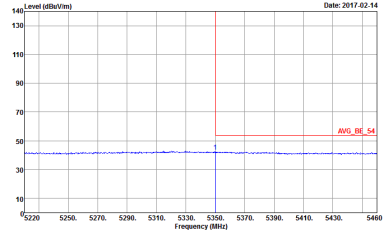

WIFI	Band 1 5150~5250MHz Band Edge @ 3m	
ANT	802.11ac VHT40 CH35 5175MHz - R	
1+2	Vertical	Fundamental
<p>Peak</p>	 <p>Site : 03CHD-HY Condition : PEAK_BE_74 3m HORN 91200-HF VERTICAL Detector : Peak Project : 6N2223-01 Mode : ID</p>	<p>Left blank</p>
<p>Avg.</p>	 <p>Site : 03CHD-HY Condition : AVG_BE_54 3m HORN 91200-HF VERTICAL Detector : Peak Project : 6N2223-01 Mode : ID</p>	<p>Left blank</p>

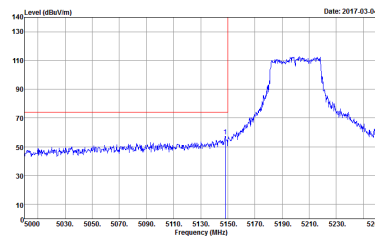
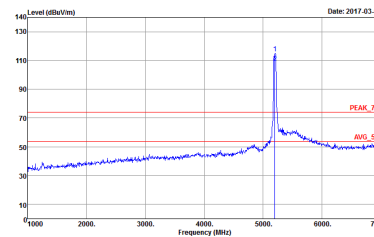
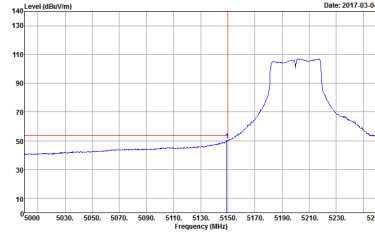

WIFI	Band 1 5150~5250MHz Band Edge @ 3m	
ANT	802.11ac VHT40 CH40 5200MHz - L	
1+2	Horizontal	Fundamental
<p>Peak</p>	 <p>Site : 03CHD-HY Condition : PEAK_BE_74 3m HORN 91200-HF HORIZONTAL Detector : Peak Project : 6N2223-01 Mode : 11</p>	 <p>Site : 03CHD-HY Condition : PEAK_74 3m HORN 91200-HF HORIZONTAL Detector : Peak Project : 6N2223-01 Mode : 11</p>
<p>Avg.</p>	 <p>Site : 03CHD-HY Condition : AVG_BE_54 3m HORN 91200-HF HORIZONTAL Detector : Peak Project : 6N2223-01 Mode : 11</p>	<p>Left blank</p>

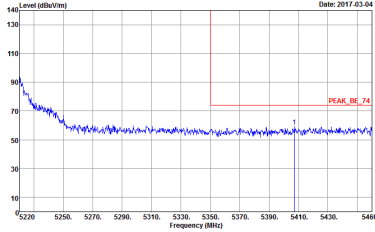
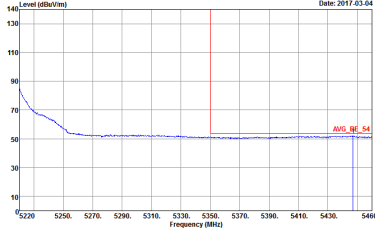

WIFI	Band 1 5150~5250MHz Band Edge @ 3m	
ANT	802.11ac VHT40 CH40 5200MHz - R	
1+2	Horizontal	Fundamental
<p>Peak</p>	 <p>Site : 03CHD-HY Condition : PEAK_BE_74 3m HORN 91200-HF HORIZONTAL Detector : Peak Project : 6N2223-01 Mode : 11</p>	<p>Left blank</p>
<p>Avg.</p>	 <p>Site : 03CHD-HY Condition : AVG_BE_54 3m HORN 91200-HF HORIZONTAL Detector : Peak Project : 6N2223-01 Mode : 11</p>	<p>Left blank</p>

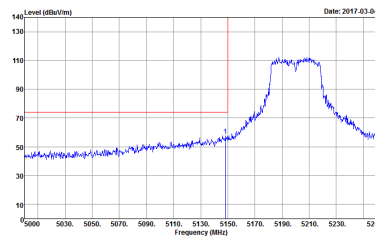
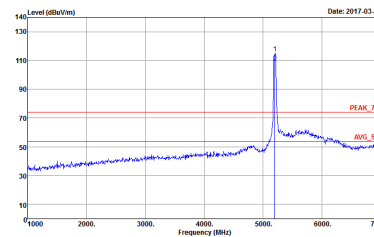
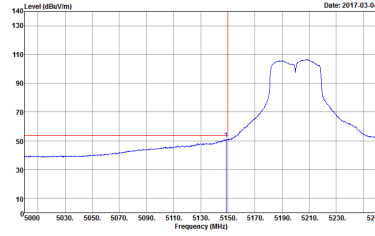

WIFI	Band 1 5150~5250MHz Band Edge @ 3m	
ANT	802.11ac VHT40 CH40 5200MHz - L	
1+2	Vertical	Fundamental
<p>Peak</p>	 <p>Site : 03CHD-HY Condition : PEAK_BE_74 3m HORN 91200-HF VERTICAL : RBW:1000.000KHz VBW:3000.000KHz SWT:Auto Detector : Peak Project : 6N2223-01 Mode : 11</p>	 <p>Site : 03CHD-HY Condition : PEAK_74 3m HORN 91200-HF VERTICAL : RBW:1000.000KHz VBW:3000.000KHz SWT:Auto Detector : Peak Project : 6N2223-01 Mode : 11</p>
<p>Avg.</p>	 <p>Site : 03CHD-HY Condition : AVG_BE_54 3m HORN 91200-HF VERTICAL : RBW:1000.000KHz VBW:3000.000KHz SWT:Auto Detector : Peak Project : 6N2223-01 Mode : 11</p>	<p>Left blank</p>

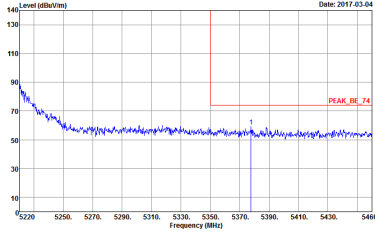
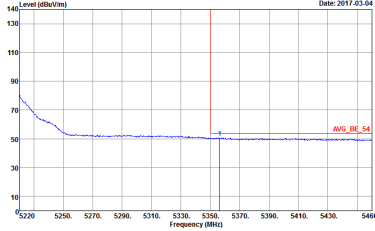

WIFI	Band 1 5150~5250MHz Band Edge @ 3m	
ANT	802.11ac VHT40 CH40 5200MHz - R	
1+2	Vertical	Fundamental
<p>Peak</p>	 <p>Site : 03CHD-HY Condition : PEAK_BE_74 3m HORN 91200-HF VERTICAL Detector : Peak Project : 6N2223-01 Mode : 11</p>	<p>Left blank</p>
<p>Avg.</p>	 <p>Site : 03CHD-HY Condition : AVG_BE_54 3m HORN 91200-HF VERTICAL Detector : Peak Project : 6N2223-01 Mode : 11</p>	<p>Left blank</p>

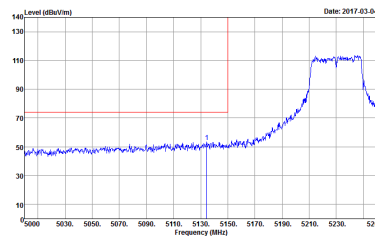
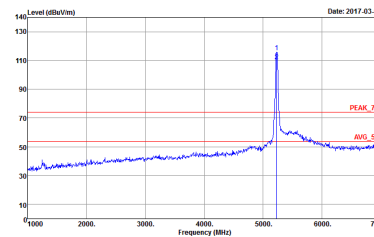
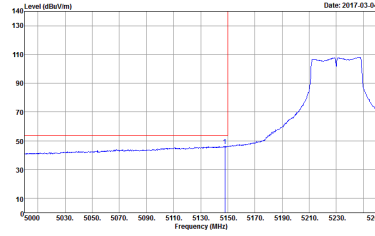

WIFI	Band 1 5150~5250MHz Band Edge @ 3m	
ANT	802.11ac VHT40 CH46 5230MHz - L	
1+2	Horizontal	Fundamental
Peak	 <p>Site : 03CHD-HY Condition : PEAK_BE_74 3m HORN 91200-HF HORIZONTAL : RBW:1000.000KHz VBW:3000.000KHz SWT:Auto Detector : Peak Project : 6N2223-01 Mode : 12</p>	 <p>Site : 03CHD-HY Condition : PEAK_74 3m HORN 91200-HF HORIZONTAL : RBW:1000.000KHz VBW:3000.000KHz SWT:Auto Detector : Peak Project : 6N2223-01 Mode : 12</p>
Avg.	 <p>Site : 03CHD-HY Condition : AVG_BE_54 3m HORN 91200-HF HORIZONTAL : RBW:1000.000KHz VBW:3000.000KHz SWT:Auto Detector : Peak Project : 6N2223-01 Mode : 12</p>	Left blank

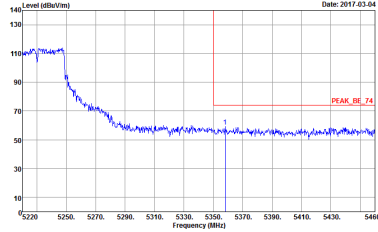
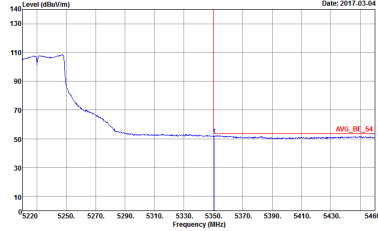

WIFI	Band 1 5150~5250MHz Band Edge @ 3m	
ANT	802.11ac VHT40 CH46 5230MHz - R	
1+2	Horizontal	Fundamental
<p>Peak</p>	 <p>Site : 03CH10-HY Condition : PEAK_BE_74 3m HORN 91200-HF HORIZONTAL Detector : Peak Project : 6N2223-01 Mode : 12</p>	<p>Left blank</p>
<p>Avg.</p>	 <p>Site : 03CH10-HY Condition : AVG_BE_54 3m HORN 91200-HF HORIZONTAL Detector : Peak Project : 6N2223-01 Mode : 12</p>	<p>Left blank</p>

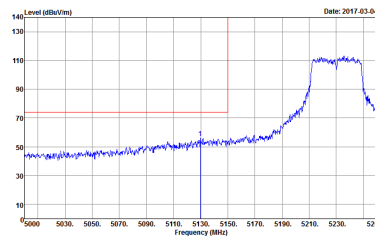
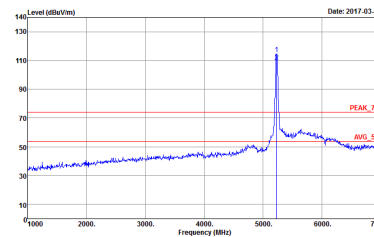
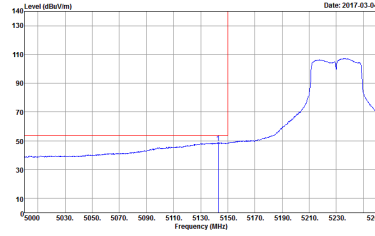

WIFI	Band 1 5150~5250MHz Band Edge @ 3m	
ANT	802.11ac VHT40 CH46 5230MHz - L	
1+2	Vertical	Fundamental
<p>Peak</p>	 <p>Site : 03CHD-HY Condition : PEAK_BE_74 3m HORN 91200-HF VERTICAL Detector : Peak Project : 6N2223-01 Mode : 12</p>	 <p>Site : 03CHD-HY Condition : PEAK_74 3m HORN 91200-HF VERTICAL Detector : Peak Project : 6N2223-01 Mode : 12</p>
<p>Avg.</p>	 <p>Site : 03CHD-HY Condition : AVG_BE_54 3m HORN 91200-HF VERTICAL Detector : Peak Project : 6N2223-01 Mode : 12</p>	<p>Left blank</p>

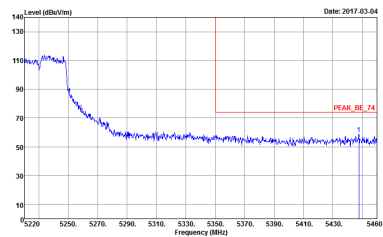
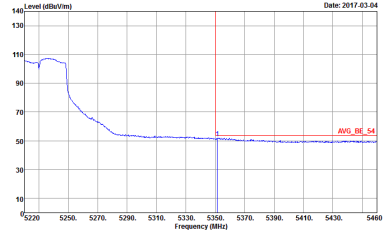

WIFI	Band 1 5150~5250MHz Band Edge @ 3m	
ANT	802.11ac VHT40 CH46 5230MHz - R	
1+2	Vertical	Fundamental
<p>Peak</p>	 <p>Site : 03CHD-HY Condition : PEAK_BE_74 3m HORN 91200-HF VERTICAL Detector : Peak Project : 6N2223-01 Mode : 12</p>	<p>Left blank</p>
<p>Avg.</p>	 <p>Site : 03CHD-HY Condition : AVG_BE_54 3m HORN 91200-HF VERTICAL Detector : Peak Project : 6N2223-01 Mode : 12</p>	<p>Left blank</p>



Band 1 5150~5250MHz

WIFI 802.11ac VHT50 (Band Edge @ 3m)

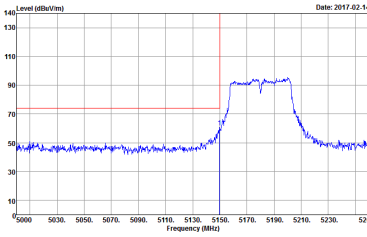
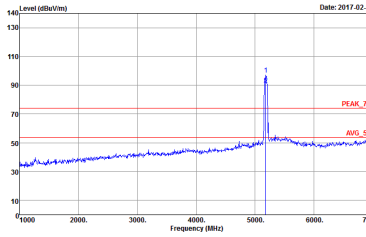
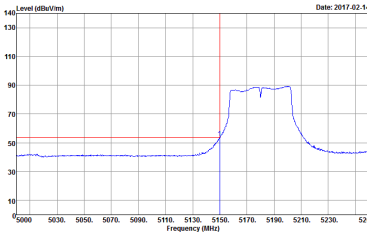
WIFI	Band 1 5150~5250MHz Band Edge @ 3m	
ANT	802.11ac VHT50 CH36 5180MHz - L	
1+2	Horizontal	Fundamental
<p>Peak</p>	 <p>Site : 03CHD-HY Condition : PEAK_BE_74 3m HORN 91200-HF HORIZONTAL Detector : Peak Project : 6N2223-01 Mode : 13</p>	 <p>Site : 03CHD-HY Condition : PEAK_74 3m HORN 91200-HF HORIZONTAL Detector : Peak Project : 6N2223-01 Mode : 13</p>
<p>Avg.</p>	 <p>Site : 03CHD-HY Condition : AVG_BE_54 3m HORN 91200-HF HORIZONTAL Detector : Peak Project : 6N2223-01 Mode : 13</p>	<p>Left blank</p>



WIFI	Band 1 5150~5250MHz Band Edge @ 3m	
ANT	802.11ac VHT50 CH36 5180MHz - R	
1+2	Horizontal	Fundamental
Peak	<p>Site : 03CH10-HY Condition : PEAK_BE_74 3m HORN 91200-HF HORIZONTAL Detector : Peak Project : 6N2223-01 Mode : 13</p>	Left blank
Avg.	<p>Site : 03CH10-HY Condition : AVG_BE_54 3m HORN 91200-HF HORIZONTAL Detector : Peak Project : 6N2223-01 Mode : 13</p>	Left blank

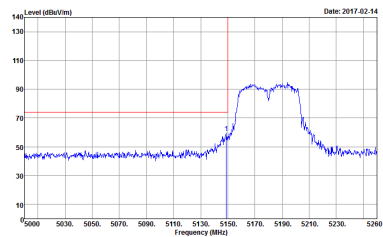
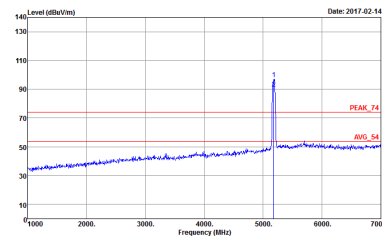
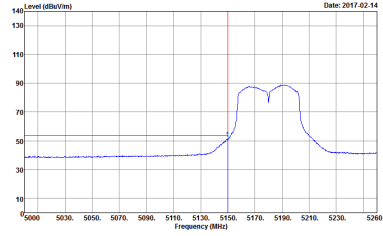

WIFI	Band 1 5150~5250MHz Band Edge @ 3m	
ANT	802.11ac VHT50 CH36 5180MHz - L	
1+2	Vertical	Fundamental
<p>Peak</p>	 <p>Site : 03CHD-HY Condition : PEAK_BE_74 3m HORN 91200-HF VERTICAL : RBW:1000.000KHz VBW:3000.000KHz SWT:Auto Detector : Peak Project : 6N2223-01 Mode : 13</p>	 <p>Site : 03CHD-HY Condition : PEAK_74 3m HORN 91200-HF VERTICAL : RBW:1000.000KHz VBW:3000.000KHz SWT:Auto Detector : Peak Project : 6N2223-01 Mode : 13</p>
<p>Avg.</p>	 <p>Site : 03CHD-HY Condition : AVG_BE_54 3m HORN 91200-HF VERTICAL : RBW:1000.000KHz VBW:3000KHz SWT:Auto Detector : Peak Project : 6N2223-01 Mode : 13</p>	<p>Left blank</p>



WIFI	Band 1 5150~5250MHz Band Edge @ 3m	
ANT	802.11ac VHT50 CH36 5180MHz - R	
1+2	Vertical	Fundamental
<p>Peak</p>	 <p>Site : 03CHD-HY Condition : PEAK_BE_74 3m HORN 91200-HF VERTICAL Detector : Peak Project : 6N2223-01 Mode : 13</p>	<p>Left blank</p>
<p>Avg.</p>	 <p>Site : 03CHD-HY Condition : AVG_BE_54 3m HORN 91200-HF VERTICAL Detector : Peak Project : 6N2223-01 Mode : 13</p>	<p>Left blank</p>



WIFI	Band 1 5150~5250MHz Band Edge @ 3m	
ANT	802.11ac VHT50 CH40 5200MHz - L	
1+2	Horizontal	Fundamental
<p>Peak</p>	<p>Site : 03CHD-HY Condition : PEAK_BE_74 3m HORN 91200-HF HORIZONTAL : RBW:1000.000KHz VBW:3000.000KHz SWT:Auto Detector : Peak Project : 6N2223-01 Mode : 14</p>	<p>Site : 03CHD-HY Condition : PEAK_74 3m HORN 91200-HF HORIZONTAL : RBW:1000.000KHz VBW:3000.000KHz SWT:Auto Detector : Peak Project : 6N2223-01 Mode : 14</p>
<p>Avg.</p>	<p>Site : 03CHD-HY Condition : AVG_BE_54 3m HORN 91200-HF HORIZONTAL : RBW:1000.000KHz VBW:3000.000KHz SWT:Auto Detector : Peak Project : 6N2223-01 Mode : 14</p>	<p>Left blank</p>

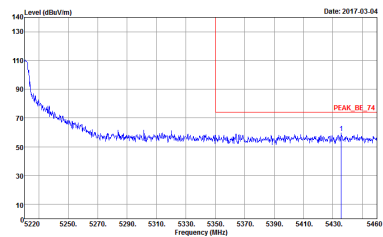
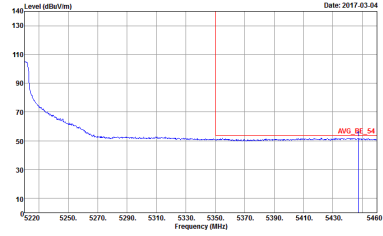

WIFI	Band 1 5150~5250MHz Band Edge @ 3m	
ANT	802.11ac VHT50 CH40 5200MHz - R	
1+2	Horizontal	Fundamental
<p>Peak</p>	 <p>Site : 03CH10-HY Condition : PEAK_BE_74 3m HORN 91200-HF HORIZONTAL Detector : Peak Project : 6N2223-01 Mode : 14</p>	<p>Left blank</p>
<p>Avg.</p>	 <p>Site : 03CH10-HY Condition : AVG_BE_54 3m HORN 91200-HF HORIZONTAL Detector : Peak Project : 6N2223-01 Mode : 14</p>	<p>Left blank</p>

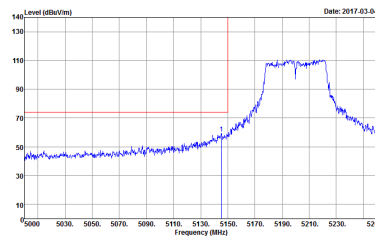
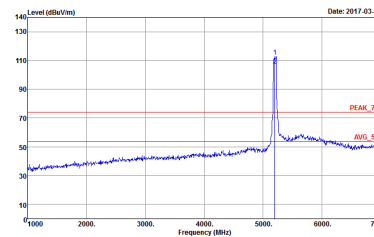
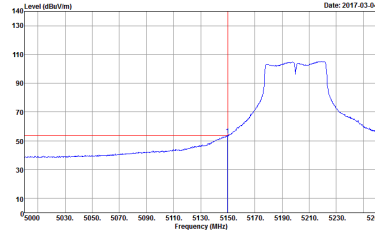

WIFI	Band 1 5150~5250MHz Band Edge @ 3m	
ANT	802.11ac VHT50 CH40 5200MHz - L	
1+2	Vertical	Fundamental
<p>Peak</p>	 <p>Site : 03CHD-HY Condition : PEAK_BE_74 3m HORN 9120D-HF VERTICAL Detector : Peak Project : 6N2223-01 Mode : 14</p>	 <p>Site : 03CHD-HY Condition : PEAK_74 3m HORN 9120D-HF VERTICAL Detector : Peak Project : 6N2223-01 Mode : 14</p>
<p>Avg.</p>	 <p>Site : 03CHD-HY Condition : AVG_BE_54 3m HORN 9120D-HF VERTICAL Detector : Peak Project : 6N2223-01 Mode : 14</p>	<p>Left blank</p>

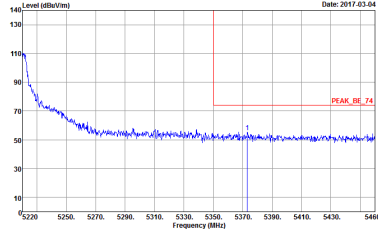
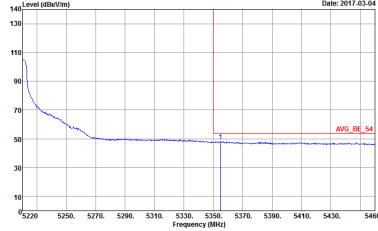

WIFI	Band 1 5150~5250MHz Band Edge @ 3m	
ANT	802.11ac VHT50 CH40 5200MHz - R	
1+2	Vertical	Fundamental
<p>Peak</p>	 <p>Site : 03CHD-HY Condition : PEAK_BE_74 3m HORN 91200-HF VERTICAL Detector : Peak Project : 6N2223-01 Mode : 14</p>	<p>Left blank</p>
<p>Avg.</p>	 <p>Site : 03CHD-HY Condition : AVG_BE_54 3m HORN 91200-HF VERTICAL Detector : Peak Project : 6N2223-01 Mode : 14</p>	<p>Left blank</p>

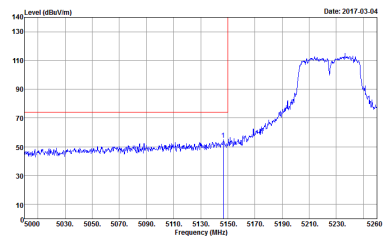
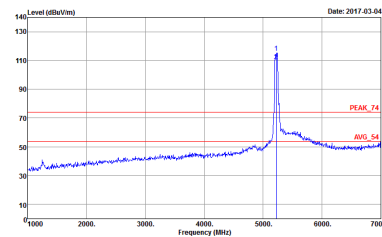
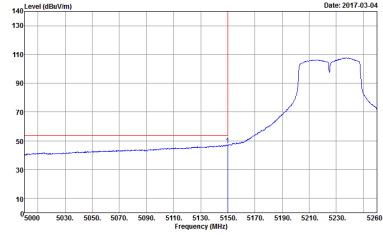

WIFI	Band 1 5150~5250MHz Band Edge @ 3m	
ANT	802.11ac VHT50 CH45 5225MHz - L	
1+2	Horizontal	Fundamental
<p>Peak</p>	 <p>Site : 03CHD-HY Condition : PEAK_BE_74 3m HORN 91200-HF HORIZONTAL Detector : Peak Project : 6N2223-01 Mode : 15</p>	 <p>Site : 03CHD-HY Condition : PEAK_74 3m HORN 91200-HF HORIZONTAL Detector : Peak Project : 6N2223-01 Mode : 15</p>
<p>Avg.</p>	 <p>Site : 03CHD-HY Condition : AVG_BE_54 3m HORN 91200-HF HORIZONTAL Detector : Peak Project : 6N2223-01 Mode : 15</p>	<p>Left blank</p>

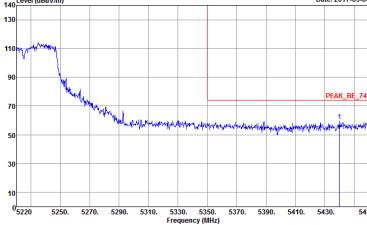
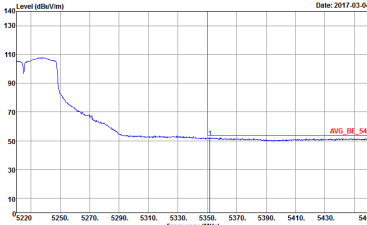

WIFI	Band 1 5150~5250MHz Band Edge @ 3m	
ANT	802.11ac VHT50 CH45 5225MHz - R	
1+2	Horizontal	Fundamental
<p>Peak</p>	 <p>Site : 03CH10-HY Condition : PEAK_BE_74 3m HORN 91200-HF HORIZONTAL Detector : Peak Project : 6N2223-01 Mode : IS</p>	<p>Left blank</p>
<p>Avg.</p>	 <p>Site : 03CH10-HY Condition : AVG_BE_54 3m HORN 91200-HF HORIZONTAL Detector : Peak Project : 6N2223-01 Mode : IS</p>	<p>Left blank</p>

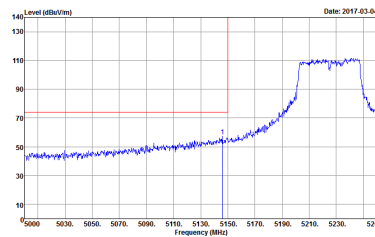
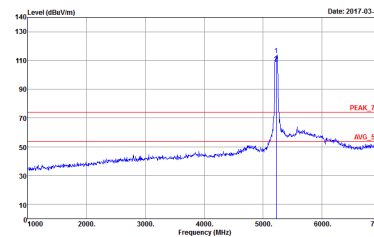
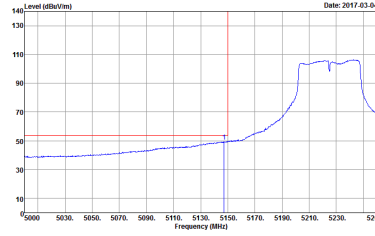

WIFI	Band 1 5150~5250MHz Band Edge @ 3m	
ANT	802.11ac VHT50 CH45 5225MHz - L	
1+2	Vertical	Fundamental
<p>Peak</p>	 <p>Site : 03CHD-HY Condition : PEAK_BE_74 3m HORN 91200-HF VERTICAL Detector : Peak Project : 6N2223-01 Mode : 15</p>	 <p>Site : 03CHD-HY Condition : PEAK_74 3m HORN 91200-HF VERTICAL Detector : Peak Project : 6N2223-01 Mode : 15</p>
<p>Avg.</p>	 <p>Site : 03CHD-HY Condition : AVG_BE_54 3m HORN 91200-HF VERTICAL Detector : Peak Project : 6N2223-01 Mode : 15</p>	<p>Left blank</p>

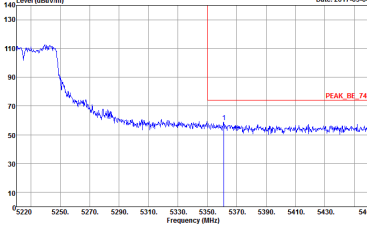
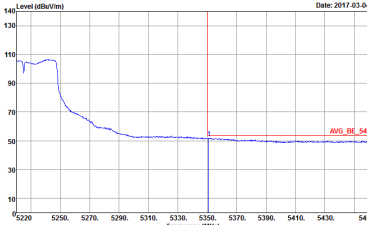

WIFI	Band 1 5150~5250MHz Band Edge @ 3m	
ANT	802.11ac VHT50 CH45 5225MHz - R	
1+2	Vertical	Fundamental
<p>Peak</p>	 <p>Site : 03CHD-HY Condition : PEAK_BE_74 3m HORN 91200-HF VERTICAL Detector : Peak Project : 6N2223-01 Mode : 15</p>	<p>Left blank</p>
<p>Avg.</p>	 <p>Site : 03CHD-HY Condition : AVG_BE_54 3m HORN 91200-HF VERTICAL Detector : Peak Project : 6N2223-01 Mode : 15</p>	<p>Left blank</p>

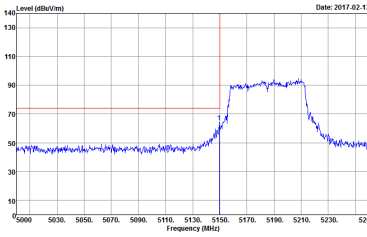
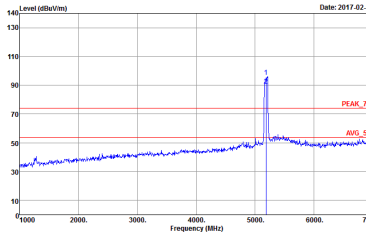
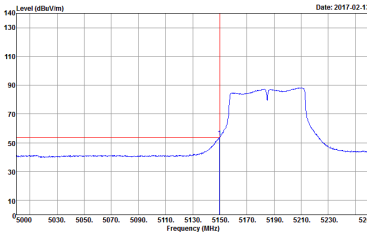

Band 1 5150~5250MHz
WIFI 802.11ac VHT60 (Band Edge @ 3m)

WIFI	Band 1 5150~5250MHz Band Edge @ 3m	
ANT	802.11ac VHT60 CH37 5185MHz - L	
1+2	Horizontal	Fundamental
<p align="center">Peak</p>	 <p>Site : 03CHD-HY Condition : PEAK_BE_74 3m HORN 91200-HF HORIZONTAL Detector : Peak Project : 6N2223-01 Mode : 16</p>	 <p>Site : 03CHD-HY Condition : PEAK_74 3m HORN 91200-HF HORIZONTAL Detector : Peak Project : 6N2223-01 Mode : 16</p>
<p align="center">Avg.</p>	 <p>Site : 03CHD-HY Condition : AVG_BE_54 3m HORN 91200-HF HORIZONTAL Detector : Peak Project : 6N2223-01 Mode : 16</p>	<p align="center">Left blank</p>

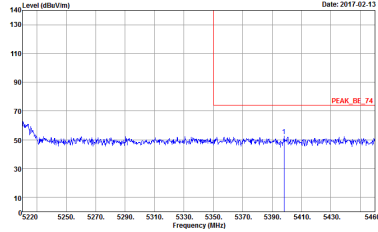
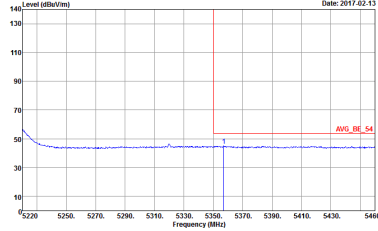

WIFI	Band 1 5150~5250MHz Band Edge @ 3m	
ANT	802.11ac VHT60 CH37 5185MHz - R	
1+2	Horizontal	Fundamental
<p>Peak</p>	 <p>Site : 03CH10-HY Condition : PEAK_BE_74 3m HORN 91200-HF HORIZONTAL Detector : Peak Project : 6N2223-01 Mode : 16</p>	<p>Left blank</p>
<p>Avg.</p>	 <p>Site : 03CH10-HY Condition : AVG_BE_54 3m HORN 91200-HF HORIZONTAL Detector : Peak Project : 6N2223-01 Mode : 16</p>	<p>Left blank</p>

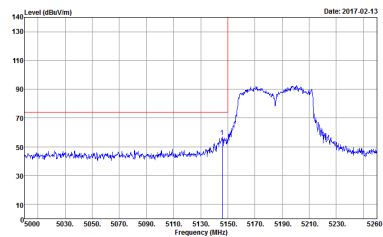
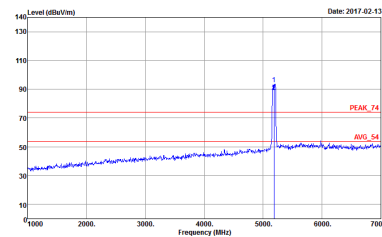
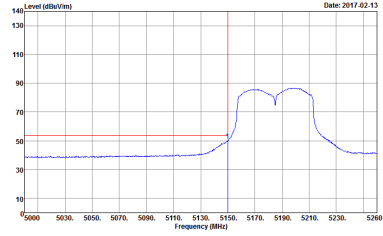

WIFI	Band 1 5150~5250MHz Band Edge @ 3m	
ANT	802.11ac VHT60 CH37 5185MHz - L	
1+2	Vertical	Fundamental
<p>Peak</p>	 <p>Site : 03CHD-HY Condition : PEAK_BE_74 3m HORN 91200-HF VERTICAL Detector : Peak Project : 6N2223-01 Mode : 16</p>	 <p>Site : 03CHD-HY Condition : PEAK_74 3m HORN 91200-HF VERTICAL Detector : Peak Project : 6N2223-01 Mode : 16</p>
<p>Avg.</p>	 <p>Site : 03CHD-HY Condition : AVG_BE_54 3m HORN 91200-HF VERTICAL Detector : Peak Project : 6N2223-01 Mode : 16</p>	<p>Left blank</p>

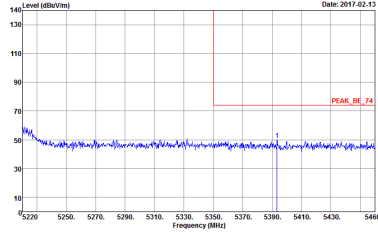
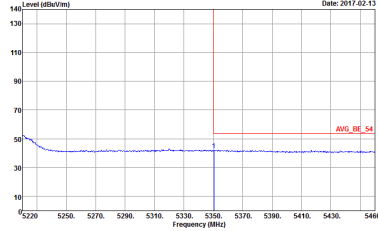

WIFI	Band 1 5150~5250MHz Band Edge @ 3m	
ANT	802.11ac VHT60 CH37 5185MHz - R	
1+2	Vertical	Fundamental
<p>Peak</p>	 <p>Site : 03CHD-HY Condition : PEAK_BE_74 3m HORN 91200-HF VERTICAL Detector : Peak Project : 6N2223-01 Mode : 16</p>	<p>Left blank</p>
<p>Avg.</p>	 <p>Site : 03CHD-HY Condition : AVG_BE_54 3m HORN 91200-HF VERTICAL Detector : Peak Project : 6N2223-01 Mode : 16</p>	<p>Left blank</p>

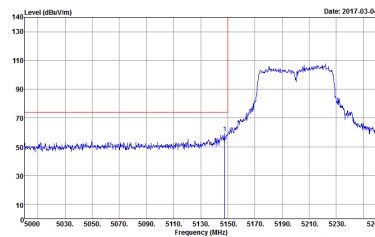
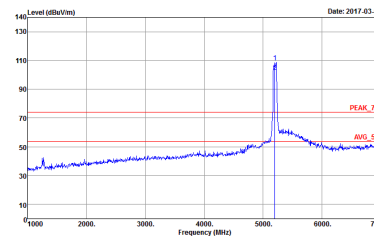
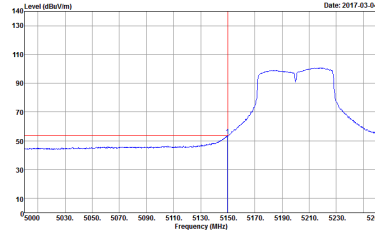

WIFI	Band 1 5150~5250MHz Band Edge @ 3m	
ANT	802.11ac VHT60 CH40 5200MHz - L	
1+2	Horizontal	Fundamental
<p>Peak</p>	 <p>Site : 03CHD-HY Condition : PEAK_BE_74 3m HORN 91200-HF HORIZONTAL Detector : Peak Project : 6N2223-01 Mode : 17</p>	 <p>Site : 03CHD-HY Condition : PEAK_74 3m HORN 91200-HF HORIZONTAL Detector : Peak Project : 6N2223-01 Mode : 17</p>
<p>Avg.</p>	 <p>Site : 03CHD-HY Condition : AVG_BE_54 3m HORN 91200-HF HORIZONTAL Detector : Peak Project : 6N2223-01 Mode : 17</p>	<p>Left blank</p>

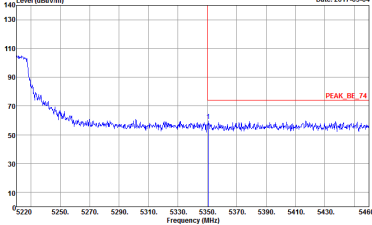
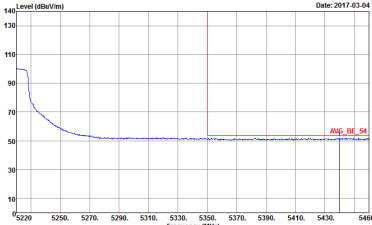

WIFI	Band 1 5150~5250MHz Band Edge @ 3m	
ANT	802.11ac VHT60 CH40 5200MHz - R	
1+2	Horizontal	Fundamental
<p>Peak</p>	 <p>Site : 03CH10-HY Condition : PEAK_BE_74 3m HORN 91200-HF HORIZONTAL Detector : Peak Project : 6N2223-01 Mode : 17</p>	<p>Left blank</p>
<p>Avg.</p>	 <p>Site : 03CH10-HY Condition : AVG_BE_54 3m HORN 91200-HF HORIZONTAL Detector : Peak Project : 6N2223-01 Mode : 17</p>	<p>Left blank</p>



WIFI	Band 1 5150~5250MHz Band Edge @ 3m	
ANT	802.11ac VHT60 CH40 5200MHz - L	
1+2	Vertical	Fundamental
<p>Peak</p>	<p>Site : 03CHD-HY Condition : PEAK_BE_74 3m HORN 91200-HF VERTICAL Detector : Peak Project : 6N2223-01 Mode : 17</p>	<p>Site : 03CHD-HY Condition : PEAK_74 3m HORN 91200-HF VERTICAL Detector : Peak Project : 6N2223-01 Mode : 17</p>
<p>Avg.</p>	<p>Site : 03CHD-HY Condition : AVG_BE_54 3m HORN 91200-HF VERTICAL Detector : Peak Project : 6N2223-01 Mode : 17</p>	<p>Left blank</p>

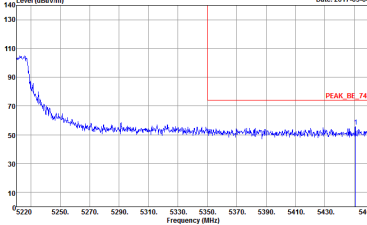
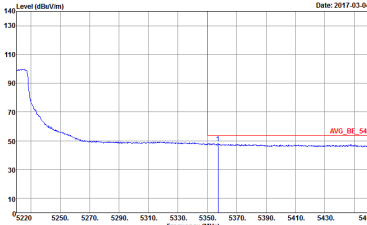

WIFI	Band 1 5150~5250MHz Band Edge @ 3m	
ANT	802.11ac VHT60 CH40 5200MHz - R	
1+2	Vertical	Fundamental
<p>Peak</p>	 <p>Site : 03CHD-HY Condition : PEAK_BE_74 3m HORN 91200-HF VERTICAL Detector : Peak Project : 6N2223-01 Mode : 17</p>	<p>Left blank</p>
<p>Avg.</p>	 <p>Site : 03CHD-HY Condition : AVG_BE_54 3m HORN 91200-HF VERTICAL Detector : Peak Project : 6N2223-01 Mode : 17</p>	<p>Left blank</p>



WIFI	Band 1 5150~5250MHz Band Edge @ 3m	
ANT	802.11ac VHT60 CH44 5220MHz - L	
1+2	Horizontal	Fundamental
<p>Peak</p>	<p>Site : 03CHD-HY Condition : PEAK_BE_74 3m HORN 91200-HF HORIZONTAL Detector : Peak Project : 6N2223-01 Mode : 1B</p>	<p>Site : 03CHD-HY Condition : PEAK_74 3m HORN 91200-HF HORIZONTAL Detector : Peak Project : 6N2223-01 Mode : 1B</p>
<p>Avg.</p>	<p>Site : 03CHD-HY Condition : AVG_BE_54 3m HORN 91200-HF HORIZONTAL Detector : Peak Project : 6N2223-01 Mode : 1B</p>	<p>Left blank</p>

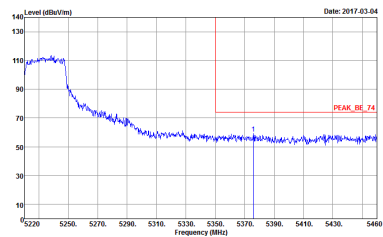
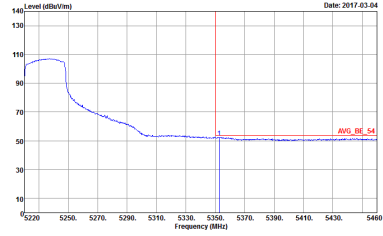

WIFI	Band 1 5150~5250MHz Band Edge @ 3m	
ANT	802.11ac VHT60 CH44 5220MHz - R	
1+2	Horizontal	Fundamental
<p>Peak</p>	 <p>Site : 03CH10-HY Condition : PEAK_BE_74 3m HORN 91200-HF HORIZONTAL Detector : Peak Project : 6N2223-01 Mode : 1B</p>	<p>Left blank</p>
<p>Avg.</p>	 <p>Site : 03CH10-HY Condition : AVG_BE_54 3m HORN 91200-HF HORIZONTAL Detector : Peak Project : 6N2223-01 Mode : 1B</p>	<p>Left blank</p>

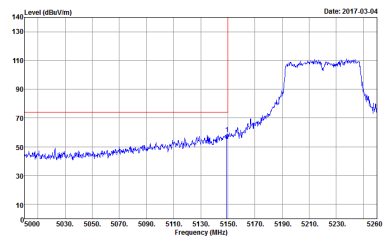
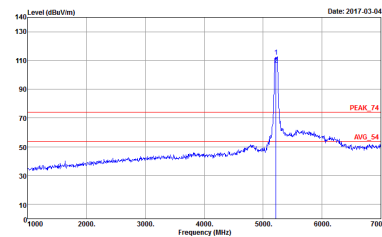
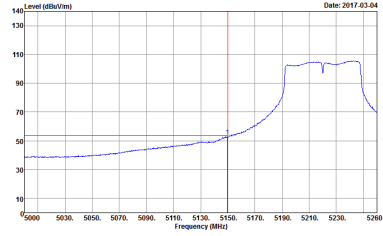

WIFI	Band 1 5150~5250MHz Band Edge @ 3m	
ANT	802.11ac VHT60 CH44 5220MHz - L	
1+2	Vertical	Fundamental
<p>Peak</p>	 <p>Site : 03CHD-HY Condition : PEAK_BE_74 3m HORN 91200-HF VERTICAL Detector : Peak Project : 6N2223-01 Mode : 1B</p>	 <p>Site : 03CHD-HY Condition : PEAK_74 3m HORN 91200-HF VERTICAL Detector : Peak Project : 6N2223-01 Mode : 1B</p>
<p>Avg.</p>	 <p>Site : 03CHD-HY Condition : AVG_BE_54 3m HORN 91200-HF VERTICAL Detector : Peak Project : 6N2223-01 Mode : 1B</p>	<p>Left blank</p>

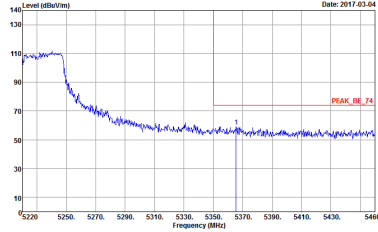
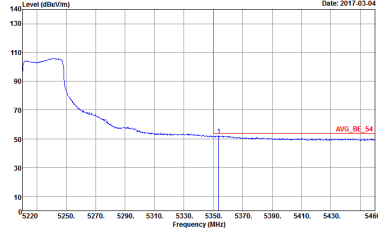

WIFI	Band 1 5150~5250MHz Band Edge @ 3m	
ANT	802.11ac VHT60 CH44 5220MHz - R	
1+2	Vertical	Fundamental
<p>Peak</p>	 <p>Site : 03CHD-HY Condition : PEAK_BE_74 3m HORN 91200-HF VERTICAL Detector : Peak Project : 6N2223-01 Mode : 1B</p>	<p>Left blank</p>
<p>Avg.</p>	 <p>Site : 03CHD-HY Condition : AVG_BE_54 3m HORN 91200-HF VERTICAL Detector : Peak Project : 6N2223-01 Mode : 1B</p>	<p>Left blank</p>



Band 1 5150~5250MHz

WIFI 802.11ac VHT80 (Band Edge @ 3m)

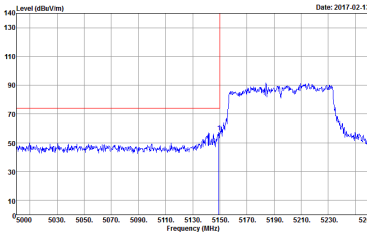
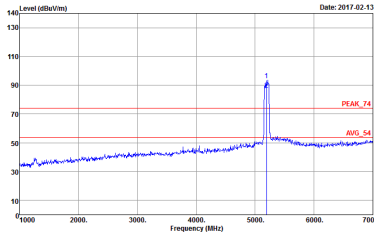
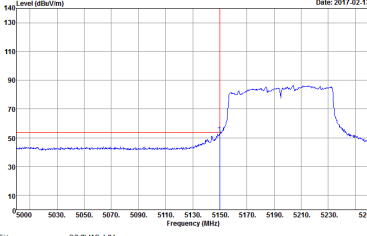
WIFI	Band 1 5150~5250MHz Band Edge @ 3m	
ANT	802.11ac VHT80 CH39 5195MHz - L	
1+2	Horizontal	Fundamental
<p>Peak</p>	 <p>Site : 03CHD-HY Condition : PEAK_BE_74 3m HORN 91200-HF HORIZONTAL : RBW:1000.000kHz VBW:3000.000kHz SWT:Auto Detector : Peak Project : 6N2223-01 Mode : 19</p>	 <p>Site : 03CHD-HY Condition : PEAK_74 3m HORN 91200-HF HORIZONTAL : RBW:1000.000kHz VBW:3000.000kHz SWT:Auto Detector : Peak Project : 6N2223-01 Mode : 19</p>
<p>Avg.</p>	 <p>Site : 03CHD-HY Condition : AVG_BE_54 3m HORN 91200-HF HORIZONTAL : RBW:1000.000kHz VBW:10.000kHz SWT:Auto Detector : Peak Project : 6N2223-01 Mode : 19</p>	<p>Left blank</p>

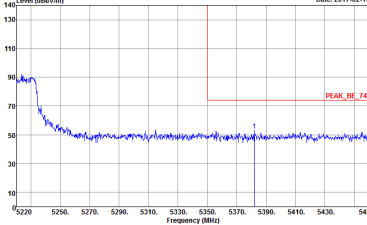
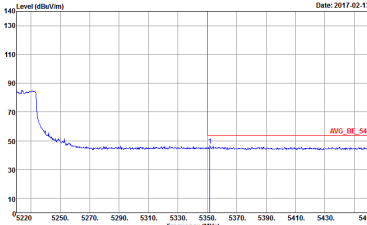

WIFI	Band 1 5150~5250MHz Band Edge @ 3m	
ANT	802.11ac VHT80 CH39 5195MHz - R	
1+2	Horizontal	Fundamental
<p>Peak</p>	 <p>Site : 03CH10-HY Condition : PEAK_BE_74 3m HORN 91200-HF HORIZONTAL Detector : Peak Project : 6N2223-01 Mode : 19</p>	<p>Left blank</p>
<p>Avg.</p>	 <p>Site : 03CH10-HY Condition : AVG_BE_54 3m HORN 91200-HF HORIZONTAL Detector : Peak Project : 6N2223-01 Mode : 19</p>	<p>Left blank</p>

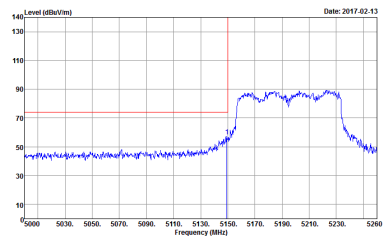
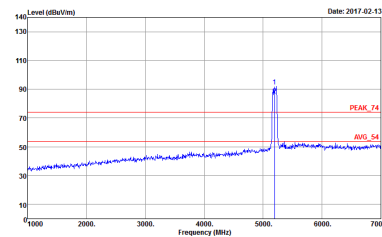
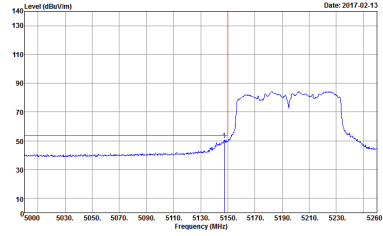

WIFI	Band 1 5150~5250MHz Band Edge @ 3m	
ANT	802.11ac VHT80 CH39 5195MHz - L	
1+2	Vertical	Fundamental
<p>Peak</p>	 <p>Site : 03CHD-HY Condition : PEAK_BE_74 3m HORN 9120D-HF VERTICAL Detector : Peak Project : 6N2223-01 Mode : 19</p>	 <p>Site : 03CHD-HY Condition : PEAK_74 3m HORN 9120D-HF VERTICAL Detector : Peak Project : 6N2223-01 Mode : 19</p>
<p>Avg.</p>	 <p>Site : 03CHD-HY Condition : AVG_BE_54 3m HORN 9120D-HF VERTICAL Detector : Peak Project : 6N2223-01 Mode : 19</p>	<p>Left blank</p>

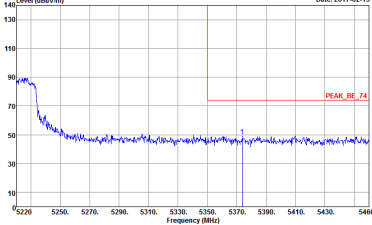
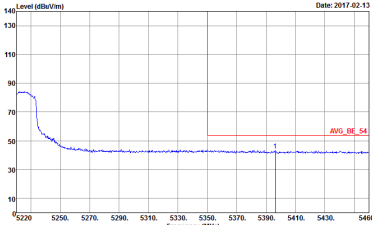

WIFI	Band 1 5150~5250MHz Band Edge @ 3m	
ANT	802.11ac VHT80 CH39 5195MHz - R	
1+2	Vertical	Fundamental
<p>Peak</p>	 <p>Site : 03CHD-HY Condition : PEAK_BE_74 3m HORN 91200-HF VERTICAL Detector : Peak Project : 6N2223-01 Mode : 19</p>	<p>Left blank</p>
<p>Avg.</p>	 <p>Site : 03CHD-HY Condition : AVG_BE_54 3m HORN 91200-HF VERTICAL Detector : Peak Project : 6N2223-01 Mode : 19</p>	<p>Left blank</p>

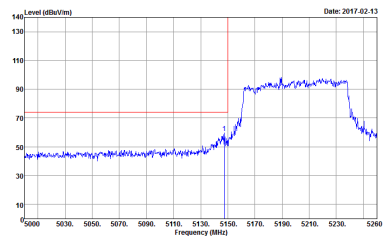
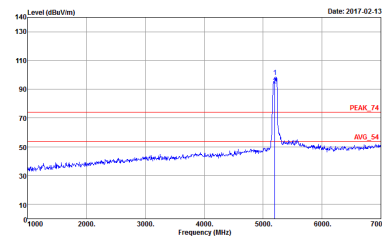
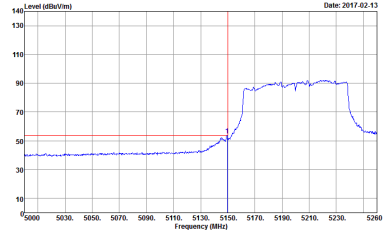

WIFI	Band 1 5150~5250MHz Band Edge @ 3m	
ANT	802.11ac VHT80 CH40 5200MHz - L	
1+2	Horizontal	Fundamental
<p>Peak</p>	 <p>Site : 03CHD-HY Condition : PEAK_BE_74 3m HORN 9120D-HF HORIZONTAL Detector : Peak Project : 6N2223-01 Mode : Z0</p>	 <p>Site : 03CHD-HY Condition : PEAK_74 3m HORN 9120D-HF HORIZONTAL Detector : Peak Project : 6N2223-01 Mode : Z0</p>
<p>Avg.</p>	 <p>Site : 03CHD-HY Condition : AVG_BE_54 3m HORN 9120D-HF HORIZONTAL Detector : Peak Project : 6N2223-01 Mode : Z0</p>	<p>Left blank</p>

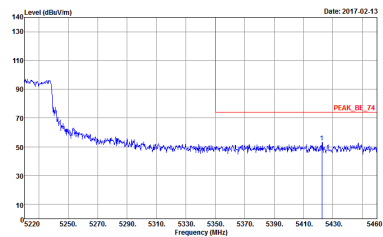
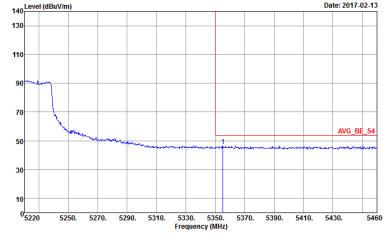

WIFI	Band 1 5150~5250MHz Band Edge @ 3m	
ANT	802.11ac VHT80 CH40 5200MHz - R	
1+2	Horizontal	Fundamental
<p>Peak</p>	 <p>Site : 03CH10-HY Condition : PEAK_BE_74 3m HORN 91200-HF HORIZONTAL Detector : Peak Project : 6N2223-01 Mode : Z0</p>	<p>Left blank</p>
<p>Avg.</p>	 <p>Site : 03CH10-HY Condition : AVG_BE_54 3m HORN 91200-HF HORIZONTAL Detector : Peak Project : 6N2223-01 Mode : Z0</p>	<p>Left blank</p>

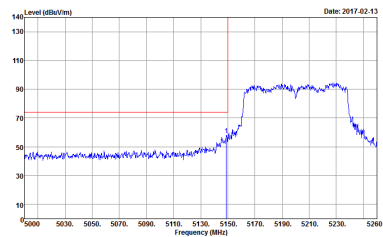
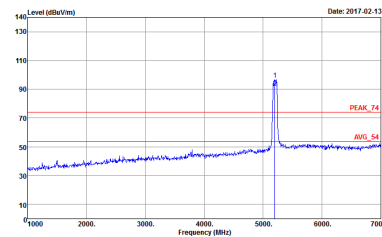
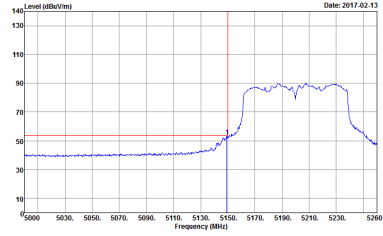

WIFI	Band 1 5150~5250MHz Band Edge @ 3m	
ANT	802.11ac VHT80 CH40 5200MHz - L	
1+2	Vertical	Fundamental
<p>Peak</p>	 <p>Site : 03CHD-HY Condition : PEAK_BE_74 3m HORN 91200-HF VERTICAL Detector : Peak Project : 6N2223-01 Mode : Z0</p>	 <p>Site : 03CHD-HY Condition : PEAK_74 3m HORN 91200-HF VERTICAL Detector : Peak Project : 6N2223-01 Mode : Z0</p>
<p>Avg.</p>	 <p>Site : 03CHD-HY Condition : AVG_BE_54 3m HORN 91200-HF VERTICAL Detector : Peak Project : 6N2223-01 Mode : Z0</p>	<p>Left blank</p>

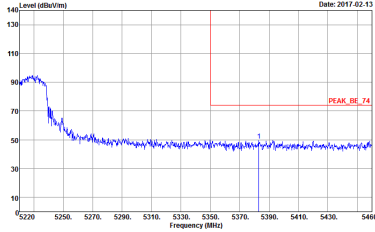
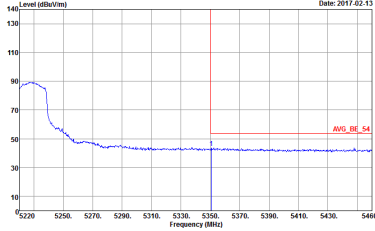

WIFI	Band 1 5150~5250MHz Band Edge @ 3m	
ANT	802.11ac VHT80 CH40 5200MHz - R	
1+2	Vertical	Fundamental
<p>Peak</p>	 <p>Site : 03CHD-HY Condition : PEAK_BE_74 3m HORN 91200-HF VERTICAL Detector : Peak Project : 6N2223-01 Mode : Z0</p>	<p>Left blank</p>
<p>Avg.</p>	 <p>Site : 03CHD-HY Condition : AVG_BE_54 3m HORN 91200-HF VERTICAL Detector : Peak Project : 6N2223-01 Mode : Z0</p>	<p>Left blank</p>

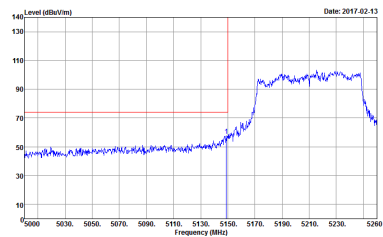
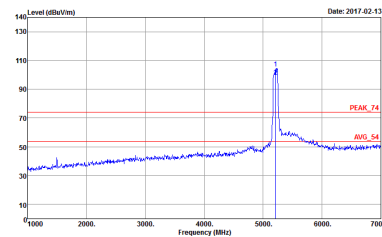
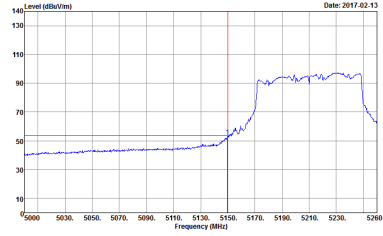

WIFI	Band 1 5150~5250MHz Band Edge @ 3m	
ANT	802.11ac VHT80 CH42 5210MHz - L	
1+2	Horizontal	Fundamental
<p>Peak</p>	 <p>Site : 03CHD-HY Condition : PEAK_BE_74 3m HORN 9120D-HF HORIZONTAL Detector : Peak Project : 6N2223-01 Mode : Z1</p>	 <p>Site : 03CHD-HY Condition : PEAK_74 3m HORN 9120D-HF HORIZONTAL Detector : Peak Project : 6N2223-01 Mode : Z1</p>
<p>Avg.</p>	 <p>Site : 03CHD-HY Condition : AVG_BE_54 3m HORN 9120D-HF HORIZONTAL Detector : Peak Project : 6N2223-01 Mode : Z1</p>	<p>Left blank</p>

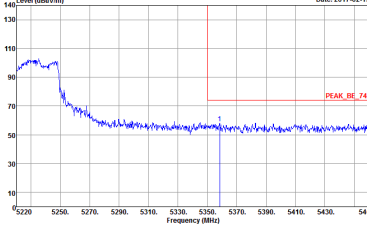
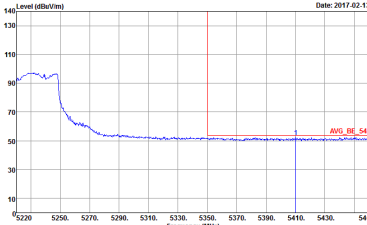

WIFI	Band 1 5150~5250MHz Band Edge @ 3m	
ANT	802.11ac VHT80 CH42 5210MHz - R	
1+2	Horizontal	Fundamental
<p>Peak</p>	 <p>Site : 03CH10-HY Condition : PEAK_BE_74 3m HORN 91200-HF HORIZONTAL Detector : Peak Project : 6N2223-01 Mode : Z1</p>	<p>Left blank</p>
<p>Avg.</p>	 <p>Site : 03CH10-HY Condition : AVG_BE_54 3m HORN 91200-HF HORIZONTAL Detector : Peak Project : 6N2223-01 Mode : Z1</p>	<p>Left blank</p>



WIFI	Band 1 5150~5250MHz Band Edge @ 3m	
ANT	802.11ac VHT80 CH42 5210MHz - L	
1+2	Vertical	Fundamental
<p>Peak</p>	<p>Site : 03CHD-HY Condition : PEAK_BE_74 3m HORN 9120D-HF VERTICAL Detector : Peak Project : 6N2223-01 Mode : Z1</p>	<p>Site : 03CHD-HY Condition : PEAK_74 3m HORN 9120D-HF VERTICAL Detector : Peak Project : 6N2223-01 Mode : Z1</p>
<p>Avg.</p>	<p>Site : 03CHD-HY Condition : AVG_BE_54 3m HORN 9120D-HF VERTICAL Detector : Peak Project : 6N2223-01 Mode : Z1</p>	<p>Left blank</p>

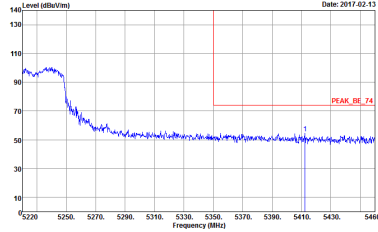
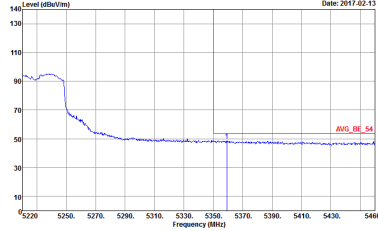

WIFI	Band 1 5150~5250MHz Band Edge @ 3m	
ANT	802.11ac VHT80 CH42 5210MHz - R	
1+2	Vertical	Fundamental
<p>Peak</p>	 <p>Site : 03CHD-HY Condition : PEAK_BE_74 3m HORN 91200-HF VERTICAL Detector : Peak Project : 6N2223-01 Mode : Z1</p>	<p>Left blank</p>
<p>Avg.</p>	 <p>Site : 03CHD-HY Condition : AVG_BE_54 3m HORN 91200-HF VERTICAL Detector : Peak Project : 6N2223-01 Mode : Z1</p>	<p>Left blank</p>



Band 1 - 5150~5250MHz
WIFI 802.11ac VHT10 (Harmonic @ 3m)

WIFI	Band 1 5150~5250MHz Harmonic @ 3m	
ANT	802.11ac VHT10 CH32 5160MHz	
1+2	Horizontal	Vertical
Peak Avg.	<p>Site : 03CH10-11Y Condition : PEAK_74 3m HORN 91200-HF HORIZONTAL Detector : Peak Project : 6N2223-01 Mode : 1</p>	<p>Site : 03CH10-11Y Condition : PEAK_74 3m HORN 91200-HF VERTICAL Detector : Peak Project : 6N2223-01 Mode : 1</p>

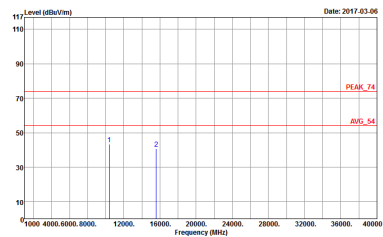
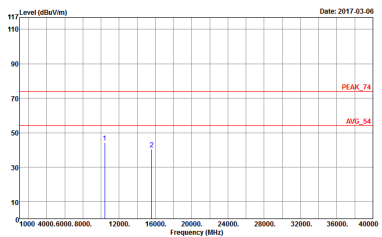

WIFI	Band 1 5150~5250MHz Harmonic @ 3m	
ANT	802.11ac VHT10 CH40 5200MHz	
1+2	Horizontal	Vertical
<p>Peak</p> <p>Avg.</p>	 <p>Site : 03CH10-11Y Condition : PEAK_74 3m HORN 91200-HF HORIZONTAL Detector : Peak Project : 6N2223-01 Mode : Z</p>	 <p>Site : 03CH10-11Y Condition : PEAK_74 3m HORN 91200-HF VERTICAL Detector : Peak Project : 6N2223-01 Mode : Z</p>

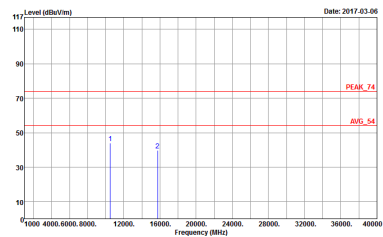
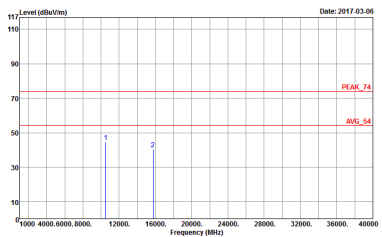

WIFI	Band 1 5150~5250MHz Harmonic @ 3m	
ANT	802.11ac VHT10 CH49 5245MHz	
1+2	Horizontal	Vertical
<p>Peak</p> <p>Avg.</p>	 <p>Site : 03CH10-11Y Condition : PEAK_74 3m HORN 91200-HF HORIZONTAL Detector : Peak Project : 6N2223-01 Mode : 3</p>	 <p>Site : 03CH10-11Y Condition : PEAK_74 3m HORN 91200-HF VERTICAL Detector : Peak Project : 6N2223-01 Mode : 3</p>



Band 1 5150~5250MHz
WIFI 802.11ac VHT20 (Harmonic @ 3m)

WIFI	Band 1 5150~5250MHz Harmonic @ 3m	
ANT	802.11ac VHT20 CH33 5165MHz	
1+2	Horizontal	Vertical
Peak Avg.	<p>Site : 03CH10-11Y Condition : PEAK_74 3m HORN 91200-HF HORIZONTAL Detector : Peak Project : 6N2223-01 Mode : -4</p>	<p>Site : 03CH10-11Y Condition : PEAK_74 3m HORN 91200-HF VERTICAL Detector : Peak Project : 6N2223-01 Mode : -4</p>

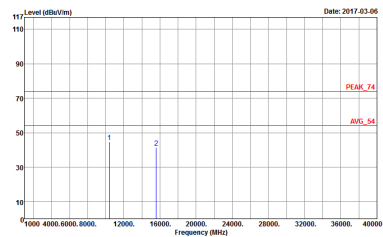
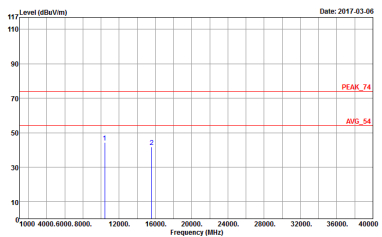

WIFI	Band 1 5150~5250MHz Harmonic @ 3m	
ANT	802.11ac VHT20 CH40 5200MHz	
1+2	Horizontal	Vertical
<p>Peak</p> <p>Avg.</p>	 <p>Site : 03CH10-11Y Condition : PEAK_74 3m HORN 91200-HF HORIZONTAL Detector : Peak Project : 6N2223-01 Mode : -5</p>	 <p>Site : 03CH10-11Y Condition : PEAK_74 3m HORN 91200-HF VERTICAL Detector : Peak Project : 6N2223-01 Mode : -5</p>

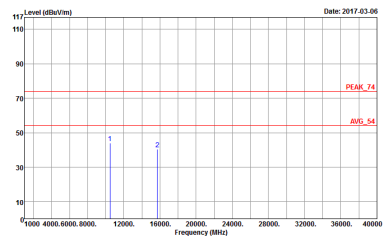
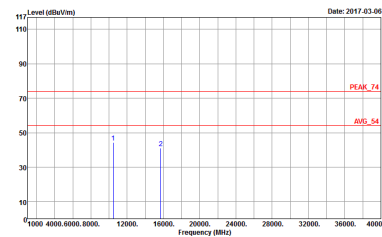

WIFI	Band 1 5150~5250MHz Harmonic @ 3m	
ANT	802.11ac VHT20 CH48 5240MHz	
1+2	Horizontal	Vertical
<p>Peak</p> <p>Avg.</p>	 <p>Site : 03CH10-11Y Condition : PEAK_74 3m HORN 91200-HF HORIZONTAL Detector : Peak Project : 6N2223-01 Mode : 6</p>	 <p>Site : 03CH10-11Y Condition : PEAK_74 3m HORN 91200-HF VERTICAL Detector : Peak Project : 6N2223-01 Mode : 6</p>



Band 1 5150~5250MHz

WIFI 802.11ac VHT30 (Harmonic @ 3m)

WIFI	Band 1 5150~5250MHz Harmonic @ 3m	
ANT	802.11ac VHT30 CH34 5170MHz	
1+2	Horizontal	Vertical
Peak	<p>Site : 03CH10-11Y Condition : PEAK_74 3m HORN 91200-HF HORIZONTAL Detector : Peak Project : 6N2223-01 Mode : 7</p>	<p>Site : 03CH10-11Y Condition : PEAK_74 3m HORN 91200-HF VERTICAL Detector : Peak Project : 6N2223-01 Mode : 7</p>
Avg.		

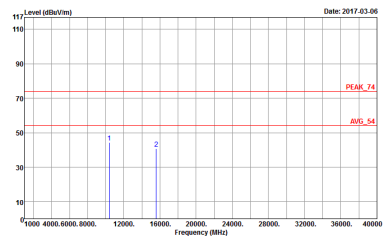
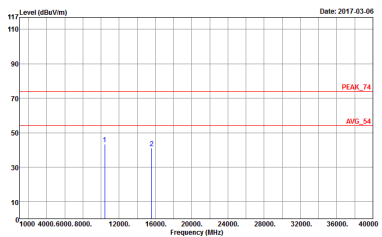

WIFI	Band 1 5150~5250MHz Harmonic @ 3m	
ANT	802.11ac VHT30 CH40 5200MHz	
1+2	Horizontal	Vertical
<p>Peak</p> <p>Avg.</p>	 <p>Site : 03CH10-11Y Condition : PEAK_74 3m HORN 91200-HF HORIZONTAL Detector : Peak Project : 6N2223-01 Mode : S</p>	 <p>Site : 03CH10-11Y Condition : PEAK_74 3m HORN 91200-HF VERTICAL Detector : Peak Project : 6N2223-01 Mode : S</p>

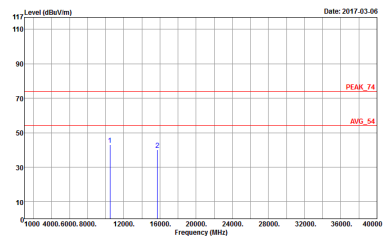
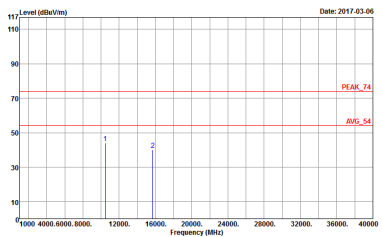

WIFI	Band 1 5150~5250MHz Harmonic @ 3m																					
ANT	802.11ac VHT30 CH47 5235MHz																					
1+2	Horizontal	Vertical																				
<p>Peak</p> <p>Avg.</p>	 <table border="1" data-bbox="430 728 686 795"> <tr><td>Site</td><td>: 03CH10-11Y</td></tr> <tr><td>Condition</td><td>: PEAK_74 3m HORN 91200-HF HORIZONTAL</td></tr> <tr><td>Detector</td><td>: Peak</td></tr> <tr><td>Project</td><td>: 6N2223-01</td></tr> <tr><td>Mode</td><td>: 9</td></tr> </table>	Site	: 03CH10-11Y	Condition	: PEAK_74 3m HORN 91200-HF HORIZONTAL	Detector	: Peak	Project	: 6N2223-01	Mode	: 9	 <table border="1" data-bbox="909 728 1165 795"> <tr><td>Site</td><td>: 03CH10-11Y</td></tr> <tr><td>Condition</td><td>: PEAK_74 3m HORN 91200-HF VERTICAL</td></tr> <tr><td>Detector</td><td>: Peak</td></tr> <tr><td>Project</td><td>: 6N2223-01</td></tr> <tr><td>Mode</td><td>: 9</td></tr> </table>	Site	: 03CH10-11Y	Condition	: PEAK_74 3m HORN 91200-HF VERTICAL	Detector	: Peak	Project	: 6N2223-01	Mode	: 9
Site	: 03CH10-11Y																					
Condition	: PEAK_74 3m HORN 91200-HF HORIZONTAL																					
Detector	: Peak																					
Project	: 6N2223-01																					
Mode	: 9																					
Site	: 03CH10-11Y																					
Condition	: PEAK_74 3m HORN 91200-HF VERTICAL																					
Detector	: Peak																					
Project	: 6N2223-01																					
Mode	: 9																					



Band 1 5150~5250MHz
WIFI 802.11ac VHT40 (Harmonic @ 3m)

WIFI	Band 1 5150~5250MHz Harmonic @ 3m	
ANT	802.11ac VHT40 CH35 5175MHz	
1+2	Horizontal	Vertical
Peak Avg.	<p>Site : 03CH10-11Y Condition : PEAK_74 3m HORN 91200-HF HORIZONTAL Detector : Peak Project : 6N2223-01 Mode : 10</p>	<p>Site : 03CH10-11Y Condition : PEAK_74 3m HORN 91200-HF VERTICAL Detector : Peak Project : 6N2223-01 Mode : 10</p>

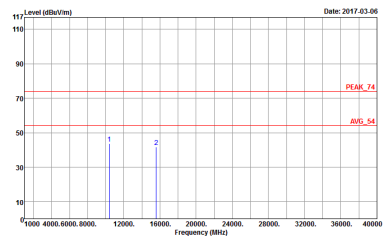
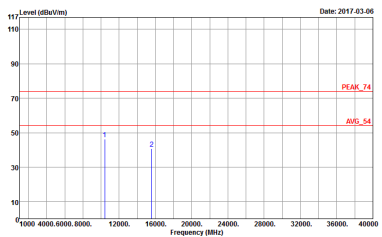

WIFI	Band 1 5150~5250MHz Harmonic @ 3m	
ANT	802.11ac VHT40 CH40 5200MHz	
1+2	Horizontal	Vertical
<p>Peak</p> <p>Avg.</p>	 <p>Site : 03CH10-11Y Condition : PEAK_74 3m HORN 91200-HF HORIZONTAL Detector : Peak Project : 6N2223-01 Mode : 11</p>	 <p>Site : 03CH10-11Y Condition : PEAK_74 3m HORN 91200-HF VERTICAL Detector : Peak Project : 6N2223-01 Mode : 11</p>



WIFI	Band 1 5150~5250MHz Harmonic @ 3m	
ANT	802.11ac VHT40 CH46 5230MHz	
1+2	Horizontal	Vertical
<p>Peak</p> <p>Avg.</p>	<p>Site : 03CH10-11Y Condition : PEAK_74 3m HORN 91200-HF HORIZONTAL Detector : Peak Project : 6N2223-01 Mode : 12</p>	<p>Site : 03CH10-11Y Condition : PEAK_74 3m HORN 91200-HF VERTICAL Detector : Peak Project : 6N2223-01 Mode : 12</p>



Band 1 5150~5250MHz
WIFI 802.11ac VHT50 (Harmonic @ 3m)

WIFI	Band 1 5150~5250MHz Harmonic @ 3m	
ANT	802.11ac VHT50 CH36 5180MHz	
1+2	Horizontal	Vertical
Peak Avg.	<p>Site : 03CH10-11Y Condition : PEAK_74 3m HORN 91200-HF HORIZONTAL Detector : Peak Project : 6N2223-01 Mode : 13</p>	<p>Site : 03CH10-11Y Condition : PEAK_74 3m HORN 91200-HF VERTICAL Detector : Peak Project : 6N2223-01 Mode : 13</p>

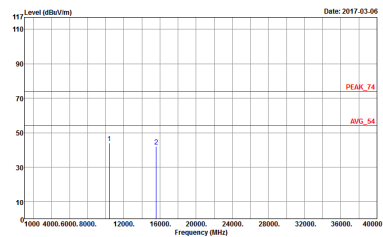
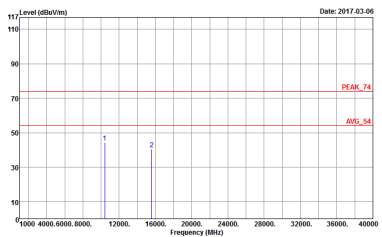

WIFI	Band 1 5150~5250MHz Harmonic @ 3m	
ANT	802.11ac VHT50 CH40 5200MHz	
1+2	Horizontal	Vertical
<p>Peak</p> <p>Avg.</p>	 <p>Site : 03CH10-11Y Condition : PEAK_74 3m HORN 91200-HF HORIZONTAL Detector : Peak Project : 6N2223-01 Mode : 14</p>	 <p>Site : 03CH10-11Y Condition : PEAK_74 3m HORN 91200-HF VERTICAL Detector : Peak Project : 6N2223-01 Mode : 14</p>

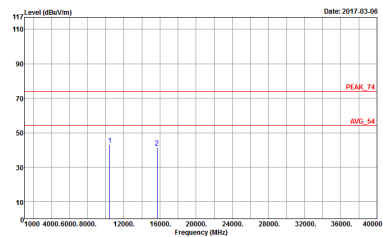
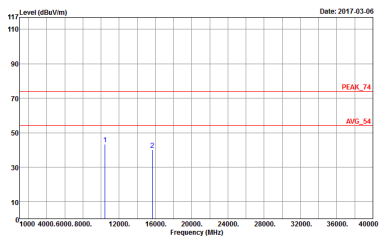

WIFI	Band 1 5150~5250MHz Harmonic @ 3m	
ANT	802.11ac VHT50 CH45 5225MHz	
1+2	Horizontal	Vertical
<p>Peak</p> <p>Avg.</p>	 <p>Site : 03CH10-11Y Condition : PEAK_74 3m HORN 91200-HF HORIZONTAL Detector : Peak Project : 6N2223-01 Mode : 15</p>	 <p>Site : 03CH10-11Y Condition : PEAK_74 3m HORN 91200-HF VERTICAL Detector : Peak Project : 6N2223-01 Mode : 15</p>



**Band 1 5150~5250MHz
WIFI 802.11ac VHT60 (Harmonic @ 3m)**

WIFI	Band 1 5150~5250MHz Harmonic @ 3m	
ANT	802.11ac VHT60 CH37 5185MHz	
1+2	Horizontal	Vertical
Peak Avg.	<p>Site : 03CH10-HY Condition : PEAK_74 3m HORN 9120D-HF HORIZONTAL Detector : Peak Project : 6N2223-01 Mode : 16</p>	<p>Site : 03CH10-HY Condition : PEAK_74 3m HORN 9120D-HF VERTICAL Detector : Peak Project : 6N2223-01 Mode : 16</p>



WIFI	Band 1 5150~5250MHz Harmonic @ 3m	
ANT	802.11ac VHT60 CH40 5200MHz	
1+2	Horizontal	Vertical
<p>Peak</p> <p>Avg.</p>	<p>Site : 03CH10-11Y Condition : PEAK_74 3m HORN 91200-HF HORIZONTAL Detector : Peak Project : 6N2223-01 Mode : 17</p>	<p>Site : 03CH10-11Y Condition : PEAK_74 3m HORN 91200-HF VERTICAL Detector : Peak Project : 6N2223-01 Mode : 17</p>

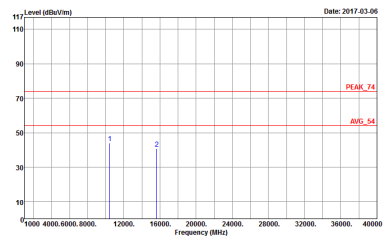
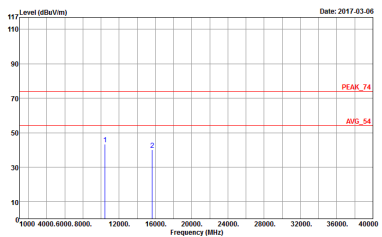

WIFI	Band 1 5150~5250MHz Harmonic @ 3m	
ANT	802.11ac VHT60 CH44 5220MHz	
1+2	Horizontal	Vertical
<p>Peak</p> <p>Avg.</p>	 <p>Site : 03CH10-11Y Condition : PEAK_74 3m HORN 91200-HF HORIZONTAL Detector : Peak Project : 6N2223-01 Mode : 18</p>	 <p>Site : 03CH10-11Y Condition : PEAK_74 3m HORN 91200-HF VERTICAL Detector : Peak Project : 6N2223-01 Mode : 18</p>



Band 1 5150~5250MHz
WIFI 802.11ac VHT80 (Harmonic @ 3m)

WIFI	Band 1 5150~5250MHz Harmonic @ 3m	
ANT	802.11ac VHT80 CH39 5195MHz	
1+2	Horizontal	Vertical
Peak Avg.	<p>Site : 03CH10-HY Condition : PEAK_74 3m HORN 91200-HF HORIZONTAL Detector : Peak Project : 6N2223-01 Mode : 19</p>	<p>Site : 03CH10-HY Condition : PEAK_74 3m HORN 91200-HF VERTICAL Detector : Peak Project : 6N2223-01 Mode : 19</p>

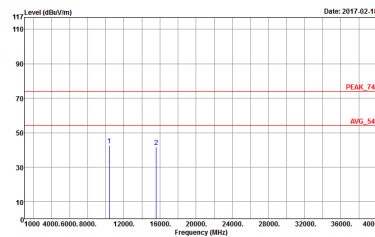
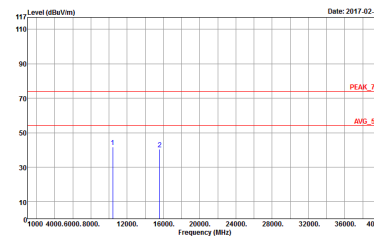

WIFI	Band 1 5150~5250MHz Harmonic @ 3m	
ANT	802.11ac VHT80 CH40 5200MHz	
1+2	Horizontal	Vertical
<p>Peak</p> <p>Avg.</p>	 <p>Site : 03CH10-11Y Condition : PEAK_74 3m HORN 91200-HF HORIZONTAL Detector : Peak Project : 6N2223-01 Mode : Z0</p>	 <p>Site : 03CH10-11Y Condition : PEAK_74 3m HORN 91200-HF VERTICAL Detector : Peak Project : 6N2223-01 Mode : Z0</p>

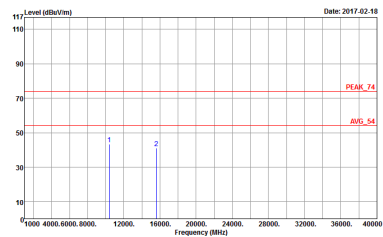
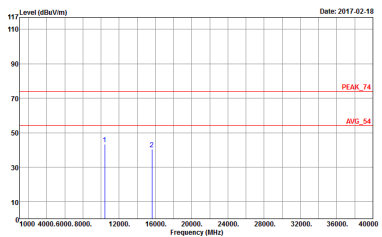

WIFI	Band 1 5150~5250MHz Harmonic @ 3m	
ANT	802.11ac VHT80 CH42 5210MHz	
1+2	Horizontal	Vertical
<p>Peak</p> <p>Avg.</p>	 <p>Site : 03CH10-11Y Condition : PEAK_74 3m HORN 91200-HF HORIZONTAL Detector : Peak Project : 6N2223-01 Mode : Z1</p>	 <p>Site : 03CH10-11Y Condition : PEAK_74 3m HORN 91200-HF VERTICAL Detector : Peak Project : 6N2223-01 Mode : Z1</p>

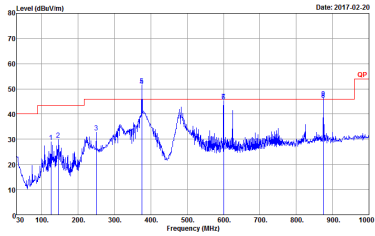
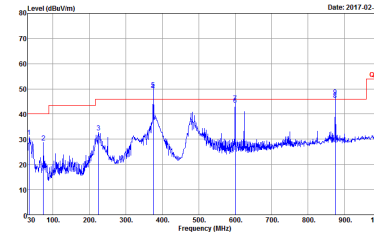

Emission below 1GHz
5GHz WIFI 802.11ac VHT60 (LF)

WIFI	5GHz WIFI	
ANT	802.11ac VHT60 LF	
1+2	Horizontal	Vertical
QP / Peak	 <p>Site : 03CH10-11Y Condition : QP 3m BE-LOG 6111D-LF HORIZONTAL Detector : Peak Project : 6N2223-01 Mode : 43</p>	 <p>Site : 03CH10-11Y Condition : QP 3m BE-LOG 6111D-LF VERTICAL Detector : Peak Project : 6N2223-01 Mode : 43</p>



Appendix E Duty Cycle Plots

Antenna	Band	Duty Cycle(%)	T(us)	1/T(kHz)	VBW Setting
1	802.11ac VHT10	96.95	2540.00	0.39	1kHz
2	802.11ac VHT10	96.95	2540.00	0.39	1kHz
1	802.11ac VHT20	95.49	1270.00	0.79	1kHz
2	802.11ac VHT20	94.10	1275.00	0.78	1kHz
1	802.11ac VHT30	92.67	834.00	1.20	3kHz
2	802.11ac VHT30	93.33	840.00	1.19	3kHz
1	802.11ac VHT40	90.48	627.00	1.59	3kHz
2	802.11ac VHT40	91.30	630.00	1.58	3kHz
1	802.11ac VHT50	89.58	516.00	1.94	3kHz
2	802.11ac VHT50	89.58	516.00	1.94	3kHz
1	802.11ac VHT60	85.95	416.00	2.40	3kHz
2	802.11ac VHT60	87.40	416.00	2.40	3kHz
1	802.11ac VHT80	82.67	310.00	3.23	10kHz
2	802.11ac VHT80	82.90	315.00	3.17	10kHz

<MIMO Ant. 1+2(1)>

802.11ac VHT10

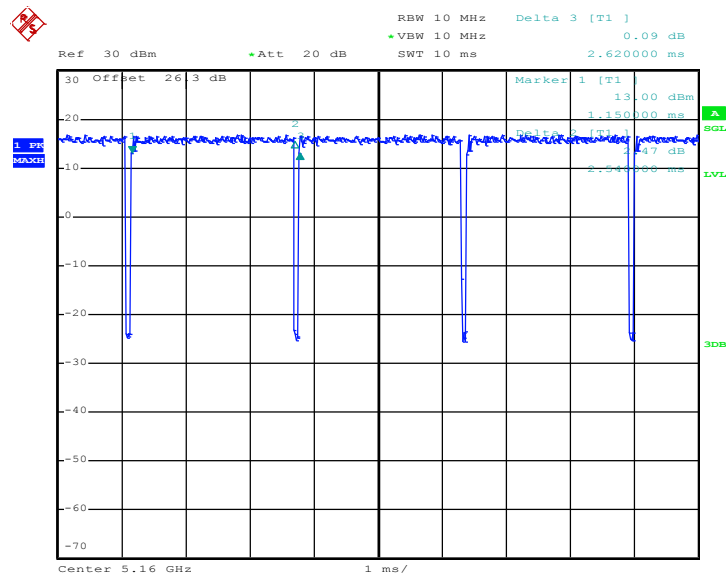

Date: 23.FEB.2017 21:34:38



802.11ac VHT20

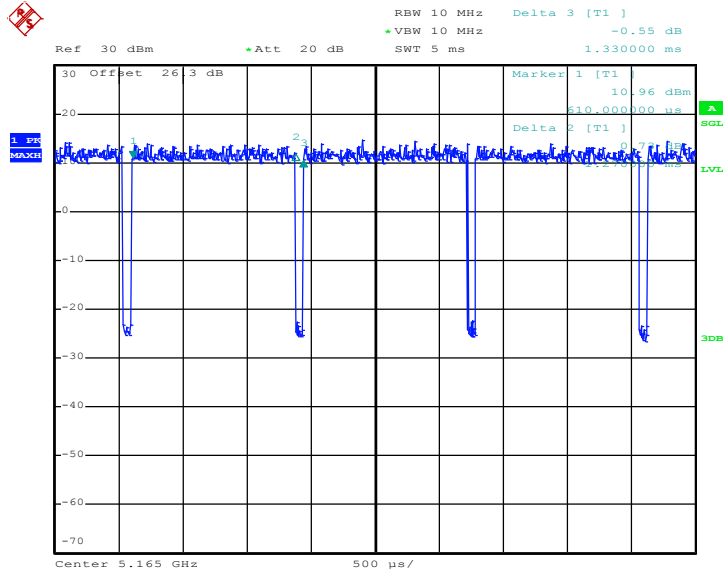

Date: 23.FEB.2017 21:39:28

802.11ac VHT30

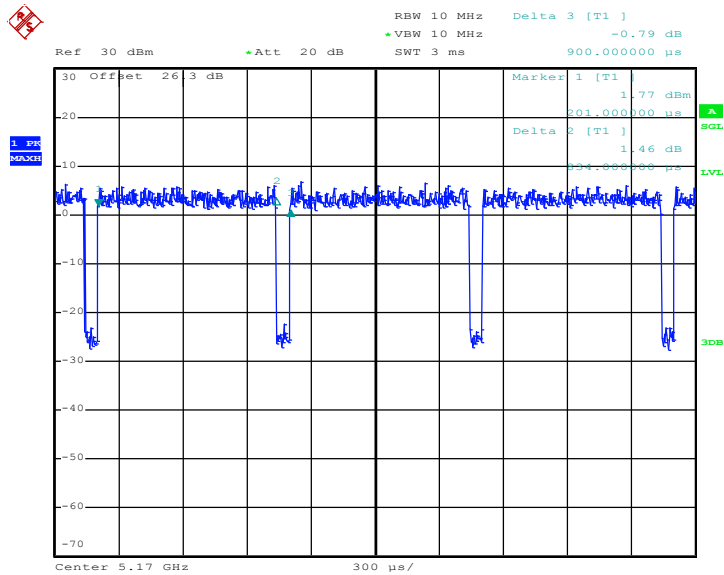

Date: 23.FEB.2017 21:49:14



802.11ac VHT40

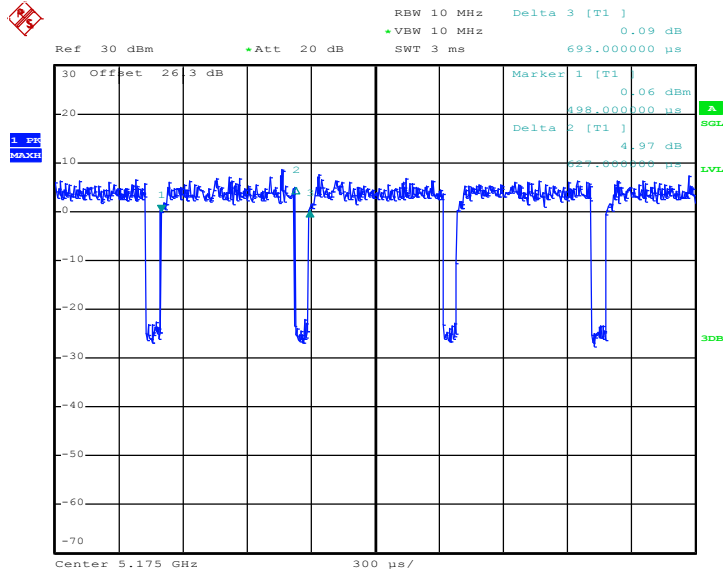

Date: 23.FEB.2017 21:55:22

802.11ac VHT50

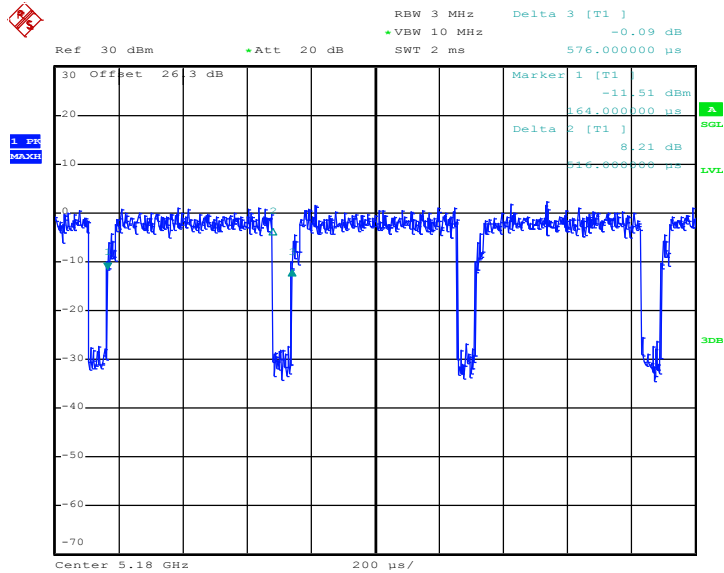

Date: 23.FEB.2017 22:01:52



802.11ac VHT60

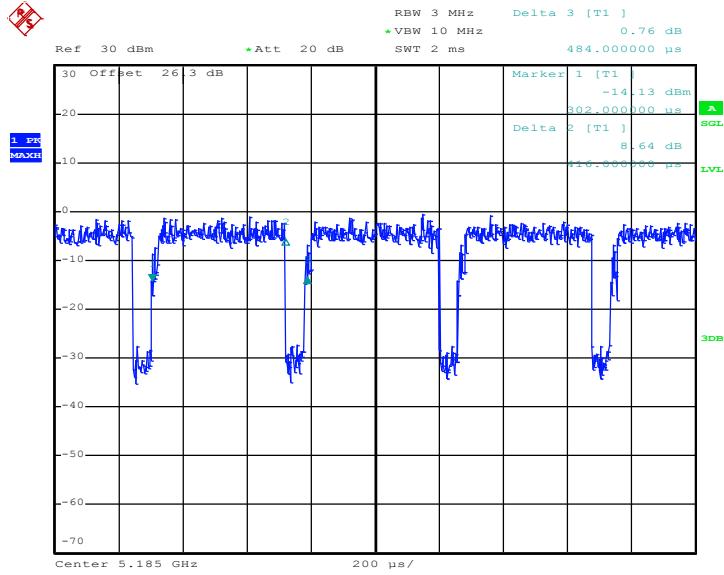

Date: 23.FEB.2017 22:12:49

802.11ac VHT80

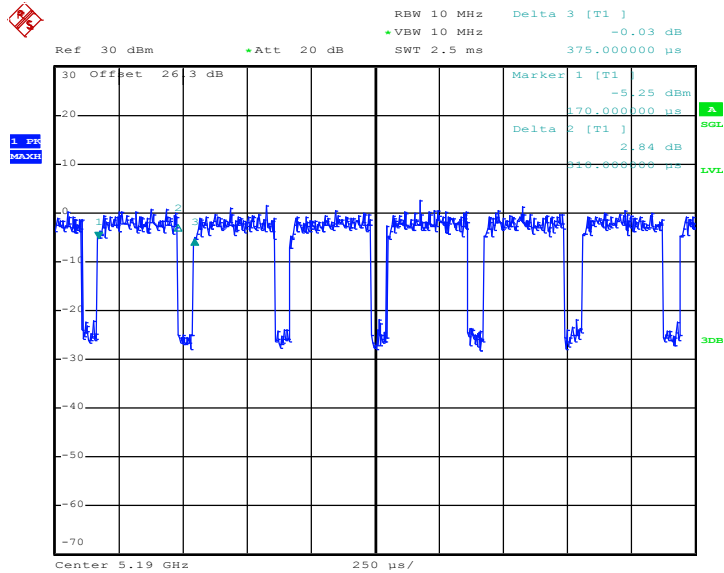

Date: 23.FEB.2017 22:19:35



<MIMO Ant. 1+2(2)>

802.11ac VHT10

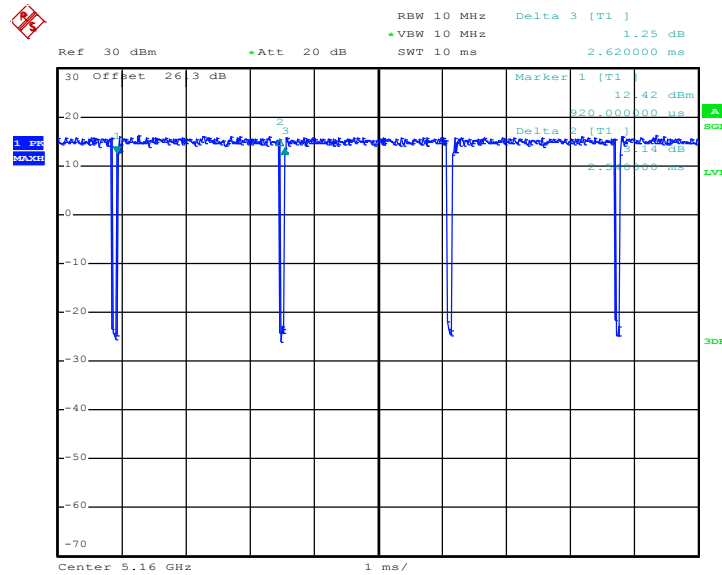

Date: 23.FEB.2017 21:36:32

802.11ac VHT20

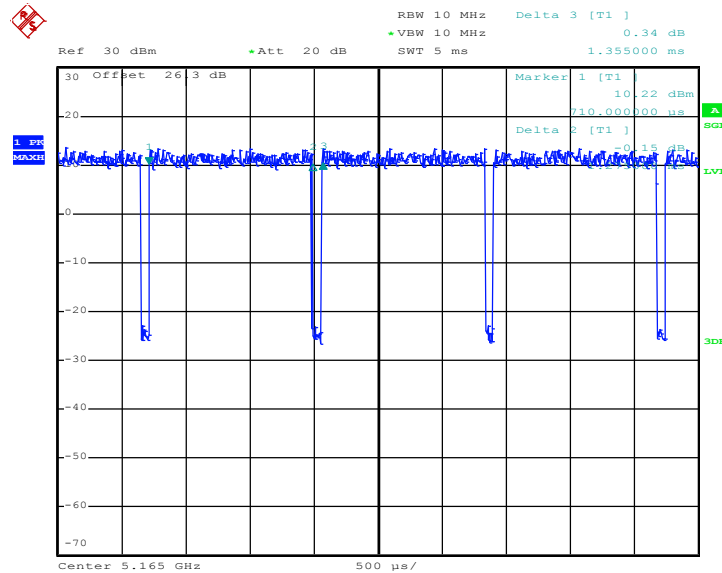

Date: 23.FEB.2017 21:41:14



802.11ac VHT30

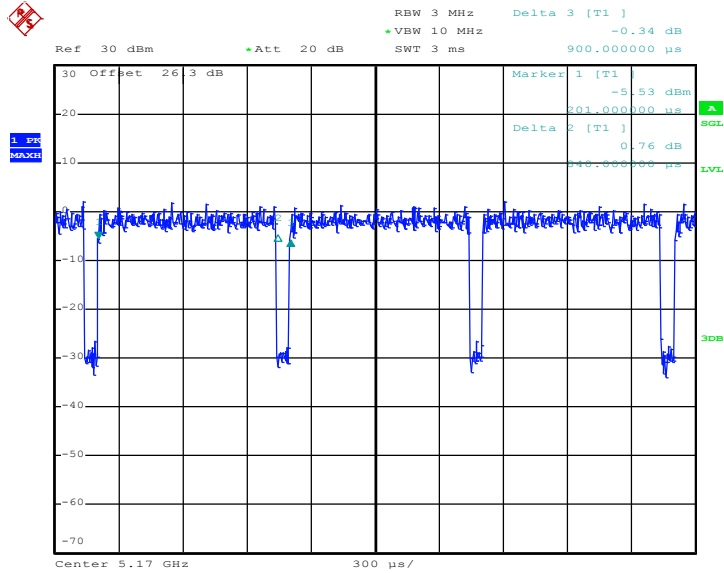

Date: 23.FEB.2017 21:50:35

802.11ac VHT40

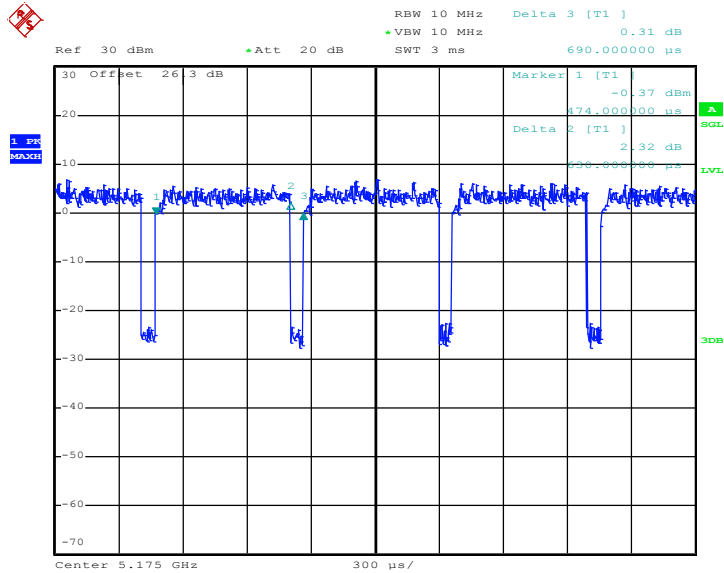

Date: 23.FEB.2017 21:57:44



802.11ac VHT50

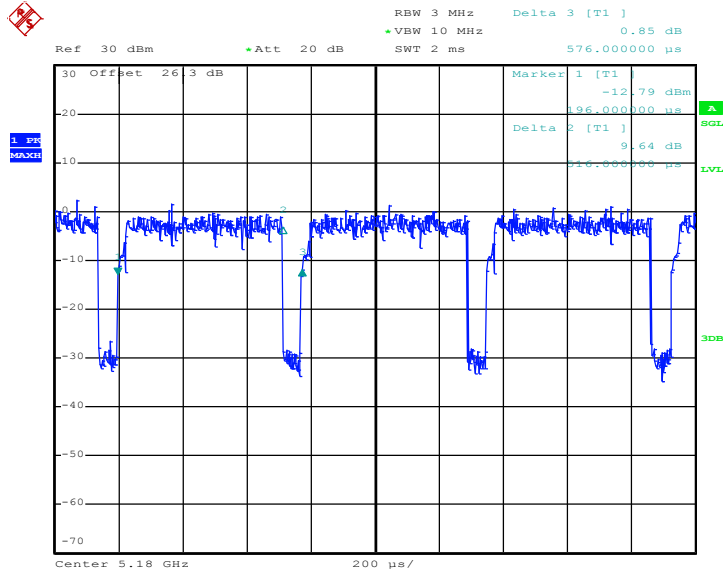

Date: 23.FEB.2017 22:03:16

802.11ac VHT60

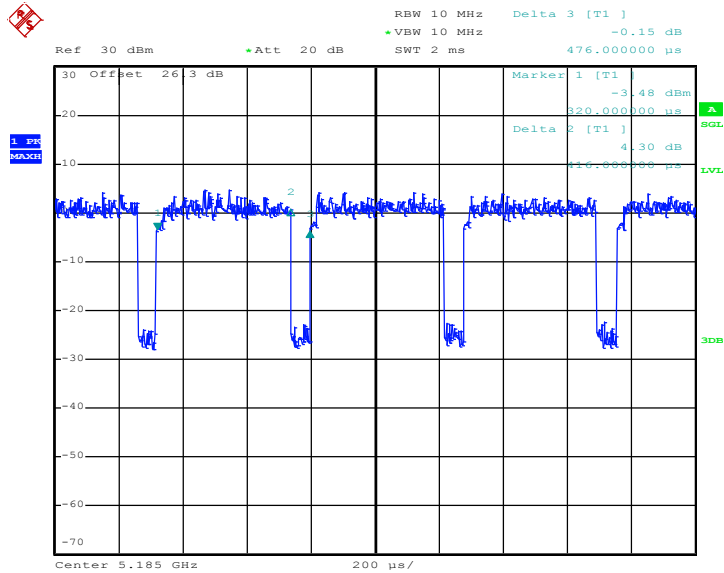

Date: 23.FEB.2017 22:14:51



802.11ac VHT80

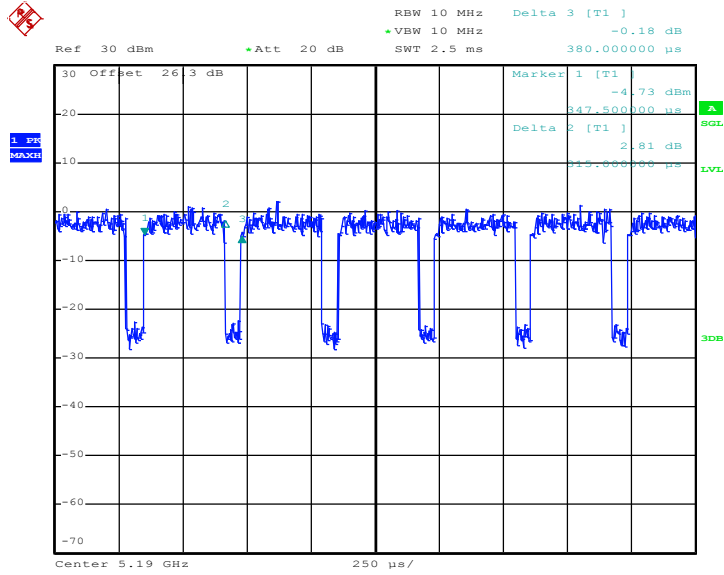

Date: 23.FEB.2017 22:22:31