



MET Laboratories, Inc. *Safety Certification - EMI - Telecom Environmental Simulation*

914 WEST PATAPSCO AVENUE • BALTIMORE, MARYLAND 21230-3432 • PHONE (410) 354-3300 • FAX (410) 354-3313

33439 WESTERN AVENUE • UNION CITY, CALIFORNIA 94587 • PHONE (510) 489-6300 • FAX (510) 489-6372

3162 BELICK STREET • SANTA CLARA, CALIFORNIA 95054 • PHONE (408) 748-3585 • FAX (510) 489-6372

May 5, 2011

Ubiquiti Networks
91 E. Tasman
San Jose, CA 95134

Dear Robert Pera,

Enclosed is the EMC Wireless test report for compliance testing of the Ubiquiti Networks, NanoStationM5 as tested to the requirements of Title 47 of the CFR, Ch. 1 (10-1-06 ed.), Part 15, Subpart B, ICES-003, Issue 4 February 2004 for a Class A Digital Device and FCC Part 15 Subpart C, RSS-210, Issue 8, Dec. 2010 for Intentional Radiators.

Thank you for using the services of MET Laboratories, Inc. If you have any questions regarding these results or if MET can be of further service to you, please feel free to contact me.

Sincerely yours,
MET LABORATORIES, INC.

Jennifer Warnell
Documentation Department

Reference: (\Ubiquiti Networks\EMCS82947-FCC247 Rev. 1)

Certificates and reports shall not be reproduced except in full, without the written permission of MET Laboratories, Inc.

Electromagnetic Compatibility Criteria Test Report

for the

**Ubiquiti Networks
NanoStationM5**

Tested under
the FCC Certification Rules
contained in
Title 47 of the CFR, Parts 15 Subpart B & ICES-003
for Class A Digital Devices
&
15.247 Subpart C & RSS-210, Issue 8, Dec. 2010
for Intentional Radiators

MET Report: EMCS82947-FCC247 Rev. 1

May 5, 2011

Prepared For:

**Ubiquiti Networks
91 E. Tasman
San Jose, CA 95134**

Prepared By:
MET Laboratories, Inc.
3162 Belick St.
Santa Clara, CA 95054

Electromagnetic Compatibility Criteria Test Report

for the

Ubiquiti Networks NanoStationM5

Tested under
the FCC Certification Rules
contained in
Title 47 of the CFR, Parts 15 Subpart B & ICES-003
for Class A Digital Devices
&
15.247 Subpart C & RSS-210, Issue 8, Dec. 2010
for Intentional Radiators



Lionel Gabrillo, Project Engineer
Electromagnetic Compatibility Lab



Jennifer Warnell
Documentation Department

Engineering Statement: The measurements shown in this report were made in accordance with the procedures indicated, and the emissions from this equipment were found to be within the limits applicable. I assume full responsibility for the accuracy and completeness of these measurements, and for the qualifications of all persons taking them. It is further stated that upon the basis of the measurements made, the equipment tested is capable of operation in accordance with the requirements of the FCC Rules Parts 15B, 15.247 and Industry Canada standards ICES-003, Issue 4 February 2004, RSS-210, Issue 8, Dec. 2010 under normal use and maintenance.



Shawn McMillen,
Wireless Manager, Electromagnetic Compatibility Lab

Report Status Sheet

Revision	Report Date	Reason for Revision to Report
∅	April 26, 2011	Initial Issue
1	May 5, 2011	Revised to reflect TCB corrections.

Table of Contents

I.	Executive Summary	1
	A. Purpose of Test	2
	B. Executive Summary	2
II.	Equipment Configuration	3
	A. Overview	4
	B. References	5
	C. Test Site	5
	D. Description of Test Sample	6
	E. Equipment Configuration	8
	F. Support Equipment	8
	G. Ports and Cabling Information	8
	H. Mode of Operation	9
	I. Method of Monitoring EUT Operation	9
	J. Modifications	9
	a) Modifications to EUT	9
	b) Modifications to Test Standard	9
	K. Disposition of EUT	9
III.	Electromagnetic Compatibility Criteria for Unintentional Radiators	10
	§ 15.107(a) Conducted Emissions Limits	11
	§ 15.109(a) Radiated Emissions Limits	15
IV.	Electromagnetic Compatibility Criteria for Intentional Radiators	19
	§ 15.203 Antenna Requirement	20
	§ 15.207(a) Conducted Emissions Limits	21
	§ 15.247(a)(a) 6 dB and 99% Bandwidth	25
	§ 15.247(b) Peak Power Output	58
	§ 15.247(d) Radiated Spurious Emissions Requirements and Band Edge	76
	§ 15.247(d) RF Conducted Spurious Emissions Requirements and Band Edge	111
	§ 15.247(e) Peak Power Spectral Density	154
	RSS-GEN Receiver Spurious Emissions	174
V.	Test Equipment	177
VI.	Certification & User's Manual Information	179
	A. Certification Information	180
	B. Label and User's Manual Information	184
VII.	ICES-003 Procedural & Labeling Requirements	186

List of Tables

Table 1. Executive Summary of EMC Part 15.247 Compliance Testing	2
Table 2. EUT Summary Table.....	4
Table 3. References	5
Table 4. Equipment Configuration	8
Table 5. Support Equipment.....	8
Table 6. Ports and Cabling Information	8
Table 7. Conducted Limits for Radio Frequency Devices calculated from FCC Part 15 Subsections 15.107(a) (b) and 15.207(a)	11
Table 8. Conducted Emissions - Voltage, AC Power, Phase Line (120 VAC, 60 Hz).....	12
Table 9. Conducted Emissions - Voltage, AC Power, Neutral Line (120 VAC, 60 Hz).....	13
Table 10. Radiated Emissions Limits calculated from FCC Part 15, §15.109 (a) (b)	15
Table 11. Radiated Emissions Limits, Test Results, FCC Limits.....	16
Table 12. Radiated Emissions Limits, Test Results, ICES-003 Limits	17
Table 13. Conducted Limits for Intentional Radiators from FCC Part 15 § 15.207(a)	21
Table 14. Conducted Emissions, 15.207(a), Phase Line, Test Results.....	22
Table 15. Conducted Emissions, 15.207(a), Neutral Line, Test Results	23
Table 16. 6 dB Occupied Bandwidth, Test Results, Port 1	26
Table 17. 6 dB Occupied Bandwidth, Test Results, Port 2	27
Table 18. 99% Occupied Bandwidth, Test Results, Port 1.....	28
Table 19. 99% Occupied Bandwidth, Test Results, Port 2.....	29
Table 20. Output Power Requirements from §15.247(b)	58
Table 21. Peak Power Output, Test Results, Port 1	59
Table 22. Peak Power Output, Test Results, Port 2.....	60
Table 23. Peak Power Output, Test Results, Summed	61
Table 24. Restricted Bands of Operation.....	76
Table 25. Radiated Emissions Limits Calculated from FCC Part 15, § 15.209 (a)	77
Table 26. Radiated Harmonic Emissions, 802.11n HT5	78
Table 27. Radiated Harmonic Emissions, 802.11n HT8	78
Table 28. Radiated Harmonic Emissions, 802.11n HT10	78
Table 29. Radiated Harmonic Emissions, 802.11n HT20	78
Table 30. Radiated Harmonic Emissions, 802.11n HT30	78
Table 31. Radiated Harmonic Emissions, 802.11n HT40	78
Table 32. Peak Power Spectral Density, Test Results, Combiner, 802.11n HT5	155
Table 33. Peak Power Spectral Density, Test Results, Combiner, 802.11n HT8	155
Table 34. Peak Power Spectral Density, Test Results, Combiner, 802.11n HT10	155
Table 35. Peak Power Spectral Density, Test Results, Combiner, 802.11n HT20	155
Table 36. Peak Power Spectral Density, Test Results, Combiner, 802.11n HT30	155
Table 37. Peak Power Spectral Density, Test Results, Combiner, 802.11n HT40	156
Table 38. Peak Power Spectral Density, Test Results, 802.11a 20 MHz	156
Table 39. Peak Power Spectral Density, Test Results, 802.11a 40 MHz	156
Table 40. Peak Power Spectral Density, Test Results, Port 1, 802.11n HT5	156
Table 41. Peak Power Spectral Density, Test Results, Port 1, 802.11n HT8	156
Table 42. Peak Power Spectral Density, Test Results, Port 1, 802.11n HT10	157
Table 43. Peak Power Spectral Density, Test Results, Port 1, 802.11n HT20	157
Table 44. Peak Power Spectral Density, Test Results, Port 1, 802.11n HT30	157
Table 45. Peak Power Spectral Density, Test Results, Port 1, 802.11n HT40	157
Table 46. Peak Power Spectral Density, Test Results, Port 2, 802.11n HT5	157
Table 47. Peak Power Spectral Density, Test Results, Port 2, 802.11n HT8	158
Table 48. Peak Power Spectral Density, Test Results, Port 2, 802.11n HT10	158
Table 49. Peak Power Spectral Density, Test Results, Port 2, 802.11n HT20	158
Table 50. Peak Power Spectral Density, Test Results, Port 2, 802.11n HT30	158

Table 51. Peak Power Spectral Density, Test Results, Port 2, 802.11n HT40	158
Table 52. Spurious Emission Limits for Receivers	174
Table 53. Test Equipment List	178

List of Plots

Plot 1. Conducted Emission, Phase Line Plot	12
Plot 2. Conducted Emission, Neutral Line Plot	13
Plot 3. Radiated Emissions, 30 MHz - 1 GHz, FCC Limits	16
Plot 4. Radiated Emissions, ICES-003 Limits	17
Plot 5. Conducted Emissions, 15.207(a), Phase Line	22
Plot 6. Conducted Emissions, 15.207(a), Neutral Line	23
Plot 7. 6 dB Occupied Bandwidth, Low Channel, 802.11a 20MHz	30
Plot 8. 6 dB Occupied Bandwidth, Mid Channel, 802.11a 20MHz	30
Plot 9. 6 dB Occupied Bandwidth, High Channel, 802.11a 20MHz	30
Plot 10. 6 dB Occupied Bandwidth, Low Channel, 802.11a 40 MHz	31
Plot 11. 6 dB Occupied Bandwidth, Mid Channel, 802.11a 40 MHz	31
Plot 12. 6 dB Occupied Bandwidth, High Channel, 802.11a 40 MHz	31
Plot 13. 6 dB Occupied Bandwidth, Low Channel, 802.11n HT5, Port 1	32
Plot 14. 6 dB Occupied Bandwidth, Mid Channel, 802.11n HT5, Port 1	32
Plot 15. 6 dB Occupied Bandwidth, High Channel, 802.11n HT5, Port 1	32
Plot 16. 6 dB Occupied Bandwidth, Low Channel, 802.11n HT5, Port 2	33
Plot 17. 6 dB Occupied Bandwidth, Mid Channel, 802.11n HT5, Port 2	33
Plot 18. 6 dB Occupied Bandwidth, High Channel, 802.11n HT5, Port 2	33
Plot 19. 6 dB Occupied Bandwidth, Low Channel, 802.11n HT8, Port 1	34
Plot 20. 6 dB Occupied Bandwidth, Mid Channel, 802.11n HT8, Port 1	34
Plot 21. 6 dB Occupied Bandwidth, High Channel, 802.11n HT8, Port 1	34
Plot 22. 6 dB Occupied Bandwidth, Low Channel, 802.11n HT8, Port 2	35
Plot 23. 6 dB Occupied Bandwidth, Mid Channel, 802.11n HT8, Port 2	35
Plot 24. 6 dB Occupied Bandwidth, High Channel, 802.11n HT8, Port 2	35
Plot 25. 6 dB Occupied Bandwidth, Low Channel, 802.11n HT10, Port 1	36
Plot 26. 6 dB Occupied Bandwidth, Mid Channel, 802.11n HT10, Port 1	36
Plot 27. 6 dB Occupied Bandwidth, High Channel, 802.11n HT10, Port 1	36
Plot 28. 6 dB Occupied Bandwidth, Low Channel, 802.11n HT10, Port 2	37
Plot 29. 6 dB Occupied Bandwidth, Mid Channel, 802.11n HT10, Port 2	37
Plot 30. 6 dB Occupied Bandwidth, High Channel, 802.11n HT10, Port 2	37
Plot 31. 6 dB Occupied Bandwidth, Low Channel, 802.11n HT20, Port 1	38
Plot 32. 6 dB Occupied Bandwidth, Mid Channel, 802.11n HT20, Port 1	38
Plot 33. 6 dB Occupied Bandwidth, High Channel, 802.11n HT20, Port 1	38
Plot 34. 6 dB Occupied Bandwidth, Low Channel, 802.11n HT20, Port 2	39
Plot 35. 6 dB Occupied Bandwidth, Mid Channel, 802.11n HT20, Port 2	39
Plot 36. 6 dB Occupied Bandwidth, High Channel, 802.11n HT20, Port 2	39
Plot 37. 6 dB Occupied Bandwidth, Low Channel, 802.11n HT30, Port 1	40
Plot 38. 6 dB Occupied Bandwidth, Mid Channel, 802.11n HT30, Port 1	40
Plot 39. 6 dB Occupied Bandwidth, High Channel, 802.11n HT30, Port 1	40
Plot 40. 6 dB Occupied Bandwidth, Low Channel, 802.11n HT30, Port 2	41
Plot 41. 6 dB Occupied Bandwidth, Mid Channel, 802.11n HT30, Port 2	41
Plot 42. 6 dB Occupied Bandwidth, High Channel, 802.11n HT30, Port 2	41
Plot 43. 6 dB Occupied Bandwidth, Low Channel, 802.11n HT40, Port 1	42
Plot 44. 6 dB Occupied Bandwidth, Mid Channel, 802.11n HT40, Port 1	42
Plot 45. 6 dB Occupied Bandwidth, High Channel, 802.11n HT40, Port 1	42
Plot 46. 6 dB Occupied Bandwidth, Low Channel, 802.11n HT40, Port 2	43
Plot 47. 6 dB Occupied Bandwidth, Mid Channel, 802.11n HT40, Port 2	43

Plot 48. 6 dB Occupied Bandwidth, High Channel, 802.11n HT40, Port 2	43
Plot 49. 99% Occupied Bandwidth, Low Channel, 802.11a 20 MHz	44
Plot 50. 99% Occupied Bandwidth, Mid Channel, 802.11a 20 MHz	44
Plot 51. 99% Occupied Bandwidth, High Channel, 802.11a 20 MHz	44
Plot 52. 99% Occupied Bandwidth, Low Channel, 802.11a 40 MHz	45
Plot 53. 99% Occupied Bandwidth, Mid Channel, 802.11a 40 MHz	45
Plot 54. 99% Occupied Bandwidth, High Channel, 802.11a 40 MHz	45
Plot 55. 99% Occupied Bandwidth, Low Channel, 802.11n HT5, Port 1	46
Plot 56. 99% Occupied Bandwidth, Mid Channel, 802.11n HT5, Port 1	46
Plot 57. 99% Occupied Bandwidth, High Channel, 802.11n HT5, Port 1	46
Plot 58. 99% Occupied Bandwidth, Low Channel, 802.11n HT5, Port 2	47
Plot 59. 99% Occupied Bandwidth, Mid Channel, 802.11n HT5, Port 2	47
Plot 60. 99% Occupied Bandwidth, High Channel, 802.11n HT5, Port 2	47
Plot 61. 99% Occupied Bandwidth, Low Channel, 802.11n HT8, Port 1	48
Plot 62. 99% Occupied Bandwidth, Mid Channel, 802.11n HT8, Port 1	48
Plot 63. 99% Occupied Bandwidth, High Channel, 802.11n HT8, Port 1	48
Plot 64. 99% Occupied Bandwidth, Low Channel, 802.11n HT8, Port 2	49
Plot 65. 99% Occupied Bandwidth, Mid Channel, 802.11n HT8, Port 2	49
Plot 66. 99% Occupied Bandwidth, High Channel, 802.11n HT8, Port 2	49
Plot 67. 99% Occupied Bandwidth, Low Channel, 802.11n HT10, Port 1	50
Plot 68. 99% Occupied Bandwidth, Mid Channel, 802.11n HT10, Port 1	50
Plot 69. 99% Occupied Bandwidth, High Channel, 802.11n HT10, Port 1	50
Plot 70. 99% Occupied Bandwidth, Low Channel, 802.11n HT10, Port 2	51
Plot 71. 99% Occupied Bandwidth, Mid Channel, 802.11n HT10, Port 2	51
Plot 72. 99% Occupied Bandwidth, High Channel, 802.11n HT10, Port 2	51
Plot 73. 99% Occupied Bandwidth, Low Channel, 802.11n HT20, Port 1	52
Plot 74. 99% Occupied Bandwidth, Mid Channel, 802.11n HT20, Port 1	52
Plot 75. 99% Occupied Bandwidth, High Channel, 802.11n HT20, Port 1	52
Plot 76. 99% Occupied Bandwidth, Low Channel, 802.11n HT20, Port 2	53
Plot 77. 99% Occupied Bandwidth, Mid Channel, 802.11n HT20, Port 2	53
Plot 78. 99% Occupied Bandwidth, High Channel, 802.11n HT20, Port 2	53
Plot 79. 99% Occupied Bandwidth, Low Channel, 802.11n HT30, Port 1	54
Plot 80. 99% Occupied Bandwidth, Mid Channel, 802.11n HT30, Port 1	54
Plot 81. 99% Occupied Bandwidth, High Channel, 802.11n HT30, Port 1	54
Plot 82. 99% Occupied Bandwidth, Low Channel, 802.11n HT30, Port 2	55
Plot 83. 99% Occupied Bandwidth, Mid Channel, 802.11n HT30, Port 2	55
Plot 84. 99% Occupied Bandwidth, High Channel, 802.11n HT30, Port 2	55
Plot 85. 99% Occupied Bandwidth, Low Channel, 802.11n HT40, Port 1	56
Plot 86. 99% Occupied Bandwidth, Mid Channel, 802.11n HT40, Port 1	56
Plot 87. 99% Occupied Bandwidth, High Channel, 802.11n HT40, Port 1	56
Plot 88. 99% Occupied Bandwidth, Low Channel, 802.11n HT40, Port 2	57
Plot 89. 99% Occupied Bandwidth, Mid Channel, 802.11n HT40, Port 2	57
Plot 90. 99% Occupied Bandwidth, High Channel, 802.11n HT40, Port 2	57
Plot 91. Peak Power Output, Low Channel, 802.11a 20 MHz	62
Plot 92. Peak Power Output, Mid Channel, 802.11a 20 MHz	62
Plot 93. Peak Power Output, High Channel, 802.11a 20 MHz	62
Plot 94. Peak Power Output, Low Channel, 802.11a 40 MHz	63
Plot 95. Peak Power Output, Mid Channel, 802.11a 40 MHz	63
Plot 96. Peak Power Output, High Channel, 802.11a 40 MHz	63
Plot 97. Peak Power Output, Low Channel, 802.11n HT5, Port 1	64
Plot 98. Peak Power Output, Mid Channel, 802.11n HT5, Port 1	64
Plot 99. Peak Power Output, High Channel, 802.11n HT5, Port 1	64
Plot 100. Peak Power Output, Low Channel, 802.11n HT5, Port 2	65

Plot 101. Peak Power Output, Mid Channel, 802.11n HT5, Port 2	65
Plot 102. Peak Power Output, High Channel, 802.11n HT5, Port 2	65
Plot 103. Peak Power Output, Low Channel, 802.11n HT8, Port 1	66
Plot 104. Peak Power Output, Mid Channel, 802.11n HT8, Port 1	66
Plot 105. Peak Power Output, High Channel, 802.11n HT8, Port 1	66
Plot 106. Peak Power Output, Low Channel, 802.11n HT8, Port 2	67
Plot 107. Peak Power Output, Mid Channel, 802.11n HT8, Port 2	67
Plot 108. Peak Power Output, High Channel, 802.11n HT8, Port 2	67
Plot 109. Peak Power Output, Low Channel, 802.11n HT10, Port 1	68
Plot 110. Peak Power Output, Mid Channel, 802.11n HT10, Port 1	68
Plot 111. Peak Power Output, High Channel, 802.11n HT10, Port 1	68
Plot 112. Peak Power Output, Low Channel, 802.11n HT10, Port 2	69
Plot 113. Peak Power Output, Mid Channel, 802.11n HT10, Port 2	69
Plot 114. Peak Power Output, High Channel, 802.11n HT10, Port 2	69
Plot 115. Peak Power Output, Low Channel, 802.11n HT20, Port 1	70
Plot 116. Peak Power Output, Mid Channel, 802.11n HT20, Port 1	70
Plot 117. Peak Power Output, High Channel, 802.11n HT20, Port 1	70
Plot 118. Peak Power Output, Low Channel, 802.11n HT20, Port 2	71
Plot 119. Peak Power Output, Mid Channel, 802.11n HT20, Port 2	71
Plot 120. Peak Power Output, High Channel, 802.11n HT20, Port 2	71
Plot 121. Peak Power Output, Low Channel, 802.11n HT30, Port 1	72
Plot 122. Peak Power Output, Mid Channel, 802.11n HT30, Port 1	72
Plot 123. Peak Power Output, High Channel, 802.11n HT30, Port 1	72
Plot 124. Peak Power Output, Low Channel, 802.11n HT30, Port 2	73
Plot 125. Peak Power Output, Mid Channel, 802.11n HT30, Port 2	73
Plot 126. Peak Power Output, High Channel, 802.11n HT30, Port 2	73
Plot 127. Peak Power Output, Low Channel, 802.11n HT40, Port 1	74
Plot 128. Peak Power Output, Mid Channel, 802.11n HT40, Port 1	74
Plot 129. Peak Power Output, High Channel, 802.11n HT40, Port 1	74
Plot 130. Peak Power Output, Low Channel, 802.11n HT40, Port 2	75
Plot 131. Peak Power Output, Mid Channel, 802.11n HT40, Port 2	75
Plot 132. Peak Power Output, High Channel, 802.11n HT40, Port 2	75
Plot 133. Radiated Spurious Emissions, Low Channel, 30 MHz – 1 GHz, 802.11a 20 MHz	79
Plot 134. Radiated Spurious Emissions, Low Channel, 1 GHz – 18 GHz, 802.11a 20 MHz	79
Plot 135. Radiated Spurious Emissions, Mid Channel, 30 MHz – 1 GHz, 802.11a 20 MHz	79
Plot 136. Radiated Spurious Emissions, Mid Channel, 1 GHz – 18 GHz, 802.11a 20 MHz	80
Plot 137. Radiated Spurious Emissions, High Channel, 30 MHz – 1 GHz, 802.11a 20 MHz	80
Plot 138. Radiated Spurious Emissions, High Channel, 1 GHz – 18 GHz, 802.11a 20 MHz	80
Plot 139. Radiated Spurious Emissions, Low Channel, 30 MHz – 1 GHz, 802.11a 40 MHz	81
Plot 140. Radiated Spurious Emissions, Low Channel, 1 GHz – 18 GHz, 802.11a 40 MHz	81
Plot 141. Radiated Spurious Emissions, Mid Channel, 30 MHz – 1 GHz, 802.11a 40 MHz	81
Plot 142. Radiated Spurious Emissions, Mid Channel, 1 GHz – 18 GHz, 802.11a 40 MHz	82
Plot 143. Radiated Spurious Emissions, High Channel, 30 MHz – 1 GHz, 802.11a 40 MHz	82
Plot 144. Radiated Spurious Emissions, High Channel, 1 GHz – 18 GHz, 802.11a 40 MHz	82
Plot 145. Radiated Spurious Emissions, Low Channel, 30 MHz – 1 GHz, 802.11n HT5	83
Plot 146. Radiated Spurious Emissions, Low Channel, 1 GHz – 18 GHz, 802.11n HT5	83
Plot 147. Radiated Spurious Emissions, Mid Channel, 30 MHz – 1 GHz, 802.11n HT5	83
Plot 148. Radiated Spurious Emissions, Mid Channel, 1 GHz – 18 GHz, 802.11n HT5	84
Plot 149. Radiated Spurious Emissions, High Channel, 30 MHz – 1 GHz, 802.11n HT5	84
Plot 150. Radiated Spurious Emissions, High Channel, 1 GHz – 18 GHz, 802.11n HT5	84
Plot 151. Radiated Spurious Emissions, Low Channel, 30 MHz – 1 GHz, 802.11n HT8	85
Plot 152. Radiated Spurious Emissions, Low Channel, 1 GHz – 18 GHz, 802.11n HT8	85
Plot 153. Radiated Spurious Emissions, Mid Channel, 30 MHz – 1 GHz, 802.11n HT8	85

Plot 154. Radiated Spurious Emissions, Mid Channel, 1 GHz – 18 GHz, 802.11n HT8	86
Plot 155. Radiated Spurious Emissions, High Channel, 30 MHz – 1 GHz, 802.11n HT8	86
Plot 156. Radiated Spurious Emissions, High Channel, 1 GHz – 18 GHz, 802.11n HT8	86
Plot 157. Radiated Spurious Emissions, Low Channel, 30 MHz – 1 GHz, 802.11n HT10	87
Plot 158. Radiated Spurious Emissions, Low Channel, 1 GHz – 18 GHz, 802.11n HT10	87
Plot 159. Radiated Spurious Emissions, Mid Channel, 30 MHz – 1 GHz, 802.11n HT10	87
Plot 160. Radiated Spurious Emissions, Mid Channel, 1 GHz – 18 GHz, 802.11n HT10	88
Plot 161. Radiated Spurious Emissions, High Channel, 30 MHz – 1 GHz, 802.11n HT10	88
Plot 162. Radiated Spurious Emissions, High Channel, 1 GHz – 18 GHz, 802.11n HT10	88
Plot 163. Radiated Spurious Emissions, Low Channel, 30 MHz – 1 GHz, 802.11n HT20	89
Plot 164. Radiated Spurious Emissions, Low Channel, 1 GHz – 18 GHz, 802.11n HT20	89
Plot 165. Radiated Spurious Emissions, Mid Channel, 30 MHz – 1 GHz, 802.11n HT20	89
Plot 166. Radiated Spurious Emissions, Mid Channel, 1 GHz – 18 GHz, 802.11n HT20	90
Plot 167. Radiated Spurious Emissions, High Channel, 30 MHz – 1 GHz, 802.11n HT20	90
Plot 168. Radiated Spurious Emissions, High Channel, 1 GHz – 18 GHz, 802.11n HT20	90
Plot 169. Radiated Spurious Emissions, Low Channel, 30 MHz – 1 GHz, 802.11n HT30	91
Plot 170. Radiated Spurious Emissions, Low Channel, 1 GHz – 18 GHz, 802.11n HT30	91
Plot 171. Radiated Spurious Emissions, Mid Channel, 30 MHz – 1 GHz, 802.11n HT30	91
Plot 172. Radiated Spurious Emissions, Mid Channel, 1 GHz – 18 GHz, 802.11n HT30	92
Plot 173. Radiated Spurious Emissions, High Channel, 30 MHz – 1 GHz, 802.11n HT30	92
Plot 174. Radiated Spurious Emissions, High Channel, 1 GHz – 18 GHz, 802.11n HT30	92
Plot 175. Radiated Spurious Emissions, Low Channel, 30 MHz – 1 GHz, 802.11n HT40	93
Plot 176. Radiated Spurious Emissions, Low Channel, 1 GHz – 18 GHz, 802.11n HT40	93
Plot 177. Radiated Spurious Emissions, Mid Channel, 30 MHz – 1 GHz, 802.11n HT40	93
Plot 178. Radiated Spurious Emissions, Mid Channel, 1 GHz – 18 GHz, 802.11n HT40	94
Plot 179. Radiated Spurious Emissions, High Channel, 30 MHz – 1 GHz, 802.11n HT40	94
Plot 180. Radiated Spurious Emissions, High Channel, 1 GHz – 18 GHz, 802.11n HT40	94
Plot 181. Radiated Harmonics, Low Channel, 7 GHz – 18 GHz, 802.11a 20 MHz	95
Plot 182. Radiated Harmonics, Low Channel, 7 GHz – 18 GHz, 802.11a 20 MHz	95
Plot 183. Radiated Harmonics, Mid Channel, 7 GHz – 18 GHz, 802.11a 20 MHz	95
Plot 184. Radiated Harmonics, Low Channel, 7 GHz – 18 GHz, 802.11a 40 MHz	96
Plot 185. Radiated Harmonics, Low Channel, 7 GHz – 18 GHz, 802.11a 40 MHz	96
Plot 186. Radiated Harmonics, Mid Channel, 7 GHz – 18 GHz, 802.11a 40 MHz	96
Plot 187. Radiated Harmonics, Low Channel, 7 GHz – 18 GHz, Average, 802.11n HT5	97
Plot 188. Radiated Harmonics, Low Channel, 7 GHz – 18 GHz, Peak, 802.11n HT5	97
Plot 189. Radiated Harmonics, Mid Channel, 7 GHz – 18 GHz, Average, 802.11n HT5	97
Plot 190. Radiated Harmonics, Mid Channel, 7 GHz – 18 GHz, Peak, 802.11n HT5	98
Plot 191. Radiated Harmonics, High Channel, 7 GHz – 18 GHz, Average, 802.11n HT5	98
Plot 192. Radiated Harmonics, High Channel, 7 GHz – 18 GHz, Peak, 802.11n HT5	98
Plot 193. Radiated Harmonics, Low Channel, 7 GHz – 18 GHz, Average, 802.11n HT8	99
Plot 194. Radiated Harmonics, Low Channel, 7 GHz – 18 GHz, Peak, 802.11n HT8	99
Plot 195. Radiated Harmonics, Mid Channel, 7 GHz – 18 GHz, Average, 802.11n HT8	99
Plot 196. Radiated Harmonics, Mid Channel, 7 GHz – 18 GHz, Peak, 802.11n HT8	100
Plot 197. Radiated Harmonics, High Channel, 7 GHz – 18 GHz, Average, 802.11n HT8	100
Plot 198. Radiated Harmonics, High Channel, 7 GHz – 18 GHz, Peak, 802.11n HT8	100
Plot 199. Radiated Harmonics, Low Channel, 7 GHz – 18 GHz, Average, 802.11n HT10	101
Plot 200. Radiated Harmonics, Low Channel, 7 GHz – 18 GHz, Peak, 802.11n HT10	101
Plot 201. Radiated Harmonics, Mid Channel, 7 GHz – 18 GHz, Average, 802.11n HT10	101
Plot 202. Radiated Harmonics, Mid Channel, 7 GHz – 18 GHz, Peak, 802.11n HT10	102
Plot 203. Radiated Harmonics, High Channel, 7 GHz – 18 GHz, Average, 802.11n HT10	102
Plot 204. Radiated Harmonics, High Channel, 7 GHz – 18 GHz, Peak, 802.11n HT10	102
Plot 205. Radiated Harmonics, Low Channel, 7 GHz – 18 GHz, Average, 802.11n HT20	103
Plot 206. Radiated Harmonics, Low Channel, 7 GHz – 18 GHz, Peak, 802.11n HT20	103

Plot 207. Radiated Harmonics, Mid Channel, 7 GHz – 18 GHz, Average, 802.11n HT20.....	103
Plot 208. Radiated Harmonics, Mid Channel, 7 GHz – 18 GHz, Peak, 802.11n HT20	104
Plot 209. Radiated Harmonics, High Channel, 7 GHz – 18 GHz, Average, 802.11n HT20	104
Plot 210. Radiated Harmonics, High Channel, 7 GHz – 18 GHz, Peak, 802.11n HT20	104
Plot 211. Radiated Harmonics, Low Channel, 7 GHz – 18 GHz, Average, 802.11n HT30.....	105
Plot 212. Radiated Harmonics, Low Channel, 7 GHz – 18 GHz, Peak, 802.11n HT30.....	105
Plot 213. Radiated Harmonics, Mid Channel, 7 GHz – 18 GHz, Average, 802.11n HT30.....	105
Plot 214. Radiated Harmonics, Mid Channel, 7 GHz – 18 GHz, Peak, 802.11n HT30	106
Plot 215. Radiated Harmonics, High Channel, 7 GHz – 18 GHz, Average, 802.11n HT30	106
Plot 216. Radiated Harmonics, High Channel, 7 GHz – 18 GHz, Peak, 802.11n HT30	106
Plot 217. Radiated Harmonics, Low Channel, 7 GHz – 18 GHz, Average, 802.11n HT40.....	107
Plot 218. Radiated Harmonics, Low Channel, 7 GHz – 18 GHz, Peak, 802.11n HT40.....	107
Plot 219. Radiated Harmonics, Mid Channel, 7 GHz – 18 GHz, Average, 802.11n HT40.....	107
Plot 220. Radiated Harmonics, Mid Channel, 7 GHz – 18 GHz, Peak, 802.11n HT40	108
Plot 221. Radiated Harmonics, High Channel, 7 GHz – 18 GHz, Average, 802.11n HT40	108
Plot 222. Radiated Harmonics, High Channel, 7 GHz – 18 GHz, Peak, 802.11n HT40	108
Plot 223. Conducted Spurious Emissions, Low Channel, 30 MHz – 1 GHz, 802.11a 20 MHz.....	112
Plot 224. Conducted Spurious Emissions, Low Channel, 1 GHz – 40 GHz, 802.11a 20 MHz.....	112
Plot 225. Conducted Spurious Emissions, Mid Channel, 30 MHz – 1 GHz, 802.11a 20 MHz.....	112
Plot 226. Conducted Spurious Emissions, Mid Channel, 1 GHz – 40 GHz, 802.11a 20 MHz	113
Plot 227. Conducted Spurious Emissions, High Channel, 30 MHz – 1 GHz, 802.11a 20 MHz	113
Plot 228. Conducted Spurious Emissions, High Channel, 1 GHz – 40 GHz, 802.11a 20 MHz.....	113
Plot 229. Conducted Spurious Emissions, Low Channel, 30 MHz – 1 GHz, 802.11a 40 MHz.....	114
Plot 230. Conducted Spurious Emissions, Low Channel, 1 GHz – 40 GHz, 802.11a 40 MHz.....	114
Plot 231. Conducted Spurious Emissions, Mid Channel, 30 MHz – 1 GHz, 802.11a 40 MHz.....	114
Plot 232. Conducted Spurious Emissions, Mid Channel, 1 GHz – 40 GHz, 802.11a 40 MHz	115
Plot 233. Conducted Spurious Emissions, High Channel, 30 MHz – 1 GHz, 802.11a 40 MHz	115
Plot 234. Conducted Spurious Emissions, High Channel, 1 GHz – 40 GHz, 802.11a 40 MHz.....	115
Plot 235. Conducted Spurious Emissions, Low Channel, 30 MHz – 1 GHz, 802.11n HT5, Port 1	116
Plot 236. Conducted Spurious Emissions, Low Channel, 1 GHz – 40 GHz, 802.11n HT5, Port 1.....	116
Plot 237. Conducted Spurious Emissions, Mid Channel, 30 MHz – 1 GHz, 802.11n HT5, Port 1.....	116
Plot 238. Conducted Spurious Emissions, Mid Channel, 1 GHz – 40 GHz, 802.11n HT5, Port 1	117
Plot 239. Conducted Spurious Emissions, High Channel, 30 MHz – 1 GHz, 802.11n HT5, Port 1	117
Plot 240. Conducted Spurious Emissions, High Channel, 1 GHz – 40 GHz, 802.11n HT5, Port 1	117
Plot 241. Conducted Spurious Emissions, Low Channel, 30 MHz – 1 GHz, 802.11n HT5, Port 2.....	118
Plot 242. Conducted Spurious Emissions, Low Channel, 1 GHz – 40 GHz, 802.11n HT5, Port 2.....	118
Plot 243. Conducted Spurious Emissions, Mid Channel, 30 MHz – 1 GHz, 802.11n HT5, Port 2.....	118
Plot 244. Conducted Spurious Emissions, Mid Channel, 1 GHz – 40 GHz, 802.11n HT5, Port 2	119
Plot 245. Conducted Spurious Emissions, High Channel, 30 MHz – 1 GHz, 802.11n HT5, Port 2	119
Plot 246. Conducted Spurious Emissions, High Channel, 1 GHz – 40 GHz, 802.11n HT5, Port 2.....	119
Plot 247. Conducted Spurious Emissions, Low Channel, 30 MHz – 1 GHz, 802.11n HT8, Port 1	120
Plot 248. Conducted Spurious Emissions, Low Channel, 1 GHz – 40 GHz, 802.11n HT8, Port 1.....	120
Plot 249. Conducted Spurious Emissions, Mid Channel, 30 MHz – 1 GHz, 802.11n HT8, Port 1.....	120
Plot 250. Conducted Spurious Emissions, Mid Channel, 1 GHz – 40 GHz, 802.11n HT8, Port 1	121
Plot 251. Conducted Spurious Emissions, High Channel, 30 MHz – 1 GHz, 802.11n HT8, Port 1	121
Plot 252. Conducted Spurious Emissions, High Channel, 1 GHz – 40 GHz, 802.11n HT8, Port 1	121
Plot 253. Conducted Spurious Emissions, Low Channel, 30 MHz – 1 GHz, 802.11n HT8, Port 2	122
Plot 254. Conducted Spurious Emissions, Low Channel, 1 GHz – 40 GHz, 802.11n HT8, Port 2.....	122
Plot 255. Conducted Spurious Emissions, Mid Channel, 30 MHz – 1 GHz, 802.11n HT8, Port 2.....	122
Plot 256. Conducted Spurious Emissions, Mid Channel, 1 GHz – 40 GHz, 802.11n HT8, Port 2	123
Plot 257. Conducted Spurious Emissions, High Channel, 30 MHz – 1 GHz, 802.11n HT8, Port 2	123
Plot 258. Conducted Spurious Emissions, High Channel, 1 GHz – 40 GHz, 802.11n HT8, Port 2.....	123
Plot 259. Conducted Spurious Emissions, Low Channel, 30 MHz – 1 GHz, 802.11n HT10, Port 1	124

Plot 260. Conducted Spurious Emissions, Low Channel, 1 GHz – 40 GHz, 802.11n HT10, Port 1	124
Plot 261. Conducted Spurious Emissions, Mid Channel, 30 MHz – 1 GHz, 802.11n HT10, Port 1	124
Plot 262. Conducted Spurious Emissions, Mid Channel, 1 GHz – 40 GHz, 802.11n HT10, Port 1	125
Plot 263. Conducted Spurious Emissions, High Channel, 30 MHz – 1 GHz, 802.11n HT10, Port 1	125
Plot 264. Conducted Spurious Emissions, High Channel, 1 GHz – 40 GHz, 802.11n HT10, Port 1	125
Plot 265. Conducted Spurious Emissions, Low Channel, 30 MHz – 1 GHz, 802.11n HT10, Port 2	126
Plot 266. Conducted Spurious Emissions, Low Channel, 1 GHz – 40 GHz, 802.11n HT10, Port 2	126
Plot 267. Conducted Spurious Emissions, Mid Channel, 30 MHz – 1 GHz, 802.11n HT10, Port 2	126
Plot 268. Conducted Spurious Emissions, Mid Channel, 1 GHz – 40 GHz, 802.11n HT10, Port 2	127
Plot 269. Conducted Spurious Emissions, High Channel, 30 MHz – 1 GHz, 802.11n HT10, Port 2	127
Plot 270. Conducted Spurious Emissions, High Channel, 1 GHz – 40 GHz, 802.11n HT10, Port 2	127
Plot 271. Conducted Spurious Emissions, Low Channel, 30 MHz – 1 GHz, 802.11n HT20, Port 1	128
Plot 272. Conducted Spurious Emissions, Low Channel, 1 GHz – 40 GHz, 802.11n HT20, Port 1	128
Plot 273. Conducted Spurious Emissions, Mid Channel, 30 MHz – 1 GHz, 802.11n HT20, Port 1	128
Plot 274. Conducted Spurious Emissions, Mid Channel, 1 GHz – 40 GHz, 802.11n HT20, Port 1	129
Plot 275. Conducted Spurious Emissions, High Channel, 30 MHz – 1 GHz, 802.11n HT20, Port 1	129
Plot 276. Conducted Spurious Emissions, High Channel, 1 GHz – 40 GHz, 802.11n HT20, Port 1	129
Plot 277. Conducted Spurious Emissions, Low Channel, 30 MHz – 1 GHz, 802.11n HT20, Port 2	130
Plot 278. Conducted Spurious Emissions, Low Channel, 1 GHz – 40 GHz, 802.11n HT20, Port 2	130
Plot 279. Conducted Spurious Emissions, Mid Channel, 30 MHz – 1 GHz, 802.11n HT20, Port 2	130
Plot 280. Conducted Spurious Emissions, Mid Channel, 1 GHz – 40 GHz, 802.11n HT20, Port 2	131
Plot 281. Conducted Spurious Emissions, High Channel, 30 MHz – 1 GHz, 802.11n HT20, Port 2	131
Plot 282. Conducted Spurious Emissions, High Channel, 1 GHz – 40 GHz, 802.11n HT20, Port 2	131
Plot 283. Conducted Spurious Emissions, Low Channel, 30 MHz – 1 GHz, 802.11n HT30, Port 1	132
Plot 284. Conducted Spurious Emissions, Low Channel, 1 GHz – 40 GHz, 802.11n HT30, Port 1	132
Plot 285. Conducted Spurious Emissions, Mid Channel, 30 MHz – 1 GHz, 802.11n HT30, Port 1	132
Plot 286. Conducted Spurious Emissions, Mid Channel, 1 GHz – 40 GHz, 802.11n HT30, Port 1	133
Plot 287. Conducted Spurious Emissions, High Channel, 30 MHz – 1 GHz, 802.11n HT30, Port 1	133
Plot 288. Conducted Spurious Emissions, High Channel, 1 GHz – 40 GHz, 802.11n HT30, Port 1	133
Plot 289. Conducted Spurious Emissions, Low Channel, 30 MHz – 1 GHz, 802.11n HT30, Port 2	134
Plot 290. Conducted Spurious Emissions, Low Channel, 1 GHz – 40 GHz, 802.11n HT30, Port 2	134
Plot 291. Conducted Spurious Emissions, Mid Channel, 30 MHz – 1 GHz, 802.11n HT30, Port 2	134
Plot 292. Conducted Spurious Emissions, Mid Channel, 1 GHz – 40 GHz, 802.11n HT30, Port 2	135
Plot 293. Conducted Spurious Emissions, High Channel, 30 MHz – 1 GHz, 802.11n HT30, Port 2	135
Plot 294. Conducted Spurious Emissions, High Channel, 1 GHz – 26 GHz, 802.11n HT30, Port 2	135
Plot 295. Conducted Spurious Emissions, Low Channel, 30 MHz – 1 GHz, 802.11n HT40, Port 1	136
Plot 296. Conducted Spurious Emissions, Low Channel, 1 GHz – 40 GHz, 802.11n HT40, Port 1	136
Plot 297. Conducted Spurious Emissions, Mid Channel, 30 MHz – 1 GHz, 802.11n HT40, Port 1	136
Plot 298. Conducted Spurious Emissions, Mid Channel, 1 GHz – 40 GHz, 802.11n HT40, Port 1	137
Plot 299. Conducted Spurious Emissions, High Channel, 30 MHz – 1 GHz, 802.11n HT40, Port 1	137
Plot 300. Conducted Spurious Emissions, High Channel, 1 GHz – 40 GHz, 802.11n HT40, Port 1	137
Plot 301. Conducted Spurious Emissions, Low Channel, 30 MHz – 1 GHz, 802.11n HT40, Port 2	138
Plot 302. Conducted Spurious Emissions, Low Channel, 1 GHz – 40 GHz, 802.11n HT40, Port 2	138
Plot 303. Conducted Spurious Emissions, Mid Channel, 30 MHz – 1 GHz, 802.11n HT40, Port 2	138
Plot 304. Conducted Spurious Emissions, Mid Channel, 1 GHz – 40 GHz, 802.11n HT40, Port 2	139
Plot 305. Conducted Spurious Emissions, High Channel, 30 MHz – 1 GHz, 802.11n HT40, Port 2	139
Plot 306. Conducted Spurious Emissions, High Channel, 1 GHz – 40 GHz, 802.11n HT40, Port 2	139
Plot 307. Conducted Band Edge, Low Channel, 802.11a 20 MHz	140
Plot 308. Conducted Band Edge, High Channel, 802.11a 20 MHz	140
Plot 309. Conducted Band Edge, Low Channel, 802.11a 40 MHz	141
Plot 310. Conducted Band Edge, High Channel, 802.11a 40 MHz	141
Plot 311. Conducted Band Edge, Low Channel, 802.11n HT5, Port 1	142
Plot 312. Conducted Band Edge, High Channel, 802.11n HT5, Port 1	142

Plot 313. Conducted Band Edge, Low Channel, 802.11n HT5, Port 2	142
Plot 314. Conducted Band Edge, High Channel, 802.11n HT5, Port 2	143
Plot 315. Conducted Band Edge, Low Channel, 802.11n HT8, Port 1	144
Plot 316. Conducted Band Edge, High Channel, 802.11n HT8, Port 1	144
Plot 317. Conducted Band Edge, Low Channel, 802.11n HT8, Port 2	144
Plot 318. Conducted Band Edge, High Channel, 802.11n HT8, Port 2	145
Plot 319. Conducted Band Edge, Low Channel, 802.11n HT10, Port 1	146
Plot 320. Conducted Band Edge, High Channel, 802.11n HT10, Port 1	146
Plot 321. Conducted Band Edge, Low Channel, 802.11n HT10, Port 2	146
Plot 322. Conducted Band Edge, High Channel, 802.11n HT10, Port 2	147
Plot 323. Conducted Band Edge, Low Channel, 802.11n HT20, Port 1	148
Plot 324. Conducted Band Edge, High Channel, 802.11n HT20, Port 1	148
Plot 325. Conducted Band Edge, Low Channel, 802.11n HT20, Port 2	148
Plot 326. Conducted Band Edge, High Channel, 802.11n HT20, Port 2	149
Plot 327. Conducted Band Edge, Low Channel, 802.11n HT30, Port 1	150
Plot 328. Conducted Band Edge, High Channel, 802.11n HT30, Port 1	150
Plot 329. Conducted Band Edge, Low Channel, 802.11n HT30, Port 2	150
Plot 330. Conducted Band Edge, High Channel, 802.11n HT30, Port 2	151
Plot 331. Conducted Band Edge, Low Channel, 802.11n HT40, Port 1	152
Plot 332. Conducted Band Edge, High Channel, 802.11n HT40, Port 1	152
Plot 333. Conducted Band Edge, Low Channel, 802.11n HT40, Port 2	152
Plot 334. Conducted Band Edge, High Channel, 802.11n HT40, Port 2	153
Plot 335. Peak Power Spectral Density, Low Channel, Average, 802.11a 20 MHz	159
Plot 336. Peak Power Spectral Density, Mid Channel, Average, 802.11a 20 MHz	159
Plot 337. Peak Power Spectral Density, High Channel, Average, 802.11a 20 MHz	159
Plot 338. Peak Power Spectral Density, Low Channel, Average, 802.11a 40 MHz	160
Plot 339. Peak Power Spectral Density, Mid Channel, Average, 802.11a 40 MHz	160
Plot 340. Peak Power Spectral Density, High Channel, Average, 802.11a 40 MHz	160
Plot 341. Peak Power Spectral Density, Low Channel, 802.11n HT5, Port 1	161
Plot 342. Peak Power Spectral Density, Mid Channel, 802.11n HT5, Port 1	161
Plot 343. Peak Power Spectral Density, High Channel, 802.11n HT5, Port 1	161
Plot 344. Peak Power Spectral Density, Low Channel, 802.11n HT5, Port 2	162
Plot 345. Peak Power Spectral Density, Mid Channel, 802.11n HT5, Port 2	162
Plot 346. Peak Power Spectral Density, High Channel, 802.11n HT5, Port 2	162
Plot 347. Peak Power Spectral Density, Low Channel, 802.11n HT8, Port 1	163
Plot 348. Peak Power Spectral Density, Mid Channel, 802.11n HT8, Port 1	163
Plot 349. Peak Power Spectral Density, High Channel, 802.11n HT8, Port 1	163
Plot 350. Peak Power Spectral Density, Low Channel, 802.11n HT8, Port 2	164
Plot 351. Peak Power Spectral Density, Mid Channel, 802.11n HT8, Port 2	164
Plot 352. Peak Power Spectral Density, High Channel, 802.11n HT8, Port 2	164
Plot 353. Peak Power Spectral Density, Low Channel, 802.11n HT10, Port 1	165
Plot 354. Peak Power Spectral Density, Mid Channel, 802.11n HT10, Port 1	165
Plot 355. Peak Power Spectral Density, High Channel, 802.11n HT10, Port 1	165
Plot 356. Peak Power Spectral Density, Low Channel, 802.11n HT10, Port 2	166
Plot 357. Peak Power Spectral Density, Mid Channel, 802.11n HT10, Port 2	166
Plot 358. Peak Power Spectral Density, High Channel, 802.11n HT10, Port 2	166
Plot 359. Peak Power Spectral Density, Low Channel, 802.11n HT20, Port 1	167
Plot 360. Peak Power Spectral Density, Mid Channel, 802.11n HT20, Port 1	167
Plot 361. Peak Power Spectral Density, High Channel, 802.11n HT20, Port 1	167
Plot 362. Peak Power Spectral Density, Low Channel, 802.11n HT20, Port 2	168
Plot 363. Peak Power Spectral Density, Mid Channel, 802.11n HT20, Port 2	168
Plot 364. Peak Power Spectral Density, High Channel, 802.11n HT20, Port 2	168
Plot 365. Peak Power Spectral Density, Low Channel, 802.11n HT30, Port 1	169

Plot 366. Peak Power Spectral Density, Mid Channel, 802.11n HT30, Port 1	169
Plot 367. Peak Power Spectral Density, High Channel, 802.11n HT30, Port 1	169
Plot 368. Peak Power Spectral Density, Low Channel, 802.11n HT30, Port 2	170
Plot 369. Peak Power Spectral Density, Mid Channel, 802.11n HT30, Port 2	170
Plot 370. Peak Power Spectral Density, High Channel, 802.11n HT30, Port 2	170
Plot 371. Peak Power Spectral Density, Low Channel, 802.11n HT40, Port 1	171
Plot 372. Peak Power Spectral Density, Mid Channel, 802.11n HT40, Port 1	171
Plot 373. Peak Power Spectral Density, High Channel, 802.11n HT40, Port 1	171
Plot 374. Peak Power Spectral Density, Low Channel, 802.11n HT40, Port 2	172
Plot 375. Peak Power Spectral Density, Mid Channel, 802.11n HT40, Port 2	172
Plot 376. Peak Power Spectral Density, High Channel, 802.11n HT40, Port 2	172
Plot 377. Receiver Spurious Emission, 30 MHz – 1 GHz, Port 1	175
Plot 378. Receiver Spurious Emission, 1 GHz – 18 GHz, Port 1	175
Plot 379. Receiver Spurious Emission, 30 MHz – 1 GHz, Port 2	176
Plot 380. Receiver Spurious Emission, 1 GHz – 18 GHz, Port 2	176

List of Figures

Figure 1. Block Diagram of Test Configuration	7
Figure 2. Block Diagram, Occupied Bandwidth Test Setup	25
Figure 3. Peak Power Output Test Setup	58
Figure 4. Block Diagram, Conducted Spurious Emissions Test Setup	111
Figure 5. Block Diagram, Peak Power Spectral Density Test Setup	154
Figure 6. Block Diagram, Conducted Receiver Spurious Emissions Test Setup	174

List of Photographs

Photograph 1. Ubiquiti Networks NanoStationM5, Front View	6
Photograph 2. Ubiquiti Networks NanoStationM5, Rear View	6
Photograph 3. Conducted Emissions, Test Setup	14
Photograph 4. Radiated Emission, Test Setup	18
Photograph 5. Conducted Emissions, 15.207(a), Test Setup	24
Photograph 6. Radiated Spurious Emissions, Test Setup, 30 MHz – 1 GHz	109
Photograph 7. Radiated Spurious Emissions, Test Setup, 1 GHz – 18 GHz	109
Photograph 8. Radiated Harmonics Emissions, Test Setup	110

List of Terms and Abbreviations

AC	Alternating Current
ACF	Antenna Correction Factor
Cal	Calibration
<i>d</i>	Measurement Distance
dB	Decibels
dB μ A	Decibels above one microamp
dB μ V	Decibels above one microvolt
dB μ A/m	Decibels above one microamp per meter
dB μ V/m	Decibels above one microvolt per meter
DC	Direct Current
E	Electric Field
DSL	Digital Subscriber Line
ESD	Electrostatic Discharge
EUT	Equipment Under Test
<i>f</i>	Frequency
FCC	Federal Communications Commission
GRP	Ground Reference Plane
H	Magnetic Field
HCP	Horizontal Coupling Plane
Hz	Hertz
IEC	International Electrotechnical Commission
kHz	kilohertz
kPa	kilopascal
kV	kilovolt
LISN	Line Impedance Stabilization Network
MHz	Megahertz
μ H	microhenry
μ	microfarad
μ s	microseconds
NEBS	Network Equipment-Building System
PRF	Pulse Repetition Frequency
RF	Radio Frequency
RMS	Root-Mean-Square
TWT	Traveling Wave Tube
V/m	Volts per meter
VCP	Vertical Coupling Plane

I. Executive Summary

A. Purpose of Test

An EMC evaluation was performed to determine compliance of the Ubiquiti Networks NanoStationM5, with the requirements of Part 15, §15.247. All references are to the most current version of Title 47 of the Code of Federal Regulations in effect. In accordance with §2.1033, the following data is presented in support of the Certification of the NanoStationM5. Ubiquiti Networks should retain a copy of this document which should be kept on file for at least two years after the manufacturing of the NanoStationM5, has been **permanently** discontinued.

B. Executive Summary

The following tests were conducted on a sample of the equipment for the purpose of demonstrating compliance with Part 15, §15.247, in accordance with Ubiquiti Networks, purchase order number US100112. All tests were conducted using measurement procedure ANSI C63.4-2003.

FCC Reference 47 CFR Part 15.247:2005	IC Reference RSS-210 Issue 8: 2010	Description	Compliance
47 CFR Part 15.107 (a)	ICES-003 Issue 4 February 2004	Conducted Emission Limits for a Class A Digital Device	Compliant
47 CFR Part 15.109 (a)	ICES-003 Issue 4 February 2004	Radiated Emission Limits for a Class A Digital Device	Compliant
Title 47 of the CFR, Part 15 §15.203	N/A	Antenna Requirement	Compliant
Title 47 of the CFR, Part 15 §15.207(a)	RSS-210(7.2.2)	Conducted Emission Limits	Compliant
Title 47 of the CFR, Part 15 §15.247(a)(2)	RSS-Gen(4.6)	6dB Occupied Bandwidth	Compliant
		99% Occupied Bandwidth	Compliant
Title 47 of the CFR, Part 15 §15.247(b)	RSS-210(A8.4)	Peak Power Output	Compliant
Title 47 of the CFR, Part 15 §15.247(d); §15.209; §15.205	RSS-210(A8.5)	Radiated Spurious Emissions Requirements	Compliant
Title 47 of the CFR, Part 15 §15.247(d)	RSS-210(A8.5)	RF Conducted Spurious Emissions Requirements	Compliant
Title 47 of the CFR, Part 15 §15.247(d)	RSS-210(A8.5)	RF Conducted Band Edge	Compliant
Title 47 of the CFR, Part 15; §15.247(e)	RSS-210(A8.3)	Peak Power Spectral Density	Compliant
Title 47 of the CFR, Part 15 §15.247(i)	RSS-Gen(5.5)	Maximum Permissible Exposure (MPE)	Compliant
N/A	RSS-Gen(4.8)	Receiver Spurious Emissions	Compliant

Table 1. Executive Summary of EMC Part 15.247 Compliance Testing

II. Equipment Configuration

A. Overview

MET Laboratories, Inc. was contracted by Ubiquiti Networks to perform testing on the NanoStationM5, under Ubiquiti Networks' purchase order number US100112.

This document describes the test setups, test methods, required test equipment, and the test limit criteria used to perform compliance testing of the Ubiquiti Networks, NanoStationM5.

The results obtained relate only to the item(s) tested.

Model(s) Tested:	NanoStationM5			
Model(s) Covered:	NanoStationM5			
EUT Specifications:	Primary Power: 120 VAC, 60 Hz			
	FCC ID: SWX-M5N IC: 6545A-M5N			
	Type of Modulations:	DSSS		
	Equipment Code:	DTS		
	Peak RF Output Power:	802.11a:	29.21 dBm (20 MHz); 29.78 dBm (40 MHz)	
		802.11n:	26.75 dBm (HT5); 27.28 dBm (HT8); 26.59 dBm (HT10); 26.93 dBm (HT20); 26.86 dBm (HT30); 26.93 dBm (HT40)	
		802.11n Combined MIMO:	29.66 dBm (HT5); 29.69 dBm (HT8); 29.45 dBm (HT10); 29.72 dBm (HT20); 29.71 dBm (HT30); 29.88 dBm (HT40)	
	EUT Frequency Ranges:	5728 – 5847 MHz		
	Antenna Gain/Type:	Integral Antenna – 16 dBi		
	6 dB Bandwidth:	802.11a:	16.478 MHz (20 MHz); 36.311 MHz (40 MHz)	
802.11n:		4.125 MHz (HT5); 6.580 MHz (HT8); 8.274 MHz (HT10); 16.622 MHz (HT20); 24.852 MHz (HT30); 36.320 MHz (HT40)		
Analysis:	The results obtained relate only to the item(s) tested.			
Environmental Test Conditions:	Temperature: 15-35° C			
	Relative Humidity: 30-60%			
	Barometric Pressure: 860-1060 mbar			
Evaluated by:	Lionel Gabrillo			
Report Date(s):	May 5, 2011			

Table 2. EUT Summary Table

B. References

CFR 47, Part 15, Subpart C	Federal Communication Commission, Code of Federal Regulations, Title 47, Part 15: General Rules and Regulations, Allocation, Assignment, and Use of Radio Frequencies
RSS-210, Issue 8, Dec. 2010	Low-power Licence-exempt Radiocommunications Devices (All Frequency Bands): Category I Equipment
CFR 47, Part 15, Subpart B	Electromagnetic Compatibility: Criteria for Radio Frequency Devices
ICES-003, Issue 4 February 2004	Electromagnetic Compatibility: Criteria for Radio Frequency Devices
ANSI C63.4:2003	Methods and Measurements of Radio-Noise Emissions from Low-Voltage Electrical And Electronic Equipment in the Range of 9 kHz to 40 GHz
ANSI/NCSL Z540-1-1994	Calibration Laboratories and Measuring and Test Equipment - General Requirements
ANSI/ISO/IEC 17025:2000	General Requirements for the Competence of Testing and Calibration Laboratories
ANSI C63.10-2009	American National Standard for Testing Unlicensed Wireless Devices

Table 3. References

C. Test Site

All testing was performed at MET Laboratories, Inc., 3162 Belick St., Santa Clara, CA 95054. All equipment used in making physical determinations is accurate and bears recent traceability to the National Institute of Standards and Technology.

Radiated Emissions measurements were performed in a 5 meter semi-anechoic chamber (equivalent to an Open Area Test Site). In accordance with §2.948(a)(3), a complete site description is contained at MET Laboratories.

D. Description of Test Sample

The Ubiquiti Networks NanoStationM5, Equipment Under Test (EUT), is a 5GHz Hi Power 2x2 MIMO AirMax TDMA Station.



Photograph 1. Ubiquiti Networks NanoStationM5, Front View



Photograph 2. Ubiquiti Networks NanoStationM5, Rear View

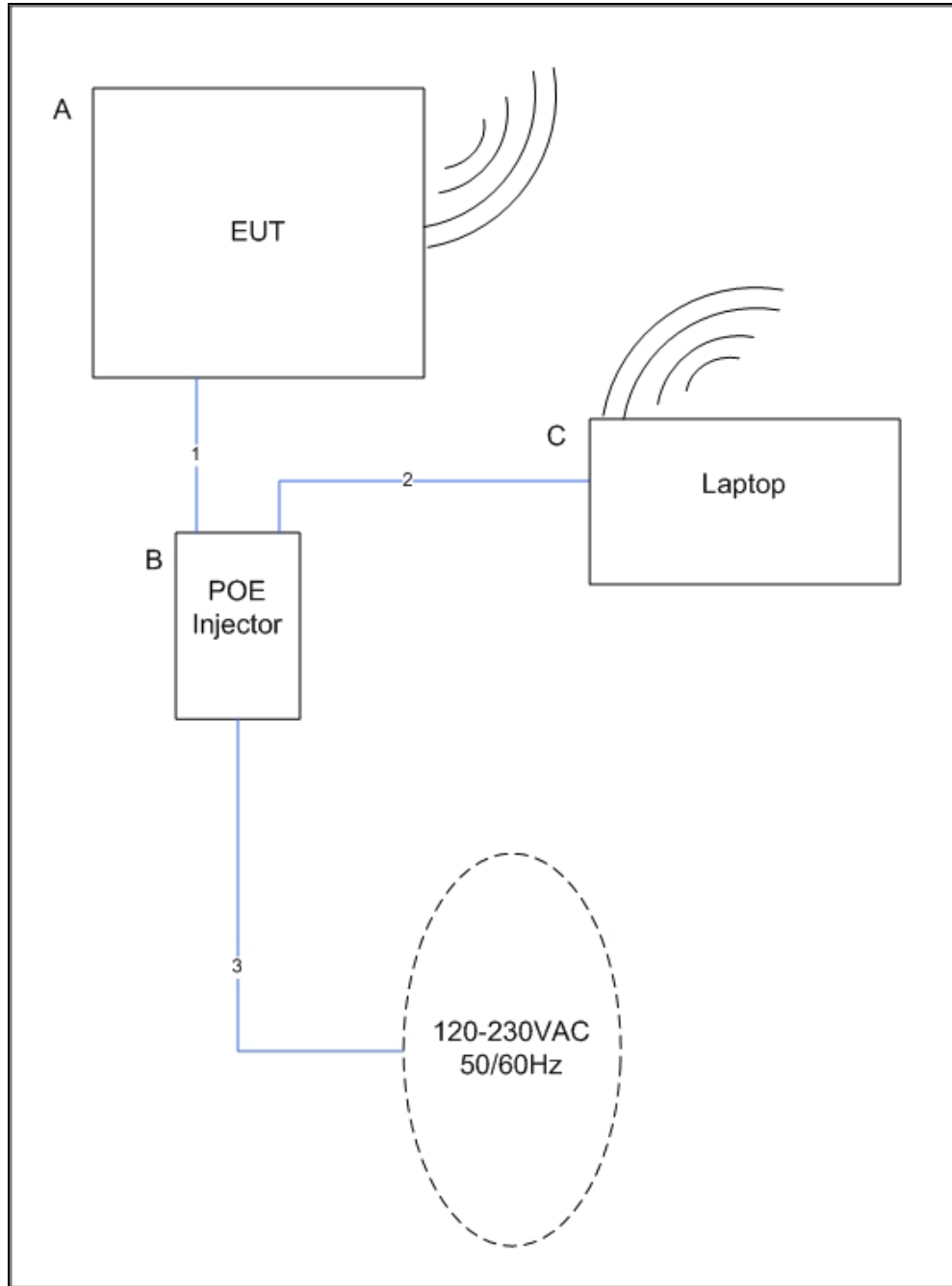

Figure 1. Block Diagram of Test Configuration

E. Equipment Configuration

The EUT was set up as outlined in Figure 1, Block Diagram of Test Setup. All cards, racks, etc., incorporated as part of the EUT is included in the following list.

Ref. ID	Name / Description	Model Number	Serial Number
A	NanoStationM5	NS5	1040T00156D8A77BD
A	NanoStationM5	NS5	1103T002722101B00
A	NanoStationM5	NS5	1104T002722104F5D
B	Power Supply	UBI-POE-15-8	1101-0096733
B	Power Supply	UBI-POE-15-8	1101-0096734

Table 4. Equipment Configuration

F. Support Equipment

Support equipment necessary for the operation and testing of the EUT is included in the following list.

Ref. ID	Name / Description	Manufacturer	Model Number	Serial Number
C	Laptop	Dell	Vostro 1510	4953929473

Table 5. Support Equipment

G. Ports and Cabling Information

Ref. ID	Port Name on EUT	Cable Description	Qty.	Length (m)	Shielded (Y/N)	Termination Point
1	NanoM5 - Main	Ethernet	1	10	Y	PSU – POE port
	NanoM5- Secondary	Ethernet	1	10	Y	Unterminated
1	PSU - POE	Ethernet	1	10	Y	NanoM5 - Main
2	PSU - LAN	Ethernet	1	10	Y	Laptop
3	AC port	AC Cable	1	0.5	Y	100-240VAC Source

Table 6. Ports and Cabling Information

H. Mode of Operation

Transmit 6-54Mbps at 5GHz.

I. Method of Monitoring EUT Operation

IP connectivity is maintained with the EUT. If IP connectivity is lost, EUT connectivity shall be re-established upon power up or re-boot.

J. Modifications

a) Modifications to EUT

No modifications were made to the EUT.

b) Modifications to Test Standard

No modifications were made to the test standard.

K. Disposition of EUT

The test sample including all support equipment submitted to the Electro-Magnetic Compatibility Lab for testing was returned to Ubiquiti Networks upon completion of testing.

III. Electromagnetic Compatibility Criteria for Unintentional Radiators

Electromagnetic Compatibility Criteria

§ 15.107 Conducted Emissions Limits

Test Requirement(s): **15.107 (a)** Except for Class A digital devices, for equipment that is designed to be connected to the public utility (AC) power line, the radio frequency voltage that is conducted back onto the AC power line on any frequency or frequencies within the band 150 kHz to 30 MHz shall not exceed the limits in Table 7. Compliance with this provision shall be based on the measurement of the radio frequency voltage between each power line and ground at the power terminals.

15.107 (b) For a Class A digital device that is designed to be connected to the public utility (AC) power line, the radio frequency voltage that is conducted back onto the AC power line on any frequency or frequencies within the band 150 kHz to 30 MHz shall not exceed the limits in Table 7. Compliance with this provision shall be based on the measurement of the radio frequency voltage between each power line and ground at the power terminals. The lower limit applies at the band edges.

15.207(a), Except as shown in paragraphs (b) and (c) of this section*, charging, AC adapters or battery eliminators the radio frequency voltage that is conducted back onto the AC power line on any frequency or frequencies, within the band 150 kHz to 30 MHz, shall not exceed the limits in the Table 7, as measured using a 50 μ H/50 ohms line impedance stabilization network (LISN). Compliance with the provisions of this paragraph shall be based on the measurement of the radio frequency voltage between each power line and ground at the power terminal. The lower limit applies at the boundary between the frequencies ranges.

Frequency range (MHz)	Class A Conducted Limits (dB μ V)		*Class B Conducted Limits (dB μ V)	
	Quasi-Peak	Average	Quasi-Peak	Average
* 0.15- 0.45	79	66	66 - 56	56 - 46
0.45 - 0.5	79	66	56	46
0.5 - 30	73	60	60	50

Note 1 — The lower limit shall apply at the transition frequencies.
 Note 2 — The limit decreases linearly with the logarithm if the frequency in the range 0.15 MHz to 0.5 MHz.
 * -- Limits per Subsection 15.207(a).

Table 7. Conducted Limits for Radio Frequency Devices calculated from FCC Part 15 Subsections 15.107(a) (b) and 15.207(a)

Test Results: The EUT was compliant with the Class A requirement(s) of this section. Measured emissions were below applicable limits.

Test Engineer(s): Jia Li

Test Date(s): 03/11/11

Conducted Emissions - Voltage, AC Power, Phase Line (120 VAC, 60 Hz)

Line	Freq (MHz)	QP Amplitude	QP Limit	Delta	Pass	Average Amplitude	Average Limit	Delta	Pass
120VAC Phase TX off	0.4212	45.87	79	-33.13	Pass	33.48	66	-32.52	Pass
120VAC Phase TX off	0.150	39.83	79	-39.17	Pass	28.732	66	-37.268	Pass
120VAC Phase TX off	29.34	23.301	73	-49.699	Pass	17.54	60	-42.46	Pass

Table 8. Conducted Emissions - Voltage, AC Power, Phase Line (120 VAC, 60 Hz)

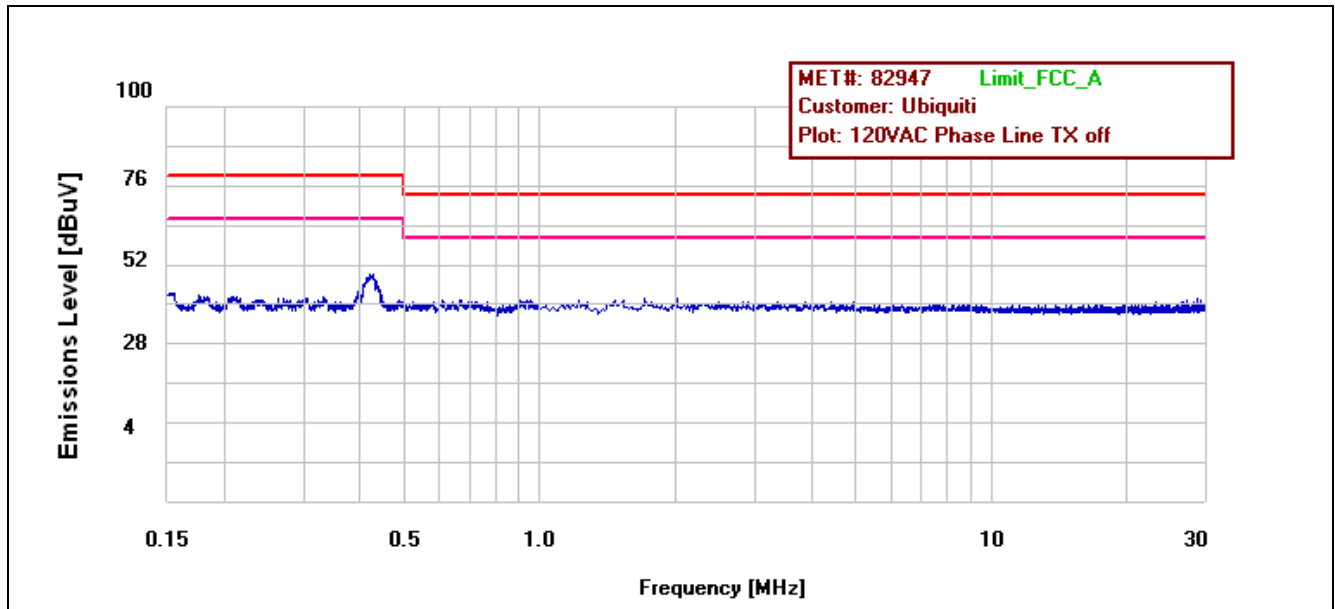

Plot 1. Conducted Emission, Phase Line Plot

Conducted Emissions - Voltage, AC Power, Neutral Line (120 VAC, 60 Hz)

Line	Freq (MHz)	QP Amplitude	QP Limit	Delta	Pass	Average Amplitude	Average Limit	Delta	Pass
120VAC NeutralTX off	0.4172	47.73	79	-31.27	Pass	36.19	66	-29.81	Pass
120VAC NeutralTX off	0.150	40.03	79	-38.97	Pass	29.867	66	-36.133	Pass
120VAC NeutralTX off	4.02	35.05	73	-37.95	Pass	28.133	60	-31.867	Pass

Table 9. Conducted Emissions - Voltage, AC Power, Neutral Line (120 VAC, 60 Hz)

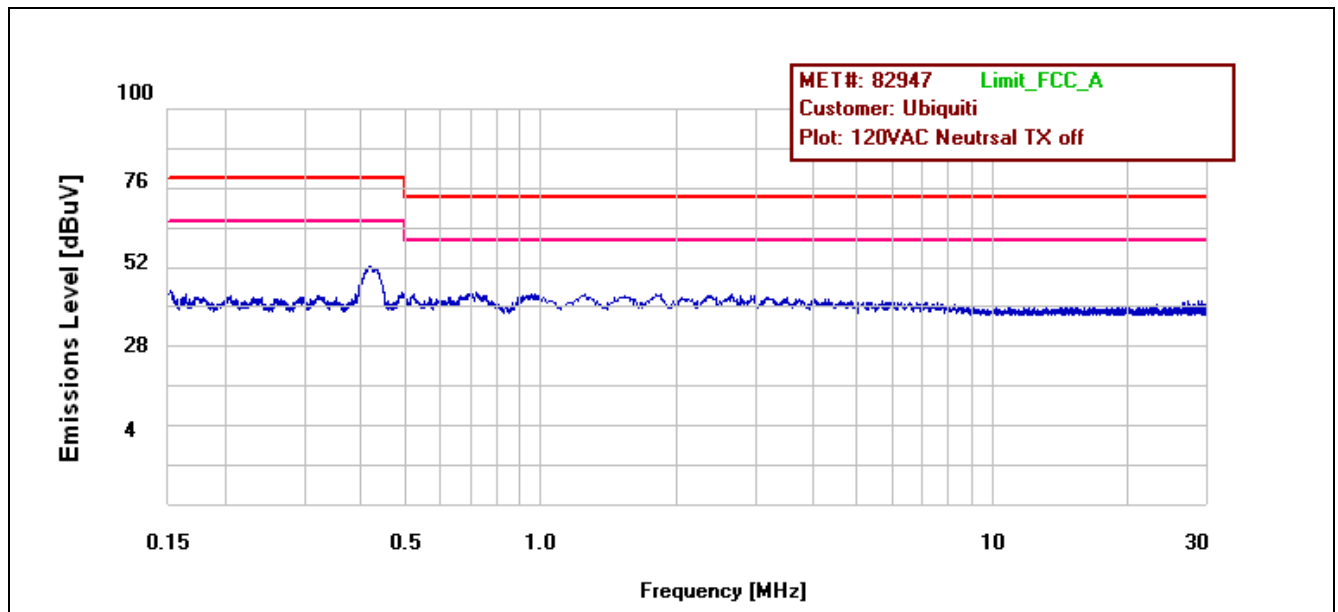

Plot 2. Conducted Emission, Neutral Line Plot

Conducted Emission Limits Test Setup

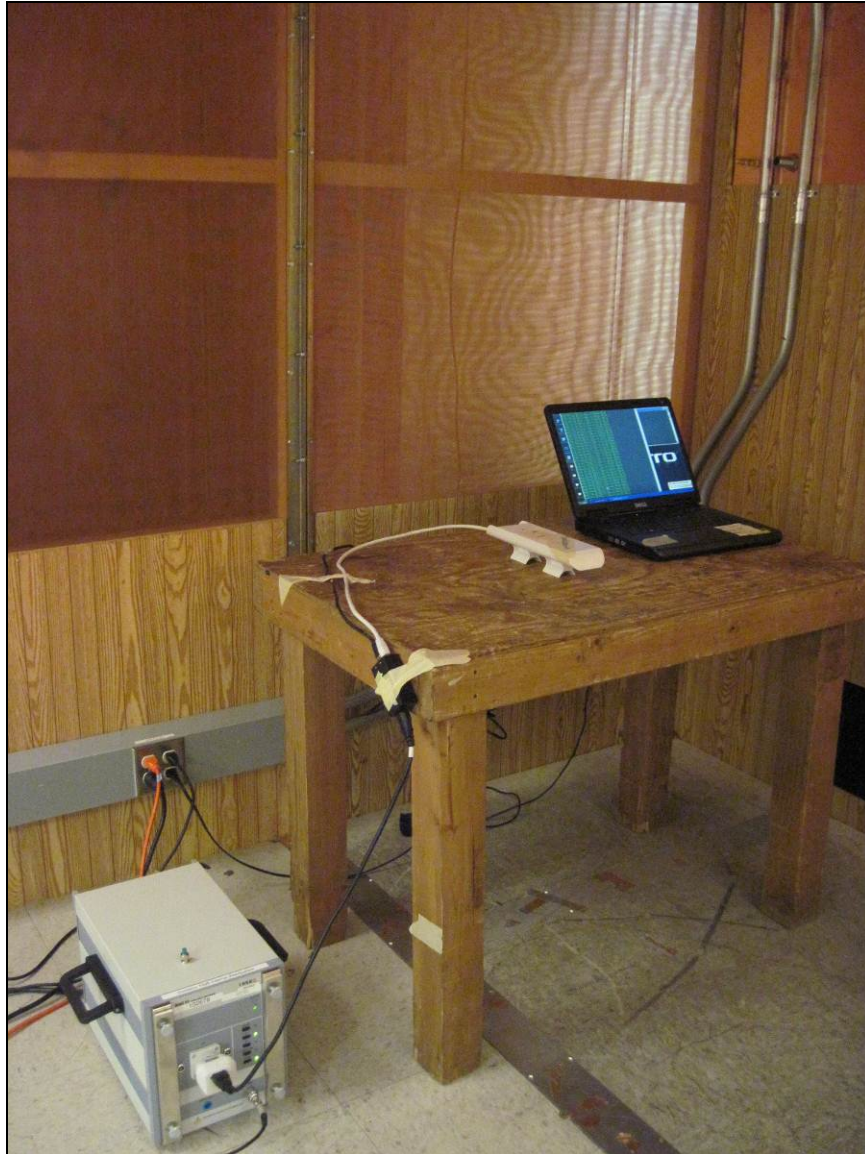

Photograph 3. Conducted Emissions, Test Setup

Radiated Emission Limits

§ 15.109 Radiated Emissions Limits

Test Requirement(s): **15.109 (a)** Except for Class A digital devices, the field strength of radiated emissions from unintentional radiators at a distance of 3 meters shall not exceed the Class B limits expressed in Table 10.

15.109 (b) The field strength of radiated emissions from a Class A digital device, as determined at a distance of 10 meters, shall not exceed the Class A limits expressed in Table 10.

Frequency (MHz)	Field Strength (dB μ V/m)	
	§15.109 (b), Class A Limit (dB μ V) @ 10m	§15.109 (a), Class B Limit (dB μ V) @ 3m
30 - 88	39.00	40.00
88 - 216	43.50	43.50
216 - 960	46.40	46.00
Above 960	49.50	54.00

Table 10. Radiated Emissions Limits calculated from FCC Part 15, §15.109 (a) (b)

Test Procedures: The EUT was placed on a non-metallic table, 80 cm above the ground plane inside a semi-anechoic chamber. The method of testing and test conditions of ANSI C63.4 were used. An antenna was located 10m from the EUT on an adjustable mast. A pre-scan was first performed in order to find prominent radiated emissions. For final emissions measurements at each frequency of interest, the EUT was rotated and the antenna height was varied between 1 m and 4 m in order to maximize the emission. Measurements in both horizontal and vertical polarities were made and the data was recorded. Unless otherwise specified, measurements were made using a quasi-peak detector with a 120 kHz bandwidth.

Test Results: The EUT was compliant with the Class A requirement(s) of this section. Measured emissions were below applicable limits.

Test Engineer(s): Lionel Gabrillo

Test Date(s): 03/16/11

Radiated Emissions Limits Test Results, Class A

Frequency (MHz)	Antenna Polarity	EUT Azimuth (Degrees)	Antenna Height (cm)	Uncorrected Amplitude (dBuV)	ACF (dB/m)	Pre Amp Gain (dB)	CBL (dB)	DCF (dB)	Corrected Amplitude (dBuV)	Limit (dBuV)	Margin (dB)
55.88	V	103.6	100.0	55.46	6.812	40	1.174	0	23.446	39	-15.554
36.12	V	201.0	100.0	43.15	13.628	40	0.955	0	17.733	39	-21.267
98.44	V	255.3	100.0	45.87	11.088	40	1.542	0	18.5	43.5	-25
780.02	V	215.7	165.9	39.47	20.1	40	4.693	0	24.263	46.4	-22.137
779.97	H	121.9	100.0	43.22	19.798	40	4.693	0	27.711	46.4	-18.689
33.76	H	0	100.0	39.16	16.296	40	0.965	0	16.421	39	-22.579

Table 11. Radiated Emissions Limits, Test Results, FCC Limits

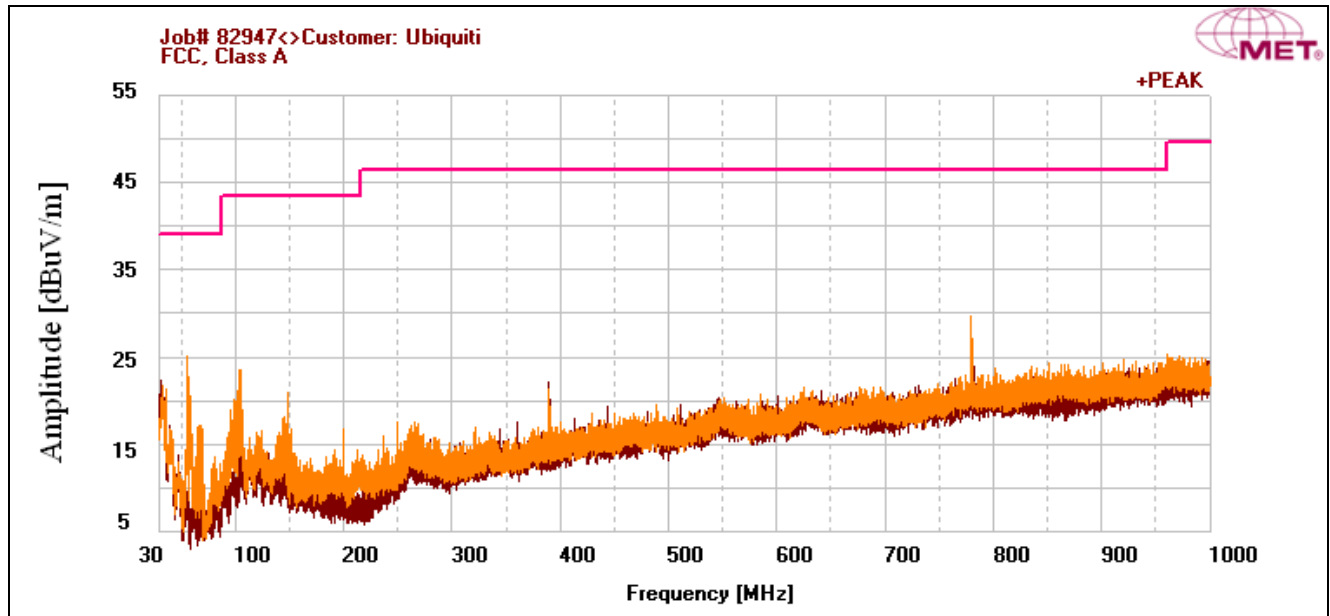

Plot 3. Radiated Emissions, 30 MHz - 1 GHz, FCC Limits

Radiated Emissions Limits Test Results, Class A

Frequency (MHz)	Antenna Polarity	EUT Azimuth (Degrees)	Antenna Height (cm)	Uncorrected Amplitude (dBuV)	ACF (dB/m)	Pre Amp Gain (dB)	CBL (dB)	DCF (dB)	Corrected Amplitude (dBuV)	Limit (dBuV)	Margin (dB)
55.88	V	103.6	100.0	55.46	6.812	40	1.174	0	23.446	40	-16.554
36.12	V	201.0	100.0	43.15	13.628	40	0.955	0	17.733	40	-22.267
98.44	V	255.3	100.0	45.87	11.088	40	1.542	0	18.5	40	-21.5
780.02	V	215.7	165.9	39.47	20.1	40	4.693	0	24.263	47	-22.737
779.97	H	121.9	100.0	43.22	19.798	40	4.693	0	27.711	47	-19.289
33.76	H	0	100.0	39.16	16.296	40	0.965	0	16.421	40	-23.579

Table 12. Radiated Emissions Limits, Test Results, ICES-003 Limits

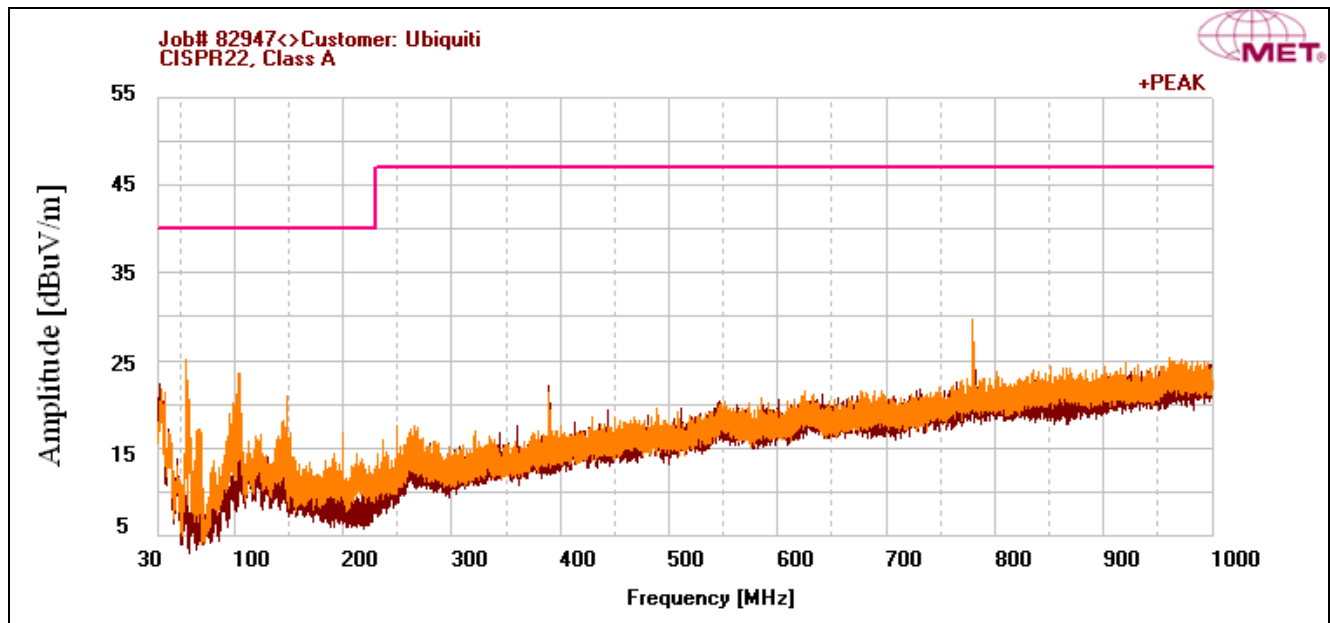

Plot 4. Radiated Emissions, ICES-003 Limits

Radiated Emission Limits Test Setup



Photograph 4. Radiated Emission, Test Setup

IV. Electromagnetic Compatibility Criteria for Intentional Radiators

Electromagnetic Compatibility Criteria for Intentional Radiators

§ 15.203 Antenna Requirement

Test Requirement: § 15.203: An intentional radiator shall be designed to ensure that no antenna other than that furnished by the responsible party shall be used with the device. The use of a permanently attached antenna or of an antenna that uses a unique coupling to the intentional radiator shall be considered sufficient to comply with the provisions of this section. The manufacturer may design the unit so that a broken antenna can be replaced by the user, but the use of a standard antenna jack or electrical connector is prohibited.

The structure and application of the EUT were analyzed to determine compliance with Section 15.203 of the Rules. Section 15.203 states that the subject device must meet at least one of the following criteria:

- a.) Antenna must be permanently attached to the unit.
- b.) Antenna must use a unique type of connector to attach to the EUT.
- c.) Unit must be professionally installed. Installer shall be responsible for verifying that the correct antenna is employed with the unit.

Results: The EUT as tested is compliant the criteria of §15.203. The EUT has an integral antenna.

Test Engineer(s): Lionel Gabrillo

Test Date(s): 03/16/11

Electromagnetic Compatibility Criteria for Intentional Radiators

§ 15.207(a) Conducted Emissions Limits

Test Requirement(s): § 15.207 (a): For an intentional radiator that is designed to be connected to the public utility (AC) power line, the radio frequency voltage that is conducted back onto the AC power line on any frequency or frequencies, within the band 150 kHz to 30MHz, shall not exceed the limits in the following table, as measured using a 50 μ H/50 Ω line impedance stabilization network (LISN). Compliance with the provisions of this paragraph shall be based on the measurement of the radio frequency voltage between each power line and ground at the power terminal. The lower limit applies at the boundary between the frequency ranges.

Frequency range (MHz)	§ 15.207(a), Conducted Limit (dB μ V)	
	Quasi-Peak	Average
* 0.15- 0.45	66 - 56	56 - 46
0.45 - 0.5	56	46
0.5 - 30	60	50

Table 13. Conducted Limits for Intentional Radiators from FCC Part 15 § 15.207(a)

Test Procedure: The EUT was placed on a 0.8 m-high wooden table inside a screen room. The EUT was situated such that the back of the EUT was 0.4 m from one wall of the vertical ground plane, and the remaining sides of the EUT were no closer than 0.8 m from any other conductive surface. The EUT was powered from a 50 Ω /50 μ H Line Impedance Stabilization Network (LISN). The EMC receiver scanned the frequency range from 150 kHz to 30 MHz. Conducted Emissions measurements were made in accordance with *ANSI C63.4-2003 "Methods and Measurements of Radio-Noise Emissions from Low-Voltage Electrical and Electronic Equipment in the Range of 9kHz to 40 GHz"*. The measurements were performed over the frequency range of 0.15 MHz to 30 MHz using a 50 Ω /50 μ H LISN as the input transducer to an EMC/field intensity meter. For the purpose of this testing, the transmitter was turned on. Scans were performed with the transmitter on.

Test Results: The EUT was compliant with this requirement. Measured emissions were below applicable limits.

Test Engineer(s): Jia Li

Test Date(s): 02/14/11

15.207(a) Conducted Emissions Test Results

Line	Freq (MHz)	QP Amplitude	QP Limit	Delta	Pass	Average Amplitude	Average Limit	Delta	Pass
120VAC Line	0.494	47.1	56.103	-9.003	Pass	35.02	46.103	-11.083	Pass
120VAC Line	2.428	42.11	56	-13.89	Pass	27.2	46	-18.8	Pass
120VAC Line	1.188	42.31	56	-13.69	Pass	26.13	46	-19.87	Pass
120VAC Line	0.748	45.3	56	-10.7	Pass	31.74	46	-14.26	Pass

Table 14. Conducted Emissions, 15.207(a), Phase Line, Test Results

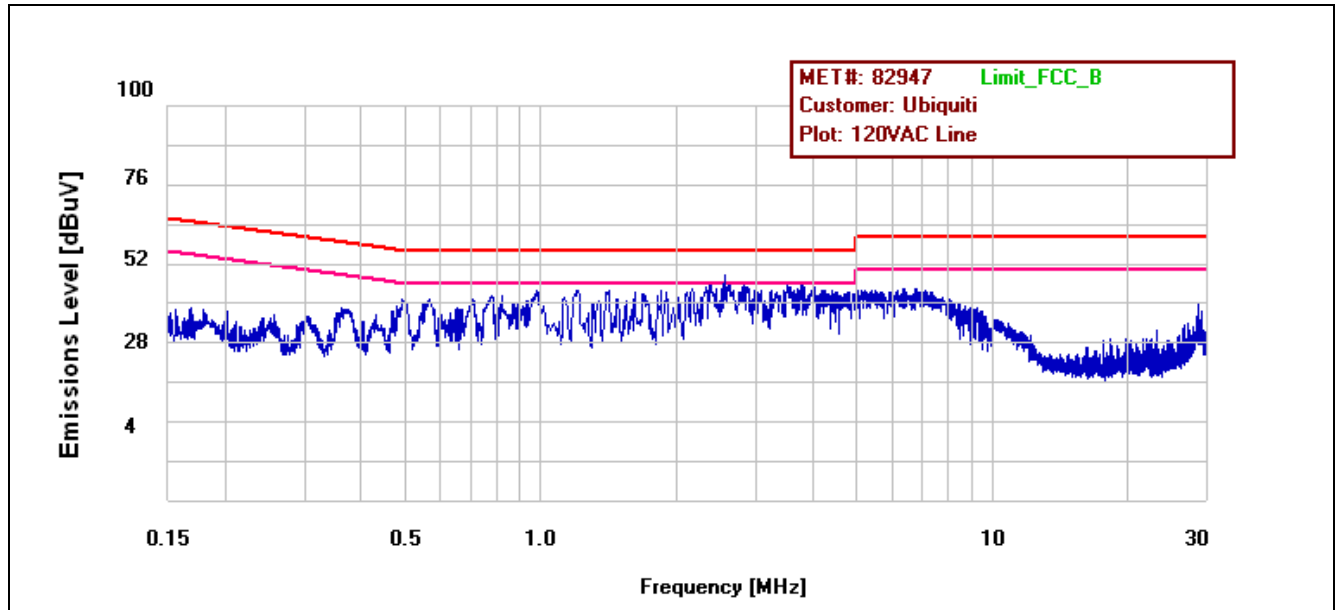

Plot 5. Conducted Emissions, 15.207(a), Phase Line

15.207(a) Conducted Emissions Test Results

Line	Freq. (MHz)	QP Amplitude	QP Limit	Delta	Pass	Average Amplitude	Average Limit	Delta	Pass
120VAC Neutral	0.970	33.36	56	-22.64	Pass	26.71	46	-19.29	Pass
120VAC Neutral	2.448	34.57	56	-21.43	Pass	22.01	46	-23.99	Pass

Table 15. Conducted Emissions, 15.207(a), Neutral Line, Test Results

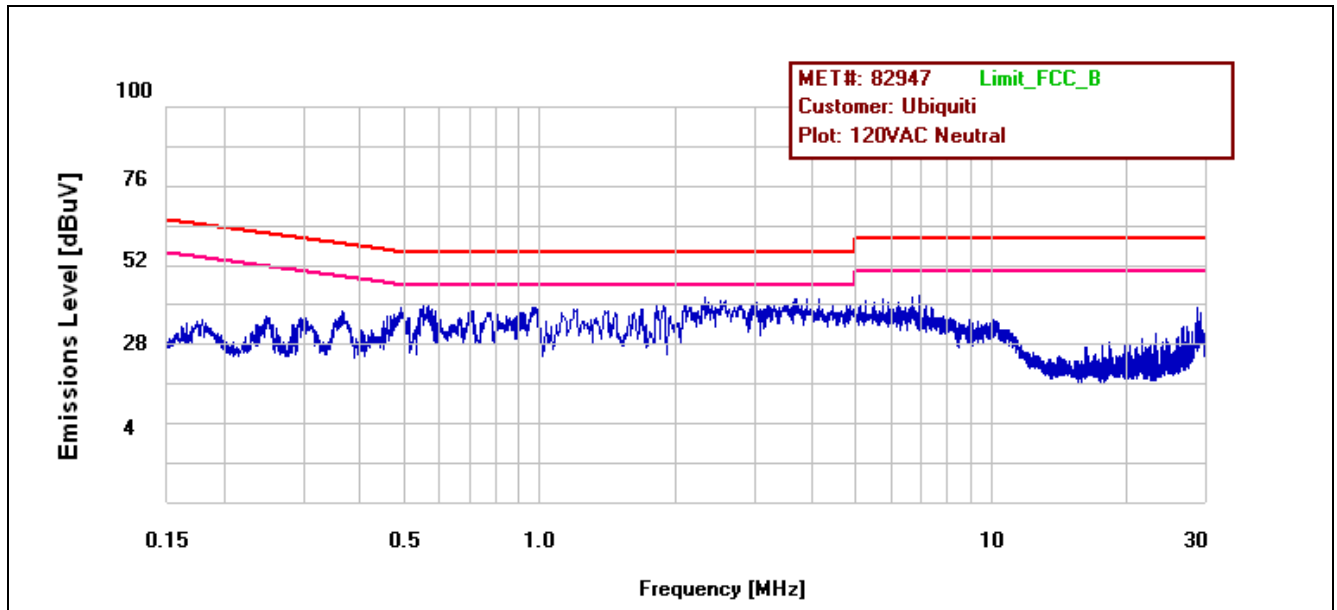

Plot 6. Conducted Emissions, 15.207(a), Neutral Line

15.207(a) Conducted Emissions Test Setup Photo

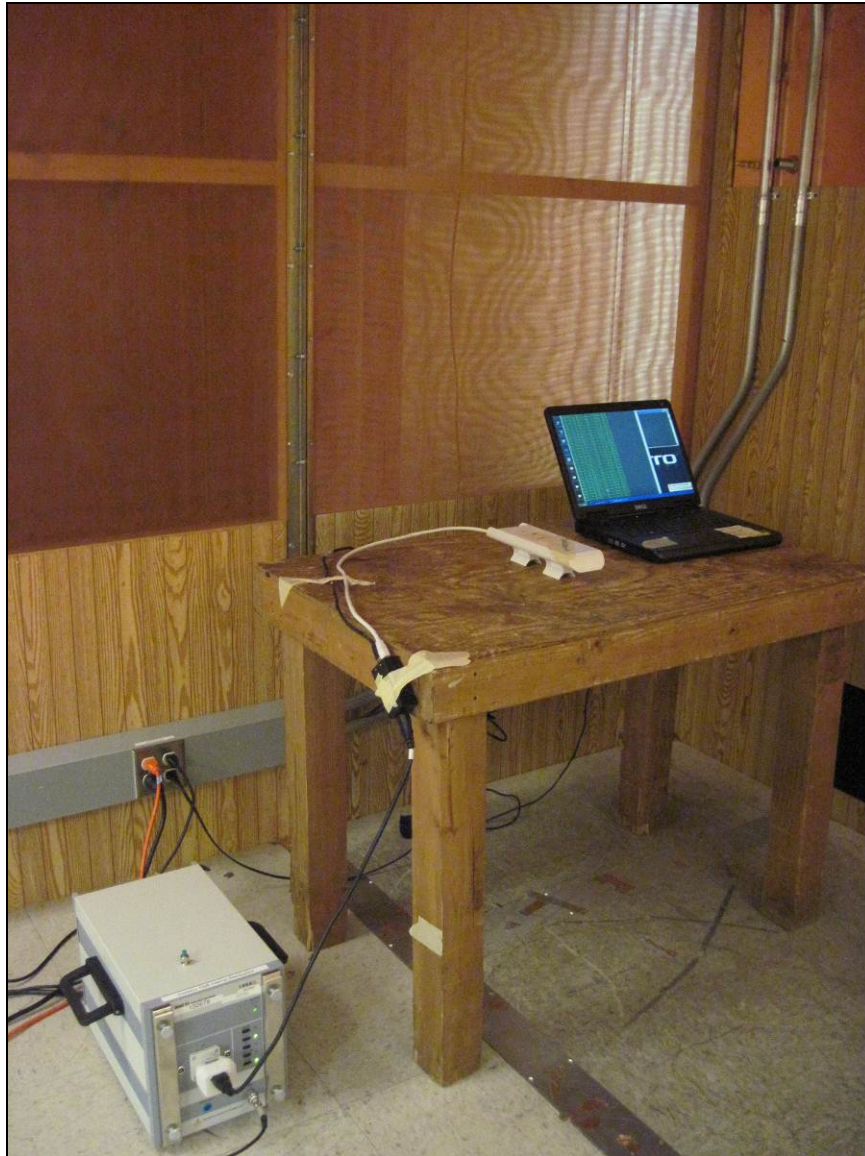

Photograph 5. Conducted Emissions, 15.207(a), Test Setup

Electromagnetic Compatibility Criteria for Intentional Radiators

§ 15.247(a)(2) 6 dB and 99% Bandwidth

Test Requirements: § 15.247(a)(2): Operation under the provisions of this section is limited to frequency hopping and digitally modulated intentional radiators that comply with the following provisions:

For systems using digital modulation techniques, the EUT may operate in the 902-928 MHz, 2400-2483.5 MHz and 5725-5850 MHz bands. The minimum 6dB bandwidth shall be at least 500 kHz.

Test Procedure: The transmitter was on and transmitting at the highest output power. The bandwidth of the fundamental frequency was measured with the spectrum analyzer using a RBW approximately 1% of the total emission bandwidth, VBW > RBW. The 6 dB Bandwidth was measured and recorded. The measurements were performed on the low, mid and high channels.

Test Results The EUT was compliant with § 15.247 (a)(2).

The 6 dB and 99% Bandwidth was determined from the plots on the following pages.

Test Engineer(s): Kenshi Chung

Test Date(s): 03/07/11

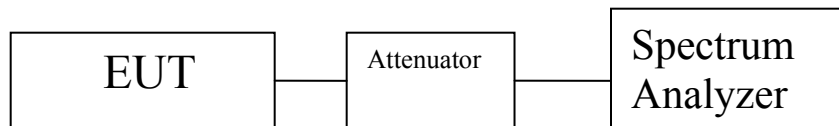

Figure 2. Block Diagram, Occupied Bandwidth Test Setup

Occupied Bandwidth Test Results

Occupied Bandwidth			
	Carrier Channel	Frequency (MHz)	Measured 6 dB Bandwidth (MHz)
802.11a 20 MHz	Low	5735	16.478
	Mid	5787	16.425
	High	5840	16.403
802.11a 40 MHz	Low	5747	36.311
	Mid	5787	36.106
	High	5828	36.226
802.11n HT5	Low	5728	3.732
	Mid	5787	3.986
	High	5847	4.125
802.11n HT8	Low	5730	6.580
	Mid	5787	6.291
	High	5845	6.279
802.11n HT10	Low	5731	8.267
	Mid	5787	8.046
	High	5844	8.075
802.11n HT20	Low	5735	16.547
	Mid	5787	16.507
	High	5840	16.459
802.11n HT30	Low	5740	23.700
	Mid	5787	24.779
	High	5835	24.694
802.11n HT40	Low	5747	35.700
	Mid	5787	35.481
	High	5825	35.861

Table 16. 6 dB Occupied Bandwidth, Test Results, Port 1

Occupied Bandwidth			
	Carrier Channel	Frequency (MHz)	Measured 6 dB Bandwidth (MHz)
802.11n HT5	Low	5728	4.107
	Mid	5787	4.050
	High	5847	4.066
802.11n HT8	Low	5730	6.532
	Mid	5787	6.343
	High	5845	6.348
802.11n HT10	Low	5731	8.133
	Mid	5787	8.274
	High	5844	8.081
802.11n HT20	Low	5735	16.622
	Mid	5787	16.427
	High	5840	16.430
802.11n HT30	Low	5740	24.359
	Mid	5787	24.852
	High	5835	24.021
802.11n HT40	Low	5747	36.320
	Mid	5787	34.821
	High	5828	32.810

Table 17. 6 dB Occupied Bandwidth, Test Results, Port 2

Occupied Bandwidth			
	Carrier Channel	Frequency (MHz)	Measured 99% Bandwidth (MHz)
802.11a HT20	Low	5735	16.5909
	Mid	5787	16.7141
	High	5840	16.5767
802.11a HT40	Low	5747	36.5672
	Mid	5787	36.5006
	High	5828	36.6789
802.11n HT5	Low	5728	4.2028
	Mid	5787	4.1694
	High	5847	4.1891
802.11n HT8	Low	5730	6.6443
	Mid	5787	6.4152
	High	5845	6.3716
802.11n HT10	Low	5731	8.4097
	Mid	5787	8.3516
	High	5844	8.5355
802.11n HT20	Low	5735	16.6151
	Mid	5787	16.6719
	High	5840	16.4859
802.11n HT30	Low	5740	25.5714
	Mid	5787	25.3596
	High	5835	25.3428
802.11n HT40	Low	5747	37.6545
	Mid	5787	38.0328
	High	5825	37.4100

Table 18. 99% Occupied Bandwidth, Test Results, Port 1

Occupied Bandwidth			
	Carrier Channel	Frequency (MHz)	Measured 99% Bandwidth (MHz)
802.11n HT5	Low	5728	4.1706
	Mid	5787	4.1903
	High	5847	4.2137
802.11n HT8	Low	5730	6.6825
	Mid	5787	6.3752
	High	5845	6.3953
802.11n HT10	Low	5731	8.4338
	Mid	5787	8.4756
	High	5844	8.3231
802.11n HT20	Low	5735	16.4941
	Mid	5787	16.5641
	High	5840	16.5715
802.11n HT30	Low	5740	25.7895
	Mid	5787	25.2524
	High	5835	25.2417
802.11n HT40	Low	5747	38.1028
	Mid	5787	40.1487
	High	5828	38.8375

Table 19. 99% Occupied Bandwidth, Test Results, Port 2

6 dB Occupied Bandwidth Test Results, 802.11a 20 MHz

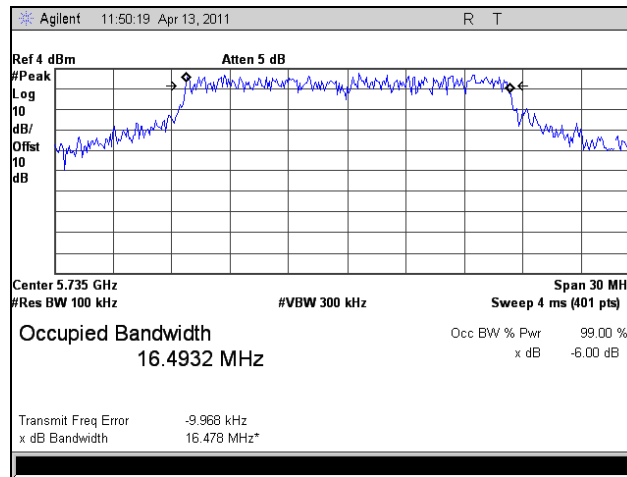

Plot 7. 6 dB Occupied Bandwidth, Low Channel, 802.11a 20MHz

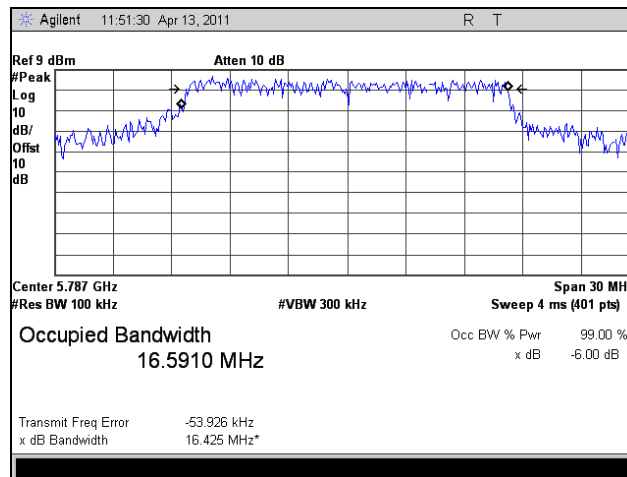

Plot 8. 6 dB Occupied Bandwidth, Mid Channel, 802.11a 20MHz

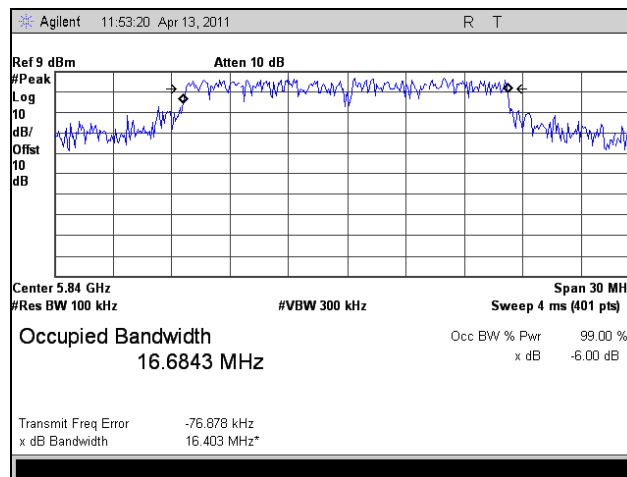

Plot 9. 6 dB Occupied Bandwidth, High Channel, 802.11a 20MHz

6 dB Occupied Bandwidth Test Results, 802.11a 40 MHz

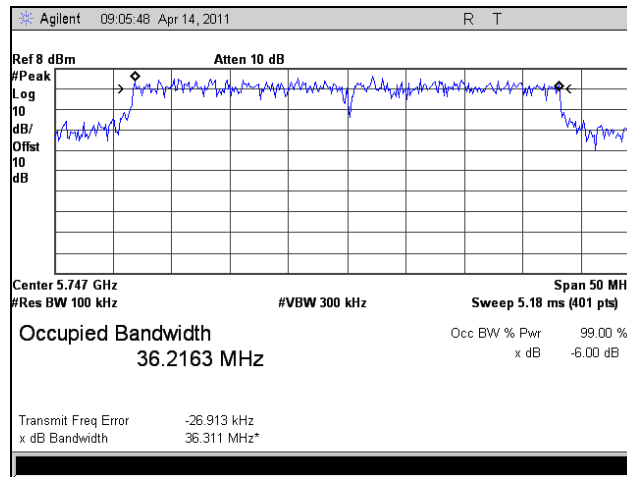

Plot 10. 6 dB Occupied Bandwidth, Low Channel, 802.11a 40 MHz

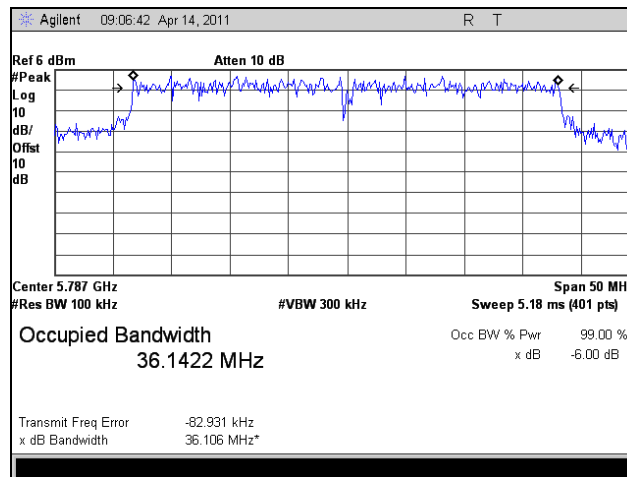

Plot 11. 6 dB Occupied Bandwidth, Mid Channel, 802.11a 40 MHz

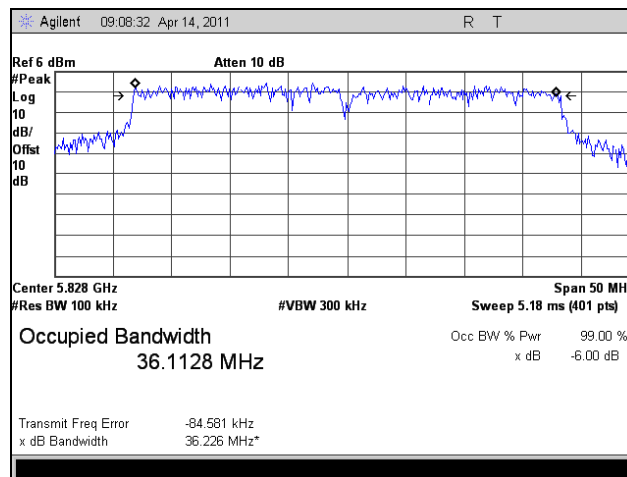

Plot 12. 6 dB Occupied Bandwidth, High Channel, 802.11a 40 MHz

6 dB Occupied Bandwidth Test Results, 802.11n HT5, Port 1

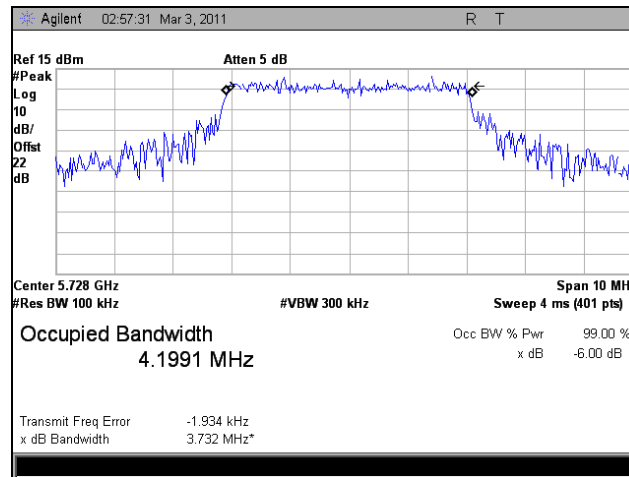

Plot 13. 6 dB Occupied Bandwidth, Low Channel, 802.11n HT5, Port 1

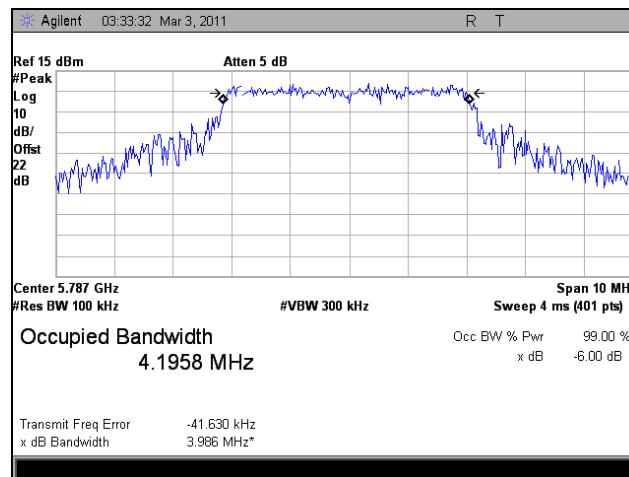

Plot 14. 6 dB Occupied Bandwidth, Mid Channel, 802.11n HT5, Port 1

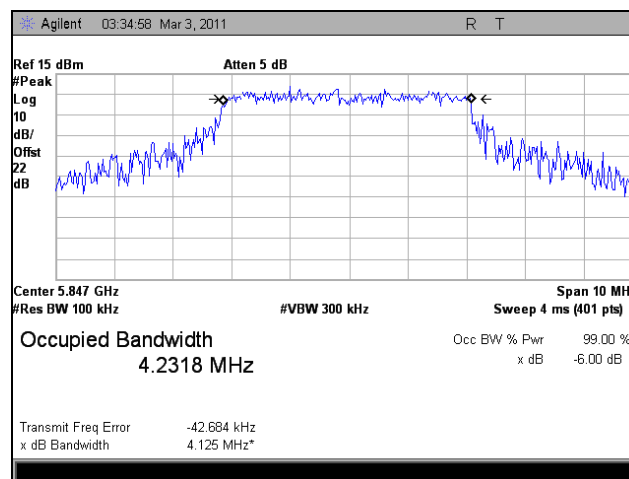

Plot 15. 6 dB Occupied Bandwidth, High Channel, 802.11n HT5, Port 1

6 dB Occupied Bandwidth Test Results, 802.11n HT5, Port 2

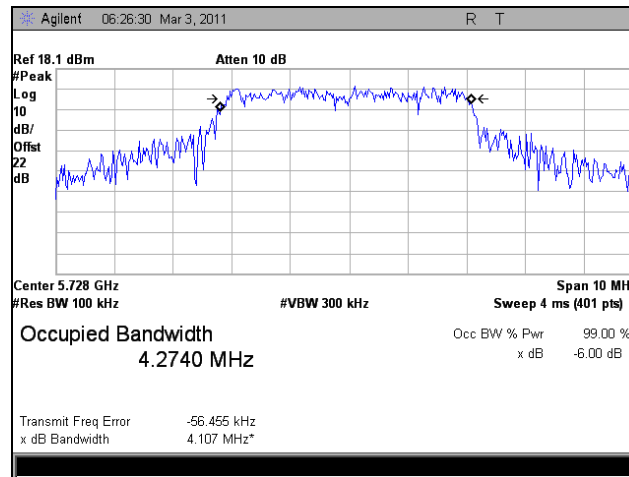

Plot 16. 6 dB Occupied Bandwidth, Low Channel, 802.11n HT5, Port 2

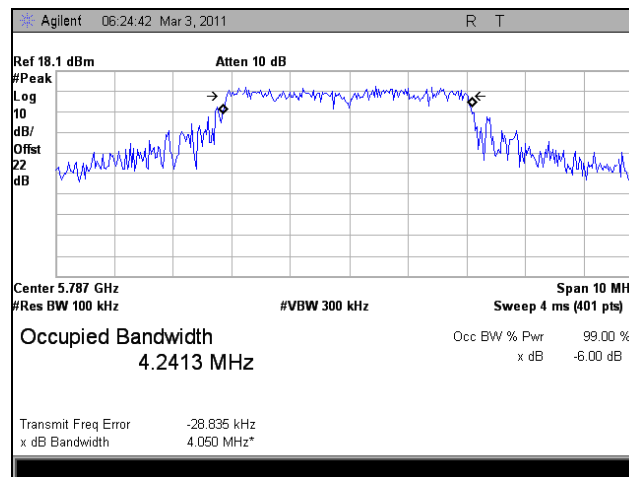

Plot 17. 6 dB Occupied Bandwidth, Mid Channel, 802.11n HT5, Port 2

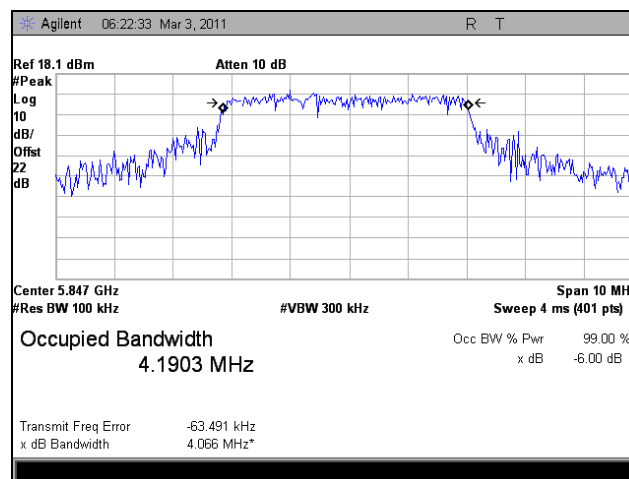

Plot 18. 6 dB Occupied Bandwidth, High Channel, 802.11n HT5, Port 2

6 dB Occupied Bandwidth Test Results, 802.11n HT8, Port 1

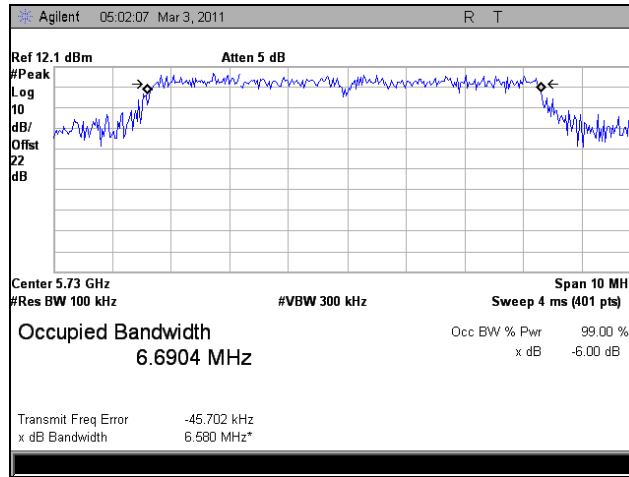

Plot 19. 6 dB Occupied Bandwidth, Low Channel, 802.11n HT8, Port 1

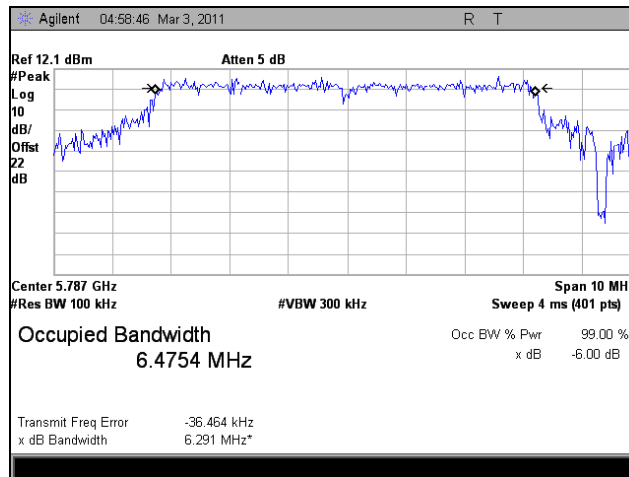

Plot 20. 6 dB Occupied Bandwidth, Mid Channel, 802.11n HT8, Port 1

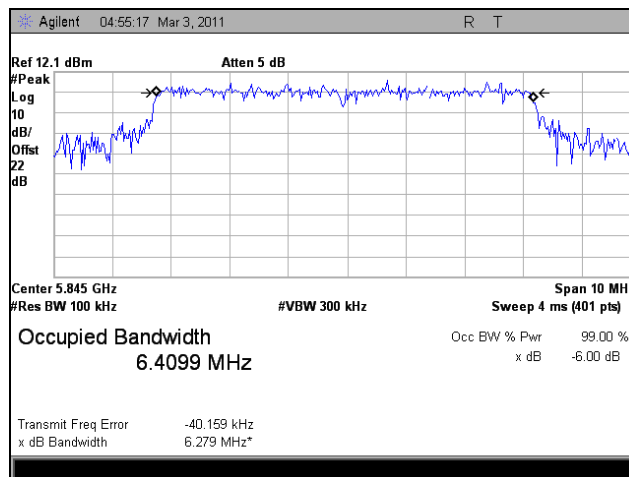

Plot 21. 6 dB Occupied Bandwidth, High Channel, 802.11n HT8, Port 1

6 dB Occupied Bandwidth Test Results, 802.11n HT8, Port 2

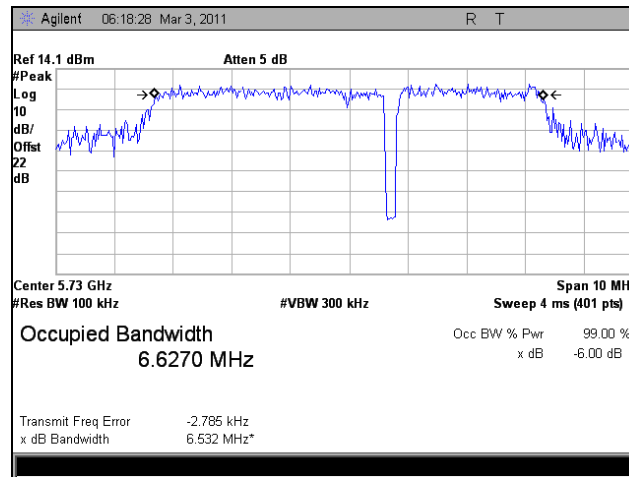

Plot 22. 6 dB Occupied Bandwidth, Low Channel, 802.11n HT8, Port 2

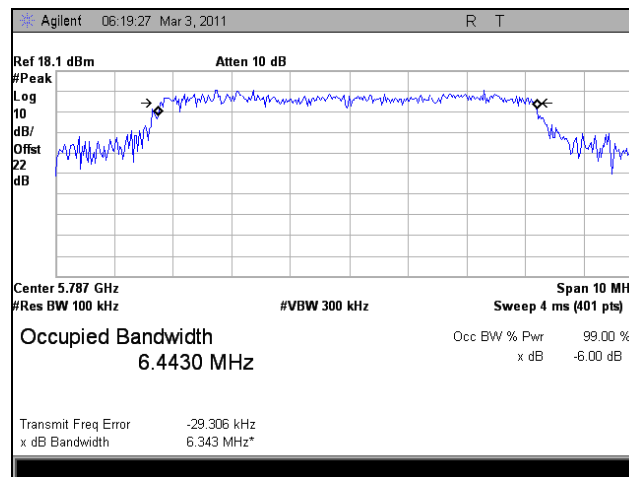

Plot 23. 6 dB Occupied Bandwidth, Mid Channel, 802.11n HT8, Port 2

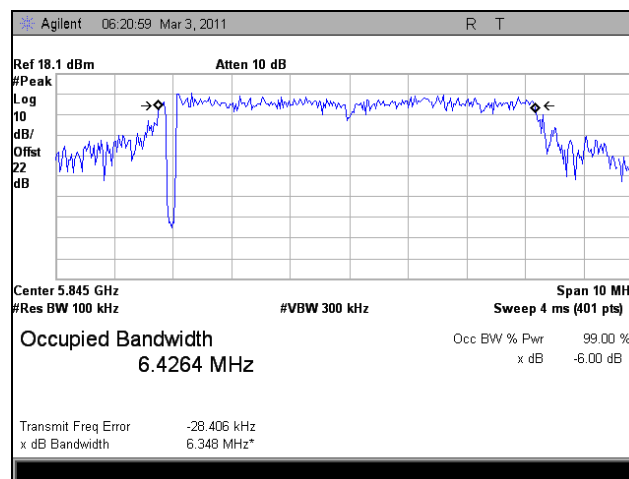

Plot 24. 6 dB Occupied Bandwidth, High Channel, 802.11n HT8, Port 2

6 dB Occupied Bandwidth Test Results, 802.11n HT10, Port 1

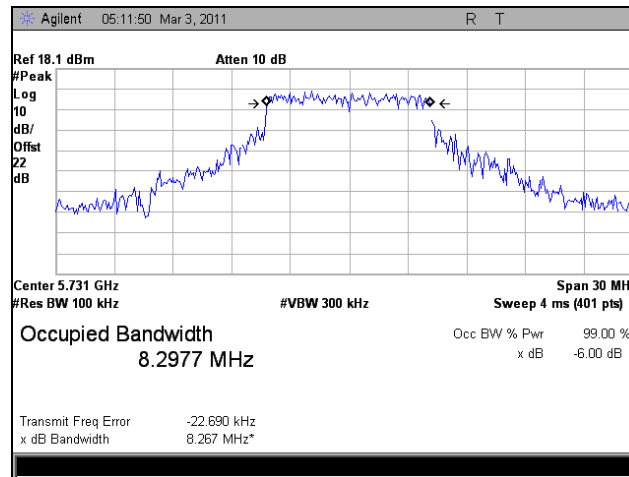

Plot 25. 6 dB Occupied Bandwidth, Low Channel, 802.11n HT10, Port 1

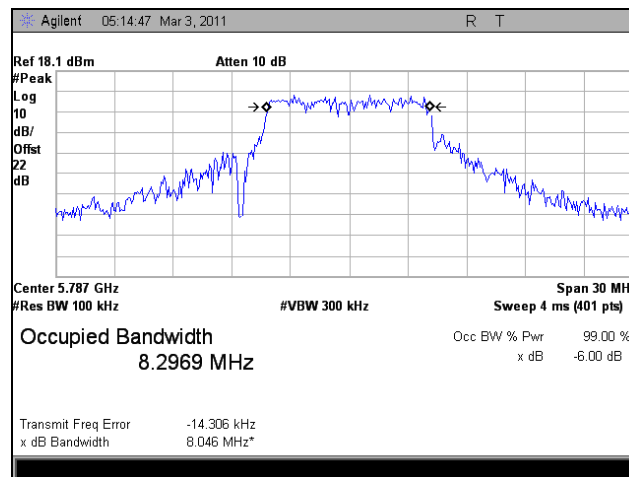

Plot 26. 6 dB Occupied Bandwidth, Mid Channel, 802.11n HT10, Port 1

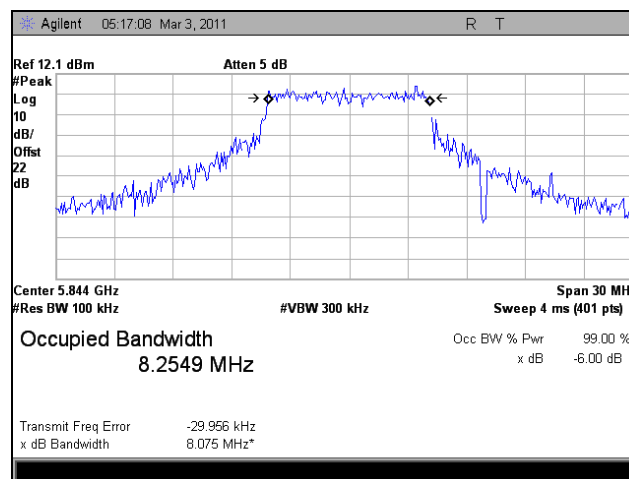

Plot 27. 6 dB Occupied Bandwidth, High Channel, 802.11n HT10, Port 1

6 dB Occupied Bandwidth Test Results, 802.11n HT10, Port 2

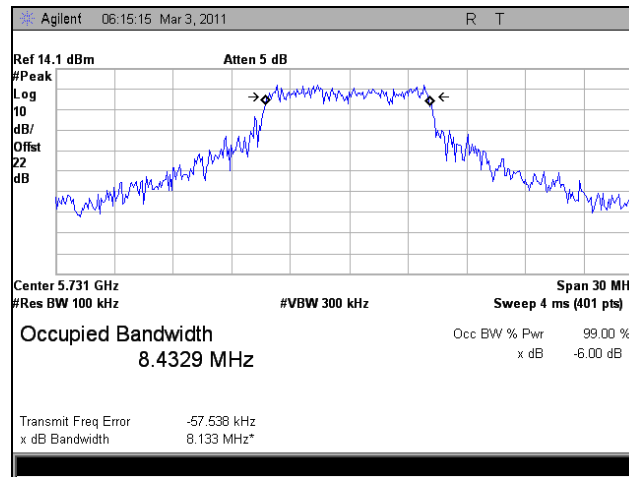

Plot 28. 6 dB Occupied Bandwidth, Low Channel, 802.11n HT10, Port 2

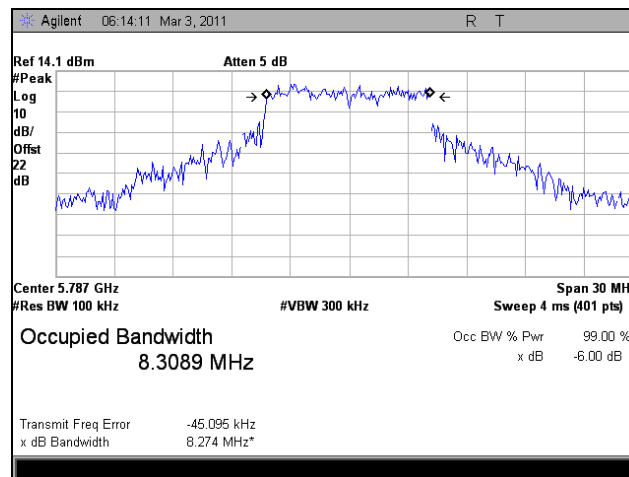

Plot 29. 6 dB Occupied Bandwidth, Mid Channel, 802.11n HT10, Port 2

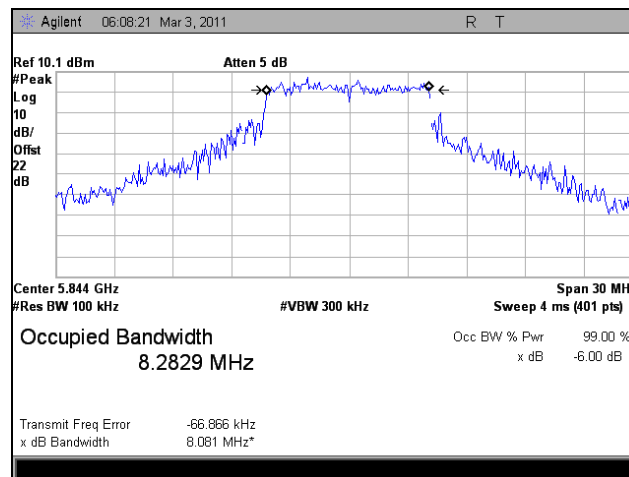

Plot 30. 6 dB Occupied Bandwidth, High Channel, 802.11n HT10, Port 2

6 dB Occupied Bandwidth Test Results, 802.11n HT20, Port 1

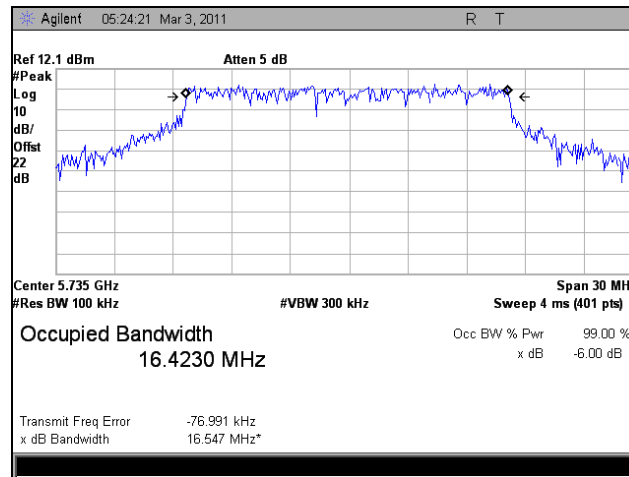

Plot 31. 6 dB Occupied Bandwidth, Low Channel, 802.11n HT20, Port 1

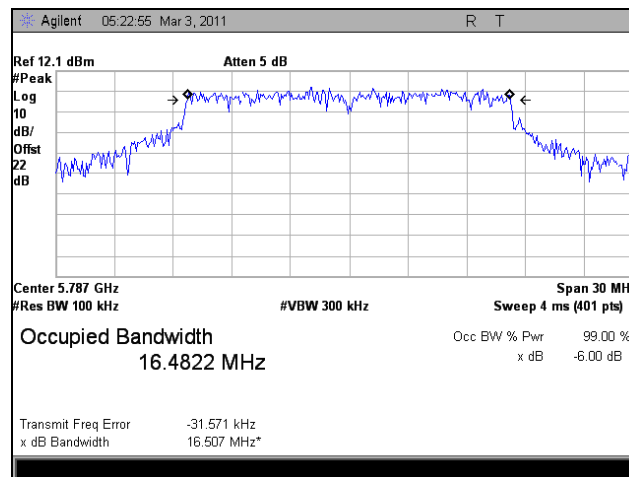

Plot 32. 6 dB Occupied Bandwidth, Mid Channel, 802.11n HT20, Port 1

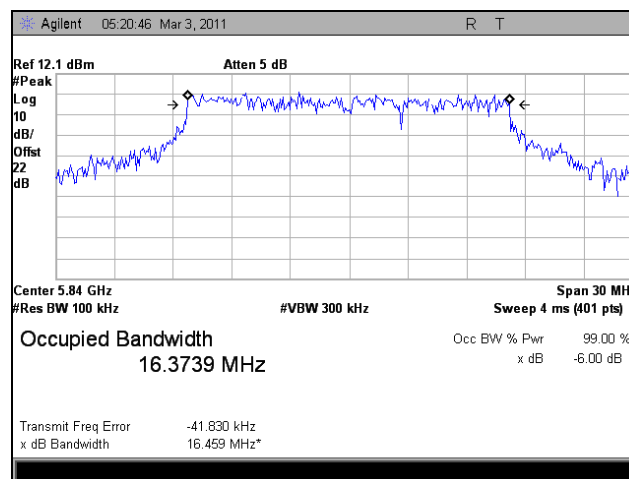

Plot 33. 6 dB Occupied Bandwidth, High Channel, 802.11n HT20, Port 1

6 dB Occupied Bandwidth Test Results, 802.11n HT20, Port 2

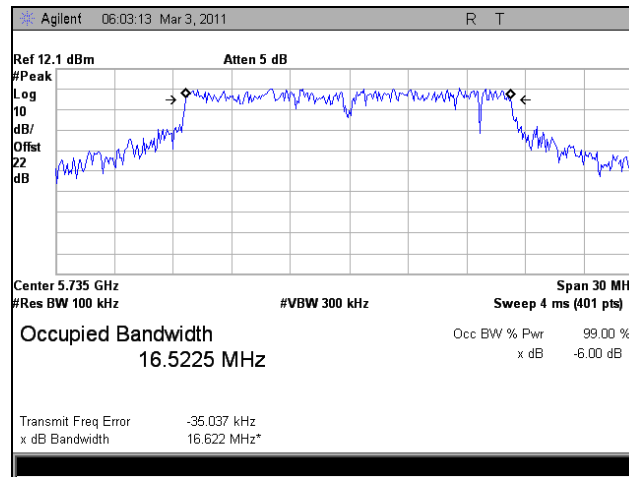

Plot 34. 6 dB Occupied Bandwidth, Low Channel, 802.11n HT20, Port 2

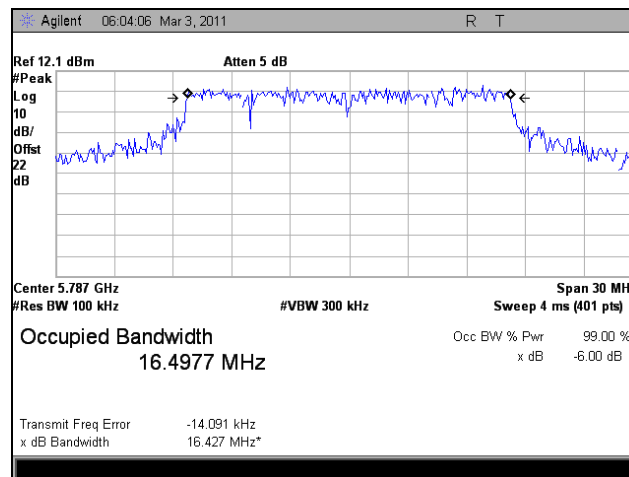

Plot 35. 6 dB Occupied Bandwidth, Mid Channel, 802.11n HT20, Port 2

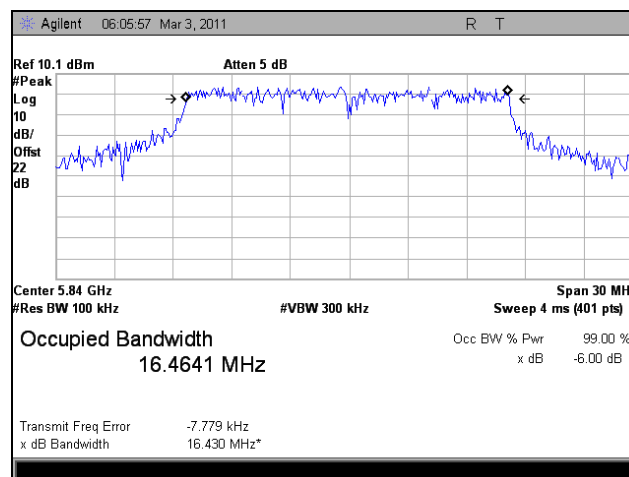

Plot 36. 6 dB Occupied Bandwidth, High Channel, 802.11n HT20, Port 2

6 dB Occupied Bandwidth Test Results, 802.11n HT30, Port 1

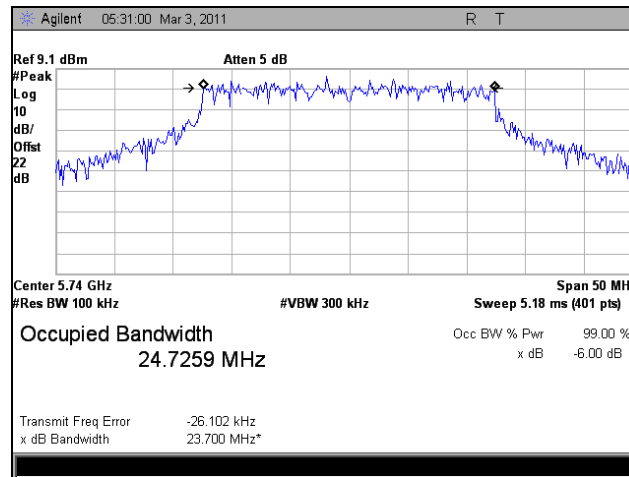

Plot 37. 6 dB Occupied Bandwidth, Low Channel, 802.11n HT30, Port 1

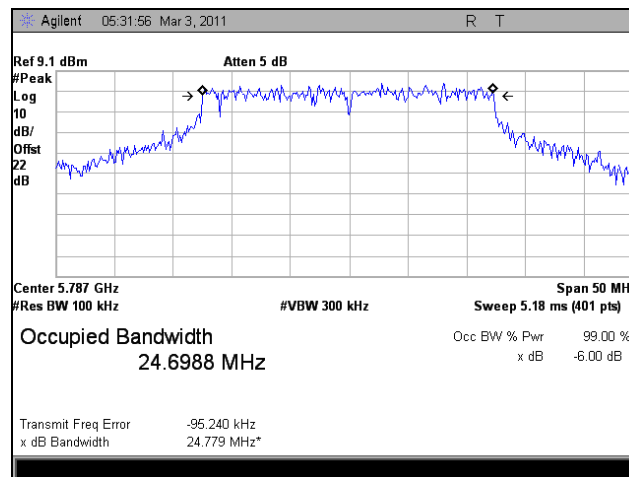

Plot 38. 6 dB Occupied Bandwidth, Mid Channel, 802.11n HT30, Port 1

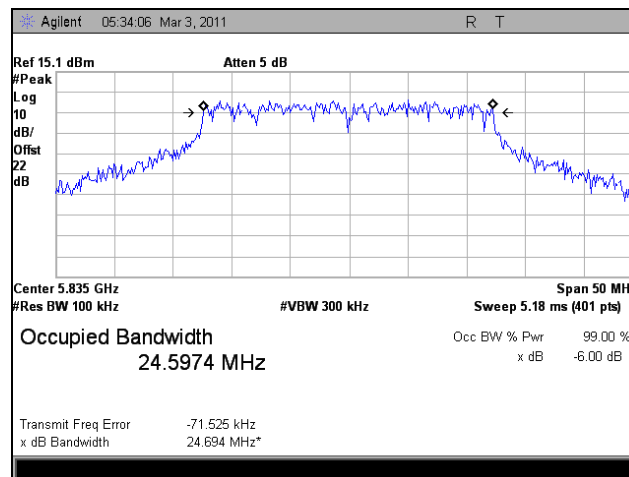

Plot 39. 6 dB Occupied Bandwidth, High Channel, 802.11n HT30, Port 1

6 dB Occupied Bandwidth Test Results, 802.11n HT30, Port 2

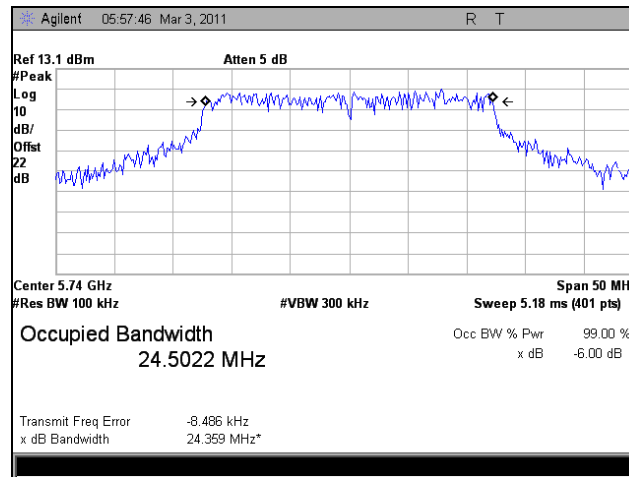

Plot 40. 6 dB Occupied Bandwidth, Low Channel, 802.11n HT30, Port 2

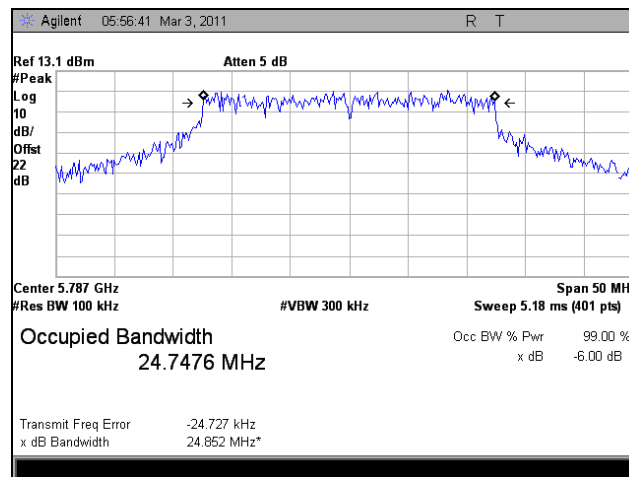

Plot 41. 6 dB Occupied Bandwidth, Mid Channel, 802.11n HT30, Port 2

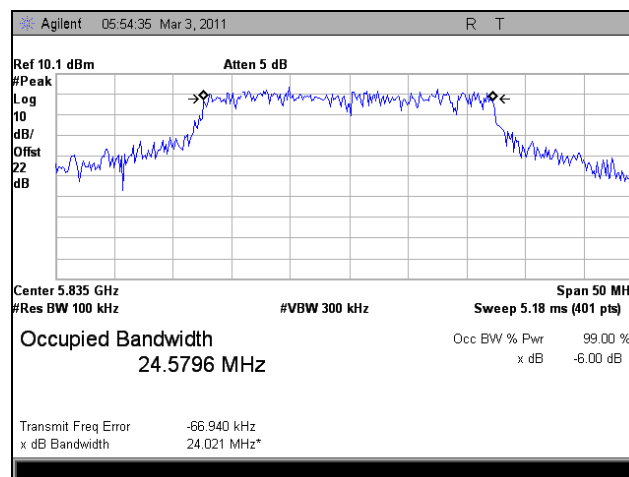

Plot 42. 6 dB Occupied Bandwidth, High Channel, 802.11n HT30, Port 2

6 dB Occupied Bandwidth Test Results, 802.11n HT40, Port 1

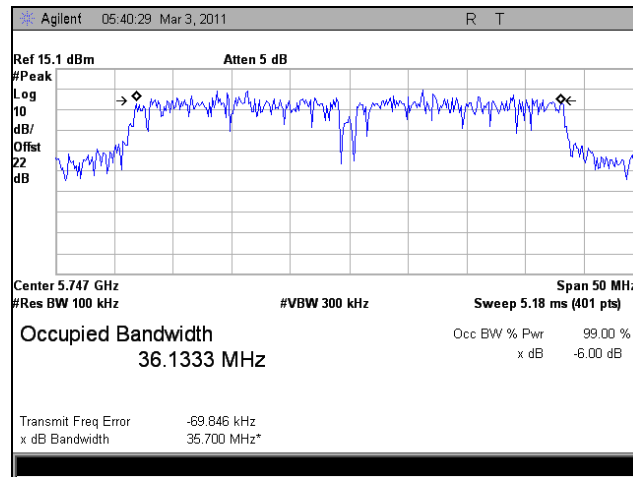

Plot 43. 6 dB Occupied Bandwidth, Low Channel, 802.11n HT40, Port 1

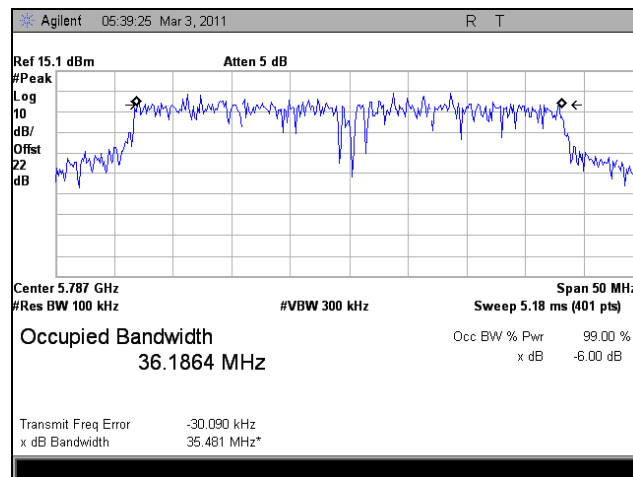

Plot 44. 6 dB Occupied Bandwidth, Mid Channel, 802.11n HT40, Port 1

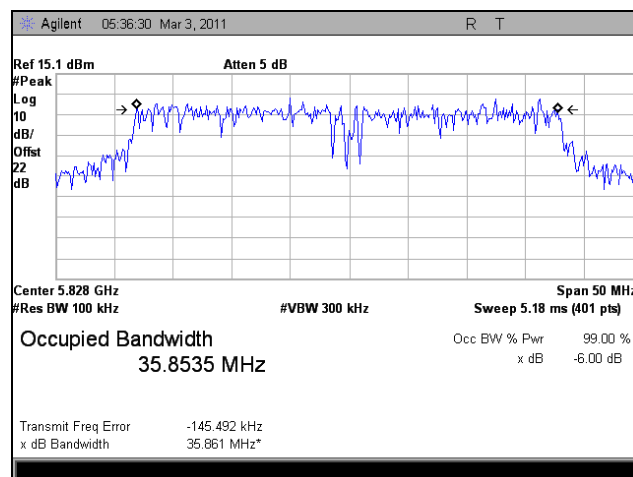

Plot 45. 6 dB Occupied Bandwidth, High Channel, 802.11n HT40, Port 1

6 dB Occupied Bandwidth Test Results, 802.11n HT40, Port 2

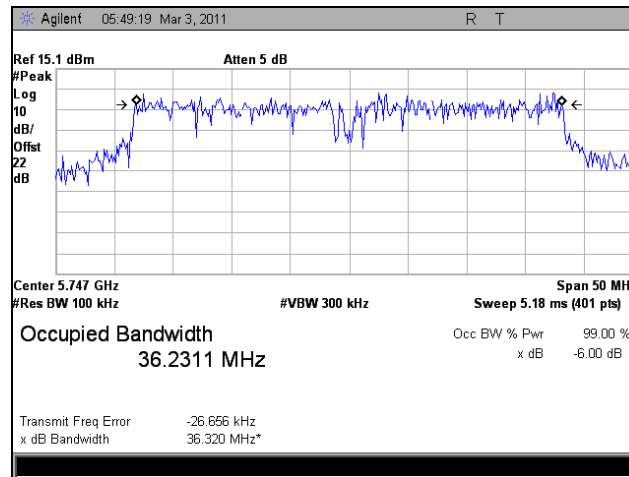

Plot 46. 6 dB Occupied Bandwidth, Low Channel, 802.11n HT40, Port 2

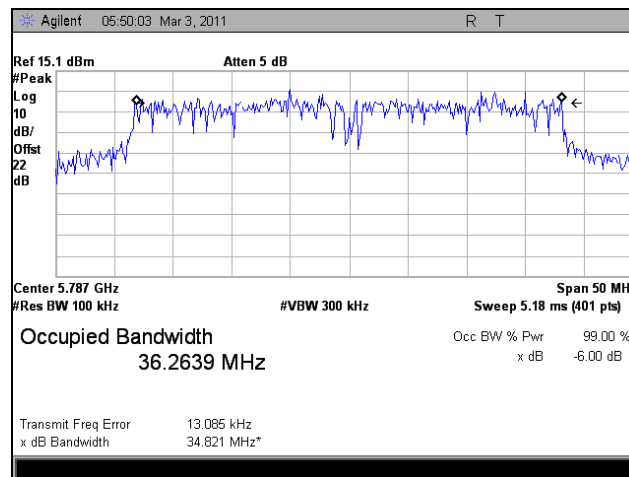

Plot 47. 6 dB Occupied Bandwidth, Mid Channel, 802.11n HT40, Port 2

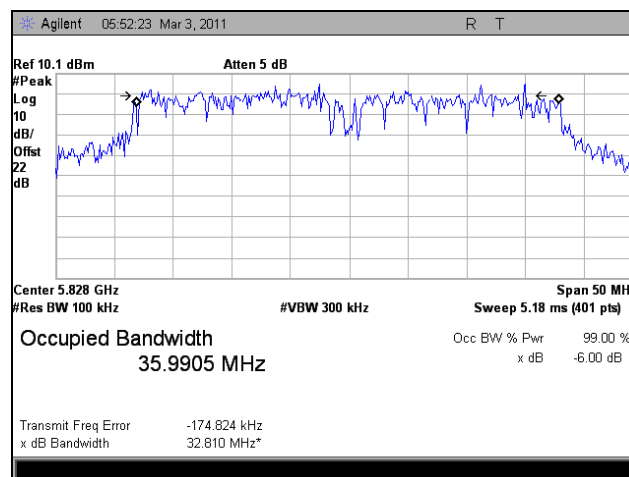

Plot 48. 6 dB Occupied Bandwidth, High Channel, 802.11n HT40, Port 2

99% Occupied Bandwidth Test Results, 802.11a 20 MHz

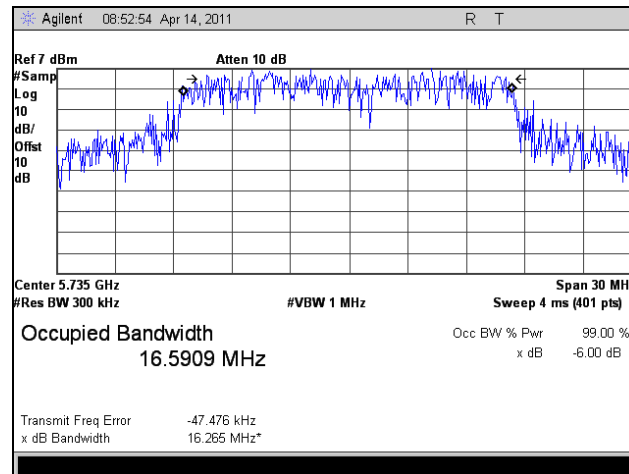

Plot 49. 99% Occupied Bandwidth, Low Channel, 802.11a 20 MHz

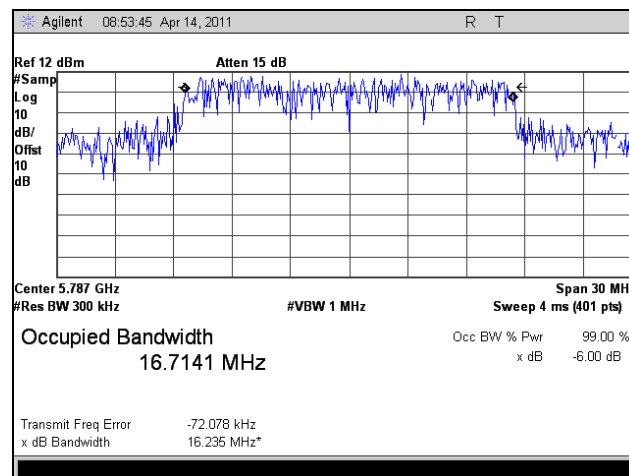

Plot 50. 99% Occupied Bandwidth, Mid Channel, 802.11a 20 MHz

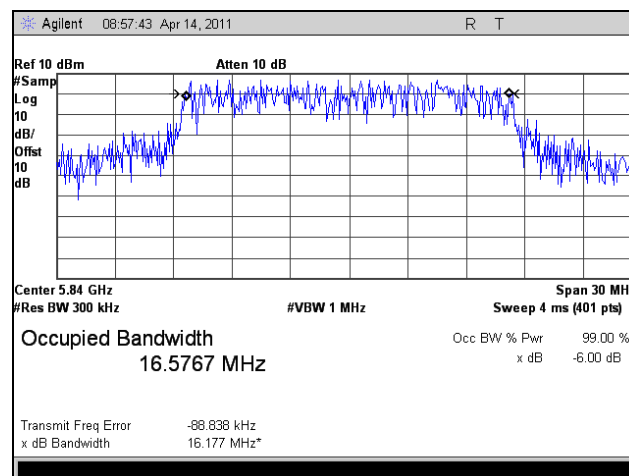

Plot 51. 99% Occupied Bandwidth, High Channel, 802.11a 20 MHz

99% Occupied Bandwidth Test Results, 802.11a 40 MHz

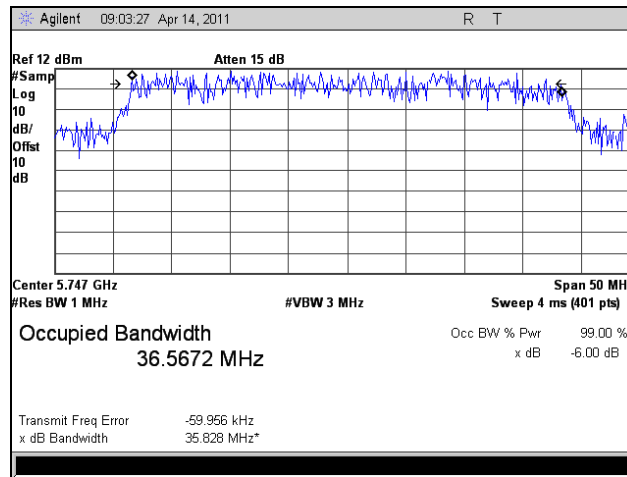

Plot 52. 99% Occupied Bandwidth, Low Channel, 802.11a 40 MHz

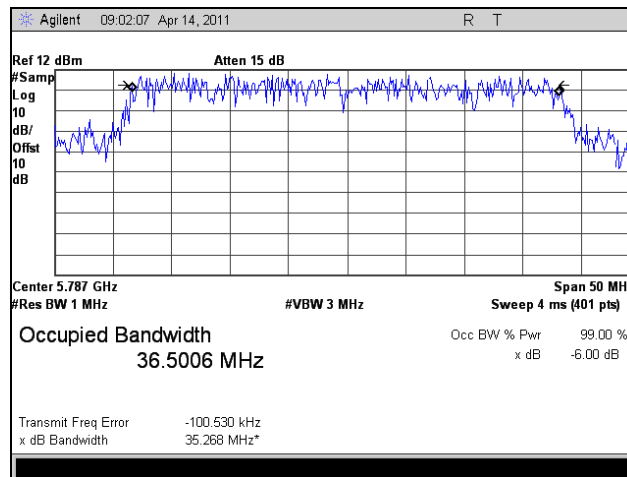

Plot 53. 99% Occupied Bandwidth, Mid Channel, 802.11a 40 MHz

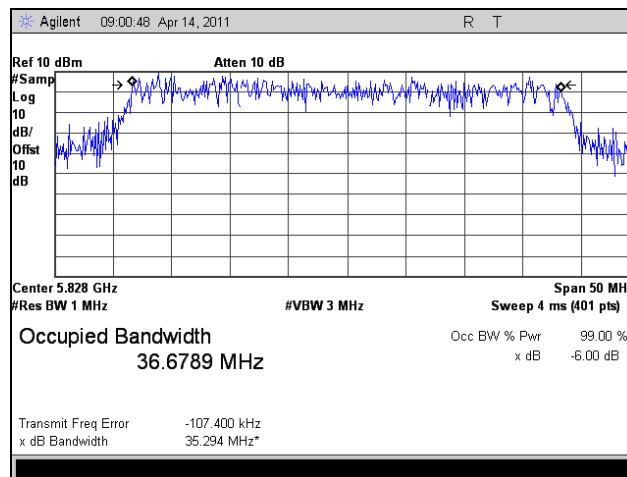

Plot 54. 99% Occupied Bandwidth, High Channel, 802.11a 40 MHz

99% Occupied Bandwidth Test Results, 802.11n HT5, Port 1

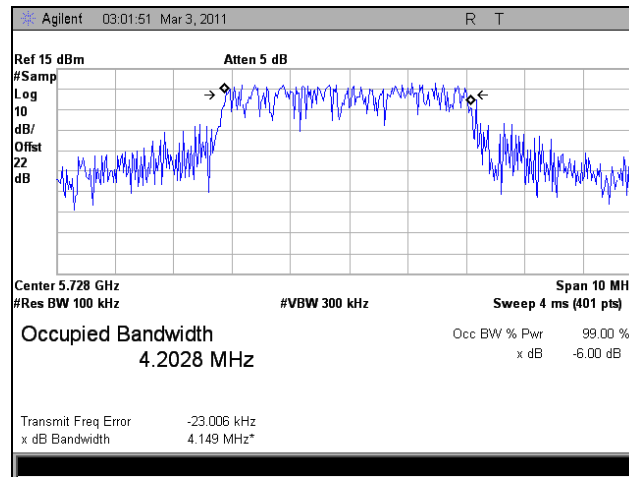

Plot 55. 99% Occupied Bandwidth, Low Channel, 802.11n HT5, Port 1

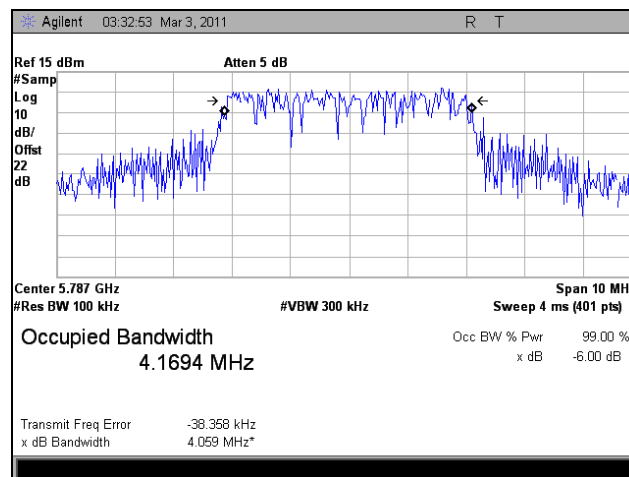

Plot 56. 99% Occupied Bandwidth, Mid Channel, 802.11n HT5, Port 1

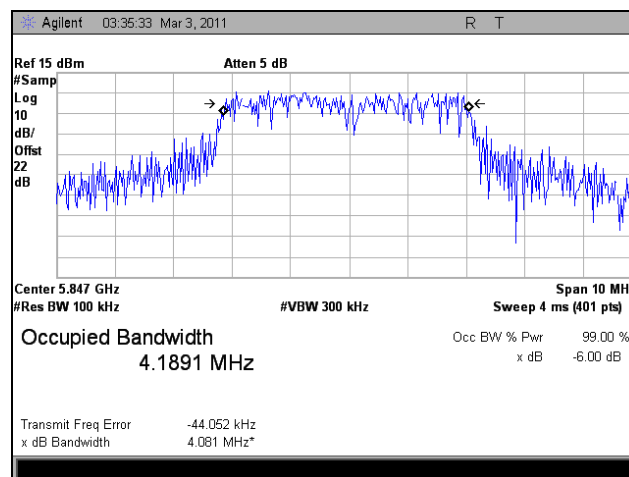

Plot 57. 99% Occupied Bandwidth, High Channel, 802.11n HT5, Port 1

99% Occupied Bandwidth Test Results, 802.11n HT5, Port 2

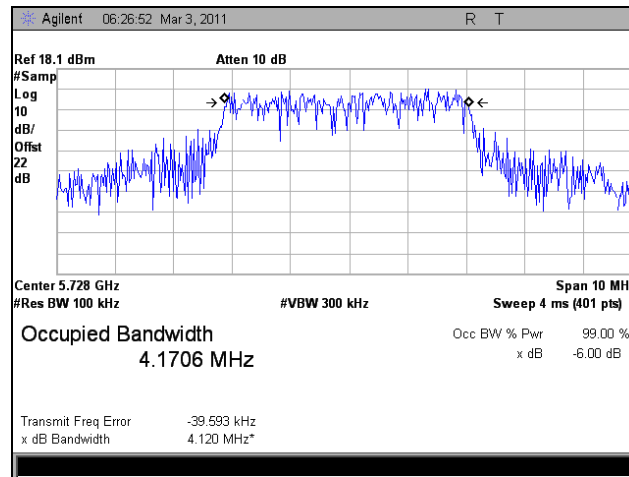

Plot 58. 99% Occupied Bandwidth, Low Channel, 802.11n HT5, Port 2

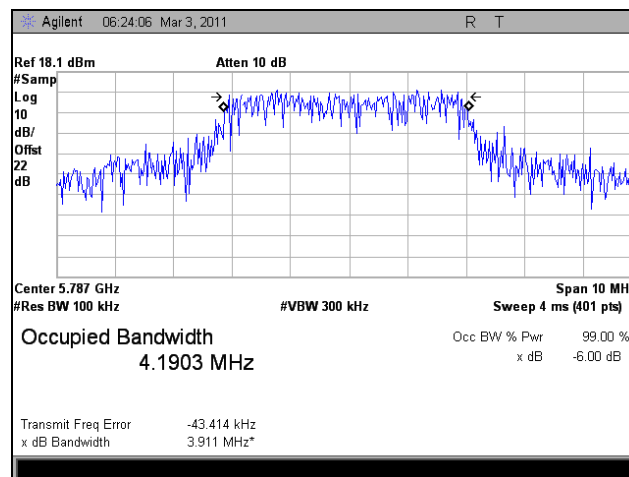

Plot 59. 99% Occupied Bandwidth, Mid Channel, 802.11n HT5, Port 2

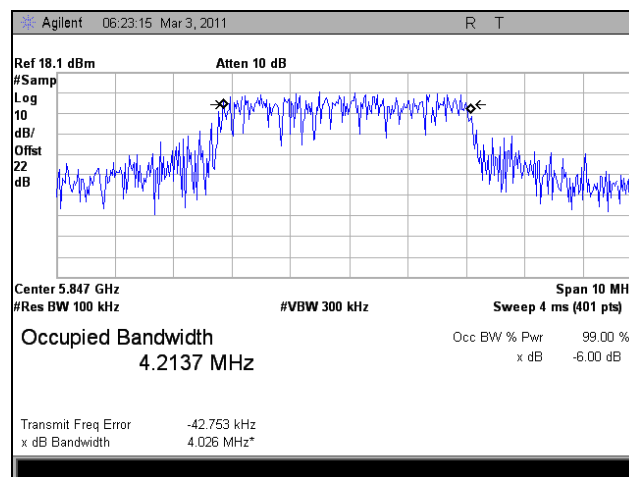

Plot 60. 99% Occupied Bandwidth, High Channel, 802.11n HT5, Port 2

99% Occupied Bandwidth Test Results, 802.11n HT8, Port 1

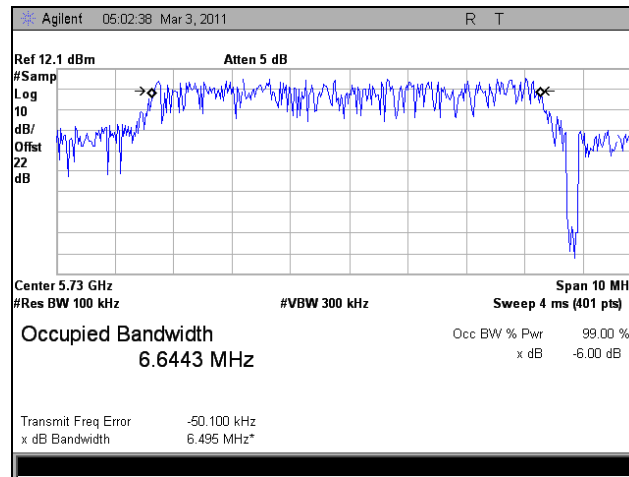

Plot 61. 99% Occupied Bandwidth, Low Channel, 802.11n HT8, Port 1

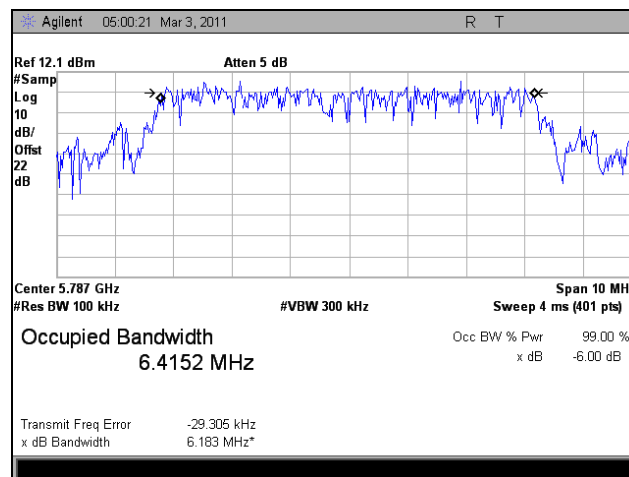

Plot 62. 99% Occupied Bandwidth, Mid Channel, 802.11n HT8, Port 1

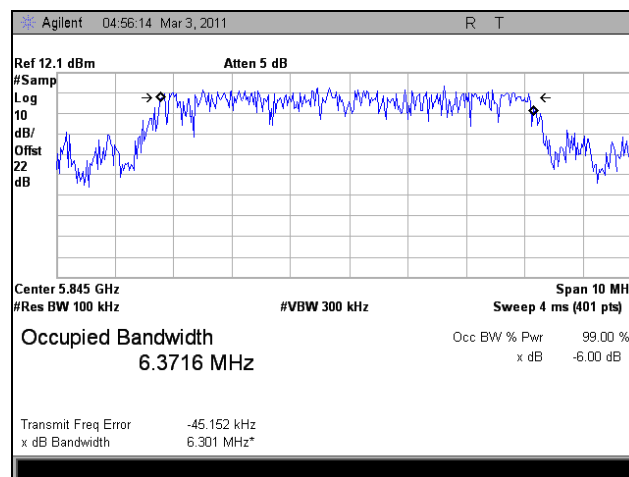

Plot 63. 99% Occupied Bandwidth, High Channel, 802.11n HT8, Port 1

99% Occupied Bandwidth Test Results, 802.11n HT8, Port 2

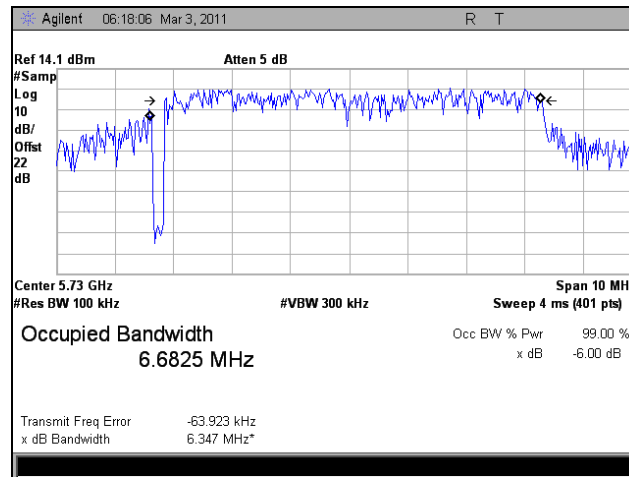

Plot 64. 99% Occupied Bandwidth, Low Channel, 802.11n HT8, Port 2

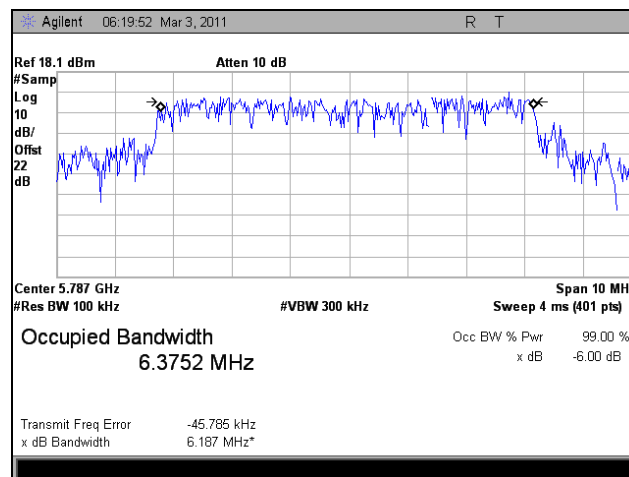

Plot 65. 99% Occupied Bandwidth, Mid Channel, 802.11n HT8, Port 2

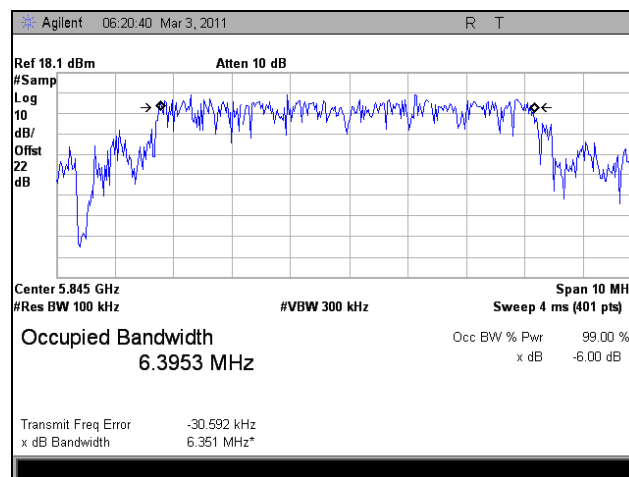

Plot 66. 99% Occupied Bandwidth, High Channel, 802.11n HT8, Port 2

99% Occupied Bandwidth Test Results, 802.11n HT10, Port 1

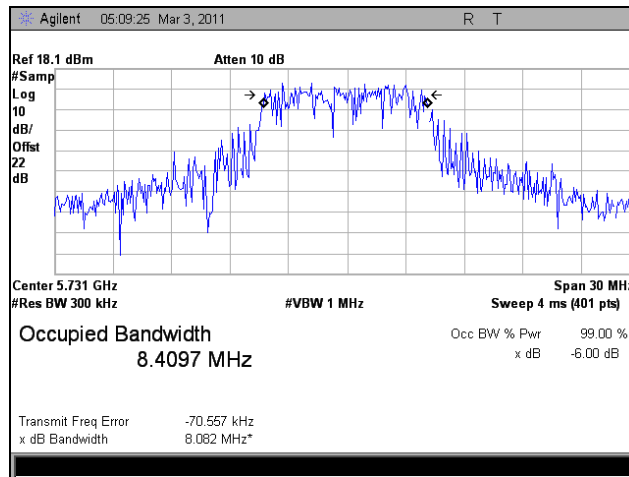

Plot 67. 99% Occupied Bandwidth, Low Channel, 802.11n HT10, Port 1

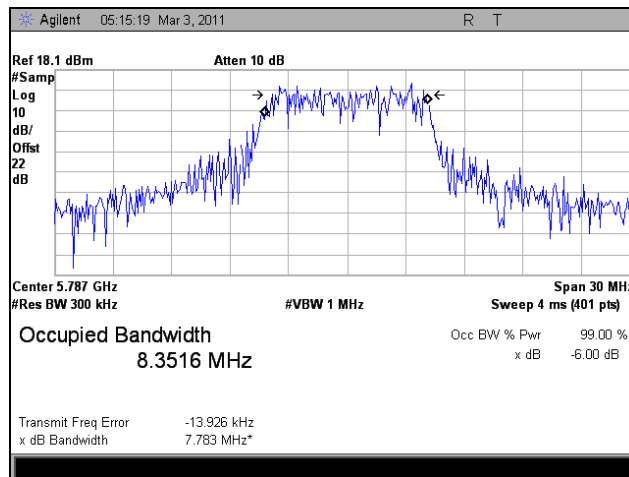

Plot 68. 99% Occupied Bandwidth, Mid Channel, 802.11n HT10, Port 1

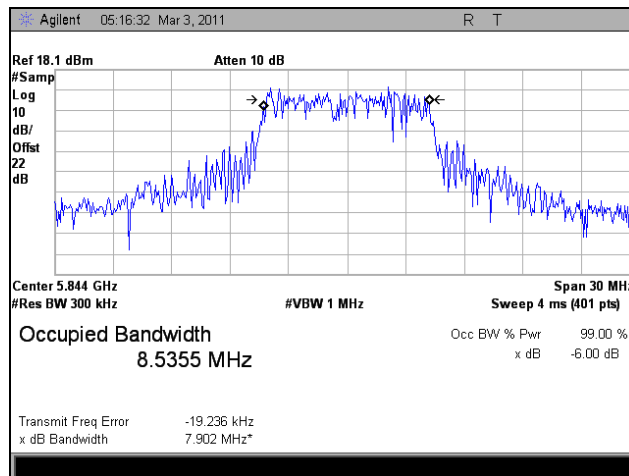

Plot 69. 99% Occupied Bandwidth, High Channel, 802.11n HT10, Port 1

99% Occupied Bandwidth Test Results, 802.11n HT10, Port 2

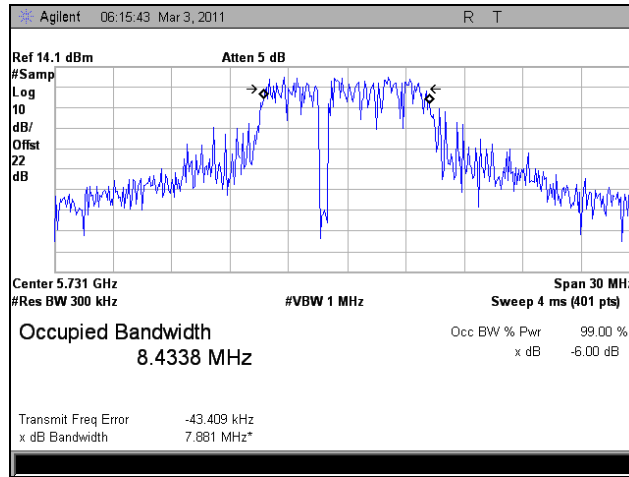

Plot 70. 99% Occupied Bandwidth, Low Channel, 802.11n HT10, Port 2

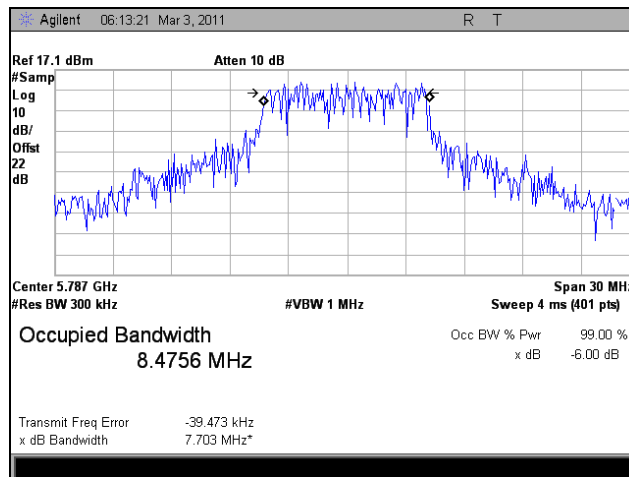

Plot 71. 99% Occupied Bandwidth, Mid Channel, 802.11n HT10, Port 2

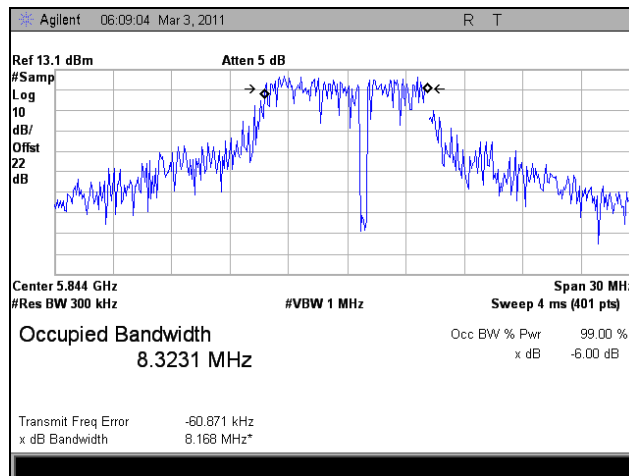

Plot 72. 99% Occupied Bandwidth, High Channel, 802.11n HT10, Port 2

99% Occupied Bandwidth Test Results, 802.11n HT20, Port 1

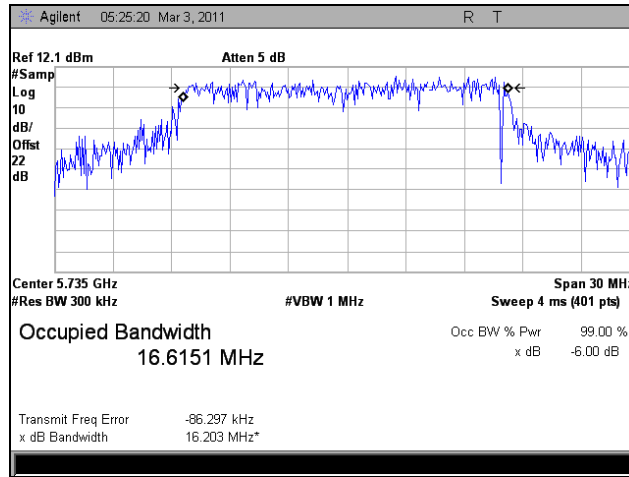

Plot 73. 99% Occupied Bandwidth, Low Channel, 802.11n HT20, Port 1

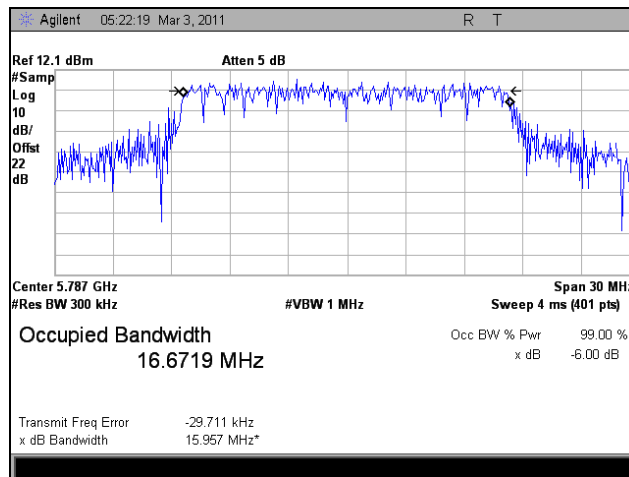

Plot 74. 99% Occupied Bandwidth, Mid Channel, 802.11n HT20, Port 1

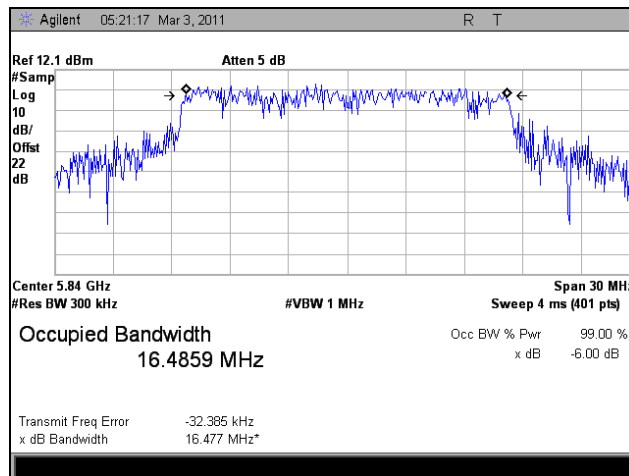

Plot 75. 99% Occupied Bandwidth, High Channel, 802.11n HT20, Port 1

99% Occupied Bandwidth Test Results, 802.11n HT20, Port 2

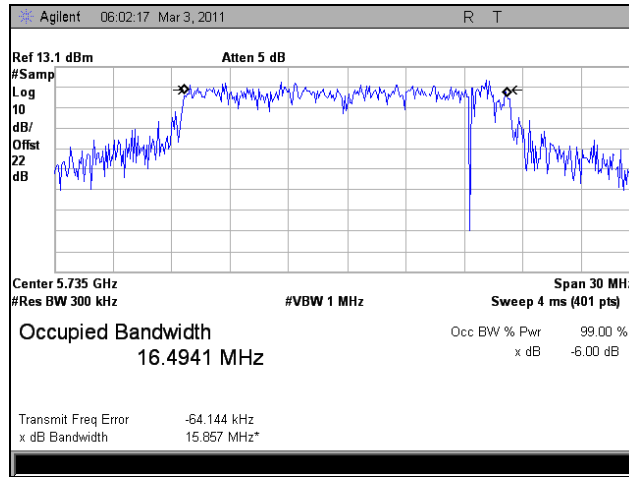

Plot 76. 99% Occupied Bandwidth, Low Channel, 802.11n HT20, Port 2

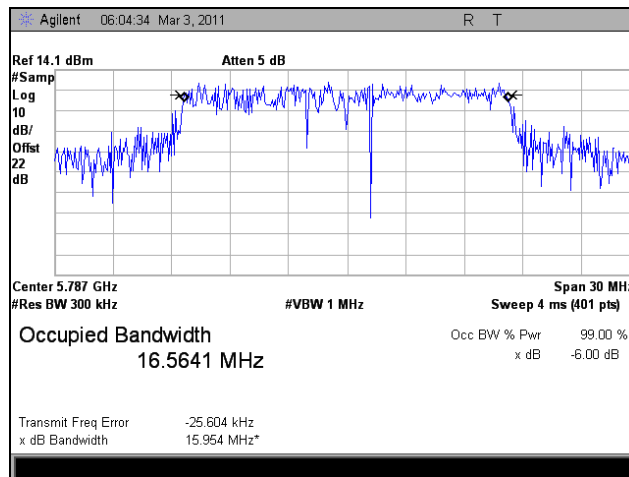

Plot 77. 99% Occupied Bandwidth, Mid Channel, 802.11n HT20, Port 2

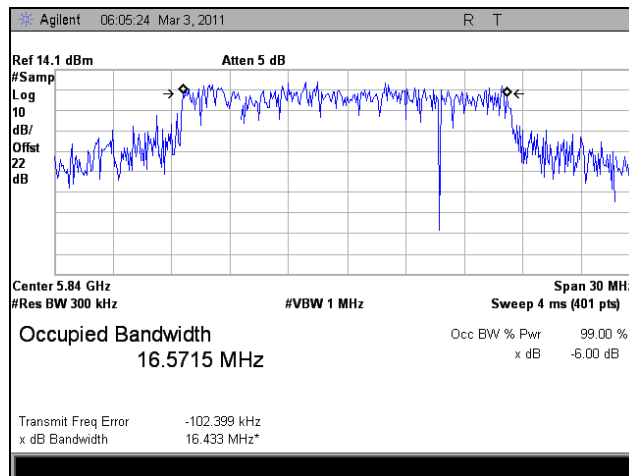

Plot 78. 99% Occupied Bandwidth, High Channel, 802.11n HT20, Port 2

99% Occupied Bandwidth Test Results, 802.11n HT30, Port 1

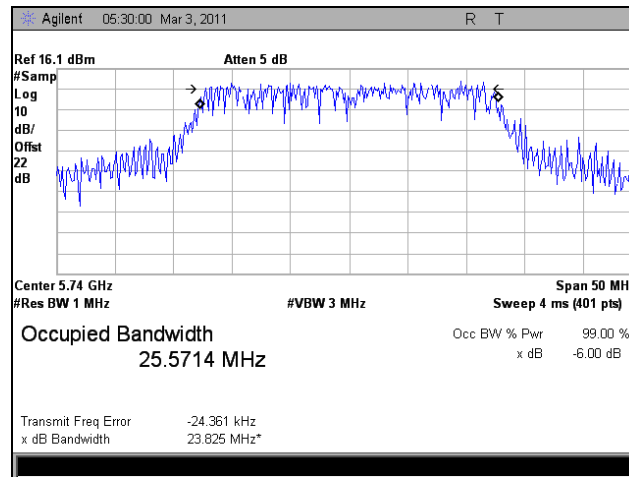

Plot 79. 99% Occupied Bandwidth, Low Channel, 802.11n HT30, Port 1

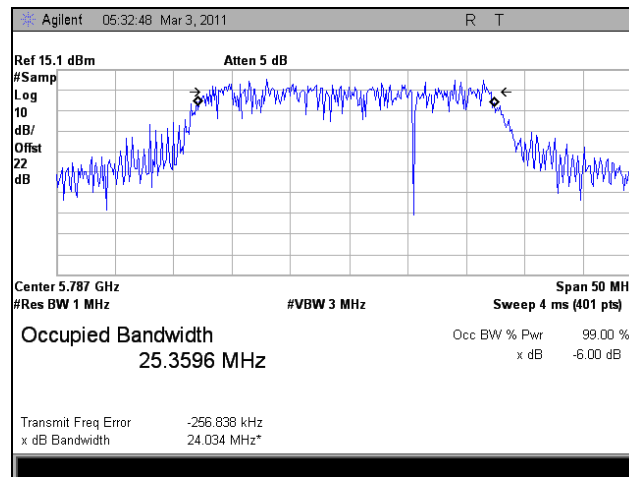

Plot 80. 99% Occupied Bandwidth, Mid Channel, 802.11n HT30, Port 1

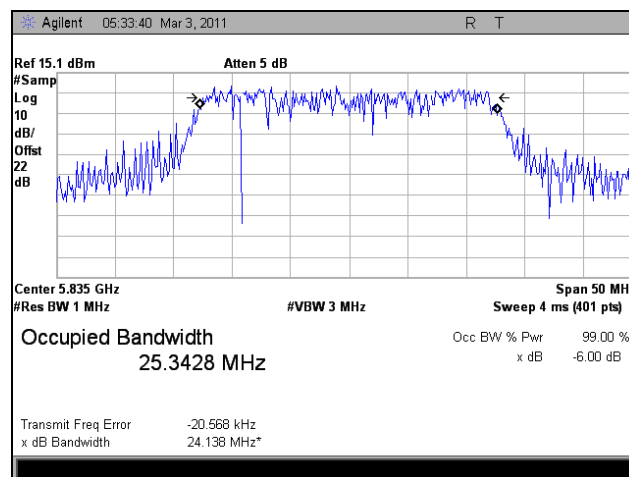

Plot 81. 99% Occupied Bandwidth, High Channel, 802.11n HT30, Port 1

99% Occupied Bandwidth Test Results, 802.11n HT30, Port 2

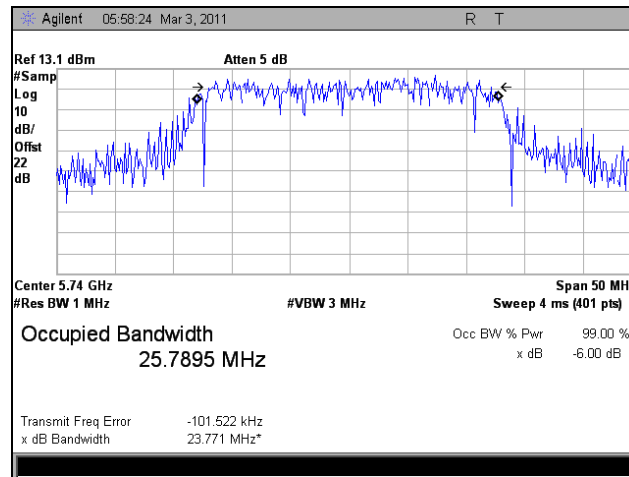

Plot 82. 99% Occupied Bandwidth, Low Channel, 802.11n HT30, Port 2

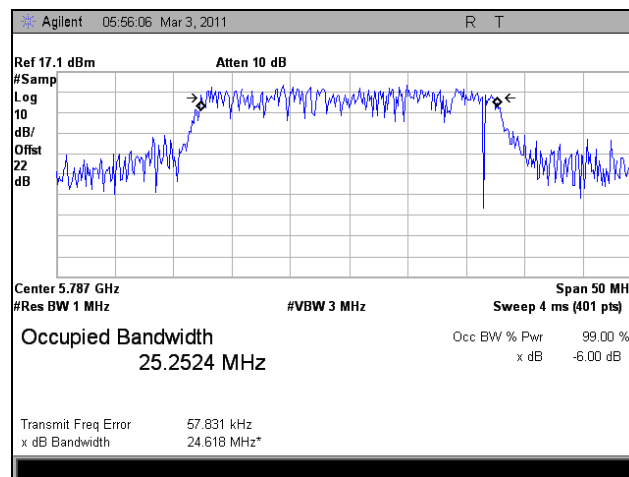

Plot 83. 99% Occupied Bandwidth, Mid Channel, 802.11n HT30, Port 2

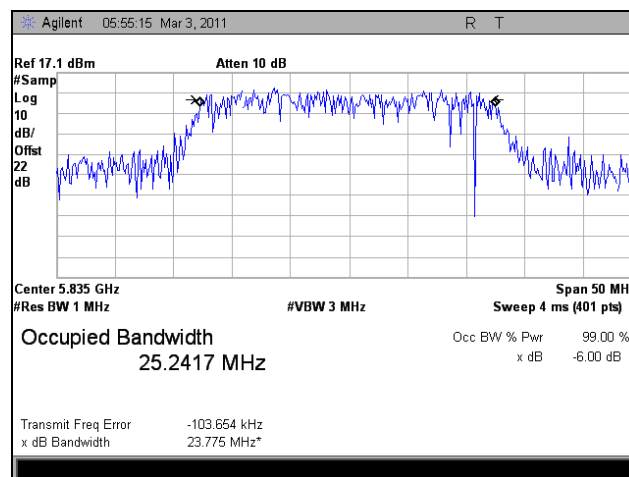

Plot 84. 99% Occupied Bandwidth, High Channel, 802.11n HT30, Port 2

99% Occupied Bandwidth Test Results, 802.11n HT40, Port 1

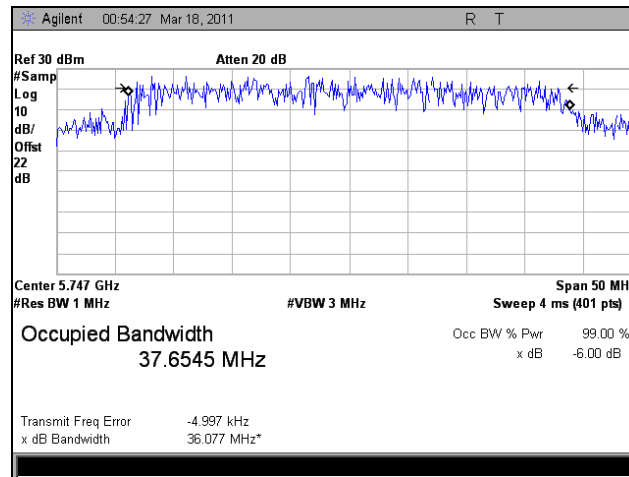

Plot 85. 99% Occupied Bandwidth, Low Channel, 802.11n HT40, Port 1

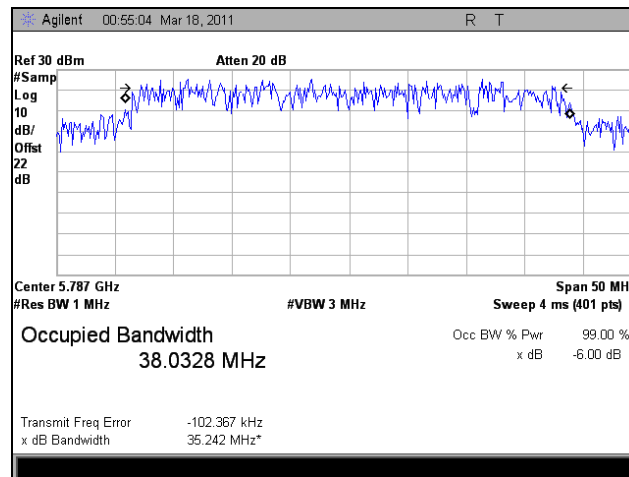

Plot 86. 99% Occupied Bandwidth, Mid Channel, 802.11n HT40, Port 1

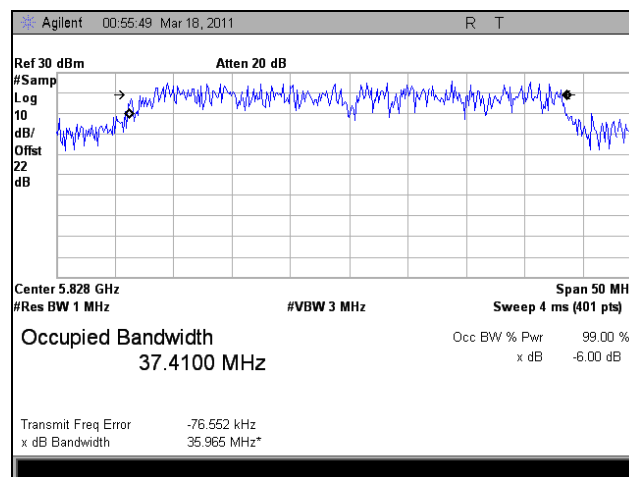

Plot 87. 99% Occupied Bandwidth, High Channel, 802.11n HT40, Port 1

99% Occupied Bandwidth Test Results, 802.11n HT40, Port 2

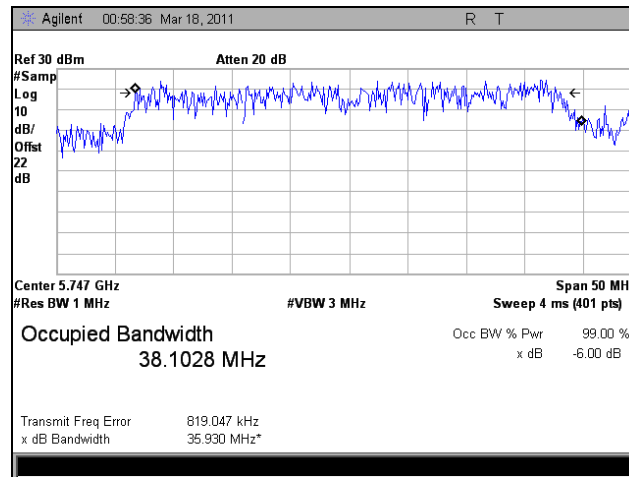

Plot 88. 99% Occupied Bandwidth, Low Channel, 802.11n HT40, Port 2

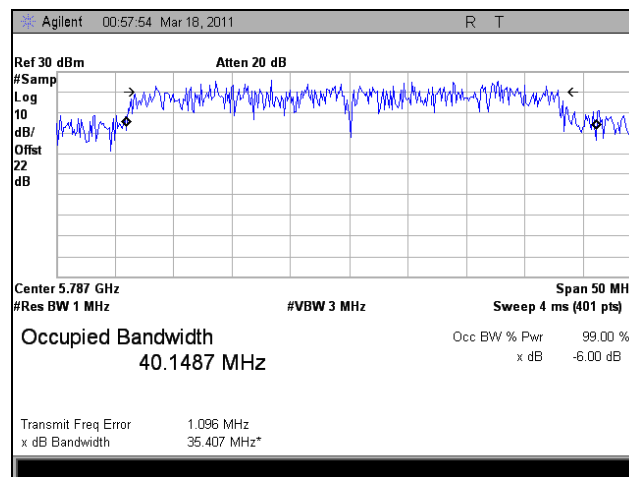

Plot 89. 99% Occupied Bandwidth, Mid Channel, 802.11n HT40, Port 2

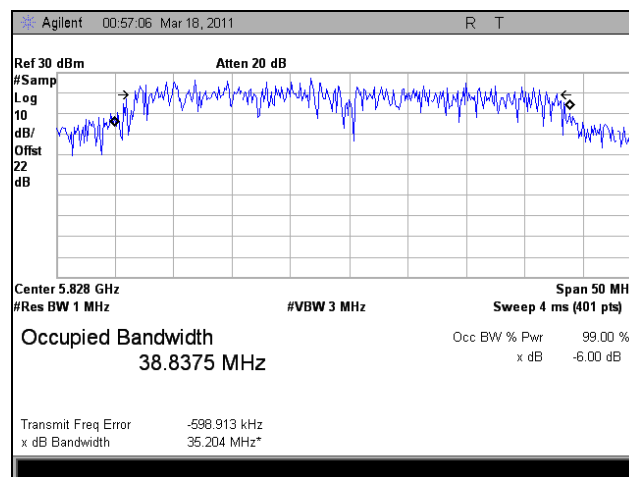

Plot 90. 99% Occupied Bandwidth, High Channel, 802.11n HT40, Port 2

Electromagnetic Compatibility Criteria for Intentional Radiators

§ 15.247(b) Peak Power Output

Test Requirements: §15.247(b): The maximum peak output power of the intentional radiator shall not exceed the following:

Digital Transmission Systems (MHz)	Output Limit (Watts)
902-928	1.000
2400-2483.5	1.000
5725- 5850	1.000

Table 20. Output Power Requirements from §15.247(b)

§15.247(c): if transmitting antennas of directional gain greater than 6 dBi are used the peak output power from the intentional radiator shall be reduced below the stated values in the Table 20, as appropriate, by the amount in dB that the directional gain of the antenna exceeds 6 dBi.

Systems operating in the 2400 – 2483.5 MHz band and using a point to point application may employ transmitting antennas with directional gain greater than 6 dBi provided the maximum peak output power of the intentional radiator is reduced by 1 dB for every 3 dB that the directional gain of the antenna exceeds 6 dBi.

Systems operating in the 5725 – 5850 MHz band that are used exclusively for fixed, point-to-point operations may employ transmitting antennas with directional gain greater than 6 dBi without any corresponding reduction in transmitter peak output power.

Fixed, point-to-point operation excludes the use of point-to-multipoint systems, Omni-directional applications, and multiple co-located intentional radiators transmitting the same information. The operator of the spread spectrum intentional radiator or, if the equipment is professionally installed, the installer is responsible for ensuring that the system is used exclusively for fixed, point-to-point operations. The instruction manual furnished with the intentional radiator shall contain language in the installation instructions informing the operator and the installer of this responsibility.

Test Procedure: The transmitter was connected to a calibrated spectrum analyzer. The EUT was measured at the low, mid and high channels of each band at the maximum power level.

Test Results: The EUT was compliant with the Peak Power Output limits of §15.247(b).

Test Engineer(s): Kenshi Chung

Test Date(s): 03/07/11

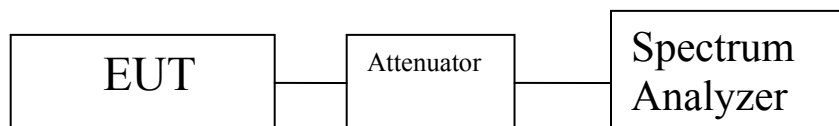

Figure 3. Peak Power Output Test Setup

Peak Power Output Test Results

Peak Conducted Output Power			
	Carrier Channel	Frequency (MHz)	Measured Peak Output Power dBm
802.11a 20 MHz	Low	5735	24.64
	Mid	5787	29.21
	High	5840	28.78
802.11a 40 MHz	Low	5747	29.76
	Mid	5787	29.78
	High	5828	28.92
802.11n HT5	Low	5728	26.75
	Mid	5787	26.49
	High	5847	23.79
802.11n HT8	Low	5730	27.28
	Mid	5787	26.47
	High	5845	26.86
802.11n HT10	Low	5731	26.28
	Mid	5787	25.61
	High	5844	24.16
802.11n HT20	Low	5735	26.82
	Mid	5787	26.61
	High	5840	26.93
802.11n HT30	Low	5740	26.86
	Mid	5787	26.15
	High	5835	25.23
802.11n HT40	Low	5747	26.11
	Mid	5787	26.85
	High	5828	26.93

Table 21. Peak Power Output, Test Results, Port 1

Peak Conducted Output Power			
	Carrier Channel	Frequency (MHz)	Measured Peak Output Power dBm
802.11n HT5	Low	5728	26.55
	Mid	5787	26.50
	High	5847	25.48
802.11n HT8	Low	5730	25.08
	Mid	5787	26.69
	High	5845	26.49
802.11n HT10	Low	5731	26.59
	Mid	5787	26.59
	High	5844	25.33
802.11n HT20	Low	5735	25.05
	Mid	5787	26.65
	High	5840	26.47
802.11n HT30	Low	5740	26.53
	Mid	5787	26.60
	High	5835	25.68
802.11n HT40	Low	5747	25.77
	Mid	5787	26.88
	High	5828	26.67

Table 22. Peak Power Output, Test Results, Port 2

Peak Conducted Output Power			
	Carrier Channel	Frequency (MHz)	Measured Peak Output Power dBm
802.11n HT5	Low	5728	29.66
	Mid	5787	29.51
	High	5847	27.73
802.11n HT8	Low	5730	29.33
	Mid	5787	29.59
	High	5845	29.69
802.11n HT10	Low	5731	29.45
	Mid	5787	29.14
	High	5844	27.79
802.11n HT20	Low	5735	29.03
	Mid	5787	29.64
	High	5840	29.72
802.11n HT30	Low	5740	29.71
	Mid	5787	29.39
	High	5835	28.47
802.11n HT40	Low	5747	28.95
	Mid	5787	29.88
	High	5828	29.81

Table 23. Peak Power Output, Test Results, Summed

Peak Power Output Test Results, 802.11a 20 MHz

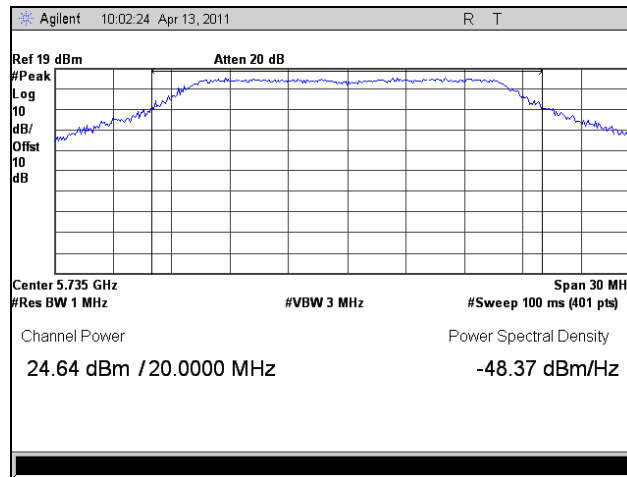

Plot 91. Peak Power Output, Low Channel, 802.11a 20 MHz

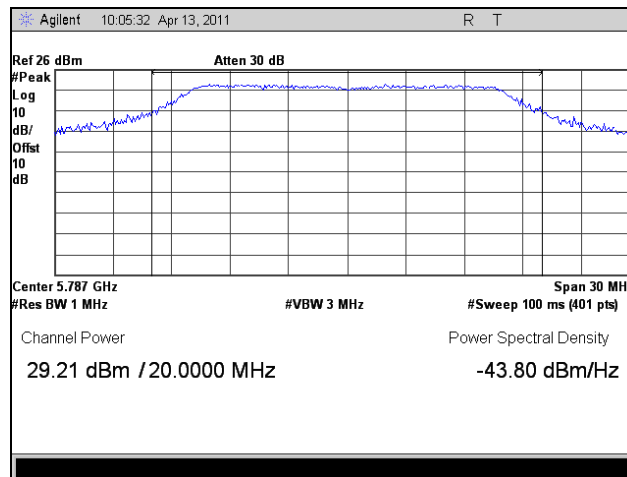

Plot 92. Peak Power Output, Mid Channel, 802.11a 20 MHz

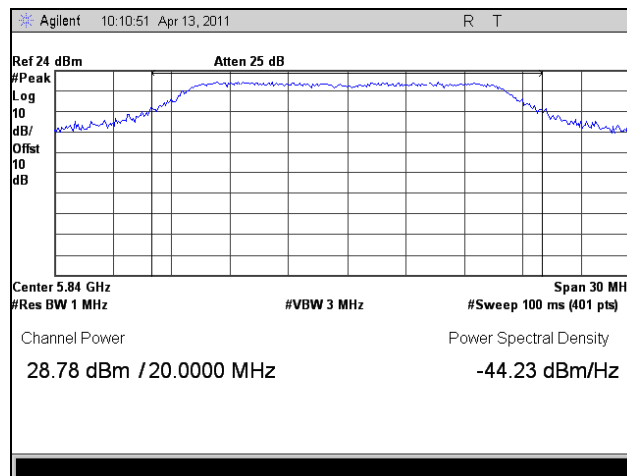

Plot 93. Peak Power Output, High Channel, 802.11a 20 MHz

Peak Power Output Test Results, 802.11a 40 MHz

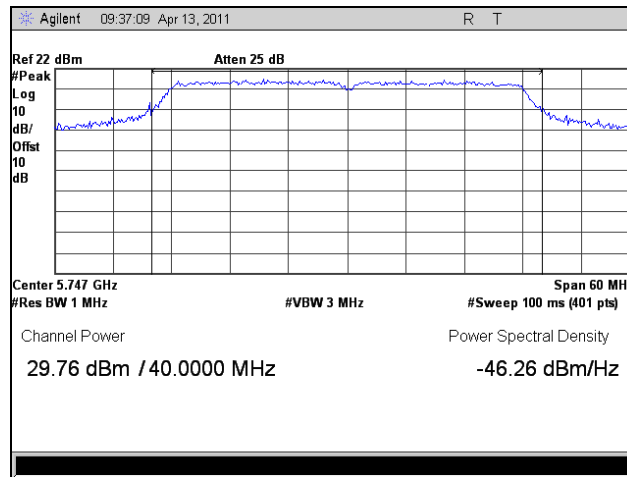

Plot 94. Peak Power Output, Low Channel, 802.11a 40 MHz

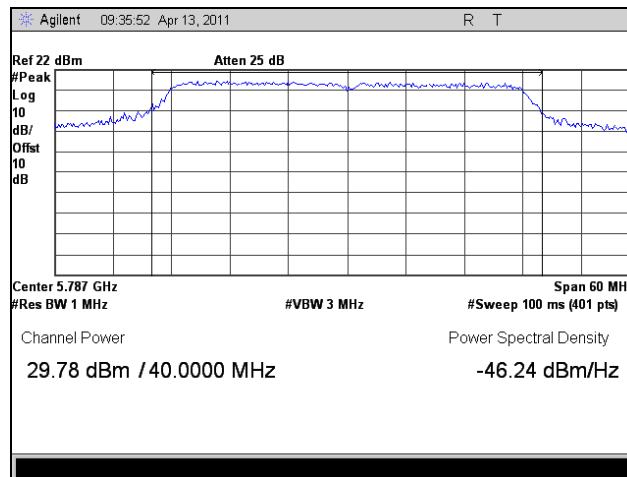

Plot 95. Peak Power Output, Mid Channel, 802.11a 40 MHz

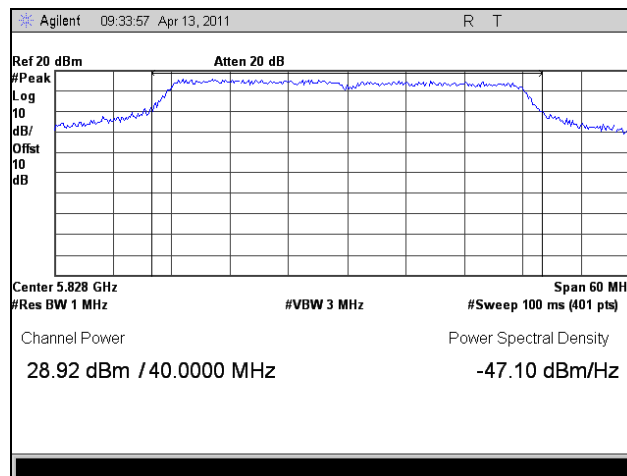

Plot 96. Peak Power Output, High Channel, 802.11a 40 MHz

Peak Power Output Test Results, 802.11n HT5, Port 1

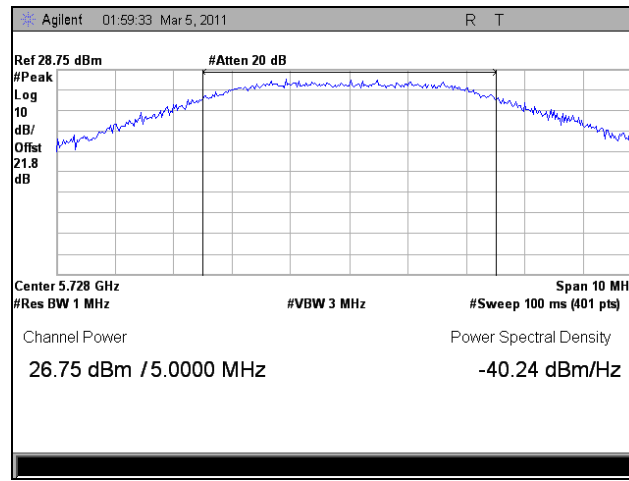

Plot 97. Peak Power Output, Low Channel, 802.11n HT5, Port 1

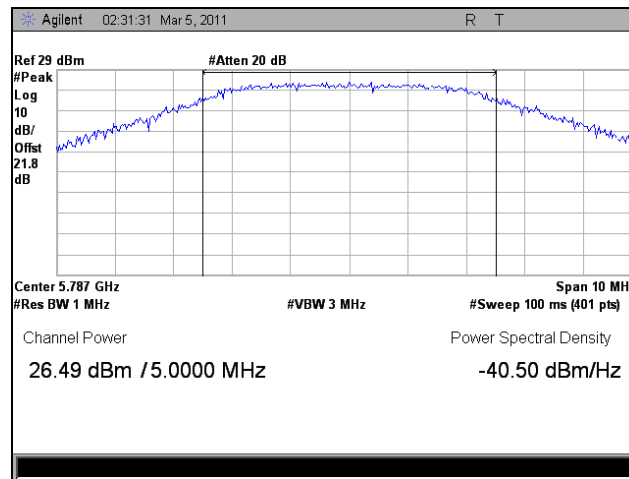

Plot 98. Peak Power Output, Mid Channel, 802.11n HT5, Port 1

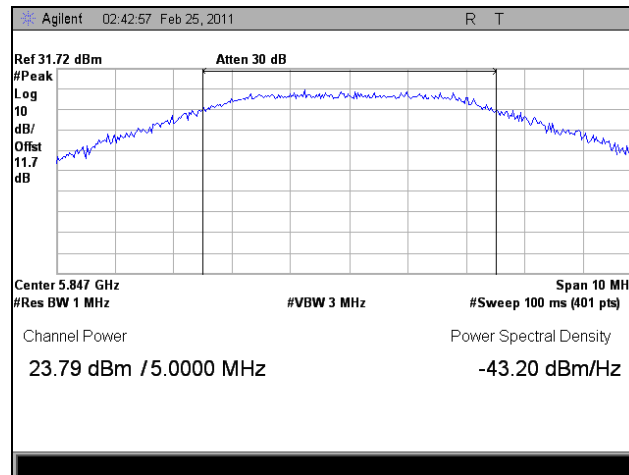

Plot 99. Peak Power Output, High Channel, 802.11n HT5, Port 1

Peak Power Output Test Results, 802.11n HT5, Port 2

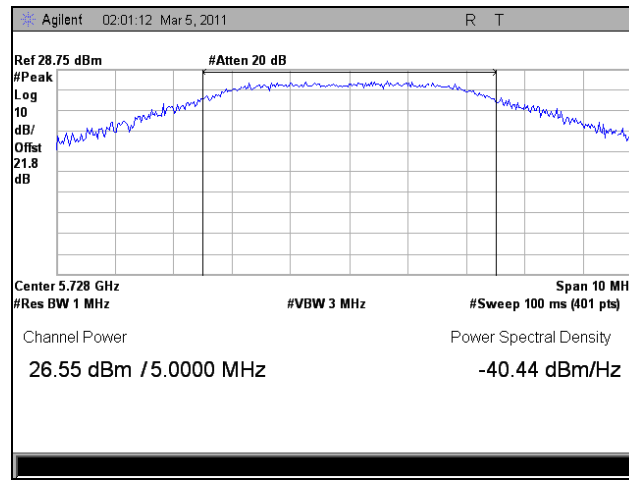

Plot 100. Peak Power Output, Low Channel, 802.11n HT5, Port 2

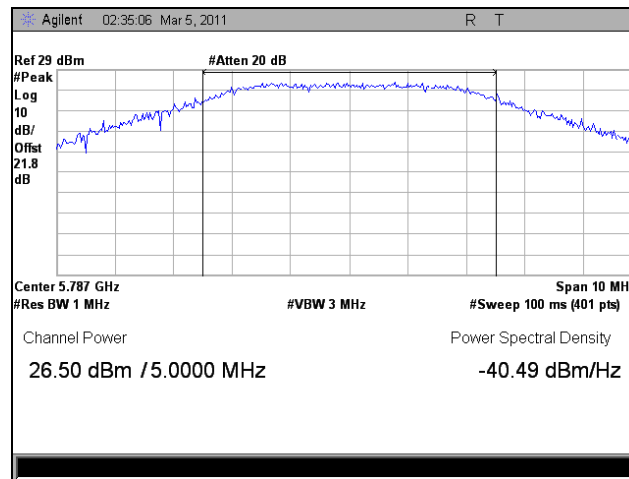

Plot 101. Peak Power Output, Mid Channel, 802.11n HT5, Port 2

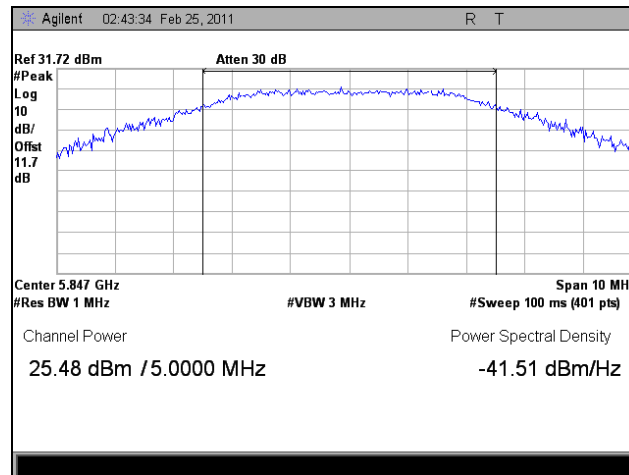

Plot 102. Peak Power Output, High Channel, 802.11n HT5, Port 2

Peak Power Output Test Results, 802.11n HT8, Port 1

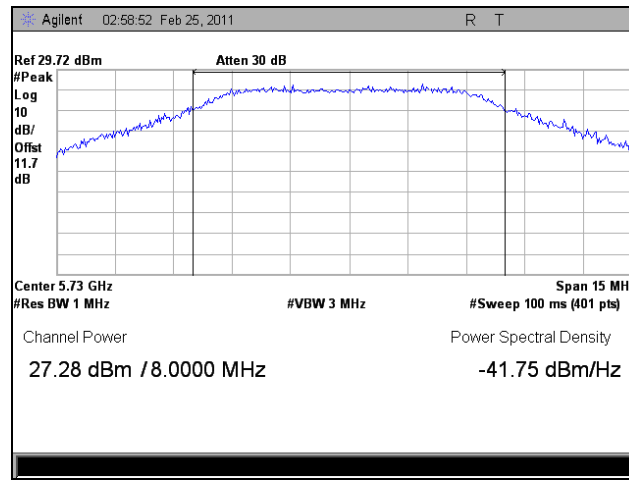

Plot 103. Peak Power Output, Low Channel, 802.11n HT8, Port 1

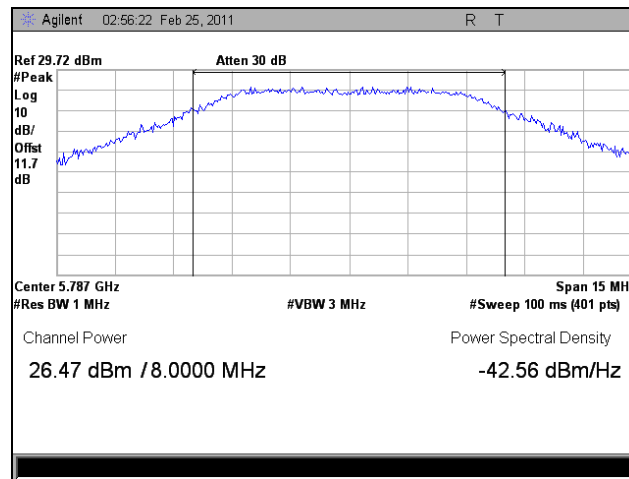

Plot 104. Peak Power Output, Mid Channel, 80.211n HT8, Port 1

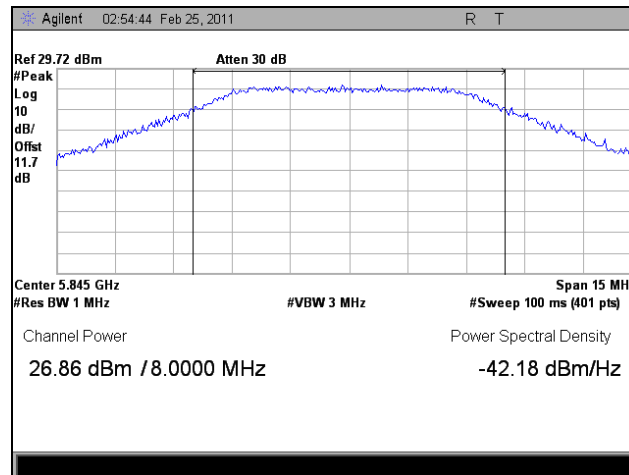

Plot 105. Peak Power Output, High Channel, 802.11n HT8, Port 1

Peak Power Output Test Results, 802.11n HT8, Port 2

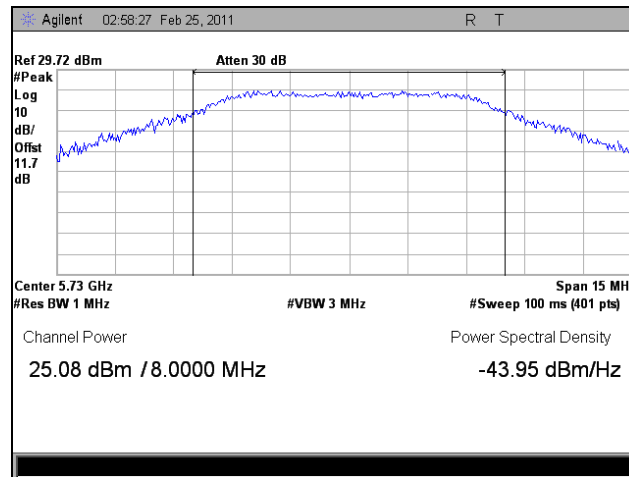

Plot 106. Peak Power Output, Low Channel, 802.11n HT8, Port 2

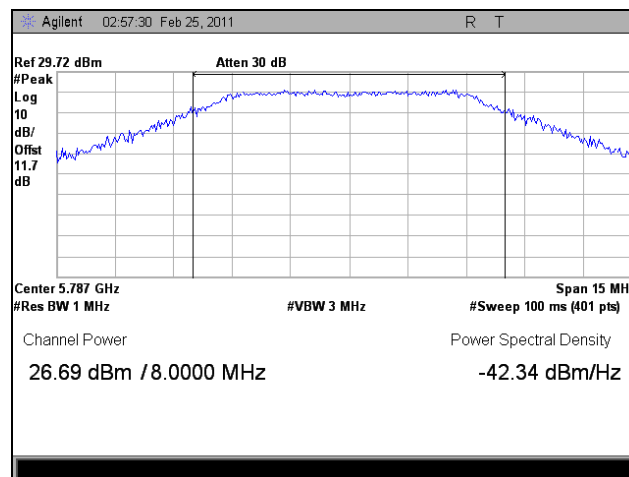

Plot 107. Peak Power Output, Mid Channel, 802.11n HT8, Port 2

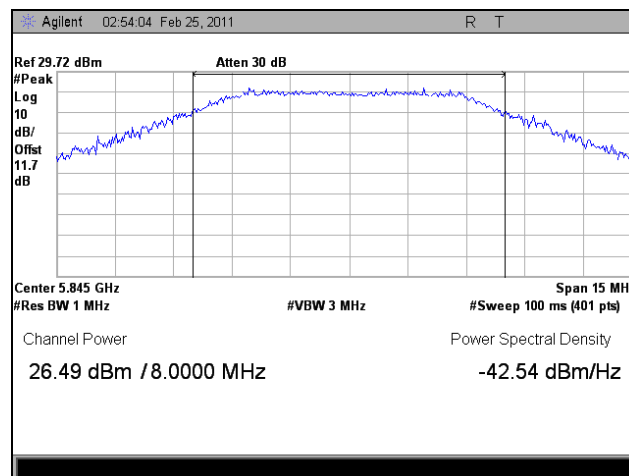

Plot 108. Peak Power Output, High Channel, 802.11n HT8, Port 2

Peak Power Output Test Results, 802.11n HT10, Port 1

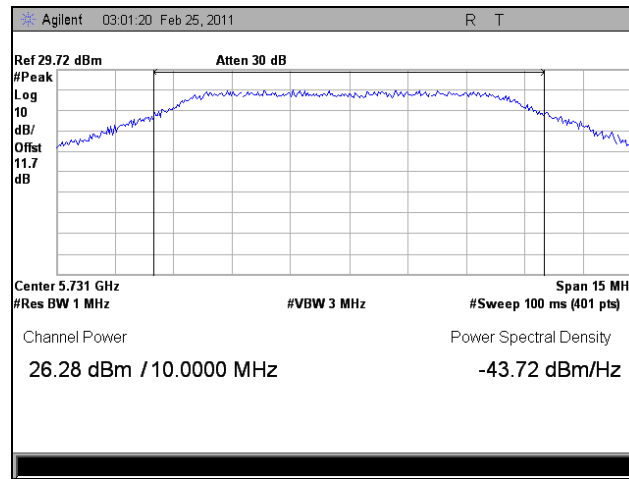

Plot 109. Peak Power Output, Low Channel, 802.11n HT10, Port 1

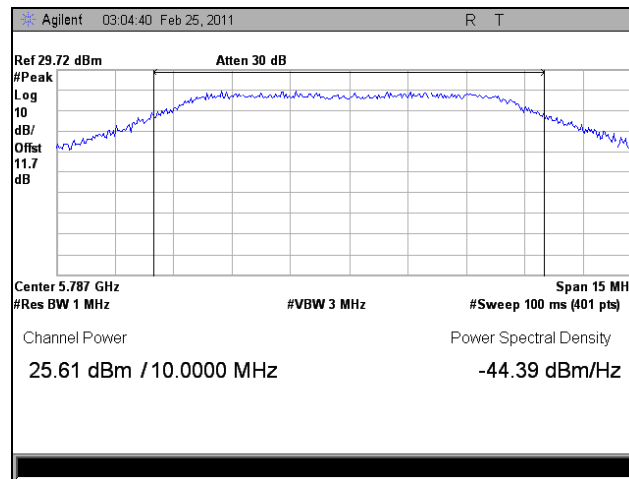

Plot 110. Peak Power Output, Mid Channel, 802.11n HT10, Port 1

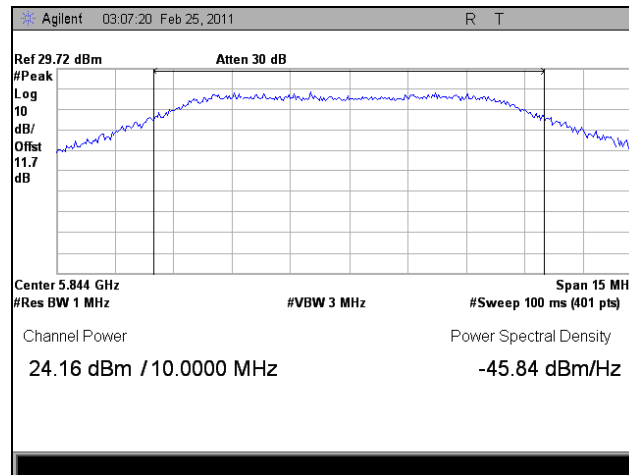

Plot 111. Peak Power Output, High Channel, 802.11n HT10, Port 1

Peak Power Output Test Results, 802.11n HT10, Port 2

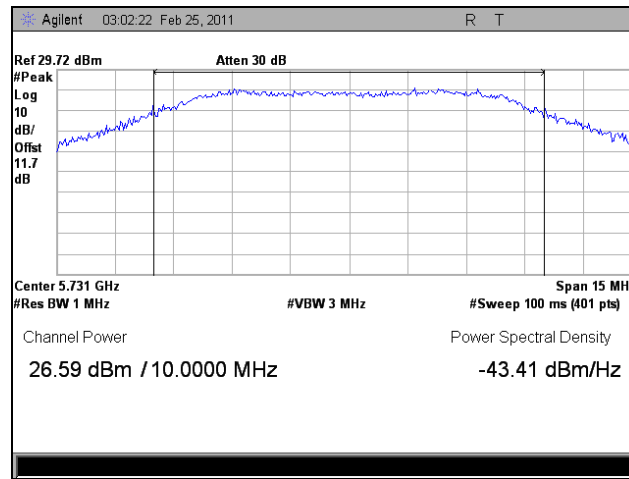

Plot 112. Peak Power Output, Low Channel, 802.11n HT10, Port 2

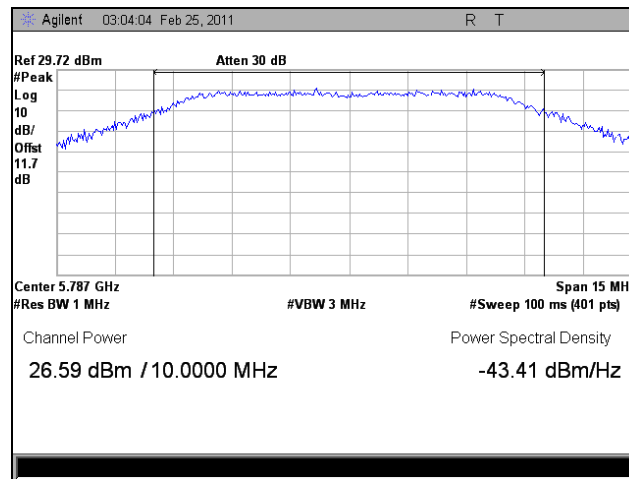

Plot 113. Peak Power Output, Mid Channel, 802.11n HT10, Port 2

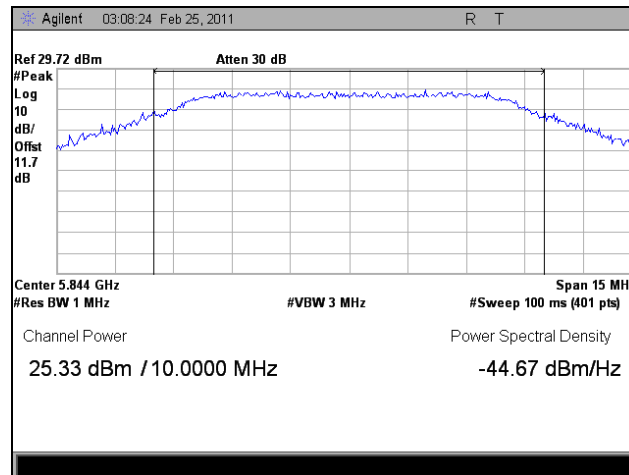

Plot 114. Peak Power Output, High Channel, 802.11n HT10, Port 2

Peak Power Output Test Results, 802.11n HT20, Port 1

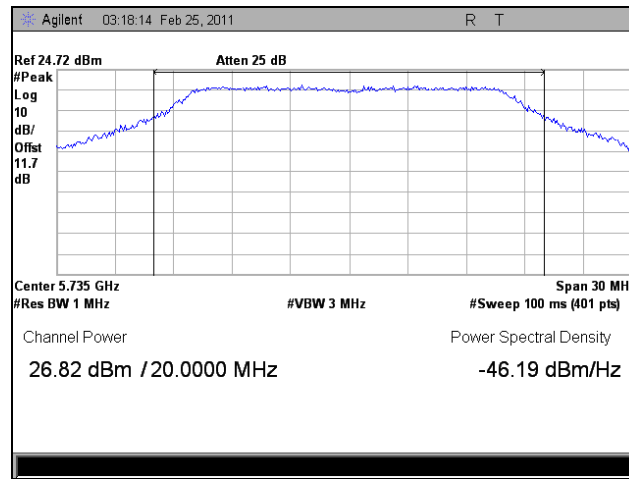

Plot 115. Peak Power Output, Low Channel, 802.11n HT20, Port 1

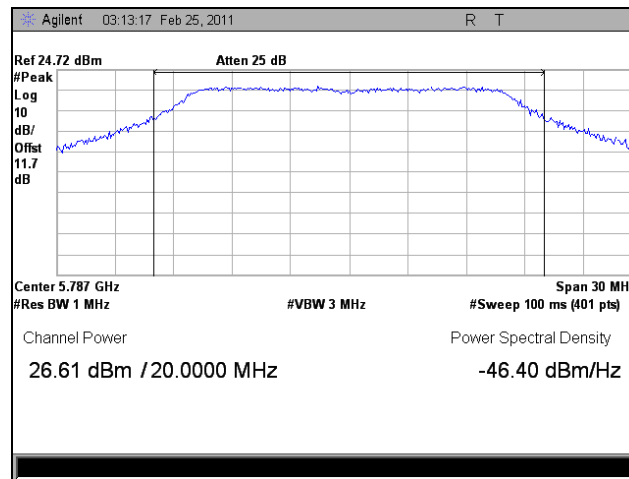

Plot 116. Peak Power Output, Mid Channel, 802.11n HT20, Port 1

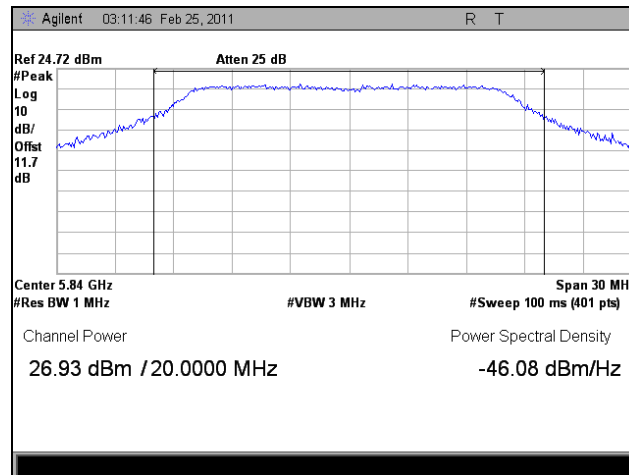

Plot 117. Peak Power Output, High Channel, 802.11n HT20, Port 1

Peak Power Output Test Results, 802.11n HT20, Port 2

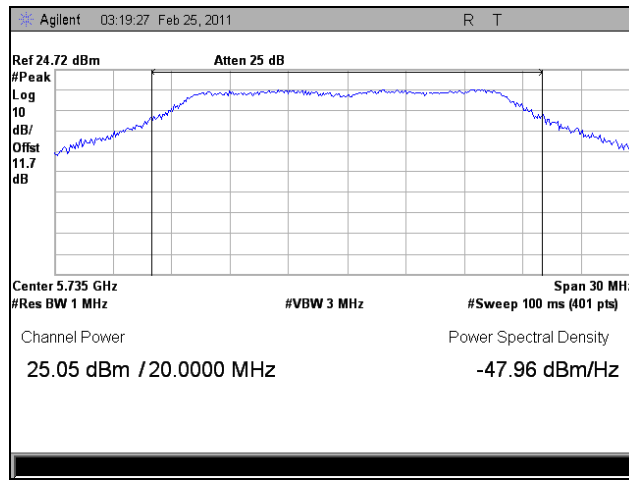

Plot 118. Peak Power Output, Low Channel, 802.11n HT20, Port 2

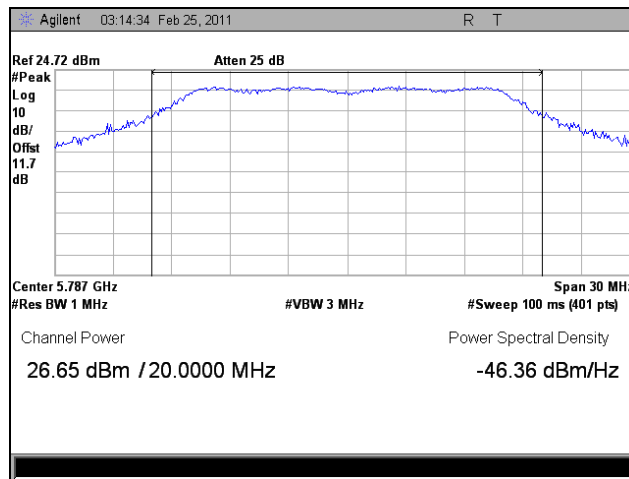

Plot 119. Peak Power Output, Mid Channel, 802.11n HT20, Port 2

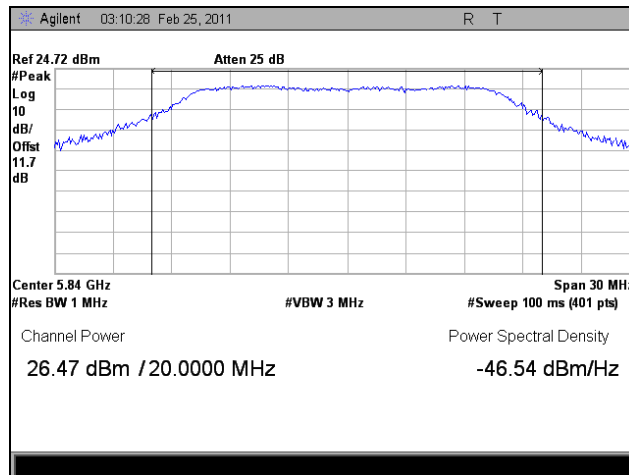

Plot 120. Peak Power Output, High Channel, 802.11n HT20, Port 2

Peak Power Output Test Results, 802.11n HT30, Port 1

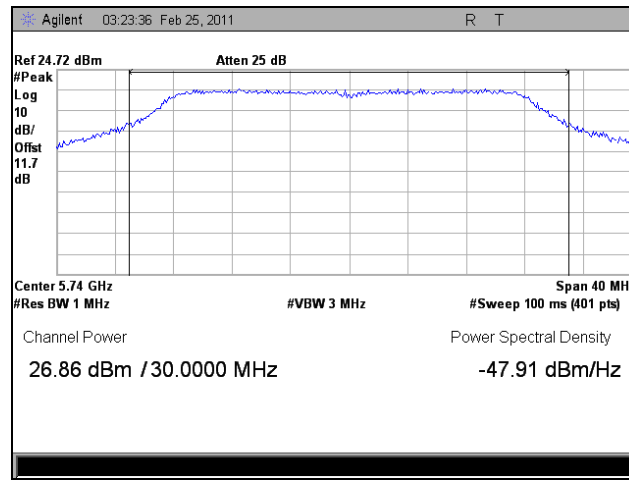

Plot 121. Peak Power Output, Low Channel, 802.11n HT30, Port 1

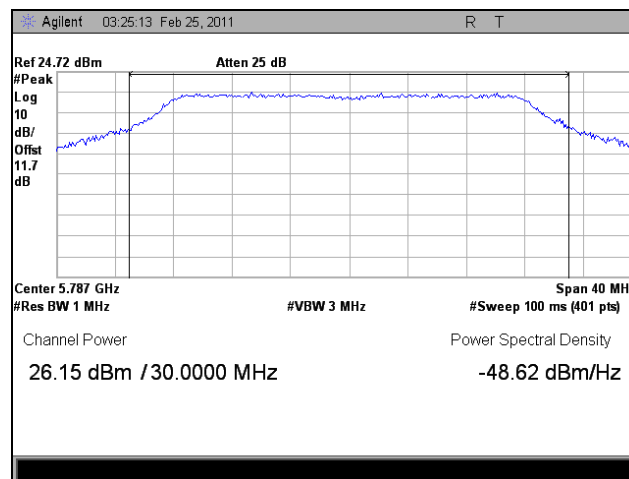

Plot 122. Peak Power Output, Mid Channel, 802.11n HT30, Port 1

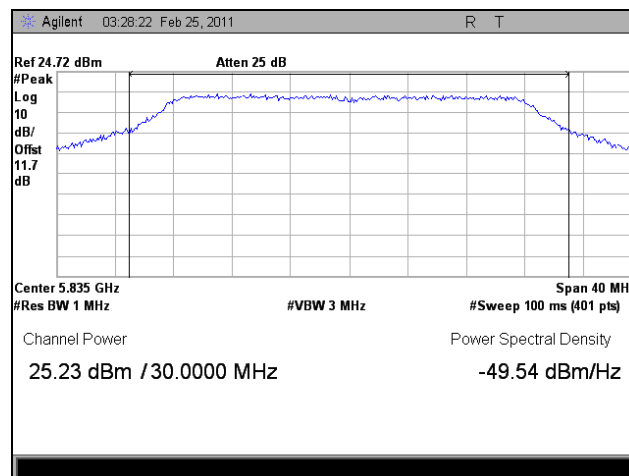

Plot 123. Peak Power Output, High Channel, 802.11n HT30, Port 1

Peak Power Output Test Results, 802.11n HT30, Port 2

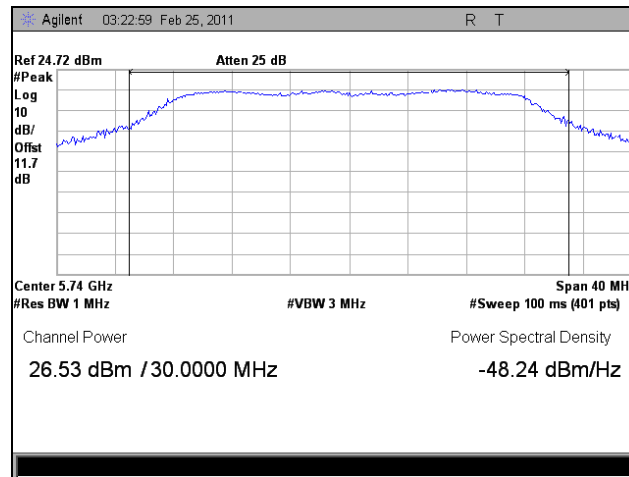

Plot 124. Peak Power Output, Low Channel, 802.11n HT30, Port 2

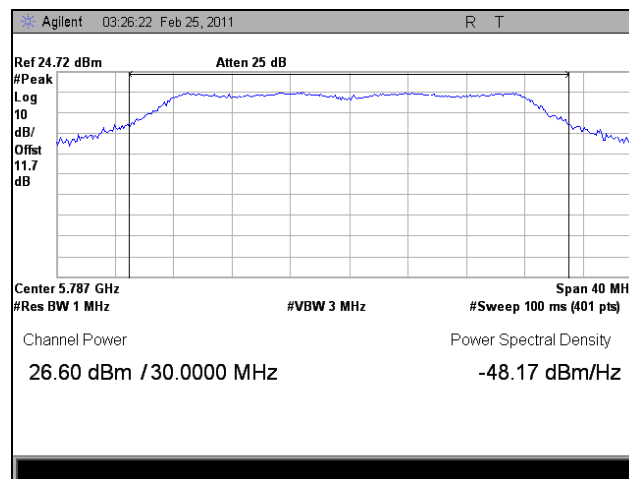

Plot 125. Peak Power Output, Mid Channel, 802.11n HT30, Port 2

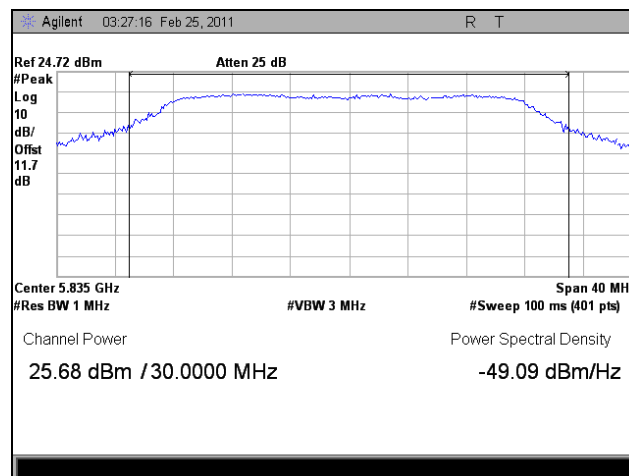

Plot 126. Peak Power Output, High Channel, 802.11n HT30, Port 2

Peak Power Output Test Results, 802.11n HT40, Port 1

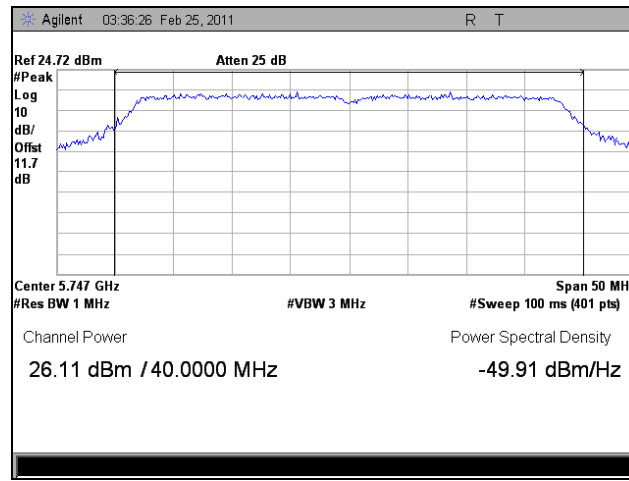

Plot 127. Peak Power Output, Low Channel, 802.11n HT40, Port 1

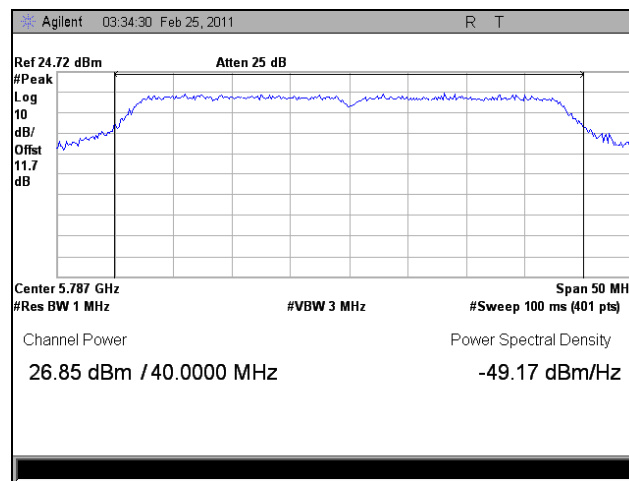

Plot 128. Peak Power Output, Mid Channel, 802.11n HT40, Port 1

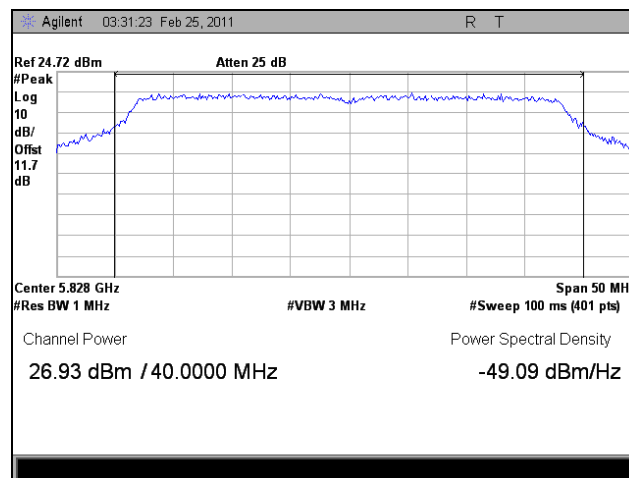

Plot 129. Peak Power Output, High Channel, 802.11n HT40, Port 1

Peak Power Output Test Results, 802.11n HT40, Port 2

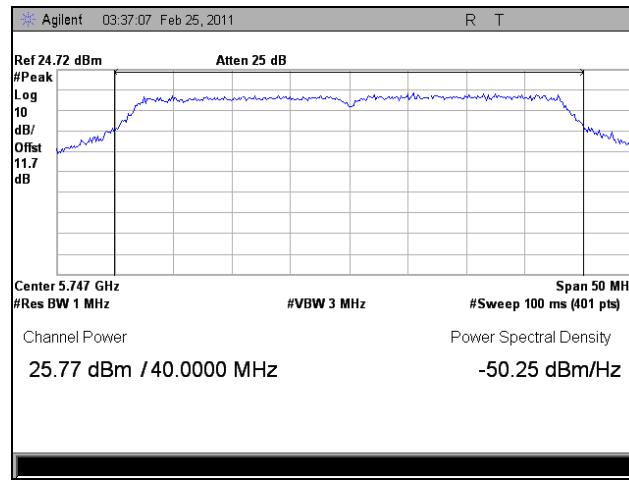

Plot 130. Peak Power Output, Low Channel, 802.11n HT40, Port 2

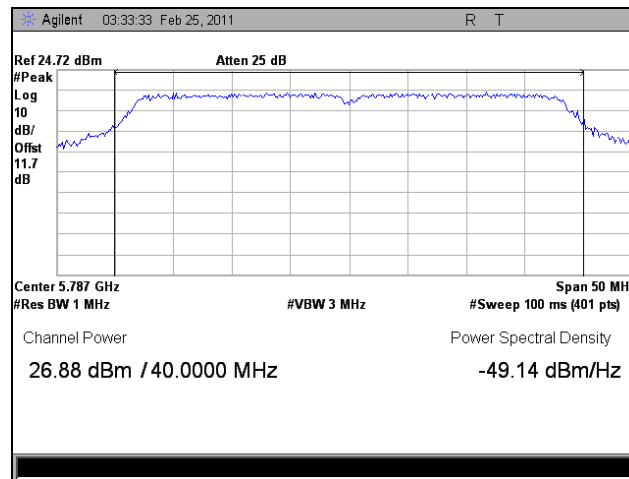

Plot 131. Peak Power Output, Mid Channel, 802.11n HT40, Port 2

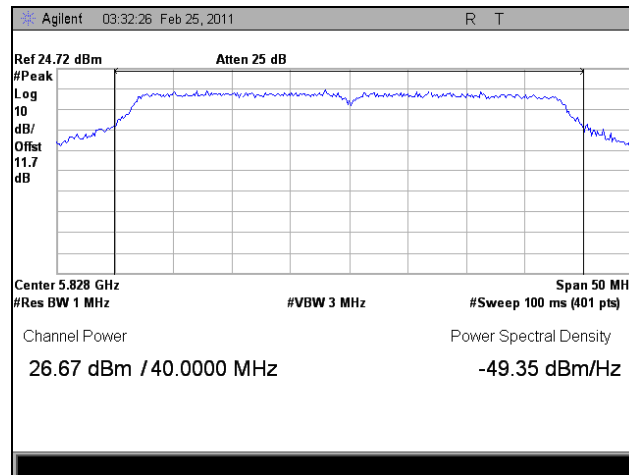

Plot 132. Peak Power Output, High Channel, 802.11n HT40, Port 2

Electromagnetic Compatibility Criteria for Intentional Radiators

§ 15.247(d) Radiated Spurious Emissions Requirements and Band Edge

Test Requirements: §15.247(d); §15.205: Emissions outside the frequency band.

§15.247(d): In any 100 kHz bandwidth outside the frequency band in which the spread spectrum or digitally modulated intentional radiator is operating, the radio frequency power that is produced by the intentional radiator shall be at least 20 dB below that in the 100 kHz bandwidth within the band that contains the highest level of the desired power, based on either an RF conducted or a radiated measurement. Attenuation below the general limits specified in § 15.209(a) is not required. In addition, radiated emissions which fall in the restricted bands, as defined in § 15.205(a), must also comply with the radiated emission limits specified in § 15.209(a).

§15.205(a): Except as shown in paragraph (d) of this section, only spurious emissions are permitted in any of the frequency bands listed below:

MHz	MHz	MHz	GHz
0.090–0.110-----	16.42–16.423	399.9–410	4.5–5.15
¹ 0.495–0.505-----	16.69475–16.69525	608–614	5.35–5.46
2.1735–2.1905-----	16.80425–16.80475	960–1240	7.25–7.75
4.125–4.128-----	25.5–25.67	1300–1427	8.025–8.5
4.17725–4.17775-----	37.5–38.25	1435–1626.5	9.0–9.2
4.20725–4.20775-----	73–74.6	1645.5–1646.5	9.3–9.5
6.215–6.218-----	74.8–75.2	1660–1710	10.6–12.7
6.26775–6.26825-----	108–121.94	1718.8–1722.2	13.25–13.4
6.31175–6.31225-----	123–138	2200–2300	14.47–14.5
8.291–8.294-----	149.9–150.05	2310–2390	15.35–16.2
8.362–8.366-----	156.52475–156.52525	2483.5–2500	17.7–21.4
8.37625–8.38675-----	156.7–156.9	2655–2900	22.01–23.12
8.41425–8.41475-----	162.0125–167.17	3260–3267	23.6–24.0
12.29–12.293-----	167.72–173.2	3332–3339	31.2–31.8
12.51975–12.52025-----	240–285	3345.8–3358 36.	43–36.5
12.57675–12.57725-----	322–335.4	3600–4400	(²)

Table 24. Restricted Bands of Operation

¹ Until February 1, 1999, this restricted band shall be 0.490 – 0.510 MHz.

² Above 38.6

Test Requirement(s): § 15.209 (a): Except as provided elsewhere in this subpart, the emissions from an intentional radiator shall not exceed the field strength levels specified in Table 25.

Frequency (MHz)	§ 15.209(a), Radiated Emission Limits (dB μ V) @ 3m
30 - 88	40.00
88 - 216	43.50
216 - 960	46.00
Above 960	54.00

Table 25. Radiated Emissions Limits Calculated from FCC Part 15, § 15.209 (a)

Test Procedures: The transmitter was turned on. Measurements were performed of the low, mid and high Channels. The EUT was rotated orthogonally through all three axes. Plots shown are corrected for both antenna correction factor and distance and compared to a 3 m limit line. Only noise floor was measured above 18 GHz.

Test Results: The EUT was compliant with the Radiated Spurious Emission limits of § 15.247(d).

Test Engineer(s): Lionel Gabrillo

Test Date(s): 02/23/11 – 3/16/11

Harmonic Emissions Requirements – Radiated

Frequency (MHz)	Antenna Polarity	EUT Azimuth (Degrees)	Antenna Height (cm)	Uncorrected Amplitude (dBuV)	ACF (dB/m)	Pre Amp Gain (dB)	CBL (dB)	DCF (dB)	Corrected Amplitude (dBuV)	Limit (dBuV)	Margin (dB)
43.8	V	0	100	26.29	10.08	0	1.643	0	38.013	40	-1.987

Table 26. Radiated Harmonic Emissions, 802.11n HT5

Note 1: No Emissions were seen above 18GHz.
Note 2: <100MHz peaks are not from the Radio.

Frequency (MHz)	Antenna Polarity	EUT Azimuth (Degrees)	Antenna Height (cm)	Uncorrected Amplitude (dBuV)	ACF (dB/m)	Pre Amp Gain (dB)	CBL (dB)	DCF (dB)	Corrected Amplitude (dBuV)	Limit (dBuV)	Margin (dB)
43.8	V	0	100	25.34	10.08	0	1.643	0	37.063	40	-2.937

Table 27. Radiated Harmonic Emissions, 802.11n HT8

Note 1: No Emissions were seen above 18GHz.
Note 2: <100MHz peaks are not from the Radio.

Frequency (MHz)	Antenna Polarity	EUT Azimuth (Degrees)	Antenna Height (cm)	Uncorrected Amplitude (dBuV)	ACF (dB/m)	Pre Amp Gain (dB)	CBL (dB)	DCF (dB)	Corrected Amplitude (dBuV)	Limit (dBuV)	Margin (dB)
43.8	V	0	100	26.21	10.08	0	1.643	0	37.933	40	-2.067

Table 28. Radiated Harmonic Emissions, 802.11n HT10

Note 1: No Emissions were seen above 18GHz.
Note 2: <100MHz peaks are not from the Radio.

Frequency (MHz)	Antenna Polarity	EUT Azimuth (Degrees)	Antenna Height (cm)	Uncorrected Amplitude (dBuV)	ACF (dB/m)	Pre Amp Gain (dB)	CBL (dB)	DCF (dB)	Corrected Amplitude (dBuV)	Limit (dBuV)	Margin (dB)
43.8	V	23.5	100.0	25.86	10.08	0	1.643	0	37.583	40	-2.417

Table 29. Radiated Harmonic Emissions, 802.11n HT20

Note 1: No Emissions were seen above 18GHz.
Note 2: <100MHz peaks are not from the Radio.

Frequency (MHz)	Antenna Polarity	EUT Azimuth (Degrees)	Antenna Height (cm)	Uncorrected Amplitude (dBuV)	ACF (dB/m)	Pre Amp Gain (dB)	CBL (dB)	DCF (dB)	Corrected Amplitude (dBuV)	Limit (dBuV)	Margin (dB)
43.8	V	16.0	100.0	25.82	10.08	0	1.643	0	37.543	40	-2.457

Table 30. Radiated Harmonic Emissions, 802.11n HT30

Note 1: No Emissions were seen above 18GHz.
Note 2: <100MHz peaks are not from the Radio.

Frequency (MHz)	Antenna Polarity	EUT Azimuth (Degrees)	Antenna Height (cm)	Uncorrected Amplitude (dBuV)	ACF (dB/m)	Pre Amp Gain (dB)	CBL (dB)	DCF (dB)	Corrected Amplitude (dBuV)	Limit (dBuV)	Margin (dB)
43.8	V	51.4	100	26.01	10.08	0	1.643	0	37.733	40	-2.267

Table 31. Radiated Harmonic Emissions, 802.11n HT40

Note 1: No Emissions were seen above 18GHz.
Note 2: <100MHz peaks are not from the Radio.

Radiated Spurious Emissions Test Results, 802.11a 20 MHz

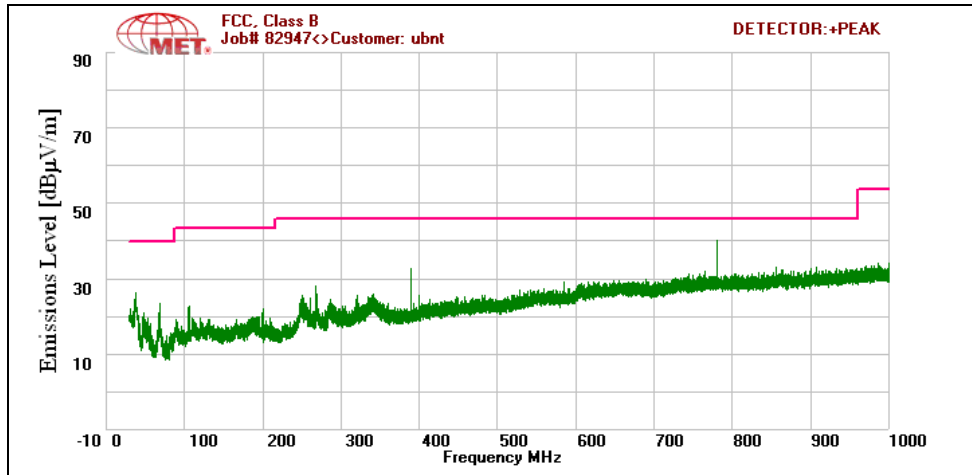

Plot 133. Radiated Spurious Emissions, Low Channel, 30 MHz – 1 GHz, 802.11a 20 MHz

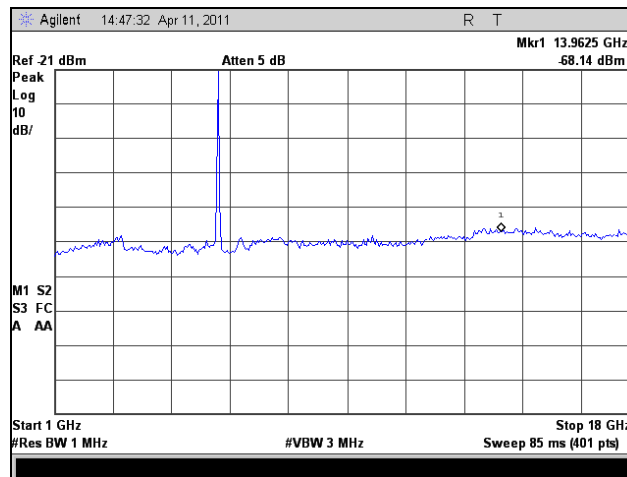

Plot 134. Radiated Spurious Emissions, Low Channel, 1 GHz – 18 GHz, 802.11a 20 MHz

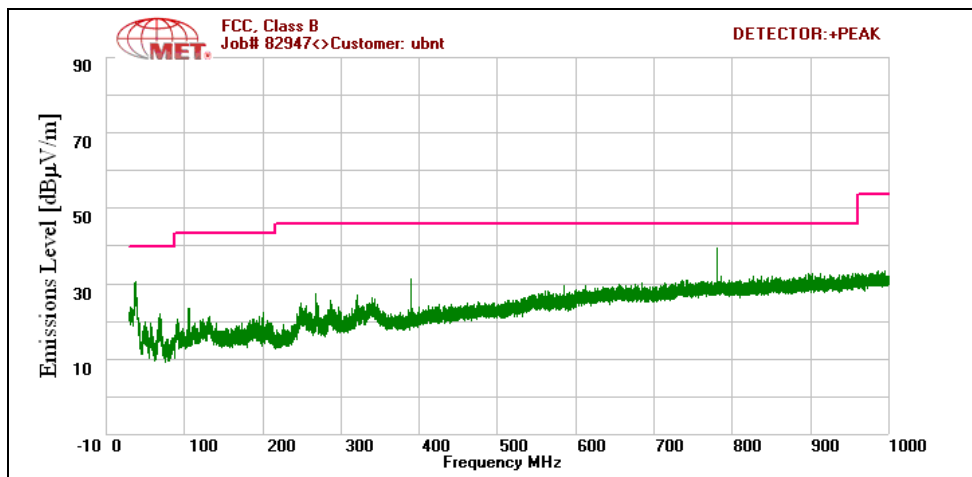

Plot 135. Radiated Spurious Emissions, Mid Channel, 30 MHz – 1 GHz, 802.11a 20 MHz

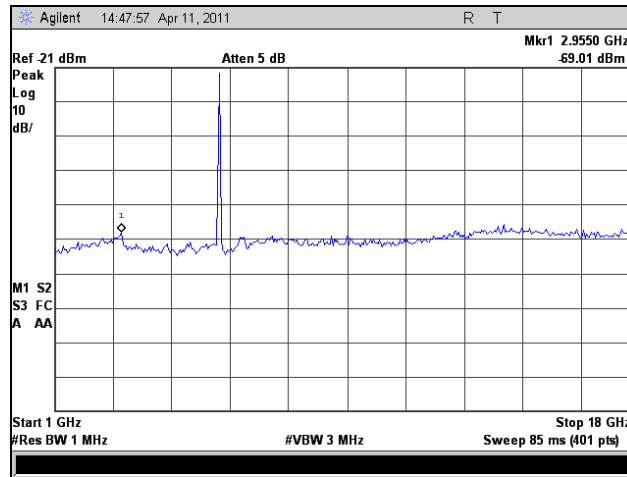

Plot 136. Radiated Spurious Emissions, Mid Channel, 1 GHz – 18 GHz, 802.11a 20 MHz

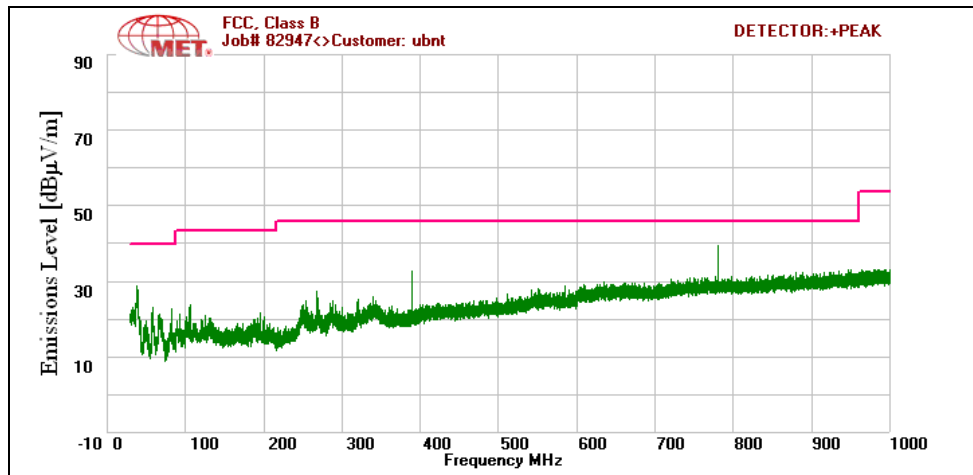

Plot 137. Radiated Spurious Emissions, High Channel, 30 MHz – 1 GHz, 802.11a 20 MHz

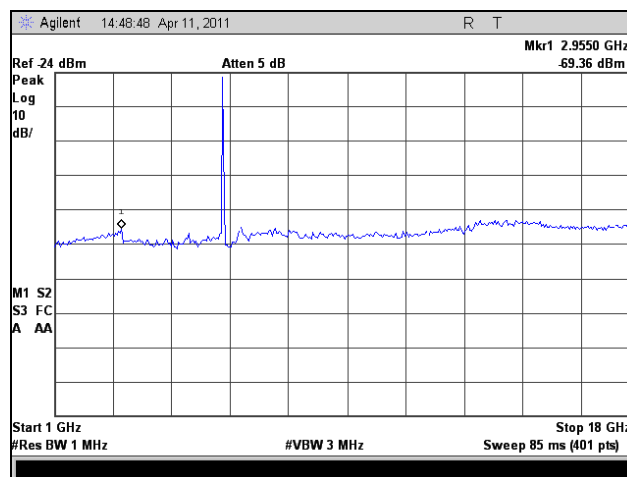

Plot 138. Radiated Spurious Emissions, High Channel, 1 GHz – 18 GHz, 802.11a 20 MHz

Radiated Spurious Emissions Test Results, 802.11a 40 MHz

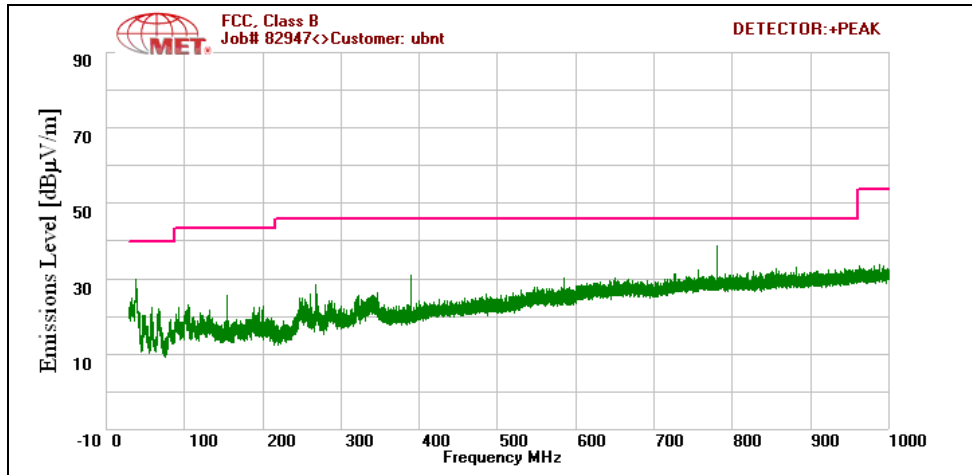

Plot 139. Radiated Spurious Emissions, Low Channel, 30 MHz – 1 GHz, 802.11a 40 MHz

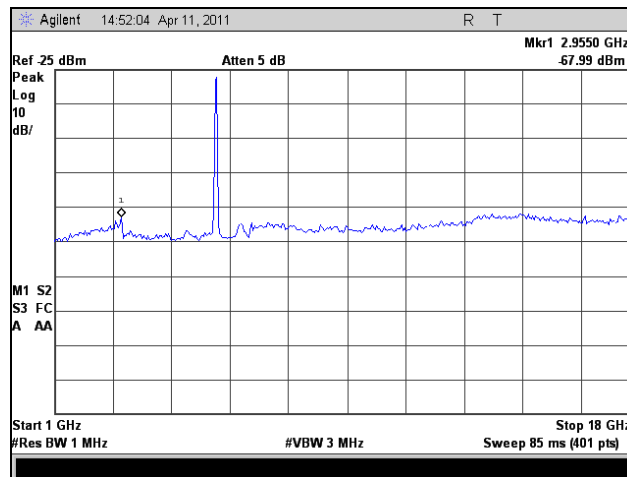

Plot 140. Radiated Spurious Emissions, Low Channel, 1 GHz – 18 GHz, 802.11a 40 MHz

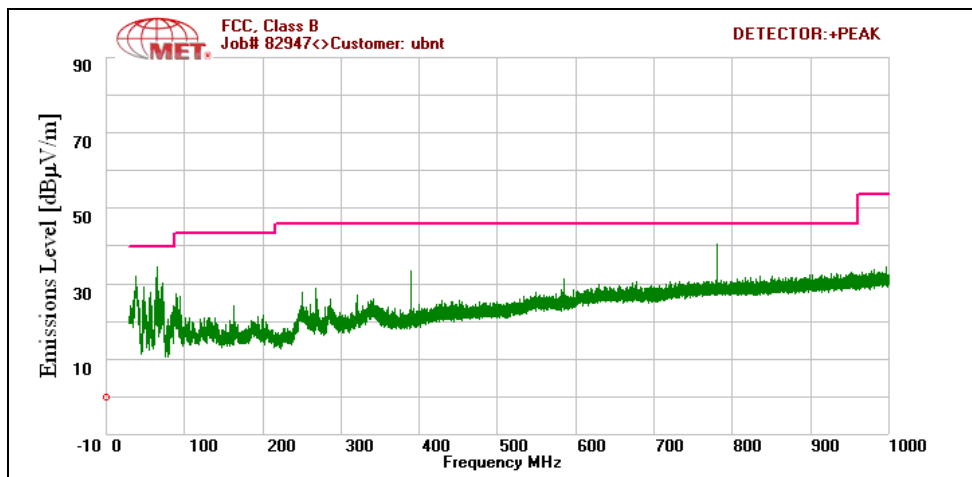

Plot 141. Radiated Spurious Emissions, Mid Channel, 30 MHz – 1 GHz, 802.11a 40 MHz

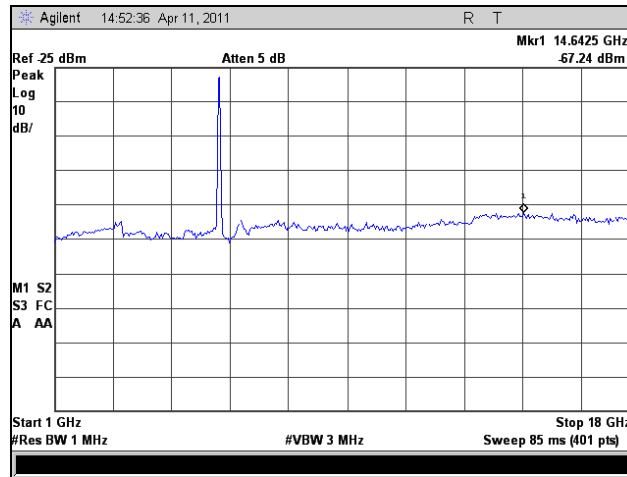

Plot 142. Radiated Spurious Emissions, Mid Channel, 1 GHz – 18 GHz, 802.11a 40 MHz

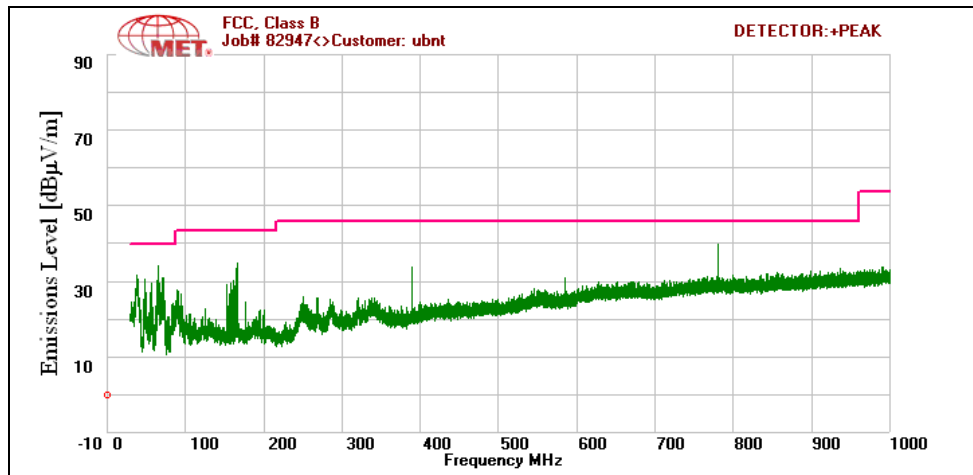

Plot 143. Radiated Spurious Emissions, High Channel, 30 MHz – 1 GHz, 802.11a 40 MHz

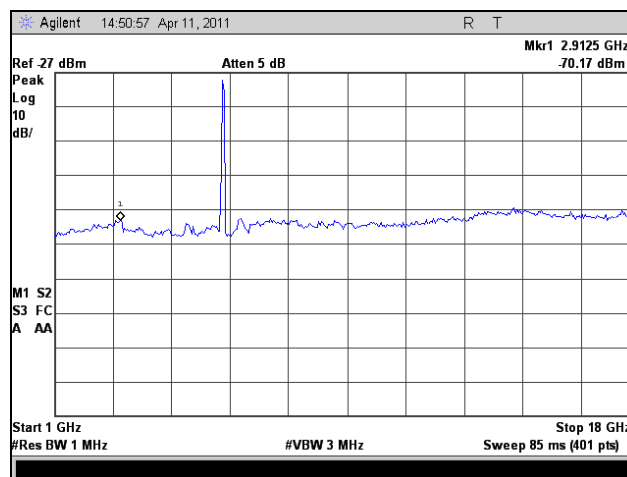

Plot 144. Radiated Spurious Emissions, High Channel, 1 GHz – 18 GHz, 802.11a 40 MHz

Radiated Spurious Emissions Test Results, 802.11n HT5

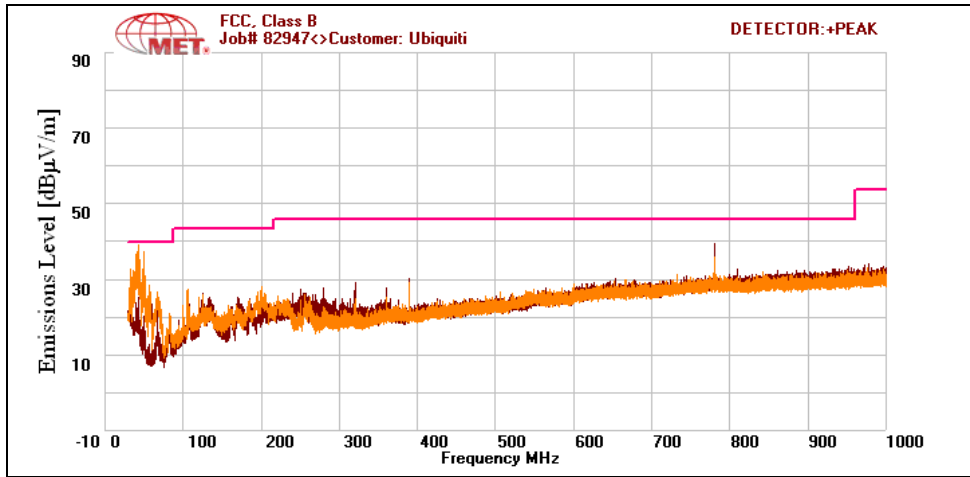

Plot 145. Radiated Spurious Emissions, Low Channel, 30 MHz – 1 GHz, 802.11n HT5

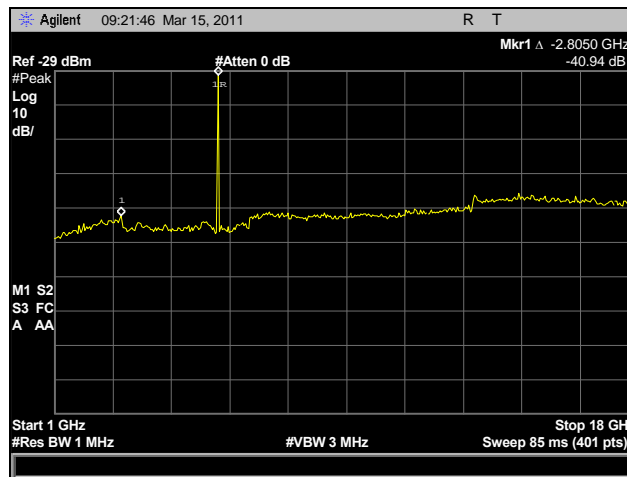

Plot 146. Radiated Spurious Emissions, Low Channel, 1 GHz – 18 GHz, 802.11n HT5

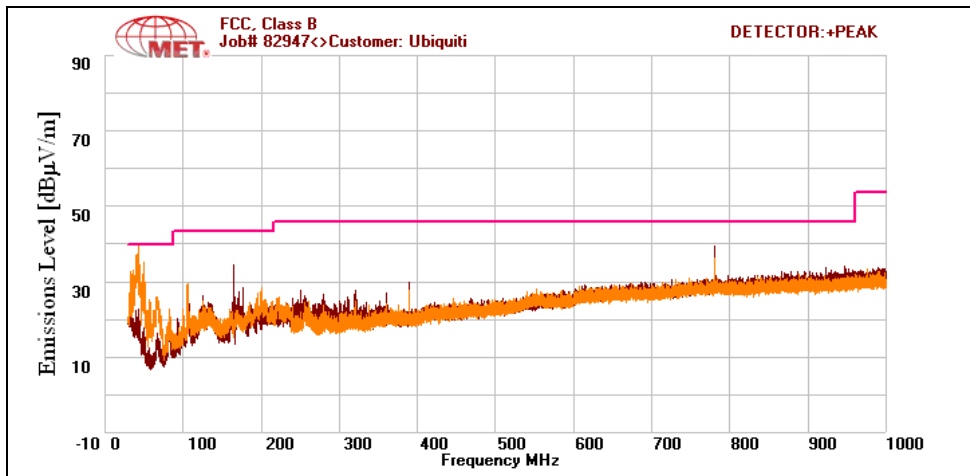

Plot 147. Radiated Spurious Emissions, Mid Channel, 30 MHz – 1 GHz, 802.11n HT5

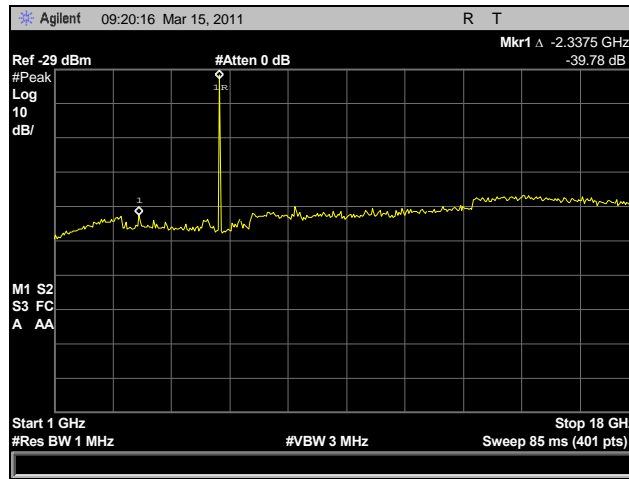

Plot 148. Radiated Spurious Emissions, Mid Channel, 1 GHz – 18 GHz, 802.11n HT5

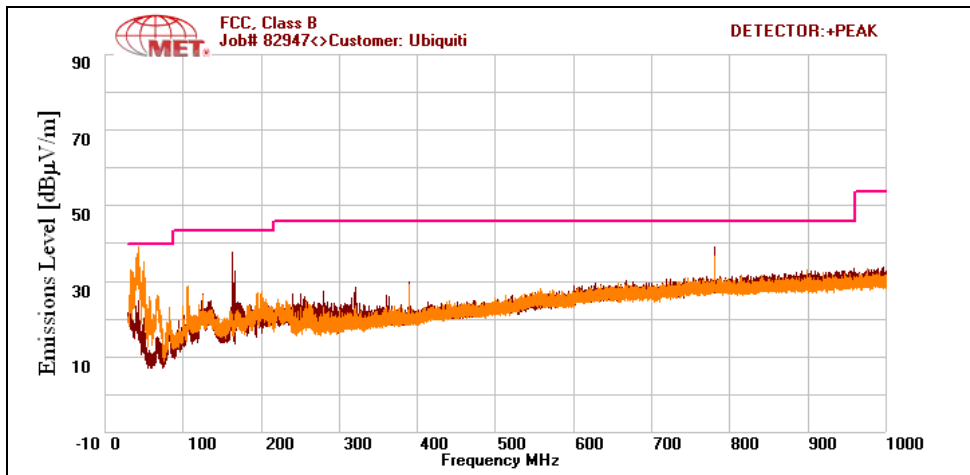

Plot 149. Radiated Spurious Emissions, High Channel, 30 MHz – 1 GHz, 802.11n HT5

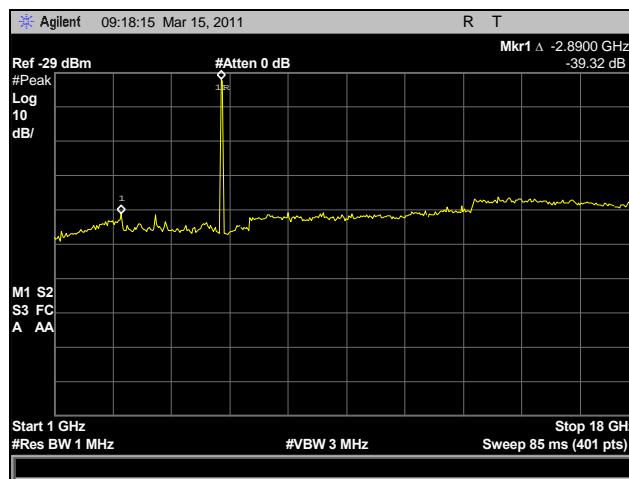

Plot 150. Radiated Spurious Emissions, High Channel, 1 GHz – 18 GHz, 802.11n HT5

Radiated Spurious Emissions Test Results, 802.11n HT8

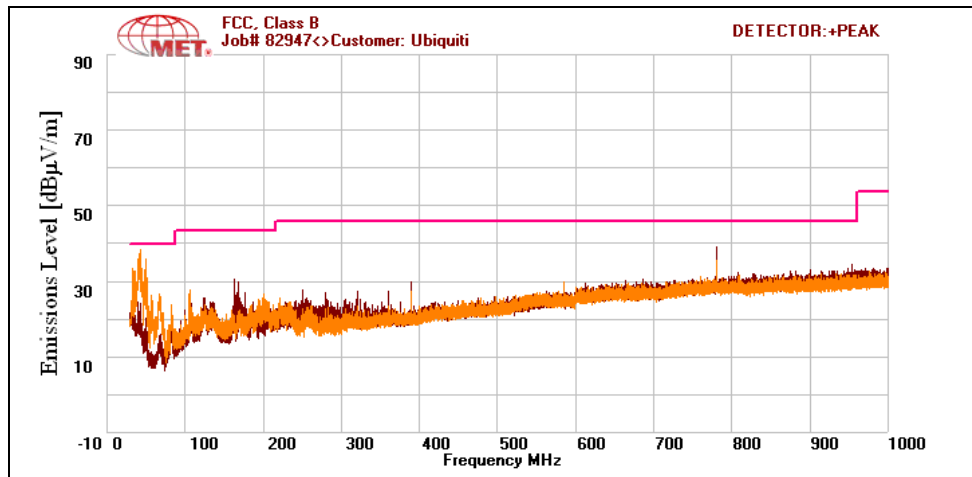

Plot 151. Radiated Spurious Emissions, Low Channel, 30 MHz – 1 GHz, 802.11n HT8

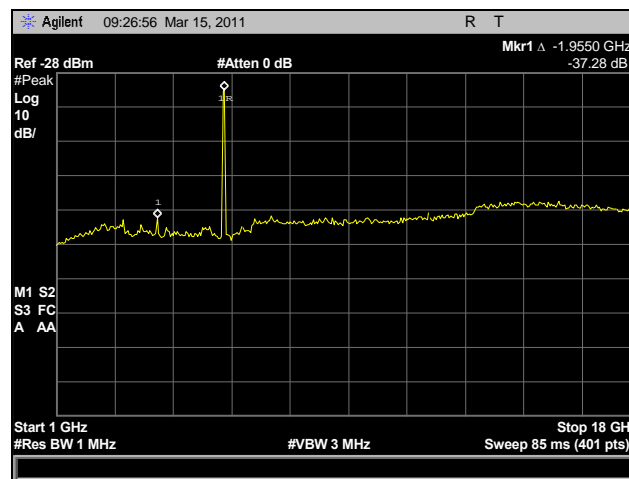

Plot 152. Radiated Spurious Emissions, Low Channel, 1 GHz – 18 GHz, 802.11n HT8

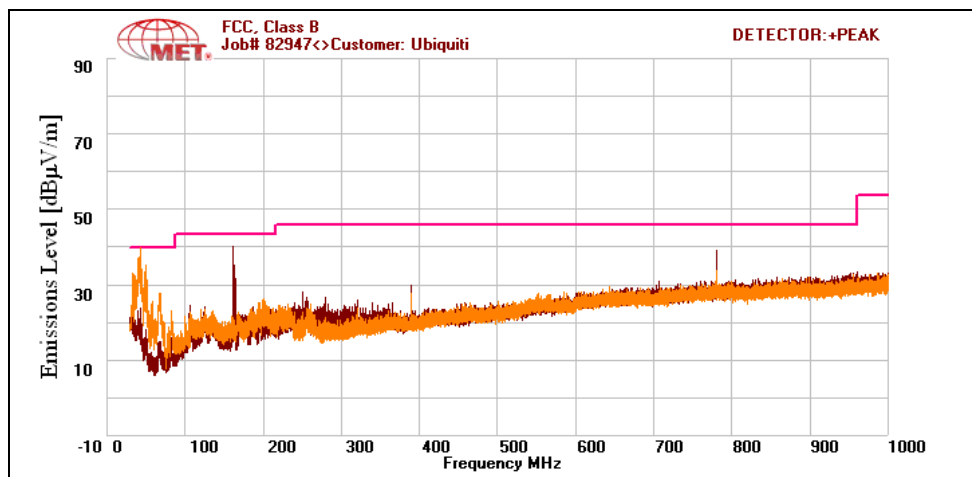

Plot 153. Radiated Spurious Emissions, Mid Channel, 30 MHz – 1 GHz, 802.11n HT8

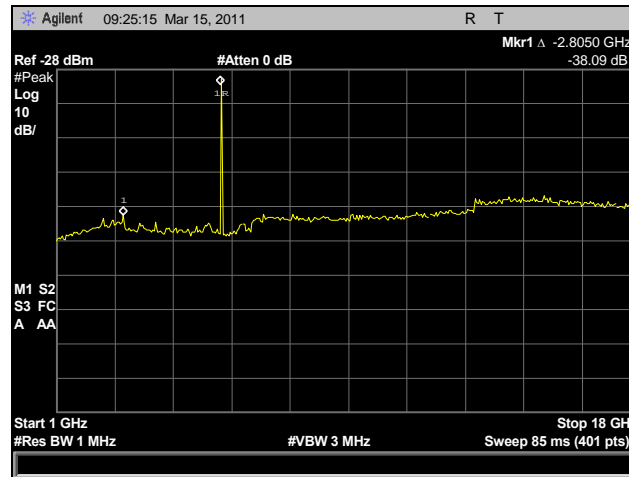

Plot 154. Radiated Spurious Emissions, Mid Channel, 1 GHz – 18 GHz, 802.11n HT8

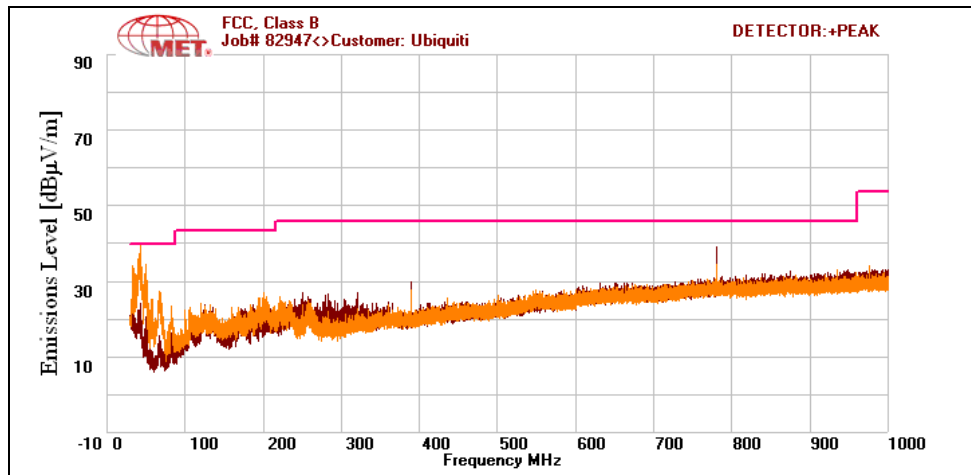

Plot 155. Radiated Spurious Emissions, High Channel, 30 MHz – 1 GHz, 802.11n HT8

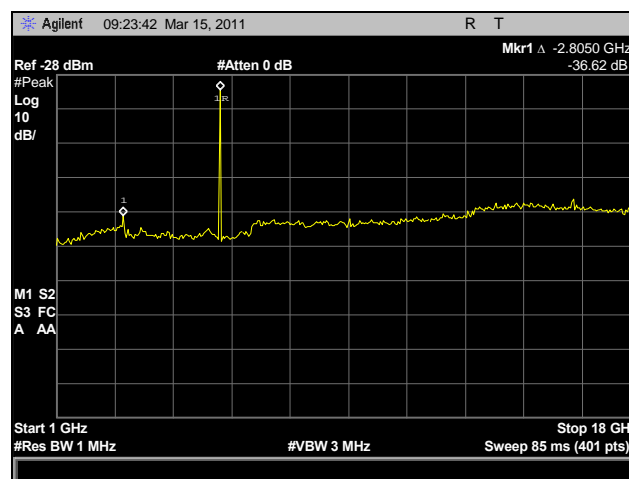

Plot 156. Radiated Spurious Emissions, High Channel, 1 GHz – 18 GHz, 802.11n HT8

Radiated Spurious Emissions Test Results, 802.11n HT10

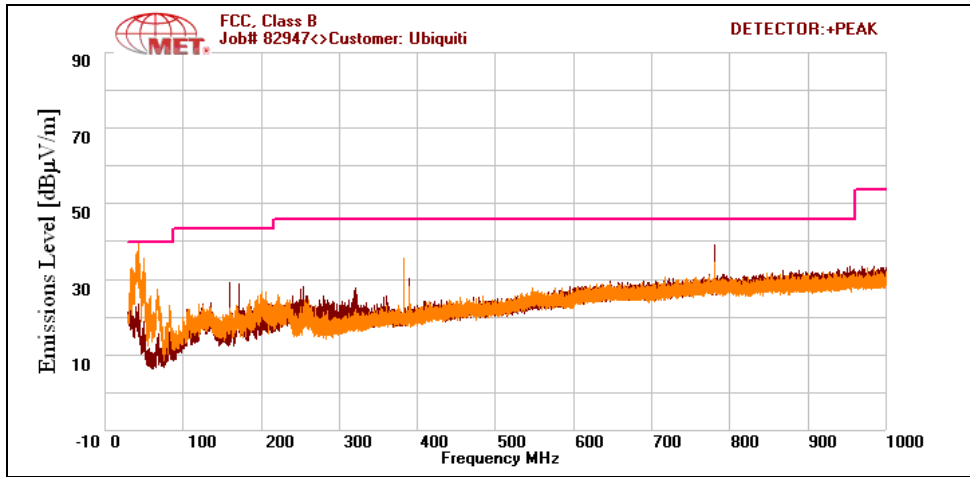

Plot 157. Radiated Spurious Emissions, Low Channel, 30 MHz – 1 GHz, 802.11n HT10

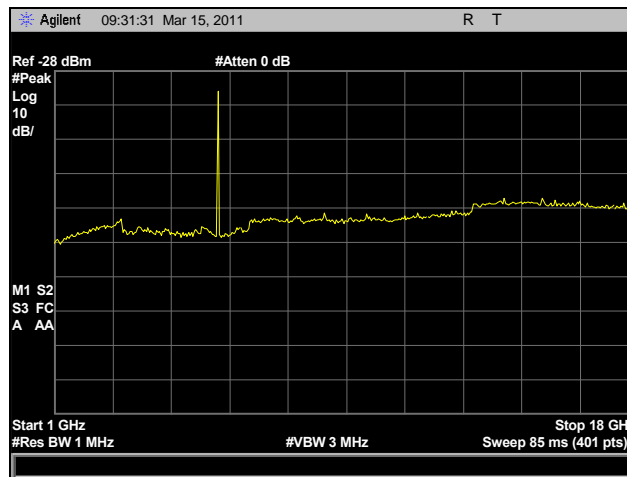

Plot 158. Radiated Spurious Emissions, Low Channel, 1 GHz – 18 GHz, 802.11n HT10

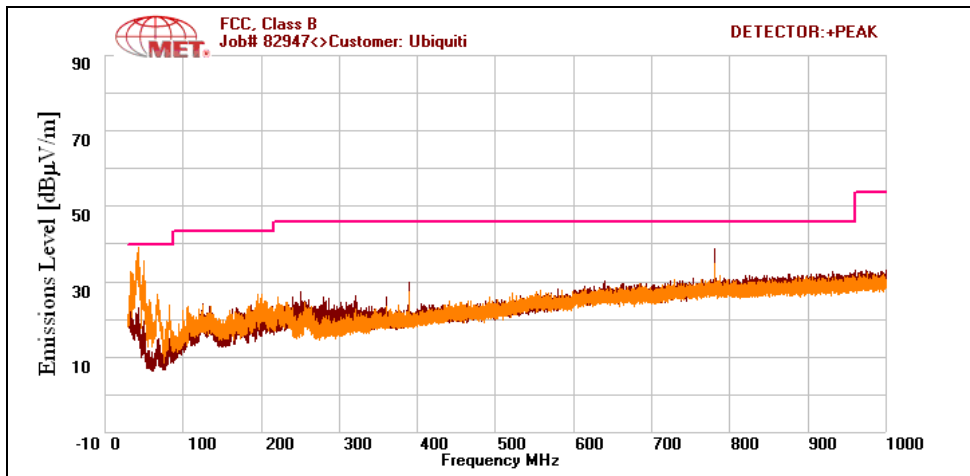

Plot 159. Radiated Spurious Emissions, Mid Channel, 30 MHz – 1 GHz, 802.11n HT10

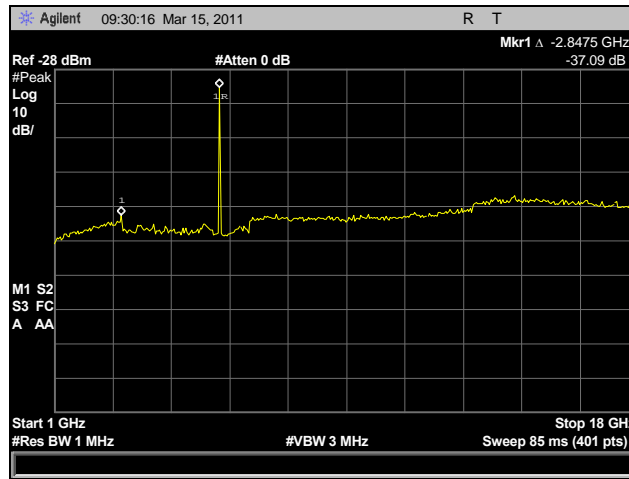

Plot 160. Radiated Spurious Emissions, Mid Channel, 1 GHz – 18 GHz, 802.11n HT10

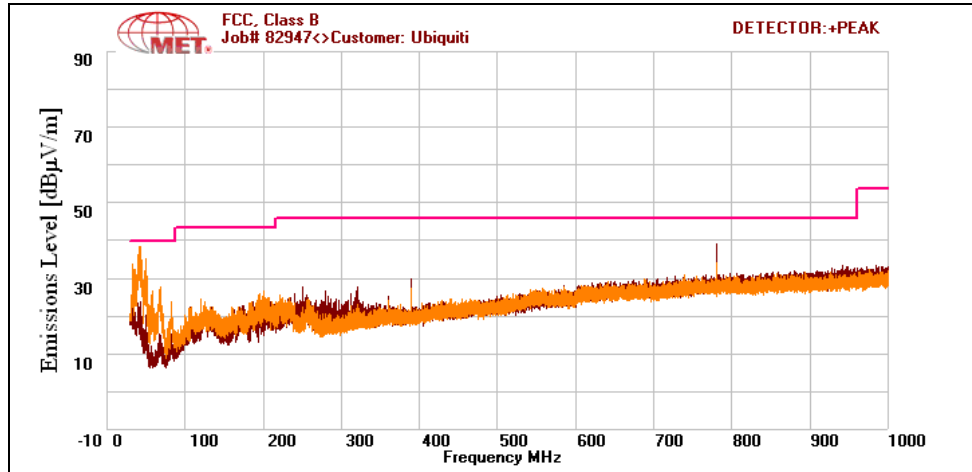

Plot 161. Radiated Spurious Emissions, High Channel, 30 MHz – 1 GHz, 802.11n HT10

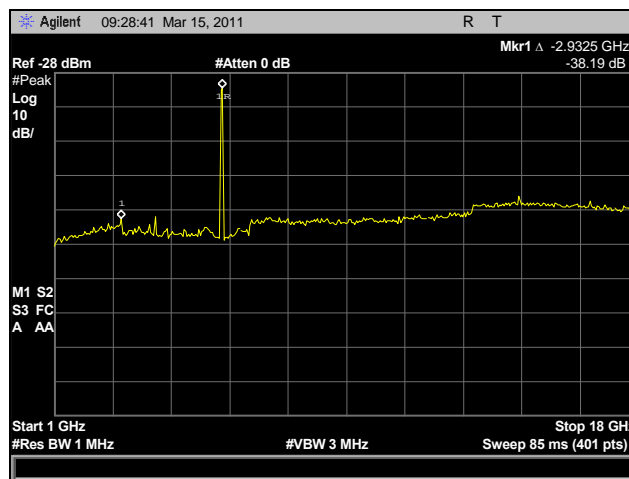

Plot 162. Radiated Spurious Emissions, High Channel, 1 GHz – 18 GHz, 802.11n HT10

Radiated Spurious Emissions Test Results, 802.11n HT20

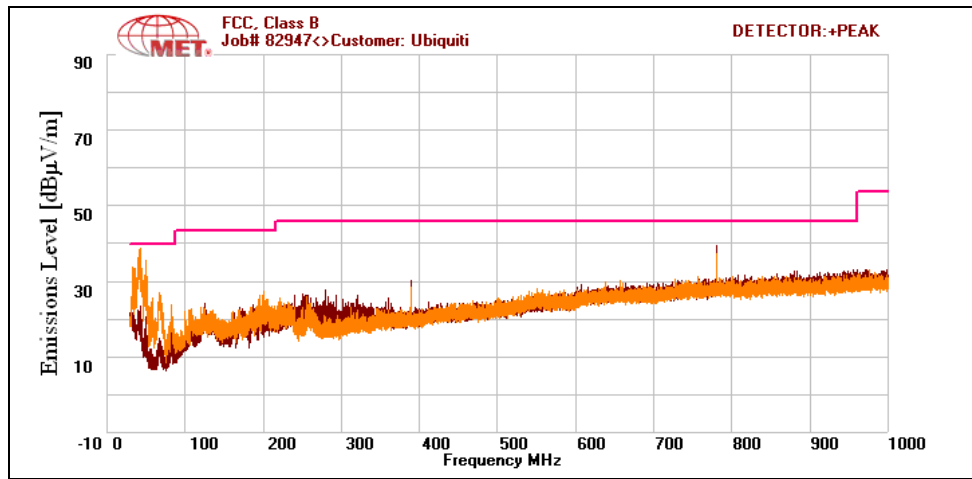

Plot 163. Radiated Spurious Emissions, Low Channel, 30 MHz – 1 GHz, 802.11n HT20

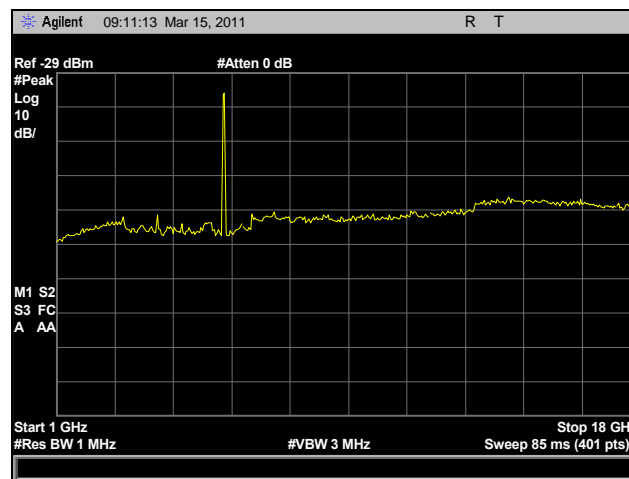

Plot 164. Radiated Spurious Emissions, Low Channel, 1 GHz – 18 GHz, 802.11n HT20

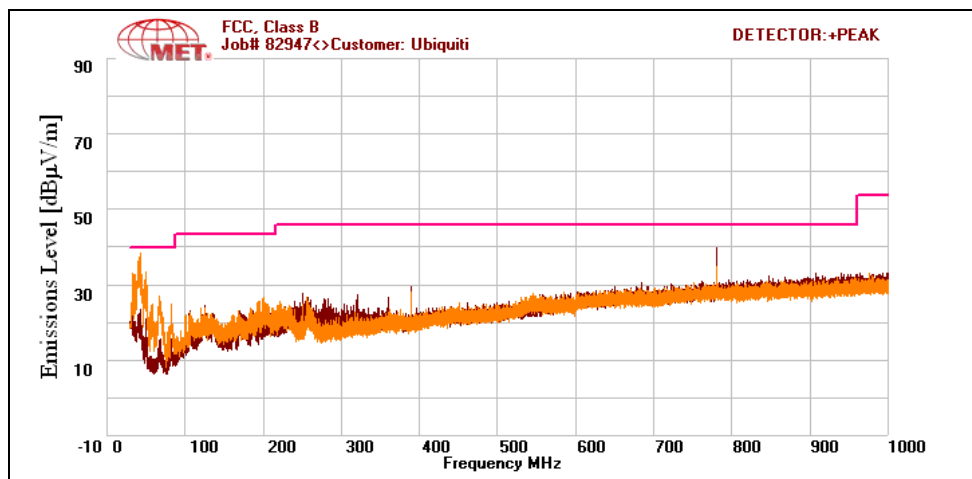

Plot 165. Radiated Spurious Emissions, Mid Channel, 30 MHz – 1 GHz, 802.11n HT20

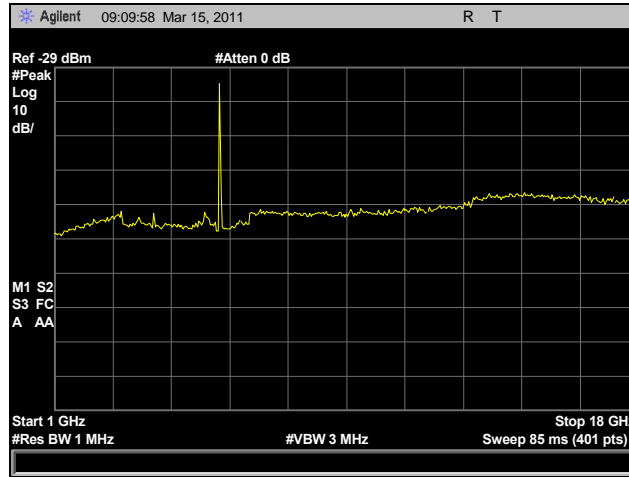

Plot 166. Radiated Spurious Emissions, Mid Channel, 1 GHz – 18 GHz, 802.11n HT20

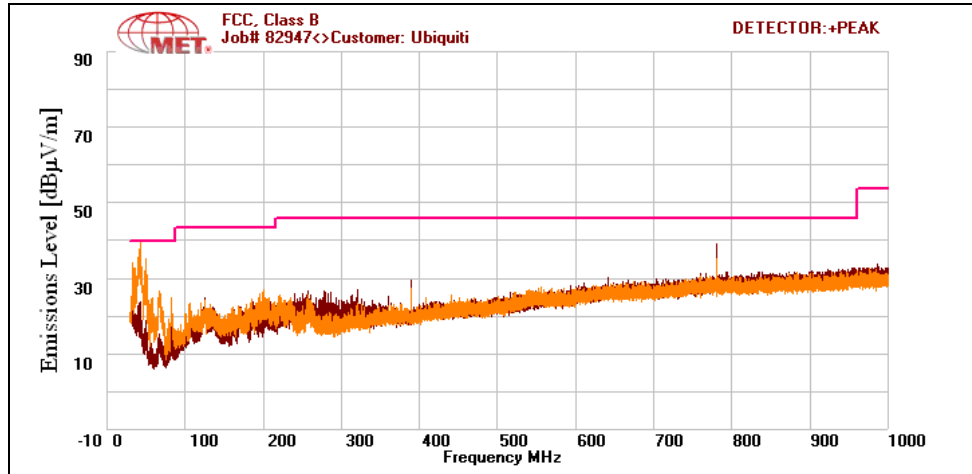

Plot 167. Radiated Spurious Emissions, High Channel, 30 MHz – 1 GHz, 802.11n HT20

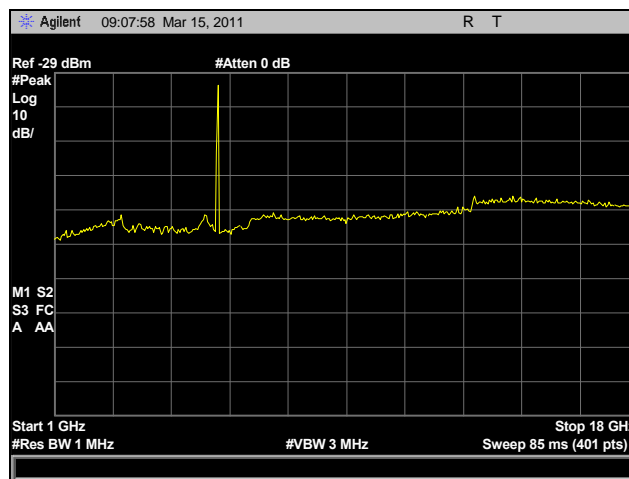

Plot 168. Radiated Spurious Emissions, High Channel, 1 GHz – 18 GHz, 802.11n HT20

Radiated Spurious Emissions Test Results, 802.11n HT30

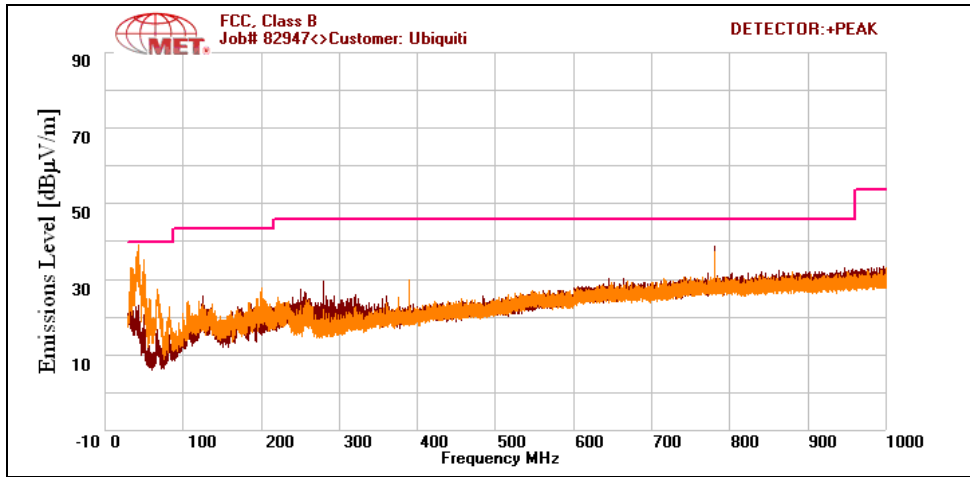

Plot 169. Radiated Spurious Emissions, Low Channel, 30 MHz – 1 GHz, 802.11n HT30

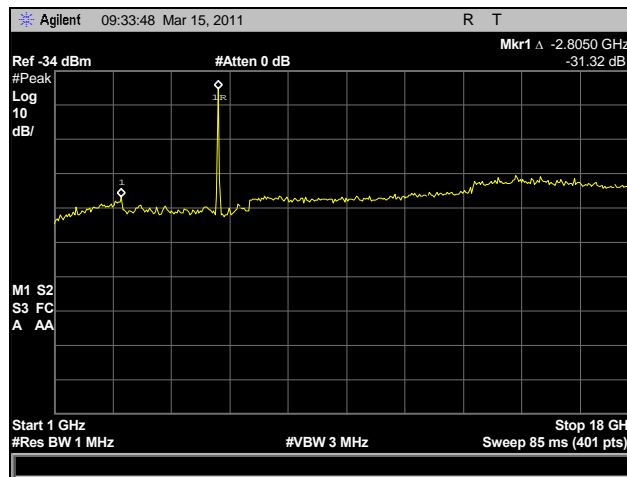

Plot 170. Radiated Spurious Emissions, Low Channel, 1 GHz – 18 GHz, 802.11n HT30

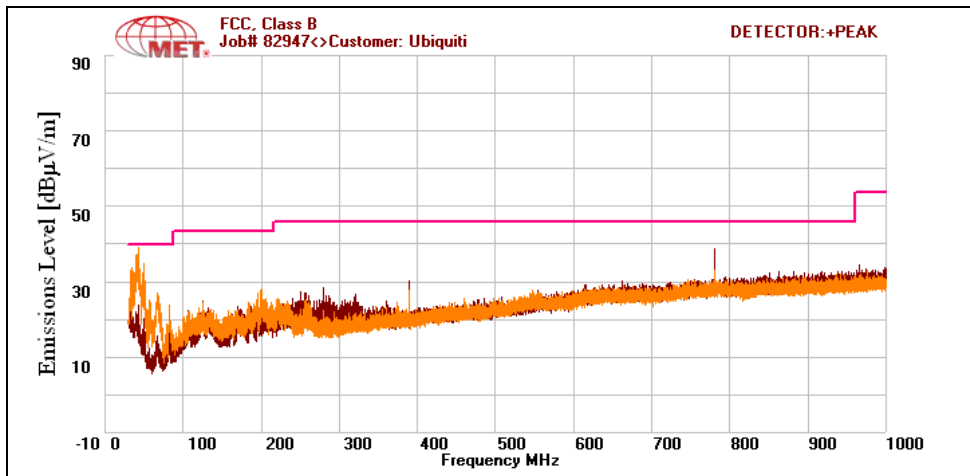

Plot 171. Radiated Spurious Emissions, Mid Channel, 30 MHz – 1 GHz, 802.11n HT30

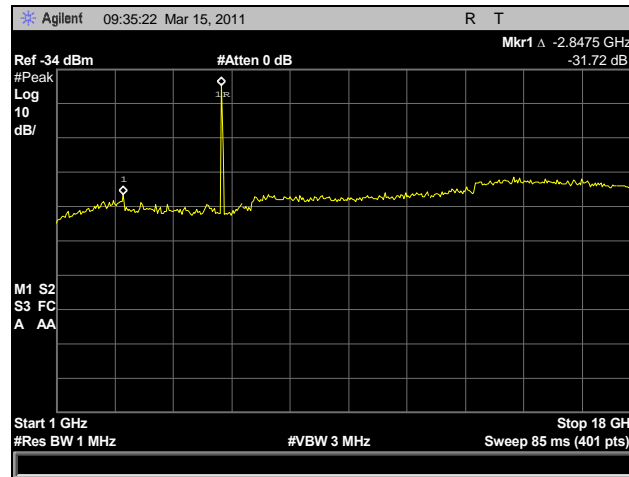

Plot 172. Radiated Spurious Emissions, Mid Channel, 1 GHz – 18 GHz, 802.11n HT30

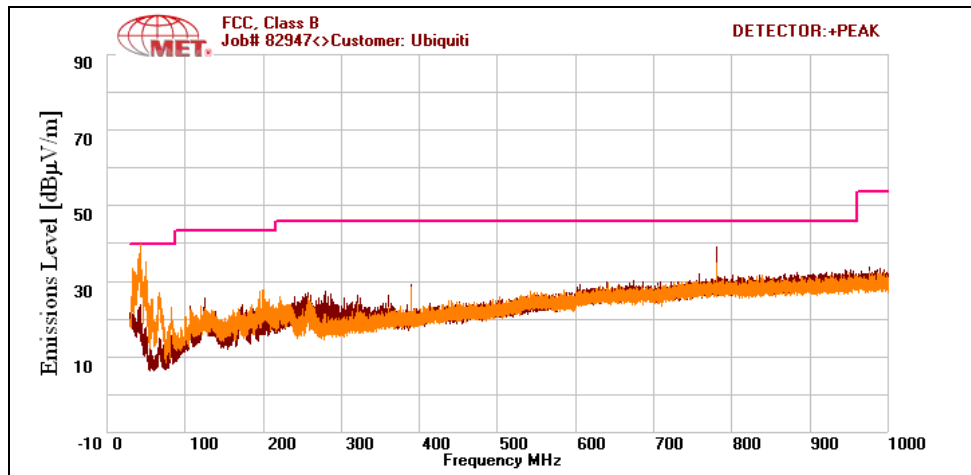

Plot 173. Radiated Spurious Emissions, High Channel, 30 MHz – 1 GHz, 802.11n HT30

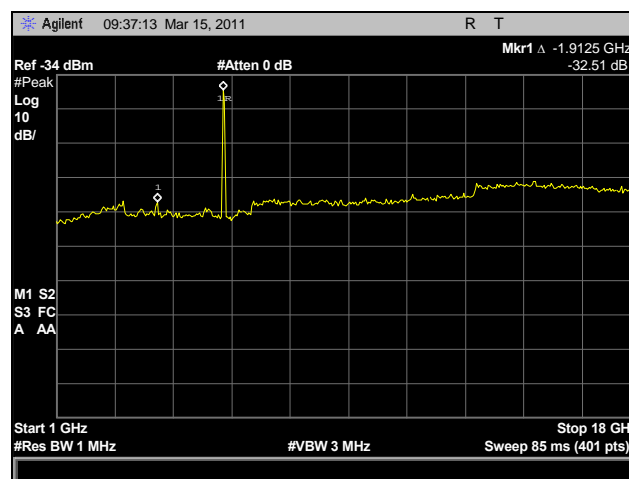

Plot 174. Radiated Spurious Emissions, High Channel, 1 GHz – 18 GHz, 802.11n HT30

Radiated Spurious Emissions Test Results, 802.11n HT40

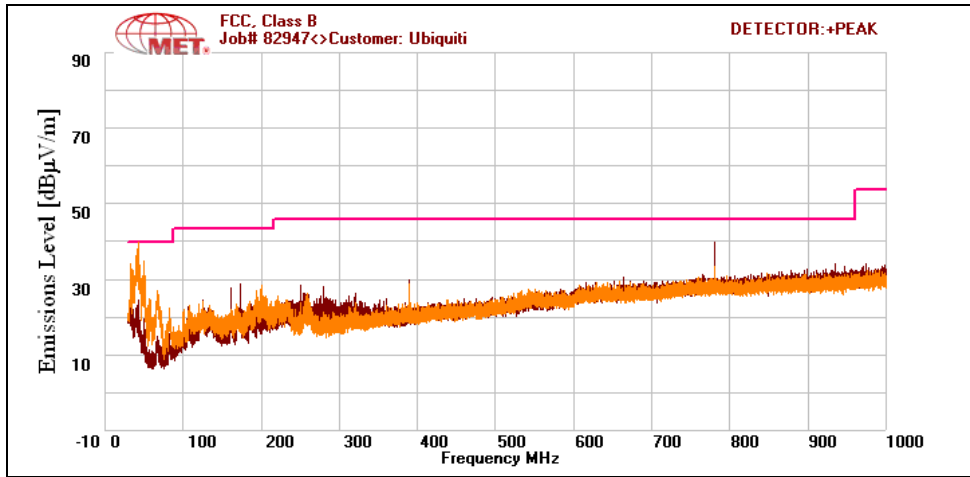

Plot 175. Radiated Spurious Emissions, Low Channel, 30 MHz – 1 GHz, 802.11n HT40

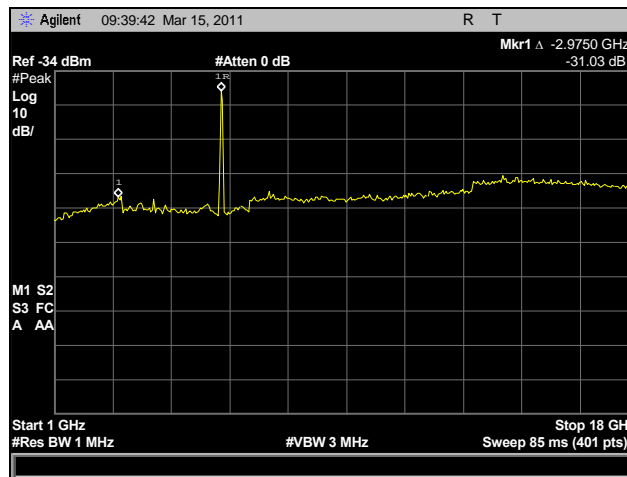

Plot 176. Radiated Spurious Emissions, Low Channel, 1 GHz – 18 GHz, 802.11n HT40

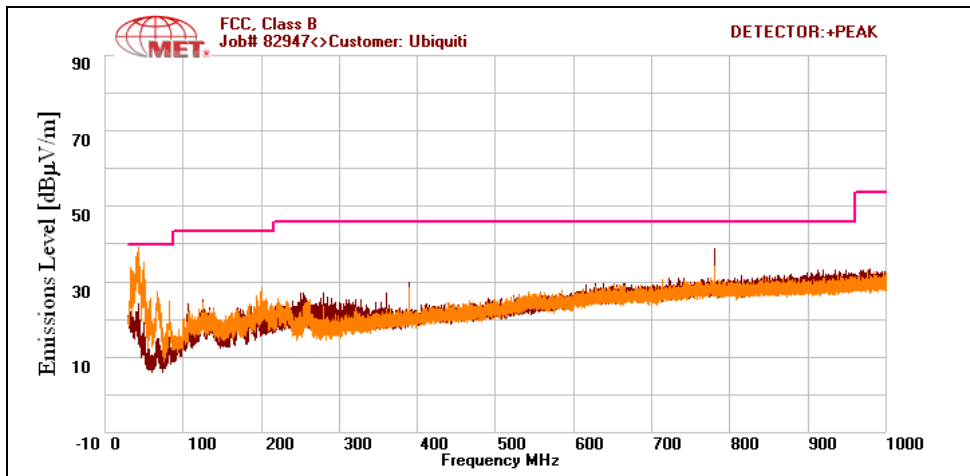

Plot 177. Radiated Spurious Emissions, Mid Channel, 30 MHz – 1 GHz, 802.11n HT40

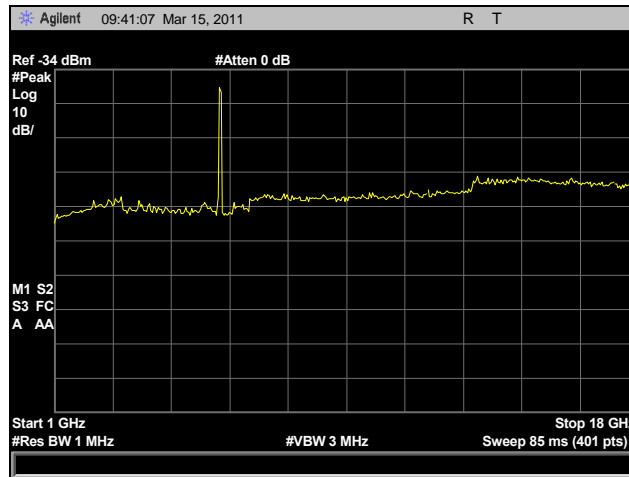

Plot 178. Radiated Spurious Emissions, Mid Channel, 1 GHz – 18 GHz, 802.11n HT40

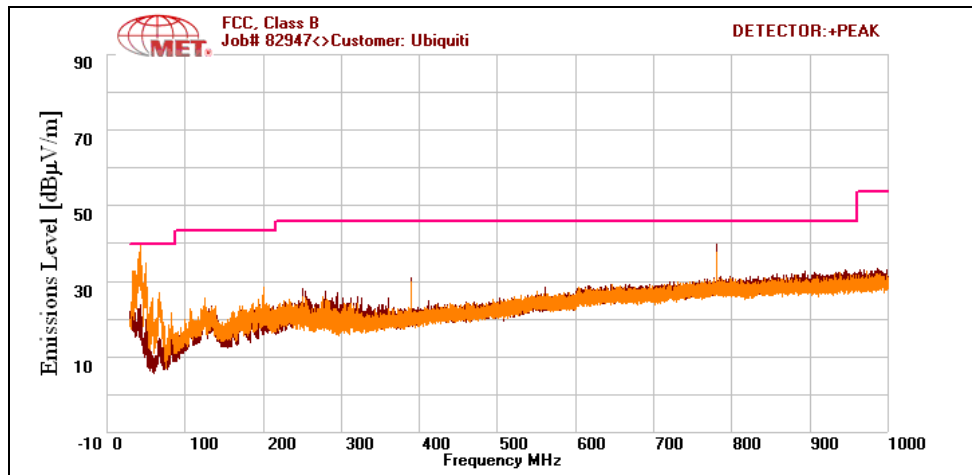

Plot 179. Radiated Spurious Emissions, High Channel, 30 MHz – 1 GHz, 802.11n HT40

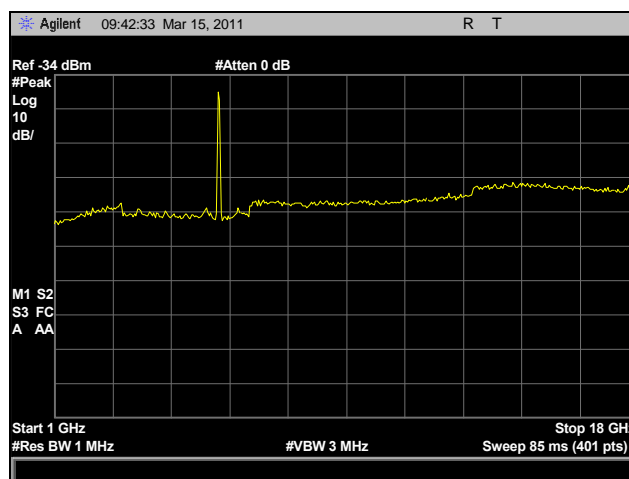

Plot 180. Radiated Spurious Emissions, High Channel, 1 GHz – 18 GHz, 802.11n HT40

Radiated Harmonics Test Results, 802.11a 20 MHz

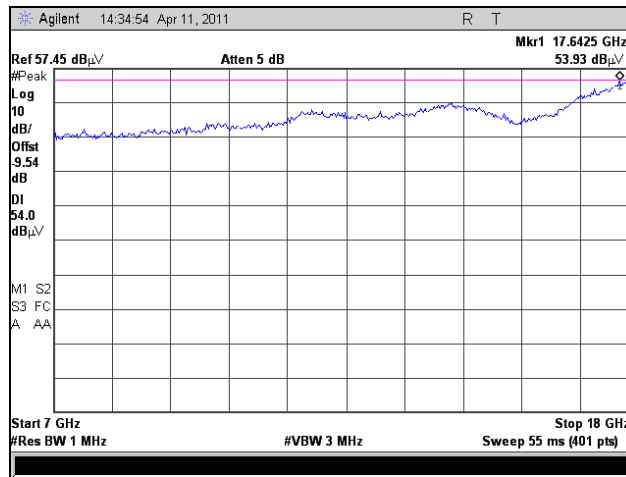

Plot 181. Radiated Harmonics, Low Channel, 7 GHz – 18 GHz, 802.11a 20 MHz

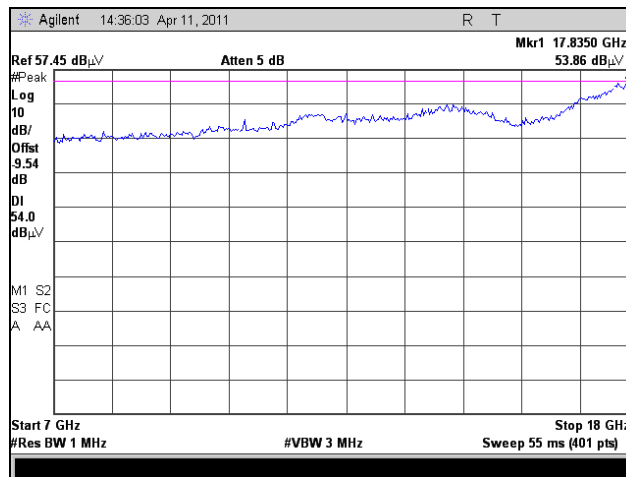

Plot 182. Radiated Harmonics, Low Channel, 7 GHz – 18 GHz, 802.11a 20 MHz

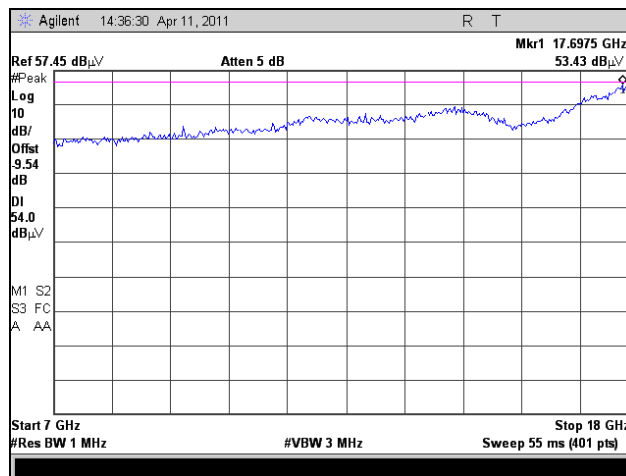

Plot 183. Radiated Harmonics, Mid Channel, 7 GHz – 18 GHz, 802.11a 20 MHz

Radiated Harmonics Test Results, 802.11a 40 MHz

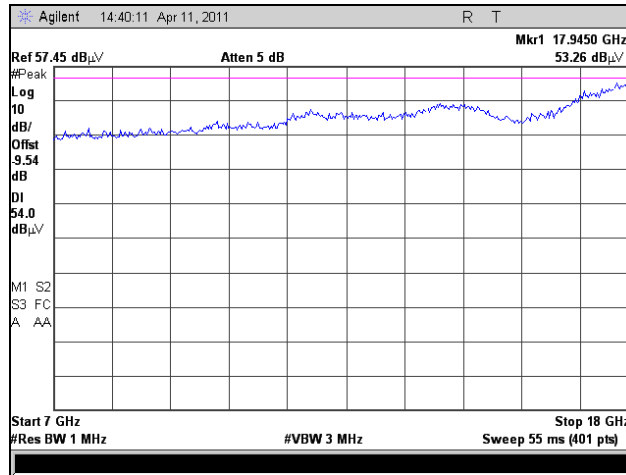

Plot 184. Radiated Harmonics, Low Channel, 7 GHz – 18 GHz, 802.11a 40 MHz

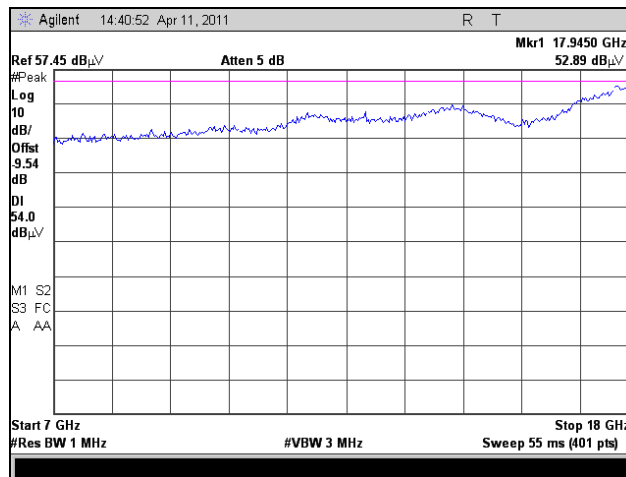

Plot 185. Radiated Harmonics, Low Channel, 7 GHz – 18 GHz, 802.11a 40 MHz

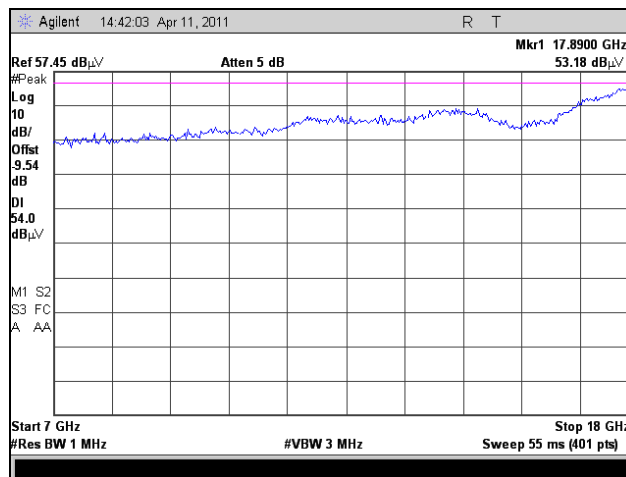

Plot 186. Radiated Harmonics, Mid Channel, 7 GHz – 18 GHz, 802.11a 40 MHz

Radiated Harmonics Test Results, 802.11n HT5

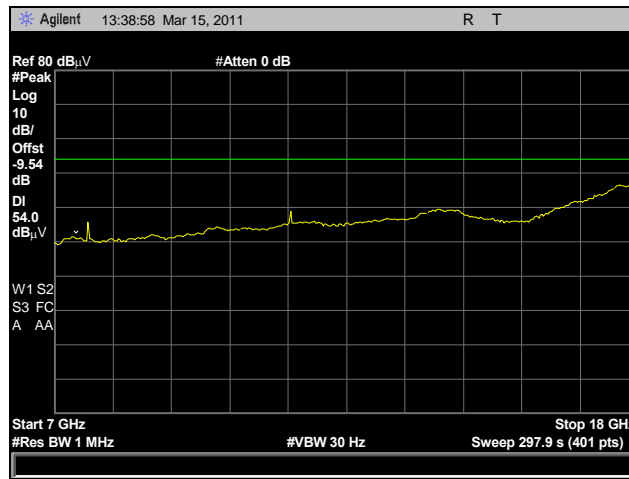

Plot 187. Radiated Harmonics, Low Channel, 7 GHz – 18 GHz, Average, 802.11n HT5

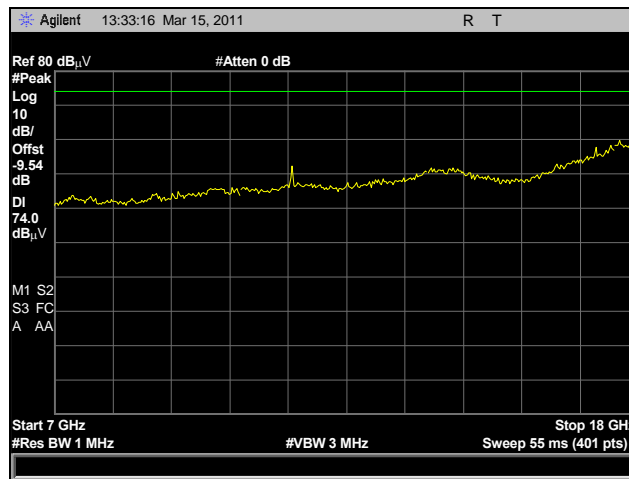

Plot 188. Radiated Harmonics, Low Channel, 7 GHz – 18 GHz, Peak, 802.11n HT5

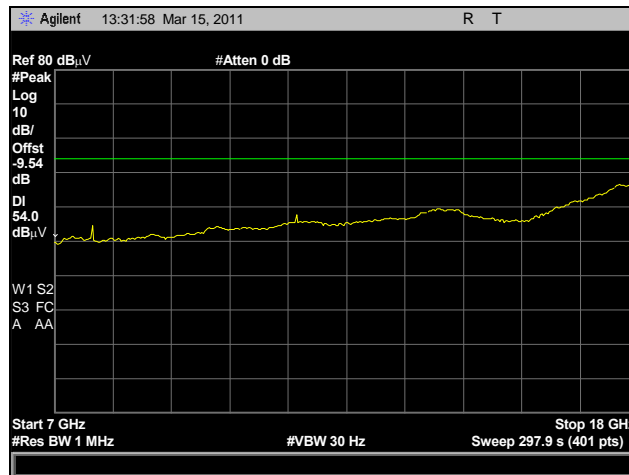

Plot 189. Radiated Harmonics, Mid Channel, 7 GHz – 18 GHz, Average, 802.11n HT5

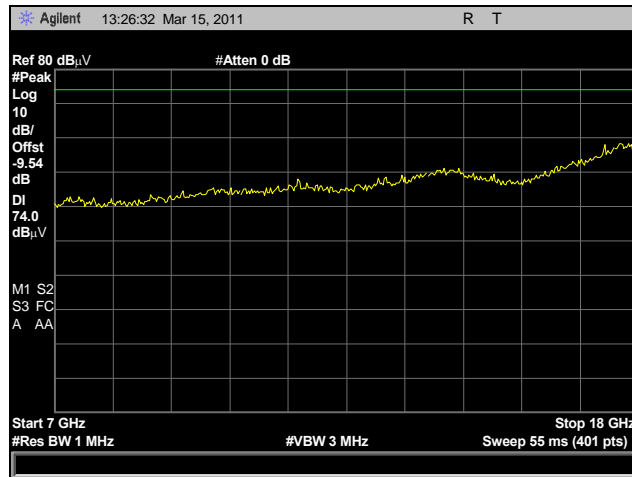

Plot 190. Radiated Harmonics, Mid Channel, 7 GHz – 18 GHz, Peak, 802.11n HT5

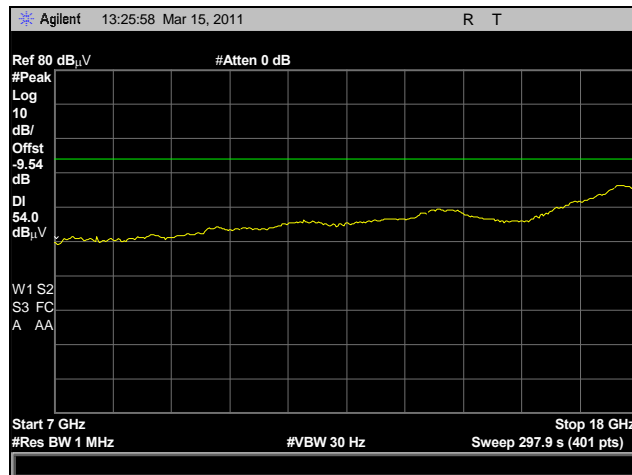

Plot 191. Radiated Harmonics, High Channel, 7 GHz – 18 GHz, Average, 802.11n HT5

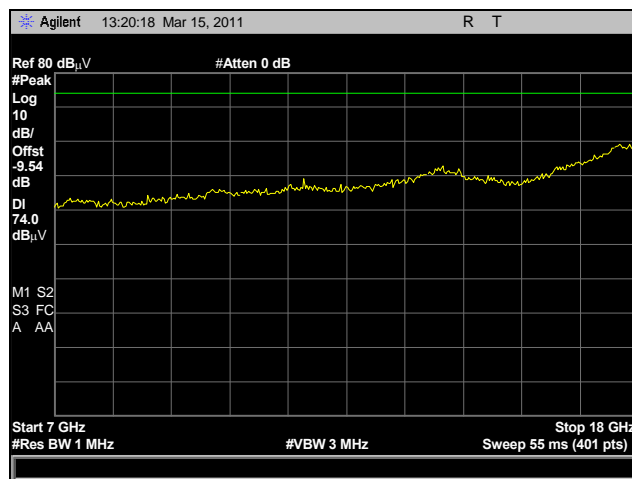

Plot 192. Radiated Harmonics, High Channel, 7 GHz – 18 GHz, Peak, 802.11n HT5

Radiated Harmonics Test Results, 802.11n HT8

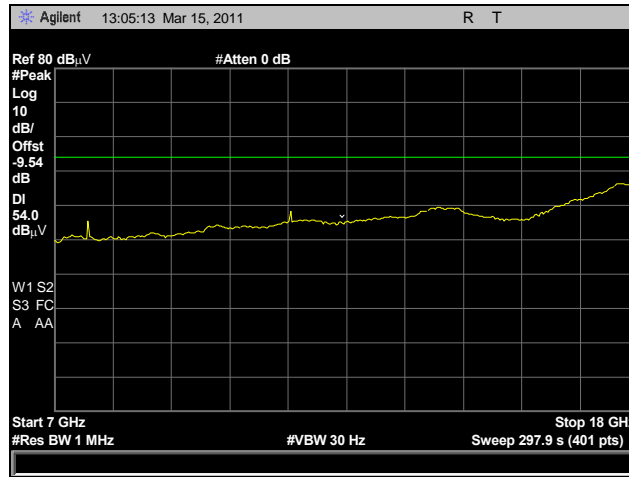

Plot 193. Radiated Harmonics, Low Channel, 7 GHz – 18 GHz, Average, 802.11n HT8

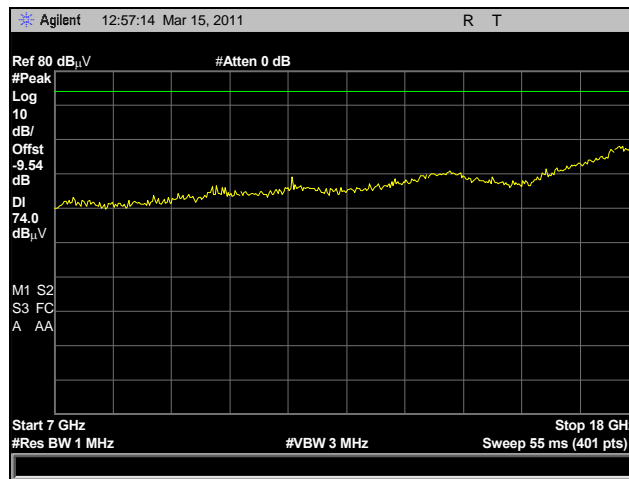

Plot 194. Radiated Harmonics, Low Channel, 7 GHz – 18 GHz, Peak, 802.11n HT8

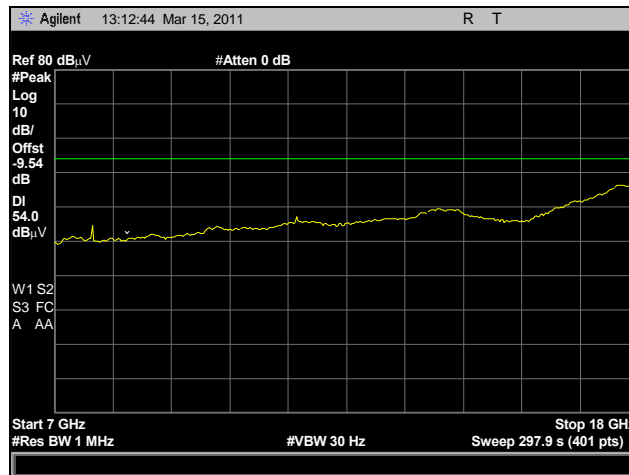

Plot 195. Radiated Harmonics, Mid Channel, 7 GHz – 18 GHz, Average, 802.11n HT8

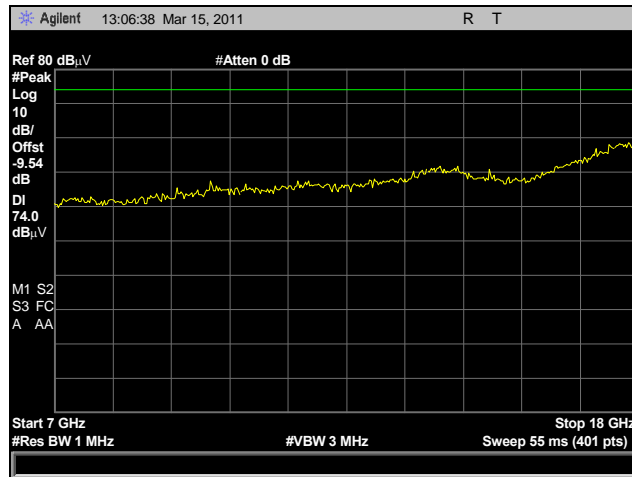

Plot 196. Radiated Harmonics, Mid Channel, 7 GHz – 18 GHz, Peak, 802.11n HT8

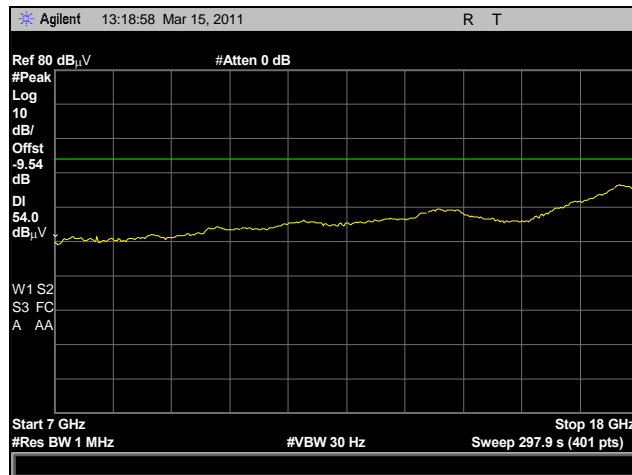

Plot 197. Radiated Harmonics, High Channel, 7 GHz – 18 GHz, Average, 802.11n HT8

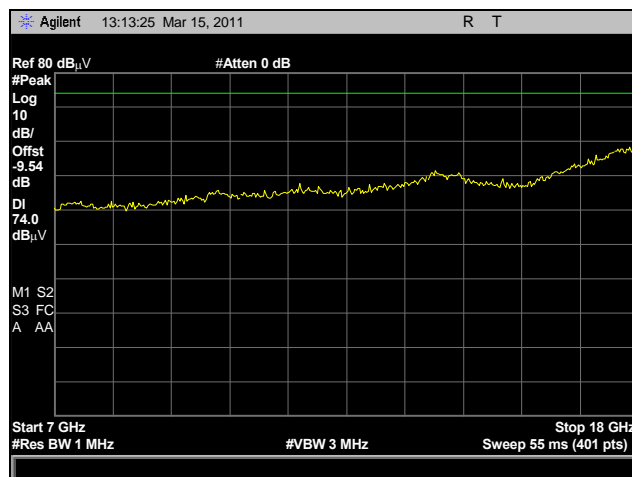

Plot 198. Radiated Harmonics, High Channel, 7 GHz – 18 GHz, Peak, 802.11n HT8

Radiated Harmonics Test Results, 802.11n HT10

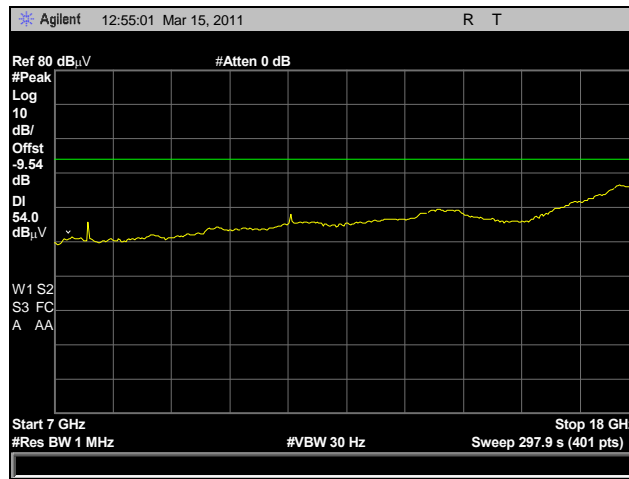

Plot 199. Radiated Harmonics, Low Channel, 7 GHz – 18 GHz, Average, 802.11n HT10

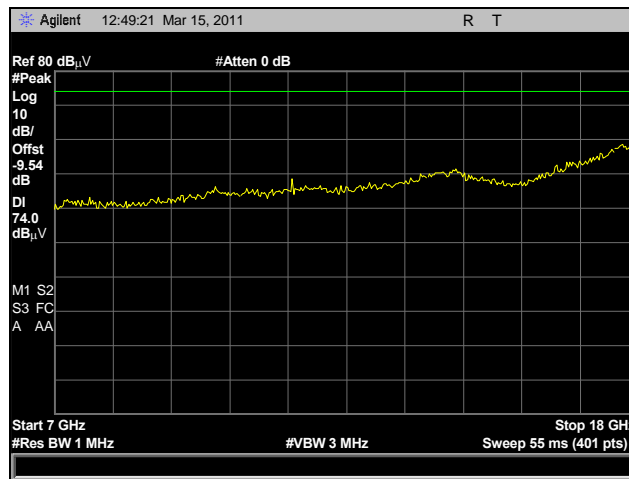

Plot 200. Radiated Harmonics, Low Channel, 7 GHz – 18 GHz, Peak, 802.11n HT10

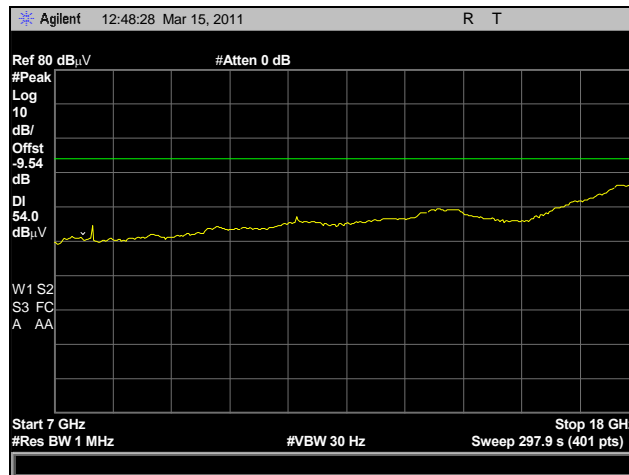

Plot 201. Radiated Harmonics, Mid Channel, 7 GHz – 18 GHz, Average, 802.11n HT10

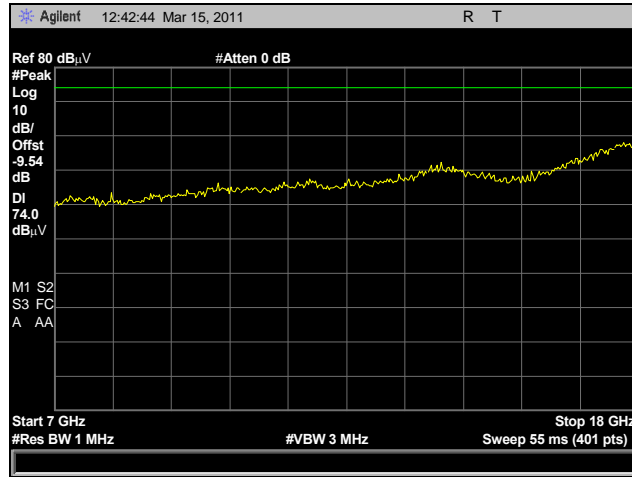

Plot 202. Radiated Harmonics, Mid Channel, 7 GHz – 18 GHz, Peak, 802.11n HT10

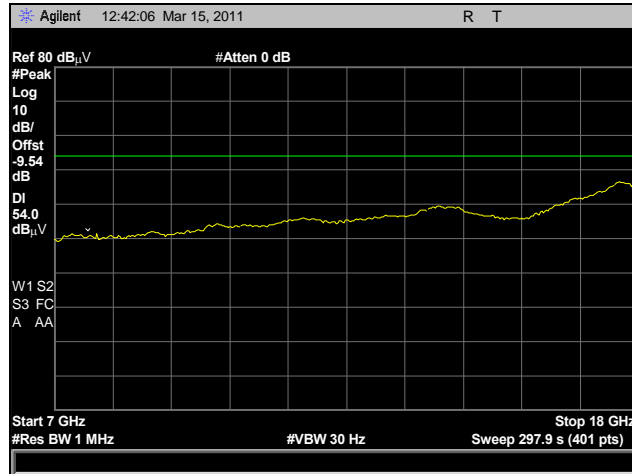

Plot 203. Radiated Harmonics, High Channel, 7 GHz – 18 GHz, Average, 802.11n HT10

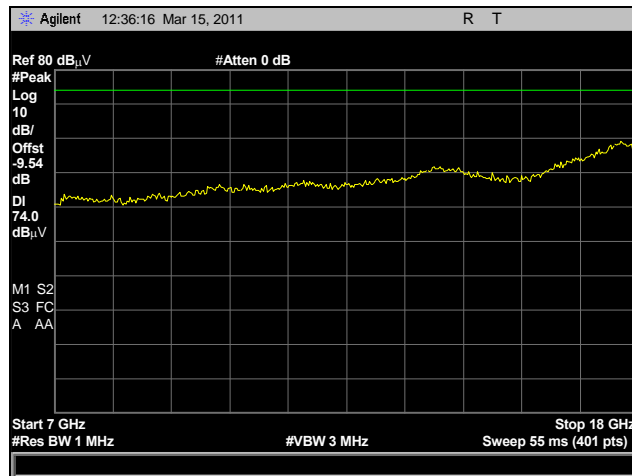

Plot 204. Radiated Harmonics, High Channel, 7 GHz – 18 GHz, Peak, 802.11n HT10

Radiated Harmonics Test Results, 802.11n HT20

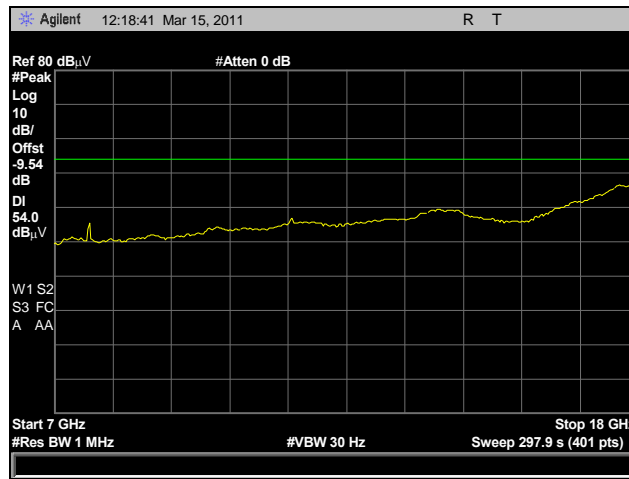

Plot 205. Radiated Harmonics, Low Channel, 7 GHz – 18 GHz, Average, 802.11n HT20

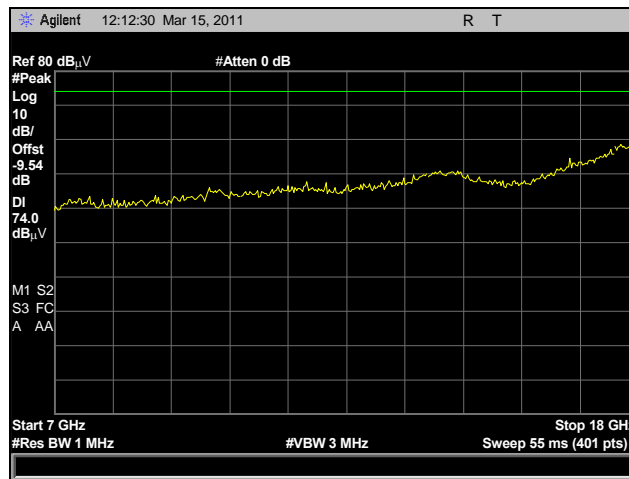

Plot 206. Radiated Harmonics, Low Channel, 7 GHz – 18 GHz, Peak, 802.11n HT20

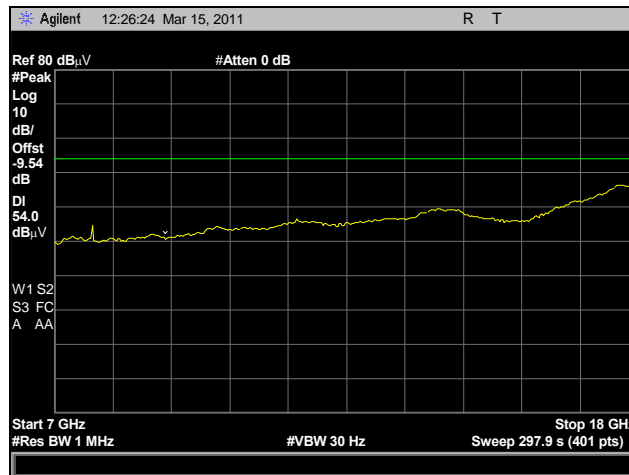

Plot 207. Radiated Harmonics, Mid Channel, 7 GHz – 18 GHz, Average, 802.11n HT20

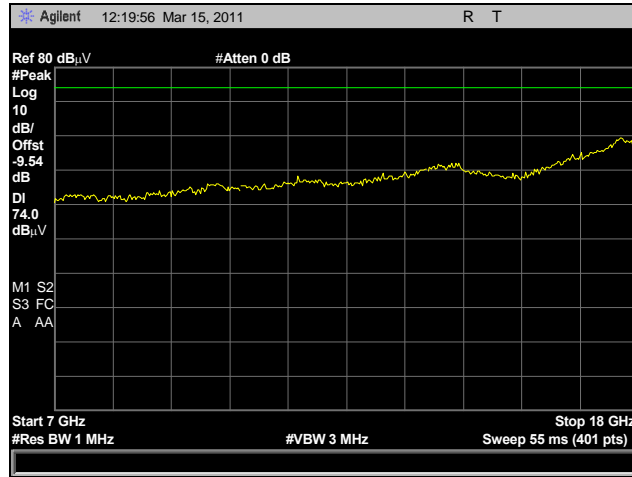

Plot 208. Radiated Harmonics, Mid Channel, 7 GHz – 18 GHz, Peak, 802.11n HT20

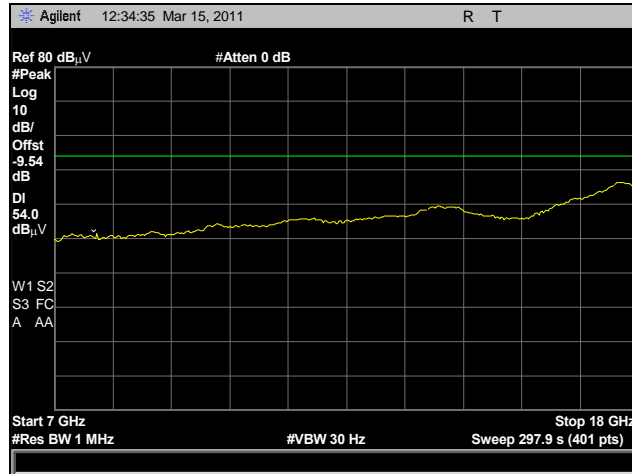

Plot 209. Radiated Harmonics, High Channel, 7 GHz – 18 GHz, Average, 802.11n HT20

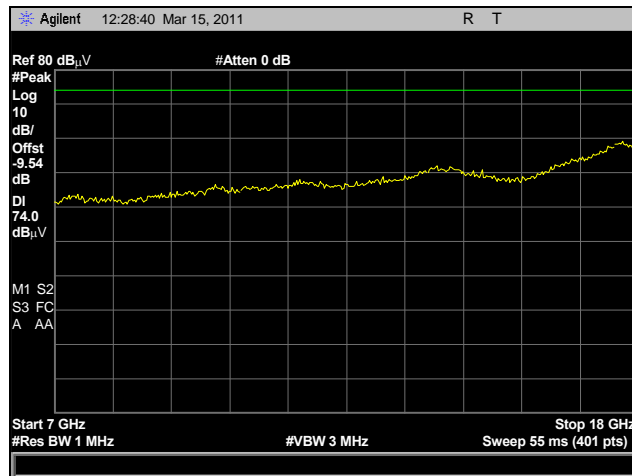

Plot 210. Radiated Harmonics, High Channel, 7 GHz – 18 GHz, Peak, 802.11n HT20

Radiated Harmonics Test Results, 802.11n HT30

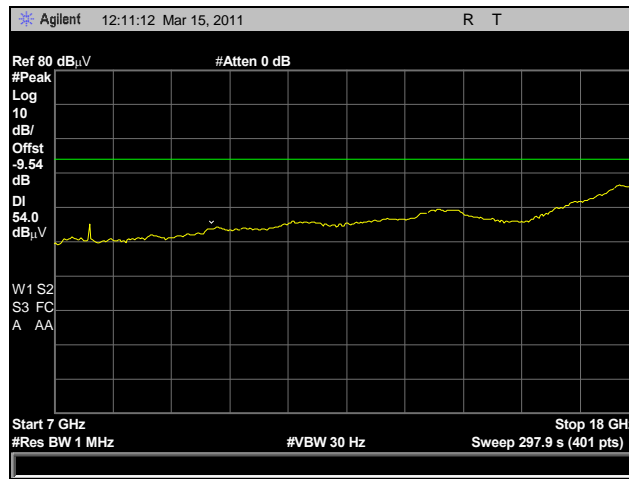

Plot 211. Radiated Harmonics, Low Channel, 7 GHz – 18 GHz, Average, 802.11n HT30

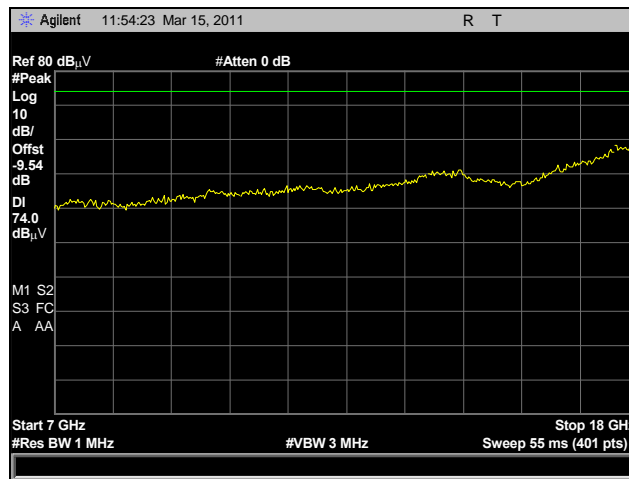

Plot 212. Radiated Harmonics, Low Channel, 7 GHz – 18 GHz, Peak, 802.11n HT30

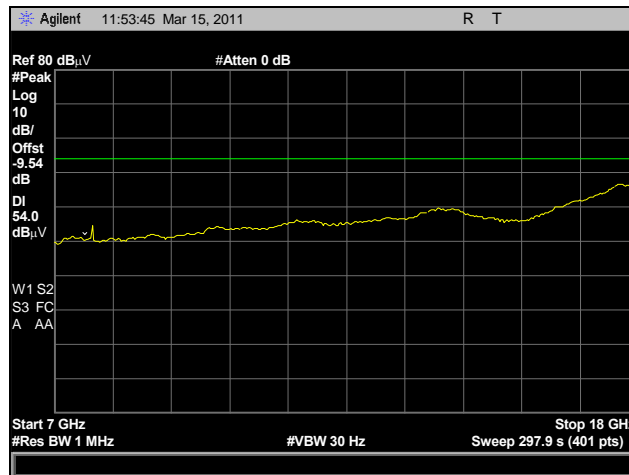

Plot 213. Radiated Harmonics, Mid Channel, 7 GHz – 18 GHz, Average, 802.11n HT30

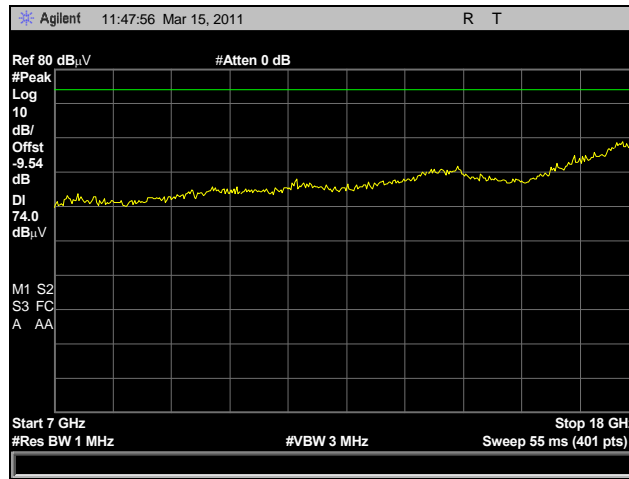

Plot 214. Radiated Harmonics, Mid Channel, 7 GHz – 18 GHz, Peak, 802.11n HT30

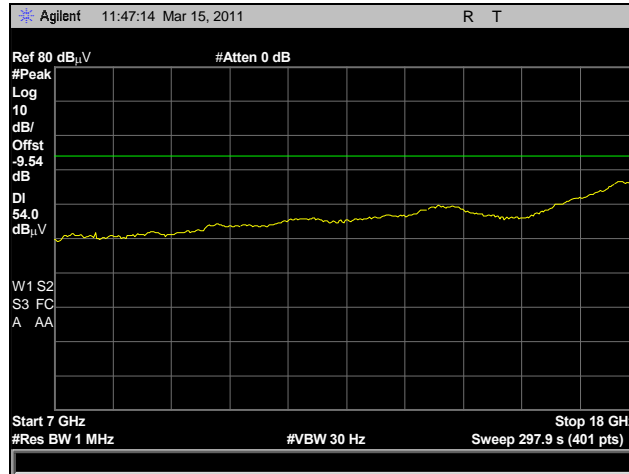

Plot 215. Radiated Harmonics, High Channel, 7 GHz – 18 GHz, Average, 802.11n HT30

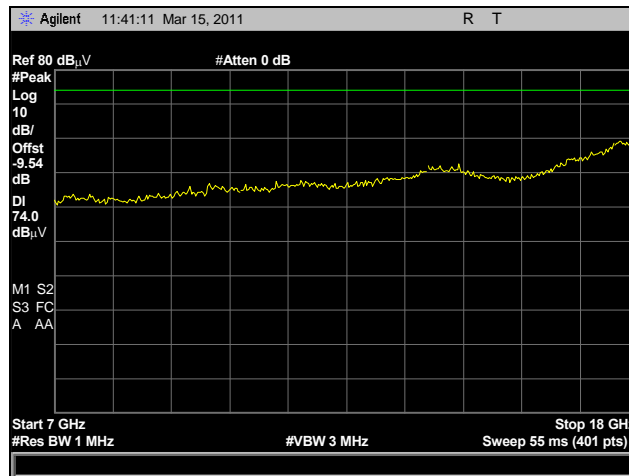

Plot 216. Radiated Harmonics, High Channel, 7 GHz – 18 GHz, Peak, 802.11n HT30

Radiated Harmonics Test Results, 802.11n HT40

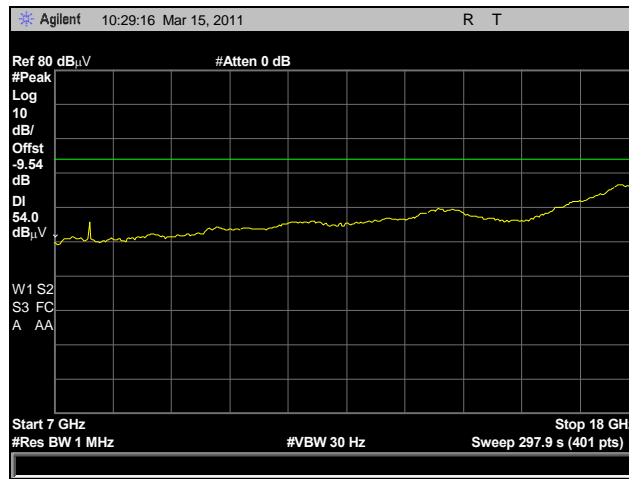

Plot 217. Radiated Harmonics, Low Channel, 7 GHz – 18 GHz, Average, 802.11n HT40

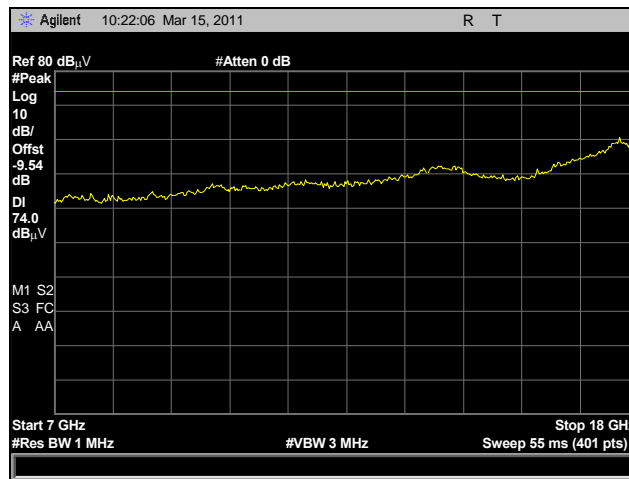

Plot 218. Radiated Harmonics, Low Channel, 7 GHz – 18 GHz, Peak, 802.11n HT40

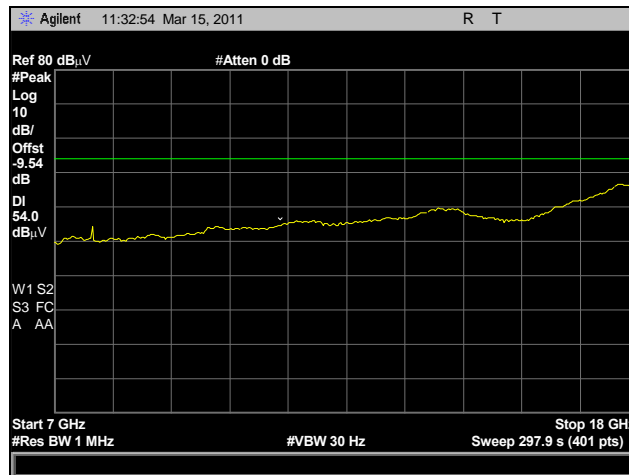

Plot 219. Radiated Harmonics, Mid Channel, 7 GHz – 18 GHz, Average, 802.11n HT40

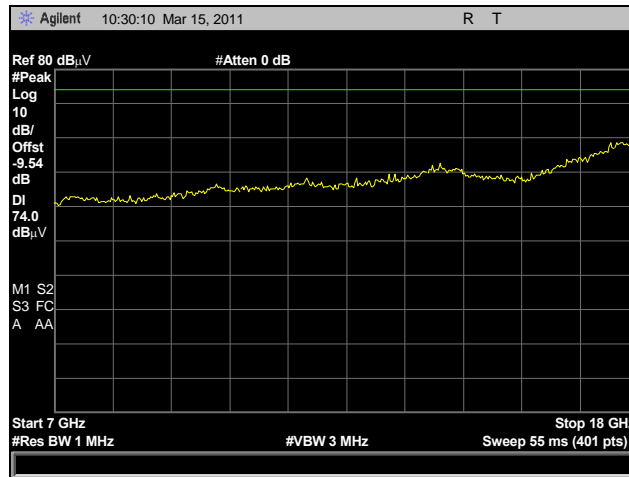

Plot 220. Radiated Harmonics, Mid Channel, 7 GHz – 18 GHz, Peak, 802.11n HT40

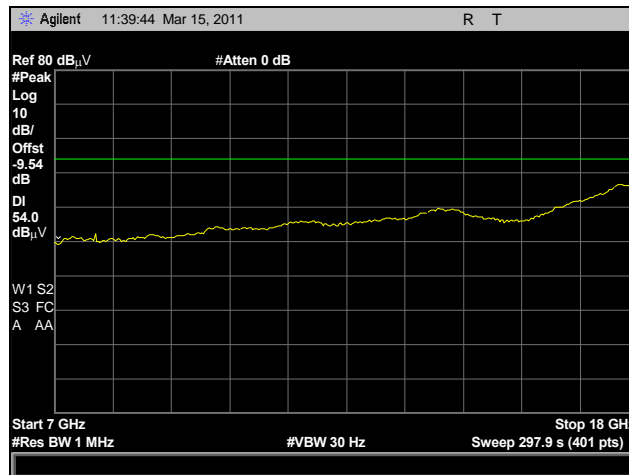

Plot 221. Radiated Harmonics, High Channel, 7 GHz – 18 GHz, Average, 802.11n HT40

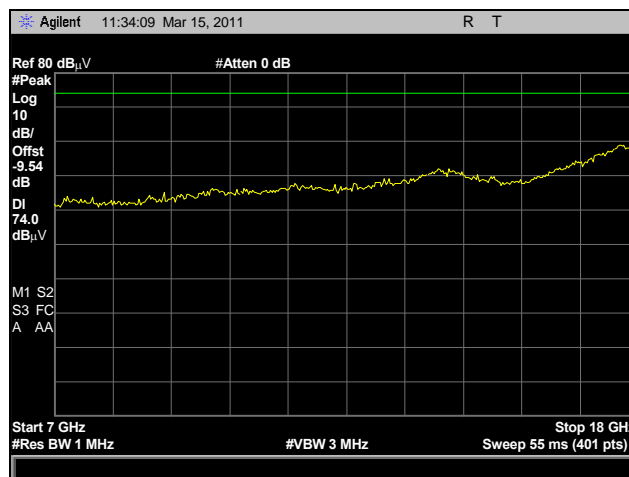

Plot 222. Radiated Harmonics, High Channel, 7 GHz – 18 GHz, Peak, 802.11n HT40

Radiated Spurious Emissions Test Setup



Photograph 6. Radiated Spurious Emissions, Test Setup, 30 MHz – 1 GHz

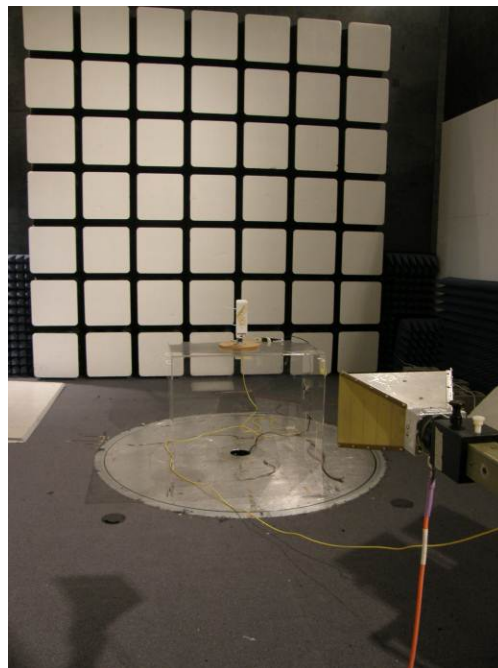

Photograph 7. Radiated Spurious Emissions, Test Setup, 1 GHz – 18 GHz

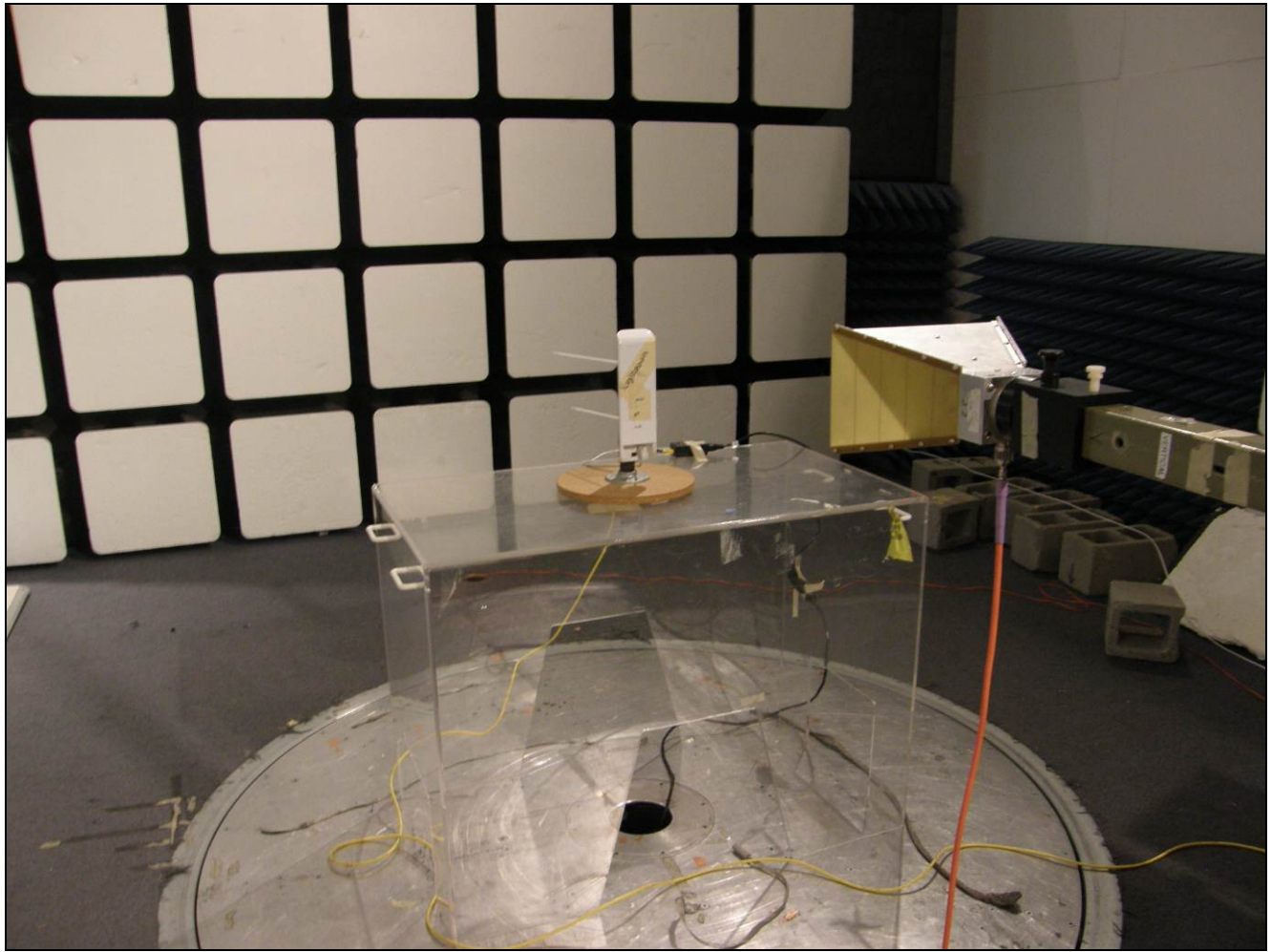

Photograph 8. Radiated Harmonics Emissions, Test Setup

Electromagnetic Compatibility Criteria for Intentional Radiators

§ 15.247(d) RF Conducted Spurious Emissions Requirements and Band Edge

Test Requirement: **15.247(d)** In any 100 kHz bandwidth outside the frequency band in which the spread spectrum or digitally modulated intentional radiator is operating, the radio frequency power that is produced by the intentional radiator shall be at least 20 dB below that in the 100 kHz bandwidth within the band that contains the highest level of the desired power, based on either an RF conducted or a radiated measurement, provided the transmitter demonstrates compliance with the peak conducted power limits. If the transmitter complies with the conducted power limits based on the use of RMS averaging over a time interval, as permitted under paragraph (b)(3) of this section, the attenuation required under this paragraph shall be 30 dB instead of 20 dB.

Test Procedure: For intentional radiators with a digital device portion which operates below 10 GHz, the spectrum was investigated as per §15.33(a)(1) and §15.33(a)(4); i.e., the lowest RF signal generated or used in the device up to the 10th harmonic of the highest fundamental frequency or to 40 GHz, whichever is lower.

A conducted sample was provided fitted with a mmcx connector. The EUT was connected from the mmcx connector to a spectrum analyzer using a 20 dB Attenuator. Testing was performed on Low, Mid and High Channels. A resolution bandwidth of 100kHz and video bandwidth of 300kHz were utilized.

For conducted band edge, a delta measurement was taken from the peak of the fundamental to the Band edge then compared to the limit.

See following pages for detailed test results with RF Conducted Spurious Emissions.

Test Results: The EUT was compliant with the Conducted Spurious Emission limits of §15.247(d).

Test Engineer(s): Kenshi Chung

Test Date(s): 03/07/11

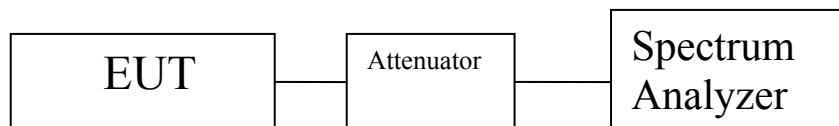
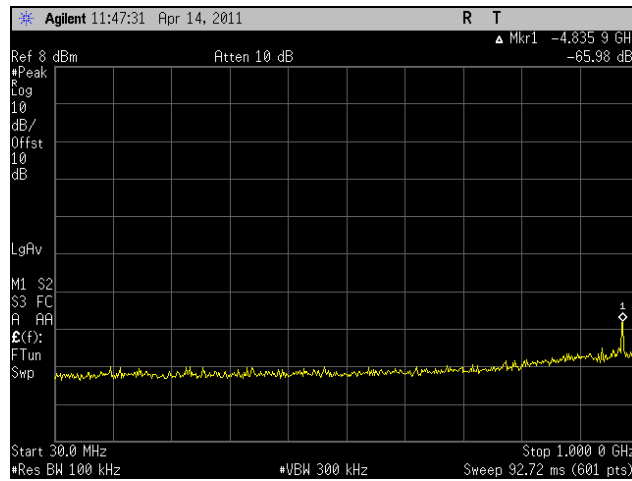
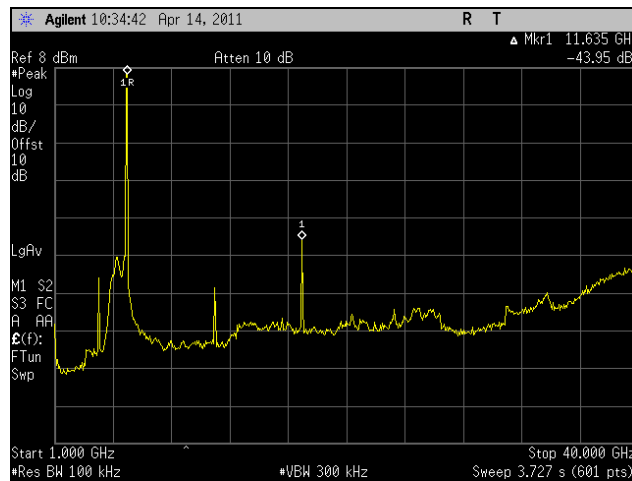

Figure 4. Block Diagram, Conducted Spurious Emissions Test Setup

Conducted Spurious Emissions Test Results, 802.11a 20 MHz



Plot 223. Conducted Spurious Emissions, Low Channel, 30 MHz – 1 GHz, 802.11a 20 MHz



Plot 224. Conducted Spurious Emissions, Low Channel, 1 GHz – 40 GHz, 802.11a 20 MHz

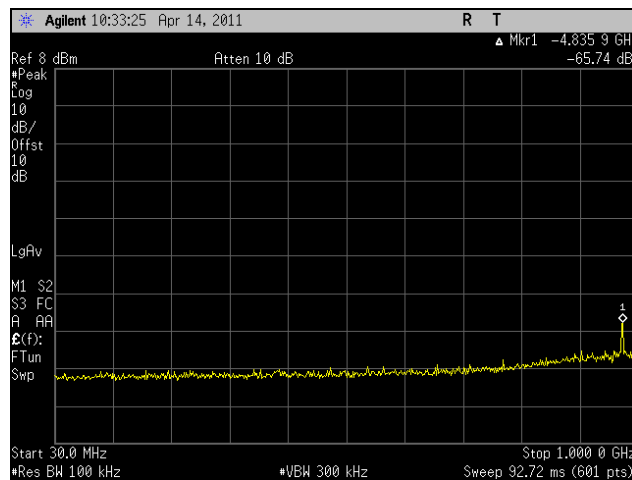

Plot 225. Conducted Spurious Emissions, Mid Channel, 30 MHz – 1 GHz, 802.11a 20 MHz

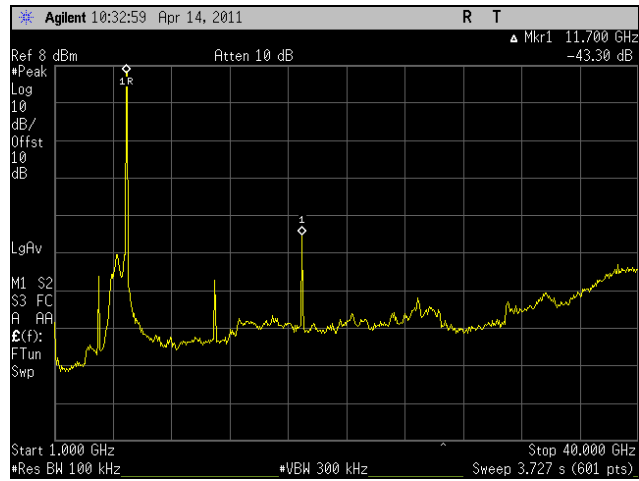

Plot 226. Conducted Spurious Emissions, Mid Channel, 1 GHz – 40 GHz, 802.11a 20 MHz

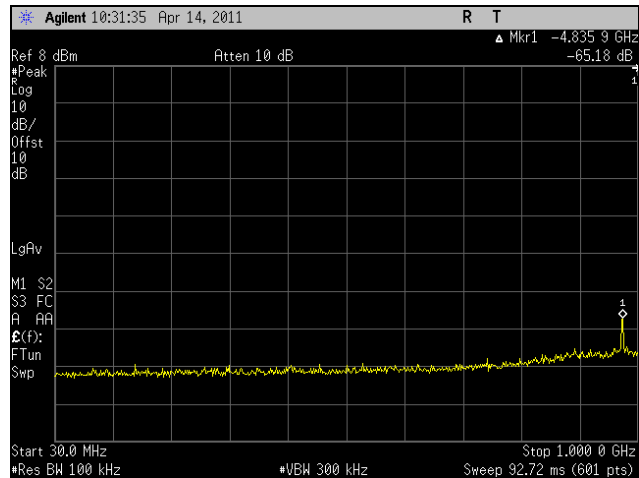

Plot 227. Conducted Spurious Emissions, High Channel, 30 MHz – 1 GHz, 802.11a 20 MHz

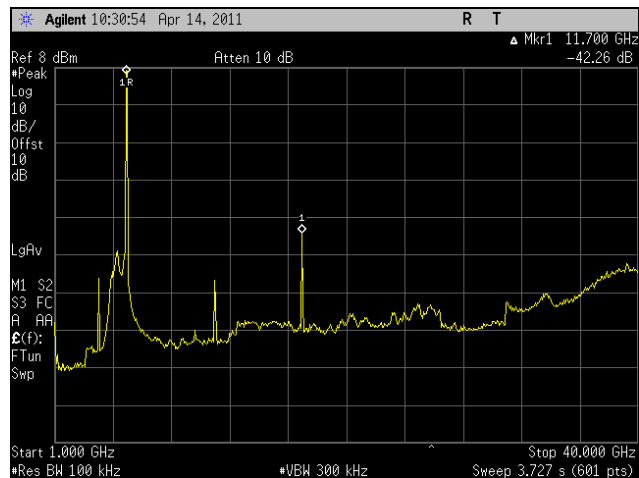

Plot 228. Conducted Spurious Emissions, High Channel, 1 GHz – 40 GHz, 802.11a 20 MHz

Conducted Spurious Emissions Test Results, 802.11a 40 MHz

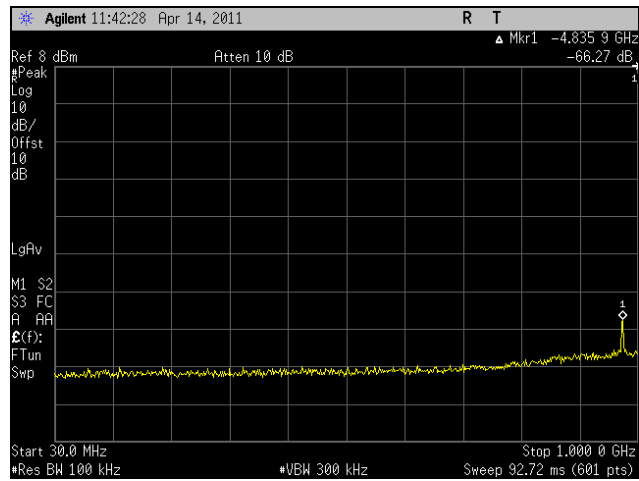

Plot 229. Conducted Spurious Emissions, Low Channel, 30 MHz – 1 GHz, 802.11a 40 MHz

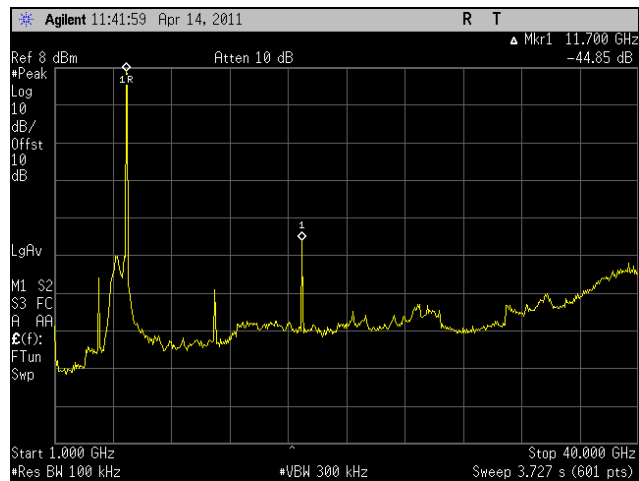

Plot 230. Conducted Spurious Emissions, Low Channel, 1 GHz – 40 GHz, 802.11a 40 MHz

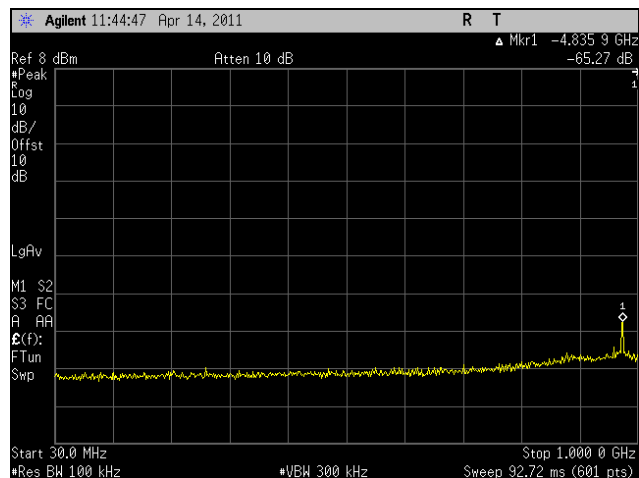

Plot 231. Conducted Spurious Emissions, Mid Channel, 30 MHz – 1 GHz, 802.11a 40 MHz

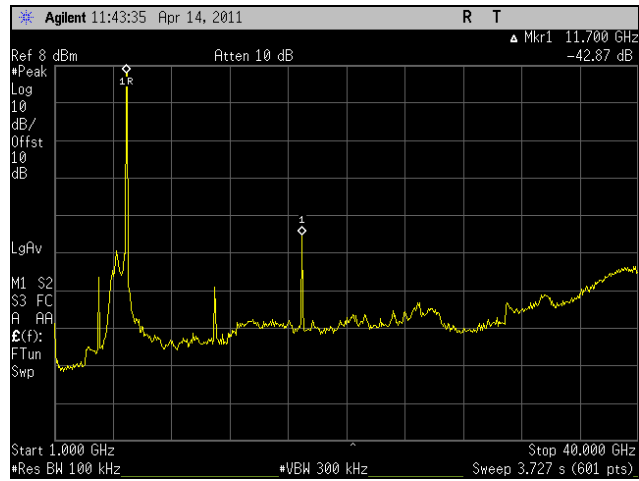

Plot 232. Conducted Spurious Emissions, Mid Channel, 1 GHz – 40 GHz, 802.11a 40 MHz

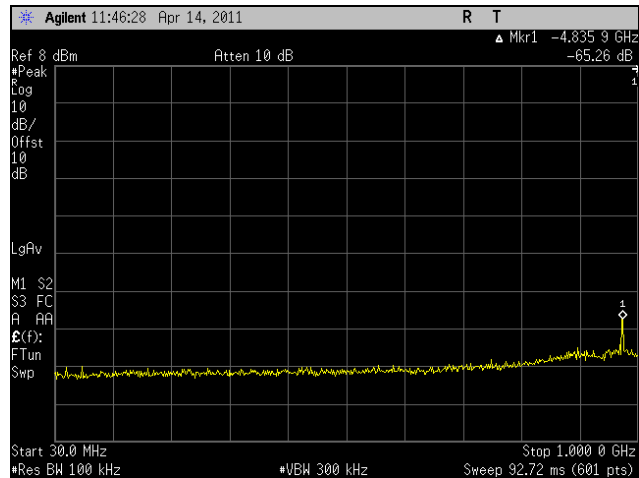

Plot 233. Conducted Spurious Emissions, High Channel, 30 MHz – 1 GHz, 802.11a 40 MHz

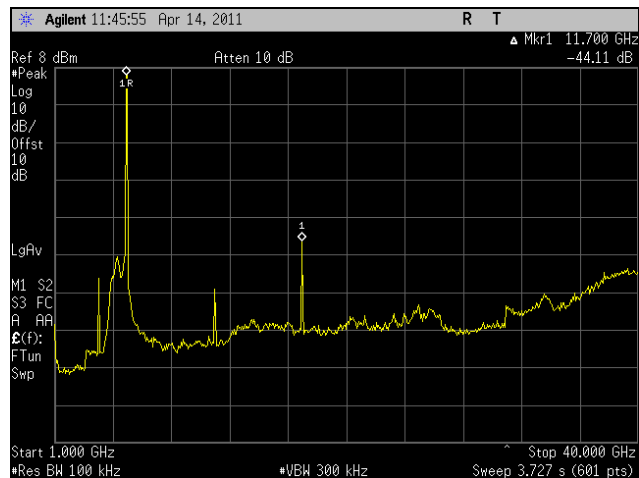

Plot 234. Conducted Spurious Emissions, High Channel, 1 GHz – 40 GHz, 802.11a 40 MHz

Conducted Spurious Emissions Test Results, 802.11n HT5, Port 1

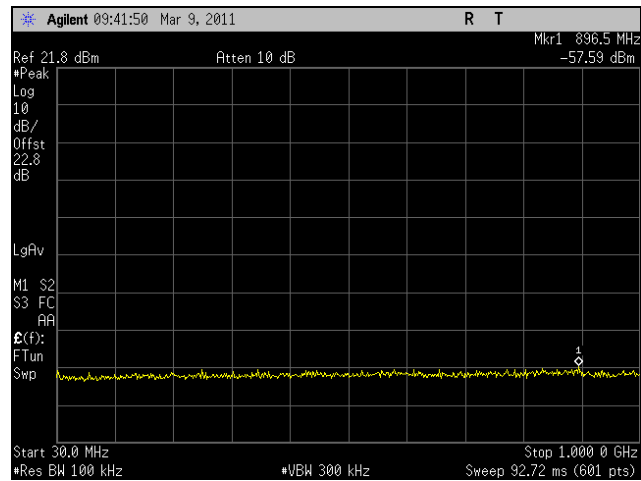

Plot 235. Conducted Spurious Emissions, Low Channel, 30 MHz – 1 GHz, 802.11n HT5, Port 1

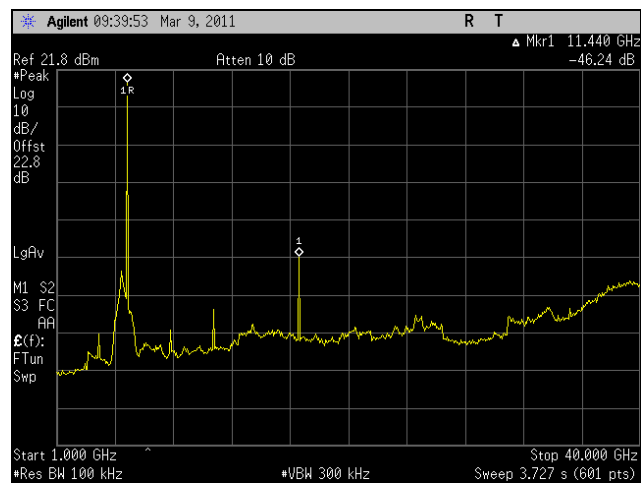

Plot 236. Conducted Spurious Emissions, Low Channel, 1 GHz – 40 GHz, 802.11n HT5, Port 1

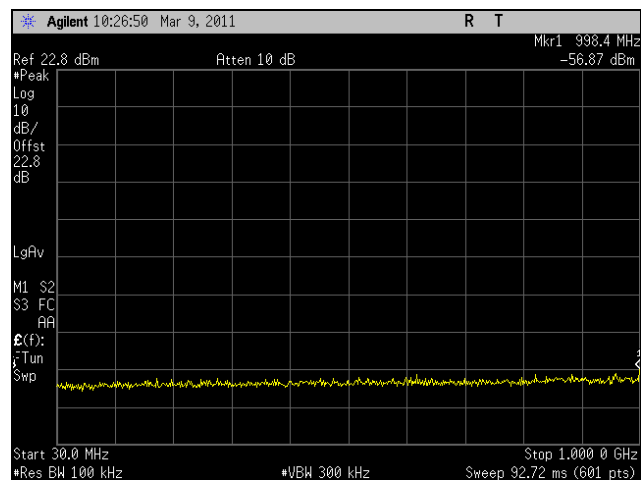

Plot 237. Conducted Spurious Emissions, Mid Channel, 30 MHz – 1 GHz, 802.11n HT5, Port 1

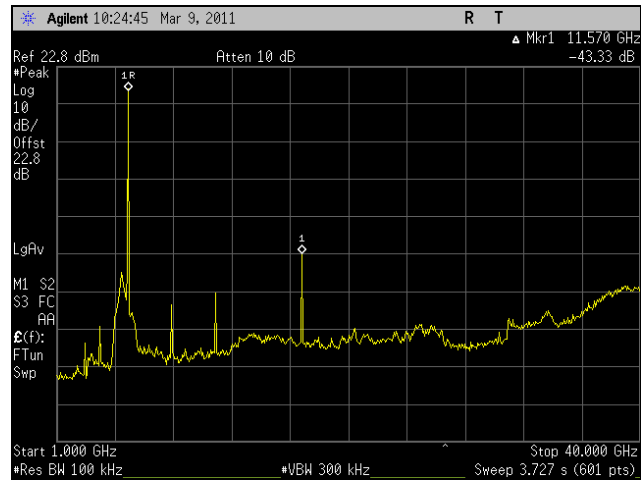

Plot 238. Conducted Spurious Emissions, Mid Channel, 1 GHz – 40 GHz, 802.11n HT5, Port 1

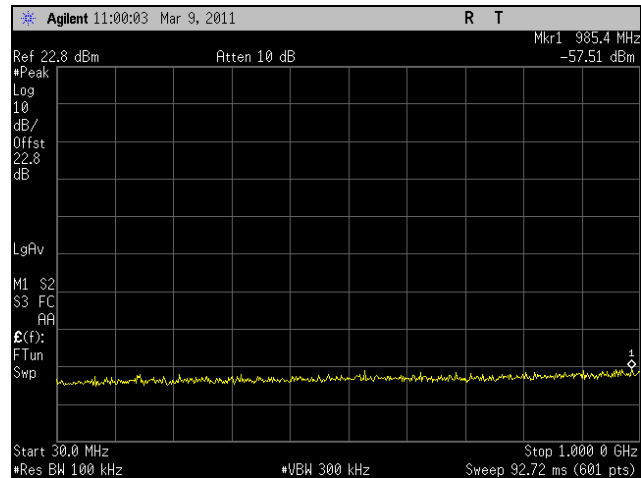

Plot 239. Conducted Spurious Emissions, High Channel, 30 MHz – 1 GHz, 802.11n HT5, Port 1

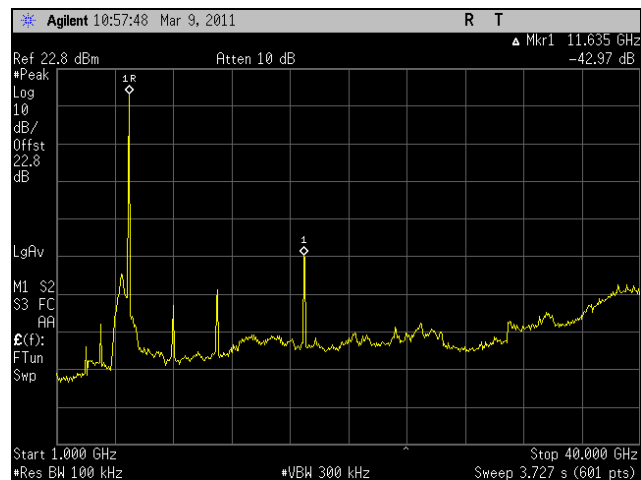

Plot 240. Conducted Spurious Emissions, High Channel, 1 GHz – 40 GHz, 802.11n HT5, Port 1

Conducted Spurious Emissions Test Results, 802.11n HT5, Port 2

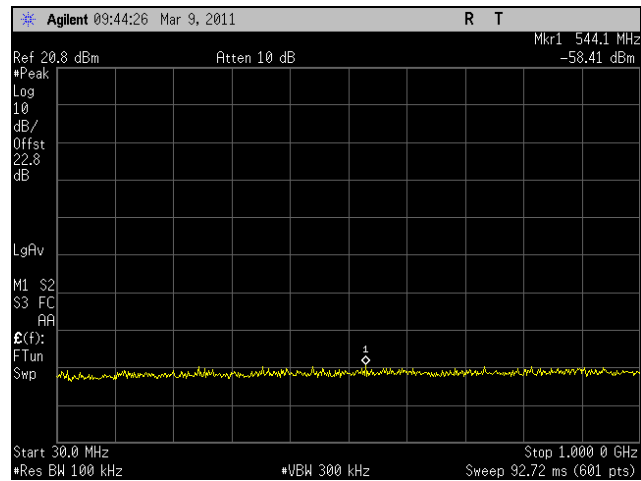

Plot 241. Conducted Spurious Emissions, Low Channel, 30 MHz – 1 GHz, 802.11n HT5, Port 2

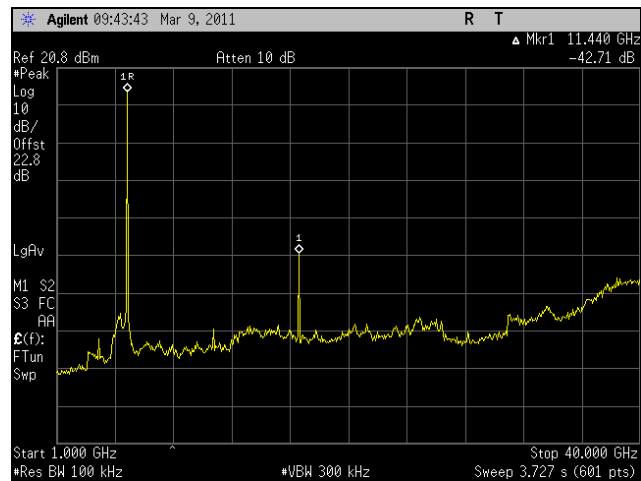

Plot 242. Conducted Spurious Emissions, Low Channel, 1 GHz – 40 GHz, 802.11n HT5, Port 2

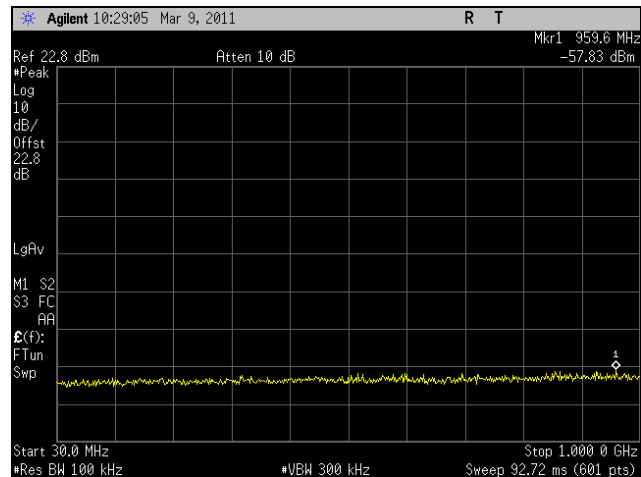

Plot 243. Conducted Spurious Emissions, Mid Channel, 30 MHz – 1 GHz, 802.11n HT5, Port 2

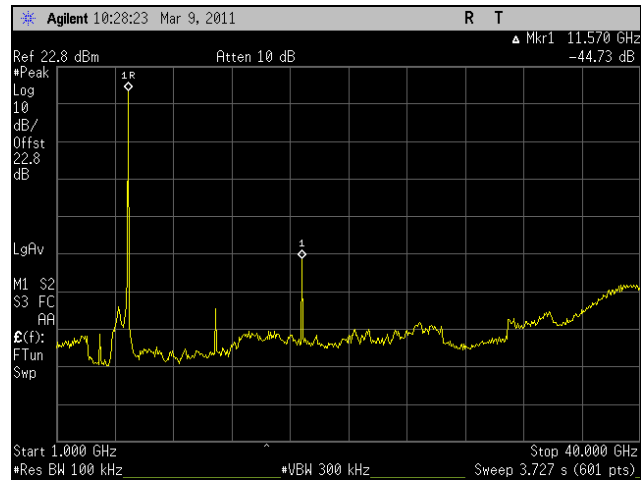

Plot 244. Conducted Spurious Emissions, Mid Channel, 1 GHz – 40 GHz, 802.11n HT5, Port 2

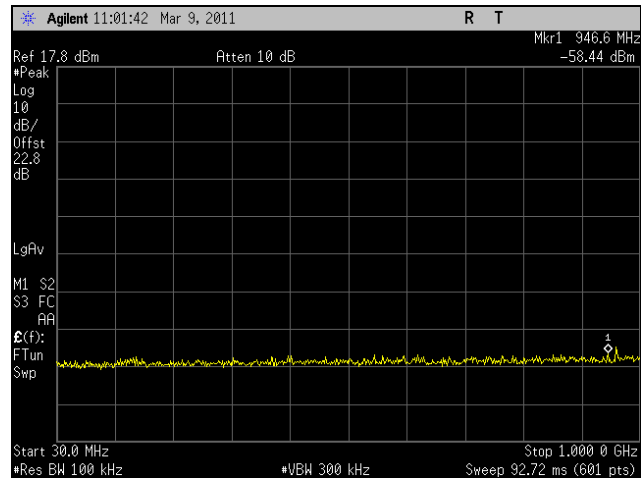

Plot 245. Conducted Spurious Emissions, High Channel, 30 MHz – 1 GHz, 802.11n HT5, Port 2

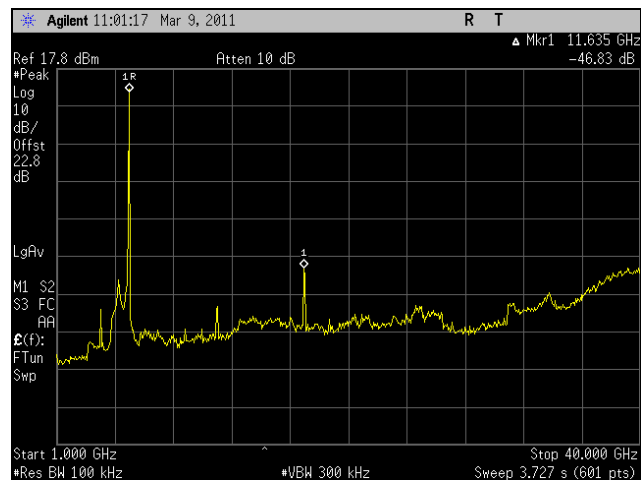

Plot 246. Conducted Spurious Emissions, High Channel, 1 GHz – 40 GHz, 802.11n HT5, Port 2

Conducted Spurious Emissions Test Results, 802.11n HT8, Port 1

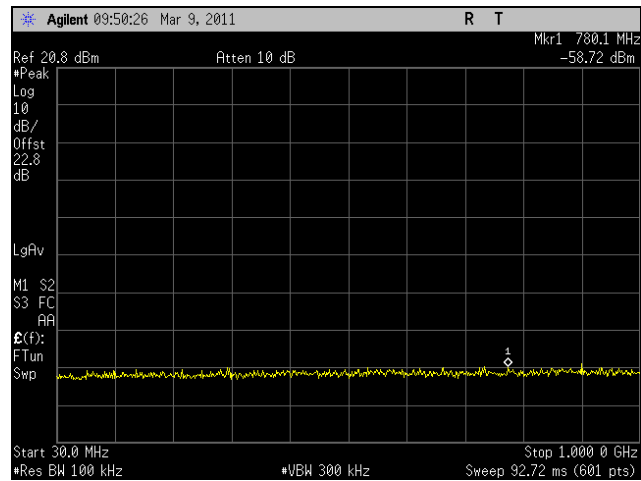

Plot 247. Conducted Spurious Emissions, Low Channel, 30 MHz – 1 GHz, 802.11n HT8, Port 1

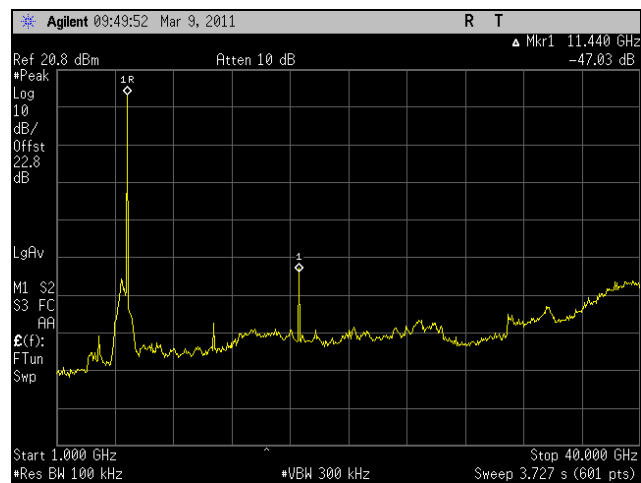

Plot 248. Conducted Spurious Emissions, Low Channel, 1 GHz – 40 GHz, 802.11n HT8, Port 1

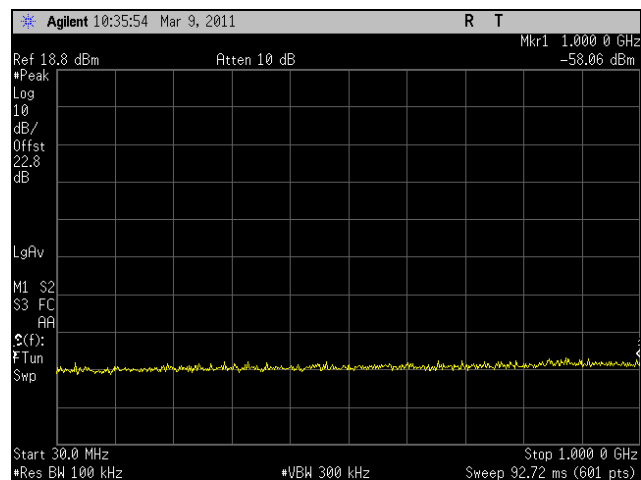

Plot 249. Conducted Spurious Emissions, Mid Channel, 30 MHz – 1 GHz, 802.11n HT8, Port 1

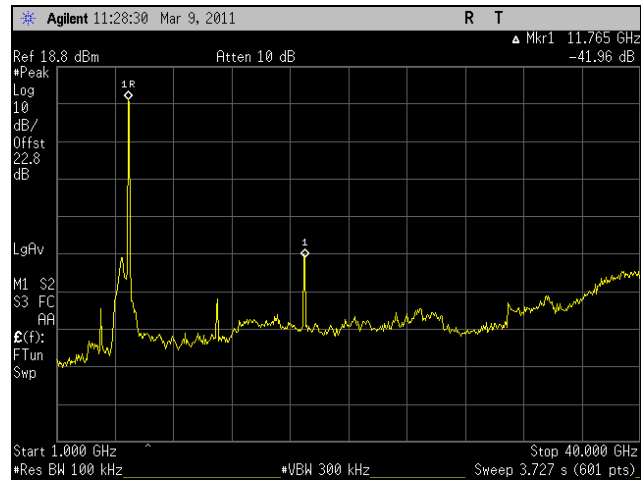

Plot 250. Conducted Spurious Emissions, Mid Channel, 1 GHz – 40 GHz, 802.11n HT8, Port 1

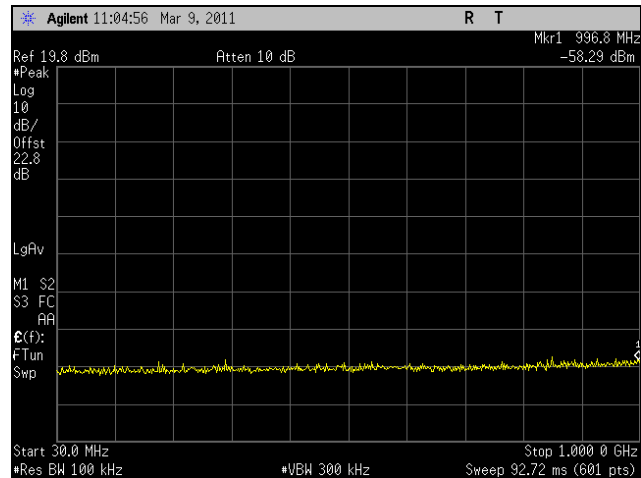

Plot 251. Conducted Spurious Emissions, High Channel, 30 MHz – 1 GHz, 802.11n HT8, Port 1

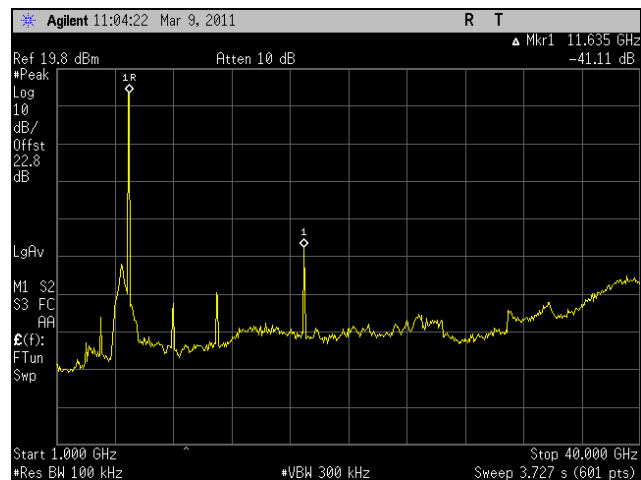

Plot 252. Conducted Spurious Emissions, High Channel, 1 GHz – 40 GHz, 802.11n HT8, Port 1

Conducted Spurious Emissions Test Results, 802.11n HT8, Port 2

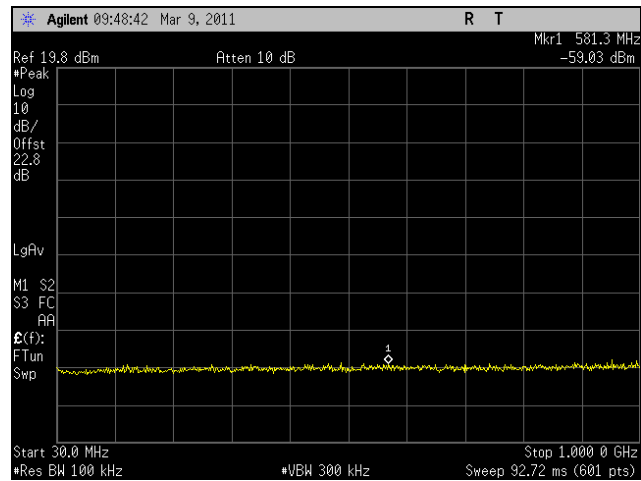

Plot 253. Conducted Spurious Emissions, Low Channel, 30 MHz – 1 GHz, 802.11n HT8, Port 2

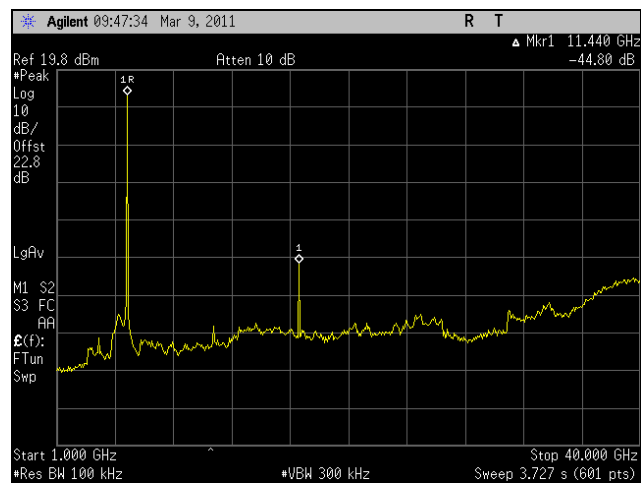

Plot 254. Conducted Spurious Emissions, Low Channel, 1 GHz – 40 GHz, 802.11n HT8, Port 2

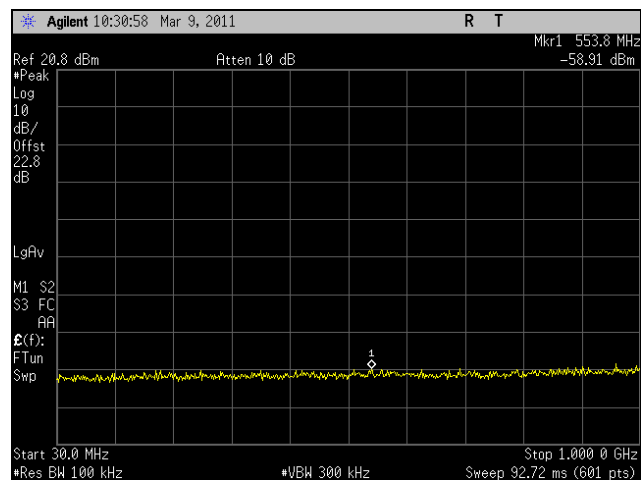

Plot 255. Conducted Spurious Emissions, Mid Channel, 30 MHz – 1 GHz, 802.11n HT8, Port 2

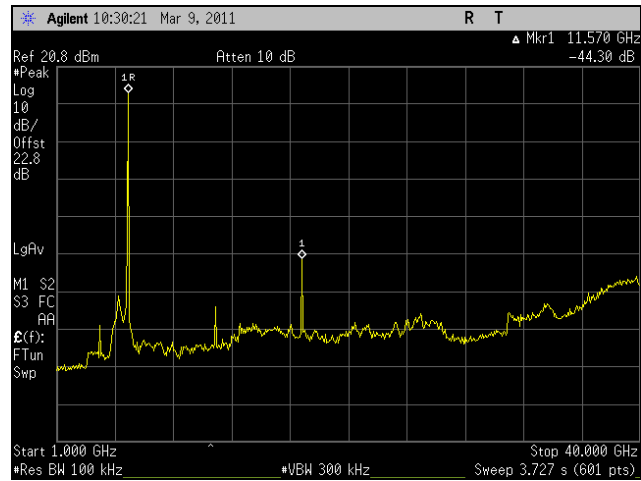

Plot 256. Conducted Spurious Emissions, Mid Channel, 1 GHz – 40 GHz, 802.11n HT8, Port 2

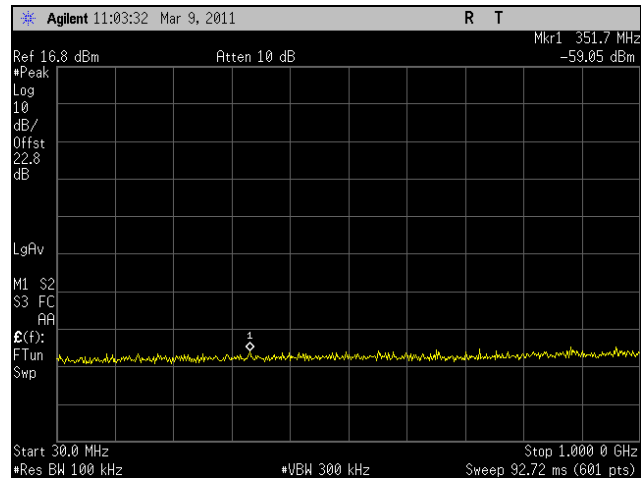

Plot 257. Conducted Spurious Emissions, High Channel, 30 MHz – 1 GHz, 802.11n HT8, Port 2

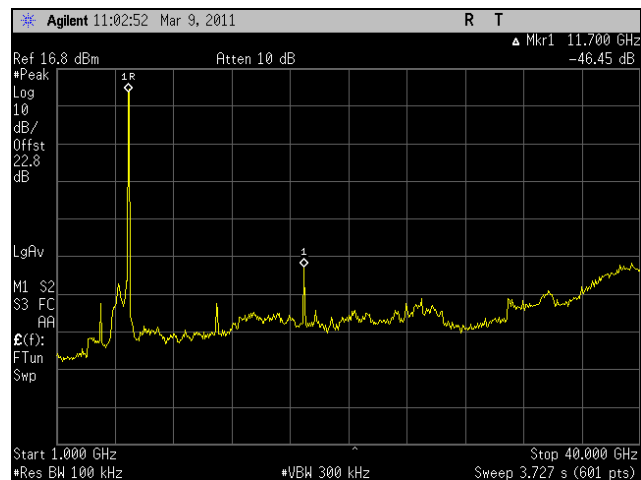

Plot 258. Conducted Spurious Emissions, High Channel, 1 GHz – 40 GHz, 802.11n HT8, Port 2

Conducted Spurious Emissions Test Results, 802.11n HT10, Port 1

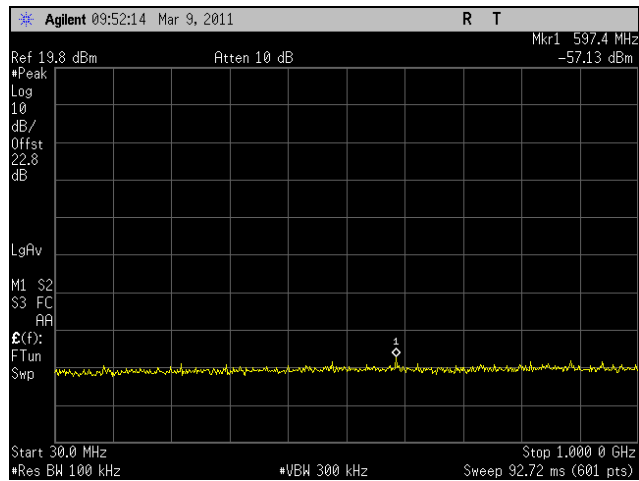

Plot 259. Conducted Spurious Emissions, Low Channel, 30 MHz – 1 GHz, 802.11n HT10, Port 1

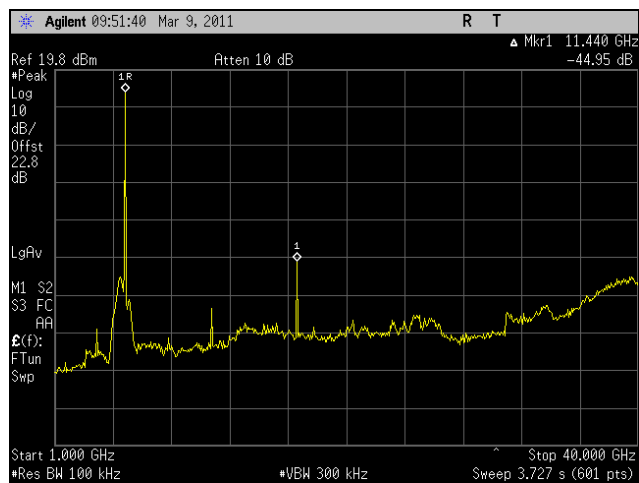

Plot 260. Conducted Spurious Emissions, Low Channel, 1 GHz – 40 GHz, 802.11n HT10, Port 1

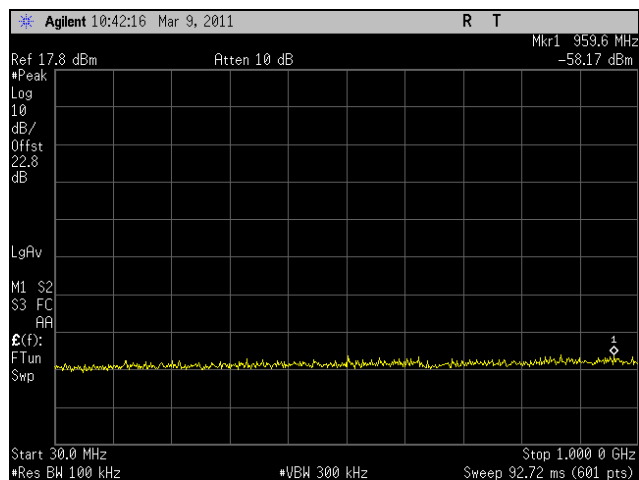

Plot 261. Conducted Spurious Emissions, Mid Channel, 30 MHz – 1 GHz, 802.11n HT10, Port 1

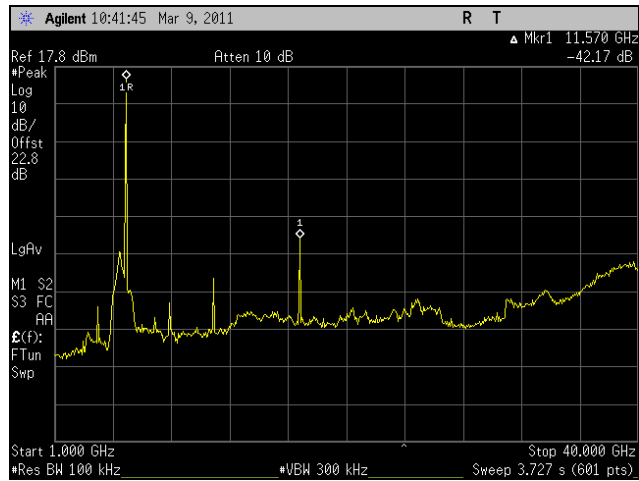

Plot 262. Conducted Spurious Emissions, Mid Channel, 1 GHz – 40 GHz, 802.11n HT10, Port 1

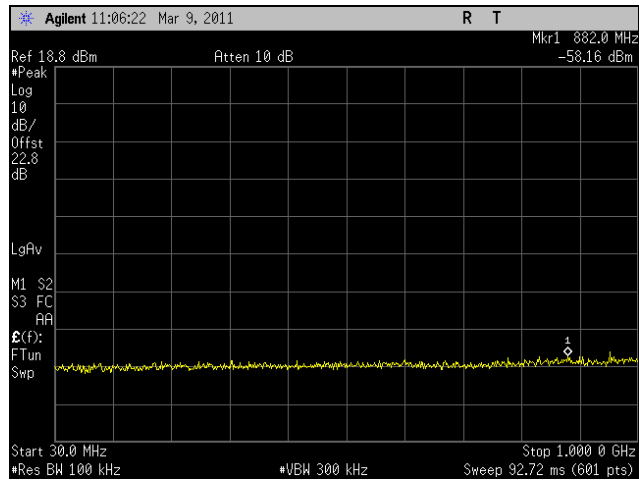

Plot 263. Conducted Spurious Emissions, High Channel, 30 MHz – 1 GHz, 802.11n HT10, Port 1

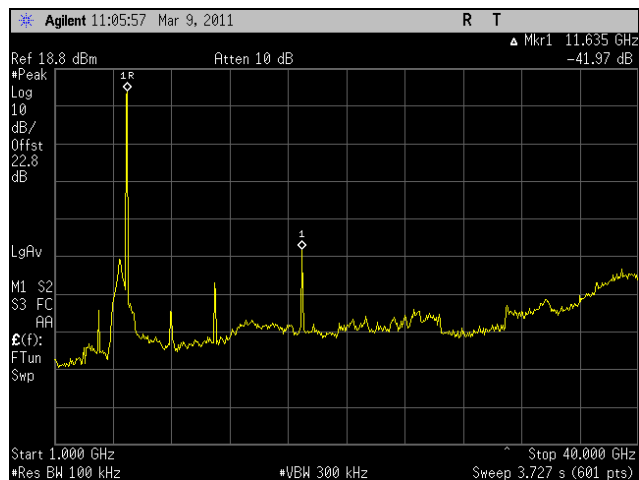

Plot 264. Conducted Spurious Emissions, High Channel, 1 GHz – 40 GHz, 802.11n HT10, Port 1

Conducted Spurious Emissions Test Results, 802.11n HT10, Port 2

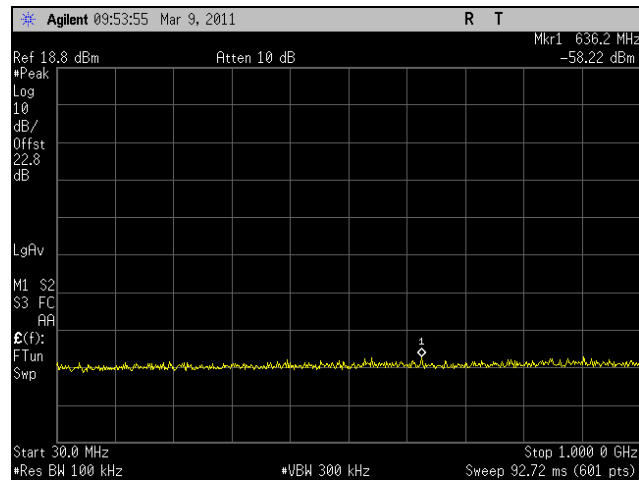

Plot 265. Conducted Spurious Emissions, Low Channel, 30 MHz – 1 GHz, 802.11n HT10, Port 2

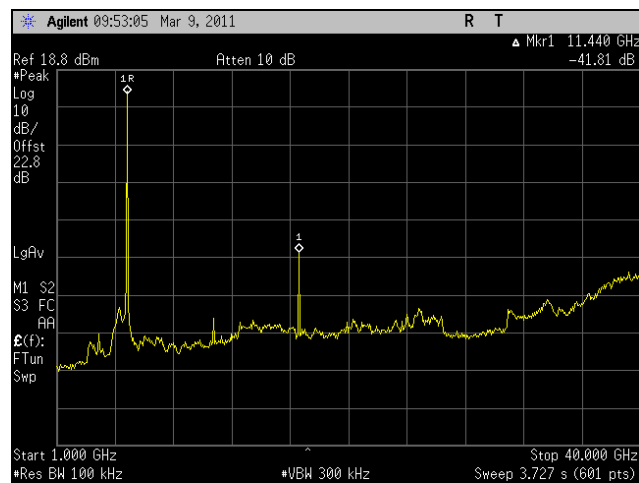

Plot 266. Conducted Spurious Emissions, Low Channel, 1 GHz – 40 GHz, 802.11n HT10, Port 2

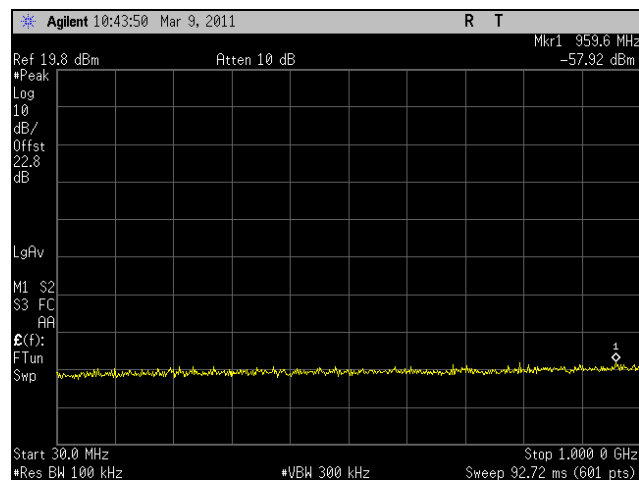

Plot 267. Conducted Spurious Emissions, Mid Channel, 30 MHz – 1 GHz, 802.11n HT10, Port 2

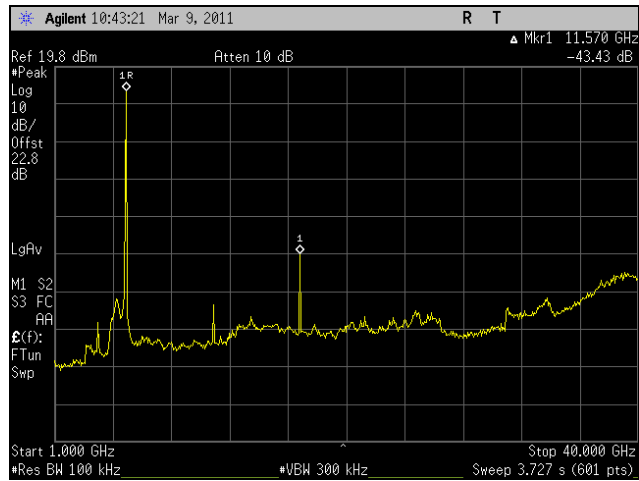

Plot 268. Conducted Spurious Emissions, Mid Channel, 1 GHz – 40 GHz, 802.11n HT10, Port 2

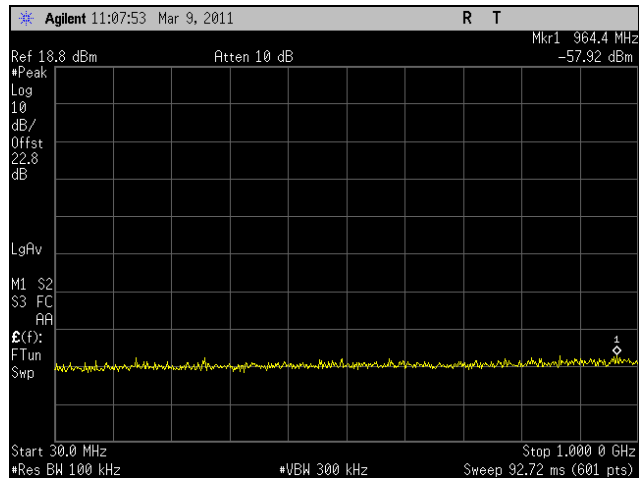

Plot 269. Conducted Spurious Emissions, High Channel, 30 MHz – 1 GHz, 802.11n HT10, Port 2

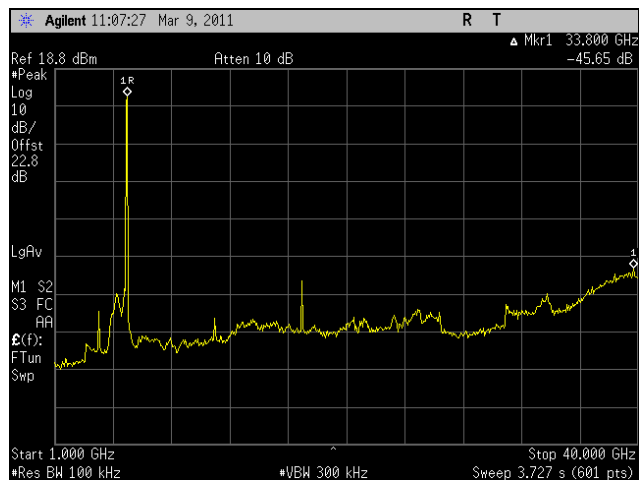

Plot 270. Conducted Spurious Emissions, High Channel, 1 GHz – 40 GHz, 802.11n HT10, Port 2

Conducted Spurious Emissions Test Results, 802.11n HT20, Port 1

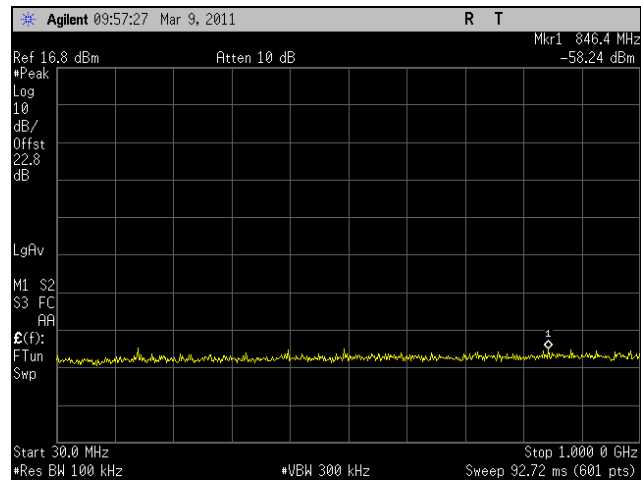

Plot 271. Conducted Spurious Emissions, Low Channel, 30 MHz – 1 GHz, 802.11n HT20, Port 1

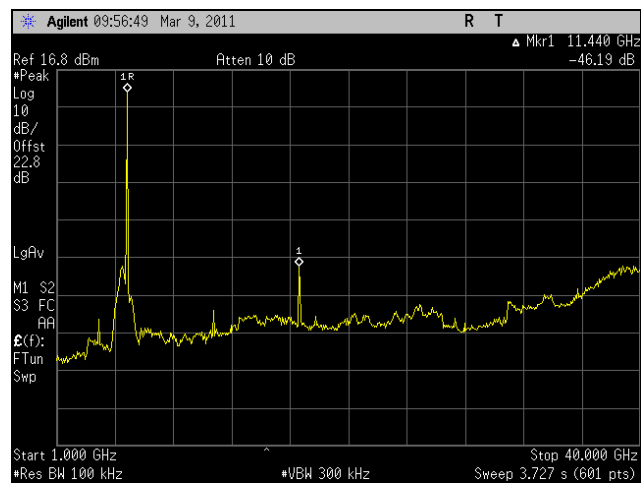

Plot 272. Conducted Spurious Emissions, Low Channel, 1 GHz – 40 GHz, 802.11n HT20, Port 1

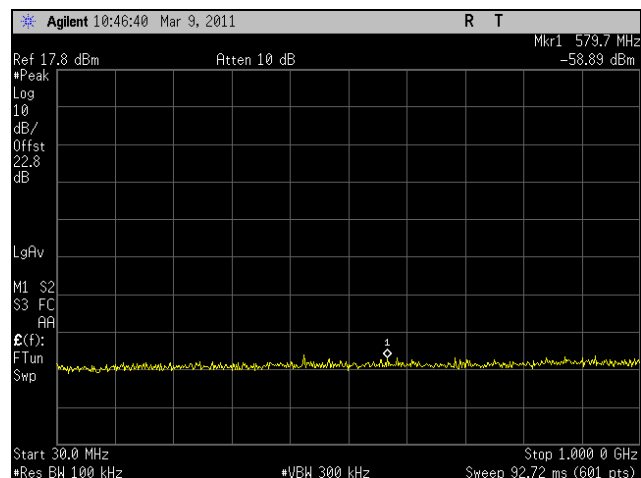

Plot 273. Conducted Spurious Emissions, Mid Channel, 30 MHz – 1 GHz, 802.11n HT20, Port 1

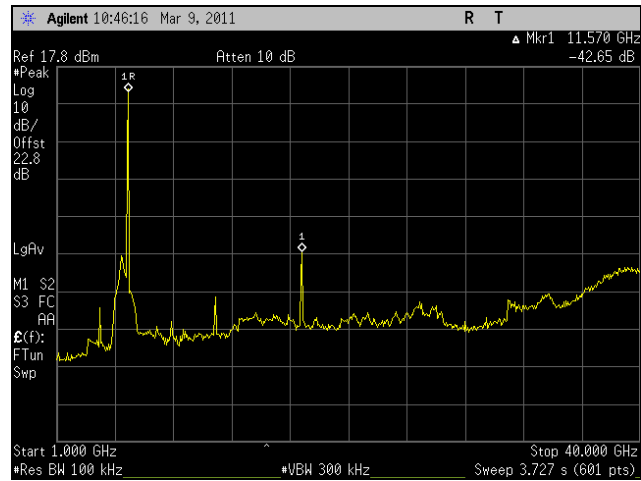

Plot 274. Conducted Spurious Emissions, Mid Channel, 1 GHz – 40 GHz, 802.11n HT20, Port 1

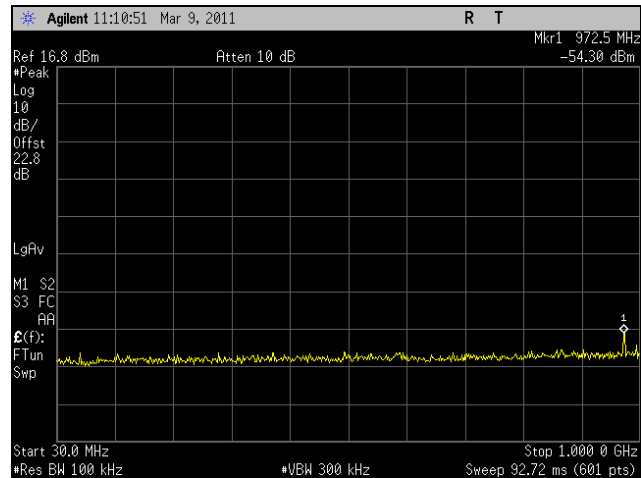

Plot 275. Conducted Spurious Emissions, High Channel, 30 MHz – 1 GHz, 802.11n HT20, Port 1

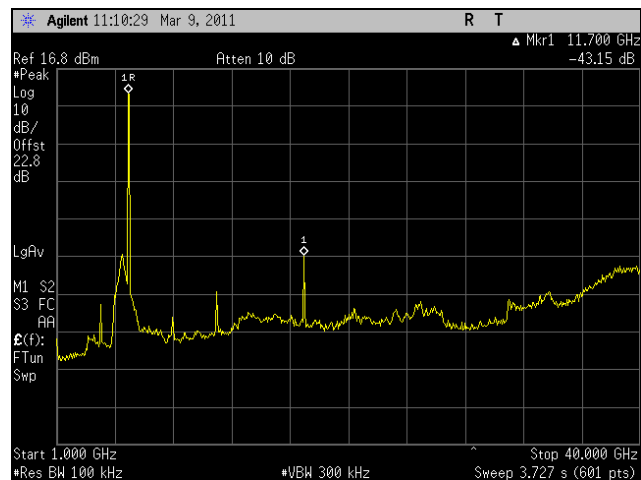

Plot 276. Conducted Spurious Emissions, High Channel, 1 GHz – 40 GHz, 802.11n HT20, Port 1

Conducted Spurious Emissions Test Results, 802.11n HT20, Port 2

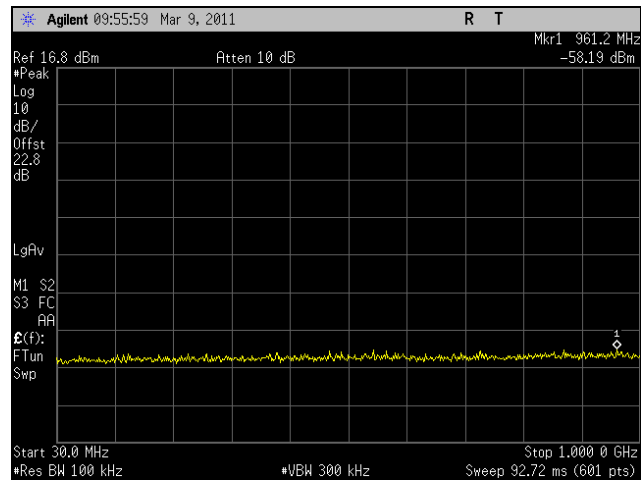

Plot 277. Conducted Spurious Emissions, Low Channel, 30 MHz – 1 GHz, 802.11n HT20, Port 2

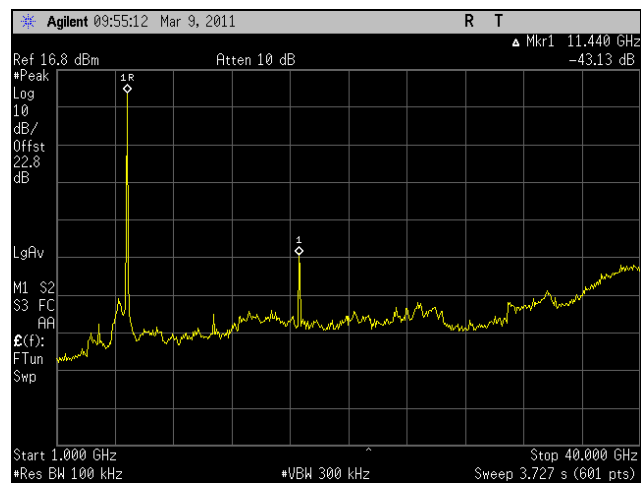

Plot 278. Conducted Spurious Emissions, Low Channel, 1 GHz – 40 GHz, 802.11n HT20, Port 2

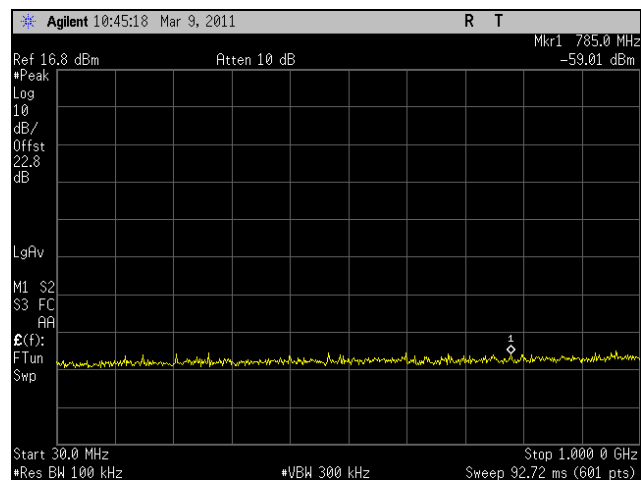

Plot 279. Conducted Spurious Emissions, Mid Channel, 30 MHz – 1 GHz, 802.11n HT20, Port 2

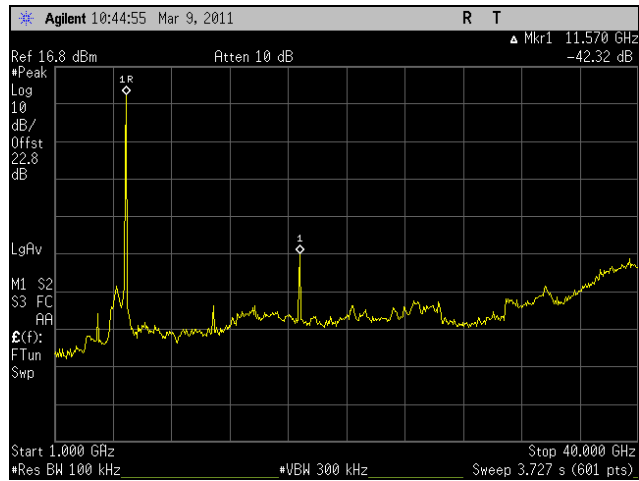

Plot 280. Conducted Spurious Emissions, Mid Channel, 1 GHz – 40 GHz, 802.11n HT20, Port 2

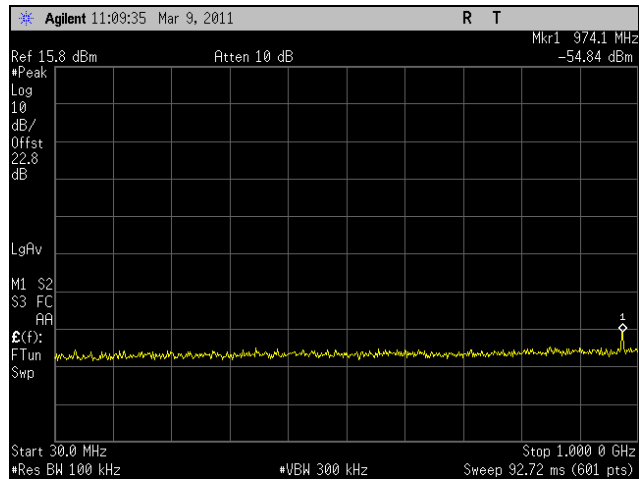

Plot 281. Conducted Spurious Emissions, High Channel, 30 MHz – 1 GHz, 802.11n HT20, Port 2

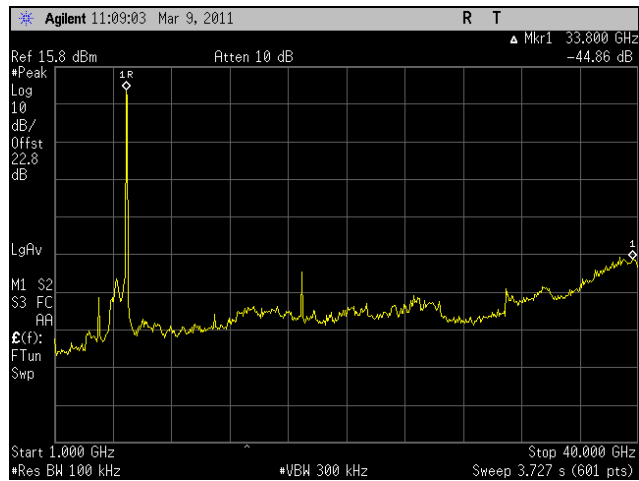

Plot 282. Conducted Spurious Emissions, High Channel, 1 GHz – 40 GHz, 802.11n HT20, Port 2

Conducted Spurious Emissions Test Results, 802.11n HT30, Port 1

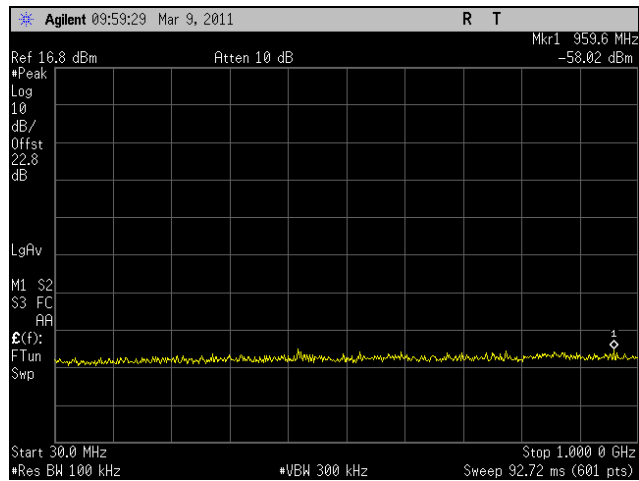

Plot 283. Conducted Spurious Emissions, Low Channel, 30 MHz – 1 GHz, 802.11n HT30, Port 1

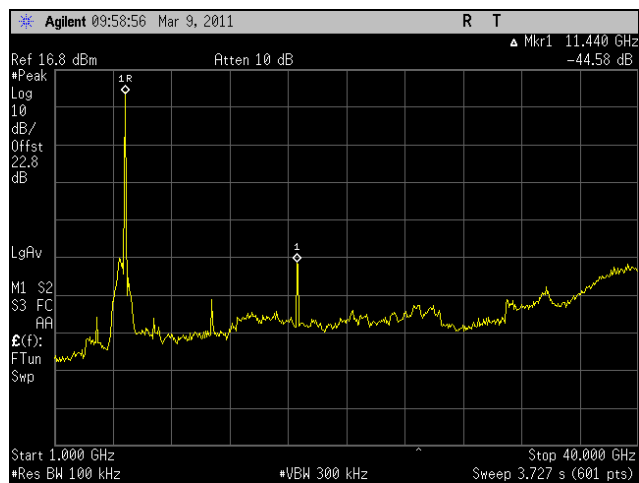

Plot 284. Conducted Spurious Emissions, Low Channel, 1 GHz – 40 GHz, 802.11n HT30, Port 1

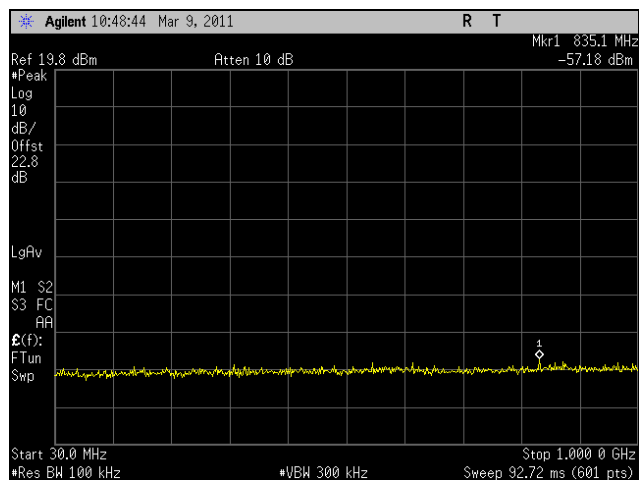

Plot 285. Conducted Spurious Emissions, Mid Channel, 30 MHz – 1 GHz, 802.11n HT30, Port 1

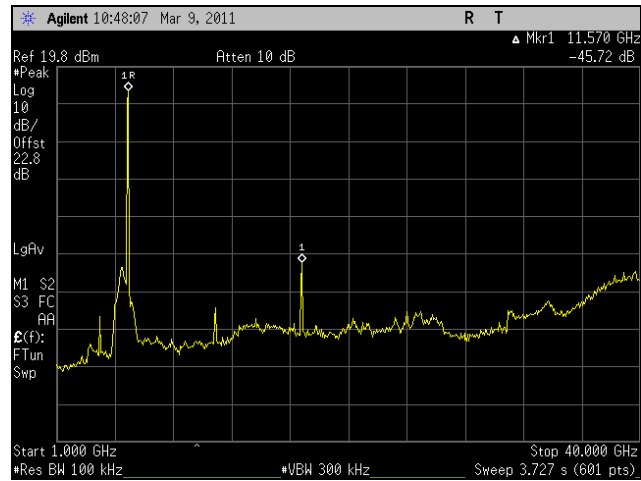

Plot 286. Conducted Spurious Emissions, Mid Channel, 1 GHz – 40 GHz, 802.11n HT30, Port 1

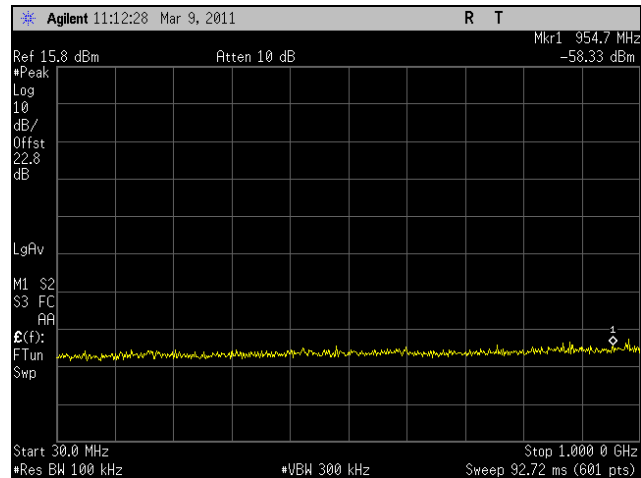

Plot 287. Conducted Spurious Emissions, High Channel, 30 MHz – 1 GHz, 802.11n HT30, Port 1

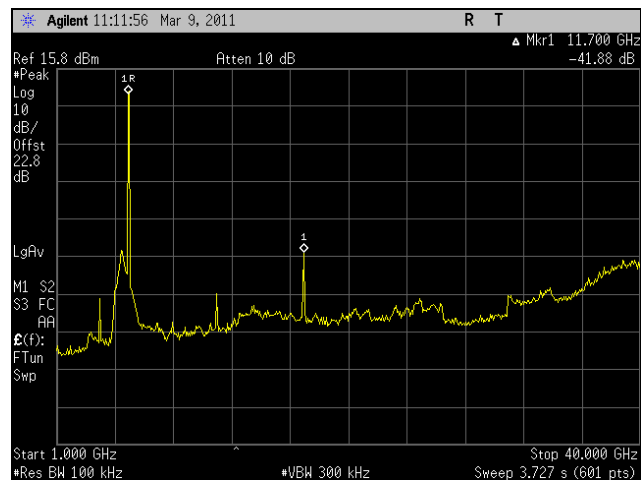

Plot 288. Conducted Spurious Emissions, High Channel, 1 GHz – 40 GHz, 802.11n HT30, Port 1

Conducted Spurious Emissions Test Results, 802.11n HT30, Port 2

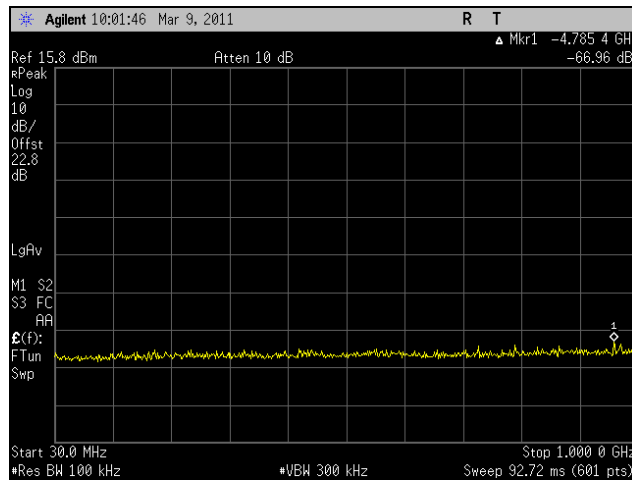

Plot 289. Conducted Spurious Emissions, Low Channel, 30 MHz – 1 GHz, 802.11n HT30, Port 2

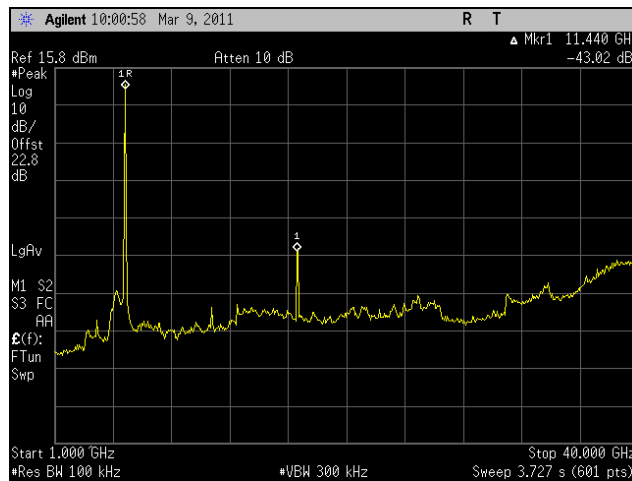

Plot 290. Conducted Spurious Emissions, Low Channel, 1 GHz – 40 GHz, 802.11n HT30, Port 2

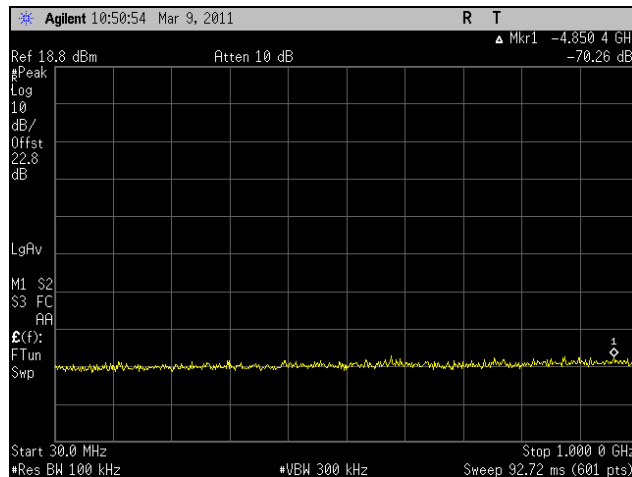

Plot 291. Conducted Spurious Emissions, Mid Channel, 30 MHz – 1 GHz, 802.11n HT30, Port 2

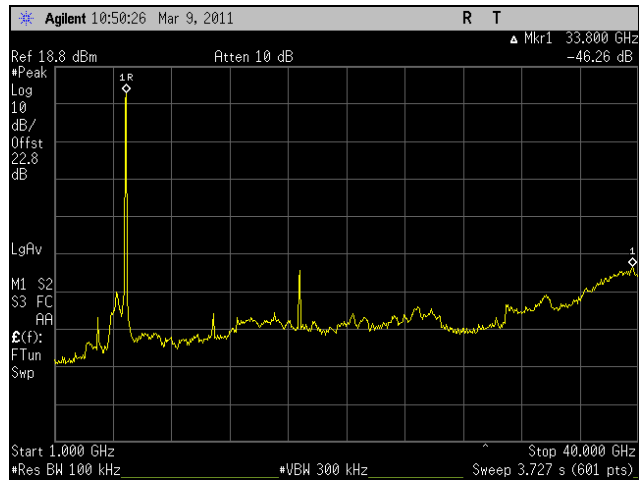

Plot 292. Conducted Spurious Emissions, Mid Channel, 1 GHz – 40 GHz, 802.11n HT30, Port 2

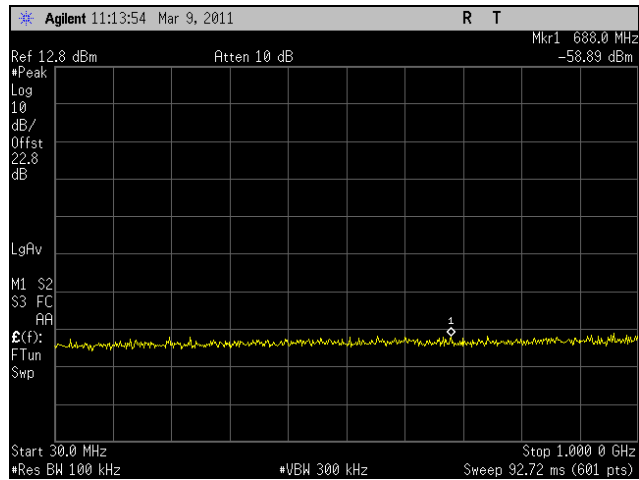

Plot 293. Conducted Spurious Emissions, High Channel, 30 MHz – 1 GHz, 802.11n HT30, Port 2

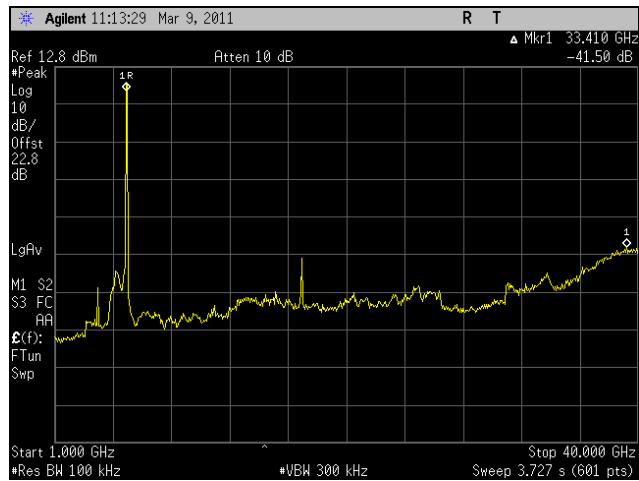

Plot 294. Conducted Spurious Emissions, High Channel, 1 GHz – 26 GHz, 802.11n HT30, Port 2

Conducted Spurious Emissions Test Results, 802.11n HT40, Port 1

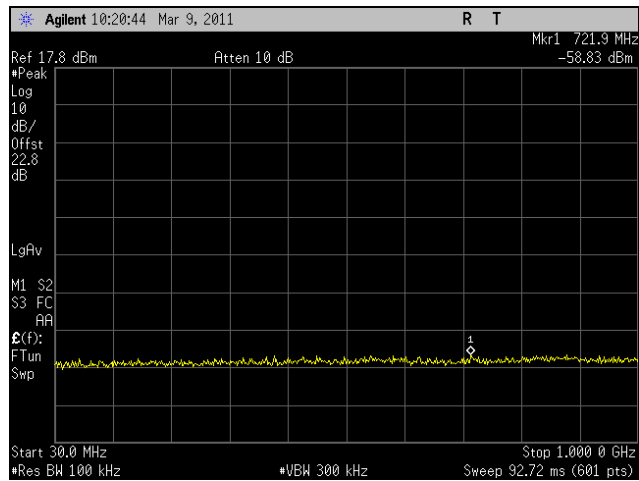

Plot 295. Conducted Spurious Emissions, Low Channel, 30 MHz – 1 GHz, 802.11n HT40, Port 1

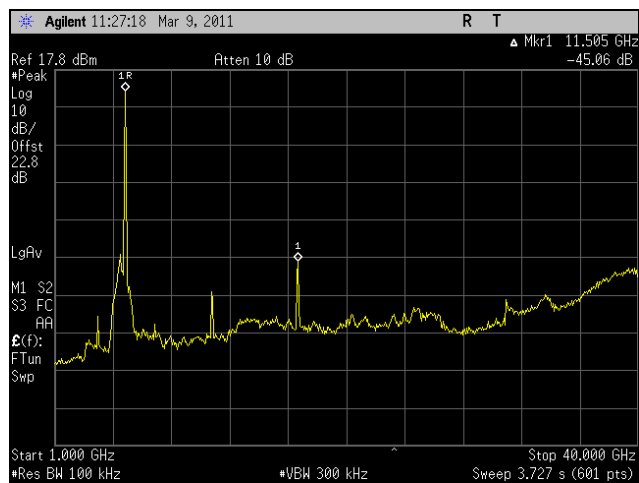

Plot 296. Conducted Spurious Emissions, Low Channel, 1 GHz – 40 GHz, 802.11n HT40, Port 1

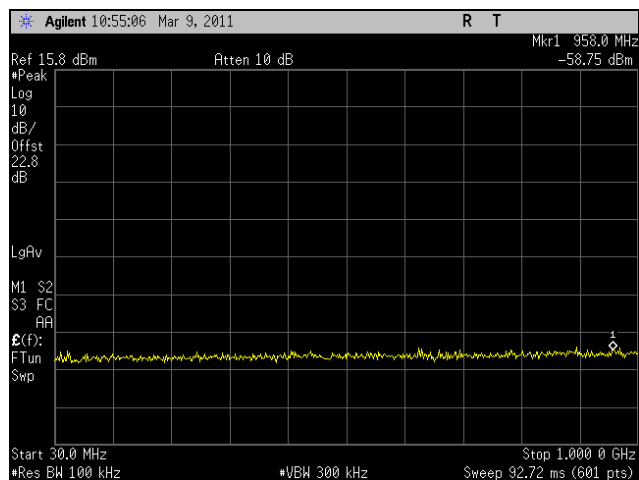

Plot 297. Conducted Spurious Emissions, Mid Channel, 30 MHz – 1 GHz, 802.11n HT40, Port 1

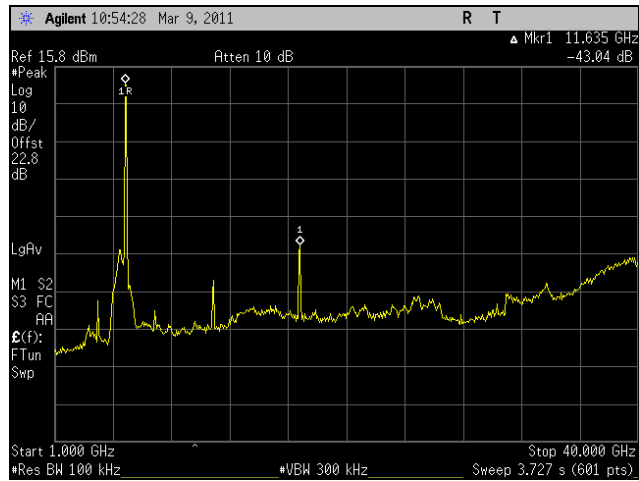

Plot 298. Conducted Spurious Emissions, Mid Channel, 1 GHz – 40 GHz, 802.11n HT40, Port 1

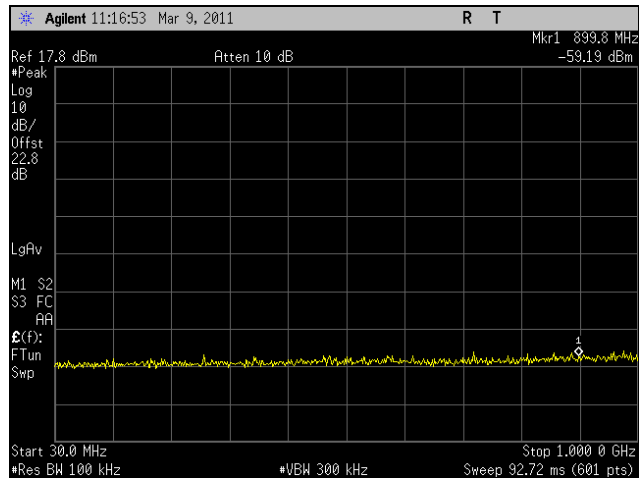

Plot 299. Conducted Spurious Emissions, High Channel, 30 MHz – 1 GHz, 802.11n HT40, Port 1

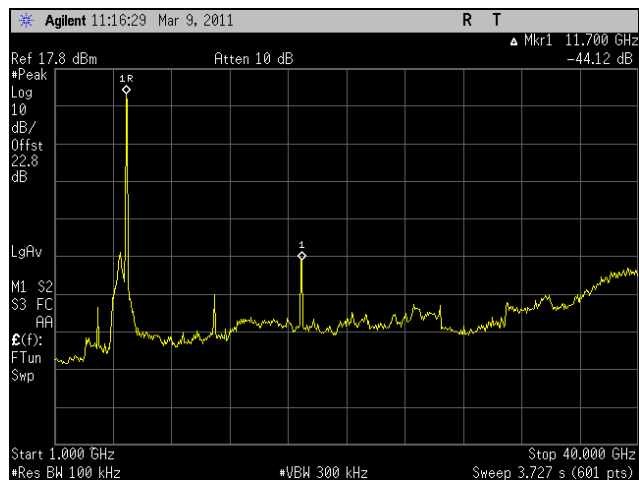

Plot 300. Conducted Spurious Emissions, High Channel, 1 GHz – 40 GHz, 802.11n HT40, Port 1

Conducted Spurious Emissions Test Results, 802.11n HT40, Port 2

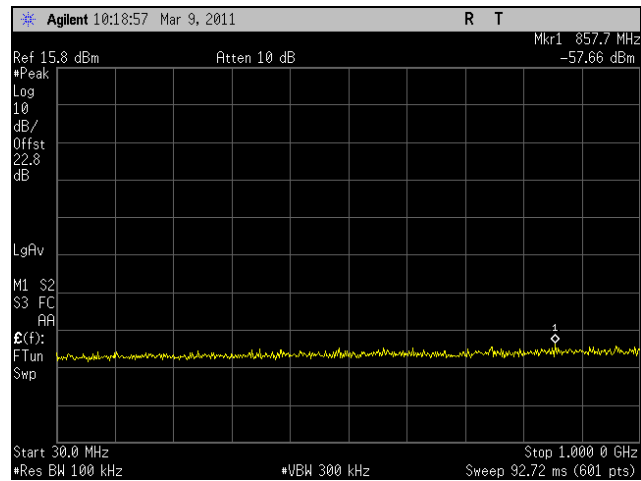

Plot 301. Conducted Spurious Emissions, Low Channel, 30 MHz – 1 GHz, 802.11n HT40, Port 2

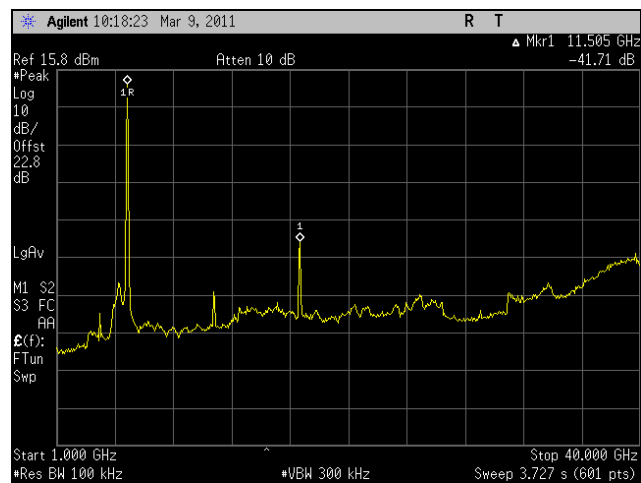

Plot 302. Conducted Spurious Emissions, Low Channel, 1 GHz – 40 GHz, 802.11n HT40, Port 2

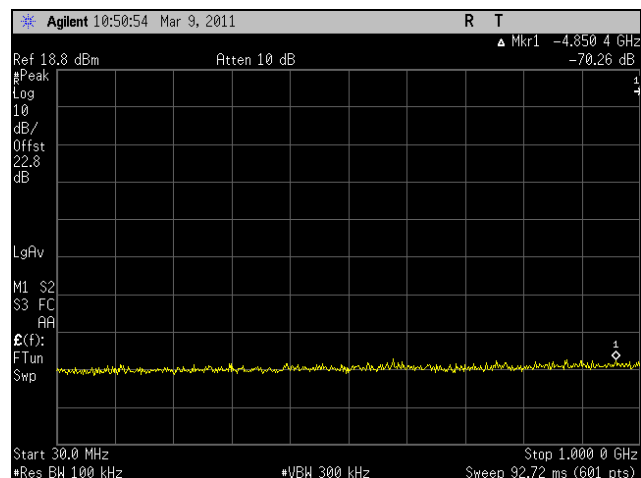

Plot 303. Conducted Spurious Emissions, Mid Channel, 30 MHz – 1 GHz, 802.11n HT40, Port 2

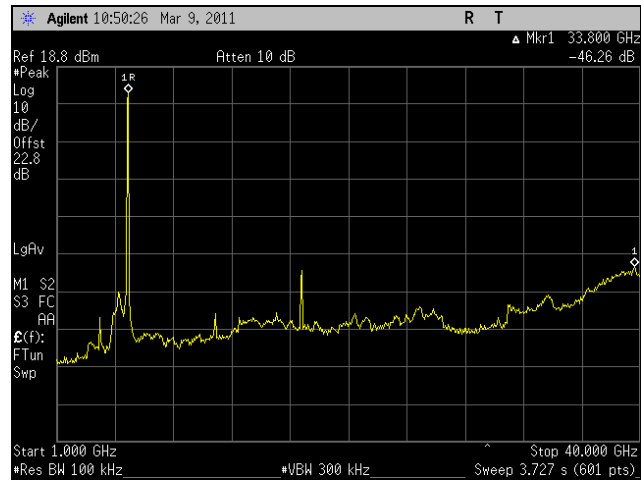

Plot 304. Conducted Spurious Emissions, Mid Channel, 1 GHz – 40 GHz, 802.11n HT40, Port 2

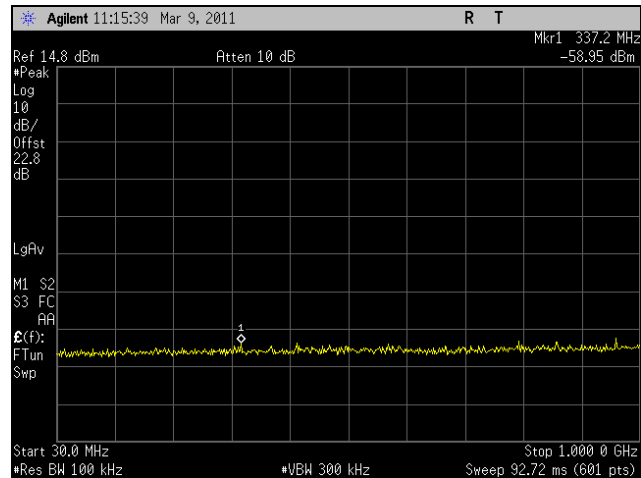

Plot 305. Conducted Spurious Emissions, High Channel, 30 MHz – 1 GHz, 802.11n HT40, Port 2

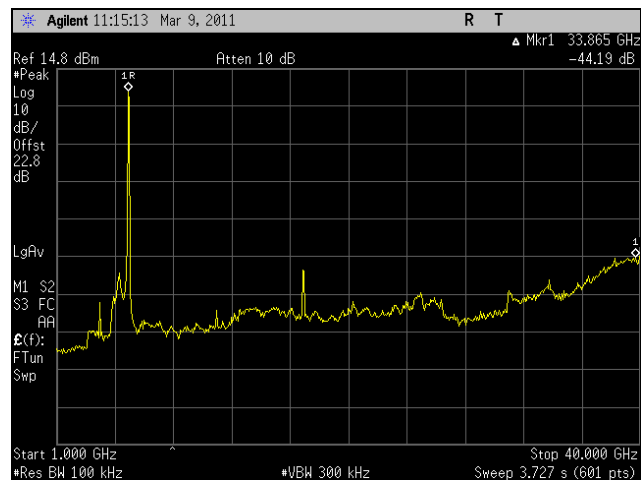

Plot 306. Conducted Spurious Emissions, High Channel, 1 GHz – 40 GHz, 802.11n HT40, Port 2

Conducted Band Edge Test Results, 802.11a 20 MHz

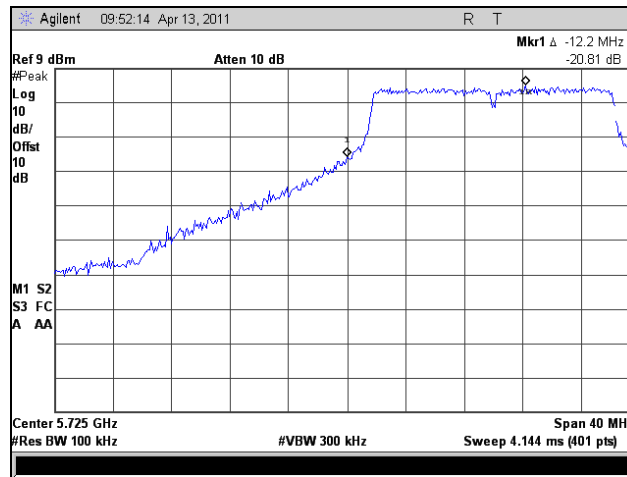

Plot 307. Conducted Band Edge, Low Channel, 802.11a 20 MHz

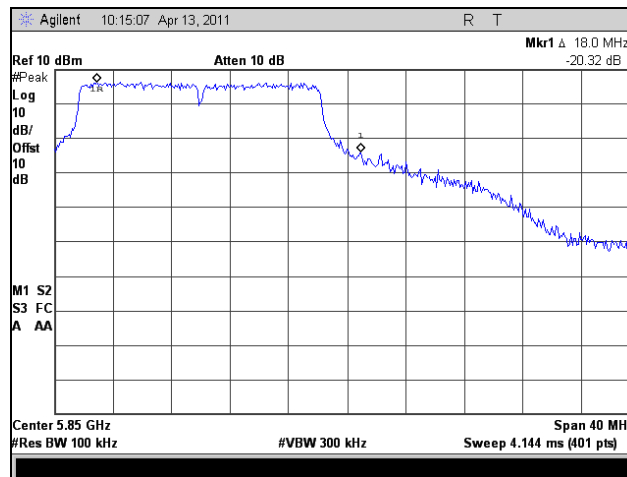

Plot 308. Conducted Band Edge, High Channel, 802.11a 20 MHz

Conducted Band Edge Test Results, 802.11a 40 MHz

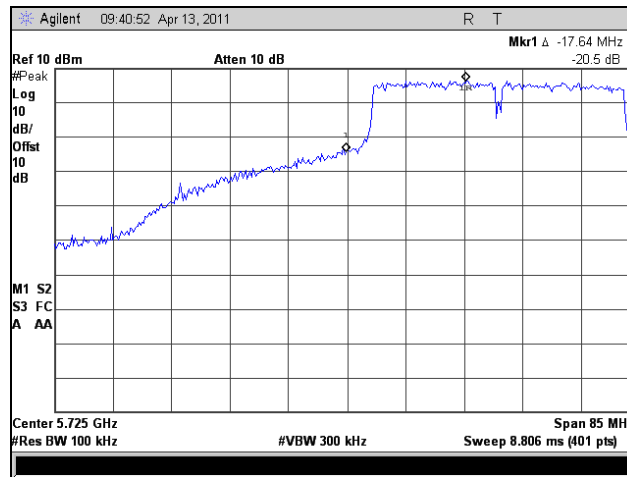

Plot 309. Conducted Band Edge, Low Channel, 802.11a 40 MHz

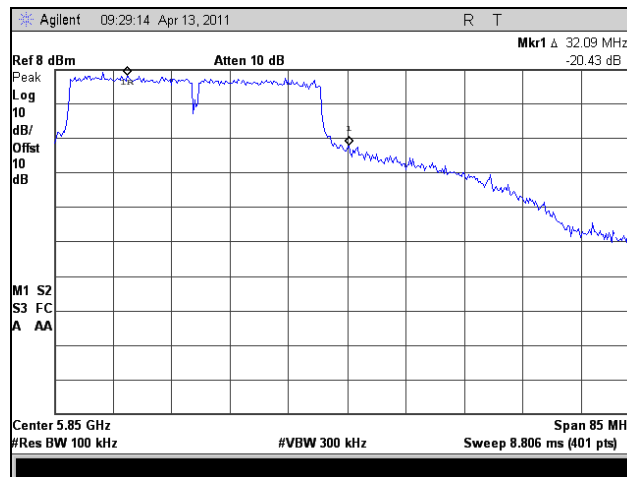

Plot 310. Conducted Band Edge, High Channel, 802.11a 40 MHz

Conducted Band Edge Test Results, 802.11n HT5

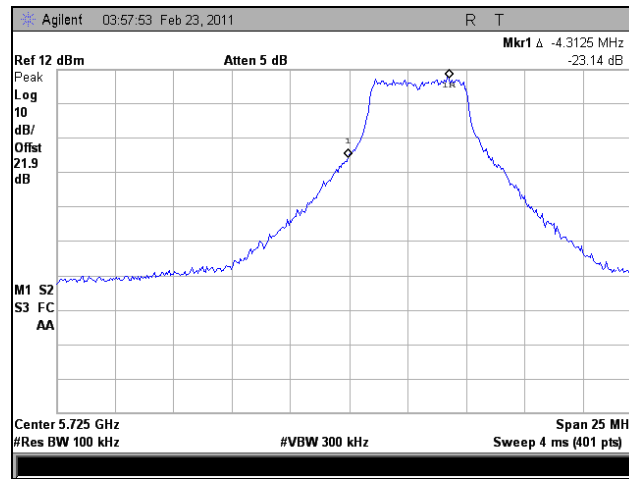

Plot 311. Conducted Band Edge, Low Channel, 802.11n HT5, Port 1

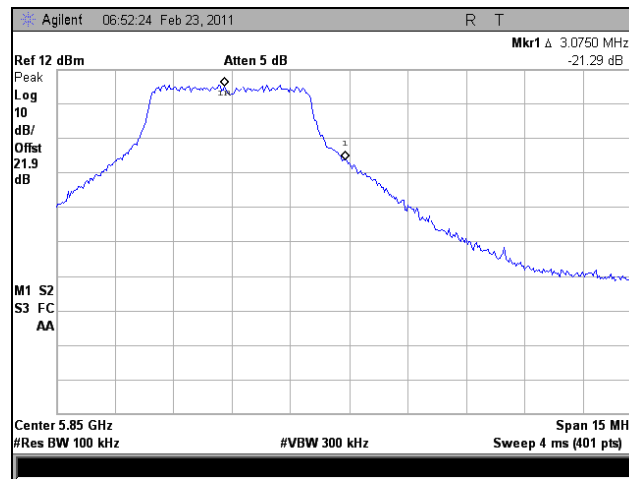

Plot 312. Conducted Band Edge, High Channel, 802.11n HT5, Port 1

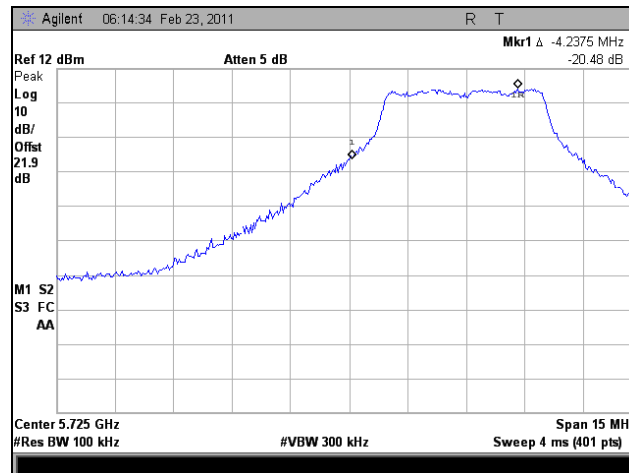

Plot 313. Conducted Band Edge, Low Channel, 802.11n HT5, Port 2

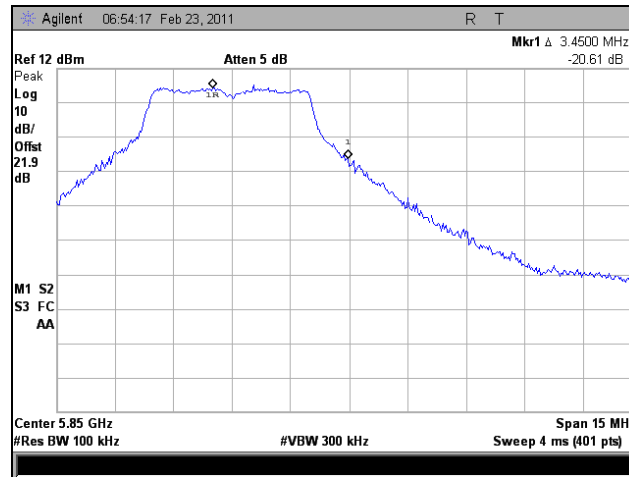

Plot 314. Conducted Band Edge, High Channel, 802.11n HT5, Port 2

Conducted Band Edge Test Results, 802.11n HT8

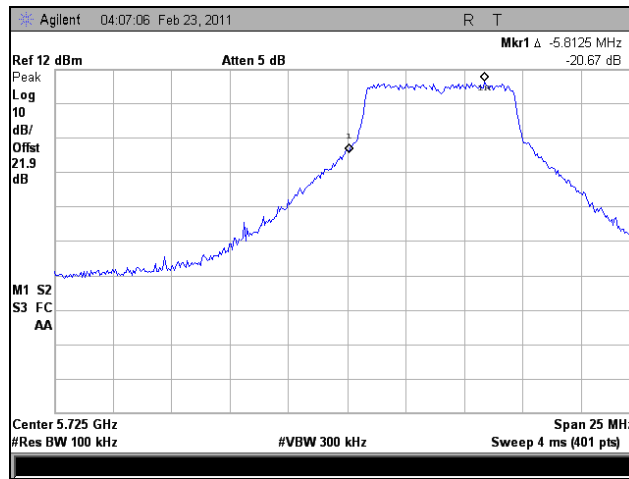

Plot 315. Conducted Band Edge, Low Channel, 802.11n HT8, Port 1

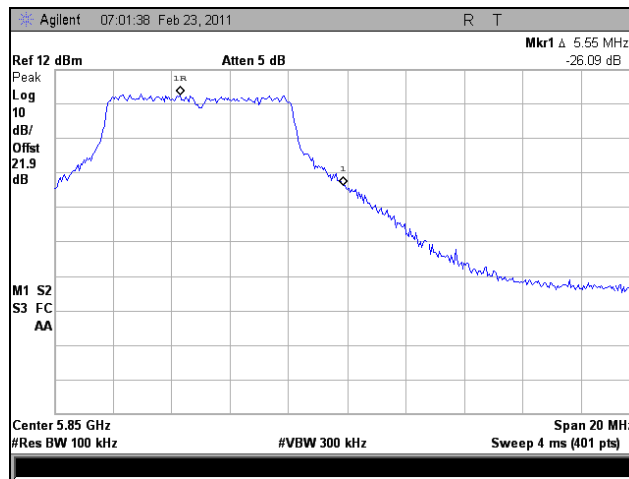

Plot 316. Conducted Band Edge, High Channel, 802.11n HT8, Port 1

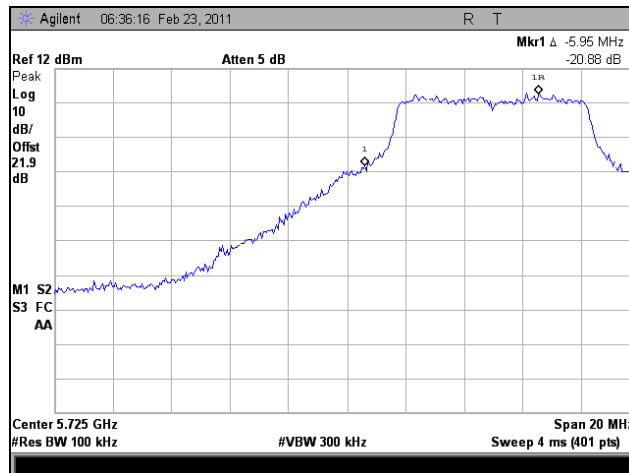

Plot 317. Conducted Band Edge, Low Channel, 802.11n HT8, Port 2

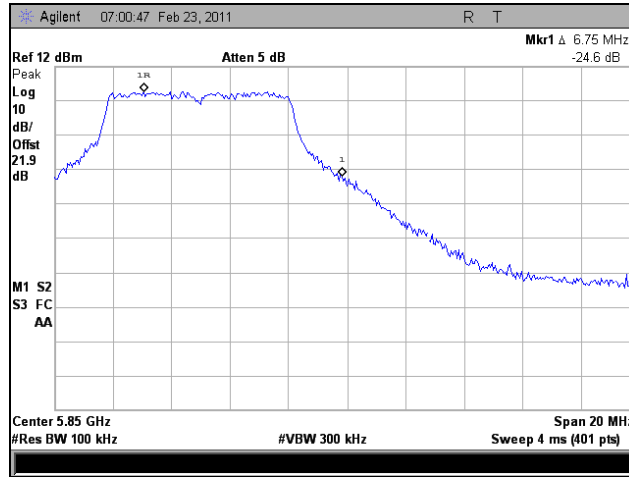

Plot 318. Conducted Band Edge, High Channel, 802.11n HT8, Port 2

Conducted Band Edge Test Results, 802.11n HT10

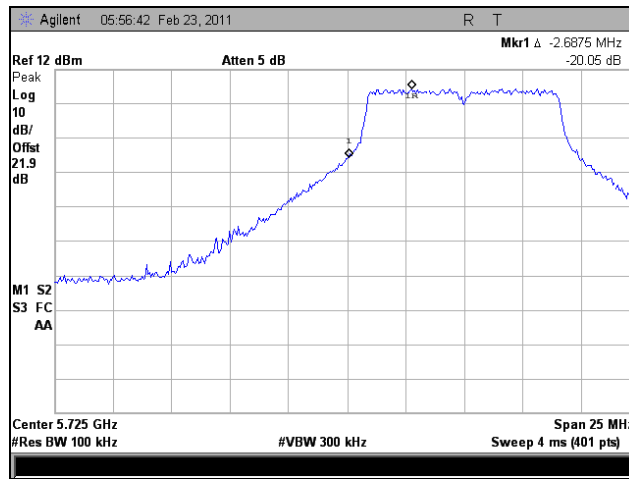

Plot 319. Conducted Band Edge, Low Channel, 802.11n HT10, Port 1

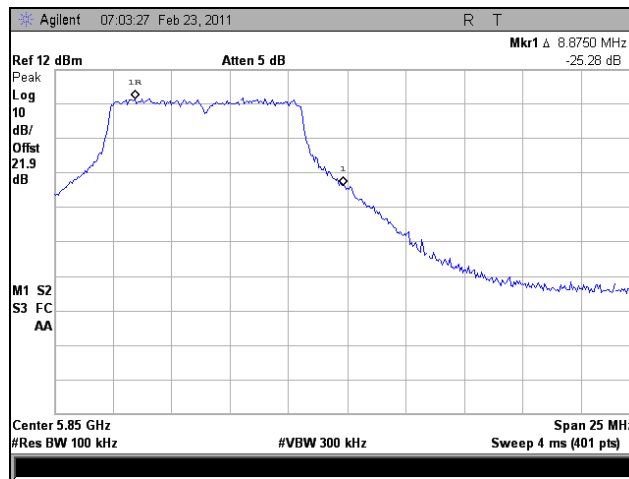

Plot 320. Conducted Band Edge, High Channel, 802.11n HT10, Port 1

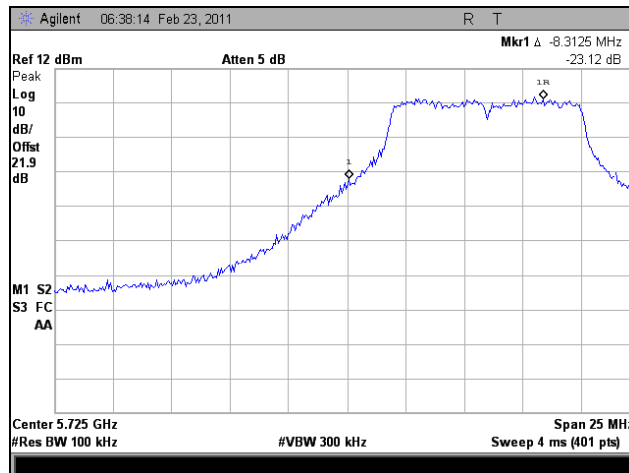

Plot 321. Conducted Band Edge, Low Channel, 802.11n HT10, Port 2

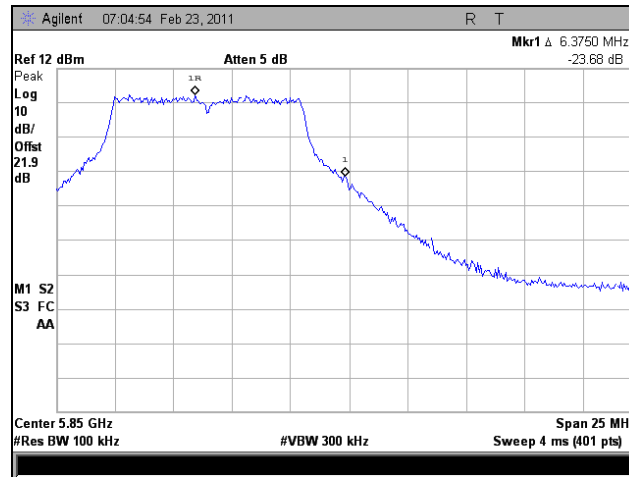

Plot 322. Conducted Band Edge, High Channel, 802.11n HT10, Port 2

Conducted Band Edge Test Results, 802.11n HT20

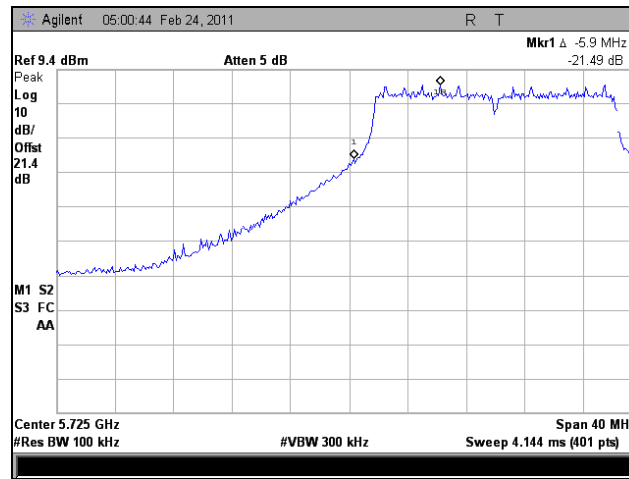

Plot 323. Conducted Band Edge, Low Channel, 802.11n HT20, Port 1

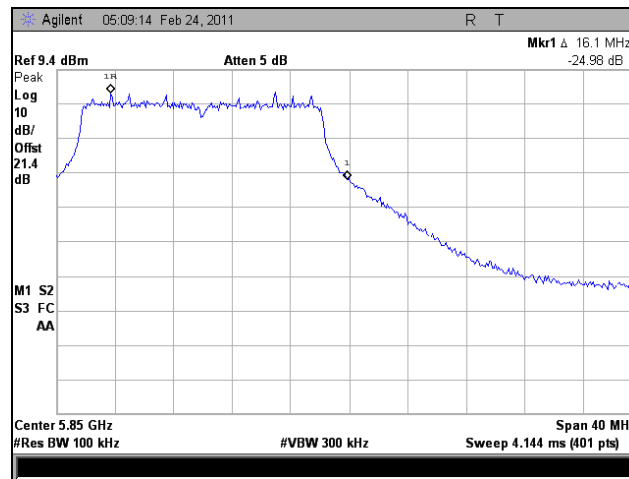

Plot 324. Conducted Band Edge, High Channel, 802.11n HT20, Port 1

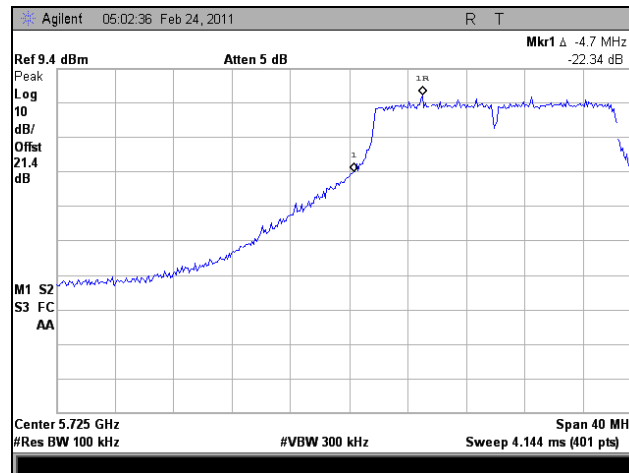

Plot 325. Conducted Band Edge, Low Channel, 802.11n HT20, Port 2

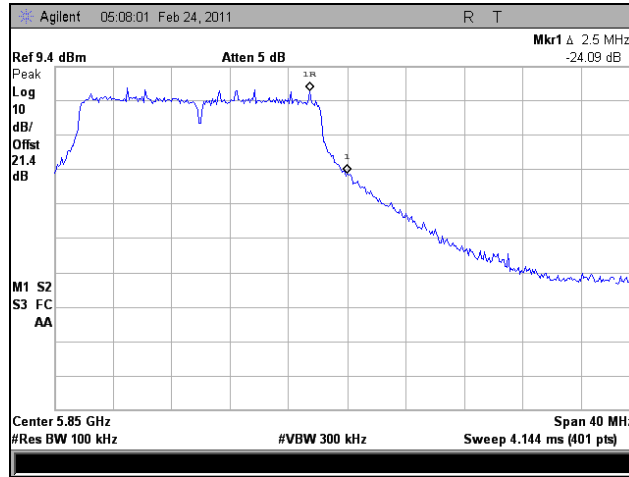

Plot 326. Conducted Band Edge, High Channel, 802.11n HT20, Port 2

Conducted Band Edge Test Results, 802.11n HT30

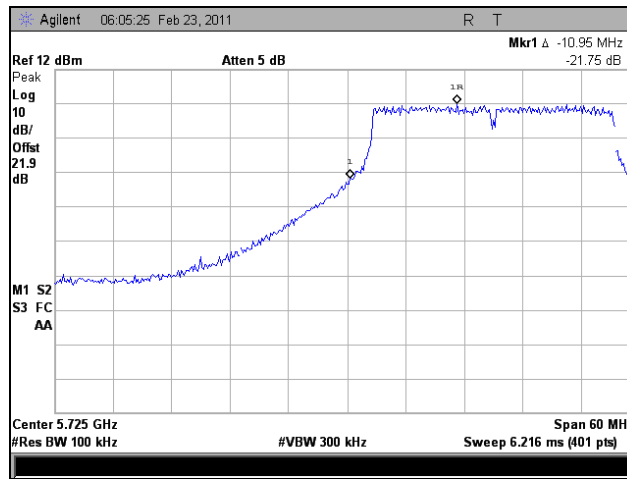

Plot 327. Conducted Band Edge, Low Channel, 802.11n HT30, Port 1

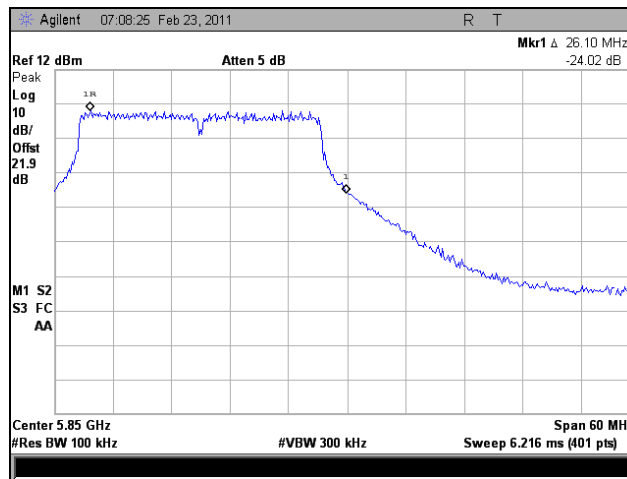

Plot 328. Conducted Band Edge, High Channel, 802.11n HT30, Port 1

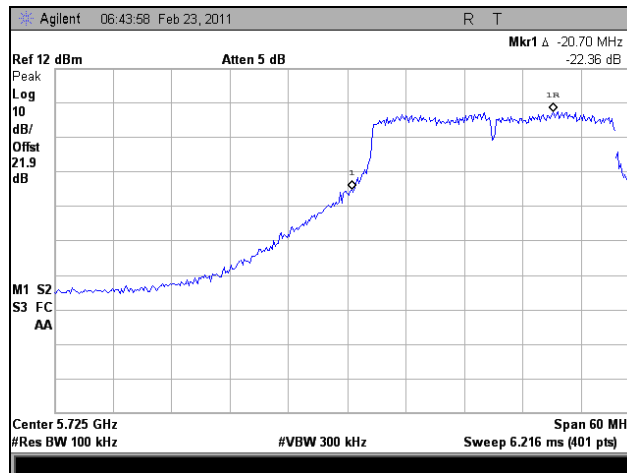

Plot 329. Conducted Band Edge, Low Channel, 802.11n HT30, Port 2

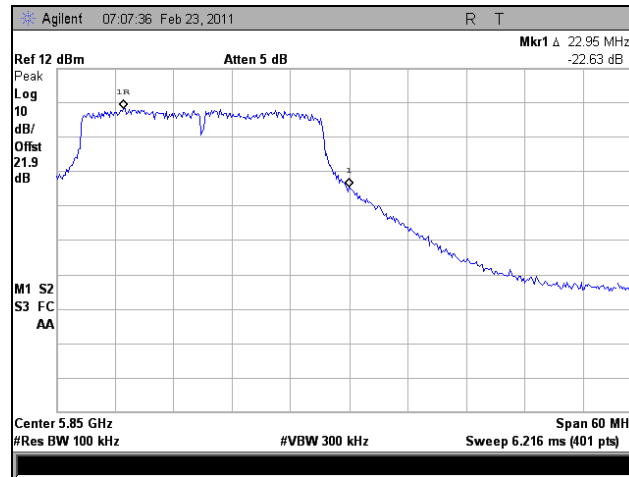

Plot 330. Conducted Band Edge, High Channel, 802.11n HT30, Port 2

Conducted Band Edge Test Results, 802.11n HT40

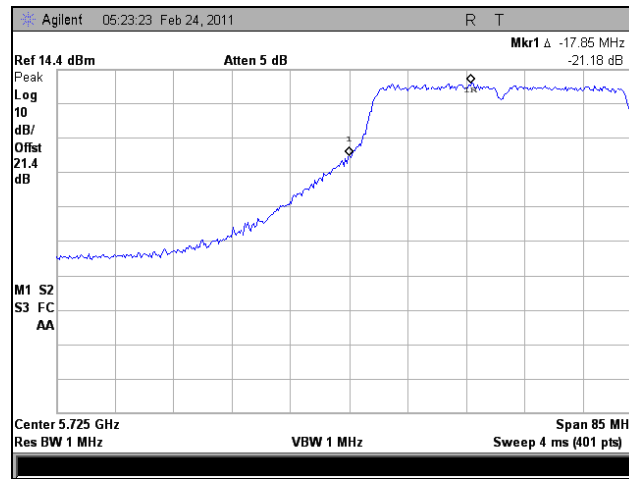

Plot 331. Conducted Band Edge, Low Channel, 802.11n HT40, Port 1

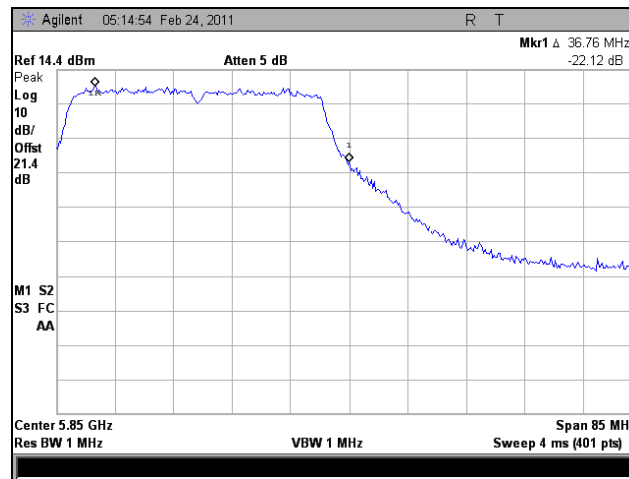

Plot 332. Conducted Band Edge, High Channel, 802.11n HT40, Port 1

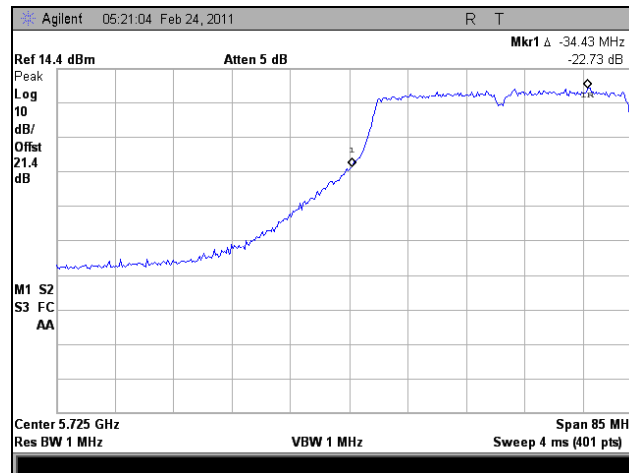

Plot 333. Conducted Band Edge, Low Channel, 802.11n HT40, Port 2

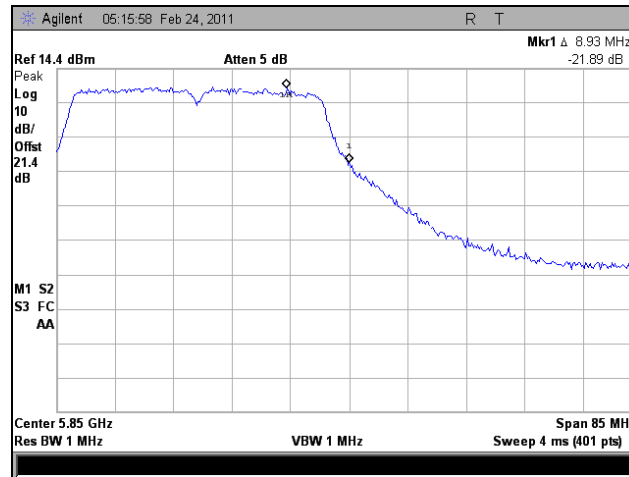

Plot 334. Conducted Band Edge, High Channel, 802.11n HT40, Port 2

Electromagnetic Compatibility Criteria for Intentional Radiators

§ 15.247(e) Peak Power Spectral Density

- Test Requirements:** §15.247(e): For digitally modulated systems, the peak power spectral density conducted from the intentional radiator to the antenna shall not be greater than 8dBm in any 3 kHz band during any time interval of continuous transmission.
- Test Procedure:** The transmitter was connected directly to a Spectrum Analyzer through an attenuator. The power level was set to the maximum level. A RBW of 1 MHz and VBW of 3 MHz were used to determine the peak emissions within the band. The Spectrum analyzer was then set to a RBW of 3 kHz and VBW was set to 10 kHz. The SPAN of the analyzer was set to 1 MHz with a 333.3 second sweep. Measurements were carried out at the low, mid and high channels.
- Test Results:** The EUT was compliant with the peak power spectral density limits of § 15.247 (e).
The peak power spectral density was determined from plots on the following page(s).
- Test Engineer:** Kenshi Chung
- Test Date:** 03/07/11

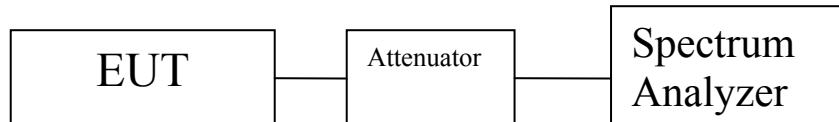

Figure 5. Block Diagram, Peak Power Spectral Density Test Setup

Peak Power Spectral Density Test Results

Peak Power Spectral Density				
Carrier Channel	Frequency (MHz)	Measured PPSD (dBm)	Limit (dBm)	Margin (dB)
Low	5728	6.159	8	-1.841
Mid	5787	7.687	8	-0.313
High	5847	4.925	8	-3.075

Table 32. Peak Power Spectral Density, Test Results, Combiner, 802.11n HT5

Peak Power Spectral Density				
Carrier Channel	Frequency (MHz)	Measured PPSD (dBm)	Limit (dBm)	Margin (dB)
Low	5730	2.804	8	-5.196
Mid	5787	3.421	8	-4.579
High	5845	4.942	8	-3.058

Table 33. Peak Power Spectral Density, Test Results, Combiner, 802.11n HT8

Peak Power Spectral Density				
Carrier Channel	Frequency (MHz)	Measured PPSD (dBm)	Limit (dBm)	Margin (dB)
Low	5731	5.48	8	-2.52
Mid	5787	1.937	8	-6.063
High	5844	2.024	8	-5.976

Table 34. Peak Power Spectral Density, Test Results, Combiner, 802.11n HT10

Peak Power Spectral Density				
Carrier Channel	Frequency (MHz)	Measured PPSD (dBm)	Limit (dBm)	Margin (dB)
Low	5735	1.908	8	-6.092
Mid	5787	-0.591	8	-8.591
High	5840	-1.328	8	-9.328

Table 35. Peak Power Spectral Density, Test Results, Combiner, 802.11n HT20

Peak Power Spectral Density				
Carrier Channel	Frequency (MHz)	Measured PPSD (dBm)	Limit (dBm)	Margin (dB)
Low	5740	-2.231	8	-10.231
Mid	5787	-2.318	8	-10.318
High	5835	-2.155	8	-10.155

Table 36. Peak Power Spectral Density, Test Results, Combiner, 802.11n HT30

Peak Power Spectral Density				
Carrier Channel	Frequency (MHz)	Measured PPSD (dBm)	Limit (dBm)	Margin (dB)
Low	5747	-6.917	8	-14.917
Mid	5787	-4.945	8	-12.945
High	5828	-3.149	8	-11.149

Table 37. Peak Power Spectral Density, Test Results, Combiner, 802.11n HT40

Peak Power Spectral Density				
Carrier Channel	Frequency (MHz)	Measured PPSD (dBm)	Limit (dBm)	Margin (dB)
Low	5735	-8.634	8	-16.634
Mid	5787	-4.484	8	-12.484
High	5840	-3.138	8	-11.138

Table 38. Peak Power Spectral Density, Test Results, 802.11a 20 MHz

Peak Power Spectral Density				
Carrier Channel	Frequency (MHz)	Measured PPSD (dBm)	Limit (dBm)	Margin (dB)
Low	5747	-6.977	8	-14.977
Mid	5787	-7.675	8	-15.675
High	5828	-9.371	8	-17.371

Table 39. Peak Power Spectral Density, Test Results, 802.11a 40 MHz

Peak Power Spectral Density				
Carrier Channel	Frequency (MHz)	Measured PPSD (dBm)	Limit (dBm)	Margin (dB)
Low	5728	2.425	8	-5.575
Mid	5787	0.564	8	-7.436
High	5847	0.179	8	-7.821

Table 40. Peak Power Spectral Density, Test Results, Port 1, 802.11n HT5

Peak Power Spectral Density				
Carrier Channel	Frequency (MHz)	Measured PPSD (dBm)	Limit (dBm)	Margin (dB)
Low	5730	-1.831	8	-9.831
Mid	5787	0.44	8	-7.56
High	5845	-0.582	8	-8.582

Table 41. Peak Power Spectral Density, Test Results, Port 1, 802.11n HT8

Peak Power Spectral Density				
Carrier Channel	Frequency (MHz)	Measured PPSD (dBm)	Limit (dBm)	Margin (dB)
Low	5731	-1.898	8	-9.898
Mid	5787	-3.095	8	-11.095
High	5844	-1.835	8	-9.835

Table 42. Peak Power Spectral Density, Test Results, Port 1, 802.11n HT10

Peak Power Spectral Density				
Carrier Channel	Frequency (MHz)	Measured PPSD (dBm)	Limit (dBm)	Margin (dB)
Low	5735	-4.563	8	-12.563
Mid	5787	-6.617	8	-14.617
High	5840	-6.69	8	-14.69

Table 43. Peak Power Spectral Density, Test Results, Port 1, 802.11n HT20

Peak Power Spectral Density				
Carrier Channel	Frequency (MHz)	Measured PPSD (dBm)	Limit (dBm)	Margin (dB)
Low	5740	-5.924	8	-13.924
Mid	5787	-6.555	8	-14.555
High	5835	-8.095	8	-16.095

Table 44. Peak Power Spectral Density, Test Results, Port 1, 802.11n HT30

Peak Power Spectral Density				
Carrier Channel	Frequency (MHz)	Measured PPSD (dBm)	Limit (dBm)	Margin (dB)
Low	5747	-9.302	8	-17.302
Mid	5787	-9.741	8	-17.741
High	5828	-8.836	8	-16.836

Table 45. Peak Power Spectral Density, Test Results, Port 1, 802.11n HT40

Peak Power Spectral Density				
Carrier Channel	Frequency (MHz)	Measured PPSD (dBm)	Limit (dBm)	Margin (dB)
Low	5728	-2.627	8	-10.627
Mid	5787	0.652	8	-7.348
High	5847	1.339	8	-6.661

Table 46. Peak Power Spectral Density, Test Results, Port 2, 802.11n HT5

Peak Power Spectral Density				
Carrier Channel	Frequency (MHz)	Measured PPSD (dBm)	Limit (dBm)	Margin (dB)
Low	5730	-1.58	8	-9.58
Mid	5787	1.349	8	-6.651
High	5845	-0.395	8	-8.395

Table 47. Peak Power Spectral Density, Test Results, Port 2, 802.11n HT8

Peak Power Spectral Density				
Carrier Channel	Frequency (MHz)	Measured PPSD (dBm)	Limit (dBm)	Margin (dB)
Low	5731	-2.801	8	-10.801
Mid	5787	-2.04	8	-10.04
High	5844	-1.464	8	-9.464

Table 48. Peak Power Spectral Density, Test Results, Port 2, 802.11n HT10

Peak Power Spectral Density				
Carrier Channel	Frequency (MHz)	Measured PPSD (dBm)	Limit (dBm)	Margin (dB)
Low	5735	-4.962	8	-12.962
Mid	5787	-6.026	8	-14.026
High	5840	-4.77	8	-12.77

Table 49. Peak Power Spectral Density, Test Results, Port 2, 802.11n HT20

Peak Power Spectral Density				
Carrier Channel	Frequency (MHz)	Measured PPSD (dBm)	Limit (dBm)	Margin (dB)
Low	5740	-6.556	8	-14.556
Mid	5787	-6.051	8	-14.051
High	5835	-5.894	8	-13.894

Table 50. Peak Power Spectral Density, Test Results, Port 2, 802.11n HT30

Peak Power Spectral Density				
Carrier Channel	Frequency (MHz)	Measured PPSD (dBm)	Limit (dBm)	Margin (dB)
Low	5747	-9.249	8	-17.249
Mid	5787	-7.32	8	-15.32
High	5828	-8.951	8	-16.951

Table 51. Peak Power Spectral Density, Test Results, Port 2, 802.11n HT40

Peak Power Spectral Density, 802.11a 20 MHz

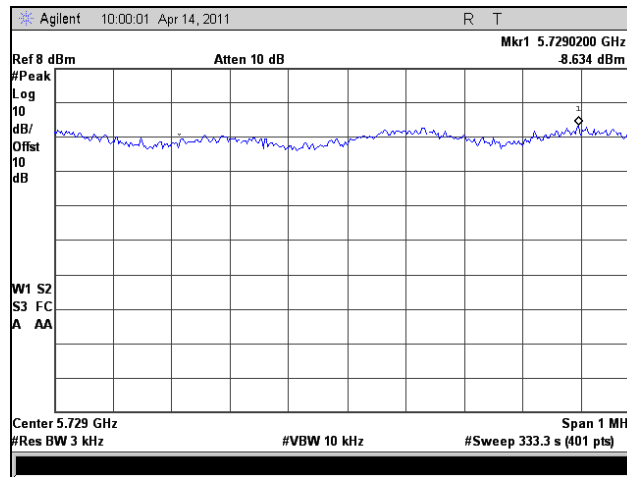

Plot 335. Peak Power Spectral Density, Low Channel, Average, 802.11a 20 MHz

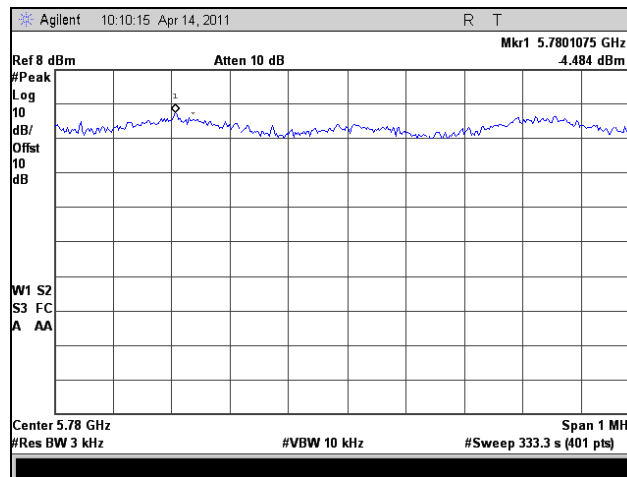

Plot 336. Peak Power Spectral Density, Mid Channel, Average, 802.11a 20 MHz

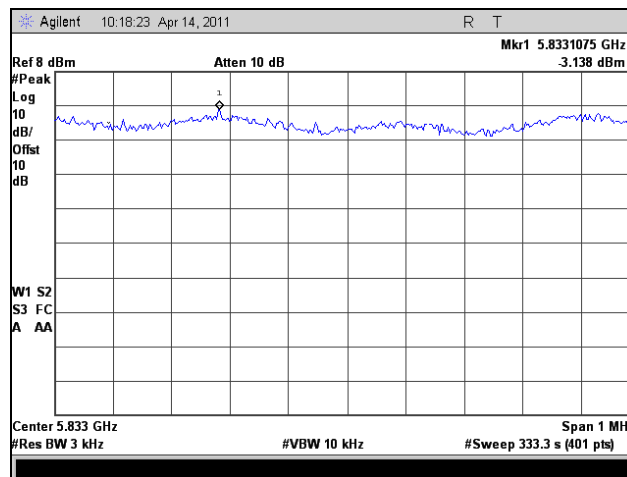

Plot 337. Peak Power Spectral Density, High Channel, Average, 802.11a 20 MHz

Peak Power Spectral Density, 802.11a 40 MHz

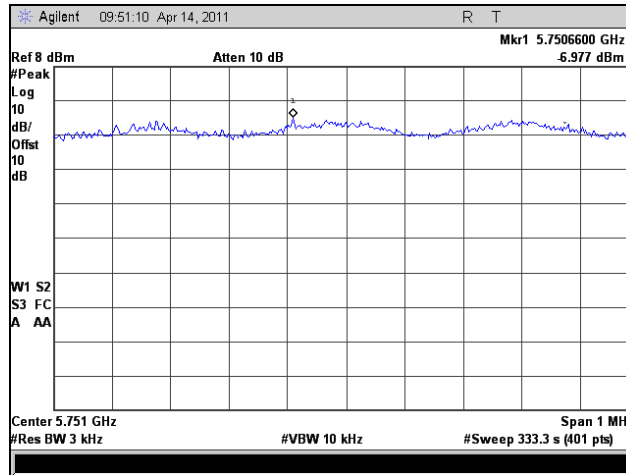

Plot 338. Peak Power Spectral Density, Low Channel, Average, 802.11a 40 MHz

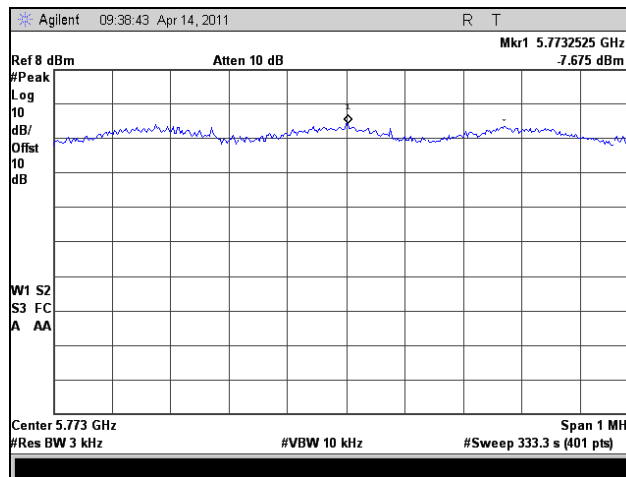

Plot 339. Peak Power Spectral Density, Mid Channel, Average, 802.11a 40 MHz

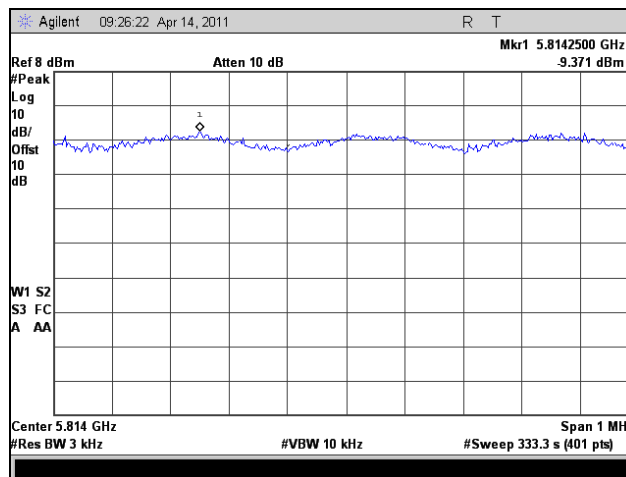

Plot 340. Peak Power Spectral Density, High Channel, Average, 802.11a 40 MHz

Peak Power Spectral Density, 802.11n HT5, Port 1

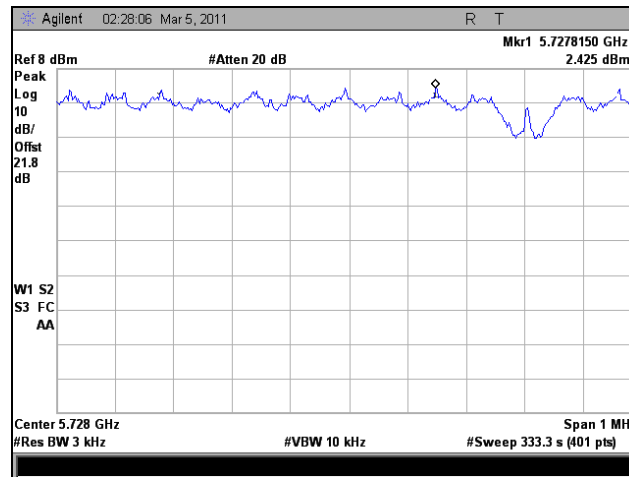

Plot 341. Peak Power Spectral Density, Low Channel, 802.11n HT5, Port 1

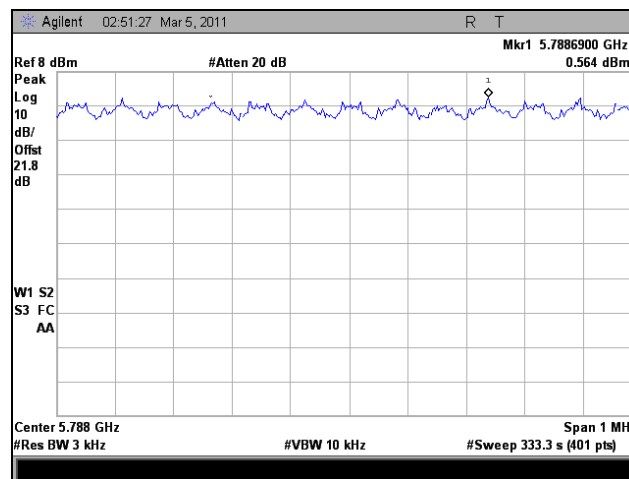

Plot 342. Peak Power Spectral Density, Mid Channel, 802.11n HT5, Port 1

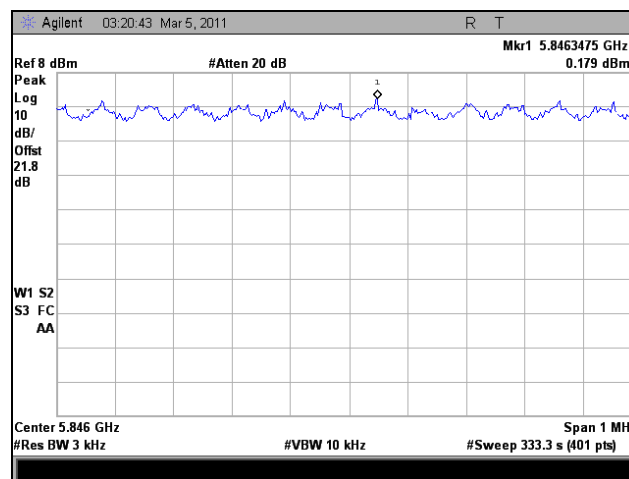

Plot 343. Peak Power Spectral Density, High Channel, 802.11n HT5, Port 1

Peak Power Spectral Density, 802.11n HT5, Port 2

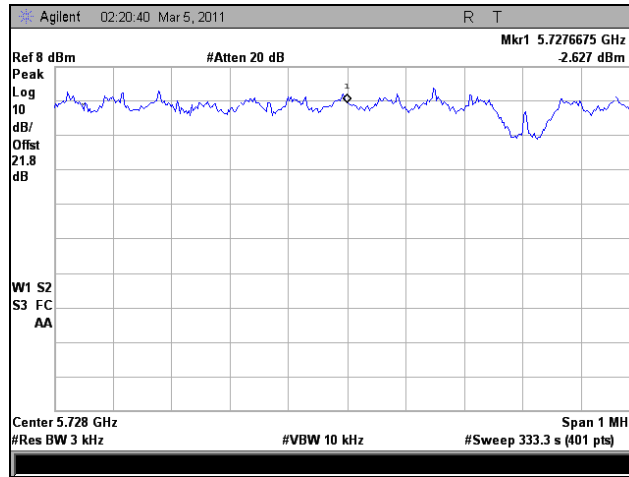

Plot 344. Peak Power Spectral Density, Low Channel, 802.11n HT5, Port 2

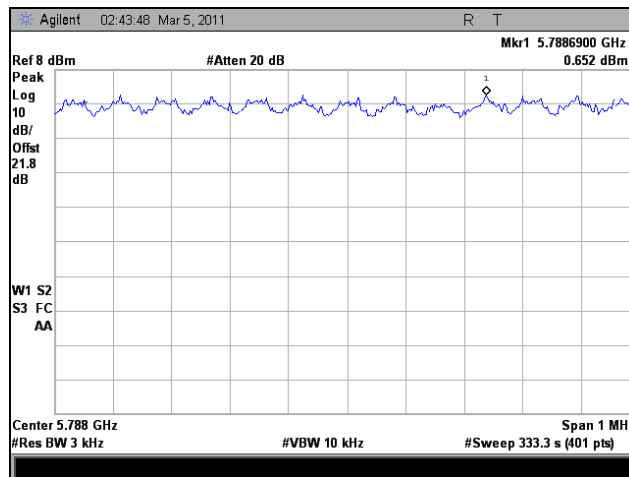

Plot 345. Peak Power Spectral Density, Mid Channel, 802.11n HT5, Port 2

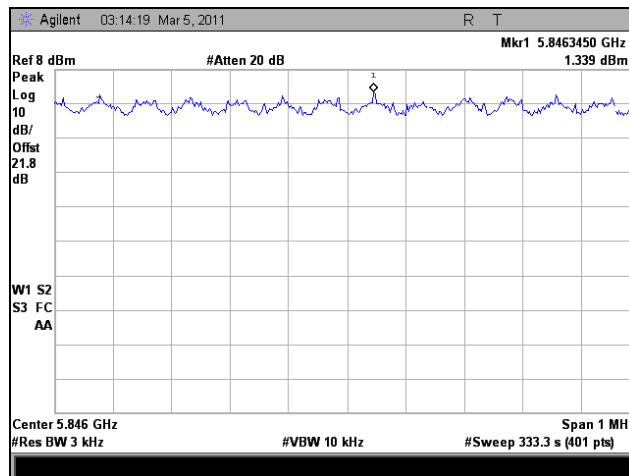

Plot 346. Peak Power Spectral Density, High Channel, 802.11n HT5, Port 2

Peak Power Spectral Density, 802.11n HT8, Port 1

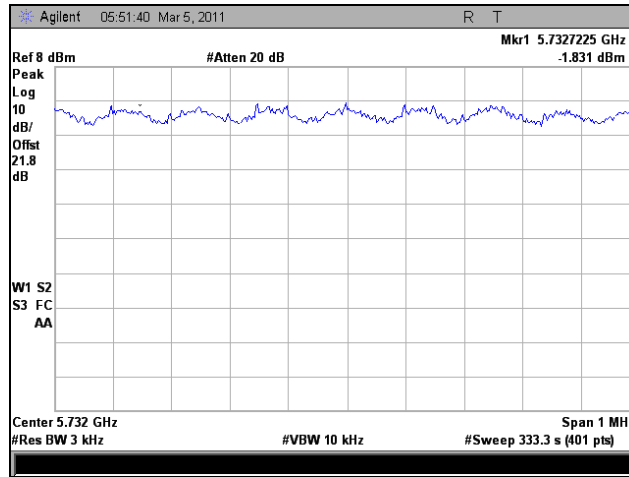

Plot 347. Peak Power Spectral Density, Low Channel, 802.11n HT8, Port 1

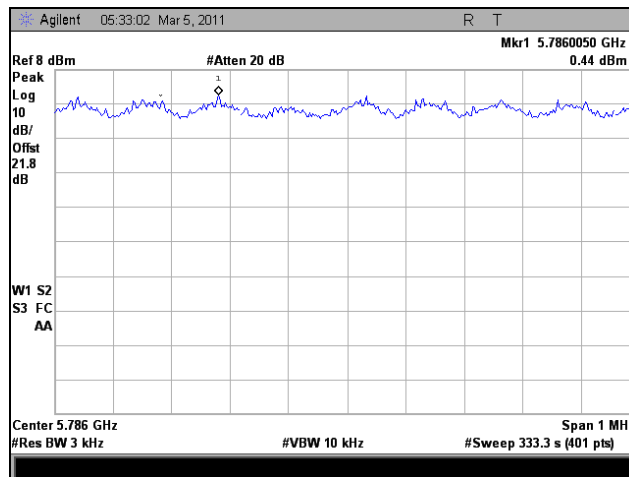

Plot 348. Peak Power Spectral Density, Mid Channel, 802.11n HT8, Port 1

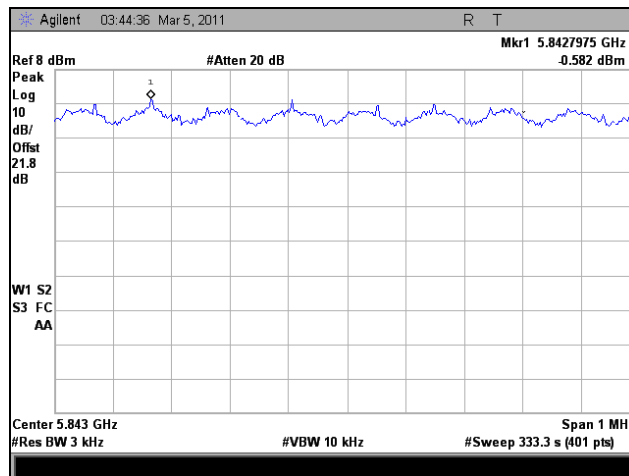

Plot 349. Peak Power Spectral Density, High Channel, 802.11n HT8, Port 1

Peak Power Spectral Density, 802.11n HT8, Port 2

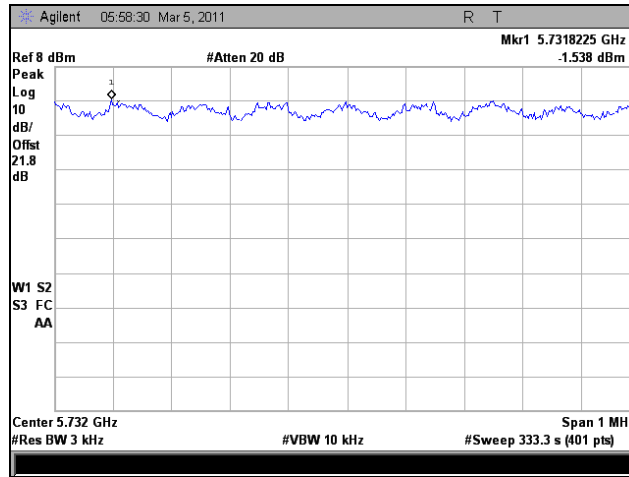

Plot 350. Peak Power Spectral Density, Low Channel, 802.11n HT8, Port 2

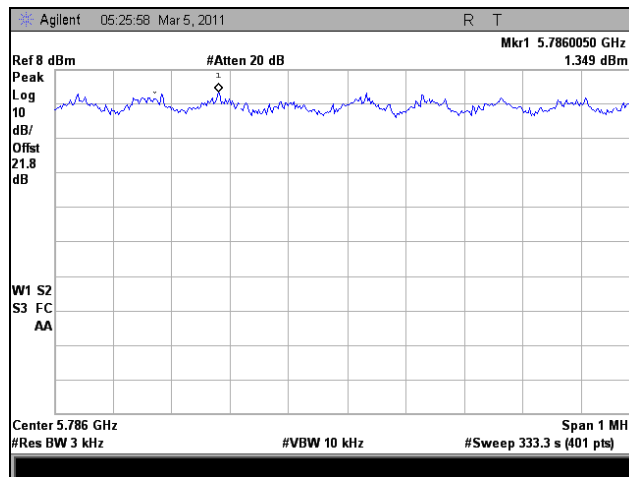

Plot 351. Peak Power Spectral Density, Mid Channel, 802.11n HT8, Port 2

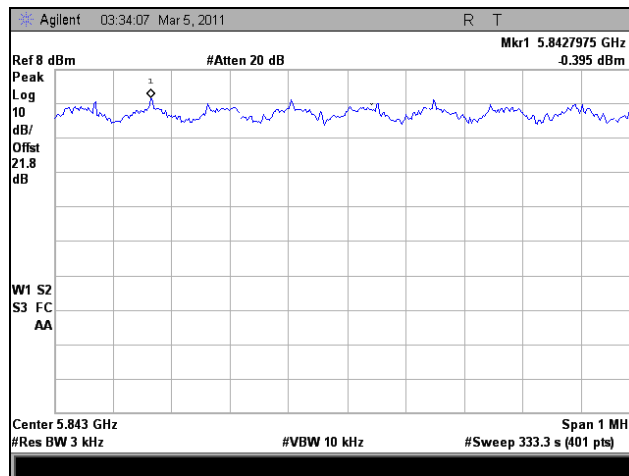

Plot 352. Peak Power Spectral Density, High Channel, 802.11n HT8, Port 2

Peak Power Spectral Density, 802.11n HT10, Port 1

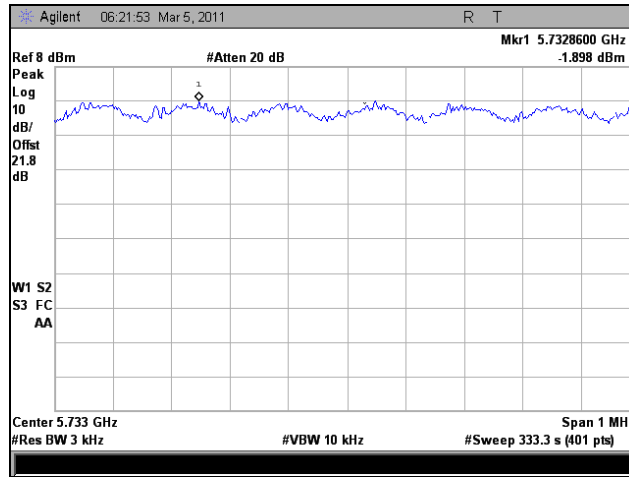

Plot 353. Peak Power Spectral Density, Low Channel, 802.11n HT10, Port 1

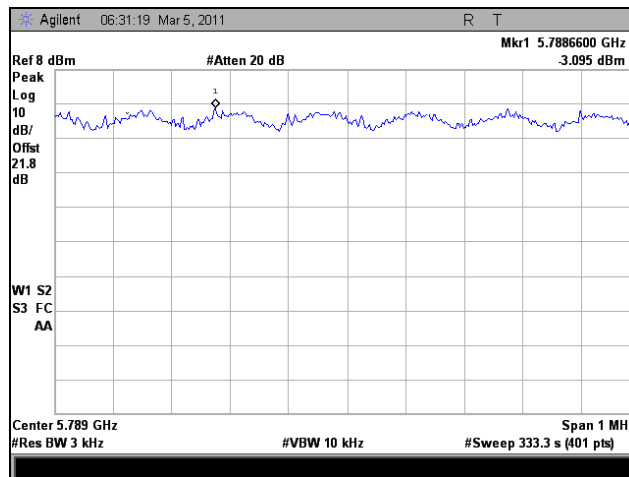

Plot 354. Peak Power Spectral Density, Mid Channel, 802.11n HT10, Port 1

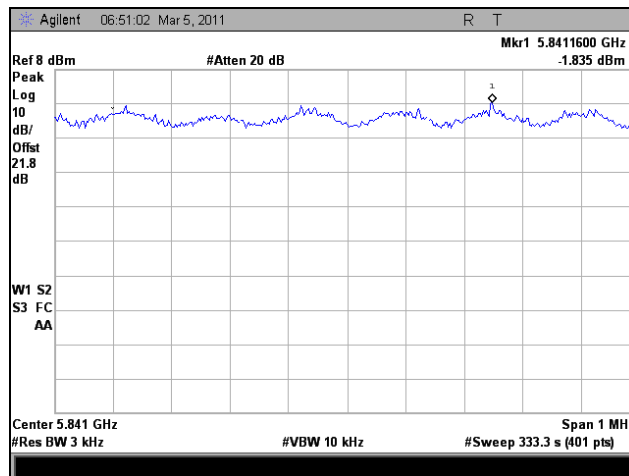

Plot 355. Peak Power Spectral Density, High Channel, 802.11n HT10, Port 1

Peak Power Spectral Density, 802.11n HT10, Port 2

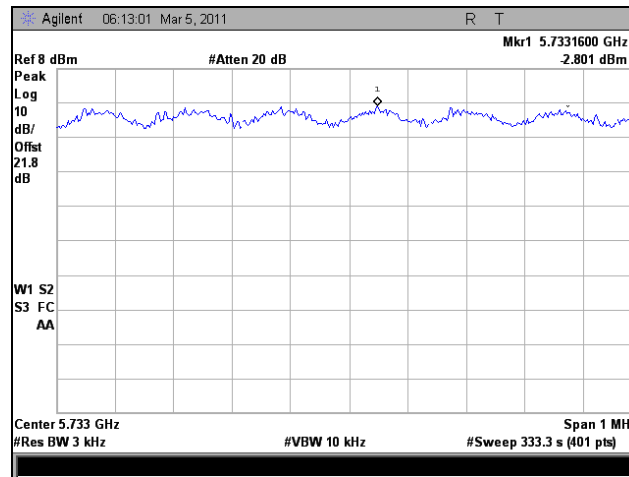

Plot 356. Peak Power Spectral Density, Low Channel, 802.11n HT10, Port 2

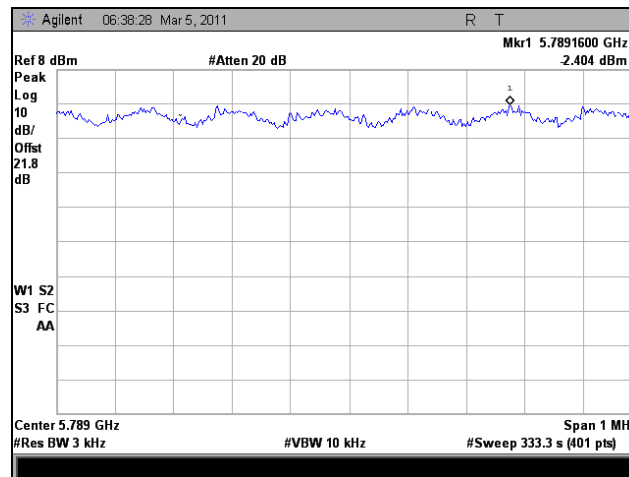

Plot 357. Peak Power Spectral Density, Mid Channel, 802.11n HT10, Port 2

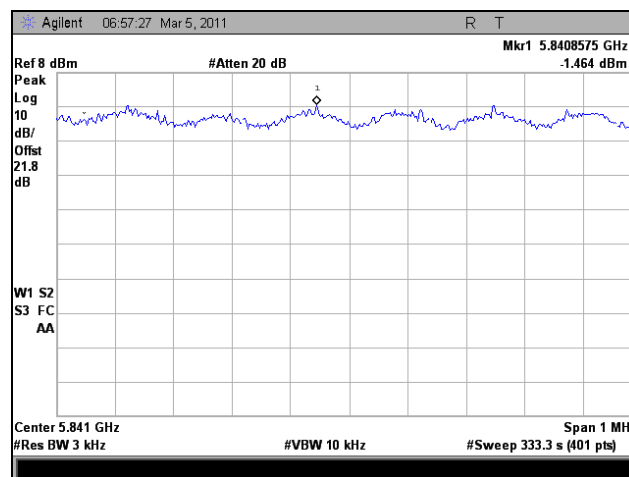

Plot 358. Peak Power Spectral Density, High Channel, 802.11n HT10, Port 2

Peak Power Spectral Density, 802.11n HT20, Port 1

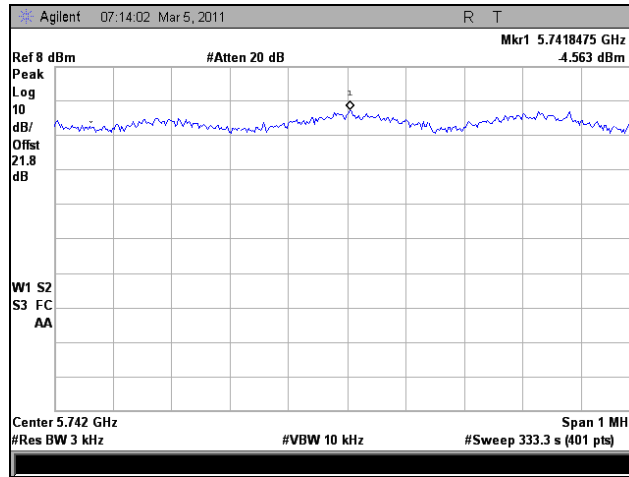

Plot 359. Peak Power Spectral Density, Low Channel, 802.11n HT20, Port 1

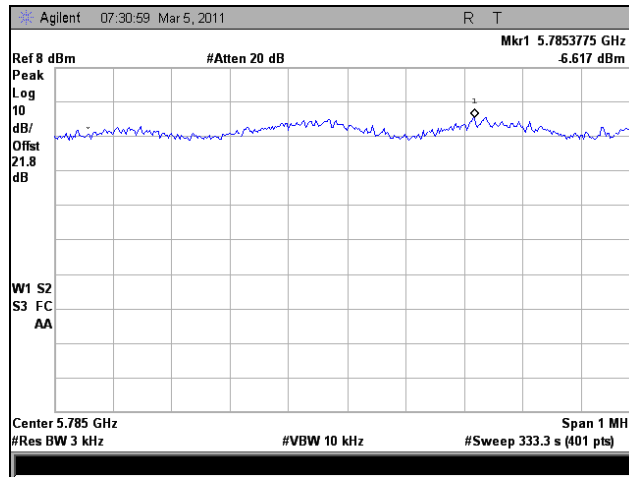

Plot 360. Peak Power Spectral Density, Mid Channel, 802.11n HT20, Port 1

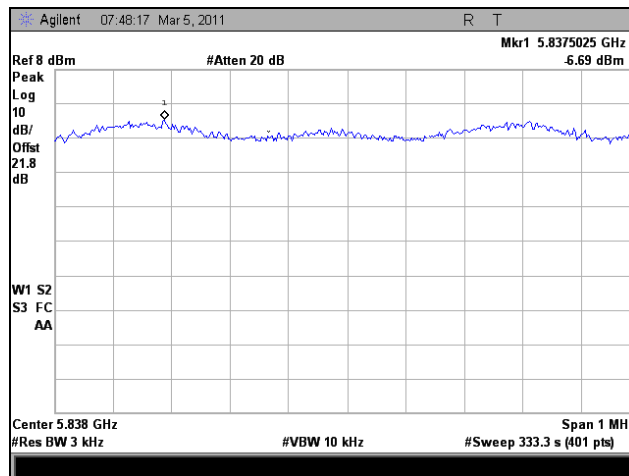

Plot 361. Peak Power Spectral Density, High Channel, 802.11n HT20, Port 1

Peak Power Spectral Density, 802.11n HT20, Port 2

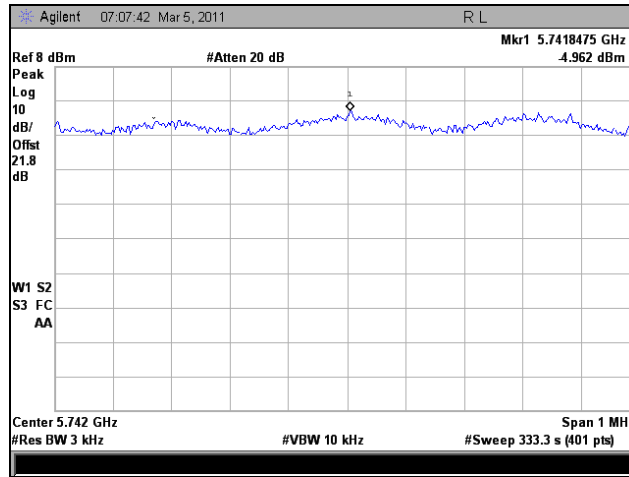

Plot 362. Peak Power Spectral Density, Low Channel, 802.11n HT20, Port 2

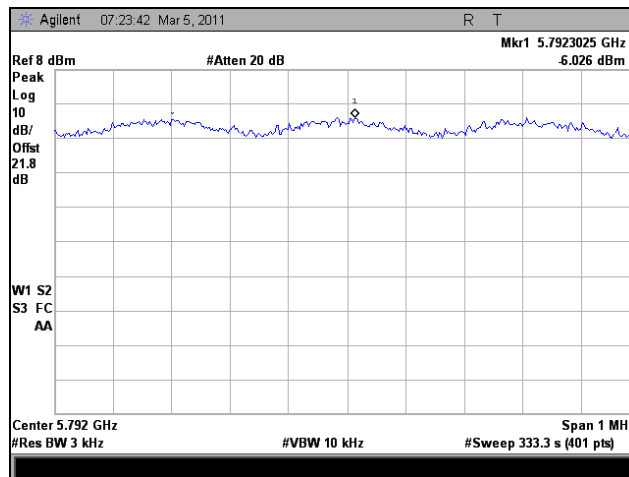

Plot 363. Peak Power Spectral Density, Mid Channel, 802.11n HT20, Port 2

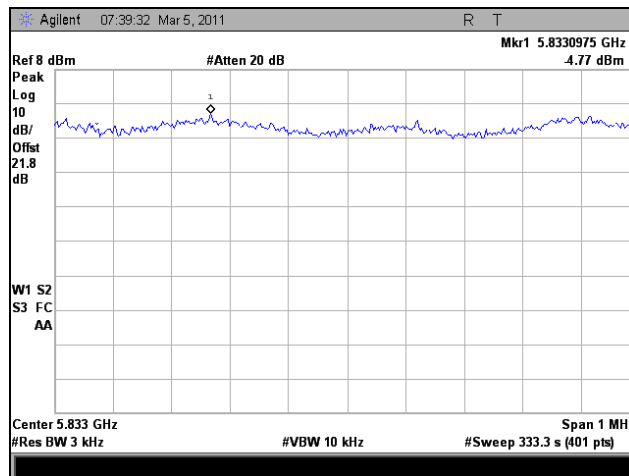

Plot 364. Peak Power Spectral Density, High Channel, 802.11n HT20, Port 2

Peak Power Spectral Density, 802.11n HT30, Port 1

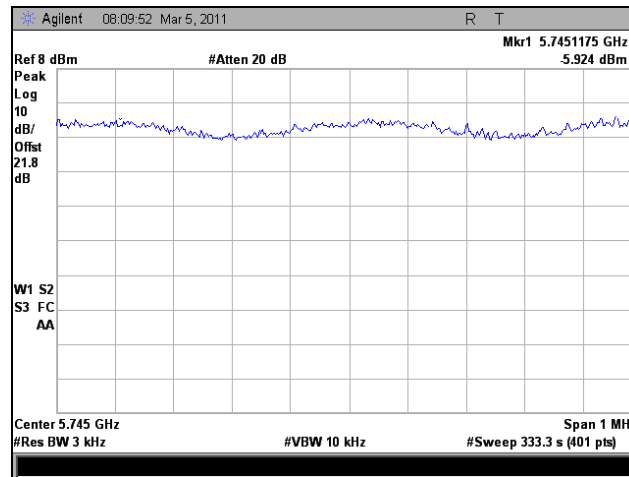

Plot 365. Peak Power Spectral Density, Low Channel, 802.11n HT30, Port 1

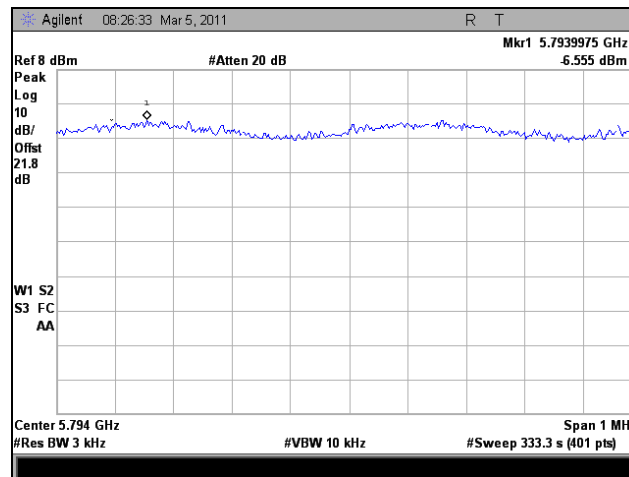

Plot 366. Peak Power Spectral Density, Mid Channel, 802.11n HT30, Port 1

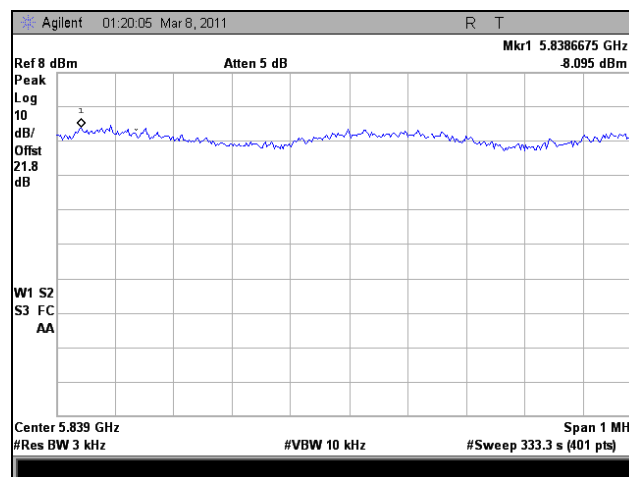

Plot 367. Peak Power Spectral Density, High Channel, 802.11n HT30, Port 1

Peak Power Spectral Density, 802.11n HT30, Port 2

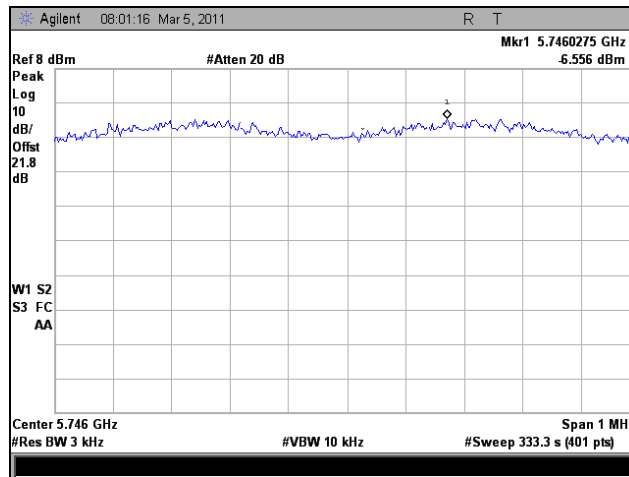

Plot 368. Peak Power Spectral Density, Low Channel, 802.11n HT30, Port 2

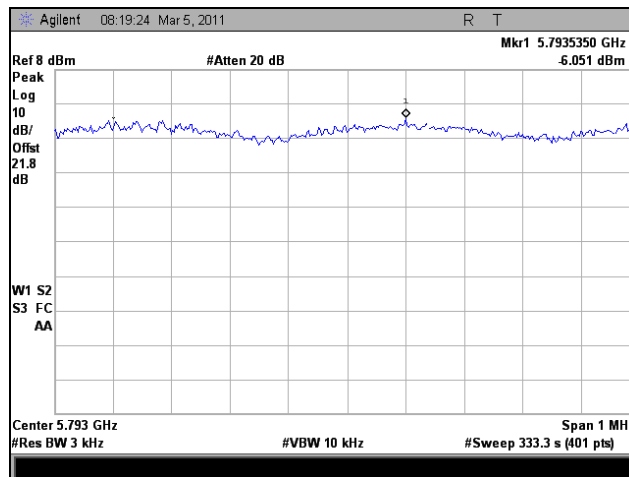

Plot 369. Peak Power Spectral Density, Mid Channel, 802.11n HT30, Port 2

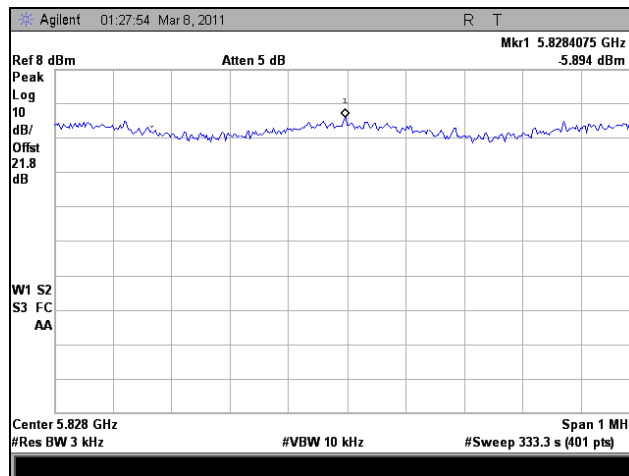

Plot 370. Peak Power Spectral Density, High Channel, 802.11n HT30, Port 2

Peak Power Spectral Density, 802.11n HT40, Port 1

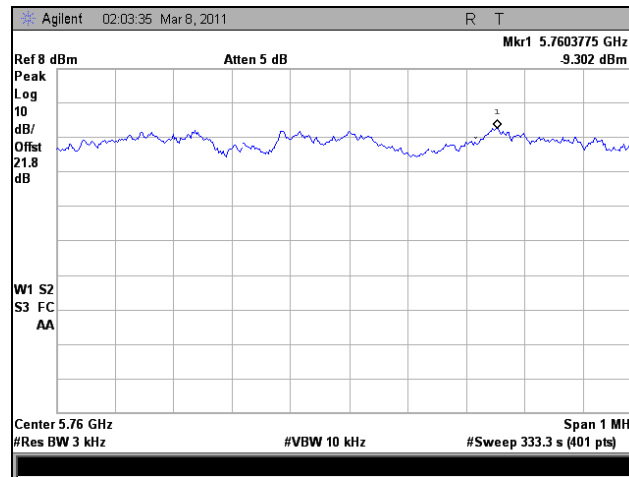

Plot 371. Peak Power Spectral Density, Low Channel, 802.11n HT40, Port 1

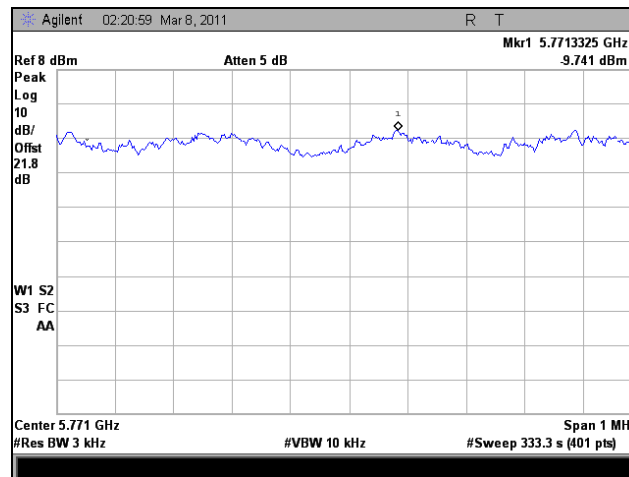

Plot 372. Peak Power Spectral Density, Mid Channel, 802.11n HT40, Port 1

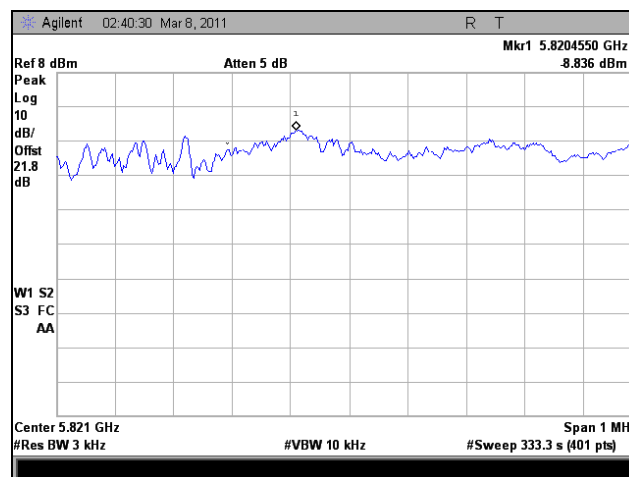

Plot 373. Peak Power Spectral Density, High Channel, 802.11n HT40, Port 1

Peak Power Spectral Density, 802.11n HT40, Port 2

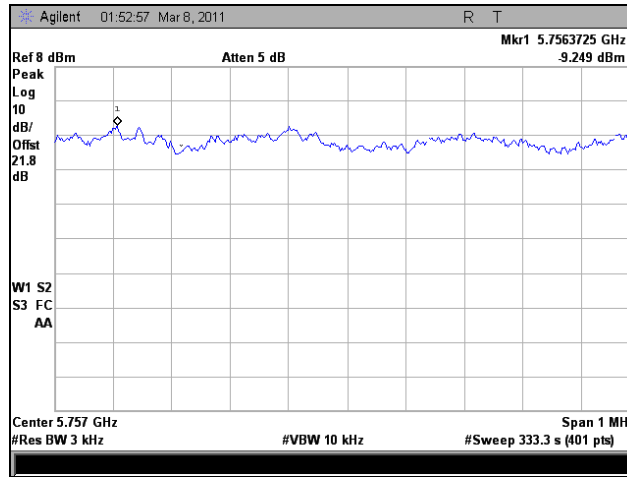

Plot 374. Peak Power Spectral Density, Low Channel, 802.11n HT40, Port 2

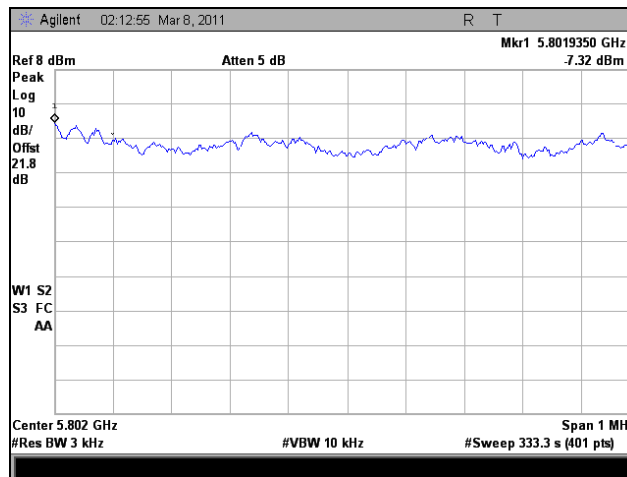

Plot 375. Peak Power Spectral Density, Mid Channel, 802.11n HT40, Port 2

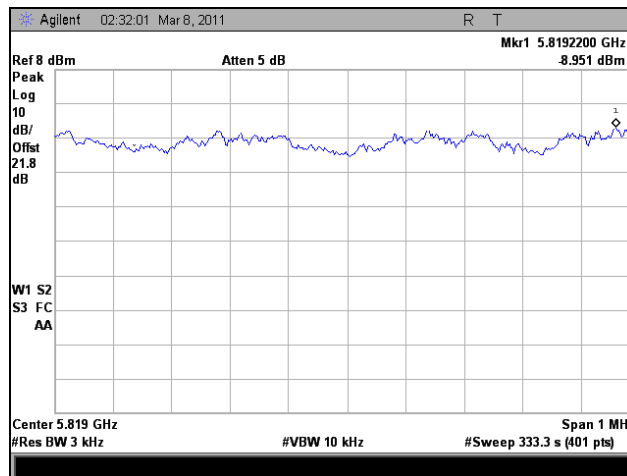

Plot 376. Peak Power Spectral Density, High Channel, 802.11n HT40, Port 2

Electromagnetic Compatibility Criteria for Intentional Radiators

§ 15.247(i) Maximum Permissible Exposure

RF Exposure Requirements: §1.1307(b)(1) and §1.1307(b)(2): Systems operating under the provisions of this section shall be operated in a manner that ensures that the public is not exposed to radio frequency energy levels in excess of the Commission's guidelines.

RF Radiation Exposure Limit: §1.1310: As specified in this section, the Maximum Permissible Exposure (MPE) Limit shall be used to evaluate the environmental impact of human exposure to radiofrequency (RF) radiation as specified in Sec. 1.1307(b), except in the case of portable devices which shall be evaluated according to the provisions of Sec. 2.1093 of this chapter.

MPE Limit Calculation: EUT's operating frequencies @ 5725-5850 MHz; highest conducted power = *29.88dBm* (peak) therefore, **Limit for Uncontrolled exposure: 1 mW/cm² or 10 W/m²**

EUT maximum antenna gain = *16 dBi*.

Equation from page 18 of OET 65, Edition 97-01

$$S = PG / 4\pi R^2 \quad \text{or} \quad R = \sqrt{PG / 4\pi S}$$

where, S = Power Density (1 mW/cm²)
P = Power Input to antenna (972.75mW)
G = Antenna Gain (39.81 numeric)

$$R = (972.75 * 39.81 / 4 * 3.14 * 1.0)^{1/2} = (38725.76 / 12.56)^{1/2} = 55.53 \text{ cm}$$

Electromagnetic Compatibility Criteria for Intentional Radiators

RSS-GEN Receiver Spurious Emissions Requirements

Test Requirements: The following receiver spurious emission limits shall be complied with:

- (a) If a radiated measurement is made, all spurious emissions shall comply with the limits of Table 52.

Spurious Frequency (MHz)	Field Strength (microvolt/m at 3 metres)
30 – 88	100
88 – 216	150
216 – 960	200
Above 960	500

Table 52. Spurious Emission Limits for Receivers

- (b) If a conducted measurement is made, no spurious output signals appearing at the antenna terminals shall exceed 2 nanowatts per any 4 kHz spurious frequency in the band 30-1000 MHz, or 5 nanowatts above 1 GHz.

Test Procedures: The EUT was programmed for receive mode only. Conducted measurements were taken at the antenna port of the EUT. 100 kHz resolution bandwidth was used from 30 MHz - 1 GHz and 300 kHz resolution was used for measurements done above 1 GHz. All plots are corrected for cable loss.

Test Results: Equipment is compliant with the Receiver Spurious Emissions Requirements of RSS-GEN.

Test Engineer(s): Kenshi Chung

Test Date(s): 03/07/11

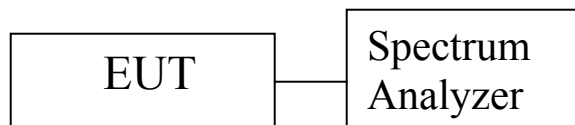
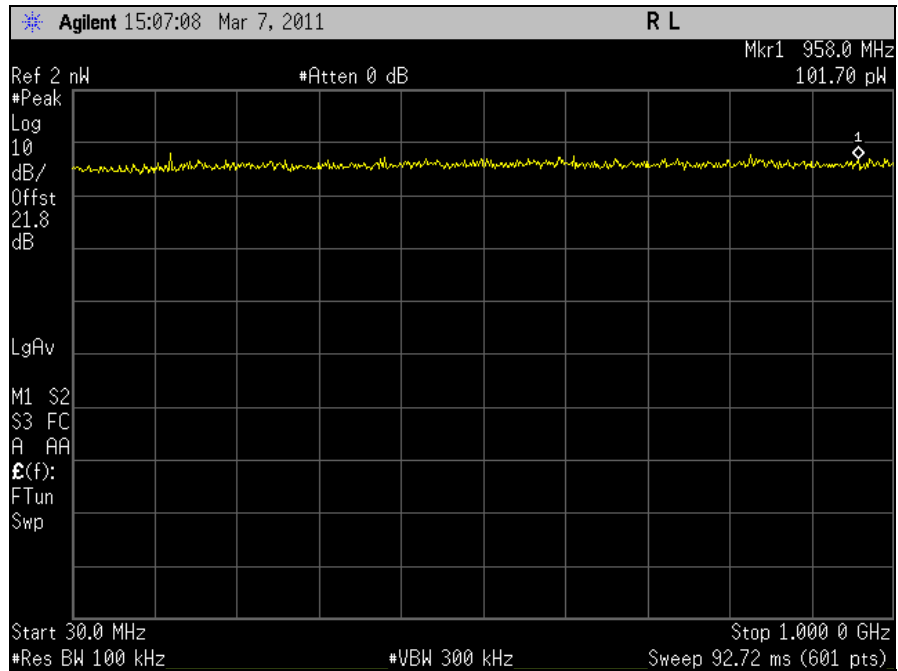
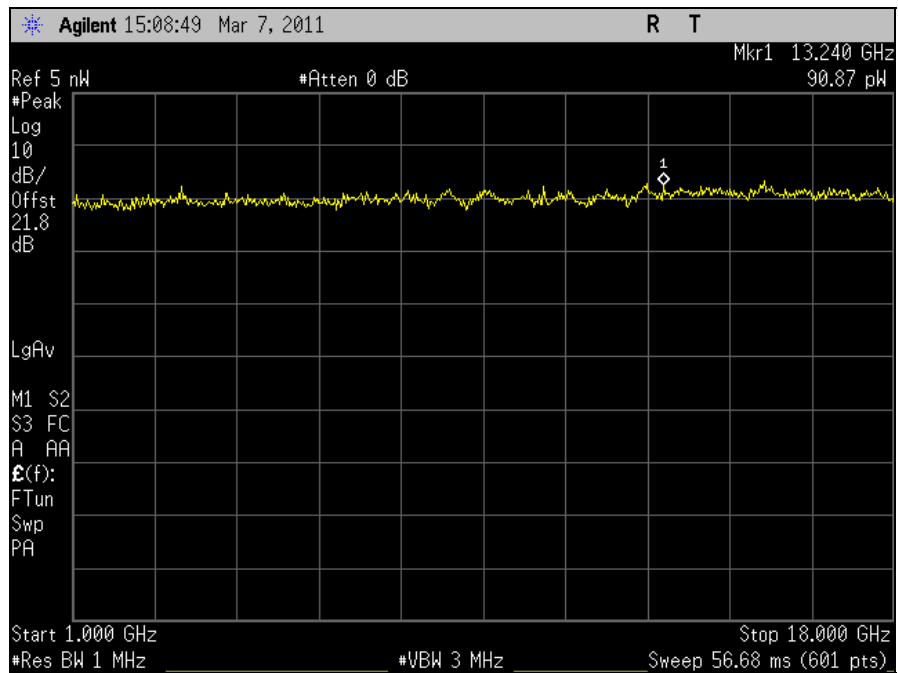

Figure 6. Block Diagram, Conducted Receiver Spurious Emissions Test Setup

Conducted Receiver Spurious Emissions



Plot 377. Receiver Spurious Emission, 30 MHz – 1 GHz, Port 1



Plot 378. Receiver Spurious Emission, 1 GHz – 18 GHz, Port 1

Conducted Receiver Spurious Emissions

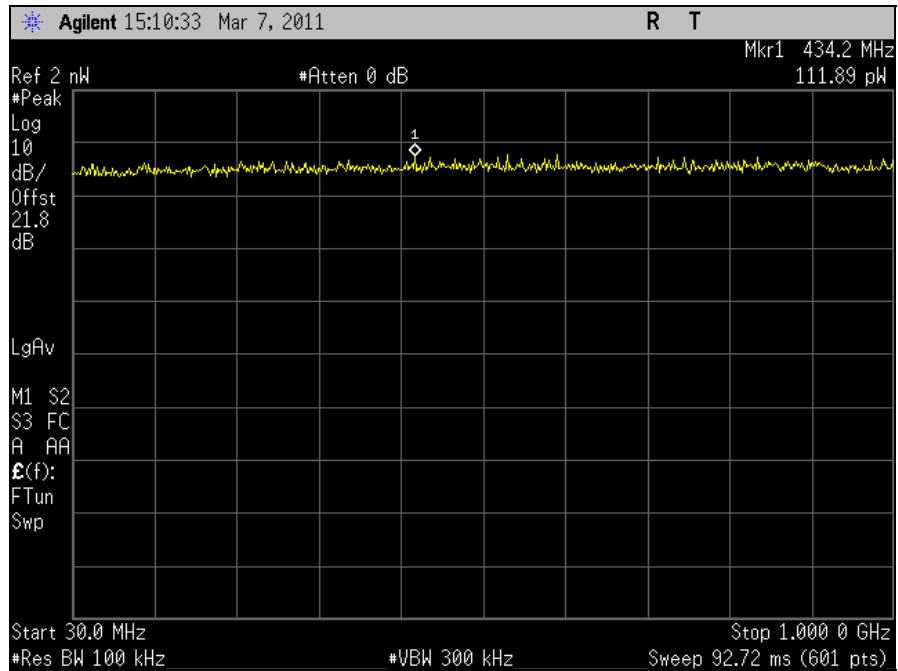

Plot 379. Receiver Spurious Emission, 30 MHz – 1 GHz, Port 2

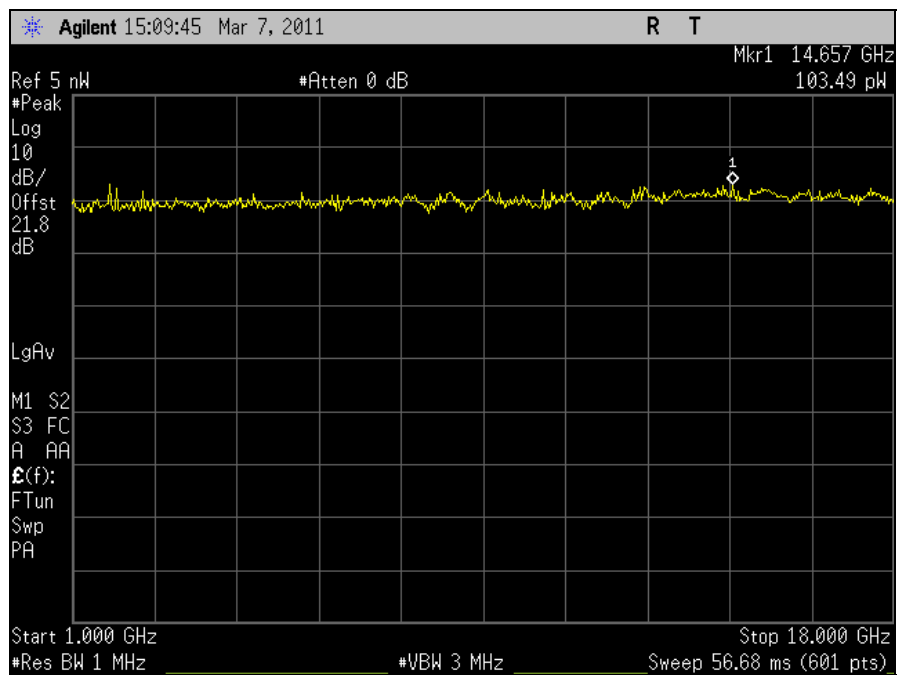

Plot 380. Receiver Spurious Emission, 1 GHz – 18 GHz, Port 2

IV. Test Equipment

Test Equipment

Calibrated test equipment utilized during testing was maintained in a current state of calibration per the requirements of ANSI/NCSL Z540-1-1994 and ANSI/ISO/IEC 17025:2000.

MET Asset #	Equipment	Manufacturer	Model	Last Cal Date	Cal Due Date
1S2583	SPECTRUM ANALYZER	AGILENT	E4447A	1/26/2010	3/26/2011
1S2678	LISN, DUAL-LINE V-NETWORK	TESEQ	NNB 51	12/1/2010	12/1/2011
1S2399	TURNTABLE CONTROLLER	SUNOL SCIENCE	SC99V	NO CALIBRATION REQUIRED	
1S2481	10M CHAMBER	ETS-LINDGREN	DKE 8X8 DBL	11/6/2010	11/6/2011
1S2482	5 METER CHAMBER	PANASHIELD	641431	11/13/2010	11/13/2011
1S2485	BILOG ANTENNA	TESEQ	CBL6112D	5/7/2010	5/7/2011
1S2499	MULTI DEVICE CONTROLLER	ETS	2090	NO CALIBRATION REQUIRED	
1S2421	EMI TEST RECEIVER	ROHDE & SCHWARZ	ESIB7	7/6/2010	7/6/2011
1S2460	SPECTRUM ANALYZER	AGILENT	E4407B	7/13/2010	7/13/2011
1S2198	HORN ANTENNA	EMCO	3115	9/22/2010	9/22/2011
N/A	HIGH PASS FILTER	MICRO-TRONICS	HPM13147	SEE NOTE	
1S2521	THERMO-HYGROMETER	FISHER SCIENTIFIC	11-661-7D	12/2/2009	12/2/2011
N/A	DC-18GHZ COMBINER	MINI CIRCUITS	ZFRSC-183-S+	SEE NOTE	
1S2523	PREAMP (1-26.5GHZ)	AGILENT	8449B	SEE NOTE	
1S2128	HARMONIC MIXER	HEWLETT PACKARD	11970A	12/9/2010	12/9/2012
1S2129	HARMONIC MIXER	HEWLETT PACKARD	11970K	12/9/2010	12/9/2012
1U0032	SEMI- ANECHOIC CHAMBER	LINDGREN ENCLOSURES	FACT 4	9/8/2010	9/8/2011
1U0007	ANTENNA, HORN	EMCO	3115	10/14/2010	10/14/2011
1U0286	SPECTRUM ANALYZER	AGILENT TECHNOLOGIES	E4407B	4/22/2010	4/22/2011

Table 53. Test Equipment List

Note: Functionally tested equipment is verified using calibrated instrumentation at the time of testing.

V. Certification & User's Manual Information

Certification & User's Manual Information

A. Certification Information

The following is extracted from Title 47 of the Code of Federal Regulations, Part 2, Subpart I — Marketing of Radio frequency devices:

§ 2.801 Radio-frequency device defined.

As used in this part, a radio-frequency device is any device which in its operation is capable of Emitting radio-frequency energy by radiation, conduction, or other means. Radio- frequency devices include, but are not limited to:

- (a) The various types of radio communication transmitting devices described throughout this chapter.
- (b) *The incidental, unintentional and intentional radiators defined in Part 15 of this chapter.*
- (c) The industrial, scientific, and medical equipment described in Part 18 of this chapter.
- (d) Any part or component thereof which in use emits radio-frequency energy by radiation, conduction, or other means.

§ 2.803 Marketing of radio frequency devices prior to equipment authorization.

- (a) Except as provided elsewhere in this chapter, no person shall sell or lease, or offer for sale or lease (including advertising for sale or lease), or import, ship or distribute for the purpose of selling or leasing or offering for sale or lease, any radio frequency device unless:
 - (1) In the case of a device subject to certification, such device has been authorized by the Commission in accordance with the rules in this chapter and is properly identified and labeled as required by §2.925 and other relevant sections in this chapter; or
 - (2) In the case of a device that is not required to have a grant of equipment authorization issued by the Commission, but which must comply with the specified technical standards prior to use, such device also complies with all applicable administrative (including verification of the equipment or authorization under a Declaration of Conformity, where required), technical, labeling and identification requirements specified in this chapter.
- (d) Notwithstanding the provisions of paragraph (a) of this section, the offer for sale solely to business, commercial, industrial, scientific or medical users (but not an offer for sale to other parties or to end users located in a residential environment) of a radio frequency device that is in the conceptual, developmental, design or pre-production stage is permitted prior to equipment authorization or, for devices not subject to the equipment authorization requirements, prior to a determination of compliance with the applicable technical requirements *provided* that the prospective buyer is advised in writing at the time of the offer for sale that the equipment is subject to the FCC rules and that the equipment will comply with the appropriate rules before delivery to the buyer or to centers of distribution.

- (e)(1) Notwithstanding the provisions of paragraph (a) of this section, prior to equipment authorization or determination of compliance with the applicable technical requirements any radio frequency device may be operated, but not marketed, for the following purposes and under the following conditions:
- (i) *Compliance testing*;
 - (ii) Demonstrations at a trade show provided the notice contained in paragraph (c) of this section is displayed in a conspicuous location on, or immediately adjacent to, the device;
 - (iii) Demonstrations at an exhibition conducted at a business, commercial, industrial, scientific or medical location, but excluding locations in a residential environment, provided the notice contained in paragraphs (c) or (d) of this section, as appropriate, is displayed in a conspicuous location on, or immediately adjacent to, the device;
 - (iv) Evaluation of product performance and determination of customer acceptability, provided such operation takes place at the manufacturer's facilities during developmental, design or pre-production states; or
 - (v) Evaluation of product performance and determination of customer acceptability where customer acceptability of a radio frequency device cannot be determined at the manufacturer's facilities because of size or unique capability of the device, provided the device is operated at a business, commercial, industrial, scientific or medical user's site, but not at a residential site, during the development, design or pre-production stages.
- (e)(2) For the purpose of paragraphs (e)(1)(iv) and (e)(1)(v) of this section, the term *manufacturer's facilities* includes the facilities of the party responsible for compliance with the regulations and the manufacturer's premises, as well as the facilities of other entities working under the authorization of the responsible party in connection with the development and manufacture, but not the marketing, of the equipment.
- (f) For radio frequency devices subject to verification and sold solely to business, commercial, industrial, scientific and medical users (excluding products sold to other parties or for operation in a residential environment), parties responsible for verification of the devices shall have the option of ensuring compliance with the applicable technical specifications of this chapter at each end user's location after installation, provided that the purchase or lease agreement includes a proviso that such a determination of compliance be made and is the responsibility of the party responsible for verification of the equipment.

Certification & User's Manual Information

The following is extracted from Title 47 of the Code of Federal Regulations, Part 2, Subpart J — Equipment Authorization Procedures:

§ 2.901 Basis and Purpose

- (a) In order to carry out its responsibilities under the Communications Act and the various treaties and international regulations, and in order to promote efficient use of the radio spectrum, the Commission has developed technical standards for radio frequency equipment and parts or components thereof. The technical standards applicable to individual types of equipment are found in that part of the rules governing the service wherein the equipment is to be operated.¹ *In addition to the technical standards provided, the rules governing the service may require that such equipment be verified by the manufacturer or importer, be authorized under a Declaration of Conformity, or receive an equipment authorization from the Commission by one of the following procedures: certification or registration.*
- (b) The following sections describe the verification procedure, the procedure for a Declaration of Conformity, and the procedures to be followed in obtaining certification from the Commission and the conditions attendant to such a grant.

§ 2.907 Certification.

- (a) Certification is an equipment authorization issued by the Commission, based on representation and test data submitted by the applicant.
- (b) Certification attaches to all units subsequently marketed by the grantee which are identical (see Section 2.908) to the sample tested except for permissive changes or other variations authorized by the Commission pursuant to Section 2.1043.

¹ In this case, the equipment is subject to the rules of Part 15. More specifically, the equipment falls under Subpart B (of Part 15), which deals with unintentional radiators.

Certification & User's Manual Information

§ 2.948 Description of measurement facilities.

- (a) Each party making measurements of equipment that is subject to an equipment authorization under Part 15 or Part 18 of this chapter, regardless of whether the measurements are filed with the Commission or kept on file by the party responsible for compliance of equipment marketed within the U.S. or its possessions, shall compile a description of the measurement facilities employed.
- (1) If the measured equipment is subject to the verification procedure, the description of the measurement facilities shall be retained by the party responsible for verification of the equipment.
- (i) *If the equipment is verified through measurements performed by an independent laboratory, it is acceptable for the party responsible for verification of the equipment to rely upon the description of the measurement facilities retained by or placed on file with the Commission by that laboratory. In this situation, the party responsible for the verification of the equipment is not required to retain a duplicate copy of the description of the measurement facilities.*
- (ii) If the equipment is verified based on measurements performed at the installation site of the equipment, no specific site calibration data is required. It is acceptable to retain the description of the measurement facilities at the site at which the measurements were performed.
- (2) If the equipment is to be authorized by the Commission under the certification procedure, the description of the measurement facilities shall be filed with the Commission's Laboratory in Columbia, Maryland. The data describing the measurement facilities need only be filed once but must be updated as changes are made to the measurement facilities or as otherwise described in this section. At least every three years, the organization responsible for filing the data with the Commission shall certify that the data on file is current.

Certification & User's Manual Information

1. Label and User's Manual Information

The following is extracted from Title 47 of the Code of Federal Regulations, Part 15, Subpart A — General:

§ 15.19 Labeling requirements.

(a) *In addition to the requirements in Part 2 of this chapter, a device subject to certification or verification shall be labeled as follows:*

- (1) Receivers associated with the operation of a licensed radio service, e.g., FM broadcast under Part 73 of this chapter, land mobile operation under Part 90, etc., shall bear the following statement in a conspicuous location on the device:

This device complies with Part 15 of the FCC Rules. Operation is subject to the condition that this device does not cause harmful interference.

- (2) A stand-alone cable input selector switch, shall bear the following statement in a conspicuous location on the device:

This device is verified to comply with Part 15 of the FCC Rules for use with cable television service.

- (3) All other devices shall bear the following statement in a conspicuous location on the device:

This device complies with Part 15 of the FCC Rules. Operation is subject to the following two conditions: (1) This device may not cause harmful interference, and (2) this device must accept any interference received, including interference that may cause undesired operation.

- (4) Where a device is constructed in two or more sections connected by wires and marketed together, the statement specified under paragraph (a) of this section is required to be affixed only to the main control unit.

- (5) When the device is so small or for such use that it is not practicable to place the statement specified under paragraph (a) of this section on it, the information required by this paragraph shall be placed in a prominent location in the instruction manual or pamphlet supplied to the user or, alternatively, shall be placed on the container in which the device is marketed. However, the FCC identifier or the unique identifier, as appropriate, must be displayed on the device.

§ 15.21 Information to user.

The users manual or instruction manual for an intentional or unintentional radiator shall caution the user that changes or modifications not expressly approved by the party responsible for compliance could void the user's authority to operate the equipment.

Verification & User's Manual Information

The following is extracted from Title 47 of the Code of Federal Regulations, Part 15, Subpart B — Unintentional Radiators:

§ 15.105 Information to the user.

- (a) For a Class A digital device or peripheral, the instructions furnished the user shall include the following or similar statement, placed in a prominent location in the text of the manual:

Note: This equipment has been tested and found to comply with the limits for a Class A digital device, pursuant to Part 15 of the FCC Rules. These limits are designed to provide reasonable protection against harmful interference when the equipment is operated in a commercial environment. This equipment generates, uses, and can radiate radio frequency energy and, if not installed and used in accordance with the instruction manual, may cause harmful interference to radio communications. Operation of this equipment in a residential area is likely to cause harmful interference in which case the user will be required to correct the interference at own expense.

- (b) For a Class B digital device or peripheral, the instructions furnished the user shall include the following or similar statement, placed in a prominent location in the text of the manual:

Note: This equipment has been tested and found to comply with the limits for a Class B digital device, pursuant to Part 15 of the FCC Rules. These limits are designed to provide reasonable protection against harmful interference when the equipment is operated in a residential environment. This equipment generates, uses, and can radiate radio frequency energy and, if not installed and used in accordance with the instruction manual, may cause harmful interference to radio communications. However, there is no guarantee that interference will not occur in a particular installation. If this equipment does cause harmful interference to radio or television reception, which can be determined by turning the equipment off and on, the user is encouraged to try to correct the interference by one or more of the following measures:

- Reorient or relocate the receiving antenna.
- Increase the separation between the equipment and receiver.
- Connect the equipment into an outlet on a circuit different from that to which the receiver is connected.
- Consult the dealer or an experienced radio/TV technician for help.

ICES-003 Procedural & Labeling Requirements

From the Industry Canada Electromagnetic Compatibility Advisory Bulletin entitled, "Implementation and Interpretation of the Interference-Causing Equipment Standard for Digital Apparatus, ICES-003" (EMCAB-3, Issue 2, July 1995):

"At present, CISPR 22: 2002 and ICES technical requirements are essentially equivalent. Therefore, if you have CISPR 22: 2002 approval by meeting CISPR Publication 22, the only additional requirements are: to attach a note to the report of the test results for compliance, indicating that these results are deemed satisfactory evidence of compliance with ICES-003 of the Canadian Interference-Causing Equipment Regulations; to maintain these records on file for the requisite five year period; and to provide the device with a notice of compliance in accordance with ICES-003."

Procedural Requirements:

According to Industry Canada's Interference Causing Equipment Standard for Digital Apparatus ICES-003 Issue 4, February 2004:

- Section 6.1: A record of the measurements and results, showing the date that the measurements were completed, shall be retained by the manufacturer or importer for a period of at least five years from the date shown in the record and made available for examination on the request of the Minister.
- Section 6.2: A written notice indicating compliance must accompany each unit of digital apparatus to the end user. The notice shall be in the form of a label that is affixed to the apparatus. Where because of insufficient space or other constraints it is not feasible to affix a label to the apparatus, the notice may be in the form of a statement in the user's manual.

Labeling Requirements:

The suggested text for the notice, in English and in French, is provided below, from the Annex of ICES-003:

This Class [²] digital apparatus complies with Canadian ICES-003.

Cet appareil numérique de la classe [¹] est conforme à la norme NMB-003 du Canada.

² Insert either A or B but not both as appropriate for the equipment requirements.

End of Report